

# *Pioneer*

---

## Operation Manual

DVD AV RECEIVER

# AVH-P4200DVD AVH-P3200DVD AVH-P3200BT

**HD** Radio<sup>®</sup>  
R E A D Y

**SUPER**  **TUNER III** **D**

---

*English*

## Thank you for purchasing this PIONEER product.

To ensure proper use, please read through this manual before using this product. It is especially important that you read and observe **WARNING**s and **CAUTION**s in this manual. *Please keep the manual in a safe and accessible place for future reference.*



### Be sure to read this

- DVD video disc region numbers 8
- Handling guideline 80

### 01 Precautions

- IMPORTANT SAFEGUARDS 5
- To ensure safe driving 5
- To avoid battery exhaustion 6

### 02 Before You Start

- AVH-P4200DVD/AVH-P3200DVD 7
- Information to User 7
- For Canadian model 7
- About this unit 7
- About this manual 8
- Operating environment 8
- After-sales service for Pioneer products 8
- Visit our website 8
- Resetting the microprocessor 8
- Feature demo mode 9
- Adjusting the response positions of the touch panels (Touch Panel Calibration) 9

### 03 What's what

- Head unit 10
- Optional remote control 10

### 04 Basic Operations

- Basic Operations 11
- Operating the scroll bar and the scrubber bar 12
- Activating the touch panel keys 12
- Common operations for menu settings/lists 13
- Adjusting the LCD panel angle 13
- Ejecting a disc 13
- Ejecting a disc 13
- Ejecting an SD 13

- Ejecting an SD 14
- Setting the clock 14

### 05 Tuner

- Introduction of tuner operations 15

### 06 Playing moving images

- Introduction of video playback operations 16

### 07 Playing audio

- Introduction of sound playback operations 19

### 08 Playing still images

- Introduction of still image playback operations 22
- Introduction of still image playback as a slideshow operations 23

### 09 Bluetooth Telephone

- Introduction of Bluetooth telephone operations 24

### 10 XM/SIRIUS tuner

- Introduction of XM/SIRIUS tuner operations 26

### 11 HD Radio™ tuner

- Introduction of HD Radio™ tuner operations 28

### 12 Using Bluetooth wireless technology

- Introduction of Bluetooth telephone operations 29
- Bluetooth audio operations 30

### 13 Detailed instructions

- Storing and recalling stations 32
- Storing the strongest stations 32
- Tuning in to strong signals 32
- Tuning in to strong HD Radio signals 32

- Using iTunes tagging **33**
  - Switching the media file type **33**
  - Operating the DVD menu **34**
  - Operating this unit's iPod function from your iPod **34**
  - Random play (shuffle) **34**
  - Playing all songs in random order (shuffle all) **35**
  - Repeating playback **35**
  - Playing videos from your iPod **35**
  - Browsing for a video/music on the iPod **35**
  - Resume playback (Bookmark) **36**
  - Frame-by-frame playback **36**
  - Slow motion playback **36**
  - Searching for the part you want to play **37**
  - Changing audio language during playback (Multi-audio) **37**
  - Changing the subtitle language during playback (Multi-subtitle) **37**
  - Changing the viewing angle during playback (Multi-angle) **38**
  - Return to the specified scene **38**
  - Selecting audio output **38**
  - PBC playback **38**
  - Selecting tracks from the track title list **38**
  - Selecting files from the file name list **39**
  - Using advanced sound retriever **39**
  - Changing audiobook speed **39**
  - Displaying lists related to the currently playing song (Link Search) **39**
  - Playing DivX® VOD content **39**
  - Capture an image in JPEG files **40**
  - Changing the wide screen mode **40**
  - Switching the XM/SIRIUS channel selection mode **41**
  - Selecting an XM/SIRIUS channel directly **42**
  - Using the MyMix function **42**
  - Using the Game Alert function **44**
  - Displaying the Radio ID **45**
  - Switching the SIRIUS display **45**
  - Using the Instant Replay function **45**
  - Switching the seek mode **46**
  - Switching the reception mode **46**
  - Calling a number in the phone book **46**
  - Selecting a number by alphabet search mode **46**
  - Using the missed, received and dialed call lists **47**
  - Using the missed, received and dialed call lists **47**
  - Setting automatic answering **48**
  - Adjusting the other party's listening volume **48**
  - Switching the ring tone **48**
  - Using the preset dial lists **48**
  - Making a call by entering phone number **48**
  - Setting the private mode **49**
  - Pairing from this unit **49**
  - Using a Bluetooth device to pair **50**
  - Connecting to a Bluetooth device automatically **50**
  - Switching visible unit **51**
  - Displaying BD (Bluetooth Device) address **51**
  - Entering PIN code for Bluetooth wireless connection **51**
  - Using a cellular phone to initiate a connection **51**
  - Registering a connected cellular phone **52**
  - Voice recognition **52**
  - Connecting a Bluetooth audio player **52**
  - Connecting to a Bluetooth device automatically **52**
  - Displaying BD (Bluetooth Device) address **52**
- 14 Menu operations**
- Introduction of menu operations **54**
  - Audio Adjustments **55**

- Setting up the DVD player **58**
- System settings **62**
- Entertainment settings **67**
- Customizing menus **68**

## **15 Other Functions**

- Changing the picture adjustment **69**
- Setting rear monitor output **69**
- Adjusting the response positions of the touch panels (Touch Panel Calibration) **70**
- Using an AUX source **70**
- Using an external unit **71**

## **Additional Information**

- Troubleshooting **72**
- Error messages **74**
- Understanding auto EQ error messages **77**
- Understanding messages **78**
- Indicator list **78**
- Handling guideline **80**
- Compressed audio compatibility (disc, USB, SD) **83**
- iPod compatibility **84**
- Sequence of audio files **84**
- Using the display correctly **85**
- Copyright and trademark **86**
- Language code chart for DVD **89**
- Specifications **90**

## Precautions

### IMPORTANT SAFEGUARDS

Please read all of these instructions regarding your display and retain them for future reference.

- 1 **Read this manual fully and carefully before operating your display.**
- 2 **Keep this manual handy as a reference for operating procedures and safety information.**
- 3 **Pay close attention to all warnings in this manual and follow the instructions carefully.**
- 4 **Do not allow other persons to use this system until they have read and understood the operating instructions.**
- 5 **Do not install the display where it may (i) obstruct the driver's vision, (ii) impair the performance of any of the vehicle's operating systems or safety features, including air bags, hazard lamp buttons or (iii) impair the driver's ability to safely operate the vehicle.**
- 6 **Do not operate this display if doing so in any way will divert your attention from the safe operation of your vehicle. Always observe safe driving rules and follow all existing traffic regulations. If you experience difficulty in operating the system or reading the display, park your vehicle in a safe location and make necessary adjustments.**
- 7 **Please remember to wear your seat belt at all times while operating your vehicle. If you are ever in an accident, your injuries can be considerably more severe if your seat belt is not properly buckled.**
- 8 **Never use headphones while driving.**
- 9 **To promote safety, certain functions are disabled unless the parking brake is on, and the vehicle is not in motion.**
- 10 **Never set the volume of your display so high that you cannot hear outside traffic and emergency vehicles.**

### WARNING

- **Do not attempt to install or service your display by yourself. Installation or servicing of the display by persons without training and experience in electronic equipment and automotive accessories may be dangerous and could expose you to the risk of electric shock or other hazards.** 

### To ensure safe driving

#### WARNING

- **LIGHT GREEN LEAD AT POWER CONNECTOR IS DESIGNED TO DETECT PARKED STATUS AND MUST BE CONNECTED TO THE POWER SUPPLY SIDE OF THE PARKING BRAKE SWITCH. IMPROPER CONNECTION OR USE OF THIS LEAD MAY VIOLATE APPLICABLE LAW AND MAY RESULT IN SERIOUS INJURY OR DAMAGE.**
- To avoid the risk of damage and injury and the potential violation of applicable laws, this unit is not for use with a video screen that is visible to the driver.
- To avoid the risk of accident and the potential violation of applicable laws, no viewing of front seat video should ever occur while the vehicle is being driven.
- In some countries or states the viewing of images on a display inside a vehicle even by persons other than the driver may be illegal. Where such regulations apply, they must be obeyed and this unit's DVD features should not be used.

When you attempt to watch a video image while driving, the warning **Viewing of front seat video source while driving is strictly prohibited.** will appear on the front display. To watch a video image on the front display, park your vehicle in a safe place and apply the parking brake.

## Parking brake interlock

Certain functions (Video viewing and certain touch panel keys) offered by this unit could be dangerous and/or unlawful if used while driving. To prevent such functions from being used while the vehicle is in motion, there is an interlock system that senses when the parking brake is set. If you attempt to use the functions described above while driving, they will become disabled until you stop the vehicle in a safe place, and (1) apply the parking brake, (2) release the parking brake, and then (3) apply the parking brake again. Please keep the brake pedal pushed down before releasing the parking brake.

## When using a display connected to V OUT

This unit's **V OUT** is for connection of a display to enable passengers in the rear seats to watch the DVD or Video CD.



### WARNING

**NEVER** install the rear display in a location where the driver can watch a DVD while driving.

## When using the rear view camera

With an optional rear view camera, this unit can be used as an aid to keep an eye on trailers, or when backing into a tight parking spot.



### WARNING

- **SCREEN IMAGE MAY APPEAR REVERSED.**
- **USE INPUT ONLY FOR REVERSE OR MIRROR IMAGE REAR VIEW CAMERA. OTHER USE MAY RESULT IN INJURY OR DAMAGE.**



### CAUTION

- The rear view camera function is to be used as an aid to keep an eye on trailers, or while

backing up. Do not use for entertainment purposes.

- Please note that the edges of the rear view camera images may differ slightly according to whether full screen images are displayed when backing up, and whether the images are used for checking the rear when the vehicle is moving forward. 

## To avoid battery exhaustion

Keep the vehicle engine running when using this unit to avoid draining the battery power.

- When no power is supplied to this unit, such as when the vehicle battery is being replaced, the microcomputer of this unit returns to its initial condition. We recommend that you transcribe the audio adjustment data.



### WARNING

Do not use with vehicles that do not feature an ACC position. 

## Before You Start

FCC ID: AJDK028

MODEL NO.: AVH-P3200BT

IC: 775E-K028

This equipment complies with FCC/IC radiation exposure limits set forth for uncontrolled equipment and meets the FCC/IC radio frequency (RF) Exposure Guidelines in Supplement C to OET65. This equipment has very low levels of RF energy that it deemed to comply without maximum permissive exposure evaluation (MPE). But it is desirable that it should be installed and operated with at least 20 cm and more between the radiator and person's body (excluding extremities: hands, wrists, feet and ankles).

This transmitter must not be co-located or operated in conjunction with any other antenna or transmitter.

### AVH-P4200DVD/AVH-P3200DVD

This device complies with part 15 of the FCC Rules. Operation is subject to the following two conditions:

(1) This device may not cause harmful interference, and (2) this device must accept any interference received, including interference that may cause undesired operation.



## Information to User

Alteration or modifications carried out without appropriate authorization may invalidate the user's right to operate the equipment.



## For Canadian model

This Class B digital apparatus complies with Canadian ICES-003.



## About this unit

The tuner frequencies on this unit are allocated for use in North America. Use in other areas may result in poor reception.



### WARNING

Handling the cord on this product or cords associated with accessories sold with the product may expose you to chemicals listed on proposition 65 known to the State of California and other governmental entities to cause cancer and birth defect or other reproductive harm. **Wash hands after handling.**

### CAUTION:

**USE OF CONTROL OR ADJUSTMENT OR PERFORMANCE OF PROCEDURES OTHER THAN THOSE SPECIFIED HEREIN MAY RESULT IN HAZARDOUS RADIATION EXPOSURE.**

### CAUTION:

**THE USE OF OPTICAL INSTRUMENTS WITH THIS PRODUCT WILL INCREASE EYE HAZARD.**



### CAUTION

- Do not allow this unit to come into contact with liquids. Electrical shock could result. Also, damage to this unit, smoke, and overheating could result from contact with liquids.
- Keep this manual handy for future reference.
- Always keep the volume low enough to hear outside sounds.
- Avoid exposure to moisture.
- If the battery is disconnected or discharged, any preset memory will be erased.



### Important (Serial number)

The serial number is located on the bottom of this unit. For your own security and convenience, be sure to record this number on the enclosed warranty card.

## DVD video disc region numbers

Only DVD video discs with compatible region numbers can be played on this player. You can find the region number of the player on the bottom of this unit and in this manual (refer to *Specifications* on page 90).

## About this manual

This unit features a number of sophisticated functions ensuring superior reception and operation. All the functions have been designed for the easiest possible use, but many are not self-explanatory. This operation manual will help you benefit fully from this unit's potential and to maximize your listening enjoyment.

We recommend that you familiarize yourself with the functions and their operation by reading through the manual before you begin using this unit. It is especially important that you read and observe **WARNINGs** and **CAUTIONs** in this manual.

## Operating environment

This unit should be used within the temperature ranges shown below.

Operating temperature range: -10 °C to +60 °C (14 °F to 140 °F)

EN300328 ETC test temperature: -20 °C and +55 °C (-4 °F and 131 °F)

## After-sales service for Pioneer products

Please contact the dealer or distributor from where you purchased this unit for after-sales service (including warranty conditions) or any other information. In case the necessary information is not available, please contact the companies listed below:

Please do not ship your unit to the companies at the addresses listed below for repair without advance contact.

### U.S.A.

Pioneer Electronics (USA) Inc.  
CUSTOMER SUPPORT DIVISION  
P.O. Box 1760  
Long Beach, CA 90801-1760  
800-421-1404

### CANADA

Pioneer Electronics of Canada, Inc.  
CUSTOMER SATISFACTION DEPARTMENT  
300 Allstate Parkway  
Markham, Ontario L3R 0P2  
1-877-283-5901  
905-479-4411

For warranty information please see the Limited Warranty sheet included with this unit.

## Visit our website

Visit us at the following site:  
<http://www.pioneerelectronics.com>

- 1 Register your product. We will keep the details of your purchase on file to help you refer to this information in the event of an insurance claim such as loss or theft.
- 2 Receive updates on the latest products and technologies.
- 3 Download owner's manuals, order product catalogues, research new products, and much more.
- 4 Your feedback is important in our continual effort to design and build the most advanced, consumer-focused product in the industry.

### Serial number



## Resetting the microprocessor

By pressing **RESET**, you can reset the microprocessor to its initial settings without changing the bookmark information.



## Before You Start

The microprocessor must be reset in the following situations:

- Before using this unit for the first time after installation
- If the unit fails to operate properly
- When strange or incorrect messages appear on the display

- 1 Turn the ignition switch OFF.
- 2 Press **RESET** with a pen tip or other pointed instrument.

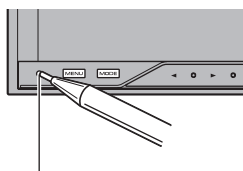

RESET button  
(AVH-P4200DVD)

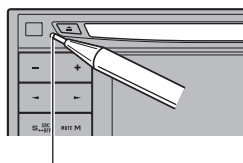

RESET button  
(AVH-P3200DVD/AVH-P3200BT)

### Note

Switch your engine ON or set the ignition switch to ACC ON before pressing **RESET** in the following situations:

- After completing connections
- When erasing all stored settings
- When resetting the unit to its initial (factory) settings.

## Feature demo mode

The feature demo automatically starts when you select **Off** for the source and continues while the ignition switch is set to ACC or ON.

To cancel the feature demo, press and hold **MUTE**. Press and hold **MUTE** again to restart. Operating the feature demo while the car engine is turned off it may drain the battery power.

### Important

Failure to connect the red lead (ACC) of this unit to a terminal coupled with ignition switch on/off operations may lead to battery drain.

## Adjusting the response positions of the touch panels (Touch Panel Calibration)

If you feel that the touch panel keys on the screen deviate from the actual positions that respond to your touch, adjust the response positions of the touch panel. Refer to *Adjusting the response positions of the touch panels (Touch Panel Calibration)* on page 70.

### Head unit

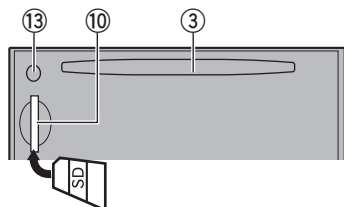
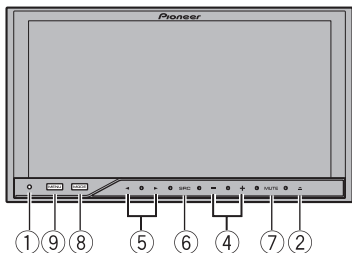

(AVH-P4200DVD)

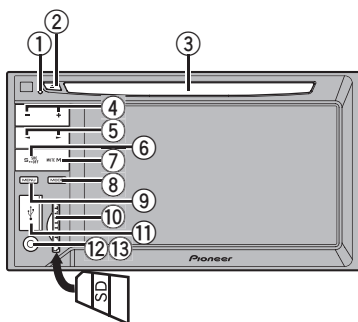

(AVH-P3200DVD/AVH-P3200BT)

Part	Part
① RESET	⑧ <b>MODE</b> Turning the information display off.
② ▲ (eject)	⑨ <b>MENU</b> Displaying the menu. Returning to the normal display.
③ Disc loading slot	⑩ SD memory card slot

Part	Part
④ +/- (VOLUME/VOL)	⑪ USB port When connecting, open the USB connector lid.
⑤ ◀▶ (TRACK/SEEK)	⑫ AUX input jack (3.5 mm stereo/video jack) Use to connect an auxiliary device.
⑥ SRC/OFF	⑬ Auto EQ microphone input jack Use to connect an auto EQ microphone.
⑦ MUTE	

### CAUTION

- (AVH-P3200DVD/AVH-P3200BT)  
Use an optional Pioneer USB cable (CD-U50E) to connect the USB audio player/USB memory as any device connected directly to the unit will protrude out from the unit and may be dangerous.
- Do not use unauthorized products.
- When inserting an SD card into the card slot, make sure that the label is facing the left.
- For details on how to operate a navigation unit from this unit, refer to its operation manual.

### Note

When the navigation unit is connected, press **MODE** to switch to the navigation display. Press **MODE** and hold to turn the display off. Press **MODE** again to turn the display on.

### Optional remote control

The remote control CD-R55 is sold separately. For details concerning operations, see the remote control manual.

# Basic Operations

## Basic Operations

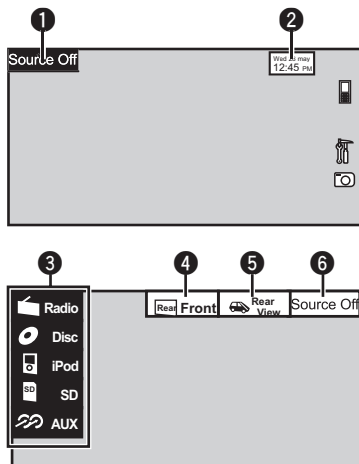

### ① Touch panel keys

<b>1</b>	<b>Source Off</b>	Displaying the source menu.
<b>2</b>	<b>Wed 28 May 12:45 PM</b>	Switching to clock adjustment display. Refer to <i>Setting the clock</i> on page 14.
<b>3</b>	<b>Radio</b>	Source icon Selecting a favorite source. When the source icon is not displayed, it can be displayed by touching the screen.
<b>4</b>	<b>Rear Front</b>	Switching the output source for the rear monitor. Refer to <i>Setting rear monitor output</i> on page 69.
<b>5</b>	<b>Rear View</b>	Switching the rear view image on or off.
<b>6</b>	<b>Source Off</b>	Turning the unit off.

Turning the unit on using the buttons

- ① Press **SRC/OFF** to turn the unit on.

Turning the unit off using the buttons

- ① Press **SRC/OFF** and hold until the unit turns off.

Selecting a source using the buttons

- ① Press **SRC/OFF** to cycle through the sources listed below:

Selecting a source using the touch panel keys

- ① Touch the source icon and then touch the desired source name.
- **XM** – XM tuner
  - **Sirius** – SIRIUS tuner
  - **Radio/HD Radio** – Radio/Digital Radio tuner
  - **AV** – AV input
  - **Disc** – Built-in DVD player
  - **USB/iPod** – USB/iPod
  - **SD** – SD memory card
  - **EXT1** – External unit 1
  - **EXT2** – External unit 2
  - **AUX** – AUX
  - **TEL/Audio** – Bluetooth telephone/audio (Function of AVH-P4200DVD/AVH-P3200DVD)
- When the source icon is not displayed, it can be displayed by touching the screen.
- While operating the menu, you cannot select a source by touching the source icon.

Adjusting the volume

- ① Press **+/- (VOLUME/VOL)** to adjust the volume.

### Notes

- In this manual, iPod and iPhone will be referred to as “iPod”.
- The **USB/iPod** icon will change as follows:
  - **USB** is displayed when a USB storage device is connected.
  - **iPod** is displayed when an iPod is connected.
  - **USB/iPod** is displayed when no device is connected.
- When appropriately set up, the image from the rear view camera can be displayed automatically. For details, refer to *Setting the rear view camera (back up camera)* on page 64.
- An external unit refers to a Pioneer product, such as those which will be available in the future. Although incompatible as a source, the basic functions of up to two external units can be controlled with this unit. When two external units are connected, the external units are automatically allocated to external unit 1 or external unit 2.
- If the HD Radio tuner is connected to this unit, tuner source is skipped.

## Operating the scroll bar and the scrubber bar

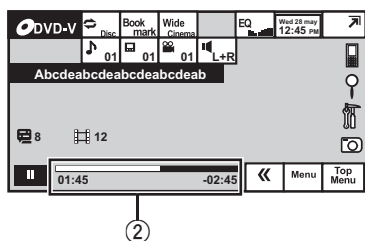
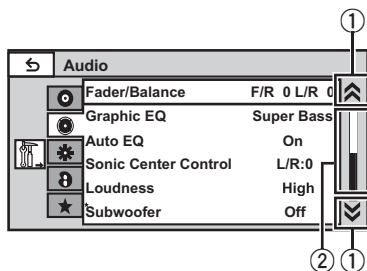

- ① Scroll icon  
Appears when selectable items are hidden.
- ② Scrubber bar  
Appears when the playback point can be specified or set by dragging.

Viewing the hidden items

- ① Touch the scroll icon or drag the scrubber bar to view any hidden items.

Specifying the playback point

- ① Drag the scrubber bar on the screen.  
(Not available when the scrubber bar is grayed out.)



## Activating the touch panel keys

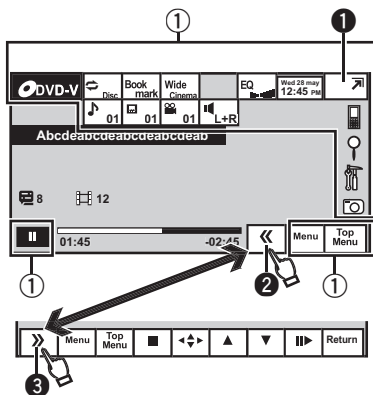

- ① Touch panel keys  
Perform various operations by touching the panel.
- ② Open/close keys  
Control the touch panel key area by touching these keys.

Turning the display to simplified display.

Returning to the normal display by touching the screen when playing moving images.

①



Returning to the normal display by touching same icon when playing audio.

②



Viewing the hidden touch panel keys.

③



Shorten the touch panel area.



## Basic Operations

### Common operations for menu settings/lists



(AVH-P3200BT only)  
Starting the Bluetooth telephone menu.  
Refer to *Introduction of Bluetooth telephone operations* on page 24.



Displaying the list menu.  
Starting the search function.



Displaying the menu.  
Refer to *Introduction of menu operations* on page 54.



Displaying still images as a slide show when listening to another source.  
Viewing slide shows  
Refer to *Introduction of still image playback operations* on page 22.



Returning to the previous display  
Returning to the previous list/category (the folder/category one level higher)

- Press and hold **MENU** to display **Picture Adjustment**.  
Refer to *Changing the picture adjustment* on page 69.

### Adjusting the LCD panel angle

(Function of AVH-P4200DVD)

#### CAUTION

Keep hands and fingers clear of the unit when opening, closing, or adjusting the LCD panel. Be especially cautious of children's hands and fingers.

- 1 Press **▲(eject)** to display the ejecting menu.

- 2 Adjust the LCD panel to an easily viewable angle.



Laying the panel down.



Returning the panel to the upright position.

- As the set angle is saved, the LCD panel will automatically be adjusted to the same position the next time the LCD panel is opened.

### Ejecting a disc

(AVH-P4200DVD)

- 1 Press **▲(eject)** to display the ejecting menu.
- 2 Eject a disc



Ejecting a disc



### Ejecting a disc

(AVH-P3200DVD/AVH-P3200BT)

- Press **▲(eject)**.

### Ejecting an SD

(AVH-P4200DVD)

- 1 Press **▲(eject)** to display the ejecting menu.
- 2 Eject an SD



Ejecting an SD.

- 3 Press an **SD** to eject.

## Ejecting an SD

(AVH-P3200DVD/AVH-P3200BT)



- Press an SD to eject. 

## Setting the clock

- 1 Switch to Clock Adjustment display.

Refer to *Basic Operations* on page 11.

- 2 Select the item to set.

- 3 Touch  or  to set the correct date and time. 

# Tuner

## Introduction of tuner operations

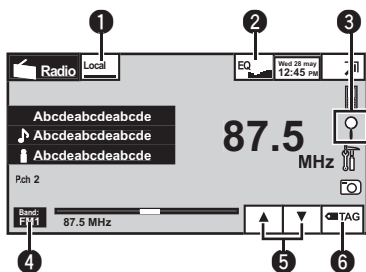

Manual tuning (step by step) using the buttons  
 ① Press ◀ or ▶ (TRACK/SEEK).

Seek tuning using the buttons  
 ① Press and hold ◀ or ▶ (TRACK/SEEK).



**Note**  
 Listening AM radio while an iPod is charged from this unit may generate noise. In this case, disconnect the iPod from this unit. □

### ① Touch panel keys

①

Local

Turning local seek tuning on and off.  
 Refer to *Tuning in to strong signals* on page 32.

②

EQ

Switching the equalizer curves.  
 Refer to *Using the equalizer* on page 55.  
 Touch and hold for more than two seconds to turn the auto-equalizer on or off.  
 Refer to *Using the auto-equalizer* on page 56.

③



Displaying the preset channel list.  
 Refer to *Storing and recalling stations* on page 32.  
 Refer to *Storing the strongest stations* on page 32.  
 Refer to *Storing and recalling stations* on page 32.

④

Band:

Selecting a band (FM1, FM2, FM3 for FM or AM).

⑤



Recalling radio station frequencies assigned to preset tuning keys.  
 Refer to *Storing and recalling stations* on page 32.

⑥

TAG

Saving song information (tag) from the broadcasting station to your iPod.  
 Refer to *Using iTunes tagging* on page 33.

## Introduction of video playback operations

You can view DVD/DVD-R/DVD-RW/CD/CD-R/CD-RW/USB/SD/iPod.

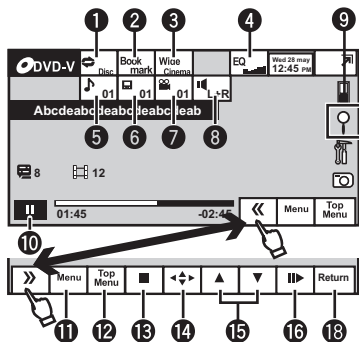

### DVD video

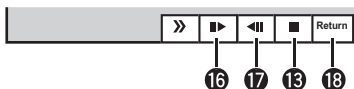

### Video CD

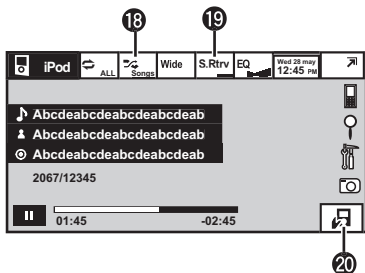

### iPod video

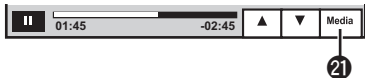

### When playing a disc containing a mixture of various media file types

- (AVH-P4200DVD)  
If an iPod with video capabilities is connected to this unit using an interface cable such as the CD-IU200V (sold separately),

you can enjoy the video contents of the iPod as an **iPod** source.

















- (AVH-P3200DVD/AVH-P3200BT)  
If an iPod with video capabilities is connected to this unit using an interface cable such as the CD-IU50V (sold separately), you can enjoy the video contents of the iPod as an **iPod** source.

### ① Touch panel keys

- |   |  |  |
|---|--|--|
| ① |  | Selecting the repeat range. Refer to <i>Repeating playback</i> on page 35.   |
| ② |  | During playback, touch the point at which you want to resume playback the next time the disc is loaded. Refer to <i>Resume playback (Bookmark)</i> on page 36.   |
| ③ |  | Changing the screen mode. Refer to <i>Changing the wide screen mode</i> on page 40.  |
| ④ |  | Switching the equalizer curves. Refer to <i>Using the equalizer</i> on page 55.<br>Touch and hold for more than two seconds to turn the auto-equalizer on or off. Refer to <i>Using the auto-equalizer</i> on page 56. |
| ⑤ |  | Switching between audio languages during playback. Refer to <i>Changing audio language during playback (Multi-audio)</i> on page 37.   |
| ⑥ |  | Switching between subtitle languages during playback. Refer to <i>Changing the subtitle language during playback (Multi-subtitle)</i> on page 37.  |
| ⑦ |  | Switching among viewing angles during playback. Refer to <i>Changing the viewing angle during playback (Multi-angle)</i> on page 38.   |



## Playing moving images

- 8**  Switching the audio output, when playing video discs recorded with LPCM audio. Refer to *Selecting audio output* on page 38.  
Switching between stereo and monaural audio output, when playing Video CD discs.
- 9**  Starting the search function. Refer to *Searching for the part you want to play* on page 37. Refer to *Selecting files from the file name list* on page 39. Displaying iPod menus. Refer to *Playing videos from your iPod* on page 35 and *Browsing for a video/music on the iPod* on page 35.
- 10**  Returning to normal playback during paused, slow motion, or frame-by-frame playback.
- 11**  Pausing playback
- 11**  Displaying the DVD menu during DVD playback. Refer to *Operating the DVD menu* on page 34.
- 12**  Returning to the top menu during DVD playback.
- 13**  Stopping playback. Stopping playback at the point set in Resume playback. Touch one more time to stop playback completely. Refer to *Resume playback (Bookmark)* on page 36.
- 14**  Displaying arrow keys to operate the DVD menu. Refer to *Using the arrow keys* on page 34.
- 15**  Skipping to another title. Selecting a folder during DivX file playback.
- 16**  Moving ahead one frame at a time during playback. Refer to *Frame-by-frame playback* on page 36. Touch and hold for more than two seconds to slow down playback speed. Speeding up the playback speed in four steps during slow motion playback on DVD video/Video CD.
- 17**  Speeding down the playback speed in four steps, during slow motion playback on Video CD.
- 18**  Returning to the specified scene to which the DVD currently being played has been preprogrammed to return. Refer to *Return to the specified scene* on page 38.
- 19**  Playing the video on your iPod in a random order. Refer to *Random play (shuffle)* on page 34.
- 20**  Switching the Advanced sound retriever function setting when playing a video on your iPod. Refer to *Using advanced sound retriever* on page 39.
- 21**  Conducting operation from your iPod and listening to it using your car's speaker's. Refer to *Operating this unit's iPod function from your iPod* on page 34.
- 22**  Switching between media file types to play on DVD/CD/USB/SD. Refer to *Switching the media file type* on page 33.

## Playing moving images

### Playing back videos

- 1 Insert the disc into the disc loading slot with the label side up.  
Playback will automatically start.
- If you are playing a DVD or Video CD, a menu may appear. Refer to *Operating the DVD menu* on page 34 and *PBC playback* on page 38.
  - When the automatic playback function is on, the unit will skip the DVD menu and automatically start playback from the first chapter of the first title. Refer to *Automatic playback of DVDs* on page 61.
- 1 If a disc has already been inserted, press **SRC/OFF** or touch the source icon to select the source.
- While an iPod is connected to this unit, **PIONEER, Accessory Attached** or ✓ (check mark) is displayed on the iPod.
  - When the source icon is not displayed, it can be displayed by touching the screen.
  - Disconnect headphones from the iPod before connecting to this unit.
  - Depending on the iPod model and the amount of data stored in the iPod, it may take some time for playback to begin.
  - Use the touch panel keys to select the iPod after connecting it to this unit.
  - No Device** is displayed when disconnecting the iPod.
- 1 If a message is displayed after loading a disc containing DivX VOD content, touch **Play**.  
Refer to *Playing DivX® VOD content* on page 39.

### Ejecting a disc

- 1 Refer to *Ejecting a disc* on page 13 or *Ejecting an SD* on page 13.

### Selecting a chapter using the buttons

- 1 Press ◀ or ▶ (**TRACK/SEEK**).

### Fast forwarding or reversing using the buttons

- 1 Press and hold ◀ or ▶ (**TRACK/SEEK**).
- Fast forward/fast rewind may not always be possible on some discs. In such cases, normal playback will automatically resume.

- If the bookmark function is on, DVD playback resumes from the selected point. For more details, refer to *Resume playback (Bookmark)* on page 36.
- Some operations may not be available while watching a DVD due to the programming of the disc. In such cases, the ⏸ icon appears on the screen.
- To ensure proper operation, connect the dock connector cable from the iPod directly to this unit.
- If the ignition switch is set to ACC or ON, the iPod battery will be charged while connected. However, the iPod battery is not charged when you select an SD as the source.
- While the iPod is connected to this unit, the iPod cannot be turned on or off. However, the iPod can be turned on or off when you select an SD as the source. ■



### Notes

- This DVD player can play back a DivX file recorded on CD-R/RW or DVD-R/RW. (Please see the following section for files that can be played back. Refer to page 82.)
- Do not insert anything other than a DVD (-R/-RW) or CD (-R/-RW) into the disc loading slot.

## Playing audio

### Introduction of sound playback operations

You can listen to DVD-R/DVD-RW/CD/CD-R/CD-RW/USB/SD/iPod sound files.

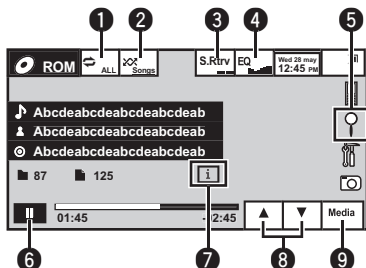

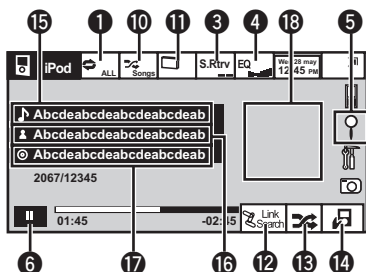

CD



iPod audio

You can control an iPod with this unit by using a cable such as the CD-IU50 (sold separately).

① Touch panel keys

①		Selecting the repeat range. Refer to <i>Repeating playback</i> on page 35.
②		Playing songs in random order. Refer to <i>Random play (shuffle)</i> on page 34.
③		Switching the Advanced sound retriever function setting when playing audio. Refer to <i>Using advanced sound retriever</i> on page 39.



Switching the equalizer curves.  
Refer to *Using the equalizer* on page 55.  
Touch and hold for more than two seconds to turn the auto-equalizer on or off.  
Refer to *Using the auto-equalizer* on page 56.



Displaying a list of track titles/file names to select songs on a CD.  
Refer to *Selecting tracks from the track title list* on page 38.  
Displaying the file name list to select the files.  
Refer to *Selecting files from the file name list* on page 39.  
Displaying iPod menus.  
Refer to *Browsing for a video/music on the iPod* on page 35.



Pausing and starting playback



Switching the text information to display on this unit when playing MP3/WMA/AAC files.

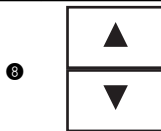

Selecting a folder.



Switching between media file types on a DVD/CD/USB/SD.  
Refer to *Switching the media file type* on page 33.



Playing songs on the iPod in random order.  
Refer to *Random play (shuffle)* on page 34.

## Playing audio

①



Changing the speed of audiobook playback on the iPod.  
Refer to *Changing audio-book speed* on page 39.

⑫



Switching to Link Search mode to play songs related to the currently playing song on the iPod. Refer to *Displaying lists related to the currently playing song (Link Search)* on page 39.

⑬



Playing all songs on the iPod in random order. Refer to *Playing all songs in random order (shuffle all)* on page 35.

⑭



Conducting operation from your iPod and listening to it using your car's speaker's. Refer to *Operating this unit's iPod function from your iPod* on page 34.

### ② Text information

⑮



Displaying the **Songs** list on the iPod. Refer to *Searching for a video/music by category* on page 35.

⑯



Displaying the **Artists** list on the iPod. Refer to *Searching for a video/music by category* on page 35.

⑰



Displaying the **Albums** list on the iPod. Refer to *Searching for a video/music by category* on page 35.

### ③ Artwork display

⑱

Starting **Album Link Search** on your iPod when you touch the artwork display. Refer to *Displaying lists related to the currently playing song (Link Search)* on page 39.

#### Playing back sound

- ① Insert the disc into the disc loading slot with the label side up.  
Playback will automatically start.
- ① If a disc has already been inserted, press **SRC/OFF** or touch the source icon to select the source.
  - While an iPod is connected to this unit, **PIONEER, Accessory Attached** or ✓ (check mark) is displayed on the iPod.
  - When the source icon is not displayed, it can be displayed by touching the screen.
  - Disconnect headphones from the iPod before connecting to this unit.
  - Depending on the iPod model and the amount of data stored in the iPod, it may take some time for playback to begin.
  - Use the touch panel keys to select the iPod after connecting it to this unit.
  - **No Device** is displayed when disconnecting the iPod.

#### Ejecting a disc

- ① Refer to *Ejecting a disc* on page 13 or *Ejecting an SD* on page 13.

#### Selecting a track using the buttons

- ① Press ◀ or ▶ (**TRACK/SEEK**).

#### Fast forwarding or reversing using the buttons

- ① Press and hold ◀ or ▶ (**TRACK/SEEK**).



#### Notes

- When playing back files recorded as VBR (variable bit rate) files, the play time will not be correctly displayed if fast forward or reverse operations are used.
- To ensure proper operation, connect the dock connector cable from the iPod directly to this unit.
- If the ignition switch is set to ACC or ON, the iPod battery will be charged while connected. However, the iPod battery is not charged when you select an SD as the source.
- While the iPod is connected to this unit, the iPod cannot be turned on or off. However, the iPod can be turned on or off when you select an SD as the source.
- If the characters recorded on the disc are not compatible with this unit, those characters will not be displayed.

## Playing audio

- Text information may not be correctly displayed depending on the recorded environment.
- USB storage device that can be charged via USB will be recharged when plugged in and the ignition switch is set to ACC or ON. However, the USB storage device that can be charged via USB will not be recharged when you select an SD as the source.
- Disconnect the USB portable audio player/USB memory when you are done using it.
- When you select **Clock** or **Speana** on *Selecting the background display* on page 67, the artwork is not displayed.

## Introduction of still image playback operations

You can view still images saved in CD-R/CD-RW/USB/SD.

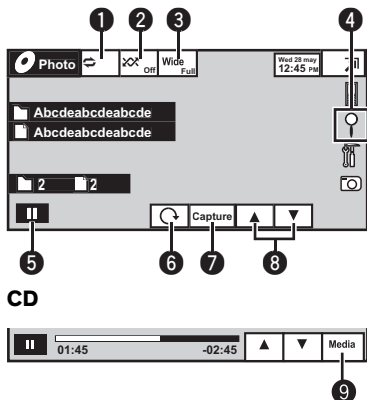

### When playing a disc containing a mixture of various media file types

When loading a CD-R/RW/USB/SD containing JPEG picture files, this unit starts a slideshow from the first folder/picture on the disc/device. The player displays the pictures in each folder in alphabetical order.

The table below shows the controls for viewing a slideshow.

#### ① Touch panel keys

Touch any of the following touch panel keys to select the function to be adjusted.

①		Selecting the repeat range. Refer to <i>Repeating playback</i> on page 35.
②		Playing files in a random order. Refer to <i>Random play (shuffle)</i> on page 34.
③	<b>Wide</b>	Changing the screen mode. Refer to <i>Changing the wide screen mode</i> on page 40.

④		Displaying the file name list to select the files. Refer to <i>Selecting files from the file name list</i> on page 39.
⑤		Starting or pausing the slideshow.
⑥		Rotating the displayed picture 90° clockwise
⑦	<b>Capture</b>	Capturing an image in JPEG files. Refer to <i>Capture an image in JPEG files</i> on page 40.
⑧		Selecting a folder.
⑨	<b>Media</b>	Switching between media file types. Refer to <i>Switching the media file type</i> on page 33.

#### Playing still images

- ① Insert the disc into the disc loading slot with the label side up. Playback will automatically start.
- ① If a disc has already been inserted, press **SRC/OFF** or touch the source icon to select the source.
  - When the source icon is not displayed, it can be displayed by touching the screen.

#### Ejecting a disc

- ① Refer to *Ejecting a disc* on page 13 or *Ejecting an SD* on page 13.

#### Selecting a file using the buttons

- ① Press ◀ or ▶ (**TRACK/SEEK**).

#### Fast file searching

- ① Press and hold ◀ or ▶ (**TRACK/SEEK**).
  - You can search 10 JPEG files at a time.

## Playing still images

### Notes

- This unit can play back a JPEG file recorded on CD-R/RW/ROM/SD/USB storage device. (Please see the following section for files that can be played back. Refer to page 82.)
- Files are played back in file number order and folders are skipped if they contain no files. (If folder **01** (ROOT) contains no files, playback commences with folder **02**.)

## Introduction of still image playback as a slideshow operations

You can view still images saved in CD-R/CD-RW/USB/SD as a slideshow when listening to another source.

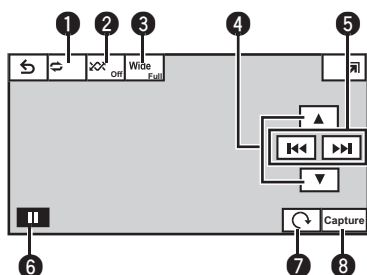

The table below shows the controls for viewing a slideshow.

### ① Touch panel keys

Touch any of the following touch panel keys to select the function to be adjusted.

①		Selecting the repeat range. Refer to <i>Repeating playback</i> on page 35.
②		Playing files in a random order. Refer to <i>Random play (shuffle)</i> on page 34.
③	<b>Wide</b>	Changing the screen mode. Refer to <i>Changing the wide screen mode</i> on page 40.

④		Selecting a folder.
⑤		Selecting a file.
⑥		Starting or pausing the slideshow.
⑦		Rotating the displayed picture 90° clockwise
⑧	<b>Capture</b>	Capturing an image in JPEG files. Refer to <i>Capture an image in JPEG files</i> on page 40.

### 1 Start slideshow when listening to another source.

Refer to *Common operations for menu settings/lists* on page 13.

	Displaying still images as a slideshow.
--	---

### 2 Select the device containing the files that you want to display.

- **Disc** – Built-in DVD player
- **USB** – USB
- **SD** – SD memory card
- To cancel searching, touch **Cancel**.

### Note

When the USB or SD source is selected, this unit cannot view still images on USB/SD as a slideshow.

## Introduction of Bluetooth telephone operations

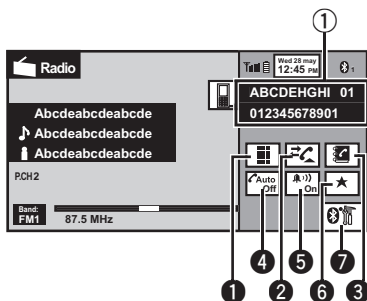

Telephone standby display

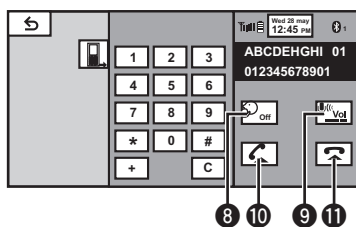

When switching to the entering phone number mode

You can use Bluetooth telephone (AVH-P3200BT only).





### Important

- Since this unit is on standby to connect with your cellular phone via Bluetooth wireless technology, using it without the engine running can drain the battery power.
- Advanced operations that require attention such as dialing numbers on the monitor, etc., are prohibited while driving. Park your vehicle in a safe place when using these advanced operations.
- Operations available may be limited depending on the cellular phone connected to this unit.

- Be sure to park your vehicle in a safe place and apply the parking brake when performing this operation.

- ① Incoming call notice  
Indicates that an incoming call has been received and has not been checked yet.
  - Not displayed for calls made when your cellular phone is disconnected from this unit.
- ② Touch panel keys

①  Switching the mode to enter the phone number directly. Refer to *Making a call by entering phone number* on page 48.

②  Switching to the call history list. Refer to *Using the missed, received and dialed call lists* on page 47.

③  Switching to the phone book mode. Refer to *Calling a number in the phone book* on page 46. Refer to *Selecting a number by alphabet search mode* on page 46.

④  Turning automatic answering on or off. Refer to *Setting automatic answering* on page 48.

⑤  Turning the ring tone for incoming calls on or off. Refer to *Switching the ring tone* on page 48.

⑥  Displaying the preset dial screen. Refer to *Using the preset dial lists* on page 48.

⑦  Displaying the Bluetooth connection menu. Refer to the instructions from page 49 to page 51.

⑧  Turning private mode on or off. Refer to *Setting the private mode* on page 49.



## Bluetooth Telephone

9



Adjusting the other party's listening volume.  
Refer to *Adjusting the other party's listening volume* on page 48.

10



Accepting an incoming call.  
Making a phone call, when selecting a phone number.  
Switching between callers on hold.

11



Ending a call.  
Rejecting an incoming call.  
Canceling call waiting.

Accepting an incoming call  
Ending a call  
1 Press **MUTE**.



### Notes

- Private mode can only be operated while you are talking on the phone.
- To end the call, both you and the other caller must hang up your phones.

## Setting up for hands-free phoning

Before you can use the hands-free phoning function you must set up the unit for use with your cellular phone. This entails establishing a Bluetooth wireless connection between this unit and your phone, registering your phone with this unit, and adjusting the volume level.

### 1 Connection

First, you need to connect a Bluetooth telephone to this unit.

For detailed instructions on connecting your phone to this unit via Bluetooth wireless technology, see following section. *Using a Bluetooth device to pair* on page 50 and *Pairing from this unit* on page 49.

- You may also need to enter a PIN code into this unit. If your telephone requires a PIN code to establish a connection, look for the code on the telephone or in its accompanying documentation. Refer to *Entering PIN code for Bluetooth wireless connection* on page 51.

### 2 Volume adjustment

Adjust the earpiece volume of your cellular phone to your preference. The unit will record the adjusted volume level as the default setting.

- The volume of the caller's voice and ring tone may vary depending on the type of cellular phone.
- If there is a large volume difference between the ring tone and caller's voice, the overall volume level may become unstable.
- Make sure to adjust the volume to a proper level before disconnecting the cellular phone from the unit. If the volume is muted (zero level) on your cellular phone, the volume level of your cellular phone remains muted even after the cellular phone is disconnected.



## Introduction of XM/SIRIUS tuner operations

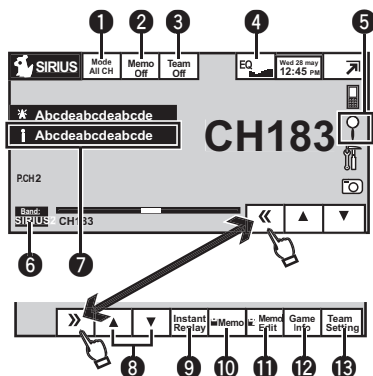

### SIRIUS tuner

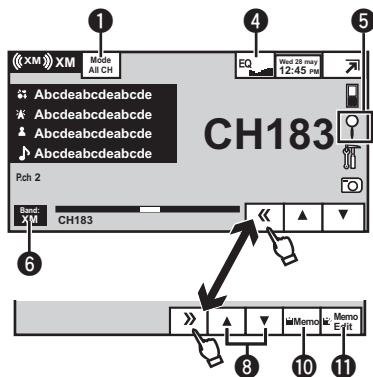

### XM tuner

You can use this unit to control an XM satellite digital tuner (GEX-P920XM), which is sold separately.

For details concerning operation, refer to the XM tuner's operation manuals. This section provides information on XM operations with this unit which differs from that described in the XM tuner's operation manual.

When the SIRIUS tuner is used together with this unit, some operations differ slightly from those described in the SIRIUS operation manual. This manual provides information on

these points. For all other information on using the SIRIUS tuner, please refer to the SIRIUS operation manual.

- With this unit, you can operate one additional function: XM/SIRIUS channel direct selection. Refer to *Selecting an XM/SIRIUS channel directly* on page 42.

① Touch panel keys

①	<div style="border: 1px solid black; padding: 5px; margin-bottom: 5px;">Mode All CH</div> <div style="border: 1px solid black; padding: 5px;">Mode Category</div>	<p>Selecting a channel by number or category. Refer to <i>Switching the XM/SIRIUS channel selection mode</i> on page 41.</p>
②	<div style="border: 1px solid black; padding: 5px; margin-bottom: 5px;">Memo On</div> <div style="border: 1px solid black; padding: 5px;">Memo Off</div>	<p>Tuning the MyMix function on or off for the SIRIUS tuner. Refer to <i>Turning the MyMix function on or off</i>, on page 43.</p>
③	<div style="border: 1px solid black; padding: 5px; margin-bottom: 5px;">Team On</div> <div style="border: 1px solid black; padding: 5px;">Team Off</div>	<p>Turning the Game Alert on or off for the SIRIUS tuner. Refer to <i>Switching the Game Alert on or off</i> on page 44.</p>
④	<div style="border: 1px solid black; padding: 5px; text-align: center;">EQ</div>	<p>Switching the equalizer curves. Refer to <i>Using the equalizer</i> on page 55. Touch and hold for more than two seconds to turn the auto-equalizer on or off. Refer to <i>Using the auto-equalizer</i> on page 56.</p>
⑤	<div style="border: 1px solid black; padding: 5px; text-align: center;">🔍</div>	<p>Displaying the preset channel list. Refer to <i>Storing and recalling stations</i> on page 32. Selecting a channel directly. Refer to <i>Selecting an XM/SIRIUS channel directly</i> on page 42. Selecting a channel from the XM channel list. Refer to <i>Selecting a channel from the XM channel list display</i> on page 41.</p>

# XM/SIRIUS tuner

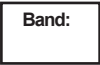
6  **Band:** Selecting a band (**XM1**, **XM2** or **XM3**) for XM tuner. Selecting a band (**SIRIUS1**, **SIRIUS2** or **SIRIUS3**) for the SIRIUS tuner.

8  Recalling radio station frequencies assigned to preset tuning keys. Refer to *Storing and recalling stations* on page 32. Selecting the channel category when selecting **Mode Category**. Refer to *Switching the XM/SIRIUS channel selection mode* on page 41 and *Selecting a SIRIUS channel from a channel category* on page 41.

9  **Instant Replay** Selecting a track, fast forwarding/reversing or pausing/playing for the SIRIUS tuner. Refer to *Using the Instant Replay function* on page 45.

10  **Memo** Storing the song title and artist name. Refer to *Making the MyMix playlist* on page 42.

11  **Memo Edit** Switching to memo edit mode. Refer to *Setting up a song alert* on page 43. Refer to *Deleting a song from the MyMix playlist for XM tuner* on page 43. Refer to *Deleting a song from the MyMix playlist for SIRIUS tuner* on page 43.

12  **Game Info** Displaying information on games for the SIRIUS tuner. Refer to *Displaying game information* on page 45.

13  **Team Setting** Selecting teams for game alert on the SIRIUS tuner. Refer to *Selecting teams for Game Alert* on page 44.

7 Switching the SIRIUS information. Refer to *Switching the SIRIUS display* on page 45. Touch and hold for more than two seconds to scroll the text.

Manual tuning (step by step) using the buttons  
 Press ◀ or ▶ (**TRACK/SEEK**).

Seek tuning using the buttons  
 Press and hold ◀ or ▶ (**TRACK/SEEK**).

## Note

You can also perform tuning from a desired channel category. (Refer to *Selecting a SIRIUS channel from a channel category* on page 41.) 

① SIRIUS tuner information

## Introduction of HD Radio™ tuner operations

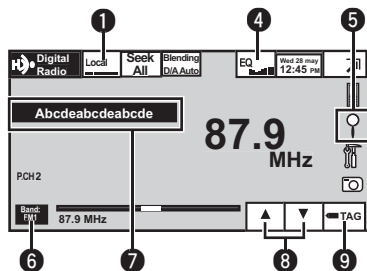

You can use this unit to control an HD Radio tuner (e.g. GEX-P20HD), which is sold separately.

For details concerning operation, refer to the HD Radio tuner's operation manual.

### ① Touch panel keys

① **Local** Turning local seek tuning on or off.  
Refer to *Tuning in to strong HD Radio signals* on page 32.

② **Seek All** Switching between Digital broadcasting station seek and normal seek.  
Refer to *Switching the seek mode* on page 46.

③ **Seek HD**

③ **Blending D/A Auto** Switching to the analog broadcast of the same frequency.  
Refer to *Switching the reception mode* on page 46.

④ **Blending Analog**

④ **EQ** Switching the equalizer curves.  
Refer to *Using the equalizer* on page 55.  
Touch and hold for more than two seconds to turn the auto-equalizer on or off.  
Refer to *Using the auto-equalizer* on page 56.

⑤  Displaying the preset channel list.  
Refer to *Storing and recalling stations* on page 32.

⑥ **Band:** Selecting a band (FM1, FM2, FM3 for FM or AM).

⑧  Recalling radio station frequencies assigned to preset tuning keys.  
Refer to *Storing and recalling stations* on page 32.

⑨ **TAG** Saving song information (tag) from the broadcasting station to your iPod.

### ① Digital Radio tuner information

⑦ Switching the digital radio tuner information.

Manual tuning (step by step) using the buttons

① Press ◀ or ▶ (**TRACK/SEEK**).

Seek tuning using the buttons

① Press and hold ◀ or ▶ (**TRACK/SEEK**).



## Using Bluetooth wireless technology

### Introduction of Bluetooth telephone operations

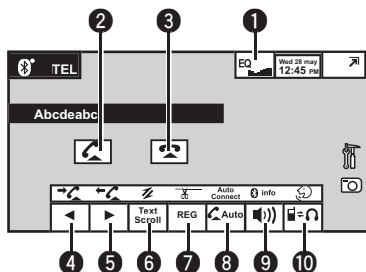









When you connect a Bluetooth adapter (e.g. CD-BTB200)(sold separately) to AVH-P4200DVD/AVH-P3200DVD, you can control Bluetooth telephone.

#### Important

- In some countries, CD-BTB200 is not sold on the market.
- Since this unit is on standby to connect with your cellular phone via Bluetooth wireless technology, using it without the engine running can drain the battery power.
- Advanced operations that require attention such as dialing numbers on the monitor, using the phone book, etc., are prohibited while driving. Park your vehicle in a safe place when using these advanced operations.
- Operations available may be limited depending on the cellular phone connected to this unit.

① Touch panel keys

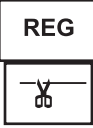
<p>1</p> 	<p>Switching the equalizer curves. Refer to <i>Using the equalizer</i> on page 55. Touch and hold for more than two seconds to turn the auto-equalizer on or off. Refer to <i>Using the auto-equalizer</i> on page 56.</p>
<p>2</p> 	<p>Accepting an incoming call. Making a phone call, when selecting a phone number from the dialed and received call history.</p>
<p>3</p> 	<p>Ending a call. Rejecting an incoming call. Canceling call waiting.</p>
<p>4</p>  	<p>Displaying the received/missed call history. Selecting a phone number from the call history. Refer to <i>Using the missed, received and dialed call lists</i> on page 47.</p>
<p>5</p>  	<p>Displaying the dialed call history. Selecting a phone number from the call history. Refer to <i>Using the missed, received and dialed call lists</i> on page 47.</p>
<p>6</p> 	<p>Scrolling the phone number. Touch and hold for more than two seconds to activate connection mode on this unit and establish a Bluetooth wireless connection from your phone. Refer to <i>Using a cellular phone to initiate a connection</i> on page 51.</p>
<p>7</p> 	<p>Registering connected cellular phone to take full advantage of the features available with Bluetooth wireless technology. Refer to <i>Registering a connected cellular phone</i> on page 52. Touch and hold for more than two seconds to terminate the Bluetooth wireless connection.</p>

## Using Bluetooth wireless technology

8



Turning automatic answering on or off.

Refer to *Setting automatic answering* on page 48.

Touch and hold for more than two seconds to connect to a Bluetooth telephone automatically.

Refer to *Connecting to a Bluetooth device automatically* on page 52.

9



Turning the ring tone for incoming calls on or off.

Refer to *Switching the ring tone* on page 48.

Touch and hold for more than two seconds to display the BD address of your cellular phone and the Bluetooth adapter.

Refer to *Displaying BD (Bluetooth Device) address* on page 52.

10



Switching between Bluetooth telephone and Bluetooth audio.

Touch and hold for more than two seconds to start voice recognition.

Refer to *Voice recognition* on page 52.

### Setting up for hands-free phoning

Before you can use the hands-free phoning function you must set up the unit for use with your cellular phone. This entails establishing a Bluetooth wireless connection between this unit and your phone, registering your phone with this unit, and adjusting the volume level.

#### 1 Connection

First, you need to connect a Bluetooth telephone to this unit.

For detailed instructions on connecting your phone to this unit via Bluetooth wireless technology, see following section. *Using a cellular phone to initiate a connection* on page 51 and *Registering a connected cellular phone* on page 52.

#### 2 Volume adjustment

Adjust the earpiece volume of your cellular phone to your preference. The unit will record the adjusted volume level as the default setting.

- The volume of the caller's voice and ring tone may vary depending on the type of cellular phone.
- If there is a large volume difference between the ring tone and caller's voice, the overall volume level may become unstable.
- Make sure to adjust the volume to a proper level before disconnecting the cellular phone from the unit. If the volume is muted (zero level) on your cellular phone, the volume level of your cellular phone remains muted even after the cellular phone is disconnected.



### Bluetooth audio operations

When you connect a Bluetooth adapter (e.g. CD-BTB200)(sold separately) to AVH-P4200DVD/AVH-P3200DVD, you can control Bluetooth audio.



#### Important

- Depending on the Bluetooth audio player connected to this unit, the available operations will be limited to the following two levels:
  - A2DP profile (Advanced Audio Distribution Profile): You can only playback songs on your audio player.
  - AVRCP profile (Audio/Video Remote Control Profile): You can perform playback, pause playback, select songs, etc.

## Using Bluetooth wireless technology

- Since there are a number of Bluetooth audio players available on the market, available operations will vary extensively. When operating your player with this unit, refer to the instruction manual that came with your Bluetooth audio player as well as this manual.
- Information related to a song (such as the elapsed playing time, song title, song index, etc.) cannot be displayed on this unit.
- As the signal from your cellular phone may cause noise, avoid using it when you are listening to songs on your Bluetooth audio player.
- When a call is in progress on the cellular phone connected to this unit via Bluetooth wireless technology, the sound of the Bluetooth audio player connected to this unit is muted.
- When the Bluetooth audio player is in use, you cannot connect to a Bluetooth telephone automatically.
- Playback continues even if you switch from your Bluetooth audio player to another source while listening to a song.

### ① Touch panel keys



Switching between Bluetooth telephone and Bluetooth audio.

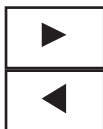

Skipping back or forward to another track when Auto is set for the Auto/manual setting.  
Performing fast forward or rewind when Manual is set for the Auto/manual setting.

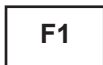

Pausing a song.  
Touch and hold for more than two seconds to activate connection mode on this unit and establish a Bluetooth wireless connection from your player.  
Refer to *Connecting a Bluetooth audio player* on page 52.

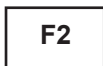

Playback starts.  
Touch and hold for more than two seconds to terminate the Bluetooth wireless connection.

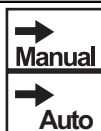

Setting the action for ◀ and ▶ icons.



Switching the equalizer curves.  
Refer to *Using the equalizer* on page 55.  
Touch and hold for more than two seconds to turn the auto-equalizer on or off.  
Refer to *Using the auto-equalizer* on page 56.

## Setting up for Bluetooth audio

Before you can use the Bluetooth audio function you must set up the unit for use with your Bluetooth audio player. This entails establishing a Bluetooth wireless connection between this unit and your Bluetooth audio player, and pairing your Bluetooth audio player with this unit.

- ① Connection  
First, you need to connect a Bluetooth audio to this unit.  
For detailed instructions on connecting your Bluetooth audio to this unit via Bluetooth wireless technology, see *Connecting a Bluetooth audio player* on page 52.

## Storing and recalling stations

You can easily store up to six stations for each band as presets.

- Six stations for each band can be stored in memory.
- Channels are stored and recalled on a broadcast station basis. This means that if the broadcast station you stored has been assigned to a different channel by SIRIUS, you can still recall the same broadcast station (though a different channel number may appear in the display).

### 1 Display the preset screen.

Refer to *Introduction of tuner operations* on page 15.

Refer to *Introduction of XM/SIRIUS tuner operations* on page 26.

Refer to *Introduction of HD Radio™ tuner operations* on page 28.

The preset screen appears in the display.

### 2 Touch and hold one of the preset tuning keys to store the selected frequency in the memory.

The selected radio station frequency has been stored in the memory.

### 3 Touch one of the preset tuning keys to select the desired station.

- You can also use ▲ and ▼ to recall stations assigned to preset tuning keys **Preset1** to **Preset6** when the **Mode All CH** mode is selected.

(Function of SIRIUS tuner) 

## Storing the strongest stations

BSM (best stations memory) automatically stores the six strongest stations in the order of their signal strength.

Storing broadcast frequencies with BSM may replace broadcast frequencies you have saved using the preset tuning keys.

### 1 Display the preset screen.

Refer to *Introduction of tuner operations* on page 15.

Refer to *Introduction of HD Radio™ tuner operations* on page 28.

The preset screen appears in the display.

### 2 Touch BSM to turn BSM on.

The six strongest broadcast frequencies will be stored under preset tuning keys in order of their signal strength.

- To cancel the storage process, touch **Cancel**. 

## Tuning in to strong signals

Local seek tuning lets you tune in to only those radio stations with sufficiently strong signals for good reception.

FM: off — 

AM: off — 

The larger the setting number, the higher the signal level. The highest level setting allows reception of only the strongest stations; while lower settings let you receive progressively weaker stations. 

## Tuning in to strong HD Radio signals

Local seek tuning lets you tune in to only those radio stations with sufficiently strong signals for good reception.

### 1 Start local seek tuning

Refer to *Introduction of HD Radio™ tuner operations* on page 28.

### 2 Touch On on Local to turn on.

- To turn off, touch **Off**.

### 3 Touch ◀ or ▶ on Level to select the desired level.

- **Level1—Level2—Level3—Level4**



## Detailed instructions

- The larger the setting number, the higher the signal level. The highest level setting allows reception of only the strongest stations; while lower settings let you receive progressively weaker stations. 

### Using iTunes tagging

*This function can be operated with the following iPod models.*

- iPod 5th generation
- iPod nano 3rd generation
- iPod nano 4th generation
- iPod classic
- iPod classic 2nd generation
- iPod touch
- iPod touch 2nd generation
- iPhone
- iPhone 3G

*However, tag information can be stored in this unit even while other iPod models are used.*

*When you want to use this function in the HD Radio tuner source, use an HD Radio tuner (GEX-P20HD).*

The song information (tag) can be saved from the broadcasting station to your iPod. The songs will show up in a playlist called "Tagged playlist" in iTunes the next time you sync your iPod. Then you can directly buy the songs you want from the iTunes Store.

The tagged songs and the song that you can buy from the iTunes Store may be different. Make sure to confirm the song before you make the purchase.

If you cannot use this function normally, update your iPod firmware.

### Storing the tag information to this unit

#### 1 Tune in to the broadcast station.

#### 2 Store the tag information to this unit.

Refer to *Introduction of tuner operations* on page 15.

Refer to *Introduction of HD Radio™ tuner operations* on page 28.

You can store the information if the **TAG** indicator is displayed while the desired song is being broadcast.

- While storing the tag data on this unit, **TAG** flashes.
- The tag information for up to 50 songs can be stored on this unit.

Depending on the timing of when the tag information is stored, the tag information for the song played before or after the currently playing song may also be stored.

- If an SD is selected as the source while tag information is being stored to this unit, the tag information will not be transferred to the iPod.

#### 3 When completed, indicator turns off and indicator is displayed.

### Storing the tagged information to your iPod

#### 1 Connect your iPod if it's not connected to this unit.

When your iPod is connected to this unit, your iPod starts storing the tagged information automatically.

- While transferring the tag, you cannot select the SD source.

#### 2 When completed, indicator on page 79 turns off and the tagged information is stored on your iPod.

- Tag information cannot be transferred to the iPod when a file on an SD device is being viewed as a slideshow. 

### Switching the media file type

When playing a disc containing a mixture of various media file types, such as DivX and MP3, you can switch between media file types to play.

## Detailed instructions

Audio data (CD-DA) and JPEG picture files on DVD-R/RW/ROM cannot be played back on this unit.

**CD** (audio data (CD-DA))—**Music** (compressed audio)—**Video** (DivX video files)—**Photo** (JPEG picture files) 

### Operating the DVD menu

(Function for DVD video)

Some DVDs allow you to make a selection from the disc contents using a menu.

#### Using the arrow keys

##### 1 Display arrow keys to operate the DVD menu.

Refer to *Playing moving images* on page 16.

##### 2 Select the desired menu item.



Selecting the desired menu item.



Starting playback from the selected menu item.



Operating the DVD menu by directly touching the menu item.

- When operating the DVD menu by directly touching the menu item, touch the icon to operate.



Returning to the normal DVD video display.



Displaying arrow keys.

- Ways to display the menu will differ depending on the disc.
- Depending on the contents of the DVD disc, this function may not work properly. In such cases, use the touch panel keys to operate the DVD menu. 

### Operating this unit's iPod function from your iPod

- While this function is in use, the iPod will not turn off even if the ignition key is turned off. Operate the iPod to turn off the power.
- When the control mode is set to iPod, the signal can be changed between PAL and NTSC from the iPod.

##### 1 Switch the control mode to iPod.

Refer to *Playing moving images* on page 16.

Refer to *Introduction of sound playback operations* on page 19.

##### 2 Operate the connected iPod to select a video/song and play.

### Random play (shuffle)

Videos/songs can be played back in random order.

- **Songs** – Play back videos/songs in the selected list in random order.
- **Albums** – Play back videos/songs from a randomly selected album in order.
- **Folder** – Play back songs/tracks in the selected folder in random order.
- **Disc** – Play back songs/tracks in the selected disc in random order.
- **On** – Play back files in random order within the repeat range, **Folder** and **Disc**.
- **Off** – Cancel random play. 

## Detailed instructions

### Playing all songs in random order (shuffle all)

(Function for iPod)

This method plays all songs on the iPod randomly. 

### Repeating playback

- **Disc** – Play through the current disc
  - **Chapter** – Repeat the current chapter
  - **Title** – Repeat the current title
  - **Track** – Repeat the current track
  - **File** – Repeat the current file
  - **Folder** – Repeat the current folder
  - **One** – Repeat just the current video/song/track
  - **All** – Repeat all videos/songs in the selected list on the iPod  
Repeat all files
- This function cannot be operated during Video CD playback featuring PBC (playback control).
  - If you perform chapter search, fast forward/reverse, frame-by-frame playback or slow motion playback, the repeat play will stop.
  - When playing discs with compressed audio and audio data (CD-DA), playback is repeated within the type of data currently playing even if **Disc** is selected.
  - If you select another folder during repeat play, the repeat play range changes to **Disc**. If you select USB or SD source, the repeat play range changes to **All**.
  - If you perform track search or fast forward/reverse during **File**, the repeat play range changes to **Folder**.
  - If you perform track search or fast forward/reverse during **Chapter**, the repeat play range changes to **Title**.
  - If you perform track search or fast forward/reverse during **Track**, the repeat play range changes to **Disc**.
  - When **Folder** is selected, it is not possible to play back a subfolder of that folder. 

### Playing videos from your iPod

(Function for iPod)

Videos can be played on this unit if an iPod with video capabilities is connected.

- This unit can play back "Movies", "Music videos", "Video Podcast" and "TV show" which are downloaded from the iTunes store.
- Before you display the video screen, be sure to change the video setting on the iPod so that the iPod can output the video to an external device.

#### 1 Display the iPod menus.

Refer to *Playing moving images* on page 16.

#### 2 Switch to iPod video mode.



Switching to iPod video mode.

#### 3 Play the video from the iPod.

- If you want to switch to iPod music mode, touch the icon.



Switching to iPod music mode.



### Browsing for a video/music on the iPod

(Function for iPod)

To make operating and searching easy, operations to control an iPod with this unit are designed to be as similar to the iPod as possible.

- Incompatible text saved on the iPod will not be displayed by the unit.

### Searching for a video/music by category

#### 1 Display the iPod menus.

Refer to *Playing moving images* on page 16.

## Detailed instructions

Refer to *Playing audio* on page 19.

### 2 Touch one of the categories in which you want to search for a video/music.

- **Video Playlists** (video playlists)
- **Movies** (movies)
- **Music Videos** (music videos)
- **Video Podcasts** (video podcasts)
- **TV Shows** (TV shows)
- **Playlists** (playlists)
- **Artists** (artists)
- **Albums** (albums)
- **Songs** (songs)
- **Podcasts** (podcasts)
- **Genres** (genres)
- **Composers** (composers)
- **Audiobooks** (audiobooks)

### 3 Touch the title of the list that you want to play.

Repeat this operation until you find the desired video/music.

### 4 Start playback of the selected list.



Starting playback of the selected list.

## Searching the list by alphabet

(Function for iPod)

### 1 Select a category.

Refer to *Searching for a video/music by category* on the previous page.

### 2 Switch to alphabet search mode.



Switching to alphabet search mode.

Alphabet search mode is displayed.

### 3 Touch the first letter of the title of the video/song you are looking for.

While searching, touch panel key operation is not available.

- To refine the search with a different letter, touch **Cancel**.

### 4 Touch the title of the list that you want to play.

Repeat this operation until you find the desired song/video.

### 5 Start playback of the selected list.



Starting playback of the selected list.



## Resume playback (Bookmark)

(Function for DVD video)

By using the Bookmark function, you can resume playback from a selected scene the next time the disc is loaded.

The selected scene will be bookmarked so that playback resumes from that point next time.

- To clear the bookmark on a disc, touch and hold the button during playback.
- The oldest bookmark is replaced by the new one.

## Frame-by-frame playback

(Function for DVD video/video CD/DivX file)

Images during frame-by-frame playback may be unclear for some discs.

## Slow motion playback



### Notes

- There is no sound during slow motion playback.
- Images during slow motion playback may be unclear for some discs.
- Reverse slow motion playback is not available.

## Detailed instructions

### Searching for the part you want to play

You can use the search function to find the part you want to play.

For DVD videos, you can select **Title** (title), **Chapter** (chapter) or **10key** (numeric keypad). For video CDs, you can select **Track**(track) or **10key**(numeric keypad).

- Chapter search is not available when disc playback is stopped.
- This function cannot be operated during some DVD videos or Video CD playback featuring PBC (playback control).

#### 1 Start the search function.

Refer to *Playing moving images* on page 16.

#### 2 Touch the desired search option (e.g., Chapter).

#### 3 Touch 0 to 9 to input the desired number.

- To cancel the entered numbers, touch C.

#### 4 Start playback from the selected part.



Registering the numbers and starting playback.

#### Note

With discs featuring a menu, you can also use the DVD menu to make your selection.

Refer to *Playing moving images* on page 16. 

### Changing audio language during playback (Multi-audio)

With DVDs/DivX files that provides audio playback in different languages and different audio systems (Dolby Digital, DTS, etc.), you can switch between languages/audio systems during playback.

#### Notes

- With some DVDs, switching between languages/audio systems may only be possible using a menu display.
- You can also switch between languages/audio systems using **Video Setup Menu**. For details, refer to *Setting the audio language* on page 58.
- Only digital output of DTS audio is possible. If the unit's optical digital outputs are not connected, select an audio setting other than DTS.
- Depending on the setting, the video may not be played back with the audio system used to record the DVD.
- You will return to normal playback if you change the **Audio** during fast forward/fast rewind, pause or slow motion playback. 

### Changing the subtitle language during playback (Multi-subtitle)

With DVDs/DivX files featuring multi-subtitle recordings, you can switch between subtitle languages during playback.

#### Notes

- With some DVDs, switching between subtitle languages may only be possible using a menu display.
- You can also switch between subtitle languages using **Video Setup Menu**. For details, refer to *Setting the subtitle language* on page 58.
- You will return to normal playback if you change the **Subtitle** during fast forward/fast rewind, pause or slow motion playback. 

## Changing the viewing angle during playback (Multi-angle)

With DVDs featuring multi-angle (scenes shot from multiple angles) recordings, you can switch among viewing angles during playback.

- During playback of a scene shot from multiple angles, the angle icon is displayed. Use the **Video Setup Menu** to turn the angle icon display on or off. For details, refer to *Setting the multi-angle DVD display* on page 59.



### Note

You will return to normal playback if you change the viewing angle during fast forward/fast rewind, pause or slow motion playback.

## Return to the specified scene

(Function for DVD video)

This function cannot be used if a specified scene has not been preprogrammed on the DVD disc.

## Selecting audio output

When playing DVD video discs recorded with LPCM audio, you can switch the audio output. When playing video CDs, you can switch between stereo and monaural audio output.

- This function is not available when disc playback is stopped.
- **L+R** – left and right
- **Left** – left
- **Right** – right
- **Mix** – mixing left and right

You may not be able to select or use this function depending on the disc and the playback location.

## PBC playback

(Function for Video CDs)

During playback of Video CDs featuring PBC (Playback Control), **PBC ON** is displayed.

### 1 Start the search function.

Refer to *Playing moving images* on page 16.

### 2 Touch 10key to display the numeric keypad.

### 3 Touch 0 to 9 corresponding to a menu number.

### 4 Start playback from the selected part.



Registering the numbers and starting playback.



### Notes

- You can display the menu by touching **Return** during PBC playback. For details, refer to the instructions provided with the disc.
- PBC playback of a Video CD cannot be canceled.
- During playback of Video CDs featuring PBC (Playback Control), you cannot select the repeat play range or use the search function.

## Selecting tracks from the track title list

You can select tracks to playback using the track title list which is a list of the tracks recorded on a disc.

### 1 Display the track title list.

Refer to *Playing audio* on page 19.

### 2 Touch your favorite track title.

Playback begins.

## Detailed instructions

### Selecting files from the file name list

(Function for USB/SD/DivX)

File name list is a list of file names (or folder names) from which you can select a file (or folder) to play back.

#### 1 Display the file (or folder) name list.

Refer to *Playing audio* on page 19.

Refer to *Introduction of still image playback operations* on page 22.

#### 2 Touch your favorite file (or folder) name.

- When you have selected a folder, a list of the names of the files (or the folders) in it can be viewed. Repeat this operation to select the desired file name.
- If folder **01** (ROOT) contains no files, playback commences with folder **02**.

#### 3 Start playback of the selected list.



Starting playback of the selected list.



### Using advanced sound retriever

Automatically enhances compressed audio and restores rich sound.

Off — ■ — ■ ■ ■

- ■ ■ is more effective than ■.

### Changing audiobook speed

(Function for iPod)

- ■ ■ ■ — Playback at a speed faster than normal
- ■ ■ — Playback at normal speed
- ■ — Playback at a speed slower than normal

### Displaying lists related to the currently playing song (Link Search)

(Function for iPod)

#### 1 Start Link Search.

Refer to *Introduction of sound playback operations* on page 19.

#### 2 Touch one of the categories in which you want to play.

- **Artist** – Displays an album list of the artist currently being played.
- **Album** – Displays a song list from the album currently being played.
- **Genre** – Displays an album list from the genre currently being played.
- To cancel searching, touch **Cancel**.

#### 3 Touch the title of the list that you want to play.

#### 4 Start playback of the selected list.



Starting playback of the selected list.

- If no related albums/songs are found, **Not Found** is displayed.

### Playing DivX® VOD content

Some DivX VOD (video on demand) content may only be playable a fixed number of times. When you load a disc containing this type of content, the remaining number of times it can be played is shown on-screen. You can then decide whether or not to play the disc.

- If there is no limit to the number of times the DivX VOD content can be viewed, then you may load the disc into your player and play the content as often as you like, and no message will be displayed.
- You can confirm the number of times that the content can be played by checking the number displayed after **Remaining Views**:



### Important

- In order to play DivX VOD content on this unit, you first need to register the unit with your DivX VOD content provider. For details on your registration code, refer to *Displaying the DivX® VOD registration code* on page 61.
- DivX VOD content is protected by a DRM (Digital Rights Management) system. This restricts playback of content to specific, registered devices.

### ● If a message is displayed after loading a disc containing DivX VOD content, touch Play.

Playback of the DivX VOD content will start.

- To skip to the next file, touch **Next Play**.
- If you do not want to play the DivX VOD content, touch **Stop**. 

## Capture an image in JPEG files

You can capture image data and use it as wallpaper. Images can be stored and recalled easily in this unit.

- Only one image can be stored on this unit. Old images are overwritten with the new ones.

### 1 Pause the slideshow when the desired image is displayed.

Refer to *Introduction of still image playback operations* on page 22.

Refer to *Introduction of still image playback as a slideshow operations* on page 23.

### 2 Capture the image.

Refer to *Introduction of still image playback operations* on page 22.

Refer to *Introduction of still image playback as a slideshow operations* on page 23.

### 3 When Do you save this image? is displayed, touch Yes.

While storing the image to this unit, **Saving the image** **Don't switch off the battery.** is

displayed. When the process is finished,

**Image saved** is displayed.

- To cancel the storage process, touch **No**. 

## Changing the wide screen mode

You can select a desired mode for enlarging a 4:3 picture to a 16:9 picture.

### 1 Display the screen mode.

Refer to *Introduction of video playback operations* on page 16.

Refer to *Introduction of still image playback operations* on page 22.

Refer to *Introduction of still image playback as a slideshow operations* on page 23.

### 2 Touch the desired wide mode setting.

#### Full (full screen)

The 4:3 picture is enlarged in the horizontal direction only, giving you a 4:3 TV picture (normal picture) without any omissions.

#### Just (just)

The picture is enlarged slightly at the center and the amount of enlargement increases horizontally toward the edges of the screen, enabling you to enjoy a 4:3 picture without sensing any disparity even when viewing on a wide screen.

#### Cinema (cinema)

The picture is enlarged by the same proportion as **Full** or **Zoom** in the horizontal direction and by an intermediate proportion between **Full** and **Zoom** in the vertical direction; ideal for a cinema-sized picture (wide screen picture) where captions lie outside the picture.

#### Zoom (zoom)

The 4:3 picture is enlarged in the same proportion both vertically and horizontally; ideal for a cinema sized picture (wide screen picture).



## Detailed instructions

### Normal (normal)

The 4:3 picture is displayed as it is, giving you no sense of disparity since its proportions are the same as that of the normal picture.

### Notes

- You cannot operate this function while driving.
- Different settings can be stored for each video source.
- When a video is viewed in a wide screen mode that does not match its original aspect ratio, it may appear different.
- Remember that using the wide mode feature of this system for commercial or public viewing purposes may constitute an infringement on the author's rights protected by the Copyright Law.
- The video image will appear coarser when viewed in **Cinema** or **Zoom** mode. 

## Switching the XM/SIRIUS channel selection mode

You have two methods for selecting a channel: by number and by category. When selecting by number, channels in any category can be selected. Select by category to narrow your search down to only channels in a particular category.

**Mode All CH** (channel number select setting)  
—**Mode Category** (channel category select setting)

## Selecting a SIRIUS channel from a channel category

Channels are organized into various program categories, e.g. Rock, Classic, Jazz while listening to a SIRIUS station. You can specify channels by selecting the desired category.

### 1 Select channel category selection mode.

Refer to *Introduction of XM/SIRIUS tuner operations* on page 26.

**Mode All CH** (channel number select setting)  
—**Mode Category** (channel category select setting)

### 2 Touch ▲ or ▼ to select the desired channel category.

### 3 Touch ◀ or ▶ on the buttons to select the desired channel in the selected channel category.

## Selecting a channel from the XM channel list display

The list content can be switched so you can search for the track you want to listen to not only by the channel name but also by the artist name or song title.

- This function is available for GEX-P920XM.
- The channel list shows all the channels during **Mode All CH** mode, and the channels included in the selected category during **Mode Category** mode.

### 1 Display the preset channel list.

Refer to *Introduction of XM/SIRIUS tuner operations* on page 26.

### 2 Switch the channel list mode.



Switching the channel list mode to the channel name or the artist name/song title.

### 3 Touch the desired channel that you want to listen to.

## Selecting an XM/SIRIUS channel directly

You can select an XM/SIRIUS channel directly by entering the desired channel number.

### 1 Display the preset channel list.

Refer to *Introduction of XM/SIRIUS tuner operations* on page 26.

### 2 Switch to direct input display.



Switching to direct input display.

### 3 Touch 0 to 9 to input the desired channel number.

- To cancel the input numbers, touch **C**.

### 4 Select the XM/SIRIUS channel of the entered number.

The XM/SIRIUS channel of the entered number is selected.



Selecting the XM/SIRIUS channel of the entered number.



to a song that matches a song title and its artist name in the MyMix playlist.

### ● Store the song title and artist name.

Refer to *Introduction of XM/SIRIUS tuner operations* on page 26.

The song title and artist name of the song you are listening to are stored, and a confirmation message appears.

- To delete a song from the MyMix playlist, refer to *Deleting a song from the MyMix playlist for XM tuner* on the next page and *Deleting a song from the MyMix playlist for SIRIUS tuner* on the next page.

- (XM tuner)

The song title and artist name of up to 12 tracks can be stored. Old tracks will be overwritten when saving more than 12 tracks.

- (SIRIUS tuner)

The song title and artist name of up to 10 tracks can be stored. Old tracks will be overwritten when saving more than 10 tracks.

- You cannot store the song title or the artist name when "-----" is displayed for the title information.

- You cannot store song titles or artist names from channel 000.

- Stored titles may not be displayed correctly.

## Using the MyMix function

The MyMix function allows you to make a MyMix song playlist. When a song in the MyMix playlist is being broadcast on a station other than the one you are listening to, you will be alerted, and you can tune in to the other station to listen to that song.

- This function is available for GEX-P920XM.
- The track itself is NOT downloaded. Only the song title and artist name are stored.

## Making the MyMix playlist

You can add a song that is being broadcast to the MyMix playlist. When it is added, the song title and its artist name are stored to this unit. The MyMix function will start when you listen

## When a song in the MyMix playlist is broadcast

(XM tuner)

As soon as a song in the MyMix playlist starts being broadcast on a different station, a message is displayed. Touch **Yes** to switch to that station, and you can listen to that song.

(SIRIUS tuner)

As soon as a stored song starts being broadcast on a different station, a song alert is displayed.

Switching to the other station to listen to that track.

Not tuning in to the other station.

## Detailed instructions

- (XM tuner)  
If you would rather not to tune in to the other station, touch **No**.
- If an alert for a song in the MyMix playlist is set to off, no alert will be provided even when the song is broadcast. Refer to *Setting up a song alert* on this page.
- If the stored title and the title of the song being broadcast differ, no alert will be provided even if they are the same song.

### Turning the MyMix function on or off.

You can turn the MyMix function off and stop the alerts for all the songs in the MyMix playlist. To restart, turn this function on.

The MyMix function is on as the default setting.

#### ● Turn the MyMix function on or off.

Refer to *Introduction of XM/SIRIUS tuner operations* on page 26.

### Setting up a song alert

You can set up an alert (on or off) for each song in the MyMix playlist. First, display the MyMix playlist and then change each alert setting. Set the alert to on to receive an alert when the song is broadcast, or set it to off to stop the alert for that song.

#### 1 Switch to memo edit mode.

Refer to *Introduction of XM/SIRIUS tuner operations* on page 26.

The MyMix playlist is displayed.

#### 2 Select the song title for which you want to turn the alert on or off.

(XM tuner)

The check mark is removed, and the alert for that song is off.

(SIRIUS tuner)

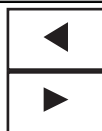

Selecting the song title for which you want to turn the alert off.

#### 3 Turn the alert on or off.

(SIRIUS tuner)



Turning the alert on or off.

### Deleting a song from the MyMix playlist for XM tuner

You can delete each song in the MyMix playlist.

#### 1 Switch to memo edit mode.

Refer to *Introduction of XM/SIRIUS tuner operations* on page 26.

The MyMix playlist is displayed.

#### 2 Delete the song title.



Deleting the song title.



Deleting all the songs in the MyMix playlist.

That song will be deleted from the MyMix playlist.

#### 3 A message to confirm deletion will appear. Touch Yes.

- To cancel deletion, touch **No**.

### Deleting a song from the MyMix playlist for SIRIUS tuner

You can delete each song in the MyMix playlist.

#### 1 Switch to memo edit mode.

Refer to *Introduction of XM/SIRIUS tuner operations* on page 26.

## Detailed instructions

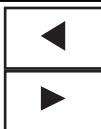
**2 Select the song title that you want to delete.**

Selecting the song title that you want to delete.

**3 Delete the song title.**

Deleting the song title.

**4 A message to confirm deletion will appear. Touch Yes.**

That song will be deleted from the MyMix playlist.

- To cancel deletion, touch **No**. 

**Using the Game Alert function**

This system can alert you when games involving your favorite teams are about to start. To use this function you need to set up a game alert for the teams in advance.

- This function is available for SIR-PNR2/SIR-PNR2C.

**Selecting teams for Game Alert****1 Start Game Alert setup.**

Refer to *Introduction of XM/SIRIUS tuner operations* on page 26.

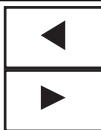
**2 Select a desired league in League**

Switching the league name.

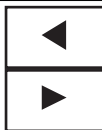
**3 Select a desired team in Team.**

Switching the team name.

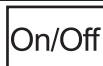
**4 Turn the alert on or off.**

Turning the alert on or off.

The game alert function is activated for that team.

- When you have already selected 12 teams, **FULL** is displayed and additional teams cannot be selected. In this case, first delete a selected team and then try again.

**5 Repeat these steps to select other teams.**

Up to 12 teams can be selected.

**Switching the Game Alert on or off**

Once you select the teams, you need to turn the Game Alert function on.

The Game Alert function is on at the default setting.

**When a game of a selected team starts**

When a game of the selected team is about to start (or is currently playing) on a different station, a game alert is displayed.

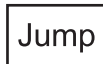

Switching to the other station to listen to the game.



Not tuning in to the other station.

## Detailed instructions

### Displaying game information

If any games of the selected teams are currently playing, you can display information on the games and tune in to the broadcast channel.

#### 1 Display the game information for the selected team.

Refer to *Introduction of XM/SIRIUS tuner operations* on page 26.

#### 2 Touch ◀ or ▶ (TRACK/SEEK) to select a game.

The game is displayed, followed by more detailed game information.

- The game score will be updated automatically.

#### 3 Switch to the other station to listen to the game.



Switching to the other station to listen to the game.

- If you have not selected any teams, **NOT SET** is displayed.
- When games involving your favorite teams are not currently playing, **NO GAME** is displayed. 

### Displaying the Radio ID Channel number selection setting

If you select **CH000**, the ID code is displayed.

#### ● Select CH000.

Refer to *Introduction of XM/SIRIUS tuner operations* on page 26. 

### Switching the SIRIUS display

- Actions will differ depending on the connected SIRIUS tuner.

#### ● Touch SIRIUS information to switch the SIRIUS display.

Refer to *Introduction of XM/SIRIUS tuner operations* on page 26.

Channel number—Channel name—Category name—Artist name—Song title/Title name—Composer name—Play time

#### Note

Play time is displayed during the Instant Replay mode. 

### Using the Instant Replay function

The following functions can be operated in Instant Replay mode.

- To use this function, a Pioneer SIRIUS bus interface (e.g. CD-SB10) is required.
- To use this function, a SIRIUS plug-and-play unit with an Instant Replay Function is required.
- For details, refer to the SIRIUS plug-and-play unit's manuals.

#### ● To exit from Instant Replay mode, select another source or touch the following icon.



Exiting from Instant Replay mode.

#### ● Select a track

Press ◀ or ▶ (TRACK/SEEK).

#### ● Fast forward or reverse

Press and hold ◀ or ▶ (TRACK/SEEK).

#### ● Pause and play



Playing and pausing.



## Switching the seek mode

There are two seek tuning settings, one is **Seek HD** (Digital broadcasting stations seek) and the other is **Seek All** (normal seek).

**Seek All—Seek HD** 

## Switching the reception mode

If the reception for a digital broadcast becomes poor, this unit automatically switches to the analog broadcast of the same frequency. If this function is set to **D/A Auto**, the tuner switches between digital broadcast and analog broadcast automatically. If this function is set to **Analog**, the tuner will only receive analog broadcasts.

**D/A Auto—Analog**



### Note

If **SEEK MODE** is set to **Seek HD** and **BLENDING** is set to **Analog**, the tuner cannot receive broadcasts. In this case, the seek mode or reception mode is changed automatically as follows:

- When **SEEK MODE** is set to **Seek HD**, if you switch **BLENDING** from **D/A Auto** to **Analog**, **SEEK MODE** is changed to **Seek All**.
- When **BLENDING** is set to **Analog**, if you switch **SEEK MODE** from **Seek All** to **Seek HD**, **BLENDING** is changed to **D/A Auto**. 

## Calling a number in the phone book

(Function of AVH-P3200BT)

The phone book in your cellular phone will be transferred automatically when the phone is connected to this unit.

After finding the number you want to call in the phone book, you can select the entry and make the call.

### 1 Switch to phone book mode.

Refer to *Introduction of Bluetooth telephone operations* on page 24.

The phone book display appears.

### 2 Select the phone number list.

The detailed phone number list of the selected entry is displayed.

### 3 Select the phone number.

- If you want to store the phone number, touch and hold the list.

### 4 Make the call.

Refer to *Introduction of Bluetooth telephone operations* on page 24.

### 5 End the call.

Refer to *Introduction of Bluetooth telephone operations* on page 24.



### Note

Depending on the cellular phone, the phone book may not be transferred automatically. In this case, operate your cellular phone to transfer the phone book. The visibility of this unit should be on. Refer to *Switching visible unit* on page 51. 

## Selecting a number by alphabet search mode

(Function of AVH-P3200BT)

If a lot of numbers are registered in the phone book, you can search for the phone number by alphabet search mode.

### 1 Switch to phone book mode.

Refer to *Introduction of Bluetooth telephone operations* on page 24.

The phone book display appears.

### 2 Touch ABC to switch to alphabet search mode.

## Detailed instructions

### 3 Touch the first letter of the entry you are looking for.

The Phone Book entries starting with that letter (e.g. "Ben", "Brian" and "Burt" when "B" is selected) will be displayed.

- If you want to change the character to Russian, touch the icon. To return to English, touch the icon again.



Changing the character to Russian.

- The order of the first name and last name may be different from that of the cellular phone.

### 4 Touch the list to display the phone number list of the selected entry.

- If several phone numbers are included in an entry, select one by touching the list.
- If you want to switch to the call history list, touch the icon.



Switching to the call history list.

### 5 Make the call.

Refer to *Introduction of Bluetooth telephone operations* on page 24.

### 6 End the call.

Refer to *Introduction of Bluetooth telephone operations* on page 24. 

## Using the missed, received and dialed call lists

(Function of AVH-P3200BT)

The 80 most recent calls dialed, received, and missed are stored in the memory. You can browse them and call numbers from these lists.

### 1 Switch to the call history list.

Refer to *Introduction of Bluetooth telephone operations* on page 24.

### 2 Select Missed Calls, Dialed Calls or Received Calls.



Displaying the received call list.



Displaying the dialed call list.



Displaying the missed call list.

### 3 Touch the list number to select a phone number.

Name and phone number are displayed in the detailed list.

- If you want to store the phone number, touch and hold the list.

### 4 Make the call.

Refer to *Introduction of Bluetooth telephone operations* on page 24.

### 5 End the call.

Refer to *Introduction of Bluetooth telephone operations* on page 24. 

## Using the missed, received and dialed call lists

(Function of AVH-P4200DVD/AVH-P3200DVD)

The 80 most recent calls dialed, received, and missed are stored in the memory. You can browse them and call numbers from these lists.

### 1 Switch to the call history list.

Refer to *Introduction of Bluetooth telephone operations* on page 29.

### 2 Touch a phone number or name (if entered) you want to call.

### 3 Make the call.

Refer to *Introduction of Bluetooth telephone operations* on page 29.

#### 4 End the call.

Refer to *Introduction of Bluetooth telephone operations* on page 29. 

### Setting automatic answering

If this function is on, this unit automatically answers all incoming calls.

#### ● Turn automatic answering on or off.

(AVH-P4200DVD/AVH-P3200DVD)

Refer to *Introduction of Bluetooth telephone operations* on page 29.

(AVH-P3200BT)

Refer to *Introduction of Bluetooth telephone operations* on page 24. 

### Adjusting the other party's listening volume

(Function of AVH-P3200BT)

To maintain the good sound quality, this unit can adjust the other party's listening volume. If the volume is not loud enough for the other party, use this function.

#### ● Select Far-End VOL.

Refer to *Introduction of Bluetooth telephone operations* on page 24.

#### 1—2—3

- This function can be performed even while talking on the phone.
- Settings can be stored for each device. 

### Switching the ring tone

You can select whether or not to use this unit's ring tone. If this function is set to on, the ring tone for this unit will sound.

#### 1 Connect your cellular phone to this unit.

#### 2 Turn ring tone on or off.

(AVH-P4200DVD/AVH-P3200DVD)

Refer to *Introduction of Bluetooth telephone operations* on page 29.

(AVH-P3200BT)

Refer to *Introduction of Bluetooth telephone operations* on page 24. 

### Using the preset dial lists

(Function of AVH-P3200BT)

You can easily store up to six phone numbers as presets.

#### 1 Display the preset screen.

Refer to *Introduction of Bluetooth telephone operations* on page 24.

#### 2 Touch one of preset dial keys to select the desired phone number.

- If you want to delete a preset phone number, touch and hold the preset dial key.

#### 3 Make the call.

Refer to *Introduction of Bluetooth telephone operations* on page 24.

#### 4 End the call.

Refer to *Introduction of Bluetooth telephone operations* on page 24. 

### Making a call by entering phone number

(Function of AVH-P3200BT)

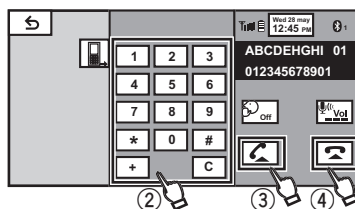



## Detailed instructions

### Important

Be sure to park your vehicle in a safe place and apply the parking brake when performing this operation.

#### 1 Switch to the entering phone number mode.

Refer to *Introduction of Bluetooth telephone operations* on page 24.

#### 2 Touch the number icons to input the numbers.

- Up to 24 digits can be entered.

#### 3 Make the call.

Refer to *Introduction of Bluetooth telephone operations* on page 24.

#### 4 End the call.

Refer to *Introduction of Bluetooth telephone operations* on page 24.

### Note

Entering phone number mode cannot be operated unless a Bluetooth telephone is connected to this unit. 

## Setting the private mode

(Function of AVH-P3200BT)

During a conversation, you can switch to private mode (talk directly on your cellular phone).

Refer to *Introduction of Bluetooth telephone operations* on page 24. 

## Pairing from this unit

(Function of AVH-P3200BT)

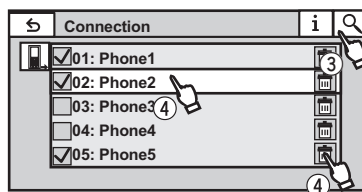

#### 1 Display the Bluetooth Connection Menu.

Refer to *Introduction of Bluetooth telephone operations* on page 24.

#### 2 Touch Connection to select a device.

#### 3 Start to search.



Starting to search.

While searching,  is displayed and when available devices are found, the device names or BD addresses (if names cannot be obtained) are displayed.

- If you want to switch between the device names and BD addresses, touch the icon.



Switching between the device names and BD addresses.

- To cancel searching, touch **Stop**.
- If five devices are already paired, **Memory Full** is displayed and pairing cannot be performed. In such cases, delete a paired device first. Refer to *Deleting a paired device*. on the next page.
- If no device can be found, **Not Found** is displayed. In such cases, check the status of the Bluetooth device and search again.

#### 4 Touch a device name to select the device you want to connect to.

While connecting, **Pairing** is displayed. If the connection is established, **Paired** is displayed.

## Detailed instructions

- If the connection fails, **Error** is displayed. In such cases, try again from the beginning.
- The PIN code is set to **0000** as the default, but can be changed. Refer to *Entering PIN code for Bluetooth wireless connection* on the next page.
- When establishing connection, the icon is displayed. Touch the icon to disconnect the device.



Disconnecting a Bluetooth device.

- If you want to delete a paired Bluetooth telephone, display **Delete OK?**. Touch **Yes** to delete the device.



Deleting a paired device.

- Never turn the unit off while the paired Bluetooth telephone is being deleted.

## Using a Bluetooth device to pair

(Function of AVH-P3200BT)

If you cannot open the connection between your Bluetooth device and this unit from your Bluetooth device, you can use this function to establish a connection.

### 1 Display the Bluetooth Connection Menu.

Refer to *Introduction of Bluetooth telephone operations* on page 24.

### 2 Touch Special Device to select the special device.

- Bluetooth devices that are difficult to establish a connection with are called special devices. If your Bluetooth device is listed as a special device, select the appropriate one.

### 3 Touch the special device list to open the connection.

This unit is now on standby for a connection with the Bluetooth device.

- If five devices are already paired, **Memory Full** is displayed and pairing cannot be performed. In such cases, delete a paired device first. Refer to *Deleting a paired device.* on this page.

### 4 Use your Bluetooth device to establish a connection.

The connection method is different depending on the Bluetooth device. Refer to the manual for your Bluetooth device to establish a connection.

While connecting, **Pair your phone** is displayed. If the connection is established, **Paired** is displayed.

- If the connection fails, **Error** is displayed. In such cases, try again from the beginning.
- The PIN code is set to **0000** as the default, but can be changed. Refer to *Entering PIN code for Bluetooth wireless connection* on the next page.

## Connecting to a Bluetooth device automatically

(Function of AVH-P3200BT)

If this function is set to on, a connection between your Bluetooth device and this unit will take place automatically as soon as the two devices are less than a few meters apart. Initially, this function is set to on.

### 1 Display the Bluetooth Connection Menu.

Refer to *Introduction of Bluetooth telephone operations* on page 24.

### 2 Touch Auto Connect to turn automatic connection on.

If your Bluetooth device is ready for a Bluetooth wireless connection, a connection to this unit will automatically be established.

## Detailed instructions

- To turn automatic connection off, touch **Auto Connect** again.

### 3 Turn your vehicle's ACC switch off and on.

## Switching visible unit

(Function of AVH-P3200BT)

This function sets whether or not to make this unit visible to the other device.

Initially, this function is set to on.

### 1 Display the Bluetooth Connection Menu.

Refer to *Introduction of Bluetooth telephone operations* on page 24.

### 2 Touch Visibility to select visibility off.

- To turn visibility on, touch **Visibility** again. 

## Displaying BD (Bluetooth Device) address

(Function of AVH-P3200BT)

This unit displays its BD address.

### 1 Display the Bluetooth Connection Menu.

Refer to *Introduction of Bluetooth telephone operations* on page 24.

### 2 Touch Bluetooth Version to select device information.

The BD address is displayed. 

## Entering PIN code for Bluetooth wireless connection

(Function of AVH-P3200BT)

To connect your Bluetooth device to this unit via Bluetooth wireless technology, you need to enter a PIN code on your Bluetooth device to

verify the connection. The default code is **0000**, but you can change it with this function.

### 1 Display the Bluetooth Connection Menu.

Refer to *Introduction of Bluetooth telephone operations* on page 24.

### 2 Touch PIN Code Input to select PIN code input.

### 3 Touch 1 to 0 to input pin code.

### 4 After inputting PIN code (up to 8 digits), store in this unit.



Storing the PIN code in this unit.



## Using a cellular phone to initiate a connection

(AVH-P4200DVD/AVH-P3200DVD)

A Bluetooth wireless connection can be established from your phone by putting the unit into initiating a connection mode.

You may need to refer to the operation manual that came with your phone if you are unsure how to initiate a connection from your phone.

### 1 Put the unit in initiating a connection mode.

Refer to *Introduction of Bluetooth telephone operations* on page 29.

### 2 Use a cellular phone to connect to this unit.

- Operation varies depending on the type of cellular phone.
- You may need to enter the link code on your cellular phone to complete the connection. 

## Registering a connected cellular phone

(Function of AVH-P4200DVD/AVH-P3200DVD)  
You can register a phone that is temporarily connected to this unit in order to take full advantage of the features available with Bluetooth wireless technology. Only one cellular phone can be registered.

### 1 Start registering a connected cellular phone.

Refer to *Introduction of Bluetooth telephone operations* on page 29.

### 2 Use cellular phone to register to this unit.

If registration is successful, the device name of the connected phone is displayed in the selected assignment.

- If the assignment is already taken, the device name will be displayed. To replace an assignment with a new phone, first delete the current assignment.
- If registration failed, the device name of the connected phone will not be displayed in the selected assignment. In such cases, return to step 1 and try again.

## Voice recognition

(Function of AVH-P4200DVD/AVH-P3200DVD)  
If your cellular phone features voice recognition technology, you can make a call by voice commands.

- Operation varies depending on the type of cellular phone. Refer to the instruction manual that came with your cellular phone for detailed instructions.

### 1 Start voice recognition.

Refer to *Introduction of Bluetooth telephone operations* on page 29.

### 2 Say the name of your contact aloud.

## Connecting a Bluetooth audio player

(Function of AVH-P4200DVD/AVH-P3200DVD)  
A Bluetooth wireless connection can be established by putting the unit into initiating a connection mode.

### ● Put the unit in initiating a connection mode.

Refer to *Bluetooth audio operations* on page 30.

This unit is now on standby for connection from Bluetooth audio player.

If your Bluetooth audio player is set ready for Bluetooth wireless connection, connection to this unit is automatically established.

## Connecting to a Bluetooth device automatically

(Function of AVH-P4200DVD/AVH-P3200DVD)  
If this function is set to on, a connection between your Bluetooth device and this unit will take place automatically as soon as the two devices are less than a few meters apart. Initially, this function is set to on.

### 1 Touch Auto Connect to turn automatic connection on.

Refer to *Introduction of Bluetooth telephone operations* on page 29.

If your Bluetooth device is ready for a Bluetooth wireless connection, a connection to this unit will automatically be established.

- To turn automatic connection off, touch **Auto Connect** again.

### 2 Turn your vehicle's ACC switch off and on.

## Displaying BD (Bluetooth Device) address

(Function of AVH-P4200DVD/AVH-P3200DVD)  
This unit displays its BD address.

## Detailed instructions

- **Touch Bluetooth Version to select device information.**

Refer to *Introduction of Bluetooth telephone operations* on page 29.

The BD address is displayed.

## Introduction of menu operations

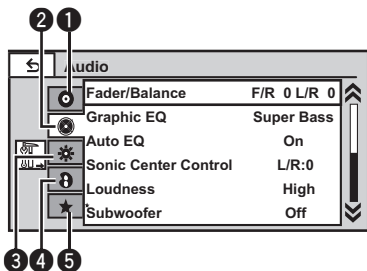

- You cannot display the Audio/DSP function menu when the mute function is on or a JPEG file is playing.

### 1 Display menus.

Refer to *Common operations for menu settings/lists* on page 13.

### 2 Touch any of the following touch panel keys to select the menu to be adjusted.

- ① Touch panel keys

①		Video Setup Menu Refer to <i>Setting up the DVD player</i> on page 58.
②		Audio function menu Refer to <i>Audio Adjustments</i> on the next page.
③		System menu Refer to <i>System settings</i> on page 62.
④		Entertainment menu Refer to <i>Entertainment settings</i> on page 67.
⑤		Custom menu You can choose menus within each menu (Audio function menu, etc.) and register them to this custom menu. Refer to <i>Customizing menus</i> on page 68.

### Notes

- You can display the **Video Setup Menu** when a **Disc**, **USB** or **SD** source is selected.
- If you start the **Video Setup Menu**, playback is stopped.

# Menu operations

## Audio Adjustments



### Note

When selecting FM as the source, you cannot switch to **Source Level Adjuster**.

## Using fader/balance adjustment

You can change the fader/balance setting to provide an ideal listening environment for all of the occupied seats.

### 1 Display the audio function menu.

Refer to *Introduction of menu operations* on the previous page.

### 2 Touch Fader/Balance on the audio function menu.

### 3 Touch ▲ or ▼ to adjust the front/rear speaker balance.

Range: **Front:15 to Rear:15**

- Select **F/R: 0 L/R: 0** when only using two speakers.
- The front/rear speaker balance cannot be adjusted when the rear output setting is **Subwoofer**. Refer to *Setting the rear output and subwoofer controller* on page 62.

### 4 Touch ◀ or ▶ to adjust the left/right speaker balance.

Range: **Left:15 to Right:15**

## Using the equalizer

You can adjust the equalization to match the car's interior acoustic characteristics as desired.

## Recalling equalizer curves

There are seven stored equalizer curves which you can easily recall at any time. Here is a list of the equalizer curves.

Display	Equalizer curve
Powerful	Powerful
Natural	Natural

Display	Equalizer curve
Vocal	Vocal
Custom1	Custom 1
Custom2	Custom 2
Flat	Flat
Super Bass	Super bass

- The equalizer curves for **Custom1** and **Custom2** can be adjusted.
- You cannot select **Custom1** and **Custom2** when using the auto-equalizer.
- When **Flat**, no changes are made to the sound. You can check the effects of the equalizer curves by switching alternatively between **Flat** and another equalizer curve.

### 1 Display the audio function menu.

Refer to *Introduction of menu operations* on the previous page.

### 2 Touch Graphic EQ on the audio function menu.

- You can select **Graphic EQ** when **Auto EQ** function is off.

### 3 Touch ◀ or ▶ to select the desired item. **Powerful—Natural—Vocal—Custom1—Custom2—Flat—Super Bass**

## Adjusting the 8-band graphic equalizer

You can adjust the level of each band for the equalizer curves.

- A separate **Custom1** curve can be created for each source. If you make adjustments when a curve other than **Custom2** is selected, the equalizer curve settings will be stored in **Custom1**.
- A **Custom2** curve that is common for all sources can be created. If you make adjustments when the **Custom2** curve is selected, the **Custom2** curve will be updated.

### 1 Display the audio function menu.

Refer to *Introduction of menu operations* on the previous page.

## Menu operations

**2 Touch Graphic EQ on the audio function menu.**

**3 Touch ◀ or ▶ to select the desired item. Powerful—Natural—Vocal—Custom1—Custom2—Flat—Super Bass**

**4 Touch the Equalizer band to adjust.**

**5 Touch ▲ or ▼ to adjust the level of the equalizer band.**

Range: **+12dB** to **-12dB**

- You can then select another band and adjust the level.

### Using the auto-equalizer

The auto-equalizer is an equalizer curve created by auto EQ (refer to *Auto EQ (auto-equalizing)* on page 64).

You can turn the auto-equalizer on or off.

If you connect an optional microphone to this unit, you can use this function.

**1 Display the audio function menu.**

Refer to *Introduction of menu operations* on page 54.

**2 Touch Auto EQ to turn the auto-equalizer on or off.**

- You cannot use this function if auto EQ has not been carried out.

### Using sonic center control

Sound that is suited for the listening position can easily be created with this function.

**1 Display the audio function menu.**

Refer to *Introduction of menu operations* on page 54.

**2 Touch Sonic Center Control on the audio function menu.**

**3 Touch ◀ or ▶ to select a listening position.**

Range: **Left:7** to **Right:7**

### Adjusting loudness

Loudness compensates for deficiencies in the low- and high-frequency ranges at low volume.

**1 Display the audio function menu.**

Refer to *Introduction of menu operations* on page 54.

**2 Touch Loudness on the audio function menu.**

**3 Touch ◀ or ▶ to select a desired level.**

**Off** (off)—**Low** (low)—**Mid** (mid)—**High** (high)

### Using subwoofer output

This unit is equipped with a subwoofer output which can be turned on or off.

- The cut-off frequency and output level can be adjusted when the subwoofer output is on.

**1 Display the audio function menu.**

Refer to *Introduction of menu operations* on page 54.

**2 Touch Subwoofer on the audio function menu.**

**3 Touch On or Off next to Subwoofer to turn the subwoofer output on or off.**

**4 Touch Normal or Reverse next to Phase to select the phase of subwoofer output.**

**5 Touch ◀ or ▶ next to Level to adjust the output level of the subwoofer.**

Range: **+6** to **-24**

**6 Touch ◀ or ▶ next to Frequency to select the cut-off frequency.**

**50Hz—63Hz—80Hz—100Hz—125Hz**

Only frequencies lower than those in the selected range are outputted from the subwoofer.



## Menu operations

### Boosting the bass

You can boost the bass level.

#### 1 Display the audio function menu.

Refer to *Introduction of menu operations* on page 54.

#### 2 Touch Bass Booster on the audio function menu.

3 Touch ◀ or ▶ to select a desired level.  
Range: 0 to +6

### Using the high pass filter

When you do not want low sounds from the subwoofer output frequency range to play from the front or rear speakers, turn on the HPF (high pass filter). Only frequencies higher than those in the selected range are output from the front or rear speakers.

#### 1 Display the audio function menu.

Refer to *Introduction of menu operations* on page 54.

#### 2 Touch High Pass Filter on the audio function menu.

3 Touch ◀ or ▶ next to Frequency to select cut-off frequency.

Off (off)—50Hz—63Hz—80Hz—100Hz—125Hz

Only frequencies higher than those in the selected range are output from the front or rear speakers.

### Adjusting source levels

With SLA (source level adjustment), the volume levels of each source can be adjusted to prevent significant differences between sources.

- Settings are based on the FM volume level, which remains unchanged.

#### 1 Display the audio function menu.

Refer to *Introduction of menu operations* on page 54.

#### 2 Compare the FM volume level with the level of the source you wish to adjust.

#### 3 Touch Source Level Adjuster on the audio function menu.

#### 4 Touch ▲ or ▼ to adjust the source volume.

Range: +4 to -4



#### Notes

- The AM volume level can also be adjusted with this function.
- Video CD, CD, compressed audio and DivX are automatically set to the same source level adjustment volume.
- iPod and USB storage device are automatically set to the same source level adjustment volume.
- External unit 1 and external unit 2 are automatically set to the same source level adjustment volume.

## Setting up the DVD player

### Setting the subtitle language

You can set a desired subtitle language. When available, the subtitles will be displayed in the selected language.

#### 1 Display the Video Setup Menu.

Refer to *Introduction of menu operations* on page 54.

#### 2 Touch Subtitle Language on the Video Setup menu.

A subtitle language menu is displayed.

#### 3 Touch the desired language.

The subtitle language is set.

- If you have selected **Others**, refer to *When you select Others* on this page.



#### Notes

- If the selected language is not available, the language specified on the disc is displayed.
- You can also switch the subtitle language by touching the icon during playback. (Refer to *Playing moving images* on page 16.)
- The setting made here will not be affected even if the subtitle language is switched during playback using **Subtitle**.

### When you select Others

A language code input display is shown when **Others** is selected. Refer to *Language code chart for DVD* on page 89.

#### 1 Touch 0 to 9 to input the language code.

- To cancel the entered numbers, touch **C**.

#### 2 Registering the code.



Registering the code.

## Setting the audio language

You can set the preferred audio language.

#### 1 Display the Video Setup Menu.

Refer to *Introduction of menu operations* on page 54.

#### 2 Touch Audio Language on the Video Setup menu.

An audio language menu is displayed.

#### 3 Touch the desired language.

The audio language is set.

- If you have selected **Others**, refer to *When you select Others* on this page.



#### Notes

- If the selected language is not available, the language specified on the disc is used.
- You can also switch the audio language by touching **Audio** during playback. (Refer to *Playing moving images* on page 16.)
- The setting made here will not be affected even if the audio language is switched during playback using **Audio**.

## Setting the menu language

You can set the preferred language in which the menus recorded on a disc are displayed.

#### 1 Display the Video Setup Menu.

Refer to *Introduction of menu operations* on page 54.

#### 2 Touch Menu Language on the Video Setup menu.

A menu language menu is displayed.

#### 3 Touch the desired language.

The menu language is set.

- If you have selected **Others**, refer to *When you select Others* on this page.



#### Note

If the selected language is not available, the language specified on the disc is displayed.

## Menu operations

### Setting the multi-angle DVD display

The angle icon can be set so it appears on scenes where the angle can be switched.

#### 1 Display the Video Setup Menu.

Refer to *Introduction of menu operations* on page 54.

#### 2 Touch Multi Angle on the Video Setup menu to turn angle icon display on or off.

### Setting the aspect ratio

There are two kinds of display: a wide screen display that has a width-to-height ratio (TV aspect ratio) of 16:9, and regular display that has a TV aspect of 4:3. Be sure to select the correct TV aspect for the display connected to **V OUT**.

- When using regular display, select either **Letter Box** or **Pan Scan**. Selecting **16:9** may result in an unnatural picture.
- If you select the TV aspect ratio, the unit's display will change to the same setting.

#### 1 Display the Video Setup Menu.

Refer to *Introduction of menu operations* on page 54.

#### 2 Touch TV Aspect on the Video Setup menu to select the TV aspect ratio.

Touch **TV Aspect** repeatedly until the desired aspect ratio appears.

- **16:9** – Wide screen picture (16:9) is displayed as is (initial setting)
- **Letter Box** – The picture is the shape of a letterbox with black bands on the top and bottom of the screen
- **Pan Scan** – The picture is cut short on the right and left sides of the screen



#### Notes

- When playing discs that do not specify **Pan Scan**, the disc is played back in **Letter Box** display even if you select the **Pan Scan** setting. Confirm whether the disc package bears the **16:9 LB** mark.

- The TV aspect ratio cannot be changed for some discs. For details, refer to the disc's instructions.

### Setting the slide show interval

JPEG files can be viewed as a slide show on this unit. In this setting, the interval between each image can be set.

#### 1 Display the Video Setup Menu.

Refer to *Introduction of menu operations* on page 54.

#### 2 Touch Time Per Photo Slide on the Video Setup menu to select the slide show interval.

Touch **Time Per Photo Slide** repeatedly until the desired setting appears.

- **5sec** – JPEG images switch at intervals of 5 seconds
- **10sec** – JPEG images switch at intervals of 10 seconds
- **15sec** – JPEG images switch at intervals of 15 seconds
- **Manual** – JPEG images can be switched manually

### Setting parental lock

Some DVD video discs let you use parental lock to restrict children from viewing violent and adult-oriented scenes. You can set parental lock to the desired level.

- When you have a parental lock level set and play a disc featuring parental lock, code number input indications may be displayed. In such cases, playback will begin when the correct code number is entered.

### Setting the code number and level

A code number must be registered in order to play back discs with parental lock.

#### 1 Display the Video Setup Menu.

Refer to *Introduction of menu operations* on page 54.

## Menu operations

**2 Touch Parental on the Video Setup menu.**

**3 Touch 0 to 9 to input a four digit code number.**

- To cancel the entered numbers, touch **C**.

**4 Registering the code.**



Registering the code.

The code number is set, and the level can now be set.

**5 Touch 1 to 8 to select the desired level.**

**6 Touch Enter.**

The parental lock level is set.

- **8** – Playback of the entire disc is possible (initial setting)
- **7 to 2** – Playback of discs for children and non-adult-oriented discs is possible
- **1** – Playback of discs for children only is possible



### Notes

- We recommend to keep a record of your code number in case you forget it.
- The parental lock level is stored on the disc. Look for the level indication written on the disc package, included literature or on the disc itself. Parental lock of this unit is not possible if a parental lock level is not stored on the disc.
- With some discs, the parental lock may be active only for certain levels of scenes. The playback of those scenes will be skipped. For details, refer to the instruction manual that came with the disc.

## Changing the level

You can change the set parental lock level.

**1 Display the Video Setup Menu.**

Refer to *Introduction of menu operations* on page 54.

**2 Touch Parental on the Video Setup menu.**

**3 Touch 0 to 9 to input the registered code number.**

**4 Registering the code.**



Registering the code.

This sets the code number, and the level can now be changed.

- If you enter an incorrect code number, the  icon is displayed. Touch **C** and enter the correct code number.
- If you forget your code number, refer to *If you forget your code number* on this page.

**5 Touch 1 to 8 to select the desired level.**

**6 Touch Enter.**

The new parental lock level is set.

## If you forget your code number

Press **RESET**.

## Setting the DivX subtitle file

You can select whether or not to display DivX external subtitles.

- The DivX subtitles will be displayed even when **Custom** is selected if no DivX external subtitle files exist.

**1 Display the Video Setup Menu.**

Refer to *Introduction of menu operations* on page 54.

**2 Touch DivX Subtitle on the Video Setup menu to select the desired subtitle setting.**

- **Original** – Display the DivX subtitles
- **Custom** – Display the DivX external subtitles

## Menu operations



### Notes

- Up to 42 characters can be displayed on one line. If more than 42 characters are set, the line breaks and the characters are displayed on the next line.
- Up to 126 characters can be displayed on one screen. If more than 126 characters are set, the excess characters will not be displayed.

## Displaying the DivX® VOD registration code

In order to play DivX VOD (video on demand) content on this unit, the unit must first be registered with a DivX VOD content provider. For registration, generate a DivX VOD registration code and submit it to your provider.

- Keep a record of the code as you will need it when you register your unit to the DivX VOD provider.

### 1 Display the Video Setup Menu.

Refer to *Introduction of menu operations* on page 54.

### 2 Touch DivX VOD on the Video Setup menu.

**Registration Code** and **Deactivation Code** appear.

### 3 Touch Registration Code.

Your registration code is displayed.

## Displaying the deactivation code

If your device is already activated, deactivate it by entering the deactivation code.

### 1 Display the Video Setup Menu.

Refer to *Introduction of menu operations* on page 54.

### 2 Touch DivX VOD on the Video Setup menu.

### 3 Touch Deactivation Code.

- To cancel deactivation, touch **Cancel**.

### 4 Touch OK.

The deactivation completed.

## Automatic playback of DVDs

When a DVD disc with a DVD menu is inserted, this unit will cancel the menu automatically and start playback from the first chapter of the first title.

- Some DVDs may not operate properly. If this function is not fully operated, turn this function off and start playback.

### 1 Display the Video Setup Menu.

Refer to *Introduction of menu operations* on page 54.

### 2 Touch DVD Auto Play to turn automatic playback on.

- To turn automatic playback off, touch **DVD Auto Play** again. 

## System settings

### Switching the auxiliary setting

Activate this setting when using an auxiliary device connected to this unit.

#### 1 Display the system menu.

Refer to *Introduction of menu operations* on page 54.

#### 2 Touch AUX Input on the system menu to turn AUX Input on or off.

### Setting AV input

Activate this setting when using an external video component connected to this unit.

#### 1 Display the system menu.

Refer to *Introduction of menu operations* on page 54.

#### 2 Touch AV Input on the system menu to turn AV Input on or off.

### Setting the rear output and subwoofer controller

This unit's rear output (rear speaker leads output and RCA rear output) can be used for full-range speaker (**Full**) or subwoofer (**Subwoofer**) connection. If you switch the rear output setting to **Subwoofer**, you can connect a rear speaker lead directly to a subwoofer without using an auxiliary amp. Initially, the unit is set for a rear full-range speaker connection (**Full**).

#### 1 Turn the unit off.

Refer to *Basic Operations* on page 11.

#### 2 Display the system menu.

Refer to *Introduction of menu operations* on page 54.

### 3 Touch Rear Speaker on the system menu to switch the subwoofer output or full-range speaker.

- When no subwoofer is connected to the rear output, select **Full** (full-range speaker).
- When a subwoofer is connected to the rear output, select **Subwoofer** (subwoofer).
- When the rear output setting is **Subwoofer**, you cannot operate the following procedure.



#### Notes

- Even if you change this setting, there is no output unless you turn the subwoofer output on (refer to *Using subwoofer output* on page 56).
- If you change this setting, subwoofer output in the audio menu will return to the factory settings.
- Both rear speaker lead outputs and RCA rear output are switched simultaneously in this setting.

### Switching sound muting/attenuation

Sound from this system is automatically muted or attenuated when a signal from equipment with a mute function is received.

- Sound from this system returns to normal when the muting or attenuation is canceled.

#### 1 Display the system menu.

Refer to *Introduction of menu operations* on page 54.

#### 2 Touch Mute/ATT until the desired setting appears.

Touch **Mute/ATT** until the desired setting appears in the display.

- **Mute** – Muting
- **ATT-20dB** – Attenuation (**ATT-20dB** has a stronger effect than **ATT-10dB**)
- **ATT-10dB** – Attenuation
- **Off** – Turns the sound muting/attenuation off

## Menu operations



### Notes

- When **Mute** is displayed, the sound is turned off and no audio adjustments can be made.
- When **ATT** is displayed, the sound is attenuated and only the volume can be adjusted. (No other audio adjustments can be made.)
- Operation returns to normal when the phone connection is ended.

## Changing languages for CAUTION

Some operations on this unit are prohibited while driving or needs to be paid a careful attention when operating. In such case, a caution appears on the display. You can change the language of the cautions at this setting.

### 1 Display the system menu.

Refer to *Introduction of menu operations* on page 54.

### 2 Touch Caution Language to select your desired language.

### 3 Touch any of the following touch panel keys to select the Caution Language.

- **English** — English
- **Español** — Spanish
- **Français** — French

## Selecting the menu language

The menu language can be selected from four languages.

If text information such as the title name, artist name or a comment is embedded in a European language or Russian, they can also be displayed on this unit.

- The language can be changed for the following:
  - System menu
  - Video Setup
  - On-screen display
  - Multi language setting for DivX
- If the embedded language and the selected language setting are not the same, text information may not be displayed properly.

- Some characters may not be displayed properly.

### 1 Display the system menu.

Refer to *Introduction of menu operations* on page 54.

### 2 Touch System Language on the system menu to select the desired language.

### 3 Touch the desired language.

**English** (English)—**Español** (Spanish)—**Português** (Portuguese)—**Русский** (Russian)

## Clearing Bluetooth memory

(AVH-P3200BT only)



### Important

Never turn the unit off while the Bluetooth memory is being cleared.

### 1 Turn the unit off.

Refer to *Basic Operations* on page 11.

### 2 Display the system menu.

Refer to *Introduction of menu operations* on page 54.

### 3 Touch Bluetooth Memory Clear on the system menu.

### 4 Touch Reset.

After selecting a desired item, a confirmation display appears. Touch **Reset** to delete the memory.

- If you do not want to clear the selected memory, touch **Cancel**.

## Updating Bluetooth connection software

(AVH-P3200BT only)

This function is used to update this unit with the latest software. For information on the software and updating, refer to our website.

**Important**

Never turn the unit off and never disconnect the phone while the software is being updated.

**1 Display the system menu.**

Refer to *Introduction of menu operations* on page 54.

**2 Touch Bluetooth Software Update.****3 Touch Start to display the data transfer mode.**

- Follow the on-screen instructions to finish updating the software.

**Displaying the Bluetooth system version**

(AVH-P3200BT only)

If this unit fails to operate properly, you may need to consult your dealer for repair. In such cases, you may be asked to specify the system version. Perform the following procedure to check the version on this unit.

**1 Turn the unit off.**

Refer to *Basic Operations* on page 11.

**2 Display the system menu.**

Refer to *Introduction of menu operations* on page 54.

**3 Touch Bluetooth Version Information to display to the version of the Bluetooth module of this unit.****Setting the rear view camera (back up camera)****CAUTION**

**Pioneer recommends the use of a camera which outputs mirror-reversed images.**

**Otherwise, the screen image will appear reversed.**

This unit features a function that automatically switches to the rear view camera video (**V IN**)

when a rear view camera is installed on your car and the gear shift is moved to the **REVERSE (R)** position. (For more details, consult your dealer.)

- After you set up the rear view camera setting, move the gear shift to **REVERSE (R)** and confirm that the rear view camera video is shown on the display.
- Change this setting if the display switches to the rear view camera video by error while you are driving forward.
- To stop watching the rear view camera video and return to the source display, press and hold **MUTE**.
- Touch the **RearView** source icon to display the rear view camera image while driving. Touch the source icon again to turn the rear view camera off. For details, refer to *Selecting a source using the touch panel keys* on page 11.

**1 Display the system menu.**

Refer to *Introduction of menu operations* on page 54.

**2 Touch Camera Polarity on the system menu to select the appropriate setting.**

- **Battery** – When the polarity of the connected lead is positive while the gear shift is in **REVERSE (R)** position
- **Ground** – When the polarity of the connected lead is negative while the gear shift is in **REVERSE (R)** position
- **Off** – When a rear view camera is not connected to this unit

**Auto EQ (auto-equalizing)**

The auto-equalizer automatically measures the car's interior acoustic characteristics, and then creates an auto-equalizer curve based on that information.



## Menu operations

### WARNING

As a loud tone (noise) may be emitted from the speakers when measuring the car's interior acoustic characteristics, never perform auto TA or auto EQ while driving.

### CAUTION

- Thoroughly check the conditions before performing auto EQ as the speakers may be damaged if these functions are performed when:
  - The speakers are incorrectly connected. (For example, when a rear speaker is connected as a subwoofer output.)
  - A speaker is connected to a power amp delivering output higher than the speaker's maximum input power capability.
- If the microphone is placed in an unsuitable position the measurement tone may become loud and measurement may take a long time, resulting in battery drainage. Be sure to place the microphone in the specified location.

### Before operating the auto EQ function

- Carry out auto EQ in as quiet a place as possible, with the car engine and air conditioning switched off. Also cut power to car phones or portable telephones in the car, or remove them from the car before carrying out auto EQ. Sounds other than the measurement tone (surrounding sounds, engine sound, telephones ringing etc.) may prevent correct measurement of the car interior acoustic characteristics.
- Be sure to carry out auto EQ using the optional microphone. Using another microphone may prevent measurement, or result in incorrect measurement of the car interior acoustic characteristics.
- In order to perform auto EQ, the front speaker must be connected.
- When this unit is connected to a power amp with input level control, auto EQ may not be possible if the power amp's input level is set below the standard level.

- When this unit is connected to a power amp with an LPF, turn this LPF off before performing auto EQ. Also set the cut-off frequency for the built-in LPF of an active subwoofer to the highest frequency.
- The distance has been calculated by computer to be the optimum delay to give accurate results for the circumstances, so please continue to use this value.
  - The reflected sound within the car is strong and delays occur.
  - The LPF on active subwoofers or external amps delay the lower sounds.
- Auto EQ changes the audio settings as follows:
  - The fader/balance settings return to the center position. (Refer to *Using fader/balance adjustment* on page 55.)
  - The equalizer curve switches to **Flat**. (Refer to page 55.)
  - The front, center and rear speakers will automatically be adjusted to a high pass filter setting.
- Previous settings for auto EQ will be overwritten.

### Performing auto EQ

#### 1 Stop the car in a place that is quiet, close all the doors, windows and sun roof, and then turn the engine off.

If the engine is left running, engine noise may prevent correct auto EQ.

#### 2 Fix the optional microphone in the center of the headrest of the driver's seat, facing forward.

The auto EQ may differ depending on where you place the microphone. If desired, place the microphone on the front passenger seat to carry out auto EQ.

## Menu operations

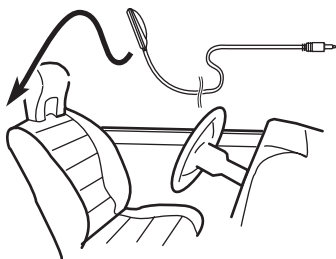

### 3 Turn the ignition switch to ON or ACC.

If the car's air conditioner or heater is turned on, turn it off. Noise from the fan in the air conditioner or heater may prevent correct auto EQ.

### 4 Display the system menu.

Refer to *Introduction of menu operations* on page 54.

### 5 Touch Auto EQ Measurement to enter auto EQ measurement mode.

### 6 Plug the microphone into the microphone input jack on this unit.

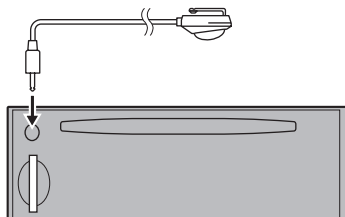

(AVH-P4200DVD)

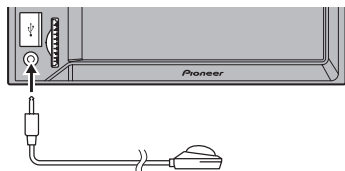

(AVH-P3200DVD/AVH-P3200BT)

### 7 Touch Start to start auto EQ.

### 8 When the 10-second countdown starts, get out of the car and close the door within 10 seconds.

A measurement tone (noise) is emitted from the speakers, and auto EQ measurement begins.

When auto EQ is completed, **Complete** is displayed.

When the car's interior acoustic characteristics cannot be measured correctly, an error message will be displayed. (Refer to *Understanding auto EQ error messages* on page 77.)

- It takes about nine minutes for auto EQ measurement to be completed when all the speakers are connected.
- To stop auto EQ, touch **Stop**.
- To cancel auto EQ measurement mode during this procedure, touch the following touch panel key.



Canceling auto EQ measurement mode.

### 9 Store the microphone carefully in the glove compartment or another safe place.

If the microphone is subjected to direct sunlight for an extended period, high temperatures may cause distortion, color change or malfunction.

### 10 Press ▲(eject) to close the panel. (AVH-P4200DVD only)



#### Note

(AVH-P4200DVD)

Do not press ▲ (eject) to open or close the panel when you are using the microphone. 

## Menu operations

### Entertainment settings

#### Selecting the illumination color

This unit is equipped with multiple-color illumination.

##### Direct selection from preset illumination colors

You can select an illumination color from the color list.

##### 1 Display the entertainment menu.

Refer to *Introduction of menu operations* on page 54.

##### 2 Touch Appearance.

##### 3 Touch Illumination and then touch a color on the list.

#### Customizing the illumination color

##### 1 Display the entertainment menu.

Refer to *Introduction of menu operations* on page 54.

##### 2 Touch Appearance.

##### 3 Touch Illumination and then touch Custom.

##### 4 Display the customizing menu.



Displaying the customizing menu.

##### 5 Touch the color bar to customize the color.

##### 6 Touch ◀ or ▶ to fine-tune the color.

##### 7 Touch the icon and hold to store the customized color in the memory.



Storing the customized color in the memory.

The customized color has been stored in the memory.

The set color will be recalled from the memory the next time you touch the same icon.

#### Selecting the OSD color

The OSD color can be changed.

##### 1 Display the entertainment menu.

Refer to *Introduction of menu operations* on page 54.

##### 2 Touch Appearance.

##### 3 Touch Screen.

##### 4 Touch one of the colors on the list.

#### Selecting the background display

You can switch the background that is displayed when listening to a source.

##### 1 Display the entertainment menu.

Refer to *Introduction of menu operations* on page 54.

##### 2 Touch Background.

##### 3 Touch the desired setting.

- If no JPEG images are stored in this unit, you cannot select photo. To store a JPEG image to this unit, refer to *Capture an image in JPEG files* on page 40. □

## Customizing menus

### 1 Display menu columns to register.

Refer to *Introduction of menu operations* on page 54.

You can customize menus except

#### **Video Setup Menu.**

### 2 Touch and hold the menu column to register it.

- To cancel registration, touch and hold the menu column again.

### 3 Display the custom menu and choose a registered menu.

Refer to *Introduction of menu operations* on page 54.



#### **Note**

You can register up to 12 columns. 

## Other Functions

### Changing the picture adjustment

You can adjust the **Brightness** (brightness), **Contrast** (contrast), **Color** (color), **Hue** (hue), **Dimmer** (dimmer), **Temperature** (temperature), **Black Level** (black level) and **RGB Dot ADJ** (RGB dot clock adjustment) for each source and rear view camera.

- You cannot adjust **Color**, **Hue**, **Contrast** and **Black Level** for the audio source.

#### 1 Press and hold MENU to display Picture Adjustment.

The adjustment function names are displayed.

#### 2 If you are adjusting the Picture Adjustment, select the unit.

<b>NAVI</b>	Adjusting the <b>Picture Adjustment</b> for the Navigation unit.
<b>Rear View</b>	Adjusting the <b>Picture Adjustment</b> for the rear view camera.
<b>Source</b>	Adjusting the <b>Picture Adjustment</b> for the source.

#### 3 Touch any of the following touch panel keys to select the function to be adjusted.

**Picture Adjustment** items are displayed.

- Brightness** – Adjusts the black intensity
- Contrast** – Adjusts the contrast
- Color** – Adjusts the color saturation
- Hue** – Adjusts the tone of color (red or green is emphasized)
- Dimmer** – Adjusts the brightness of the display
- Temperature** – Adjusts the color temperature, resulting in a better white balance
- Black Level** – Emphasizes the dark portions of images making the difference between bright and dark more distinct
- RGB Dot ADJ** – Adjusts phase shifting by dot clock when a Navigation unit is connected

- You cannot adjust the picture adjustment for the rear view camera when **Camera Polarity** is set to **Off**. (Refer to *Setting the rear view camera (back up camera)* on page 64.)
- If the color system is set to PAL/PAL-M/SECAM, you cannot adjust **Hue**.
- With some rear view cameras, picture adjustment may not be possible.

#### 4 Touch ◀ or ▶ to adjust the selected item.

Each time you touch ◀ or ▶, the level of the selected item increases or decreases.

- Dimmer** can be adjusted from **+1** to **+48**.
- Temperature** can be adjusted from **+3** to **-3**.

#### 5 Touch Black Level and RGB Dot ADJ to adjust.

- Black Level** can be set on or off.
- RGB Dot ADJ** can be set to **1** or **2**.



#### Notes

- You cannot operate this function while driving.
- Different **Brightness/Contrast/Dimmer** settings can be set for when the illumination switch is on and when it is off.

### Setting rear monitor output

The output source for the rear monitor can be switched to the following:

- Front** – The source on the front screen of this unit
- Disc** – The video and sound from the DVD
- AV** – The video and sound from AV input
- AUX** – The source for AUX input
- Off** – No source



#### Note

You cannot play DivX files on the rear and front monitors at the same time.

## Adjusting the response positions of the touch panels (Touch Panel Calibration)

If you feel that the touch panel keys on the screen deviate from the actual positions that respond to your touch, adjust the response positions of the touch panel. There are two adjustment methods: 4-point adjustment, in which you touch four corners of the screen; and 16-point adjustment, in which you make fine-adjustments on the entire screen.

- Touch the screen gently for adjustment. Forcefully pressing the touch panel may damage the touch panel. Do not use a sharp pointed tool such as a ballpoint pen or mechanical pen. Doing so may damage the screen.
- If the touch panel cannot be adjusted properly, consult your local Pioneer dealer.

### 1 Turn the unit off.

Refer to *Basic Operations* on page 11.

### 2 Press and hold MENU to display Picture Adjustment.

### 3 Press and hold MENU to start Touch Panel Calibration.

The 4-point touch panel adjustment screen appears.

### 4 Touch each of the arrows on the four corners of the screen.

- To cancel the adjustment, press and hold MENU.

### 5 Press MENU to complete 4-point adjustment.

Data for the adjusted position is saved.

- Do not turn off the engine while the data is being saved.

### 6 Press MENU to proceed to 16-point adjustment.

The 16-point touch panel adjustment screen appears.

- To cancel the adjustment, press and hold MENU.

### 7 Gently touch the center of the + mark displayed on the screen.

After you touch all the marks, the data for the adjusted position is saved.

- Do not turn off the engine while the data is being saved.

### 8 Press and hold MENU to complete the adjustment.

## Using an AUX source

A separately sold auxiliary device such as a VCR or portable device can be connected to this unit. When connected, the auxiliary device is automatically recognized as an AUX source and is assigned to **AUX**.

## About AUX connection methods

There are two methods to connect auxiliary devices to this unit.

### Mini pin plug cable (AUX)

*When connecting an auxiliary device using a mini plug cable*

iPods and portable audio/video players can be connected to this unit via mini plug cable.

- If an iPod with video capabilities is connected to this unit via 3.5mm plug (4 pole) cable (such as the CD-V150M), you can enjoy the video contents of the connected iPod.
- A portable audio/video player can be connected by using a 3.5mm plug (4 pole) with an RCA cable (sold separately). However, depending on the cable, a reverse connection between the red (right side audio) cable and yellow (video) cable may be required in order for the sound and video image to be reproduced correctly.

## Other Functions

### ● Insert the stereo mini plug into the AUX input jack on this unit.

Refer to the installation manual.

Refer to *What's what* on page 10. 

## Using an external unit

An external unit refers to a Pioneer product, such as those which will be available in the future. Although incompatible as a source, the basic functions of up to two external units can be controlled with this unit. When two external units are connected, the external units are automatically allocated to external unit 1 or external unit 2.

The basic operations of the external unit are explained below. The allocated functions will differ depending on the connected external unit. For details concerning these functions, refer to the owner's manual for the external unit.

## Basic operations

The functions allocated to the following operations will differ depending on the connected external unit. For details concerning these functions, refer to the owner's manual for the connected external unit.



Switching to auto or manual.



Switching to video and audio.



Changing the screen mode.  
Refer to *Changing the wide screen mode* on page 40.



Switching the equalizer curves.  
Refer to *Using the equalizer* on page 55.  
Touch and hold for more than two seconds to turn the auto-equalizer on or off.  
Refer to *Using the auto-equalizer* on page 56.



Actions will differ depending on the connected external unit.

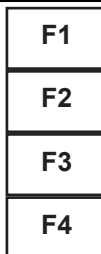

Function 1 to 4  
Actions will differ depending on the connected external unit.



Using the functions allocated to 1 to 6 keys.  
Actions will differ depending on the connected external unit.



# Additional Information

## Troubleshooting

### Common

Symptom	Cause	Action (Reference page)
The power will not turn on. The unit will not operate.	Leads and connectors are incorrectly connected.	Confirm once more that all connections are correct.
	The fuse is blown.	Rectify the cause and then replace the fuse. Be sure to install a fuse with the same rating.
	Noise and/or other factors are causing the built-in microprocessor to operate incorrectly.	Press <b>RESET</b> . (Page 10)
Operation with the remote control is not possible. The unit does not operate correctly even when the appropriate remote control buttons are pressed.	Battery power is low.	Load a new battery.
	Some operations are prohibited with certain discs.	Try operating with another disc.
Playback is not possible.	The disc is dirty.	Clean the disc. (Page 80)
	The type of disc loaded cannot be played on this unit.	Check the disc type.
	The disc loaded is not compatible with this video system.	Change the disc to one that is compatible with your video system.
There is no sound. The volume level will not rise.	Cables are not connected correctly.	Connect the cables correctly.
	The unit is performing still, slow motion or frame-by-frame playback.	There is no sound during still, slow motion or frame-by-frame playback.

Symptom	Cause	Action (Reference page)
There is no image displayed.	The parking brake cable is not connected.	Connect the parking brake cable, and apply the parking brake.
	The parking brake is not applied.	Connect the parking brake cable, and apply the parking brake.
The  icon is displayed, and operation is not possible.	The operation is prohibited for the disc.	This operation is not possible.
	The operation is not compatible with the configuration of the disc.	This operation is not possible.
The image displayed stops (pauses) and the unit cannot be operated.	The data could no longer be read during playback.	Stop playback once, and start playback again.
There is no sound. The volume level is low.	The volume level is low.	Adjust the volume level.
	The attenuator is on.	Turn the attenuator off.
The sound and video skip.	The unit is not firmly secured.	Firmly secure the unit.
	File size and transmission rate are above recommended rates.	Create a DivX file that is within the recommended size and transmission rate.
The aspect ratio is incorrect and the image is stretched.	The aspect ratio setting is incorrect for the display.	Select the appropriate setting for your display. (Page 59)
The motor sounds when the ignition switch is turned ON (or is turned to ACC).	The unit is confirming whether or not a disc is loaded.	This is a normal operation.



## Additional Information

Symptom	Cause	Action (Reference page)
Nothing is displayed. The touch panel keys cannot be used.	The rear view camera is not connected. <b>Camera Polarity</b> is at incorrect setting.	Connect a rear view camera. Press and hold <b>MENU</b> to return to the source display and then select the correct setting for <b>Camera Polarity</b> . (Page 64)
<b>No xxxx</b> appears when a display is changed ( <b>No Title</b> , for example).	There is no text information embedded.	Switch the display or play another track/file.
Sub-folders cannot be played back.	Folder repeat play has been selected.	Select the repeat range again.
The repeat range changes automatically.	Another folder was selected during repeat play. Track search or fast forward/reverse was performed during file repeat play.	Select the repeat range again. Select the repeat range again.

### DVD

Symptom	Cause	Action (Reference page)
Playback is not possible.	The loaded disc has a different region number from this unit.	Replace the disc with one featuring the same region number as this unit.
A parental lock message is displayed and playback is not possible.	Parental lock is activated.	Turn parental lock off or change the level. (Page 59)
Parental lock cannot be canceled.	The code number is incorrect. You have forgotten your code number.	Enter the correct code number. (Page 59) Press <b>RESET</b> . (Page 60)

Symptom	Cause	Action (Reference page)
Dialog language (and subtitle language) cannot be switched.	The DVD being played does not feature multiple language recordings. You can only switch between items indicated in the disc menu.	The language cannot be switched if they are not recorded on the disc. Switch the language using the disc menu.
No subtitles are displayed.	The DVD being played does not feature subtitles. You can only switch between items indicated in the disc menu.	Subtitles are not displayed if they are not recorded on the disc. Switch the language using the disc menu.
Playback is not performed with the audio language and subtitle language settings selected in <b>Video Setup Menu</b> .	The DVD being played does not feature dialog or subtitles in the selected language.	The language cannot be switched if the selected language is not recorded on the disc.
The viewing angle cannot be switched.	The DVD being played does not feature scenes shot from multiple angles. You are trying to switch to multi-angle viewing for a scene that was not recorded from multiple angles.	The viewing angle cannot be switched if the DVD does not feature scenes recorded from multiple angles. Switch between multiple angles when watching scenes recorded from multiple angles.

## Additional Information

Symptom	Cause	Action (Reference page)
The image is extremely unclear/distorted and dark during playback.	Some discs feature a signal to prohibit copying.	Since this unit is compatible with the analog copy generation management system, when playing a disc that has a signal prohibiting copying, horizontal stripes or other imperfections may appear when viewed on some displays. This is not a malfunction.

### Video CD

Symptom	Cause	Action
The PBC (playback control) menu cannot be called up.	The Video CD being played does not feature PBC.	This operation is not available for Video CDs that do not feature PBC.
Repeat play and track/time search are not possible.	The Video CD being played features PBC.	This operation is not available for Video CDs that feature PBC.

### iPod

Symptom	Cause	Action
The iPod does not operate correctly.	The cables are incorrectly connected.	Disconnect the cable from the iPod. Once the iPod's main menu is displayed, reconnect the iPod and reset it.
	The iPod version is old.	Update the iPod version.

### Bluetooth audio/telephone

Symptom	Cause	Action
The sound from the Bluetooth audio source is not played back.	There is a call in progress on a Bluetooth-connected cellular phone.	The sound will be played back when the call is terminated.
	A Bluetooth-connected cellular phone is currently being operated.	Do not operate the cellular phone at this time.
	A call was made with a Bluetooth-connected cellular phone and then immediately terminated. As a result, communication between this unit and the cellular phone was not terminated properly.	Reconnect the Bluetooth connection between this unit and the cellular phone.



## Error messages

When you contact your dealer or your nearest Pioneer Service Center, be sure to note the error message.

### Tuner

Message	Cause	Action
<b>No Data Provided</b>	This unit cannot receive artist name/song title information.	Move to the desirable location with good reception.
<b>No Data</b>	This unit cannot receive program service name information.	Move to the desirable location with good reception.

### DVD

Message	Cause	Action
<b>Different Region Disc</b>	The disc does not have the same region number as this unit.	Replace the DVD with one bearing the correct region number.

## Additional Information

Message	Cause	Action
<b>Error-02-XX/ FF-FF</b>	The disc is dirty.	Clean the disc.
	The disc is scratched.	Replace the disc.
	The disc is loaded upside down.	Check that the disc is loaded correctly.
	There is an electrical or mechanical error.	Press <b>RESET</b> .
<b>Unplayable Disc</b>	This type of disc cannot be played on this unit.	Replace the disc with one that can be played on this unit.
	The inserted disc does not contain any playable files.	Replace the disc.
<b>Protect</b>	All the files on the inserted disc are embedded with DRM.	Replace the disc.
<b>Skipped</b>	The inserted disc contains DRM protected WMA files.	Play an audio file not embedded with Windows Media DRM 9/10.
<b>TEMP</b>	The temperature of the unit is outside the normal operating range.	Wait until the unit returns to a temperature within the normal operating limits.
<b>Rental Expired.</b>	The inserted disc contains expired DivX VOD content.	Select a file that can be played.
<b>Unplayable File-High Definition</b>	The inserted disc contains a high definition DivX file.	Select a file that can be played.
<b>It is not possible to write it in the flash.</b>	This unit's flash memory used as the temporary storage area is full.	Select a file that can be played.
<b>Authorization Error</b>	This unit's DivX registration code has not been authorized by the DivX VOD contents provider.	Register this unit to the DivX VOD contents provider. (Page 40)

Message	Cause	Action
<b>Unplayable File</b>	This type of file cannot be played on this unit.	Select a file that can be played.
<b>Format Read/Ready</b>	Sometimes there is a delay between the start of playback and when you start to hear any sound.	Wait until the message disappears and you hear sound.
<b>Video frame rate not supported.</b>	DivX file's frame rate is more than 30 fps.	Select a file that can be played.
<b>Audio Format not supported.</b>	This type of file is not supported on this unit.	Select a file that can be played.

### External storage device (USB, SD)

Message	Cause	Action
<b>Unplayable File</b>	This type of file cannot be played on this unit.	Select a file that can be played.
	There are no songs.	Transfer the audio files to the USB portable audio player/USB memory and connect.
	Security for the connected USB memory is enabled.	Follow the USB memory instructions to disable security.
<b>Format Read/Ready</b>	Sometimes there is a delay between the start of playback and when you start to hear any sound.	Wait until the message disappears and you hear sound.
<b>Skipped</b>	The connected USB portable audio player/USB memory contains WMA files that are protected by Windows Media™ DRM 9/10.	Play an audio file not embedded with Windows Media DRM 9/10.

## Additional Information

Message	Cause	Action
<b>Protect</b>	All the files on the connected USB portable audio player/USB memory are protected by Windows Media DRM 9/10.	Transfer audio files not protected by Windows Media DRM 9/10 to the USB portable audio player/USB memory and connect.
<b>Incompatible USB</b>	The USB device connected to is not supported by this unit.	Connect a USB portable audio player or USB memory that is USB Mass Storage Class compliant.
	The USB device is not formatted with FAT16 or FAT32.	The connected USB device should be formatted with FAT16 or FAT32.
<b>Incompatible SD</b>	Unsupported SD card is inserted.	Use the supported SD card.
	Not compatible SD storage device	Remove your device and replace it with a compatible SD storage device.
<b>Check USB</b>	The USB connector or USB cable has short-circuited.	Check that the USB connector or USB cable is not caught in something or damaged.
	The connected USB portable audio player/USB memory consumes more than maximum allowable current.	Disconnect the USB portable audio player/USB memory and do not use it. Turn the ignition switch to OFF, then to ACC or ON and then connect a compliant USB portable audio player/USB memory.

Message	Cause	Action
<b>Error-02-9X/-DX</b>	Communication failed.	Perform one of the following operations. –Turn the ignition switch OFF and back ON. –Disconnect the USB portable audio player/USB memory. –Change to a different source. Then, return to the USB portable audio player/USB memory.
<b>Rental Expired.</b>	The inserted disc contains expired DivX VOD content.	Select a file that can be played.
<b>Unplayable File-High Definition</b>	The inserted disc contains a high definition DivX file.	Select a file that can be played.
<b>It is not possible to write it in the flash.</b>	This unit's flash memory used as the temporary storage area is full.	Select a file that can be played.
<b>Authorization Error</b>	This unit's DivX registration code has not been authorized by the DivX VOD contents provider.	Register this unit to the DivX VOD contents provider. (Page 40)
<b>Unplayable File</b>	This type of file cannot be played on this unit.	Select a file that can be played.
<b>Format Read/Ready</b>	Sometimes there is a delay between the start of playback and when you start to hear any sound.	Wait until the message disappears and you hear sound.
<b>Video frame rate not supported.</b>	DivX file's frame rate is more than 30 fps.	Select a file that can be played.
<b>Audio Format not supported.</b>	This type of file is not supported on this unit.	Select a file that can be played.

## Additional Information

### iPod

Message	Cause	Action
<b>Format Read/Ready</b>	Sometimes there is a delay between the start of playback and when you start to hear any sound.	Wait until the message disappears and you hear sound.
<b>Error-02-6X/-9X/-DX</b>	Communication failed.	Disconnect the cable from the iPod. Once the iPod's main menu is displayed, reconnect the iPod and reset it.
	iPod failure	Disconnect the cable from the iPod. Once the iPod's main menu is displayed, reconnect the iPod and reset it.
<b>Error-02-67</b>	The iPod firmware versions are old.	Update the iPod version.
<b>Stop</b>	There are no songs.	Transfer songs to the iPod.
	There are no songs in the current list.	Select a list that contains songs.

### iTunes tagging

Message	Cause	Action
<b>iPod full. Tags not transferred.</b>	Memory used for tag information on the iPod is full.	Sync the iPod with iTunes and clean up the tagged playlist.
<b>Memory full. Tags not stored.</b>	This unit's flash memory used as the temporary storage area is full.	Connect the iPod to this unit and transfer this unit's tag information to the iPod.
<b>Tags transferred failed.</b>	This unit's tag information cannot transfer to the iPod.	Check the iPod and try again.
<b>Tag store failed.</b>	Tag information cannot be stored in this unit.	Try again.

Message	Cause	Action
<b>Error-8D</b>	Built-in FLASH ROM encountered an error	Turn the ignition OFF and ON.
<b>SD source cannot be selected during tag transfer.</b>	Tag information is being transferred to the iPod.	Wait until tag transfer is complete.

### Bluetooth

Message	Cause	Action
<b>Error-10</b>	The power failed for the Bluetooth module of this unit.	Turn the ignition switch OFF and then to ACC or ON. If the error message is still displayed after performing the above action, please contact your dealer or an authorized Pioneer Service Station.



## Understanding auto EQ error messages

When correct measurement of the car's interior acoustic characteristics is not possible using auto EQ, an error message may appear on the display. In such cases, refer to the table below to see what the problem is and how it may be corrected. After checking, try again.

Message	Cause	Action
<b>Error. Please check MIC.</b>	The microphone is not connected.	Plug the optional microphone securely into the jack.

## Additional Information

Message	Cause	Action
<b>Error. Please check xxxx speaker.</b>	The microphone cannot pick up the measuring tone of a speaker.	<ul style="list-style-type: none"> <li>• Confirm that the speakers are connected correctly.</li> <li>• Correct the input level setting of the power amp connected to the speakers.</li> <li>• Plug the microphone securely into the jack.</li> </ul>
<b>Error. Please check noise.</b>	The surrounding noise level is too high.	<ul style="list-style-type: none"> <li>• Stop your car in a place that is quiet, and switch off the engine, air conditioner and heater.</li> <li>• Set the microphone correctly.</li> </ul>
<b>Error. Please check battery.</b>	Power is not being supplied from the battery to this unit.	<ul style="list-style-type: none"> <li>• Connect the battery correctly.</li> <li>• Check the battery voltage.</li> </ul>



## Understanding messages

Messages	Translation
<b>CAUTION: Screen image may appear reversed.</b>	<b>Pioneer recommends the use of a camera which outputs mirror-reversed images. Otherwise, the screen image will appear reversed.</b>



## Indicator list

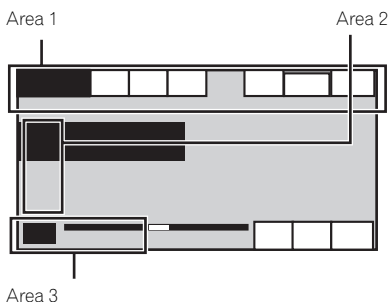

### Area 1



Indicates that the selected frequency is being broadcast in stereo.



Indicates that a Bluetooth telephone is connected.

**Dolby D**

Indicates that the digital format is Dolby Digital.

**MPEG-A**

Indicates that the digital format is MPEG Audio.

**LPCM**

Indicates that the digital format is Linear PCM.

**48k16**

Indicates the sampling frequency.

**DTS**

Indicates that the digital format is DTS.

**1 ch**

**1+1ch**

**2 ch**

**Mch**

Indicates the audio channel.

**PBCOn**

Indicates that a disc with PBC On is being played.

## Additional Information



Indicates that a cellular phone is connected.

- Indicates that an incoming call has been received and has not been checked yet.
- Not displayed for calls made when your cellular phone is disconnected from this unit.



Indicates the battery strength of the cellular phone.

- The level shown on the indicator may differ from the actual battery strength.
- If the battery strength is not available, nothing is displayed in the battery strength indicator area.



Indicates the signal strength of the cellular phone.

**Auto EQ**

Indicates that Auto EQ is on.



Shows when HD Radio signal is received.



Shows when analog audio of HD Radio signal is received.



Shows when digital audio of HD Radio signal is received.



Shows when HD Radio station information is received.



Shows when downloadable song information (tag) from a radio station is received.



Shows when song information (tag) from an HD Radio station is being saved to this unit.



Shows while searching a song/video in alphabet search mode. Shows when song information (tag) is being saved to your iPod.



Shows when this unit has the song information (tag).



Shows which audio language has been selected.



Shows which subtitle language has been selected.



Shows which viewing angle has been selected.



Shows which audio output has been selected.

### Area 2



Shows the disc title of the CD text disc currently being played.



Shows the song title when receiving the tag information. Shows the track title of the track currently being played for CD text discs. Shows the song title of the song currently being played for MP3/WMA/AAC files.



Shows the comment currently being played.



Shows the station name currently tuned in to.



Shows the artist name when receiving the tag information. Shows the artist name of the track/song currently being played for CD text discs. Shows the artist name of the artist currently being played for MP3/WMA/AAC files.



Shows cellular phone information.



Shows general phone information.



Shows home phone information.



Shows office phone information.



Shows other phone information.

## Additional Information



Shows the category name.



Shows the folder name of the folder containing the MP3/WMA/AAC file currently being played.



Shows the file name of the MP3/WMA/AAC file currently being played.



Shows the preset number of the station currently being tuned in to.



Shows the channel currently being tuned in to.



Shows SIRIUS information.

### Area 3



Shows the title number currently being played.



Shows the chapter number currently being played.



Shows the replay time currently being played.



Shows when the game alert function is on while receiving SIRIUS stations.



Shows the genre of the track/song currently being played.

**DEMO**

Indicates that the feature demo is on.



## Handling guideline

### Discs and player

Use only discs featuring any of following logos.



Use 12-cm disc. Do not use 8-cm disc or an adapter for 8-cm disc.

Use only conventional, fully circular discs. Do not use shaped discs.



Do not insert anything other than a DVD (-R/-RW) or CD (-R/-RW) into the disc loading slot.

Do not use cracked, chipped, warped, or otherwise damaged discs as they may damage the player.

Unfinalized CD-R/CD-RW disc playback is not possible.

Do not touch the recorded surface of the discs.

Store discs in their cases when not in use.

Avoid leaving discs in excessively hot environments including under direct sunlight.

Do not attach labels, write on or apply chemicals to the surface of the discs.

To clean a disc, wipe the disc with a soft cloth outward from the center.

Condensation may temporarily impair the player's performance. Leave it to adjust to the warmer temperature for about one hour. Also, wipe any damp discs with a soft cloth.

Playback of discs may not be possible because of disc characteristics, disc format, recorded application, playback environment, storage conditions, and so on.



## Additional Information

Road shocks may interrupt disc playback.

Read the precautions for discs before using them.

Certain functions may not be available for some DVD video discs.

It may not be possible to play back some DVD video discs.

It is not possible to play back DVD-RAM discs.

This unit is not compatible with discs recorded in AVCHD (Advanced Video Codec High Definition) format. Do not insert AVCHD discs as you may not be able to eject the disc.

### External storage device (USB, SD)

Address any questions you have about your external storage device (USB, SD) to the manufacturer of the device.

Do not leave the external storage device (USB, SD) in places with high temperatures.

Depending on the external storage device (USB, SD), the following problems may occur.

- Operations may vary.
- The storage device may not be recognized.
- Files may not be played back properly.

### USB storage device

Connections via USB hub are not supported.

Do not connect anything other than a USB storage device.

Firmly secure the USB storage device when driving. Do not let the USB storage device fall onto the floor, where it may become jammed under the brake or accelerator pedal.

Depending on the USB storage device, the device may cause noise to occur on the radio.

Copyright protected files that are stored in the USB devices cannot be played back.

You cannot connect a USB portable audio player/USB memory to this unit via USB hub.

Partitioned USB memory is not compatible with this unit.

Depending on the kind of USB portable audio player/USB memory you use, the device may not be recognized or audio files may not be played back properly.

Do not leave the USB portable audio player/USB memory in direct sunlight for extended amounts of time. Doing so may cause the device to malfunction from the extreme rise in temperature.

### SD memory card

This unit supports only the following types of SD memory cards.

- SD

Keep the SD memory card out of the reach of children. Should the SD memory card be swallowed, consult a doctor immediately.

Do not touch the connectors of the SD memory card directly with your fingers or with any metal device.

Do not insert anything other than an SD memory card into the SD card slot. If a metal object (such as a coin) is inserted into the slot, the internal circuits may break and cause malfunctions.

Do not insert a damaged SD memory card (e.g. warped, label peeled off) as it may not be ejected from the slot.

Do not try to force an SD memory card into the SD card slot as the card or this unit may be damaged.

When ejecting an SD memory card, press it and hold it until it clicks. It is dangerous to release your finger immediately after pressing the card as it may shoot out of the slot and hit you in the face, etc. If the card shoots out of the slot, it may be lost.

### iPod

Do not leave the iPod in direct sunlight for extended amounts of time. Doing so may cause the iPod to malfunction from the extreme rise in temperature.

Do not leave the iPod in places with high temperatures.

To ensure proper operation, connect the dock connector cable from the iPod directly to this unit.

Firmly secure the iPod when driving. Do not let the iPod fall onto the floor, where it may become jammed under the brake or accelerator pedal.

## Additional Information

For details, refer to the manuals for the iPod.

### About iPod settings

- When an iPod is connected, this unit changes the EQ (equalizer) setting of the iPod to off in order to optimize the acoustics. When you disconnect the iPod, the EQ returns to the original setting.
- You cannot set Repeat to off on the iPod when using this unit. Repeat is automatically changed to All when the iPod is connected to this unit.

### DVD-R/DVD-RW discs

Unfinalized DVD-R/DVD-RW discs which have been recorded in the Video format (video mode) cannot be played back.

Playback of DVD-R/DVD-RW discs may not be possible, due to disc characteristics, scratches or dirt on the disc, or dirt, condensation, etc. on the lens of this unit.

Depending on the application settings and the environment, playback of discs recorded on a personal computer may not be possible. (For details, contact the manufacturer of the application.)

### CD-R/CD-RW discs

When CD-R/CD-RW discs are used, playback is possible only for discs which have been finalized.

Playback of CD-R/CD-RW discs recorded on a music CD recorder or a personal computer may not be possible due to disc characteristics, scratches or dirt on the disc, or dirt, condensation, etc., on the lens of this unit.

Depending on the application settings and the environment, playback of discs recorded on a personal computer may not be possible. (For details, contact the manufacturer of the application.)

Playback of CD-R/CD-RW discs may become impossible in case of direct exposure to sunlight, high temperatures, or the storage conditions in the vehicle. Titles and other text information recorded on a CD-R/CD-RW disc may not be displayed by this unit (in the case of audio data (CD-DA)).

### DualDiscs

DualDiscs are two-sided discs that have a recordable CD for audio on one side and a recordable DVD for video on the other.

Playback of the DVD side is possible with this unit. However, since the CD side of DualDiscs is not physically compatible with the general CD standard, it may not be possible to play the CD side with this unit.

Frequent loading and ejecting of a DualDisc may result in scratches on the disc. Serious scratches can lead to playback problems on this unit. In some cases, a DualDisc may become stuck in the disc loading slot and will not eject. To prevent this, we recommend you refrain from using DualDisc with this unit. Please refer to the information from the disc manufacturer for more detailed information about DualDiscs.

### JPEG picture files

JPEG is short for Joint Photographic Experts Group and refers to a still image compression technology standard.

Files are compatible with Baseline JPEG and EXIF 2.1 still images up to a resolution of 8 192 × 7 680. (EXIF format is used most commonly with digital still cameras.)

Playback of EXIF format files that were processed by a personal computer may not be possible.

There is no progressive JPEG compatibility.

### DivX video files

Depending on the composition of the file information, such as the number of audio streams or file size, there may be a slight delay when playing back discs.

Some special operations may be prohibited due to the composition of the DivX files.

Only DivX files downloaded from a DivX partner site are guarantee for proper operation. Unauthorized DivX files may not operate properly.

DRM rental files cannot be operated until playback is started.

Recommended file size: 2 Mbps or less with a transmission rate of 2 GB or less.

The ID code of this unit must be registered to a DivX VOD provider in order to playback DivX VOD files. For information on ID codes, refer to *Displaying the DivX® VOD registration code* on page 61.

For more details about DivX, visit the following site: <http://www.divx.com/>

### Important

- When naming a JPEG image file, add the corresponding filename extension (.jpg, .jpeg, .jpe or .jfif).

## Additional Information

- This unit plays back files with these filename extensions (.jpg, .jpeg, .jpe or .jif) as a JPEG image file. To prevent malfunctions, do not use these extensions for files other than JPEG image files. 

## Compressed audio compatibility (disc, USB, SD)

### WMA

File extension: .wma

Bit rate: 5 kbps to 320 kbps (CBR), VBR

Sampling frequency: 8 kHz to 48 kHz

Windows Media Audio Professional, Lossless, Voice/DRM Stream/Stream with video: No

### MP3

File extension: .mp3

Bit rate: 8 kbps to 320 kbps

Sampling frequency: 8 kHz to 48 kHz (32 kHz, 44.1 kHz, 48 kHz for emphasis)

Compatible ID3 tag version: 1.0, 1.1, 2.2, 2.3 (ID3 tag Version 2.x is given priority over Version 1.x.)

M3u playlist: No

MP3i (MP3 interactive), mp3 PRO: No

### AAC

Compatible format: AAC encoded by iTunes

File extension: .m4a

Sampling frequency: 8 kHz to 44.1 kHz

Bit rate: 8 kbps to 320 kbps

Apple Lossless: No

AAC file bought on the iTunes Store (.m4p file extension): No

### DivX compatibility

Compatible format: DivX video format implemented in relation to DivX standards

File extensions: .avi or .divx

DivX Ultra format: No

DivX HD format: No

DivX files without video data: No

DivX plus: No

Compatible audio codec: MP2, MP3, Dolby Digital

LPCM: No

Bit rate: 8 kbps to 320 kbps (CBR), VBR

Sampling frequency: 8 kHz to 48 kHz

Compatible external subtitle file extension: .srt

### Supplemental information

Some characters in a file name (including the file extension) or a folder name may not be displayed.

This unit may not operate correctly depending on the application used to encode WMA files.

There may be a slight delay when starting playback of audio files embedded with image data.

### Disc

Playable folders: up to 700

Playable files: up to 999 for CD-R/CD-RW

Playable files: up to 3500 for DVD-R/DVD-RW

File system: ISO 9660 Level 1 and 2, Romeo, Joliet, UDF 1.02 (DVD-R/DVD-RW)

Multi-session playback: Yes

Packet write data transfer: No

Regardless of the length of blank section between the songs of the original recording, compressed audio discs play with a short pause between songs.

### External storage device (USB, SD)

Playable folders: up to 6 000

Playable files: up to 65 535, up to 255 for one folder

Playback of copyright protected files: No

Partitioned external storage device (USB, SD): Only the first playable partition can be played.

There may be a slight delay when starting playback of audio files on an external storage device (USB, SD) with numerous folder hierarchies.

## Additional Information

There is no compatibility for Multi Media Cards (MMC).

Compatibility with all SD memory cards is not guaranteed.

This unit is not compatible with SD-Audio/SD-Video.

### **CAUTION**

Pioneer accepts no responsibility for data lost on the USB memory/USB portable audio player/SD memory card even if that data is lost while using this unit. 

## iPod compatibility

This unit supports only the following iPod models. Supported iPod software versions are shown below. Older versions may not be supported.

- iPod nano 5th generation (software version 1.0.2)
- iPod nano 4th generation (software version 1.0.3)
- iPod nano 3rd generation (software version 1.1.3)
- iPod nano 2nd generation (software version 1.1.3)
- iPod nano 1st generation (software version 1.3.1)
- iPod touch 2nd generation (software version 3.0)
- iPod touch 1st generation (software version 3.0)
- iPod classic 120GB (software version 2.0.1)
- iPod classic (software version 1.1.2)
- iPod 5th generation (software version 1.3.0)
- iPhone 3GS (software version 3.0)
- iPhone 3G (software version 3.0)
- iPhone (software version 3.0)

Depending on the generation or version of the iPod, some functions can not be operated.

Operations may vary depending on the software version of iPod.

When using an iPod, iPod Dock Connector to USB Cable is required.

Pioneer CD-IU50 interface cable is also available. For details, consult your dealer.

About the file/format compatibility, refer to iPod manuals.

Audio Book, Podcast: Yes

### **CAUTION**

Pioneer accepts no responsibility for data lost on the iPod even if that data is lost while using this unit. 

## Sequence of audio files

The user cannot assign folder numbers and specify playback sequences with this unit.

### Example of a hierarchy

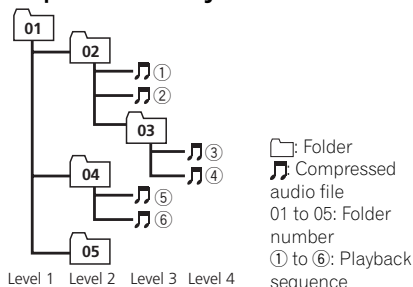

### Disc

Folder selection sequence or other operation may differ depending on the encoding or writing software.

### External storage device (USB, SD)

Playback sequence is the same as recorded sequence in the external storage device (USB, SD).

To specify the playback sequence, the following method is recommended.

- 1 Create the file name including numbers that specify the playback sequence (e.g., 001xxx.mp3 and 099yyy.mp3).
- 2 Put those files into a folder.
- 3 Save the folder containing files on the external storage device (USB, SD).

However, depending on the system environment, you may not be able to specify the playback sequence.

For USB portable audio players, the sequence is different and depends on the player. 

## Additional Information

### Using the display correctly

#### CAUTION

- If liquid or foreign matter should get inside this unit, turn off the power immediately and consult your dealer or the nearest authorized PIONEER Service Station. Do not use the unit in this condition because doing so may result in fire, electric shock, or other failure.
- If you notice smoke, a strange noise or smell, or any other abnormal signs from the display, turn off the power immediately and consult your dealer or the nearest authorized PIONEER Service Station. Using this unit in this condition may result in permanent damage to the system.
- Do not disassemble or modify this unit, as there are high-voltage components inside which may cause electric shock. Be sure to consult your dealer or the nearest authorized PIONEER Service Station for internal inspection, adjustments, or repairs.

### Handling the display

- Never touch the screen with anything besides your finger when operating the touch panel function. The screen can scratch easily.
- When the display is subjected to direct sunlight for a long period of time, it will become very hot resulting in possible damage to the LCD screen. You should avoid exposing the display unit to direct sunlight as much as possible.
- The display should be used within the temperature range of  $-10^{\circ}\text{C}$  to  $+60^{\circ}\text{C}$  ( $14^{\circ}\text{F}$  to  $140^{\circ}\text{F}$ ).

At temperatures higher or lower than this operating temperature range, the display may not operate normally.

- The LCD screen is exposed in order to increase its visibility within the vehicle. Do not press it strongly on it as this may damage it.
- Do not push the LCD screen forcefully as this may scratch it.

### Liquid crystal display (LCD) screen

- Heat from the heater may damage the LCD screen, and cool air from the cooler may cause moisture to form inside the display resulting in possible damage.
- Small black dots or white dots (bright dots) may appear on the LCD screen. These are due to the characteristics of the LCD screen and do not indicate a malfunction.
- When using a cellular phone, keep the antenna away from the display to prevent disruption of the video image by the appearance of spots, colored stripes, etc.

### LED (light-emitting diode) backlight

- At low temperatures, using the LED backlight may increase image lag and degrade the image quality due to the characteristics of the LCD screen. Image quality will improve with an increase in temperature.
- To protect the LED backlight, the display will darken in the following environments:
  - In the direct sunlight
  - Near the heater vent
- The product lifetime of the LED backlight is more than 10 000 hours. However, it may decrease if used in high temperatures.
- If the LED backlight reaches the end of its product lifetime, the screen will become dark and the image will no longer be projected. In such cases, please consult your dealer or the nearest authorized PIONEER Service Station.

### Keeping the display in good condition

- When removing dust from the screen or cleaning the display, first turn the system power off, then wipe with a soft dry cloth.
- When wiping the screen, take care not to scratch the surface. Do not use harsh or abrasive chemical cleaners. 

## Additional Information

### Copyright and trademark

This product incorporates copyright protection technology that is protected by method claims of certain U.S. patents and other intellectual property rights owned by Macrovision Corporation and other rights owners. Use of this copyright protection technology must be authorized by Macrovision Corporation, and is intended for home and other limited viewing uses only unless otherwise authorized by Macrovision Corporation. Reverse engineering or disassembly is prohibited.

### Bluetooth



The Bluetooth® word mark and logos are registered trademarks owned by Bluetooth SIG, Inc. and any use of such marks by Pioneer Corporation is under license. Other trademarks and trade names are those of their respective owners.

- Bluetooth is a short-range wireless radio connectivity technology that is developed as a cable replacement for mobile phones, handheld PCs and other devices. Bluetooth operates in 2.4 GHz frequency range and transmits voice and data at speeds up to 1 megabit per second. Bluetooth was launched by a special interest group (SIG) that comprises of Ericsson Inc., Intel Corp., Nokia Corp., Toshiba and IBM in 1998, and it is currently developed by nearly 2 000 companies worldwide.

### DVD video



**DVD** is a trademark of DVD Format/Logo Licensing Corporation.

### iTunes

Apple and iTunes are trademarks of Apple Inc., registered in the U.S. and other countries.

### MP3

Supply of this product only conveys a license for private, non-commercial use and does not convey a license nor imply any right to use this product in any commercial (i.e. revenue-generating) real time broadcasting (terrestrial, satellite, cable and/or any other media), broadcasting/streaming via internet, intranets and/or other networks or in other electronic content distribution systems, such as pay-audio or audio-on-demand applications. An independent license for such use is required. For details, please visit <http://www.mp3licensing.com>.

### WMA



Windows Media and the Windows logo are trademarks or registered trademarks of Microsoft Corporation in the United States and/or other countries.

This product includes technology owned by Microsoft Corporation and cannot be used or distributed without a license from Microsoft Licensing, Inc.

## Additional Information

### SD memory card



SD Logo is a trademark.

### iPod



iPod is a trademark of Apple Inc., registered in the U.S. and other countries.

"Made for iPod" means that an electronic accessory has been designed to connect specifically to iPod and has been certified by the developer to meet Apple performance standards.

Apple is not responsible for the operation of this device or its compliance with safety and regulatory standards.

### iPhone



iPhone is a trademark of Apple Inc.

"Works with iPhone" means that an electronic accessory has been designed to connect specifically to iPhone and has been certified by the developer to meet Apple performance standards.

Apple is not responsible for the operation of this device or its compliance with safety and regulatory standards.

### Dolby Digital



Manufactured under license from Dolby Laboratories. Dolby, Pro Logic, and the double-D symbol are trademarks of Dolby Laboratories.

### DivX



DivX® is a registered trademark of DivX, Inc., and is used under license.

**ABOUT DIVX VIDEO:** DivX® is a digital video format created by DivX, Inc. This is an official DivX Certified device that plays DivX video. Visit [www.divx.com](http://www.divx.com) for more information and software tools to convert your files into DivX video.

**ABOUT DIVX VIDEO-ON-DEMAND:** This DivX Certified® device must be registered in order to play DivX Video-on-Demand (VOD) content. To generate the registration code, locate the DivX VOD section in *Menu operations*. Go to [vod.divx.com](http://vod.divx.com) with this code to complete the registration process and learn more about DivX VOD.

### About the SAT RADIO READY mark



## Additional Information

The SAT RADIO READY mark indicates that the Satellite Radio Tuner for Pioneer (i.e., XM tuner and Sirius satellite tuner which are sold separately) can be controlled by this unit. Please inquire to your dealer or nearest authorized Pioneer service station regarding the satellite radio tuner that can be connected to this unit. For satellite radio tuner operation, please refer to the satellite radio tuner owner's manual.

- The system will use direct satellite-to-receiver broadcasting technology to provide listeners in their cars and at home with crystal-clear sound seamlessly from coast to coast. Satellite radio will create and package over 100 channels of digital-quality music, news, sports, talk and children's programming.
- "SAT Radio", the SAT Radio logo and all related marks are trademarks of Sirius Satellite Radio Inc., and XM Satellite Radio Inc.

### **HD Radio™ Technology**

- HD Radio™ and the HD Radio Ready logo are proprietary trademarks of iBiquity Digital Corporation. 



# Additional Information

## Language code chart for DVD

### Language (code), input code

Japanese (ja), <b>1001</b>	Dzongkha (dz), <b>0426</b>	Kurdish (ku), <b>1121</b>	Kinyarwanda (rw), <b>1823</b>
English (en), <b>0514</b>	Ewe (ee), <b>0505</b>	Komi (kv), <b>1122</b>	Sanskrit (sa), <b>1901</b>
French (fr), <b>0618</b>	Esperanto (eo), <b>0515</b>	Cornish (kw), <b>1123</b>	Sardinian (sc), <b>1903</b>
Spanish (es), <b>0519</b>	Estonian (et), <b>0520</b>	Kirghiz, Kyrgyz (ky), <b>1125</b>	Sindhi (sd), <b>1904</b>
German (de), <b>0405</b>	Basque (eu), <b>0521</b>	Latin (la), <b>1201</b>	Northern Sami (se), <b>1905</b>
Italian (it), <b>0920</b>	Persian (fa), <b>0601</b>	Luxembourgish (lb), <b>1202</b>	Sangho (sg), <b>1907</b>
Chinese (zh), <b>2608</b>	Fulah (ff), <b>0606</b>	Ganda (lg), <b>1207</b>	Sinhala (si), <b>1909</b>
Dutch, Flemish (nl), <b>1412</b>	Finnish (fi), <b>0609</b>	Limburgan (li), <b>1209</b>	Slovak (sk), <b>1911</b>
Portuguese (pt), <b>1620</b>	Fijian (fj), <b>0610</b>	Lingala (ln), <b>1214</b>	Slovenian (sl), <b>1912</b>
Swedish (sv), <b>1922</b>	Faroese (fo), <b>0615</b>	Lao (lo), <b>1215</b>	Samoan (sm), <b>1913</b>
Russian (ru), <b>1821</b>	Western Frisian (fy), <b>0625</b>	Lithuanian (lt), <b>1220</b>	Shona (sn), <b>1914</b>
Korean (ko), <b>1115</b>	Irish (ga), <b>0701</b>	Luba-Katanga (lu), <b>1221</b>	Somali (so), <b>1915</b>
Greek (el), <b>0512</b>	Gaelic (gd), <b>0704</b>	Latvian (lv), <b>1222</b>	Albanian (sq), <b>1917</b>
Afar (aa), <b>0101</b>	Galician (gl), <b>0712</b>	Malagasy (mg), <b>1307</b>	Serbian (sr), <b>1918</b>
Abkhazian (ab), <b>0102</b>	Guarani (gn), <b>0714</b>	Marshallese (mh), <b>1308</b>	Swati (ss), <b>1919</b>
Avestan (ae), <b>0105</b>	Gujarati (gu), <b>0721</b>	Maori (mi), <b>1309</b>	Sotho, Southern (st), <b>1920</b>
Afrikaans (af), <b>0106</b>	Manx (gv), <b>0722</b>	Macedonian (mk), <b>1311</b>	Sundanese (su), <b>1921</b>
Akan (ak), <b>0111</b>	Hausa (ha), <b>0801</b>	Malayalam (ml), <b>1312</b>	Swahili (sw), <b>1923</b>
Amharic (am), <b>0113</b>	Hebrew (he), <b>0805</b>	Mongolian (mn), <b>1314</b>	Tamil (ta), <b>2001</b>
Aragonese (an), <b>0114</b>	Hindi (hi), <b>0809</b>	Marathi (mr), <b>1318</b>	Telugu (te), <b>2005</b>
Arabic (ar), <b>0118</b>	Hiri Motu (ho), <b>0815</b>	Malay (ms), <b>1319</b>	Tajik (tg), <b>2007</b>
Assamese (as), <b>0119</b>	Croatian (hr), <b>0818</b>	Maltese (mt), <b>1320</b>	Thai (th), <b>2008</b>
Avaric (av), <b>0122</b>	Haitian (ht), <b>0820</b>	Burmese (my), <b>1325</b>	Tigrinya (ti), <b>2009</b>
Aymara (ay), <b>0125</b>	Hungarian (hu), <b>0821</b>	Nauru (na), <b>1401</b>	Turkmen (tk), <b>2011</b>
Azerbaijani (az), <b>0126</b>	Armenian (hy), <b>0825</b>	Bokmal (nb), <b>1402</b>	Tagalog (tl), <b>2012</b>
Bashkir (ba), <b>0201</b>	Herero (hz), <b>0826</b>	Ndebele, North (nd), <b>1404</b>	Tswana (tn), <b>2014</b>
Belarusian (be), <b>0205</b>	Interlingua (ia), <b>0901</b>	Nepali (ne), <b>1405</b>	Tonga (to), <b>2015</b>
Bulgarian (bg), <b>0207</b>	Indonesian (id), <b>0904</b>	Ndonga (ng), <b>1407</b>	Turkish (tr), <b>2018</b>
Bihari (bh), <b>0208</b>	Interlingue (ie), <b>0905</b>	Nynorsk (nn), <b>1414</b>	Tsonga (ts), <b>2019</b>
Bislama (bi), <b>0209</b>	Igbo (ig), <b>0907</b>	Norwegian (no), <b>1415</b>	Tatar (tt), <b>2020</b>
Bambara (bm), <b>0213</b>	Sichuan Yi (ii), <b>0909</b>	Ndebele, South (nr), <b>1418</b>	Twi (tw), <b>2023</b>
Bengali (bn), <b>0214</b>	Inupiaq (ik), <b>0911</b>	Navajo, Navaho (nv), <b>1422</b>	Tahitian (ty), <b>2025</b>
Tibetan (bo), <b>0215</b>	Ido (io), <b>0915</b>	Chichewa (ny), <b>1425</b>	Uighur, Uyghur (ug), <b>2107</b>
Breton (br), <b>0218</b>	Icelandic (is), <b>0919</b>	Occitan (oc), <b>1503</b>	Ukrainian (uk), <b>2111</b>
Bosnian (bs), <b>0219</b>	Inuktitut (iu), <b>0921</b>	Ojibwa (oj), <b>1510</b>	Urdu (ur), <b>2118</b>
Catalan (ca), <b>0301</b>	Javanese (jv), <b>1022</b>	Oromo (om), <b>1513</b>	Uzbek (uz), <b>2126</b>
Chechen (ce), <b>0305</b>	Georgian (ka), <b>1101</b>	Oriya (or), <b>1518</b>	Venda (ve), <b>2205</b>
Chamorro (ch), <b>0308</b>	Kongo (kg), <b>1107</b>	Ossetian (os), <b>1519</b>	Vietnamese (vi), <b>2209</b>
Corsican (co), <b>0315</b>	Kikuyu, Gikuyu (ki), <b>1109</b>	Panjabi, Punjabi (pa), <b>1601</b>	Volapük (vo), <b>2215</b>
Cree (cr), <b>0318</b>	Kuanyama (kj), <b>1110</b>	Pali (pi), <b>1609</b>	Walloon (wa), <b>2301</b>
Czech (cs), <b>0319</b>	Kazakh (kk), <b>1111</b>	Polish (pl), <b>1612</b>	Wolof (wo), <b>2315</b>
Church Slavik (cu), <b>0321</b>	Kalaallisut (kl), <b>1112</b>	Pashto, Pushto (ps), <b>1619</b>	Xhosa (xh), <b>2408</b>
Chuvash (cv), <b>0322</b>	Central Khmer (km), <b>1113</b>	Quechua (qu), <b>1721</b>	Yiddish (yi), <b>2509</b>
Welsh (cy), <b>0325</b>	Kannada (kn), <b>1114</b>	Romansh (rm), <b>1813</b>	Yoruba (yo), <b>2515</b>
Danish (da), <b>0401</b>	Kanuri (kr), <b>1118</b>	Rundi (rn), <b>1814</b>	Zhuang, Chuang (za), <b>2601</b>
Divehi (dv), <b>0422</b>	Kashmiri (ks), <b>1119</b>	Romanian (ro), <b>1815</b>	Zulu (zu), <b>2621</b>



# Additional Information

## Specifications

### General

Power source .....	14.4 V DC (10.8 V to 15.1 V allowable)
Grounding system .....	Negative type
Maximum current consumption .....	10.0 A
Dimensions (W × H × D):	
D	
Chassis .....	178 mm × 100 mm × 165 mm (7 in. × 3-7/8 in. × 6-1/2 in.)
Nose .....	171 mm × 97 mm × 18 mm (6-3/4 in. × 3-7/8 in. × 3/4 in.)
(AVH-P4200DVD)	
Nose .....	171 mm × 97 mm × 7 mm (6-3/4 in. × 3-7/8 in. × 1/4 in.)
(AVH-P3200DVD/AVH-P3200BT)	
Weight .....	2.9 kg (6.4 lbs)
(AVH-P4200DVD)	
Weight .....	1.8 kg (4.0 lbs)
(AVH-P3200DVD/AVH-P3200BT)	

### Display

Screen size/aspect ratio .....	6.95 inch wide/16:9 (effective display area: 156.4 × 81.7 mm)
(AVH-P4200DVD)	
Screen size/aspect ratio .....	5.8 inch wide/16:9 (effective display area: 128.4 × 70.9 mm)
(AVH-P3200DVD/AVH-P3200BT)	
Pixels .....	345 600 (1 440 × 240)
Display method .....	TFT active matrix, driving type
Color system .....	NTSC
Durable temperature range (power off) .....	-20 °C to +80 °C

### Audio

Maximum power output .....	50 W × 4 70 W × 1/2 Ω (for subwoofer)
Continuous power output .....	22 W × 4 (50 Hz to 15 000 Hz, 5 % THD, 4 Ω load, both channels driven)
Load impedance .....	4 Ω (4 Ω to 8 Ω (2 Ω for 1 ch) allowable)
Preout maximum output level .....	4.0 V

### Equalizer (8-Band Graphic Equalizer):

Frequency .....	40/80/200/400/1k/2.5k/8k/10k Hz
Gain .....	±12 dB

### HPPF:

Frequency .....	50/63/80/100/125 Hz
Slope .....	-12 dB/oct

### Subwoofer (mono):

Frequency .....	50/63/80/100/125 Hz
Slope .....	-18 dB/oct
Gain .....	+6 dB to -24 dB
Phase .....	Normal/Reverse

### Bass boost:

Gain .....	+12 dB to 0 dB
------------	----------------

### DVD Player

System .....	DVD video, Video CD, CD, WMA, MP3, AAC, DivX, JPEG system
Usable discs .....	DVD video, Video CD, CD, CD-R/RW, DVD-R/RW/RDL
Region number .....	1
Frequency response .....	5 Hz to 44 000 Hz (with DVD, at sampling frequency 96 kHz)
Signal-to-noise ratio .....	96 dB (1 kHz) (IEC-A network) (RCA level)
Output level:	
Video .....	1.0 Vp-p/75 Ω (±0.2 V)
Number of channels .....	2 (stereo)
MP3 decoding format .....	MPEG-1 & 2 Audio Layer 3
WMA decoding format .....	Ver. 7, 7.1, 8, 9, 10, 11 (2ch audio) (Windows Media Player)
AAC decoding format .....	MPEG-4 AAC (iTunes encoded only) (.m4a) (Ver. 8.2 and earlier)
DivX decoding format .....	Home Theater Ver. 3, 4, 5.2, 6 (.avi, .divx)

### USB

USB standard specification .....	USB 1.1, USB 2.0 full speed
Maximum current supply .....	500 mA
USB Class .....	MSC (Mass Storage Class)
File system .....	FAT16, FAT32
MP3 decoding format .....	MPEG-1 & 2 Audio Layer 3
WMA decoding format .....	Ver. 7, 7.1, 8, 9, 10, 11 (2ch audio) (Windows Media Player)
AAC decoding format .....	MPEG-4 AAC (iTunes encoded only) (Ver. 8.2 and earlier)

## Additional Information

DivX decoding format ..... Home Theater Ver. 3, 4, 5, 2,  
6 (.avi, .divx)

### SD

Compatible physical format

..... Version 1.10

Maximum memory capacity

..... 2 GB

File system ..... FAT12, FAT16, FAT32

MP3 decoding format ..... MPEG-1 & 2 Audio Layer 3

WMA decoding format ..... Ver. 7, 7.1, 8, 9, 10, 11 (2ch  
audio)

(Windows Media Player)

AAC decoding format ..... MPEG-4 AAC (iTunes en-  
coded only)

(Ver. 8.2 and earlier)

DivX decoding format ..... Home Theater Ver. 3, 4, 5, 2,  
6 (.avi, .divx)

### FM tuner

Frequency range ..... 87.9 MHz to 107.9 MHz

Usable sensitivity ..... 9 dBf (0.8  $\mu$ V/75  $\Omega$  mono,  
S/N: 30 dB)

Signal-to-noise ratio ..... 72 dB (IEC-A network)

### AM tuner

Frequency range ..... 530 kHz to 1710 kHz (10  
kHz)

Usable sensitivity ..... 25  $\mu$ V (S/N: 20 dB)

Signal-to-noise ratio ..... 62 dB (IEC-A network)

### Bluetooth

(AVH-P3200BT)

Version ..... Bluetooth 2.0 certified

Output power ..... +4 dBm Max.  
(Power class 2)

### CEA2006 Specifications



Power output ..... 14 W RMS  $\times$  4 Channels (4  
 $\Omega$  and  $\leq$  1 % THD+N)

S/N ratio ..... 91 dBA (reference: 1 W into  
4  $\Omega$ )



### Note

Specifications and the design are subject to mod-  
ifications without notice. ■









*Register your product at  
Enregistrez votre produit au  
Registre su producto en*

**<http://www.pioneerelectronics.com>**

*See "Visit our website" page  
Voir la page "Visitez notre site Web"  
Consulte la página sobre "Visite nuestro sitio Web"*

**PIONEER CORPORATION**

4-1, MEGURO 1-CHOME, MEGURO-KU  
TOKYO 153-8654, JAPAN

**PIONEER ELECTRONICS (USA) INC.**

P.O. Box 1540, Long Beach, California 90801-1540, U.S.A.  
TEL: (800) 421-1404

**PIONEER EUROPE NV**

Haven 1087, Keetberglaan 1, B-9120 Melsele, Belgium/Belgique  
TEL: (0) 3/570.05.11

**PIONEER ELECTRONICS ASIACENTRE PTE. LTD.**

253 Alexandra Road, #04-01, Singapore 159936  
TEL: 65-6472-7555

**PIONEER ELECTRONICS AUSTRALIA PTY. LTD.**

178-184 Boundary Road, Braeside, Victoria 3195, Australia  
TEL: (03) 9586-6300

**PIONEER ELECTRONICS OF CANADA, INC.**

300 Allstate Parkway, Markham, Ontario L3R 0P2, Canada  
TEL: 1-877-283-5901  
TEL: 905-479-4411

**PIONEER ELECTRONICS DE MEXICO, S.A. de C.V.**

Bldv.Manuel Avila Camacho 138 10 piso  
Col.Lomas de Chapultepec, Mexico, D.F. 11000  
TEL: 55-9178-4270

**先鋒股份有限公司**

總公司：台北市中山北路二段44號13樓  
電話：(02) 2521-3588

**先鋒電子（香港）有限公司**

香港九龍尖沙嘴海港城世界商業中心  
9樓901-6室  
電話：(0852) 2848-6488

Published by Pioneer Corporation.  
Copyright © 2009 by Pioneer Corporation.  
All rights reserved.

Printed in Thailand

<CRB3174-A/N> UC

<KOMZX> <09L00000>