

TYPE OF EXHIBIT: TEST REPORT

FCC PART: 2.1033 (c)(14)

MANUFACTURER: RITRON, INC.
505 West Carmel Drive
Carmel, IN 46032

MODELS: RQA-152, RQT-152

TYPE OF UNIT: VHF-FM Voice Message Transmitter

FCC ID: AIERIT32-152

DATE: October 20, 2011

The following is a list of attached exhibits required by the Federal Communications Commission for the application to and grant of FCC Type Acceptance. All tests are per TIA-603-D (2010) where applicable.

Test Equipment List	2.947 (d)	pg 2
Description of Measurement Facility	2.947 (d)	pg 3
Radio Frequency Power Output	2.1046 (a)	pg 4
Transmitter Audio Overall Response	2.1047 (a)	pg 6
Transmitter Audio Lowpass Filter	2.1047 (a)	pg 7
Modulation Limiting	2.1047 (b)	pg 8
Emissions Designator	2.1049 (c)(1)	pg 10
Occupied Bandwidth	2.1049 (c)(1) 90.210(d)	pg 11
Spurious Emissions at Antenna Terminals	2.1051	pg 13
Field Strength of Spurious Emissions	2.1053 (b)	pg 14
Frequency Stability vs. Temperature	2.1055 (a)	pg 16
Frequency Stability vs. Voltage	2.1055 (d)	pg 17
Transient Frequency Behavior	90.214	pg 18

TYPE OF EXHIBIT: TEST EQUIPMENT LIST
FCC PART: 2.947 (d)
MANUFACTURER: RITRON, INC.
 505 West Carmel Drive
 Carmel, IN 46032
MODELS: RQA-152, RQT-152
TYPE OF UNIT: VHF-FM Voice Message Transmitter
FCC ID: AIERIT32-152
DATE: October 20, 2011

The measured data in this report was obtained using one or more of the following pieces of equipment. The particular equipment used in any one test is detailed in the procedure for that test.

<u>ITEM</u>	<u>MANUFACTURER</u>	<u>MODEL NO.</u>	<u>SERIAL NO.</u>	<u>Last Cal</u>	<u>EXP Cal</u>
Comms Test Set	Aeroflex	IFR COM-120B	500009331	15 SEP 2010	15 SEP 2011
Signal generator	Hewlett-Packard	8657B	3315V04378	19 APR 2011	19 APR 2012
Spectrum Analyzer	Advantest	R3265A	75060189	21 OCT 2010	21 OCT 2011

Support equipment:

<u>ITEM</u>	<u>MANUFACTURER</u>	<u>MODEL NO.</u>	<u>SERIAL NO.</u>
Power Supply	BK Precision	1630	146-03508
Digital Oscilloscope	Philips	PM-3335	DM648004
Digital Multimeter	Fluke	179	82800086
Dipole Antenna	Electro-Metrics	EM-6924	241
Dipole Antenna	Electro-Metrics	BDA-25	8-101
Log Periodic Antenna	Electro-Metrics	LPA-25	8-102
Gain horn	EMCO	3105	
Temperature Chamber	Associated Laboratories	ELH-0.5-LC	N/A
Thermocouple	Omega	7035-J-225	8504
272 MHz high pass filter	Ritron		
30dB Power Attenuator	Bird	8306-300-N	N/A
10dB Attenuator	ELCOM	AT-51-10	N/A

Signed: 
 Michael A. Pickard - Project Engineer

TYPE OF EXHIBIT: DESCRIPTION OF MEASUREMENT FACILITY
FCC PART: 2.947(d)
MANUFACTURER: RITRON, INC.
505 West Carmel Drive
Carmel, IN 46032
MODELS: RQA-152, RQT-152
TYPE OF UNIT: VHF-FM Voice Message Transmitter
FCC ID: AIERIT32-152
DATE: October 20, 2011

The ERP and field strength of spurious emissions measurements filed with this application were made on a site certified by RITRON, Inc. Data pertaining to this site are on file with the FCC and Industry Canada.

This site is used on a continuing basis exclusively by RITRON, Inc. and is utilized only for RF field strength measurements of equipment designed and manufactured by RITRON, Inc. It is not used for measurements by, or for, any other party on a contract basis or otherwise.

All other measurements were taken at RITRON's engineering laboratory in Carmel, IN.

Signed: *Michael A. Pickard*
Michael A. Pickard - Project Engineer



Ritron Test Site

TYPE OF EXHIBIT: RADIO FREQUENCY POWER OUTPUT

FCC PART: 2.1046(a)

MANUFACTURER: RITRON, INC.
505 West Carmel Drive
Carmel, IN 46032

MODELS: RQA-152, RQT-152

TYPE OF UNIT: VHF-FM Voice Message Transmitter

FCC ID: AIERIT32-152

DATE: October 17, 2011

PROCEDURE:

1. The RQT-152 was aligned for transmitter operation at 2W power level per the tune-up procedure for frequencies representing the low, middle, and upper range of the desired operating band.
2. Power was supplied to the RQT-152 at the EXTERNAL POWER input by a BK Precision 1630 power supply set to 10 and 13.5 volts to represent the specified input voltage range.
3. The RQT-152 was connected to an IFR COM-120A Test Set used to measure the RF carrier power. The input to the Test Set provides a resistive 50-ohm termination at the frequencies and power levels used for this test.
4. A Fluke 179 multimeter was used to measure the I_{TX} transmitter current that supplies the driver and final RF amplifier stages.
5. Measurements were taken at the lower, middle and upper band edge frequencies.
6. Power was supplied to the RQT-152 at the BATTERY input by a BK Precision 1630 power supply set to 6 and 9 volts to represent the specified input voltage range.
7. Steps 3 through 5 were repeated with power supplied through the BATTERY input.

TYPE OF EXHIBIT: RADIO FREQUENCY POWER OUTPUT
FCC PART: 2.1046(a)
MANUFACTURER: RITRON, INC.
 505 West Carmel Drive
 Carmel, IN 46032
MODELS: RQA-152, RQT-152
TYPE OF UNIT: VHF-FM Voice Message Transmitter
FCC ID: AIERIT32-152
DATE: October 17, 2011

RESULTS:

EXTERNAL POWER

<u>Frequency (MHz)</u>	<u>Input (VDC)</u>	<u>+V_{TX} (VDC)</u>	<u>I_{TX} (mA)</u>	<u>Power (W)</u>
150.025	10	7.24	581	1.98
	13.5	7.24	581	1.98
156.025	10	7.52	463	1.98
	13.5	7.52	463	1.98
165.025	10	7.60	495	1.96
	13.5	7.60	495	1.96

BATTERY

<u>Frequency (MHz)</u>	<u>Input (VDC)</u>	<u>+V_{TX} (VDC)</u>	<u>I_{TX} (mA)</u>	<u>Power (mW)</u>
150.025	6	5.80	457	0.96
	9	7.24	581	1.98
156.025	6	5.80	345	1.14
	9	7.52	463	1.98
165.025	6	5.80	369	1.10
	9	7.60	495	1.96

Signed: *Michael A. Pickard*
 Michael A. Pickard - Project Engineer

TYPE OF TEST: TRANSMITTER AUDIO OVERALL RESPONSE

FCC PART: 2.1047 (a)

MANUFACTURER: RITRON, INC.
505 West Carmel Drive
Carmel, IN 46032

MODELS: RQA-152, RQT-152

TYPE OF UNIT: VHF-FM Voice Message Transmitter

FCC ID: AIERIT32-152

DATE: October 20, 2011

PROCEDURE:

The output of an IFR COM-120B audio function generator was applied to the input of the RQT-152 audio processing circuitry at J300 with the analog voice storage IC in feedthrough mode at a constant input level of .35 VP to prevent limiting at any frequency.

The output frequency response was calculated as $-20 \log(V_{in}/V_{ref})$ where the reference is 1 kHz.

RESULTS:

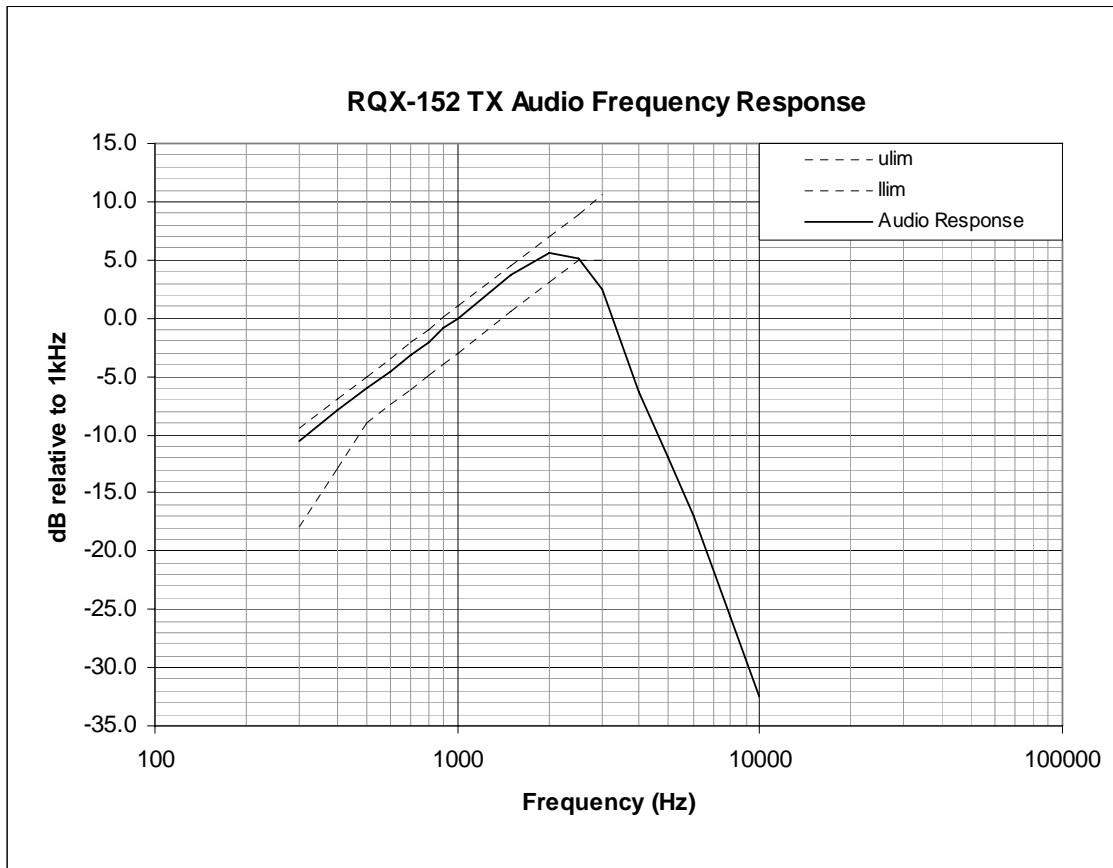

Signed:

Michael A. Pickard - Project Engineer

TYPE OF TEST: TRANSMITTER AUDIO LOWPASS FILTER

FCC PART: 2.1047 (a)

MANUFACTURER: RITRON, INC.
505 West Carmel Drive
Carmel, IN 46032

MODELS: RQA-152, RQT-152

TYPE OF UNIT: VHF-FM Voice Message Transmitter

FCC ID: AIERIT32-152

DATE: October 20, 2011

PROCEDURE:

The output of an IFR COM-120B audio function generator was applied to the input of the RQT-152 audio lowpass filter at R331 through a 0.1 μ F capacitor at a constant input level of 2.0 VP to keep the filter in a linear (not limiting) mode. The output frequency response was calculated as $-20 \log(V_{in}/V_{ref})$ where the reference is 1 kHz.

RESULTS:

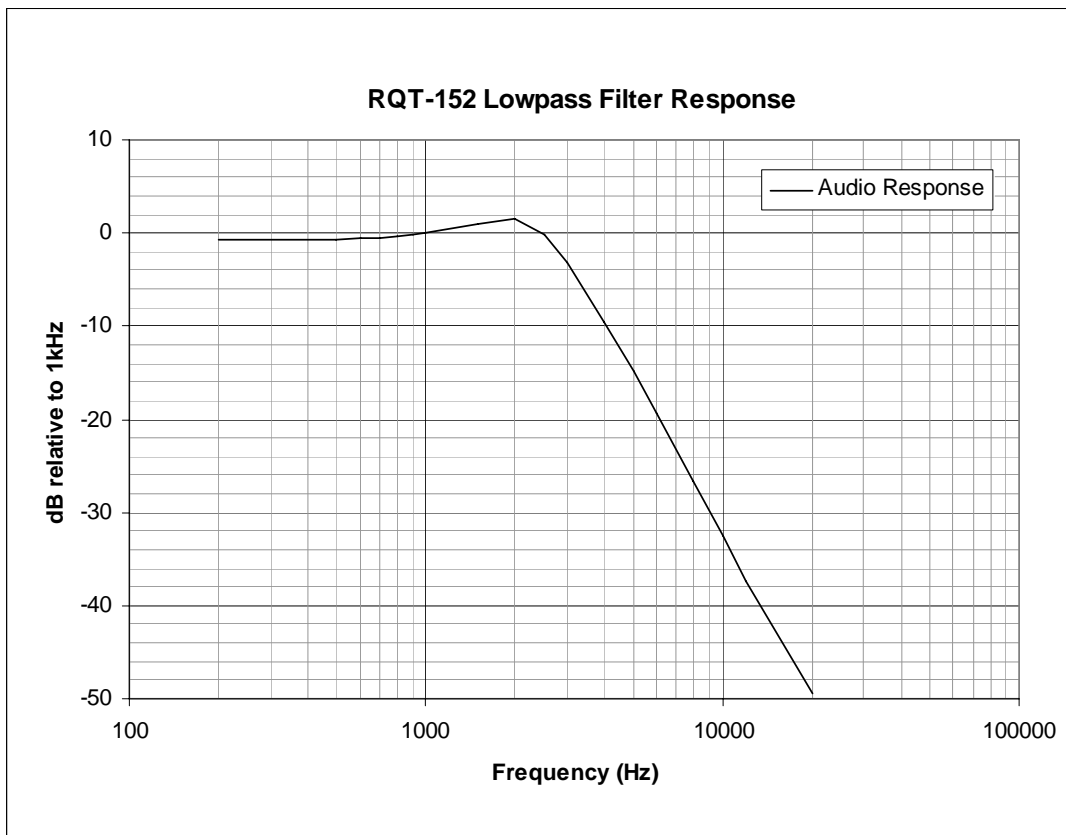

Signed: Michael A. Pickard
Michael A. Pickard - Project Engineer

TYPE OF TEST: MODULATION LIMITING

FCC PART: 2.1047 (b)

MANUFACTURER: RITRON, INC.
505 West Carmel Drive
Carmel, IN 46032

MODELS: RQA-152, RQT-152

TYPE OF UNIT: VHF-FM Voice Message Transmitter

FCC ID: AIERIT32-152

DATE: October 20, 2011

PROCEDURE:

1. The RQT-152 was adjusted for a narrowband 100% deviation of +/- 2.5 kHz at 1900 Hz per the tune-up procedure. The radio was programmed for transmitter operation on 156.025 MHz, a frequency representing the middle of the desired operating range.
2. The output of an IFR COM-120B audio function generator was applied to the input of the RQT-152 audio processing circuitry at J300 with the analog voice storage IC in feedthrough mode.
3. The output of the generator was adjusted from 0.1 VP to 2.5 VP at frequencies from 500 to 3000 Hz.
4. An IFR COM-120B was used to measure FM deviation. The resulting deviations were recorded as a percentage of the rated system deviation of +/- 2.5 kHz for narrowband operation.
5. Steps 2 – 4 were repeated at frequencies representing the lower and upper range of the desired operation band.
6. The attached chart displays the narrowband (12.5 kHz) response at 156.025 MHz.

TYPE OF TEST: MODULATION LIMITING
FCC PART: 2.1047 (b)
MANUFACTURER: RITRON, INC.
505 West Carmel Drive
Carmel, IN 46032
MODELS: RQA-152, RQT-152
TYPE OF UNIT: VHF-FM Voice Message Transmitter
FCC ID: AIERIT32-152
DATE: October 20, 2011

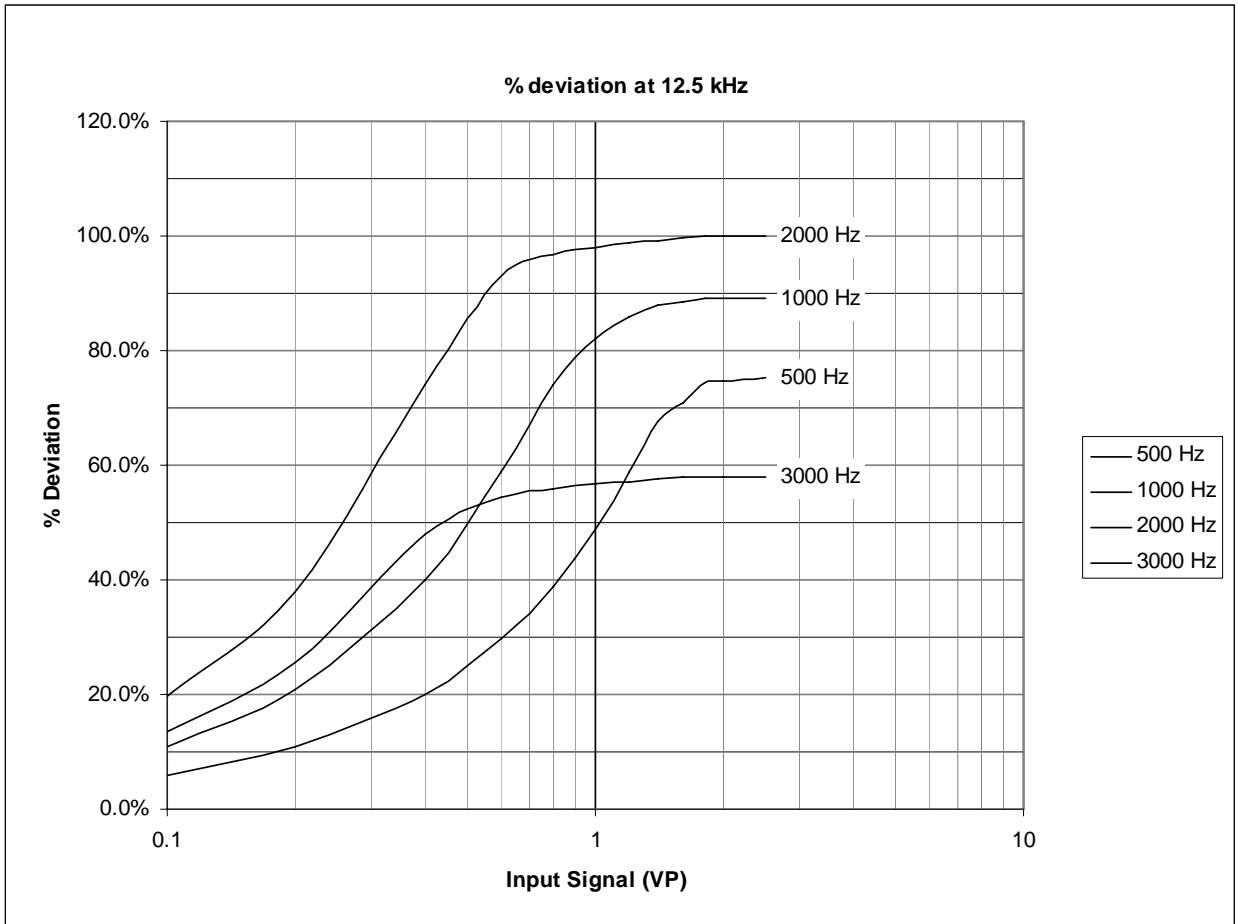

Signed: Michael A. Pickard
Michael A. Pickard - Project Engineer

TYPE OF TEST: EMISSIONS DESIGNATOR
FCC PART: 2.1049 (c)
MANUFACTURER: RITRON, INC.
505 West Carmel Drive
Carmel, IN 46032
MODELS: RQA-152, RQT-152
TYPE OF UNIT: VHF-FM Voice Message Transmitter
FCC ID: AIERIT32-152
DATE: October 20, 2011

CALCULATIONS:

By Carson's rule, the occupied bandwidth for an FM signal may be calculated by:

$BW = 2(f_{\Delta} + f_m)$ where f_{Δ} is the frequency deviation and f_m is the modulating frequency.

The necessary bandwidth for the narrowband voice channel is:

Maximum modulation frequency (f_m) in kHz	= 3
Maximum deviation (f_{Δ}) in kHz	= 2.5
Necessary bandwidth for narrowband in kHz	= $2(2.5 + 3) = 11$

Narrowband emissions designator applied for is 11K0F3E.

TYPE OF TEST: OCCUPIED BANDWIDTH
FCC PART: 2.1049 (c)(1) per 90.210 (d)
MANUFACTURER: RITRON, INC.
505 West Carmel Drive
Carmel, IN 46032
MODELS: RQA-152, RQT-152
TYPE OF UNIT: VHF-FM Voice Message Transmitter
FCC ID: AIERIT32-152
DATE: October 18, 2011

PROCEDURE:

1. The RQT-152 was programmed for transmitter operation on 150.025 MHz, a frequency representing the lower range of the desired operating band. The transmitter was adjusted for a deviation of +/- 2.5 kHz at 1900 Hz for narrowband operation. The photo shows voice occupied bandwidth for 12.5 kHz bandwidth operation with a 2500 Hz audio tone.
2. The RF output of the RQT-152 was measured with a HP435B wattmeter at 2W. Power was set with +12 VDC in at J500 EXT PWR terminals.
3. The unit's antenna port was connected to the Advantest R3265A spectrum analyzer through a Bird 8306-300-N 30dB attenuator.
4. The output of an IFR COM-120B audio function generator was applied to the input of the RQT-152 audio processing circuitry with the analog voice storage IC in feed through mode. The frequency of the audio signal generator was set to 2500 Hz and the output adjusted to a level 16 dB greater than that necessary to produce 50% of the rated system deviation at the frequency of maximum response.
5. The spectrum analyzer was centered on 150.025 MHz and the sidebands were capture in max hold mode on the spectrum analyzer. The appropriate narrow band emission mask was also displayed.

Frequency of maximum response:	1900 Hz
Level for 50% system deviation:	0.24 VP
Level for 50% system deviation + 16DB:	1.51 VP
6. Steps 2 - 5 were repeated at frequencies representing the middle and upper range of the desired operating band.
7. The captured spectrum analyzer display at 150.025 MHz is included in this exhibit, representing the response with the highest sidebands.

TYPE OF TEST: 12.5 kHz VOICE OCCUPIED BANDWIDTH

FCC PART: 2.1049 (c)(1) per 90.210 (b)(d)

MANUFACTURER: RITRON, INC.
505 West Carmel Drive
Carmel, IN 46032

MODELS: RQA-152, RQT-152

TYPE OF UNIT: VHF-FM Voice Message Transmitter

FCC ID: AIERIT32-152

DATE: October 18, 2011

DATA: 12.5 kHz channel with 2500 Hz tone.

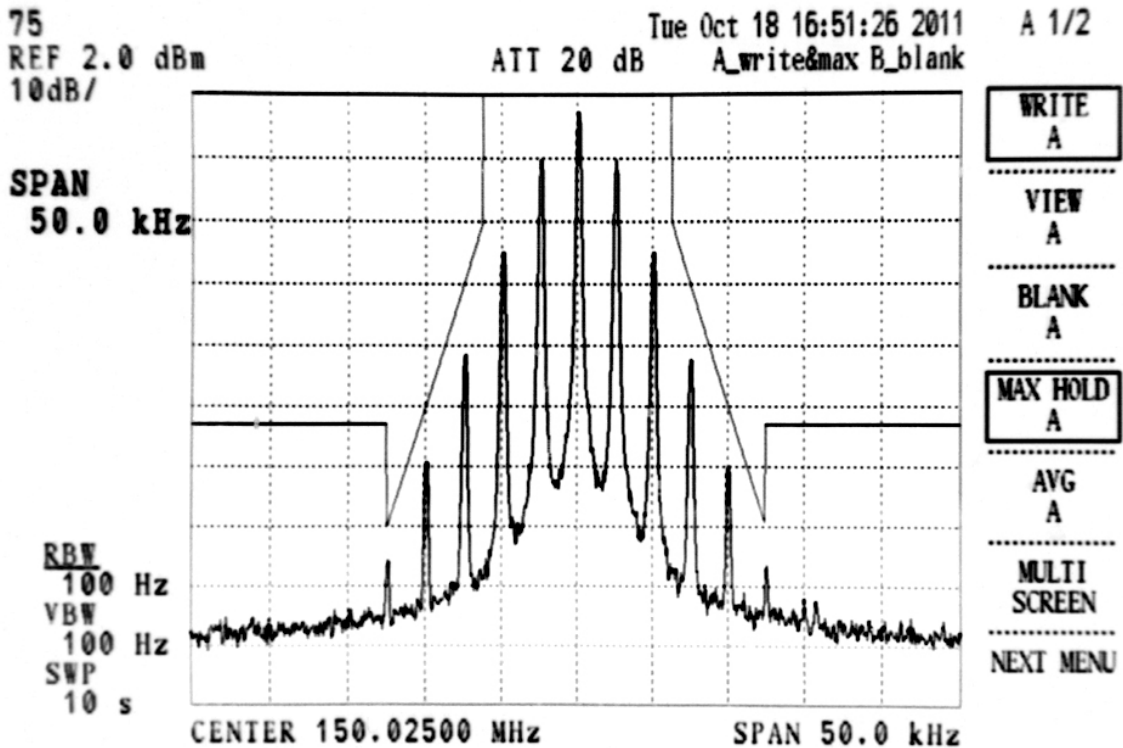

Signed:

Michael A. Pickard

Michael A. Pickard - Project Engineer

TYPE OF TEST: SPURIOUS EMISSIONS AT ANTENNA TERMINALS

FCC PART: 2.1051

MANUFACTURER: RITRON, INC.
505 West Carmel Drive
Carmel, IN 46032

MODELS: RQA-152, RQT-152

TYPE OF UNIT: VHF-FM Voice Message Transmitter

FCC ID: AIERIT32-152

DATE: October 18, 2011

PROCEDURE:

1. The RQT-152 was programmed for transmitter operation on low, middle and high frequencies.
2. The supply voltage was set to +12 VDC through J500 EXT PWR terminals..
3. The transmitter was modulated by a 2500 Hz tone at an input level 16 dB greater than that necessary to produce 50 percent modulation as specified in FCC Part 2.1049 (c)(1).
4. The RQT-152 antenna terminal was connected to the input of an Advantest R3265A Spectrum Analyzer through a 272 MHz high-pass filter used to attenuate the carrier. The measured insertion loss of the high-pass filter and cable loss is listed on the data sheet.
5. The spectrum was searched from 8 MHz to the 10th harmonic of the operating frequency. All unreported emissions are more than 20 dB below the FCC limit.

RESULTS:

Power Output: 2W

FCC Attenuation per Part 90.210(d)(3): 53.0 dBc

Multiple of Carrier	Emmission Frequency MHz	Analyzer Reading dBm	Atten/HPF Correction Factor-dB	Spurious Power dBm	Spurious Power dBc	FCC Limit dBc	dB below FCC Limit
Carrier	150.025						
Carrier 4	156.025						
7	624.100	-38.59	0.63	-37.96	-70.96	-53.0	17.96
	1092.175	-32.84	2.00	-30.84	-63.84	-53.0	10.84
Carrier	165.025						

Signed:

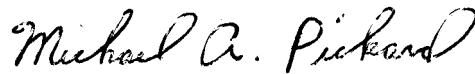

Michael A. Pickard - Project Engineer

TYPE OF TEST: FIELD STRENGTH OF SPURIOUS EMISSIONS

FCC PART: 2.1053

MANUFACTURER: RITRON, INC.
505 West Carmel Drive
Carmel, IN 46032

MODELS: RQA-152, RQT-152

TYPE OF UNIT: VHF-FM Voice Message Transmitter

FCC ID: AIERIT32-152

DATE: October 12, 2011

PROCEDURE:

1. Field strength of spurious radiation of the RQT-152 was taken at the RITRON, Inc. 3-meter test site, details of which are on file with the FCC. The measurement was via the substitution method.
2. The RQT-152 and RQA-152 were aligned for transmitter operation on 150.025 MHz, 156.025 MHz, and 165.025 MHz at the rated 2W transmitter output power. These 3 frequencies represent the low, middle, and upper range of the desired operating band. The radio was powered by 9 internal AA batteries for a 12VDC supply.
3. The RQT-152 was terminated at the antenna port with the Ritron AFB-1545 antenna include with the product. The RQA-152 was terminated at the antenna port with the standard internal antenna include with the product. (The user can connect other antennas, however.)
3. All field strength measurements were made with the Advantest R3265A Spectrum Analyzer connected to the Electro-Metrics LPA-25 log periodic or EMCO horn receiving antenna.
4. A calibrated ½-wave dipole antenna was substituted at the radio side of the range driven by a known power level from an HP 8657B RF signal generator to produce a known ERP at each harmonic. The receiving antenna was oriented both vertically and horizontally and reference measurements were taken at each harmonic. Cable loss from generator to the dipole was taken into account.
5. For each emission, the height and polarization of the field strength measuring antenna and orientation of the RQT-152 and RQA-152 were varied to find maximum field strength.
6. The spectrum was searched up to the 10th harmonic of the transmit frequency. All non-harmonics were less than 20 dB below the FCC limits specified in Part 90.210(d)(3). All harmonics with greater than 20 dB margin were not reported.

TYPE OF TEST: FIELD STRENGTH OF SPURIOUS EMISSIONS
FCC PART: 2.1053
MODELS: RQA-152, RQT-152
FCC ID: AIERIT32-152
DATE: October 12, 2011

Power Output: 2 W

FCC Attenuation per Part 90.210(d)(3): 53.0 dBc

Multiple of Carrier	Emission Frequency MHz	Measured Reading @ -20 dBm	Vertical					
			Substitution Reading @ -20 dBm	Spurious Reading dBm	Spurious Level dBc	FCC Limit dBC	dB below FCC Limit	
6	150.025	-21.5	-50.0					
	900.150	-24.2	-57.1	-71.7	-71.8	-53.0	18.8	
7	1050.175	-24.4	-62.3	-76.1	-71.3	-53.0	18.3	
6	156.025	-21.8	-48.3					
	936.150	24.3	-58.4	-72.1	-70.9	-53.0	17.9	
7	1092.175	-24.1	-63.2	-74.7	-68.6	-53.0	15.6	
4	165.025	-21.7	-45.9					
	660.100	-23.1	-54.2	-71.0	-72.9	-53.0	19.9	
6	990.150	-24.3	-58.6	-72.5	-71.3	-53.0	18.3	
7	1155.175	-24.5	-67.4	-81.8	-71.9	-53.0	18.9	
8	1320.200	-25.1	-68.3	-79.3	-69.1	-53.0	16.1	

Multiple of Carrier	Emission Frequency MHz	Measured Reading @ -20 dBm	Horizontal					
			Substitution Reading @ -20 dBm	Spurious Reading dBm	Spurious Level dBc	FCC Limit dBC	dB below FCC Limit	
6	150.025	-21.5	-47.6					
	900.150	-24.2	-56.7	-66.6	-67.1	-53.0	14.1	
8	1200.200	-24.4	-68.0	-76.2	-65.5	-53.0	12.5	
6	156.025	-21.8	-47.4					
	936.150	-24.3	-57.1	-74.7	-74.8	-53.0	21.8	
4	165.025	-21.7	-42.9					
	660.100	-23.1	-50.8	-65.2	-70.6	-53.0	17.6	
5	825.125	-23.7	-54.3	-68.8	-71.3	-53.0	18.3	
8	1320.200	-25.1	-68.2	-80.1	-70.0	-53.0	17.0	

Signed:

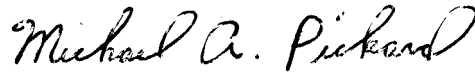

Michael A. Pickard - Project Engineer

TYPE OF TEST: FREQUENCY STABILITY VS. TEMPERATURE
FCC PART: 2.1055 (a)(1)
MANUFACTURER: RITRON, INC.
505 West Carmel Drive
Carmel, IN 46032
MODELS: RQA-152, RQT-152
TYPE OF UNIT: VHF-FM Voice Message Transmitter
FCC ID: AIERIT32-152
DATE: October 20, 2011

PROCEDURE:

1. The RQT-152 was programmed for operation at 2W on 156.025 MHz. Frequency determining circuits are the same for all frequencies within the desired operating band.
2. The unit was placed inside a Delta Design Model 3900 CL temperature chamber and was powered by 9 internal AA batteries for a +12 VDC supply. The antenna terminal was connected to the input of an IFR COM-120B RF communications test set used to measure frequency of the carrier. A Triplet model 320-G/P thermocouple was placed inside the chamber to measure temperature.
3. Frequency was measured at +25°C and recorded as a reference frequency.
4. The temperature was raised to +30°C for 30 minutes, at which time the transmitter frequency was measured and recorded.
5. Step 4 was repeated in +10°C increments up to +60°C.
6. The unit was allowed to return naturally back to the ambient room temperature of +25°C.
7. The temperature was lowered to +20°C for 30 minutes, at which time the transmitter frequency was measured and recorded.
8. Step 7 was repeated in -10°C increments down to -30°C.
9. The frequency remained within the 1.5 ppm specified across the full -30°C to +60°C temperature range.

Temp C	Frequency (MHz)	Error (ppm)
-30	156.025014	0.07
-20	156.025020	0.11
-10	156.025001	-0.01
0	156.024967	-0.23
10	156.024981	-0.14
20	156.025000	-0.02
30	156.025013	0.06
40	156.025010	0.04
50	156.025022	0.12
60	156.025000	-0.02
25	156.025003	

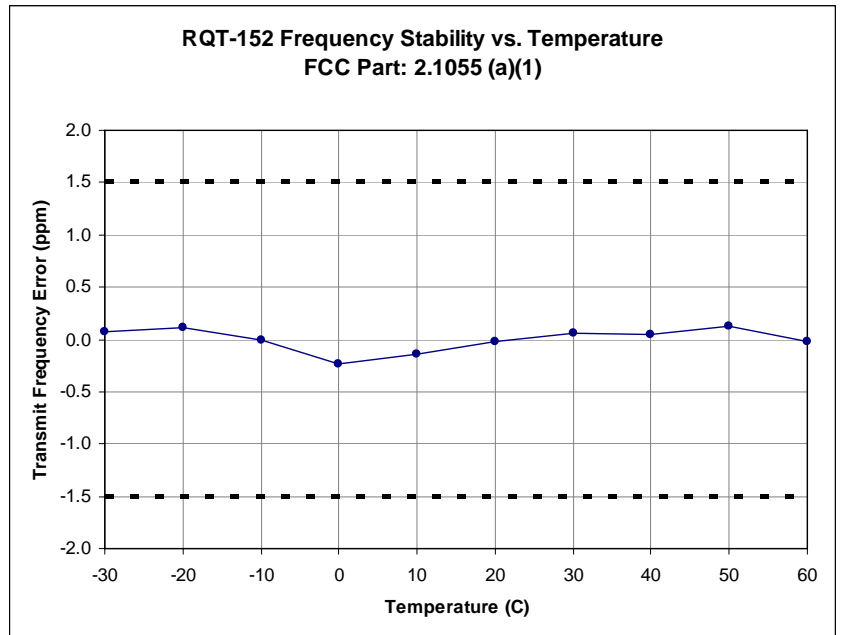

Signed: Michael A. Pickard
Michael A. Pickard - Project Engineer

TYPE OF TEST: FREQUENCY STABILITY VS. VOLTAGE

FCC PART: 2.1055 (d)(1)

MANUFACTURER: RITRON, INC.
505 West Carmel Drive
Carmel, IN 46032

MODELS: RQA-152, RQT-152

TYPE OF UNIT: VHF-FM Voice Message Transmitter

FCC ID: AIERIT32-152

DATE: October 20, 2011

PROCEDURE:

1. The RQT-152 was programmed for operation at 156.025 MHz. Frequency determining circuits are the same for all frequencies within the desired operating band.
2. The RQT-152 antenna terminal was connected to the input of an IFR COM-120B communications test set, used to measure frequency of the carrier.
3. A BK Precision Model 1630 power supply was used to apply supply voltage at the battery input.
4. The radio was put into transmit mode and the measured frequency at 7.5 VDC was used as a reference.
5. Frequency was checked from 85% of minimum to 115% of maximum specified operating voltage.
Minimum of $6.0 \times 0.85 = 5.1 \text{ V}^*$ Maximum of $9 \times 1.15 = 10.35 \text{ V}$.
* Note that the radio transmitter is inhibited at voltages below 5.4 VDC.
6. The BK Precision Model 1630 power supply was used then to apply supply voltage at the external power input.
7. The radio was put into transmit mode and the measured frequency at 12 VDC was used as a reference.
8. Frequency was checked from 85% of minimum to 115% of maximum specified operating voltage.
Minimum of $11.0 \times 0.85 = 9.35 \text{ V}$ Maximum of $15 \times 1.15 = 17.25 \text{ V}$.

VDC	Condition	Frequency (Mhz)	Error (ppm)
5.40 *	Battery @ 85%	156.025004	0.02
7.50	Battery Nominal	156.025001	0.00
10.35	Battery @ 115%	156.025001	0.00
9.35	External Power @ 85%	156.025001	0.00
12.00	External Power Nominal	156.025001	0.00
19.55	External Power @ 115%	156.025001	0.00

Signed:



Michael A. Pickard - Project Engineer

TYPE OF TEST: TRANSIENT FREQUENCY BEHAVIOR

FCC PART: 90.214

MANUFACTURER: RITRON, INC.
505 West Carmel Drive
Carmel, IN 46032

MODELS: RQA-152, RQT-152

TYPE OF UNIT: VHF-FM Voice Message Transmitter

FCC ID: AIERIT32-152

DATE: October 14, 2011

PROCEDURE:

1. The RQT-152 was aligned for transmitter operation at 2W power level per the tune-up procedure for frequencies representing the low, middle, and upper range of the desired operating band.
2. Power was supplied to the RQT-152 at the BATTERY input by a BK Precision 1630 power supply set to 9 VDC.
3. The test equipment was connected per the following diagram:

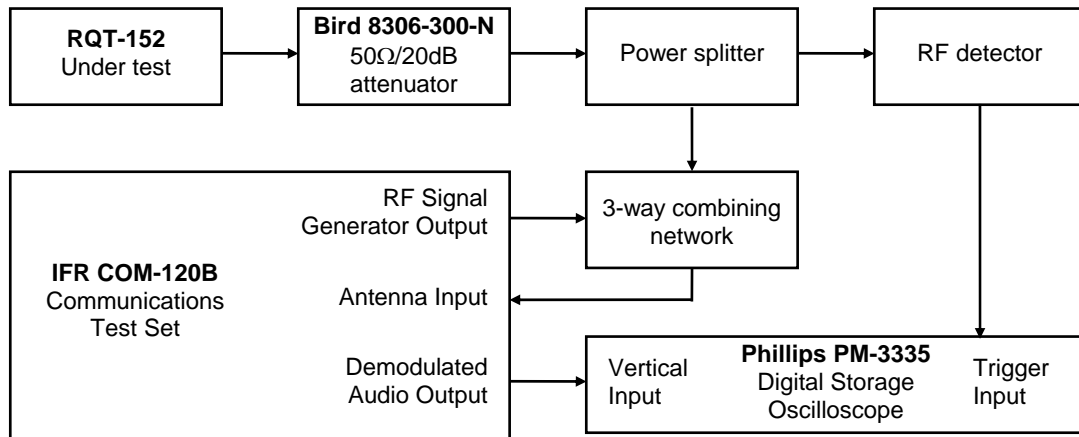

4. The IFR COM-120B receiver was set to measure FM deviation with the audio bandwidth set at ≤ 20 Hz to 15 kHz and the RF frequency set to 165.025 MHz.
5. The RQT-152 transmitter under test was turned on and the IFR COM-120B Spectrum Analyzer was used to measure the RF power level through the test network.
6. The RQT-152 transmitter was turned off.
7. The IFR COM-120B RF signal generator was set to the transmit frequency at an RF level 30 dB below that measured in step 3, modulated with a 1 kHz tone at ± 12.5 kHz deviation.
8. The Phillips PM-3335 digital oscilloscope horizontal sweep rate was set to 10 mS per division. The vertical amplitude control was adjusted to display the 1000 Hz demodulated audio from the signal generator at ± 4 divisions (3.125 kHz/div), vertically centered on the screen.

9. The Phillips PM-3335 digital oscilloscope was set to trigger at 1 division from the left side of the display when the RF detector senses RF power from the RQT-152 transmitter.
10. The RQT-152 transmitter is turned on and the resulting waveform on the oscilloscope display was stored and plotted. The FCC limits per Part 90.214 were added to the plot in the same manner illustrated in EIA-603-B Part 2.2.19.3. The resulting plot is labeled "Switch ON" and shows compliance with FCC Part 90.214.
11. The Phillips PM-3335 digital oscilloscope was set to trigger at 1 division from the right side of the display when the RF detector senses loss of RF power from the RQT-152 transmitter.
12. The RQT-152 transmitter is turned off and the resulting waveform on the oscilloscope display was stored and plotted. The FCC limits per Part 90.214 were added to the plot in the same manner illustrated in EIA-603-B Part 2.2.19.3. The resulting plot is labeled "Switch OFF" and shows compliance with FCC Part 90.214.
13. The test procedure was repeated for frequencies at the low, middle, and upper range of the desired operating band. The worst case response occurred at 165.025 MHz, the upper edge of the specified operating band, with the resulting display included in this exhibit.

TYPE OF TEST: TRANSIENT FREQUENCY BEHAVIOR
FCC PART: 90.214
MANUFACTURER: RITRON, INC.
505 West Carmel Drive
Carmel, IN 46032
MODELS: RQA-152, RQT-152
TYPE OF UNIT: VHF-FM Voice Message Transmitter
FCC ID: AIERIT32-152
DATE: October 14, 2011

SWITCH ON CONDITION

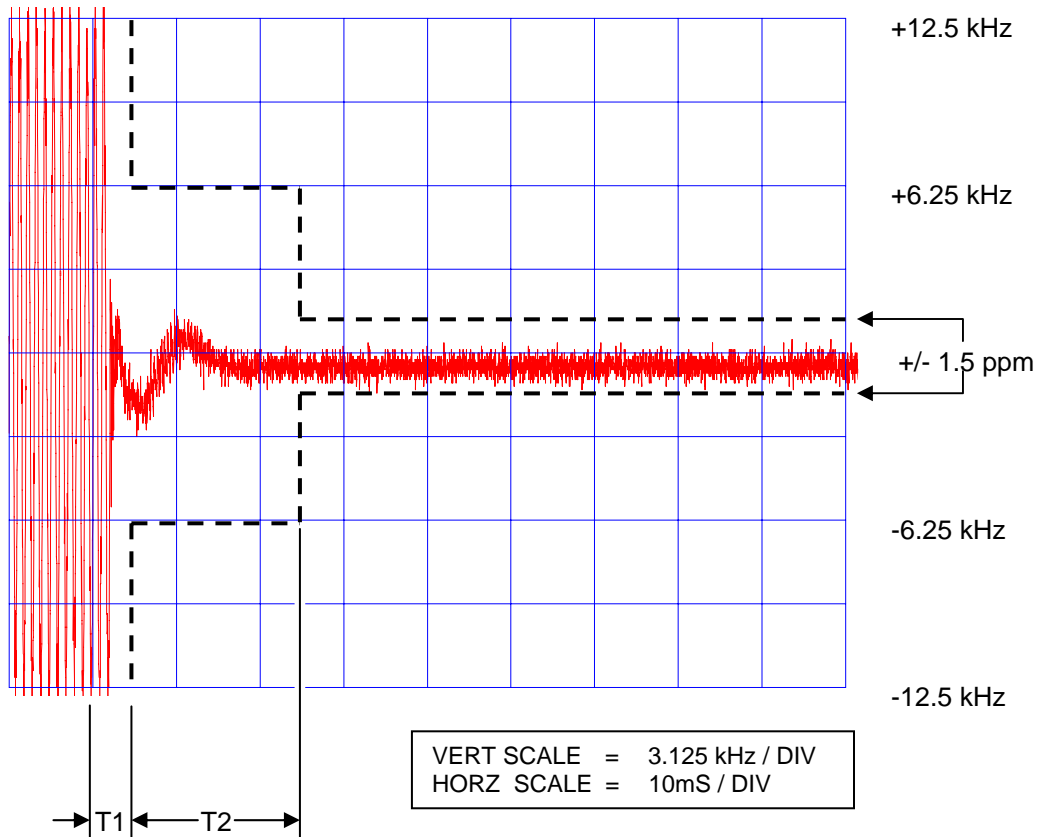

Signed: Michael A. Pickard
Michael A. Pickard - Project Engineer

TYPE OF TEST: TRANSIENT FREQUENCY BEHAVIOR
FCC PART: 90.214
MANUFACTURER: RITRON, INC.
505 West Carmel Drive
Carmel, IN 46032
MODELS: RQA-152, RQT-152
TYPE OF UNIT: VHF-FM Voice Message Transmitter
FCC ID: AIERIT32-152
DATE: October 14, 2011

SWITCH OFF CONDITION

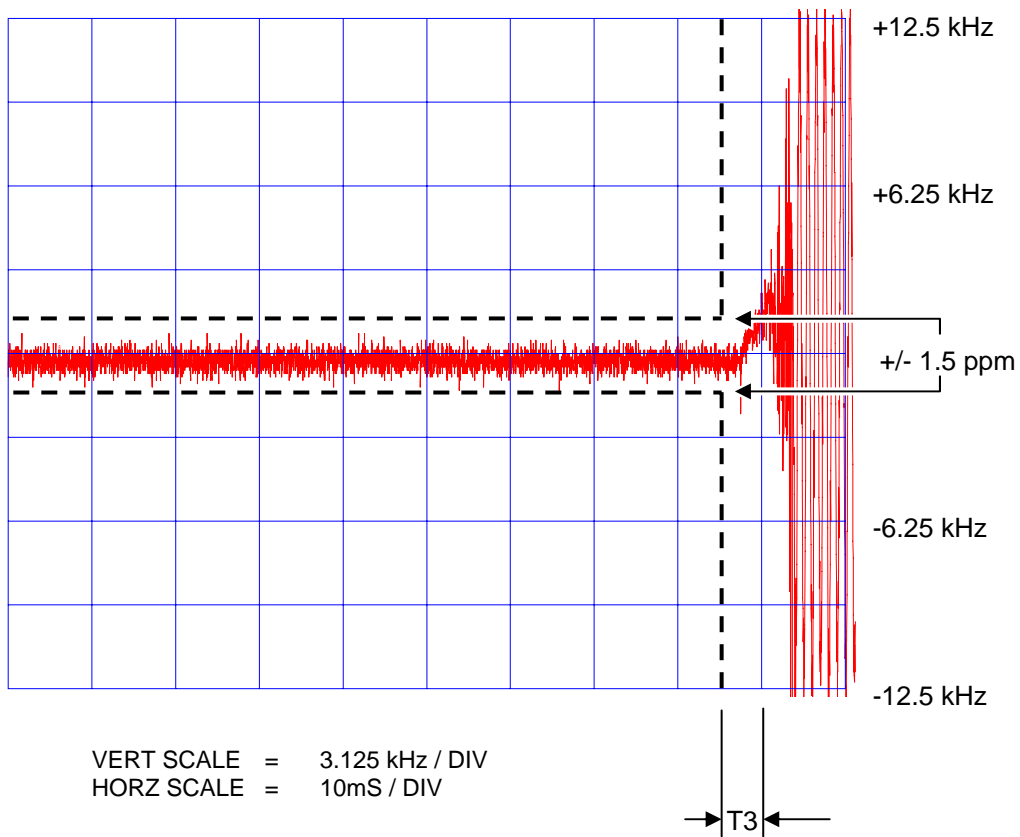

Signed: Michael A. Pickard
Michael A. Pickard - Project Engineer