



3000 Bristol Circle,  
Oakville, Ontario, Canada  
L6H 6G4

Telephone (905) 829-1570  
Facsimile (905) 829-8050

Website: [www.ultratech-labs.com](http://www.ultratech-labs.com)  
Email: [vic@ultratech-labs.com](mailto:vic@ultratech-labs.com)

Jan. 28, 2002

Icom America, Inc.  
2380 116<sup>th</sup> Ave. N.E.  
Bellevue, Washington 98004  
USA

**Attn.:** Mr. Masaaki Takahashi

**Subject:** Certification Testing in Accordance with FCC 47 CFR, Parts 2 & 90 - Licensed Non-Broadcast Mobile Radio Transceivers for Occupational Use Operating in the Frequency Band 136-174 MHz (12.5 kHz and 25 kHz Channel Spacings).

**Product:** Mobile VHF FM Transceiver  
**Model:** IC-F520  
**FCC ID:** AFJIC-F520

Dear Mr. Takahashi,

The product sample has been tested in accordance with **FCC 47 CFR, Parts 2 and 90 - Licensed Non-Broadcast Mobile Radio Transceivers for Occupational Use Operating in the Frequency Band 136-174 MHz (12.5 kHz and 25 kHz Channel Spacings)**, and the results and observation were recorded in the engineering report, Our File No.: ICOM35-FTX

Enclosed you will find copy of the engineering report. If you have any queries, please do not hesitate to contact us.

Yours truly,



Tri Minh Luu, P.Eng  
Vice President - Engineering

Encl.

# ENGINEERING TEST REPORT

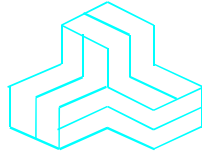

**Mobile VHF FM Transceiver**  
**Model No.: IC-F520**  
**FCC ID: AFJIC-F520**

*Applicant:* **Icom Incorporated**  
1-1-32, Kamiminami  
Hirano-ku, Osaka  
Japan, 547-0003

*Tested in Accordance With*

**Federal Communications Commission (FCC)**  
**47 CFR, Parts 2 & 90**  
**Licensed Non-Broadcast Mobile Radio Transceivers for Occupational Use**  
**Operating in the Frequency Band 136-174 MHz (12.5 kHz and 25 kHz Channel Spacings)**

**UltraTech's File No.: ICOM35-FTX**

This Test report is Issued under the Authority of  
Tri M. Luu, Professional Engineer,  
Vice President of Engineering  
UltraTech Group of Labs

Date: Jan. 28, 2002



Report Prepared by: Tri Luu

Issued Date: Jan. 28, 2002

Tested by: Hung Trinh, RFI/EMI Technician

Test Dates: Jan. 23-28, 2001

*The results in this Test Report apply only to the sample(s) tested, and the sample tested is randomly selected.*

## UltraTech

3000 Bristol Circle, Oakville, Ontario, Canada, L6H 6G4  
Telephone (905) 829-1570 Facsimile (905) 829-8050

Website: [www.ultratech-labs.com](http://www.ultratech-labs.com) Email: [vic@ultratech-labs.com](mailto:vic@ultratech-labs.com)

## TABLE OF CONTENTS

<b>EXHIBIT 1. SUBMITTAL CHECK LIST .....</b>	<b>1</b>
<b>EXHIBIT 2. INTRODUCTION.....</b>	<b>2</b>
2.1. SCOPE.....	2
2.2. RELATED SUBMITTAL(S)/GRANT(S).....	2
2.3. NORMATIVE REFERENCES.....	2
<b>EXHIBIT 3. PERFORMANCE ASSESSMENT .....</b>	<b>3</b>
3.1. CLIENT INFORMATION.....	3
3.2. EQUIPMENT UNDER TEST (EUT) INFORMATION.....	3
3.3. EUT'S TECHNICAL SPECIFICATIONS .....	4
3.4. LIST OF EUT'S PORTS.....	4
<b>EXHIBIT 4. EUT OPERATION CONDITIONS AND CONFIGURATIONS DURING TESTS.....</b>	<b>5</b>
4.1. CLIMATE TEST CONDITIONS .....	5
4.2. OPERATIONAL TEST CONDITIONS & ARRANGEMENT FOR TEST SIGNALS .....	5
TEST SAMPLE SETUP .....	6
<b>EXHIBIT 5. SUMMARY OF TEST RESULTS.....</b>	<b>7</b>
5.1. LOCATION OF TESTS.....	7
5.2. APPLICABILITY & SUMMARY OF EMC EMISSION TEST RESULTS.....	7
5.3. MODIFICATIONS INCORPORATED IN THE EUT FOR COMPLIANCE PURPOSES.....	7
5.4. DEVIATION OF STANDARD TEST PROCEDURES.....	7
<b>EXHIBIT 6. MEASUREMENTS, EXAMINATIONS &amp; TEST DATA FOR EMC EMISSIONS.....</b>	<b>8</b>
6.1. TEST PROCEDURES .....	8
6.2. MEASUREMENT UNCERTAINTIES.....	8
6.3. MEASUREMENT EQUIPMENT USED: .....	8
6.4. ESSENTIAL/PRIMARY FUNCTIONS AS DECLARED BY THE MANUFACTURER .....	8
6.5. RF POWER OUTPUT @ FCC 2.1046 & 90.205 .....	9
6.5.1. <i>Limits @ FCC 90.205</i> .....	9
6.5.2. <i>Method of Measurements</i> .....	9
6.5.3. <i>Test Equipment List</i> .....	9
6.5.4. <i>Test Arrangement</i> .....	9
6.5.5. <i>Test Data</i> .....	10
6.6. RF EXPOSURE REQUIRMENTS @ 1.1310 & 2.1091.....	11
6.6.1. <i>Limits</i> .....	11
6.6.2. <i>Method of Measurements</i> .....	11
6.6.3. <i>Test Data</i> .....	13
6.7. FREQUENCY STABILITY @ FCC 2.1055 & 90.213.....	14
6.7.1. <i>Limits @ FCC 90.213</i> .....	14
6.7.2. <i>Method of Measurements</i> .....	14
6.7.3. <i>Test Equipment List</i> .....	14
6.7.4. <i>Test Arrangement</i> .....	14
6.7.5. <i>Test Data</i> .....	15
6.8. 99% OCCUPIED BANDWIDTH & EMISSION MASK @ FCC 2.1049, 90.209 & 90.210 .....	16
6.8.1. <i>Limits @ FCC 90.209 &amp; 90.210</i> .....	16

### ULTRATECH GROUP OF LABS

3000 Bristol Circle, Oakville, Ontario, Canada L6H 6G4  
Tel. #: 905-829-1570, Fax. #: 905-829-8050, Email: [vic@ultratech-labs.com](mailto:vic@ultratech-labs.com), Website: <http://www.ultratech-labs.com>

File #: ICOM35-FTX  
Jan. 28, 2002

- Assessed by ITI (UK) Competent Body, NVLAP (USA) Accreditation Body & ACA/AUSTEL (Australia), VCCI (Japan)
- Accredited by Industry Canada (Canada) under ACC-LAB (Europe/Canada MRA and APEC/Canada MRA)
- Recognized/Listed by FCC (USA)
- All test results contained in this engineering test report are traceable to National Institute of Standards and Technology (NIST)

6.8.2.	<i>Method of Measurements</i> .....	16
6.8.3.	<i>Test Equipment List</i> .....	16
6.8.4.	<i>Test Arrangement</i> .....	16
6.8.5.	<i>Test Data</i> .....	17
6.9.	AUDIO FREQUENCY RESPONSE @ FCC 2.1047(A) AND 90.242(B)(8) .....	18
6.9.1.	<i>Limits @ FCC 2.1047(a) and 90.242(b)(8)</i> .....	18
6.9.2.	<i>Method of Measurements</i> .....	18
6.9.3.	<i>Test Equipment List</i> .....	18
6.9.4.	<i>Test Arrangement</i> .....	18
6.9.5.	<i>Test Data</i> .....	19
6.10.	MODULATION LIMITING @ FCC 2.1047(B) & 90.210 .....	23
6.10.1.	<i>Limits @ FCC 2.1047(b) and 90.210</i> .....	23
6.10.2.	<i>Method of Measurements</i> .....	23
6.10.3.	<i>Test Equipment List</i> .....	23
6.10.4.	<i>Test Arrangement</i> .....	23
6.10.5.	<i>Test Data</i> .....	24
6.11.	TRANSMITTER ANTENNA POWER SPURIOUS/HARMONIC CONDUCTED EMISSIONS @ FCC 90.210 .....	28
6.11.1.	<i>Limits @ 90.210</i> .....	28
6.11.2.	<i>Method of Measurements</i> .....	28
6.11.3.	<i>Test Equipment List</i> .....	28
6.11.4.	<i>Test Arrangement</i> .....	28
6.11.5.	<i>Test Data</i> .....	29
6.12.	TRANSMITTER SPURIOUS/HARMONIC RADIATED EMISSIONS @ FCC 90.210 .....	32
6.12.1.	<i>Limits @ FCC 90.210</i> .....	32
6.12.2.	<i>Method of Measurements</i> .....	32
6.12.3.	<i>Test Equipment List</i> .....	32
6.12.4.	<i>Test Data</i> .....	32
6.13.	TRANSIENT FREQUENCY BEHAVIOR @ 90.214 .....	36
6.13.1.	<i>Limits</i> .....	36
6.13.2.	<i>Method of Measurements</i> .....	36
6.13.3.	<i>Test Equipment List</i> .....	37
6.13.4.	<i>Test Arrangement</i> .....	37
6.13.5.	<i>Test Data</i> .....	38
<b>EXHIBIT 7. MEASUREMENT UNCERTAINTY .....</b>		<b>40</b>
7.1.	RADIATED EMISSION MEASUREMENT UNCERTAINTY .....	40
<b>EXHIBIT 8. MEASUREMENT METHODS .....</b>		<b>41</b>
8.1.	CONDUCTED POWER MEASUREMENTS .....	41
8.2.	RADIATED POWER MEASUREMENTS (ERP & EIRP) USING SUBSTITUTION METHOD .....	42
8.2.1.	<i>Maximizing RF Emission Level (E-Field)</i> .....	42
8.2.2.	<i>Measuring the EIRP of Spurious/Harmonic Emissions using Substitution Method</i> .....	43
8.3.	FREQUENCY STABILITY .....	45
8.4.	EMISSION MASK .....	46
8.5.	SPURIOUS EMISSIONS (CONDUCTED) .....	46
8.6.	TRANSIENT FREQUENCY BEHAVIOR .....	47

**ULTRATECH GROUP OF LABS**

3000 Bristol Circle, Oakville, Ontario, Canada L6H 6G4  
 Tel. #: 905-829-1570, Fax. #: 905-829-8050, Email: [vic@ultratech-labs.com](mailto:vic@ultratech-labs.com), Website: <http://www.ultratech-labs.com>

File #: ICOM35-FTX  
 Jan. 28, 2002

- Assessed by ITI (UK) Competent Body, NVLAP (USA) Accreditation Body & ACA/AUSTEL (Australia), VCCI (Japan)
- Accredited by Industry Canada (Canada) under ACC-LAB (Europe/Canada MRA and APEC/Canada MRA)
- Recognized/Listed by FCC (USA)
- All test results contained in this engineering test report are traceable to National Institute of Standards and Technology (NIST)

## EXHIBIT 1. SUBMITTAL CHECK LIST

Annex No.	Exhibit Type	Description of Contents	Quality Check (OK)
--	Test Report	<ul style="list-style-type: none"> <li>Exhibit 1: Submittal check lists</li> <li>Exhibit 2: Introduction</li> <li>Exhibit 3: Performance Assessment</li> <li>Exhibit 4: EUT Operation and Configuration during Tests</li> <li>Exhibit 5: Summary of test Results</li> <li>Exhibit 6: Measurement Data</li> <li>Exhibit 7: Measurement Uncertainty</li> <li>Exhibit 8: Measurement Methods</li> </ul>	OK
1	Test Data Plots	<ul style="list-style-type: none"> <li>Occupied Bandwidth, Plots # 1 to 6</li> <li>Emission Mask D, Plots # 7 to 9</li> <li>Emission Mask B, Plot # 9 to 12</li> <li>Spurious Emissions at Antenna Terminals, Plots # 13 to 24</li> <li>Transient Frequency Behavior, Plots # 25 to 32</li> </ul>	OK OK OK OK OK
2	Test Setup Photos	Radiated Emissions Test Setup Photos, Photo # 1 to 2	OK
3	External Photos of EUT	External EUT Photos	OK
4	Internal Photos of EUT	Internal EUT Photos	OK
5	Cover Letters	Letter from Ultratech for Certification Request	OK
6	Attestation Statements	<ul style="list-style-type: none"> <li>Letter from the Applicant to appoint Ultratech to act as an agent</li> <li>Letter from the Applicant to request for Confidentiality Filing</li> <li>Confirmation to meet the FCC Rules, Parts 90.203(e) and (g)</li> <li>Blocked Frequency</li> </ul>	OK
7	ID Label/Location Info	ID Label Location of ID Label	OK
8	Block Diagram	Block Diagram	OK
9	Schematic Diagrams	<ul style="list-style-type: none"> <li>Schematic Diagrams</li> </ul>	OK
10	Parts List/Tune Up Info	<ul style="list-style-type: none"> <li>Parts List</li> </ul>	OK
11	Operational Description	RF Exposure Info	OK
12	RF Exposure Info	Not applicable	OK
13	Users Manual	Icom Instruction Manual	OK

### ULTRATECH GROUP OF LABS

3000 Bristol Circle, Oakville, Ontario, Canada L6H 6G4  
 Tel. #: 905-829-1570, Fax. #: 905-829-8050, Email: [vic@ultratech-labs.com](mailto:vic@ultratech-labs.com), Website: <http://www.ultratech-labs.com>

File #: ICOM35-FTX  
 Jan. 28, 2002

- Assessed by ITI (UK) Competent Body, NVLAP (USA) Accreditation Body & ACA/AUSTEL (Australia), VCCI (Japan)
- Accredited by Industry Canada (Canada) under ACC-LAB (Europe/Canada MRA and APEC/Canada MRA)
- Recognized/Listed by FCC (USA)
- All test results contained in this engineering test report are traceable to National Institute of Standards and Technology (NIST)

## EXHIBIT 2. INTRODUCTION

### 2.1. SCOPE

<b>Reference:</b>	FCC Parts 2 and 90
<b>Title:</b>	Telecommunication – 47 Code of Federal Regulations (CFR), Parts 2 and 90
<b>Purpose of Test:</b>	To gain FCC Certification Authorization for Radio Operating in the Frequency Band 136-174 MHz (12.5 kHz and 25 kHz Channel Spacings).
<b>Test Procedures:</b>	Both conducted and radiated emissions measurements were conducted in accordance with American National Standards Institute ANSI C63.4 - American National Standard for Methods of Measurement of Radio-Noise Emissions from Low-Voltage Electrical and Electronic Equipment in the Range of 9 kHz to 40 GHz.

### 2.2. RELATED SUBMITTAL(S)/GRANT(S)

None

### 2.3. NORMATIVE REFERENCES

Publication	Year	Title
FCC CFR Parts 0-19 & 80-End	2000	Code of Federal Regulations – Telecommunication
ANSI C63.4	1992	American National Standard for Methods of Measurement of Radio-Noise Emissions from Low-Voltage Electrical and Electronic Equipment in the Range of 9 kHz to 40 GHz
CISPR 22 & EN 55022	1997 1998	Limits and Methods of Measurements of Radio Disturbance Characteristics of Information Technology Equipment
CISPR 16-1		Specification for Radio Disturbance and Immunity measuring apparatus and methods

#### ULTRATECH GROUP OF LABS

3000 Bristol Circle, Oakville, Ontario, Canada L6H 6G4  
Tel. #: 905-829-1570, Fax. #: 905-829-8050, Email: [vic@ultratech-labs.com](mailto:vic@ultratech-labs.com), Website: <http://www.ultratech-labs.com>

File #: ICOM35-FTX  
Jan. 28, 2002

- Assessed by ITI (UK) Competent Body, NVLAP (USA) Accreditation Body & ACA/AUSTEL (Australia), VCCI (Japan)
- Accredited by Industry Canada (Canada) under ACC-LAB (Europe/Canada MRA and APEC/Canada MRA)
- Recognized/Listed by FCC (USA)
- All test results contained in this engineering test report are traceable to National Institute of Standards and Technology (NIST)

## EXHIBIT 3. PERFORMANCE ASSESSMENT

### 3.1. CLIENT INFORMATION

APPLICANT	
<b>Name:</b>	Icom Incorporated
<b>Address:</b>	1-1-32, Kamiminami Hirano-ku, Oaska Japan, 547-0003
<b>Contact Person:</b>	Mr. Takashi Aoki Phone #: +81-66-793-5302 Fax #: +81-66-793-0013 Email Address: <a href="mailto:export@icom.co.jp">export@icom.co.jp</a>

MANUFACTURER	
<b>Name:</b>	Icom Incorporated
<b>Address:</b>	1-1-32, Kamiminami Hirano-ku, Oaska Japan, 547-0003
<b>Contact Person:</b>	Mr. Takashi Aoki Phone #: +81-66-793-5302 Fax #: # +81-66-793-0013 Email Address: <a href="mailto:export@icom.co.jp">export@icom.co.jp</a>

### 3.2. EQUIPMENT UNDER TEST (EUT) INFORMATION

The following information (with the exception of the Date of Receipt) has been supplied by the applicant.

<b>Brand Name:</b>	Icom Incorporated
<b>Product Name:</b>	Mobile VHF FM Transceiver
<b>Model Name or Number:</b>	IC-F520
<b>Serial Number:</b>	Pre-production sample
<b>Type of Equipment:</b>	Licensed Non-Broadcast Mobile Radio Communication Equipment for Occupational Use.
<b>External Power Supply:</b>	N/A
<b>Transmitting/Receiving Antenna Type:</b>	Non-Integral. The antenna will be mounted outside of the vehicle.
<b>Accessory</b>	ICOM Condenser Microphone, Model HM-100N

#### ULTRATECH GROUP OF LABS

3000 Bristol Circle, Oakville, Ontario, Canada L6H 6G4  
 Tel. #: 905-829-1570, Fax. #: 905-829-8050, Email: [vic@ultratech-labs.com](mailto:vic@ultratech-labs.com), Website: <http://www.ultratech-labs.com>

File #: ICOM35-FTX  
 Jan. 28, 2002

- Assessed by ITI (UK) Competent Body, NVLAP (USA) Accreditation Body & ACA/AUSTEL (Australia), VCCI (Japan)
- Accredited by Industry Canada (Canada) under ACC-LAB (Europe/Canada MRA and APEC/Canada MRA)
- Recognized/Listed by FCC (USA)
- All test results contained in this engineering test report are traceable to National Institute of Standards and Technology (NIST)

### 3.3. EUT'S TECHNICAL SPECIFICATIONS

TRANSMITTER	
Equipment Type:	Mobile
Intended Operating Environment:	[ x ] Commercial [ x ] Light Industry & Heavy Industry
Power Supply Requirement:	13.6 Vdc, 5.1 A
Nominal RF Output Conducted Power Rating:	25.0 Watts hi & 2.5 Watts lo
Operating Frequency Range:	136-174MHz
RF Output Impedance:	50 Ohms
Channel Spacing:	12.5 kHz and 25 kHz
Frequency Tolerance	2.5ppm
Emission Designation*:	11K0F3E and 16K0F3E
Antenna Connector Type:	N Female Connector

\* For an average case of commercial telephony, the Necessary Bandwidth is calculated as follows:

For FM Voice Modulation:

Channel Spacing = 12.5 kHz, D = 2.5 kHz max. allowed, K = 1, M = 3 kHz

$$B_n = 2M + 2DK = 2(3) + 2(2.5)(1) = \mathbf{11 \text{ kHz}}$$

Emission Designation: 11K0F3E

Channel Spacing = 25 kHz, D = 5 kHz max. allowed, K = 1, M = 3 kHz

$$B_n = 2M + 2DK = 2(3) + 2(5)(1) = \mathbf{16 \text{ kHz}}$$

Emission Designation: 16K0F3E

### 3.4. LIST OF EUT'S PORTS

Port Number	EUT's Port Description	Number of Identical Ports	Connector Type	Cable Type (Shielded/Non-shielded)
1	Antenna Connector	1	N Female Connector	Shielded Coaxial
2	SP/MIC	1	Speaker /Microphone Jack	Shielded

**NOTE:**

*Ports of the EUT which in normal operation were connected to ancillary equipment through interconnecting cables via a representative interconnecting cable to simulate the input/output characteristics. RF input/output was correctly terminated to the 50 Ohms RF Load.*

**ULTRATECH GROUP OF LABS**

3000 Bristol Circle, Oakville, Ontario, Canada L6H 6G4  
 Tel. #: 905-829-1570, Fax. #: 905-829-8050, Email: [vic@ultratech-labs.com](mailto:vic@ultratech-labs.com), Website: <http://www.ultratech-labs.com>

File #: ICOM35-FTX  
 Jan. 28, 2002

- Assessed by ITI (UK) Competent Body, NVLAP (USA) Accreditation Body & ACA/AUSTEL (Australia), VCCI (Japan)
- Accredited by Industry Canada (Canada) under ACC-LAB (Europe/Canada MRA and APEC/Canada MRA)
- Recognized/Listed by FCC (USA)
- All test results contained in this engineering test report are traceable to National Institute of Standards and Technology (NIST)



## EXHIBIT 4. EUT OPERATION CONDITIONS AND CONFIGURATIONS DURING TESTS

### 4.1. CLIMATE TEST CONDITIONS

The climate conditions of the test environment are as follows:

Temperature:	21°C
Humidity:	51%
Pressure:	102 kPa
Power input source:	13.6 Vdc, 5.1 A

### 4.2. OPERATIONAL TEST CONDITIONS & ARRANGEMENT FOR TEST SIGNALS

<b>Operating Modes:</b>	The transmitter was operated in a continuous transmission mode with the carrier modulated as specified in the Test Data.
<b>Special Test Software:</b>	None
<b>Special Hardware Used:</b>	None
<b>Transmitter Test Antenna:</b>	The EUT is tested with the transmitter antenna port terminated to a 50 Ohms RF Load.

<b>Transmitter Test Signals</b>	
<b>Frequency Band(s):</b>	Near lowest, near middle & near highest frequencies of each frequency band(s) that the transmitter covers:
<ul style="list-style-type: none"> <li>▪ 136-174 MHz</li> </ul>	<ul style="list-style-type: none"> <li>• 136.10, 155.10 and 173.90 MHz</li> </ul>
<b>Transmitter Wanted Output Test Signals:</b>	
<ul style="list-style-type: none"> <li>▪ RF Power Output (measured maximum output power):</li> <li>▪ Normal Test Modulation:</li> <li>▪ Modulating Signal Source:</li> </ul>	26.3 Watts hi & 2.7 Watts lo (measured at antenna terminal) FM modulation with 2.5 kHz sine wave signal. External

#### ULTRATECH GROUP OF LABS

3000 Bristol Circle, Oakville, Ontario, Canada L6H 6G4  
 Tel. #: 905-829-1570, Fax. #: 905-829-8050, Email: [vic@ultratech-labs.com](mailto:vic@ultratech-labs.com), Website: <http://www.ultratech-labs.com>

File #: ICOM35-FTX  
 Jan. 28, 2002

- Assessed by ITI (UK) Competent Body, NVLAP (USA) Accreditation Body & ACA/AUSTEL (Australia), VCCI (Japan)
- Accredited by Industry Canada (Canada) under ACC-LAB (Europe/Canada MRA and APEC/Canada MRA)
- Recognized/Listed by FCC (USA)
- All test results contained in this engineering test report are traceable to National Institute of Standards and Technology (NIST)

### 4.3. TEST SAMPLE SETUP

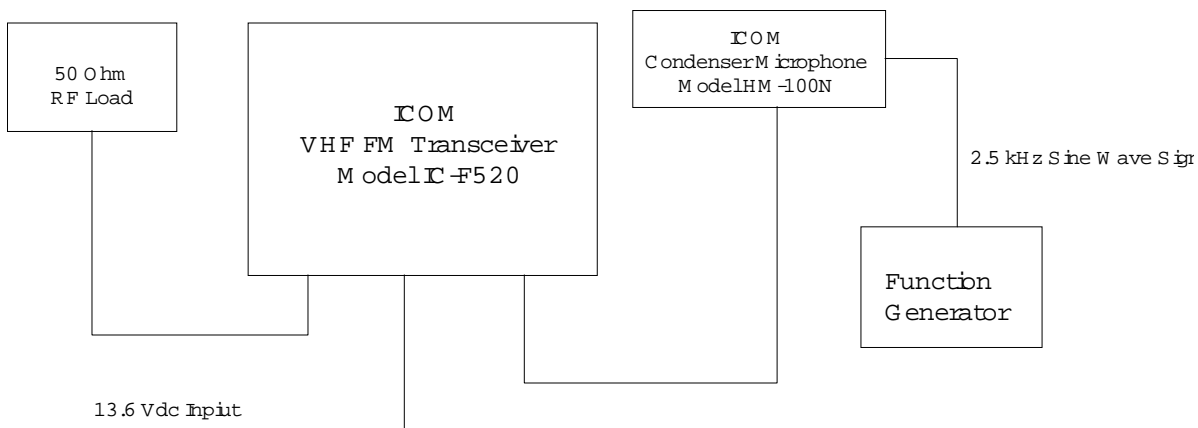

#### ULTRATECH GROUP OF LABS

3000 Bristol Circle, Oakville, Ontario, Canada L6H 6G4  
Tel. #: 905-829-1570, Fax. #: 905-829-8050, Email: [vic@ultratech-labs.com](mailto:vic@ultratech-labs.com), Website: <http://www.ultratech-labs.com>

File #: ICOM35-FTX  
Jan. 28, 2002

- Assessed by ITI (UK) Competent Body, NVLAP (USA) Accreditation Body & ACA/AUSTEL (Australia), VCCI (Japan)
- Accredited by Industry Canada (Canada) under ACC-LAB (Europe/Canada MRA and APEC/Canada MRA)
- Recognized/Listed by FCC (USA)
- All test results contained in this engineering test report are traceable to National Institute of Standards and Technology (NIST)

## EXHIBIT 5. SUMMARY OF TEST RESULTS

### 5.1. LOCATION OF TESTS

All of the measurements described in this report were performed at Ultratech Group of Labs located in the city of Oakville, Province of Ontario, Canada.

Radiated Emissions were performed at the Ultratech's 3 Meter Open Field Test Site (OFTS) situated in the Town of Oakville, province of Ontario.

The above site have been calibrated in accordance with ANSI C63.4, and found to be in compliance with the requirements of Sec. 2.948 of the FCC Rules. The descriptions and site measurement data of the Oakville Open Field Test Site has been filed with FCC office (FCC File No.: 31040/SIT 1300B3) and Industry Canada office (Industry Canada File No.: IC2049). Last Date of Site Calibration: August 8, 2001.

### 5.2. APPLICABILITY & SUMMARY OF EMC EMISSION TEST RESULTS

FCC Paragraph	Test Requirements	Applicability (Yes/No)
90.205 & 2.1046	RF Power Output	Yes
1.1307, 1.1310, 2.1091 & 2.1093	RF Exposure Limit	Yes
90.213 & 2.1055	Frequency Stability	Yes
2.1047(a) & 90.242(b)(8)	Audio Frequency Response	Yes
90.210 & 2.1047(b)	Modulation Limiting	Yes
90.209 90.210 & 2.1049	Emission Limitation & Emission Mask	Yes
90.210, 2.1057 & 2.1051	Emission Limits - Spurious Emissions at Antenna Terminal	Yes
90.210, 2.1057 & 2.1053	Emission Limits - Field Strength of Spurious Emissions	Yes
90.214	Transient Frequency Behavior	Yes

### 5.3. MODIFICATIONS INCORPORATED IN THE EUT FOR COMPLIANCE PURPOSES

None

### 5.4. DEVIATION OF STANDARD TEST PROCEDURES

None

---

#### ULTRATECH GROUP OF LABS

3000 Bristol Circle, Oakville, Ontario, Canada L6H 6G4  
Tel. #: 905-829-1570, Fax. #: 905-829-8050, Email: [vic@ultratech-labs.com](mailto:vic@ultratech-labs.com), Website: <http://www.ultratech-labs.com>

File #: ICOM35-FTX  
Jan. 28, 2002

- Assessed by ITI (UK) Competent Body, NVLAP (USA) Accreditation Body & ACA/AUSTEL (Australia), VCCI (Japan)
- Accredited by Industry Canada (Canada) under ACC-LAB (Europe/Canada MRA and APEC/Canada MRA)
- Recognized/Listed by FCC (USA)
- All test results contained in this engineering test report are traceable to National Institute of Standards and Technology (NIST)

## **EXHIBIT 6. MEASUREMENTS, EXAMINATIONS & TEST DATA FOR EMC EMISSIONS**

### **6.1. TEST PROCEDURES**

This section contains test results only, details of test methods and procedures can be found in Exhibit 8 of this report

### **6.2. MEASUREMENT UNCERTAINTIES**

The measurement uncertainties stated were calculated in accordance with requirements of UKAS Document NIS 81 with a confidence level of 95%. Please refer to Exhibit 7 for Measurement Uncertainties.

### **6.3. MEASUREMENT EQUIPMENT USED:**

The measurement equipment used complied with the requirements of the Standards referenced in the Methods & Procedures ANSI C63.4:1992 and CISPR 16-1.

### **6.4. ESSENTIAL/PRIMARY FUNCTIONS AS DECLARED BY THE MANUFACTURER**

The essential function of the EUT is to correctly communicate data to and from radios over RF link.

---

---

#### **ULTRATECH GROUP OF LABS**

3000 Bristol Circle, Oakville, Ontario, Canada L6H 6G4  
Tel. #: 905-829-1570, Fax. #: 905-829-8050, Email: [vic@ultratech-labs.com](mailto:vic@ultratech-labs.com), Website: <http://www.ultratech-labs.com>

**File #: ICOM35-FTX**  
**Jan. 28, 2002**

- Assessed by ITI (UK) Competent Body, NVLAP (USA) Accreditation Body & ACA/AUSTEL (Australia), VCCI (Japan)
- Accredited by Industry Canada (Canada) under ACC-LAB (Europe/Canada MRA and APEC/Canada MRA)
- Recognized/Listed by FCC (USA)
- All test results contained in this engineering test report are traceable to National Institute of Standards and Technology (NIST)

## 6.5. RF POWER OUTPUT @ FCC 2.1046 & 90.205

### 6.5.1. Limits @ FCC 90.205

Refer to 47 CFR § 90.205 for specification details.

### 6.5.2. Method of Measurements

Refer to sections 8.1 and 8.2 of this test report for measurement methods.

- The transmitter terminal was coupled to the power meter through a 30 dB attenuator
- Power of the transmitter channel near the lowest, middle and highest of each frequency block/band were measured using the power meter, and the reading was corrected by added the calibrated attenuator's attenuation value and cable loss.
- The RF Output was turned on with standard modulation applied.

### 6.5.3. Test Equipment List

Test Instruments	Manufacturer	Model No.	Serial No.	Frequency Range
Attenuator(s)	Bird	...	...	DC – 22 GHz
Attenuator(s)	Weinschel Corp	24-20-34	BJ2357	DC – 8.5 GHz
Power Meter	Hewlett Packard	436A	1725A02249	10 kHz – 50 GHz, sensor dependent
Power Sensor	Hewlett Packard	8481A	2702A68983	10 MHz – 18 GHz

### 6.5.4. Test Arrangement

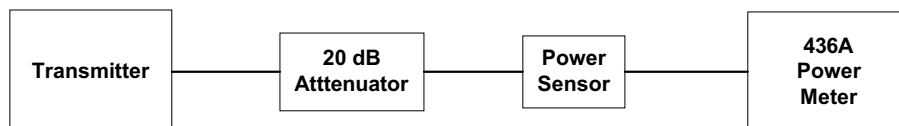

## ULTRATECH GROUP OF LABS

3000 Bristol Circle, Oakville, Ontario, Canada L6H 6G4  
Tel. #: 905-829-1570, Fax. #: 905-829-8050, Email: [vic@ultratech-labs.com](mailto:vic@ultratech-labs.com), Website: <http://www.ultratech-labs.com>

File #: ICOM35-FTX  
Jan. 28, 2002

- Assessed by ITI (UK) Competent Body, NVLAP (USA) Accreditation Body & ACA/AUSTEL (Australia), VCCI (Japan)
- Accredited by Industry Canada (Canada) under ACC-LAB (Europe/Canada MRA and APEC/Canada MRA)
- Recognized/Listed by FCC (USA)
- All test results contained in this engineering test report are traceable to National Institute of Standards and Technology (NIST)

### 6.5.5. Test Data

#### RF Power at RF Output Port

Transmitter Channel Output	Fundamental Frequency (MHz)	Measured Power (dBm)	Power Rating (dBm)
High Power, Narrow Band (12.5kHz channel spacing)			
Lowest	136.10	44.2	44.0
Middle	155.10	44.2	44.0
Highest	173.90	44.0	44.0
High Power, Wide Band (25kHz channel spacing)			
Lowest	136.10	44.2	44.0
Middle	155.10	44.2	44.0
Highest	173.90	44.0	44.0
Low Power, Narrow Band (12.5kHz channel spacing)			
Lowest	136.10	34.1	34.0
Middle	155.10	34.3	34.0
Highest	173.90	34.3	34.0
Low Power, Wide Band (25kHz channel spacing)			
Lowest	136.10	34.2	34.0
Middle	155.10	34.3	34.0
Highest	173.90	34.3	34.0

#### ULTRATECH GROUP OF LABS

3000 Bristol Circle, Oakville, Ontario, Canada L6H 6G4  
 Tel. #: 905-829-1570, Fax. #: 905-829-8050, Email: [vic@ultratech-labs.com](mailto:vic@ultratech-labs.com), Website: <http://www.ultratech-labs.com>

File #: ICOM35-FTX  
 Jan. 28, 2002

- Assessed by ITI (UK) Competent Body, NVLAP (USA) Accreditation Body & ACA/AUSTEL (Australia), VCCI (Japan)
- Accredited by Industry Canada (Canada) under ACC-LAB (Europe/Canada MRA and APEC/Canada MRA)
- Recognized/Listed by FCC (USA)
- All test results contained in this engineering test report are traceable to National Institute of Standards and Technology (NIST)

## 6.6. RF EXPOSURE REQUIRMENTS @ 1.1310 & 2.1091

### 6.6.1. Limits

- **FCC 1.1310:-** The criteria listed in the following table shall be used to evaluate the environmental impact of human exposure to radio-frequency (RF) radiation as specified in 1.1307(b).

**LIMITS FOR MAXIMUM PERMISSIBLE EXPOSURE (MPE)**

Frequency Range (MHz)	Electric Field Strength (V/m)	Magnetic Field Strength (A/m)	Power Density (mW/cm <sup>2</sup> )	Average Time (minutes)
<b>(A) Limits for Occupational/Control Exposures</b>				
30-300	61.4	0.163	1.0	6
<b>(B) Limits for General Population/Uncontrolled Exposure</b>				
30-300	27.5	0.073	0.2	30

F = Frequency in MHz

### 6.6.2. Method of Measurements

Refer to FCC @ 1.1310, 2.1091 and Public Notice DA 00-705 (March 30, 2000)

- In order to demonstrate compliance with MPE requirements (see Section 2.1091), the following information is typically needed:
  - (1) Calculation that estimates the minimum separation distance (20 cm or more) between an antenna and persons required to satisfy power density limits defined for free space.
  - (2) Antenna installation and device operating instructions for installers (professional/unskilled users), and the parties responsible for ensuring compliance with the RF exposure requirement
  - (3) Any caution statements and/or warning labels that are necessary in order to comply with the exposure limits
  - (4) Any other RF exposure related issues that may affect MPE compliance

---

#### ULTRATECH GROUP OF LABS

3000 Bristol Circle, Oakville, Ontario, Canada L6H 6G4  
 Tel. #: 905-829-1570, Fax. #: 905-829-8050, Email: [vic@ultratech-labs.com](mailto:vic@ultratech-labs.com), Website: <http://www.ultratech-labs.com>

File #: ICOM35-FTX  
 Jan. 28, 2002

- Assessed by ITI (UK) Competent Body, NVLAP (USA) Accreditation Body & ACA/AUSTEL (Australia), VCCI (Japan)
- Accredited by Industry Canada (Canada) under ACC-LAB (Europe/Canada MRA and APEC/Canada MRA)
- Recognized/Listed by FCC (USA)
- All test results contained in this engineering test report are traceable to National Institute of Standards and Technology (NIST)

**Calculation Method of RF Safety Distance**

$$S = PG/4\pi r^2 = EIRP/4\pi r^2$$

Where: P: power input to the antenna in mW  
EIRP: Equivalent (effective) isotropic radiated power.  
S: power density mW/cm<sup>2</sup>  
G: numeric gain of antenna relative to isotropic radiator  
r: distance to centre of radiation in cm

FCC radio frequency exposure limits may be exceeded at distances closer than r cm from the antenna of this device

$$r = \sqrt{PG/4\pi S}$$

FCC radio frequency exposure limits may not be exceeded at distances closer than r cm from the antenna of this device

- For portable transmitters (see Section 2.1093), or devices designed to operate next to a person's body, compliance is determined with respect to the SAR limit (define in the body tissues) for near-field exposure conditions. If the maximum average output power, operating condition configurations and exposure conditions are comparable to those of existing cellular and PCS phones., an SAR evaluation may be required in order to determine if such a device complies with SAR limit. When SAR evaluation data is not available, and the additional supporting information cannot assure compliance, the Commission may request that an SAR evaluation be performed, as provided for in Section 1.1307(d)

---

**ULTRATECH GROUP OF LABS**

3000 Bristol Circle, Oakville, Ontario, Canada L6H 6G4  
Tel. #: 905-829-1570, Fax. #: 905-829-8050, Email: [vic@ultratech-labs.com](mailto:vic@ultratech-labs.com), Website: <http://www.ultratech-labs.com>

File #: ICOM35-FTX  
Jan. 28, 2002

- Assessed by ITI (UK) Competent Body, NVLAP (USA) Accreditation Body & ACA/AUSTEL (Australia), VCCI (Japan)
- Accredited by Industry Canada (Canada) under ACC-LAB (Europe/Canada MRA and APEC/Canada MRA)
- Recognized/Listed by FCC (USA)
- All test results contained in this engineering test report are traceable to National Institute of Standards and Technology (NIST)



### 6.6.3. Test Data

#### **Antenna Gain Limit specified by Manufacturer: 0 dBi**

Measured Maximum RF Conducted Power (dBm)	Calculated EIRP (dBm)	Laboratory's Recommended Minimum RF Safety Distance r (cm)	Manufacturer's specified antenna separation distance (cm)
44.2	44.2	45.8	85 cm

**Note 1:** RF EXPOSURE DISTANCE LIMITS :  $r = (PG/4\Pi S)^{1/2} = (EIRP/4\Pi S)^{1/2}$   
 For Occupational/Controlled Exposure  $S = 1.0 \text{ mW/cm}^2$

Evaluation of RF Exposure Compliance Requirements	
RF Exposure Requirements	Compliance with FCC Rules
Minimum calculated separation distance between antenna and persons required: 45.8 cm	Manufacturer' instruction for separation distance between antenna and persons required: 85 cm meter. Please refer to page # b of the Users/ Manual and FCC RF Exposure folder
Antenna installation and device operating instructions for installers (professional/unskilled users), and the parties responsible for ensuring compliance with the RF exposure requirement	Please refer to page # b of the Users/ Manual and FCC RF Exposure folder
Caution statements and/or warning labels that are necessary in order to comply with the exposure limits	Please refer to page # b of the Users/ Manual and FCC RF Exposure folder
Any other RF exposure related issues that may affect MPE compliance	RF Safety Training for compliance with Occupational Use/Control Exposure

#### **ULTRATECH GROUP OF LABS**

3000 Bristol Circle, Oakville, Ontario, Canada L6H 6G4  
 Tel. #: 905-829-1570, Fax. #: 905-829-8050, Email: [vic@ultratech-labs.com](mailto:vic@ultratech-labs.com), Website: <http://www.ultratech-labs.com>

File #: ICOM35-FTX  
 Jan. 28, 2002

- Assessed by ITI (UK) Competent Body, NVLAP (USA) Accreditation Body & ACA/AUSTEL (Australia), VCCI (Japan)
- Accredited by Industry Canada (Canada) under ACC-LAB (Europe/Canada MRA and APEC/Canada MRA)
- Recognized/Listed by FCC (USA)
- All test results contained in this engineering test report are traceable to National Institute of Standards and Technology (NIST)

## 6.7. FREQUENCY STABILITY @ FCC 2.1055 & 90.213

### 6.7.1. Limits @ FCC 90.213

Refer to 47 CFR §90.213 for specification details.

Frequency Range (MHz)	Channel Spacing (kHz)	Frequency Stability (ppm)
		Mobile Stations > 2 Watts
138-174	25	5.0
	12.5	2.5

### 6.7.2. Method of Measurements

Refer to Exhibit 8, § 8.3 of this report for measurement details

### 6.7.3. Test Equipment List

Test Instruments	Manufacturer	Model No.	Serial No.	Frequency Range
EMI Receiver/ EMI Receiver	Hewlett Packard	HP 8593EM	3412A00103	9 kHz – 26.5 GHz
Attenuator(s)	Bird	..	...	DC – 22 GHz
Temperature & Humidity Chamber	Tenney	T5	9723B	-40° to +60° C range

### 6.7.4. Test Arrangement

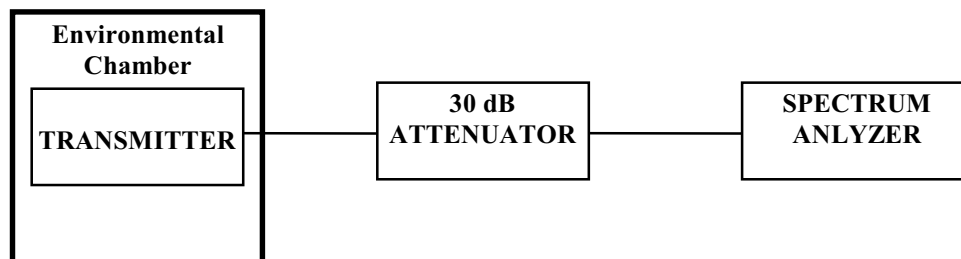

## ULTRATECH GROUP OF LABS

3000 Bristol Circle, Oakville, Ontario, Canada L6H 6G4  
 Tel. #: 905-829-1570, Fax. #: 905-829-8050, Email: [vic@ultratech-labs.com](mailto:vic@ultratech-labs.com), Website: <http://www.ultratech-labs.com>

File #: ICOM35-FTX  
 Jan. 28, 2002

- Assessed by ITI (UK) Competent Body, NVLAP (USA) Accreditation Body & ACA/AUSTEL (Australia), VCCI (Japan)
- Accredited by Industry Canada (Canada) under ACC-LAB (Europe/Canada MRA and APEC/Canada MRA)
- Recognized/Listed by FCC (USA)
- All test results contained in this engineering test report are traceable to National Institute of Standards and Technology (NIST)

### 6.7.5. Test Data

<b>Product Name:</b>	Mobile VHF FM Transceiver
<b>Model No.:</b>	IC-F520
<b>Center Frequency:</b>	136.10 MHz
<b>Full Power Level:</b>	26.3 Watts
<b>Frequency Tolerance Limit (Worst Case):</b>	$\pm 2.5$ ppm or $\pm 340.25$ Hz at 136.10 MHz
<b>Max. Frequency Tolerance Measured:</b>	+270 Hz or +2.0 ppm
<b>Input Voltage Rating:</b>	13.6 Vdc, 5.1 A

CENTER FREQUENCY & RF POWER OUTPUT VARIATION			
Ambient Temperature (°C)	Supply Voltage (Nominal) 13.6 Volts dc	Supply Voltage (85% of Nominal) 11.6 Volts dc	Supply Voltage (115% of Nominal) 15.6 Volts dc
	Hz	Hz	Hz
-30	-60	N/A	N/A
-20	-80	N/A	N/A
-10	-100	N/A	N/A
0	-70	N/A	N/A
+10	-50	N/A	N/A
+20	+9	+40	+9
+30	-10	N/A	N/A
+40	+54	N/A	N/A
+50	+270	N/A	N/A

#### ULTRATECH GROUP OF LABS

3000 Bristol Circle, Oakville, Ontario, Canada L6H 6G4  
 Tel. #: 905-829-1570, Fax. #: 905-829-8050, Email: [vic@ultratech-labs.com](mailto:vic@ultratech-labs.com), Website: <http://www.ultratech-labs.com>

File #: ICOM35-FTX  
 Jan. 28, 2002

- Assessed by ITI (UK) Competent Body, NVLAP (USA) Accreditation Body & ACA/AUSTEL (Australia), VCCI (Japan)
- Accredited by Industry Canada (Canada) under ACC-LAB (Europe/Canada MRA and APEC/Canada MRA)
- Recognized/Listed by FCC (USA)
- All test results contained in this engineering test report are traceable to National Institute of Standards and Technology (NIST)

## 6.8. 99% OCCUPIED BANDWIDTH & EMISSION MASK @ FCC 2.1049, 90.209 & 90.210

### 6.8.1. Limits @ FCC 90.209 & 90.210

Emissions shall be attenuated below the mean output power of the transmitter as follows:

Frequency Band (MHz)	Channel Spacing (kHz)	Authorized Bandwidth (kHz)	Recommended Frequency Deviation (KHz)	Applicable Emissions Mask	
				Mask for equipment with audio low pass filter	Mask for equipment without audio low pass filter
138-174	25 12.5	20 11.25	5 2.5	B D	C D

### 6.8.2. Method of Measurements

Refer to § 8.4 of this report for measurement details

### 6.8.3. Test Equipment List

Test Instruments	Manufacturer	Model No.	Serial No.	Frequency Range
Spectrum Analyzer/ EMI Receiver	Hewlett Packard	HP 8593EM	3412A00103	9 kHz – 26.5 GHz
Attenuator(s)	Bird	..	...	DC – 22 GHz
Audio Oscillator	Hewlett Packard	HP 204C	0989A08798	DC to 1.2 MHz

### 6.8.4. Test Arrangement

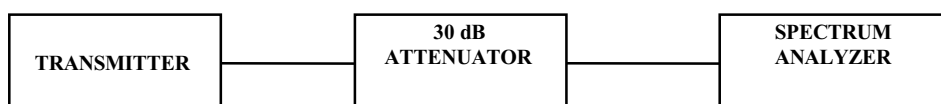

## ULTRATECH GROUP OF LABS

3000 Bristol Circle, Oakville, Ontario, Canada L6H 6G4  
 Tel. #: 905-829-1570, Fax. #: 905-829-8050, Email: [vic@ultratech-labs.com](mailto:vic@ultratech-labs.com), Website: <http://www.ultratech-labs.com>

File #: ICOM35-FTX  
 Jan. 28, 2002

- Assessed by ITI (UK) Competent Body, NVLAP (USA) Accreditation Body & ACA/AUSTEL (Australia), VCCI (Japan)
- Accredited by Industry Canada (Canada) under ACC-LAB (Europe/Canada MRA and APEC/Canada MRA)
- Recognized/Listed by FCC (USA)
- All test results contained in this engineering test report are traceable to National Institute of Standards and Technology (NIST)

## 6.8.5. Test Data

### 6.8.5.1. 99% Occupied Bandwidth

Conform. Please refer to Plots # 1 through # 6 in Annex 1 for Details of measurements

Frequency (MHz)	Channel Spacing (kHz)	Measured 99% OBW (kHz)	Recommended maximum 99% OBW
136.10	12.5	8.1	11.25
155.10	12.5	8.2	11.25
173.90	12.5	8.1	11.25
136.10	25.0	12.8	20
155.10	25.0	13.4	20
173.90	25.0	13.1	20

### 6.8.5.2. Emission Masks

Conform. Please refer to Plots # 7 to 9 in Annex 1 for Details of Mask D Measurements for 12.5 kHz Channel Spacing

Conform. Please refer to Plots # 10 to 12 in Annex 1 for Details of Mask B Measurements for 25 kHz Channel Spacing

---

---

#### ULTRATECH GROUP OF LABS

3000 Bristol Circle, Oakville, Ontario, Canada L6H 6G4  
Tel. #: 905-829-1570, Fax. #: 905-829-8050, Email: [vic@ultratech-labs.com](mailto:vic@ultratech-labs.com), Website: <http://www.ultratech-labs.com>

File #: ICOM35-FTX  
Jan. 28, 2002

- Assessed by ITI (UK) Competent Body, NVLAP (USA) Accreditation Body & ACA/AUSTEL (Australia), VCCI (Japan)
- Accredited by Industry Canada (Canada) under ACC-LAB (Europe/Canada MRA and APEC/Canada MRA)
- Recognized/Listed by FCC (USA)
- All test results contained in this engineering test report are traceable to National Institute of Standards and Technology (NIST)

## 6.9. AUDIO FREQUENCY RESPONSE @ FCC 2.1047(a) AND 90.242(B)(8)

### 6.9.1. Limits @ FCC 2.1047(a) and 90.242(b)(8)

No limit is required by FCC for audio frequency response. However, FCC recommends the Audio Frequency Response to be tested to show the roll-off curve at 3 kHz.

Recommended Limits: The attenuation of lowpass filter between the frequencies of 3 kHz and 20 kHz shall be greater than the attenuation at 1kHz by at least:  $60\text{Log}_{10}(f/3)$  decibels where "f" is the frequency in kHz. At frequency above 20 kHz, the attenuation shall be 50 dB greater than the attenuation at 1 kHz.

### 6.9.2. Method of Measurements

The rated audio input signal was applied to the input of the audiolowpass filter (or of all modulation stages) using an audio oscillator, this input signal level and its corresponding output signal were then measured and recorded using the FFT (Audio) EMI Receiver. Tests were repeated at different audio signal frequencies from 0 to 50 kHz.

### 6.9.3. Test Equipment List

Test Instruments	Manufacturer	Model No.	Serial No.	Frequency Range
FFT (audio) EMI Receiver	Advantest	R9211E	...	10 mHz – 100 kHz, 1 MHz Input Impedance
Audio Oscillator	Hewlett Packard	HP 204C	0989A08798	DC to 1.2 MHz

### 6.9.4. Test Arrangement

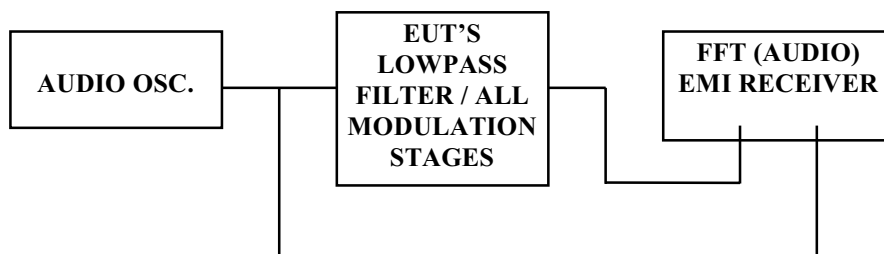

## ULTRATECH GROUP OF LABS

3000 Bristol Circle, Oakville, Ontario, Canada L6H 6G4  
 Tel. #: 905-829-1570, Fax. #: 905-829-8050, Email: [vic@ultratech-labs.com](mailto:vic@ultratech-labs.com), Website: <http://www.ultratech-labs.com>

File #: ICOM35-FTX  
 Jan. 28, 2002

- Assessed by ITI (UK) Competent Body, NVLAP (USA) Accreditation Body & ACA/AUSTEL (Australia), VCCI (Japan)
- Accredited by Industry Canada (Canada) under ACC-LAB (Europe/Canada MRA and APEC/Canada MRA)
- Recognized/Listed by FCC (USA)
- All test results contained in this engineering test report are traceable to National Institute of Standards and Technology (NIST)

## 6.9.5. Test Data

### 6.9.5.1. 12.5 kHz Channel Spacing

FREQUENCY (kHz)	AUDIO IN (dBV)	AUDIO OUT (dBV)	ATTEN. (OUT - IN) (dB)	ATTEN. wrt. 1 kHz (dB)	FCC LIMIT @22.915D (dB)	PASS/ FAIL
0.20	-46.8	<-70.0	<-23.2	<-56.4	0	PASS
0.40	-46.8	-23.3	23.5	-9.7	0.0	PASS
0.60	-46.8	-19.0	27.8	-5.4	0.0	PASS
0.80	-46.8	-15.8	31.0	-2.2	0.0	PASS
1.00	-46.8	-13.6	33.2	0.0	0.0	PASS
1.50	-46.8	-11.3	35.5	2.3	0.0	PASS
2.00	-46.8	-11.0	35.8	2.6	0.0	PASS
2.50	-46.8	-11.2	35.6	2.4	0.0	PASS
3.00	-46.8	-12.1	34.7	1.5	0.0	PASS
3.50	-46.8	-19.3	27.5	-5.7	-4.0	PASS
4.00	-46.8	-42.3	4.5	-28.7	-7.5	PASS
4.50	-46.8	<-70.0	<-23.2	<-56.4	-10.6	PASS
5.00	-46.8	<-70.0	<-23.2	<-56.4	-13.3	PASS
6.00	-46.8	<-70.0	<-23.2	<-56.4	-18.1	PASS
7.00	-46.8	<-70.0	<-23.2	<-56.4	-22.1	PASS
8.00	-46.8	<-70.0	<-23.2	<-56.4	-25.6	PASS
9.00	-46.8	<-70.0	<-23.2	<-56.4	-28.6	PASS
10.00	-46.8	<-70.0	<-23.2	<-56.4	-31.4	PASS
20.00	-46.8	<-70.0	<-23.2	<-56.4	-49.4	PASS
22.00	-46.8	<-70.0	<-23.2	<-56.4	-50.0	PASS
24.00	-46.8	<-70.0	<-23.2	<-56.4	-50.0	PASS
26.00	-46.8	<-70.0	<-23.2	<-56.4	-50.0	PASS
28.00	-46.8	<-70.0	<-23.2	<-56.4	-50.0	PASS
30.00	-46.8	<-70.0	<-23.2	<-56.4	-50.0	PASS

\* The Audio Input Level = STD MOD LEVEL + 10 dB  
 Where STD Modulation Level is the audio input level at 1KHz and Frequency Deviation = 60% of the maximum frequency deviation

#### ULTRATECH GROUP OF LABS

3000 Bristol Circle, Oakville, Ontario, Canada L6H 6G4  
 Tel. #: 905-829-1570, Fax. #: 905-829-8050, Email: [vic@ultratech-labs.com](mailto:vic@ultratech-labs.com), Website: <http://www.ultratech-labs.com>

File #: ICOM35-FTX  
 Jan. 28, 2002

- Assessed by ITI (UK) Competent Body, NVLAP (USA) Accreditation Body & ACA/AUSTEL (Australia), VCCI (Japan)
- Accredited by Industry Canada (Canada) under ACC-LAB (Europe/Canada MRA and APEC/Canada MRA)
- Recognized/Listed by FCC (USA)
- All test results contained in this engineering test report are traceable to National Institute of Standards and Technology (NIST)

**AUDIO FREQUENCY REPSONSE @ FCC 2.987(a) & 90.242b(8)**  
**VHF FM Transceiver, Model IC-F520 (12.5 kHz Channel Spacing)**

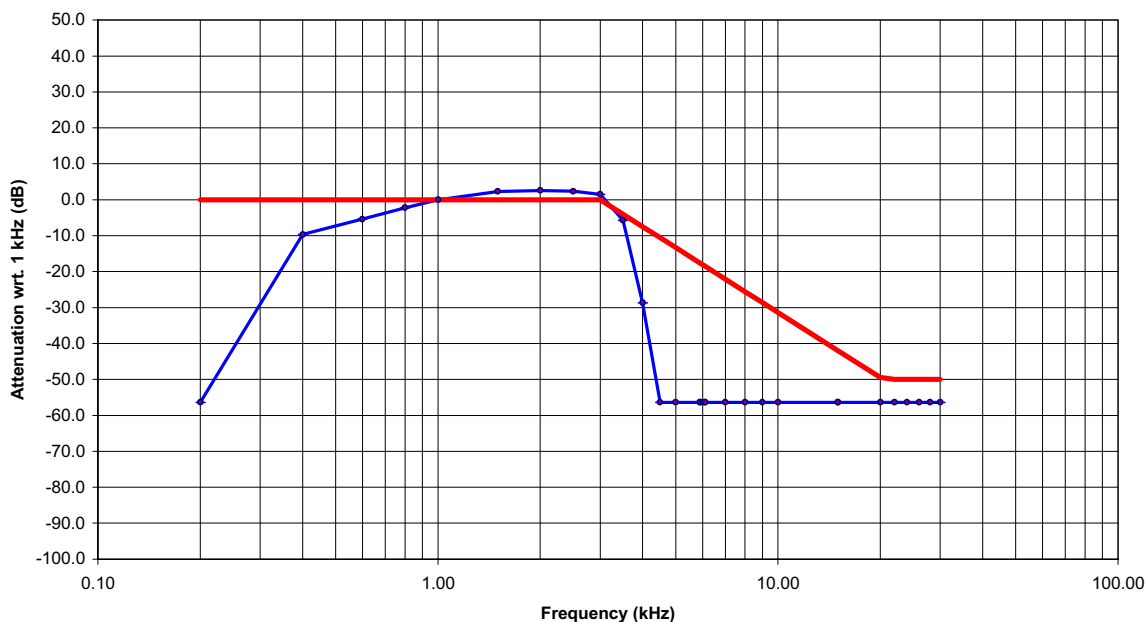

**ULTRATECH GROUP OF LABS**

3000 Bristol Circle, Oakville, Ontario, Canada L6H 6G4  
Tel. #: 905-829-1570, Fax. #: 905-829-8050, Email: [vic@ultratech-labs.com](mailto:vic@ultratech-labs.com), Website: <http://www.ultratech-labs.com>

File #: ICOM35-FTX  
Jan. 28, 2002

- Assessed by ITI (UK) Competent Body, NVLAP (USA) Accreditation Body & ACA/AUSTEL (Australia), VCCI (Japan)
- Accredited by Industry Canada (Canada) under ACC-LAB (Europe/Canada MRA and APEC/Canada MRA)
- Recognized/Listed by FCC (USA)
- All test results contained in this engineering test report are traceable to National Institute of Standards and Technology (NIST)



**6.9.5.2. 25 kHz Channel Spacing**

FREQUENCY (kHz)	AUDIO IN (dBV)	AUDIO OUT (dBV)	ATTEN. (OUT - IN) (dB)	ATTEN. wrt. 1 kHz (dB)	FCC LIMIT @22.915D (dB)	PASS/ FAIL
0.20	-46.8	<-70.0	<-23.2	<-62.6	0	PASS
0.40	-46.8	-17.6	29.2	-10.2	0.0	PASS
0.60	-46.8	-12.4	34.4	-5.0	0.0	PASS
0.80	-46.8	-9.5	37.3	-2.1	0.0	PASS
1.00	-46.8	-7.4	39.4	0.0	0.0	PASS
1.50	-46.8	-5.7	41.1	1.7	0.0	PASS
2.00	-46.8	-5.3	41.5	2.1	0.0	PASS
2.50	-46.8	-5.2	41.6	2.2	0.0	PASS
3.00	-46.8	-5.6	41.2	1.8	0.0	PASS
3.50	-46.8	-12.1	34.7	-4.7	-4.0	PASS
4.00	-46.8	-35.1	11.7	-27.7	-7.5	PASS
4.50	-46.8	<-70.0	<-23.2	<-62.6	-10.6	PASS
5.00	-46.8	<-70.0	<-23.2	<-62.6	-13.3	PASS
6.00	-46.8	<-70.0	<-23.2	<-62.6	-18.1	PASS
7.00	-46.8	<-70.0	<-23.2	<-62.6	-22.1	PASS
8.00	-46.8	<-70.0	<-23.2	<-62.6	-25.6	PASS
9.00	-46.8	<-70.0	<-23.2	<-62.6	-28.6	PASS
10.00	-46.8	<-70.0	<-23.2	<-62.6	-31.4	PASS
20.00	-46.8	<-70.0	<-23.2	<-62.6	-49.4	PASS
22.00	-46.8	<-70.0	<-23.2	<-62.6	-50.0	PASS
24.00	-46.8	<-70.0	<-23.2	<-62.6	-50.0	PASS
26.00	-46.8	<-70.0	<-23.2	<-62.6	-50.0	PASS
28.00	-46.8	<-70.0	<-23.2	<-62.6	-50.0	PASS
30.00	-46.8	<-70.0	<-23.2	<-62.6	-50.0	PASS

\* The Audio Input Level = STD MOD LEVEL + 10 dB  
 Where STD Modulation Level is the audio input level at 1KHz and Frequency Deviation = 60% of the maximum frequency deviation

**ULTRATECH GROUP OF LABS**

3000 Bristol Circle, Oakville, Ontario, Canada L6H 6G4  
 Tel. #: 905-829-1570, Fax. #: 905-829-8050, Email: [vic@ultratech-labs.com](mailto:vic@ultratech-labs.com), Website: <http://www.ultratech-labs.com>

File #: ICOM35-FTX  
 Jan. 28, 2002

- Assessed by ITI (UK) Competent Body, NVLAP (USA) Accreditation Body & ACA/AUSTEL (Australia), VCCI (Japan)
- Accredited by Industry Canada (Canada) under ACC-LAB (Europe/Canada MRA and APEC/Canada MRA)
- Recognized/Listed by FCC (USA)
- All test results contained in this engineering test report are traceable to National Institute of Standards and Technology (NIST)

**AUDIO FREQUENCY RESPONSE @ FCC 2.987(a) & 90.242b(8)**  
**VHF FM Transceiver, Model IC-F520 (25 kHz Channel Spacing)**

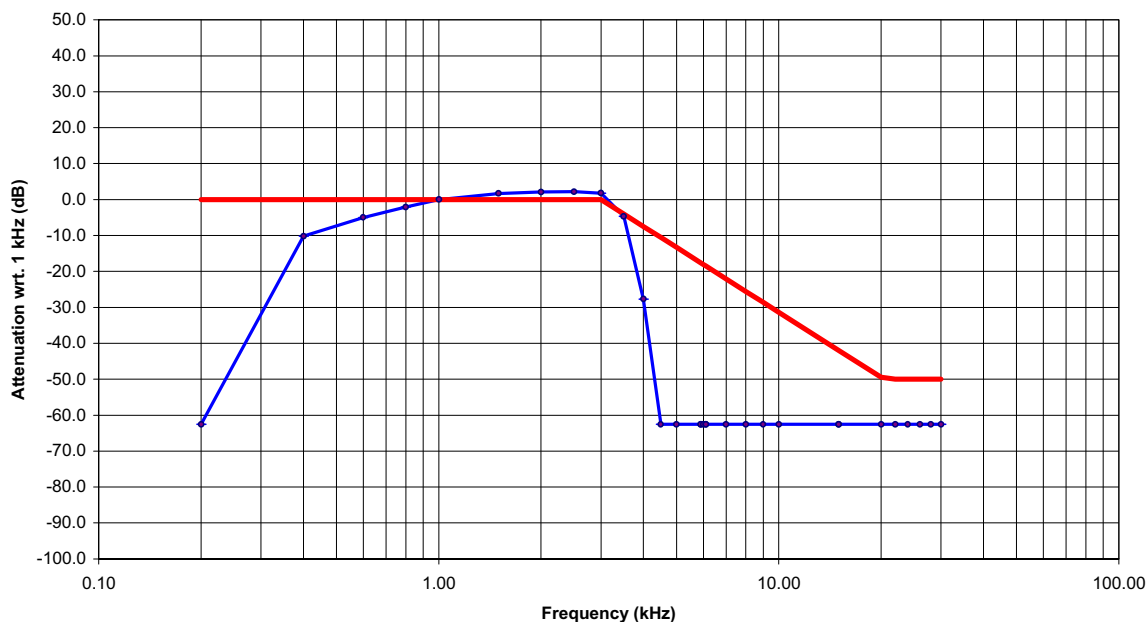

**ULTRATECH GROUP OF LABS**

3000 Bristol Circle, Oakville, Ontario, Canada L6H 6G4  
Tel. #: 905-829-1570, Fax. #: 905-829-8050, Email: [vic@ultratech-labs.com](mailto:vic@ultratech-labs.com), Website: <http://www.ultratech-labs.com>

File #: ICOM35-FTX  
Jan. 28, 2002

- Assessed by ITI (UK) Competent Body, NVLAP (USA) Accreditation Body & ACA/AUSTEL (Australia), VCCI (Japan)
- Accredited by Industry Canada (Canada) under ACC-LAB (Europe/Canada MRA and APEC/Canada MRA)
- Recognized/Listed by FCC (USA)
- All test results contained in this engineering test report are traceable to National Institute of Standards and Technology (NIST)

## 6.10. MODULATION LIMITING @ FCC 2.1047(b) & 90.210

### 6.10.1. Limits @ FCC 2.1047(b) and 90.210

Recommended frequency deviation characteristics are given below:

- 2.5 kHz for 12.5 kHz Channel Spacing
- 5 kHz for 25 kHz Channel Spacing System

### 6.10.2. Method of Measurements

**For Audio Transmitter:** The carrier frequency deviation was measured with the tone input signal level varied from 0Vp to audio input rating level plus 16 dB at frequencies 0.1, 0.5, 1.0, 3.0 and 5.0 kHz. The maximum deviation was recorded at each test condition.

**For Data Transmitter with Maximum Frequency Deviation set by Factory-** The EUT was set at maximum frequency deviation, and its peak frequency deviation was then measured using EUT's internal random data source.

### 6.10.3. Test Equipment List

Test Instruments	Manufacturer	Model No.	Serial No.	Frequency Range
Communication Analyzer	Rohde & Schawrz	SMF02	879988/057	400 kHz - 1000 MHz including AF & RF Signal Generators, SINAD, DISTORTION, DEVIATION meters and etc

### 6.10.4. Test Arrangement

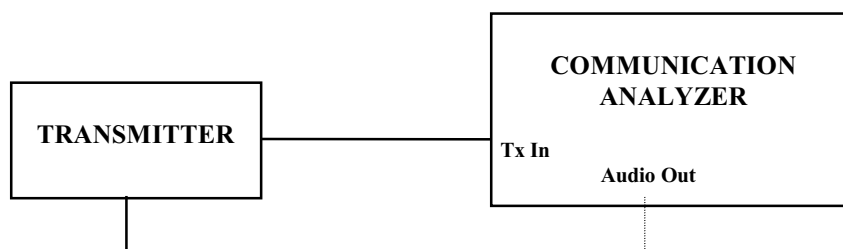

## ULTRATECH GROUP OF LABS

3000 Bristol Circle, Oakville, Ontario, Canada L6H 6G4  
 Tel. #: 905-829-1570, Fax. #: 905-829-8050, Email: [vic@ultratech-labs.com](mailto:vic@ultratech-labs.com), Website: <http://www.ultratech-labs.com>

File #: ICOM35-FTX  
 Jan. 28, 2002

- Assessed by ITI (UK) Competent Body, NVLAP (USA) Accreditation Body & ACA/AUSTEL (Australia), VCCI (Japan)
- Accredited by Industry Canada (Canada) under ACC-LAB (Europe/Canada MRA and APEC/Canada MRA)
- Recognized/Listed by FCC (USA)
- All test results contained in this engineering test report are traceable to National Institute of Standards and Technology (NIST)

## 6.10.5. Test Data

### 6.10.5.1. 12.5 KHz Spacing Operation

MODULATING SIGNAL LEVEL (mVrms)	PEAK FREQUENCY DEVIATION (kHz) at the following modulating frequency:					MAXIMUM LIMIT (kHz)
	0.1 kHz	0.5 kHz	1.0 kHz	3.0 kHz	5.0 kHz	
2	0.7	0.8	0.9	1.6	0.4	2.5
4	0.7	0.8	1.0	1.7	0.4	2.5
6	0.7	0.8	1.2	1.7	0.4	2.5
8	0.7	0.9	1.3	1.7	0.4	2.5
10	0.7	1.0	1.5	1.7	0.4	2.5
14	0.7	1.0	1.8	1.7	0.4	2.5
16	0.7	1.2	2.1	1.7	0.4	2.5
18	0.7	1.2	2.2	1.7	0.4	2.5
20	0.7	1.2	2.3	1.7	0.4	2.5
25	0.7	1.2	2.5	1.7	0.4	2.5
30	0.7	1.3	2.5	1.7	0.4	2.5
35	0.7	1.7	2.5	1.7	0.4	2.5
40	0.7	1.7	2.5	1.7	0.4	2.5
45	0.7	1.7	2.5	1.7	0.4	2.5
50	0.8	1.8	2.5	1.7	0.4	2.5

#### ULTRATECH GROUP OF LABS

3000 Bristol Circle, Oakville, Ontario, Canada L6H 6G4  
 Tel. #: 905-829-1570, Fax. #: 905-829-8050, Email: [vic@ultratech-labs.com](mailto:vic@ultratech-labs.com), Website: <http://www.ultratech-labs.com>

File #: ICOM35-FTX  
 Jan. 28, 2002

- Assessed by ITI (UK) Competent Body, NVLAP (USA) Accreditation Body & ACA/AUSTEL (Australia), VCCI (Japan)
- Accredited by Industry Canada (Canada) under ACC-LAB (Europe/Canada MRA and APEC/Canada MRA)
- Recognized/Listed by FCC (USA)
- All test results contained in this engineering test report are traceable to National Institute of Standards and Technology (NIST)

Voice Signal Input Level = STD MOD Level + 16 dB = 20dBmVrms + 16 = **36 dBmVrms**

MODULATING FREQUENCY (KHz)	PEAK FREQUENCY DEVIATION (KHz)	MAXIMUM LIMIT (KHz)
0.1	1.1	2.5
0.2	2.2	2.5
0.4	1.6	2.5
0.6	2.3	2.5
0.8	2.5	2.5
1.0	2.5	2.5
1.2	2.2	2.5
1.4	2.1	2.5
1.6	2.1	2.5
1.8	2.1	2.5
2.0	2.1	2.5
2.5	2.0	2.5
3.0	1.8	2.5
3.5	0.9	2.5
4.0	0.1	2.5
4.5	0.1	2.5
5.0	0.1	2.5
6.0	0.1	2.5
7.0	0.1	2.5
8.0	0.1	2.5
9.0	0.1	2.5
10.0	0.1	2.5

**ULTRATECH GROUP OF LABS**

3000 Bristol Circle, Oakville, Ontario, Canada L6H 6G4  
 Tel. #: 905-829-1570, Fax. #: 905-829-8050, Email: [vic@ultratech-labs.com](mailto:vic@ultratech-labs.com), Website: <http://www.ultratech-labs.com>

File #: ICOM35-FTX  
 Jan. 28, 2002

- Assessed by ITI (UK) Competent Body, NVLAP (USA) Accreditation Body & ACA/AUSTEL (Australia), VCCI (Japan)
- Accredited by Industry Canada (Canada) under ACC-LAB (Europe/Canada MRA and APEC/Canada MRA)
- Recognized/Listed by FCC (USA)
- All test results contained in this engineering test report are traceable to National Institute of Standards and Technology (NIST)

**6.10.5.2. 25 KHz Spacing Operation**

MODULATING SIGNAL LEVEL (mVrms)	PEAK FREQUENCY DEVIATION (kHz) at the following modulating frequency:					MAXIMUM LIMIT (kHz)
	0.1 kHz	0.5 kHz	1.0 kHz	3.0 kHz	5.0 kHz	
2	1.3	1.3	1.4	2.8	1.3	5
4	1.3	1.3	1.6	3.6	1.3	5
6	1.3	1.4	1.9	3.7	1.3	5
8	1.3	1.4	2.2	3.8	1.3	5
10	1.3	1.5	2.9	3.8	1.1	5
12	1.3	1.6	3.3	3.8	1.0	5
14	1.3	1.6	3.6	3.8	0.9	5
16	1.3	1.7	3.9	3.8	0.9	5
18	1.3	1.8	4.2	3.8	0.8	5
20	1.3	1.9	4.5	3.8	0.7	5
25	1.3	2.4	5.0	3.8	0.6	5
30	1.3	2.9	5.0	3.8	0.5	5
35	1.3	3.2	5.0	3.8	0.4	5
40	1.3	3.0	5.0	3.8	0.3	5
45	1.0	3.1	5.0	3.8	0.3	5
50	1.0	3.4	5.0	3.8	0.3	5

**ULTRATECH GROUP OF LABS**

3000 Bristol Circle, Oakville, Ontario, Canada L6H 6G4  
 Tel. #: 905-829-1570, Fax. #: 905-829-8050, Email: [vic@ultratech-labs.com](mailto:vic@ultratech-labs.com), Website: <http://www.ultratech-labs.com>

File #: ICOM35-FTX  
 Jan. 28, 2002

- Assessed by ITI (UK) Competent Body, NVLAP (USA) Accreditation Body & ACA/AUSTEL (Australia), VCCI (Japan)
- Accredited by Industry Canada (Canada) under ACC-LAB (Europe/Canada MRA and APEC/Canada MRA)
- Recognized/Listed by FCC (USA)
- All test results contained in this engineering test report are traceable to National Institute of Standards and Technology (NIST)

Voice Signal Input Level = STD MOD Level + 16 dB = 20dBmVrms + 16 = **36 dBmVrms**

MODULATING FREQUENCY (KHz)	PEAK FREQUENCY DEVIATION (KHz)	MAXIMUM LIMIT (KHz)
0.1	2.1	5
0.2	4.2	5
0.4	3.3	5
0.6	4.6	5
0.8	5.0	5
1.0	5.0	5
1.2	4.3	5
1.4	3.9	5
1.6	3.9	5
1.8	3.9	5
2.0	3.9	5
2.5	3.9	5
3.0	3.7	5
3.5	2.1	5
4.0	0.3	5
4.5	0.2	5
5.0	0.1	5
6.0	0.1	5
7.0	0.1	5
8.0	0.1	5
9.0	0.1	5
10.0	0.1	5

**ULTRATECH GROUP OF LABS**

3000 Bristol Circle, Oakville, Ontario, Canada L6H 6G4  
 Tel. #: 905-829-1570, Fax. #: 905-829-8050, Email: [vic@ultratech-labs.com](mailto:vic@ultratech-labs.com), Website: <http://www.ultratech-labs.com>

File #: ICOM35-FTX  
 Jan. 28, 2002

- Assessed by ITI (UK) Competent Body, NVLAP (USA) Accreditation Body & ACA/AUSTEL (Australia), VCCI (Japan)
- Accredited by Industry Canada (Canada) under ACC-LAB (Europe/Canada MRA and APEC/Canada MRA)
- Recognized/Listed by FCC (USA)
- All test results contained in this engineering test report are traceable to National Institute of Standards and Technology (NIST)

## 6.11. TRANSMITTER ANTENNA POWER SPURIOUS/HARMONIC CONDUCTED EMISSIONS @ FCC 90.210

### 6.11.1. Limits @ 90.210

Emissions shall be attenuated below the mean output power of the transmitter as follows:

FCC Rules	Frequency Range	Attenuation Limit (dBc)
90.210(b)&(c)	10 MHz to Lowest frequency of the radio to 10 <sup>th</sup> harmonic of the highest frequency of the radio	43+10*log(P)
90.210(d)	10 MHz to Lowest frequency of the radio to 10 <sup>th</sup> harmonic of the highest frequency of the radio	50+10*log(P) or 70 dBc whichever is less

### 6.11.2. Method of Measurements

Refer to Exhibit 8 § 8.5 of this report for measurement details

### 6.11.3. Test Equipment List

Test Instruments	Manufacturer	Model No.	Serial No.	Frequency Range
Spectrum Analyzer/ EMI Receiver	Hewlett Packard	HP 8593EM	3412A00103	9 kHz – 26.5 GHz
Attenuator(s)	Bird	..	...	DC – 22 GHz
Audio Oscillator	Hewlett Packard	HP 204C	0989A08798	DC to 1.2 MHz
Highpass Filter, Microphase	Microphase	CR220HID	IIT111000AC	Cut-off Frequency at 600 MHz, 1.3 GHz or 4 GHz

### 6.11.4. Test Arrangement

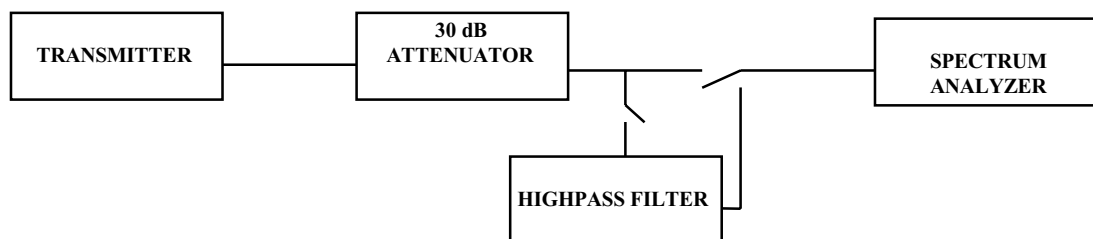

## ULTRATECH GROUP OF LABS

3000 Bristol Circle, Oakville, Ontario, Canada L6H 6G4  
 Tel. #: 905-829-1570, Fax. #: 905-829-8050, Email: [vic@ultratech-labs.com](mailto:vic@ultratech-labs.com), Website: <http://www.ultratech-labs.com>

File #: ICOM35-FTX  
 Jan. 28, 2002

- Assessed by ITI (UK) Competent Body, NVLAP (USA) Accreditation Body & ACA/AUSTEL (Australia), VCCI (Japan)
- Accredited by Industry Canada (Canada) under ACC-LAB (Europe/Canada MRA and APEC/Canada MRA)
- Recognized/Listed by FCC (USA)
- All test results contained in this engineering test report are traceable to National Institute of Standards and Technology (NIST)



### 6.11.5. Test Data

#### REMARKS:

The transmitter antenna conducted pre-scans showed there was no difference when the product operated with the following modes:

- (1) 12.5 kHz Channel Spacing, FM voice modulation
- (2) 12.5 kHz Channel Spacing, FM data modulation
- (3) 25 kHz Channel Spacing, FM voice modulation and
- (4) 25 kHz Channel Spacing, FM voice modulation

The EUT's configuration (1) was tested with the most stringent limit of  $50 + 10 \cdot \log(P \text{ in Watts})$  for the worst case.

#### 6.11.5.1. Lowest Frequency (136.10 MHz, 12.5 kHz Channel Spacing, RF Output Power: Hi)

Fundamental Frequency: 136.10 MHz, Narrow Band (12.5kHz channel spacing)  
 RF Output Power: 44.2 dBm or 26.3 Watts  
 Modulation: FM modulation with 2.5 kHz sine wave signal  
 FCC Limit:  $50 + 10 \cdot \log(26.3) = 64.2$  dBc (dB below the carrier)

FREQUENCY (MHz)	TRANSMITTER CONDUCTED ANTENNA EMISSIONS		LIMIT (dBc)	MARGIN (dB)	PASS/ FAIL
	(dBm)	(dBc)			
270.20	-49.0	-93.2	-64.2	-29.0	PASS
542.40	-50.7	-94.9	-64.2	-30.7	PASS

- The emissions were scanned from 10 MHz to 2 GHz and all emissions less than 30 dB below FCC Limits were recorded.
- Refer to plots # 13 & 14 for measurements details

#### 6.11.5.2. Middle Frequency (155.1 MHz, 12.5 kHz Channel Spacing, RF Output Power: Hi)

Fundamental Frequency: 155.1 MHz, Narrow Band (12.5kHz channel spacing)  
 RF Output Power: 44.2 dBm or 26.3 Watts  
 Modulation: FM modulation with 2.5 kHz sine wave signal  
 FCC Limit:  $50 + 10 \cdot \log(26.3) = 64.2$  dBc (dB below the carrier)

FREQUENCY (MHz)	TRANSMITTER CONDUCTED ANTENNA EMISSIONS		LIMIT (dBc)	MARGIN (dB)	PASS/ FAIL
	(dBm)	(dBc)			
310.20	-45.1	-89.3	-64.2	-25.1	PASS

- The emissions were scanned from 10 MHz to 2 GHz and all emissions less than 30 dB below FCC Limits were recorded.
- Refer to plots # 15 & 16 for measurements details

#### ULTRATECH GROUP OF LABS

3000 Bristol Circle, Oakville, Ontario, Canada L6H 6G4  
 Tel. #: 905-829-1570, Fax. #: 905-829-8050, Email: [vic@ultratech-labs.com](mailto:vic@ultratech-labs.com), Website: <http://www.ultratech-labs.com>

File #: ICOM35-FTX  
 Jan. 28, 2002

- Assessed by ITI (UK) Competent Body, NVLAP (USA) Accreditation Body & ACA/AUSTEL (Australia), VCCI (Japan)
- Accredited by Industry Canada (Canada) under ACC-LAB (Europe/Canada MRA and APEC/Canada MRA)
- Recognized/Listed by FCC (USA)
- All test results contained in this engineering test report are traceable to National Institute of Standards and Technology (NIST)

**6.11.5.3. Highest Frequency (155.1 MHz, 12.5 kHz Channel Spacing, RF Output Power: Hi)**

Fundamental Frequency: 173.9 MHz, Narrow Band (12.5kHz channel spacing)  
 RF Output Power: 44.0 dBm or 25.0 Watts  
 Modulation: FM modulation with 2.5 kHz sine wave signal  
 FCC Limit:  $50 + 10 \cdot \log(25.0) = 64.0$  dBc (dB below the carrier)

FREQUENCY (MHz)	TRANSMITTER CONDUCTED ANTENNA EMISSIONS		LIMIT (dBc)	MARGIN (dB)	PASS/ FAIL
	(dBm)	(dBc)			
347.80	-37.4	-81.4	-64.0	-17.4	PASS
521.70	-42.6	-86.6	-64.0	-22.6	PASS
<ul style="list-style-type: none"> <li>The emissions were scanned from 10 MHz to 2GHz and all emissions less than 30 dB below FCC Limits were recorded.</li> <li>Refer to plots # 17 &amp; 18 for measurements details</li> </ul>					

**ULTRATECH GROUP OF LABS**

3000 Bristol Circle, Oakville, Ontario, Canada L6H 6G4  
 Tel. #: 905-829-1570, Fax. #: 905-829-8050, Email: [vic@ultratech-labs.com](mailto:vic@ultratech-labs.com), Website: <http://www.ultratech-labs.com>

File #: ICOM35-FTX  
 Jan. 28, 2002

- Assessed by ITI (UK) Competent Body, NVLAP (USA) Accreditation Body & ACA/AUSTEL (Australia), VCCI (Japan)
- Accredited by Industry Canada (Canada) under ACC-LAB (Europe/Canada MRA and APEC/Canada MRA)
- Recognized/Listed by FCC (USA)
- All test results contained in this engineering test report are traceable to National Institute of Standards and Technology (NIST)

**6.11.5.4. Lowest Frequency (136.10 MHz, 12.5 kHz Channel Spacing, RF Output Power: Lo)**

Fundamental Frequency: 136.10 MHz, Narrow Band (12.5kHz channel spacing)  
 RF Output Power: 34.1 dBm or 2.6 Watts  
 Modulation: FM modulation with 2.5 kHz sine wave signal  
 FCC Limit:  $50 + 10 \cdot \log(2.6) = 54.2$  dBc (dB below the carrier)

FREQUENCY (MHz)	TRANSMITTER CONDUCTED ANTENNA EMISSIONS		LIMIT (dBc)	MARGIN (dB)	PASS/ FAIL
	(dBm)	(dBc)			
270.20	-50.4	-84.5	-54.2	-30.3	PASS
<ul style="list-style-type: none"> <li>The emissions were scanned from 10 MHz to 2 GHz and all emissions less than 30 dB below FCC Limits were recorded.</li> <li>Refer to plots # 19 &amp; 20 for measurements details</li> </ul>					

**6.11.5.5. Middle Frequency (155.1 MHz, 12.5 kHz Channel Spacing, RF Output Power: Lo)**

Fundamental Frequency: 155.1 MHz, Narrow Band (12.5kHz channel spacing)  
 RF Output Power: 34.3 dBm or 2.7 Watts  
 Modulation: FM modulation with 2.5 kHz sine wave signal  
 FCC Limit:  $50 + 10 \cdot \log(2.7) = 54.3$  dBc (dB below the carrier)

FREQUENCY (MHz)	TRANSMITTER CONDUCTED ANTENNA EMISSIONS		LIMIT (dBc)	MARGIN (dB)	PASS/ FAIL
	(dBm)	(dBc)			
10 MHz - 2 GHz	<-54.6	<-88.9	-54.3	<-34.6	PASS
<ul style="list-style-type: none"> <li>The emissions were scanned from 10 MHz to 2 GHz and all emissions less than 30 dB below FCC Limits were recorded.</li> <li>Refer to plots # 21 &amp; 22 for measurements details</li> </ul>					

**6.11.5.6. Highest Frequency (155.1 MHz, 12.5 kHz Channel Spacing, RF Output Power: Lo)**

Fundamental Frequency: 173.9 MHz, Narrow Band (12.5kHz channel spacing)  
 RF Output Power: 34.3 dBm or 2.7 Watts  
 Modulation: FM modulation with 2.5 kHz sine wave signal  
 FCC Limit:  $50 + 10 \cdot \log(25.0) = 54.3$  dBc (dB below the carrier)

FREQUENCY (MHz)	TRANSMITTER CONDUCTED ANTENNA EMISSIONS		LIMIT (dBc)	MARGIN (dB)	PASS/ FAIL
	(dBm)	(dBc)			
347.80	-43.9	-78.2	-54.3	-23.9	PASS
<ul style="list-style-type: none"> <li>The emissions were scanned from 10 MHz to 2 GHz and all emissions less than 30 dB below FCC Limits were recorded.</li> <li>Refer to plots # 23 &amp; 24 for measurements details</li> </ul>					

**ULTRATECH GROUP OF LABS**

3000 Bristol Circle, Oakville, Ontario, Canada L6H 6G4  
 Tel. #: 905-829-1570, Fax. #: 905-829-8050, Email: [vic@ultratech-labs.com](mailto:vic@ultratech-labs.com), Website: <http://www.ultratech-labs.com>

File #: ICOM35-FTX  
 Jan. 28, 2002

- Assessed by ITI (UK) Competent Body, NVLAP (USA) Accreditation Body & ACA/AUSTEL (Australia), VCCI (Japan)
- Accredited by Industry Canada (Canada) under ACC-LAB (Europe/Canada MRA and APEC/Canada MRA)
- Recognized/Listed by FCC (USA)
- All test results contained in this engineering test report are traceable to National Institute of Standards and Technology (NIST)

## 6.12. TRANSMITTER SPURIOUS/HARMONIC RADIATED EMISSIONS @ FCC 90.210

### 6.12.1. Limits @ FCC 90.210

Emissions shall be attenuated below the mean output power of the transmitter as follows:

FCC Rules	Frequency Range	Attenuation Limit (dBc)
90.210(b)&(c)	10 MHz to Lowest frequency of the radio to 10 <sup>th</sup> harmonic of the highest frequency of the radio	43+10*log(P)
90.210(d)	10 MHz to Lowest frequency of the radio to 10 <sup>th</sup> harmonic of the highest frequency of the radio	50+10*log(P) or 70 dBc whichever is less

### 6.12.2. Method of Measurements

Refer to Exhibit 8, § 8.2 of this report for measurement details

### 6.12.3. Test Equipment List

Test Instruments	Manufacturer	Model No.	Serial No.	Frequency Range
Spectrum Analyzer/ EMI Receiver	Advantest	R3271	15050203	100 Hz to 32 GHz with external mixer for frequency above 32 GHz
Microwave Amplifier	Hewlett Packard	HP 83017A	3116A00661	1 GHz to 26.5 GHz
Active Loop Antenna	EMCO	6507	8906-1167	1 kHz – 30 MHz
Biconilog Antenna	EMCO	3143	1029	20 MHz to 2 GHz
Horn Antenna	EMCO	3155	9701-5061	1 GHz – 18 GHz
Horn Antenna with Mixer	EMCO	3160-09	1007	18 GHz – 26.5 GHz
Horn Antenna with Mixer	EMCO	3160-10	1001	26.5 GHz – 40 GHz

### 6.12.4. Test Data

#### Remark:

- (1) The spurious/harmonic emissions from 25 kHz Channel Spacing operation was found to be the same as those of 12.5 kHz Channel Spacing operation. Therefore, 12.5 KHz Channel Spacing was chosen to be tested for worst case since it's limit is more stringent.
- (2) The RF Output Power was set to "hi" (26.3 Watts) for measuring the worst case of emissions
- (3) The emissions were scanned from 10 MHz to 2 GHz and all emissions within 20 dB below the limits were recorded.

#### ULTRATECH GROUP OF LABS

3000 Bristol Circle, Oakville, Ontario, Canada L6H 6G4  
 Tel. #: 905-829-1570, Fax. #: 905-829-8050, Email: [vic@ultratech-labs.com](mailto:vic@ultratech-labs.com), Website: <http://www.ultratech-labs.com>

File #: ICOM35-FTX  
 Jan. 28, 2002

- Assessed by ITI (UK) Competent Body, NVLAP (USA) Accreditation Body & ACA/AUSTEL (Australia), VCCI (Japan)
- Accredited by Industry Canada (Canada) under ACC-LAB (Europe/Canada MRA and APEC/Canada MRA)
- Recognized/Listed by FCC (USA)
- All test results contained in this engineering test report are traceable to National Institute of Standards and Technology (NIST)

**6.12.4.1. Lowest Frequency (136.10 MHz) - Hi Power**

Fundamental Frequency: 136.10 MHz, Narrow Band (12.5kHz channel spacing)  
 RF Output Power: 44.2 dBm or 26.3 Watts, ERP = 44.2 dBm - 2.15 dB = 42.1 dBm wrt. 0 dBi antenna gain  
 Modulation: FM modulation with 2.5 kHz sine wave signal  
 FCC Limit:  $50 + 10 \cdot \log(26.3) = 64.2$  dBc (dB below the carrier)

Frequency (MHz)	E-Field Level @3m (dBμV/m)	ERP Measured by Substitution Method		EMI Receiver Detector (Peak/QP)	Antenna Plane (H/V)	Limit (dBc)	Margin (dB)	Pass / Fail
		(dBm)	(dBc)					
408.30	68.6	-31.3	-73.4	PEAK	V	-64.2	-9.2	PASS
408.30	72.8	-31.3	-73.4	PEAK	H	-64.2	-9.2	PASS
544.40	64.2	-39.3	-81.4	PEAK	V	-64.2	-17.2	PASS
544.40	62.6	-42.0	-84.1	PEAK	H	-64.2	-19.9	PASS

➤ The rf emissions were scanned from 10 MHz to 2 GHz, all emissions less than 20 dB below the FCC limit (-20dBm or -64.2 dBc) were recorded.

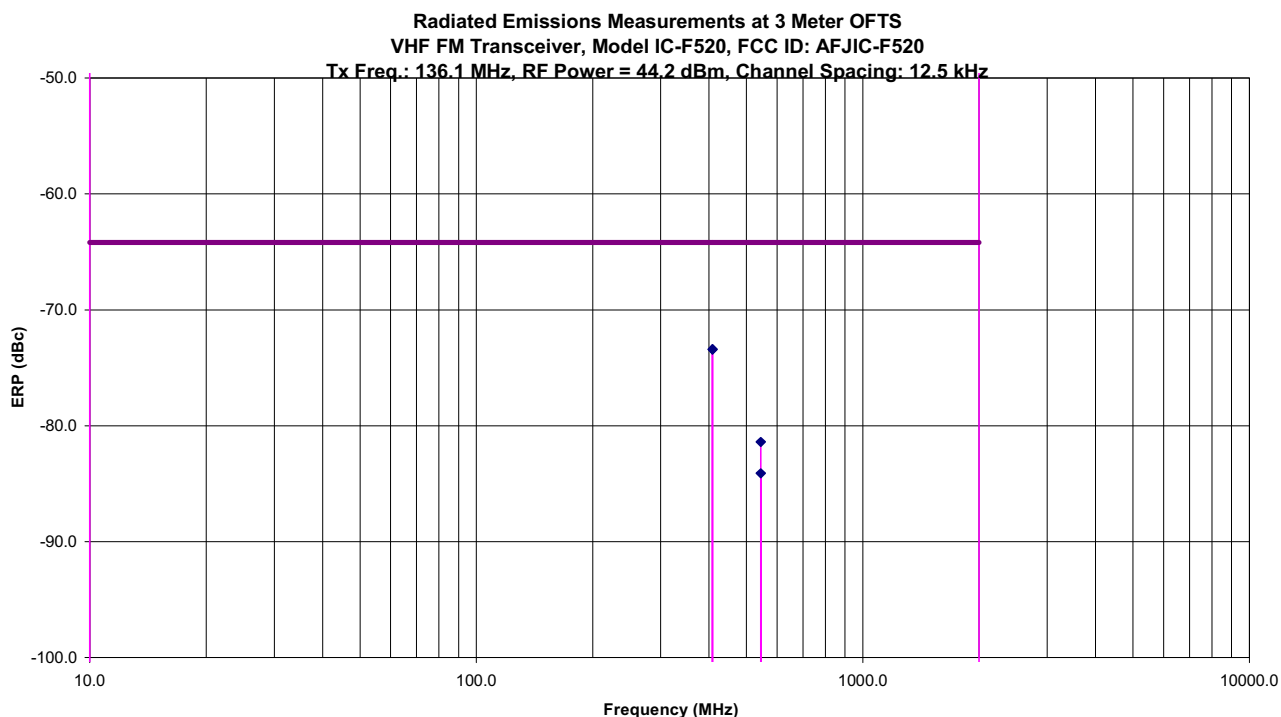

**ULTRATECH GROUP OF LABS**

3000 Bristol Circle, Oakville, Ontario, Canada L6H 6G4  
 Tel. #: 905-829-1570, Fax. #: 905-829-8050, Email: [vic@ultratech-labs.com](mailto:vic@ultratech-labs.com), Website: <http://www.ultratech-labs.com>

File #: ICOM35-FTX  
 Jan. 28, 2002

- Assessed by ITI (UK) Competent Body, NVLAP (USA) Accreditation Body & ACA/AUSTEL (Australia), VCCI (Japan)
- Accredited by Industry Canada (Canada) under ACC-LAB (Europe/Canada MRA and APEC/Canada MRA)
- Recognized/Listed by FCC (USA)
- All test results contained in this engineering test report are traceable to National Institute of Standards and Technology (NIST)

**6.12.4.2. Middle Frequency (155.10 MHz) - Hi Power**

Fundamental Frequency: 155.1 MHz, Narrow Band (12.5kHz channel spacing)  
 RF Output Power: 44.2 dBm or 26.3 Watts, , ERP = 44.2 dBm - 2.15 dB = 42.1 dBm wrt. 0 dBi antenna gain

Modulation: FM modulation with 2.5 kHz sine wave signal  
 FCC Limit:  $50 + 10 \cdot \log(26.3) = 64.2$  dBc (dB below the carrier)

Frequency (MHz)	E-Field Level @3m (dBμV/m)	ERP Measured by Substitution Method		EMI Receiver Detector (Peak/QP)	Antenna Plane (H/V)	Limit (dBc)	Margin (dB)	Pass / Fail
		(dBm)	(dBc)					
465.30	59.4	-42.5	-84.6	PEAK	V	-64.2	-20.4	PASS
465.30	63.3	-40.0	-82.1	PEAK	H	-64.2	-17.9	PASS
620.40	70.5	-32.1	-74.2	PEAK	V	-64.2	-10.0	PASS
620.40	67.6	-37.2	-79.3	PEAK	H	-64.2	-15.1	PASS

➤ The rf emissions were scanned from 10 MHz to 2GHz, all emissions less than 20 dB below the FCC limit (-20dBm or -64.2 dBc) were recorded.

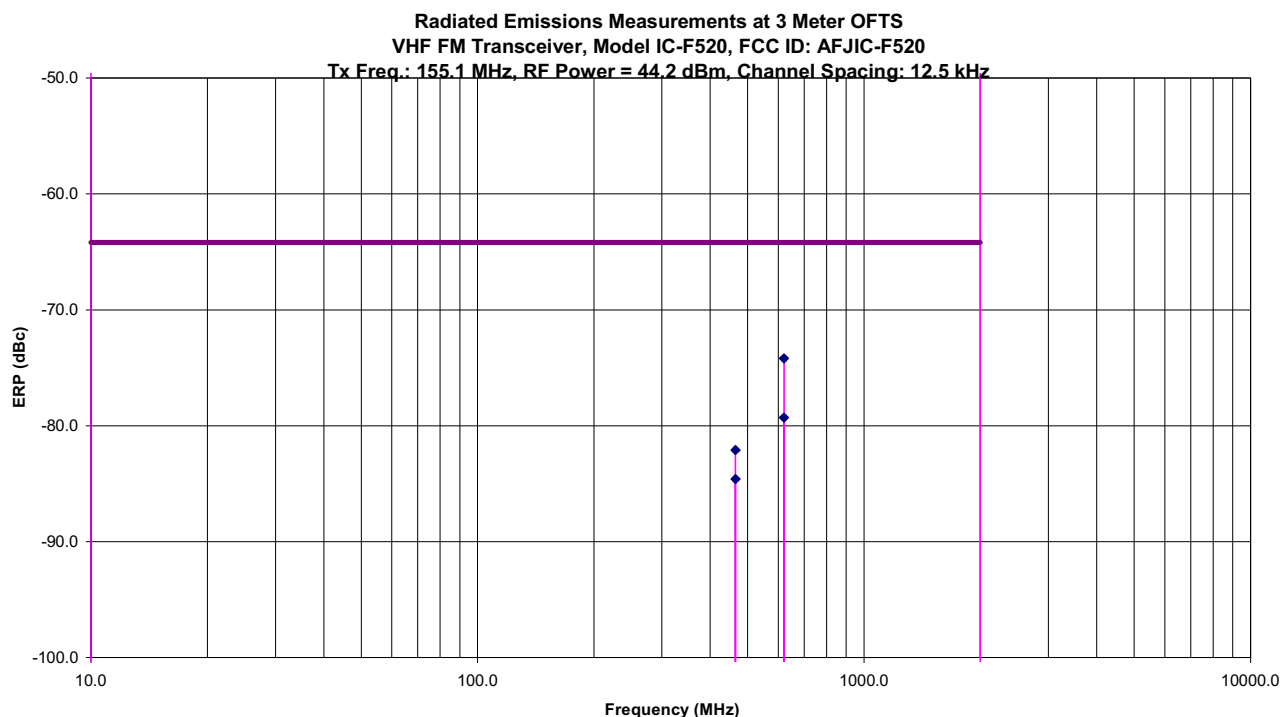

**ULTRATECH GROUP OF LABS**

3000 Bristol Circle, Oakville, Ontario, Canada L6H 6G4  
 Tel. #: 905-829-1570, Fax. #: 905-829-8050, Email: [vic@ultratech-labs.com](mailto:vic@ultratech-labs.com), Website: <http://www.ultratech-labs.com>

File #: ICOM35-FTX  
 Jan. 28, 2002

- Assessed by ITI (UK) Competent Body, NVLAP (USA) Accreditation Body & ACA/AUSTEL (Australia), VCCI (Japan)
- Accredited by Industry Canada (Canada) under ACC-LAB (Europe/Canada MRA and APEC/Canada MRA)
- Recognized/Listed by FCC (USA)
- All test results contained in this engineering test report are traceable to National Institute of Standards and Technology (NIST)

**6.12.4.3. Highest Frequency (173.90 MHz) - Hi Power**

Fundamental Frequency: 173.9 MHz, Narrow Band (12.5kHz channel spacing)  
 RF Output Power: 44.0 dBm or 25.0 Watts, , ERP = 44.0 dBm - 2.15 dB = 41.9 dBm wrt. 0 dBi antenna gain

Modulation: FM modulation with 2.5 kHz sine wave signal  
 FCC Limit:  $50 + 10 \cdot \log(25.0) = 64.0$  dBc (dB below the carrier)

Frequency (MHz)	E-Field Level @3m (dBμV/m)	ERP Measured by Substitution Method		EMI Receiver Detector (Peak/QP)	Antenna Plane (H/V)	Limit (dBc)	Margin (dB)	Pass / Fail
		(dBm)	(dBc)					
521.70	62.8	-41.6	-83.5	PEAK	V	-64.0	-19.5	PASS
521.70	56.1	-46.3	-88.2	PEAK	H	-64.0	-24.2	PASS
695.60	56.4	-43.8	-85.7	PEAK	V	-64.0	-21.7	PASS
695.60	55.0	-47.5	-89.4	PEAK	H	-64.0	-25.4	PASS

➤ The rf emissions were scanned from 10 MHz to 2GHz, all emissions less than 20 dB below the FCC limit (-20dBm or -64 dBc) were recorded.

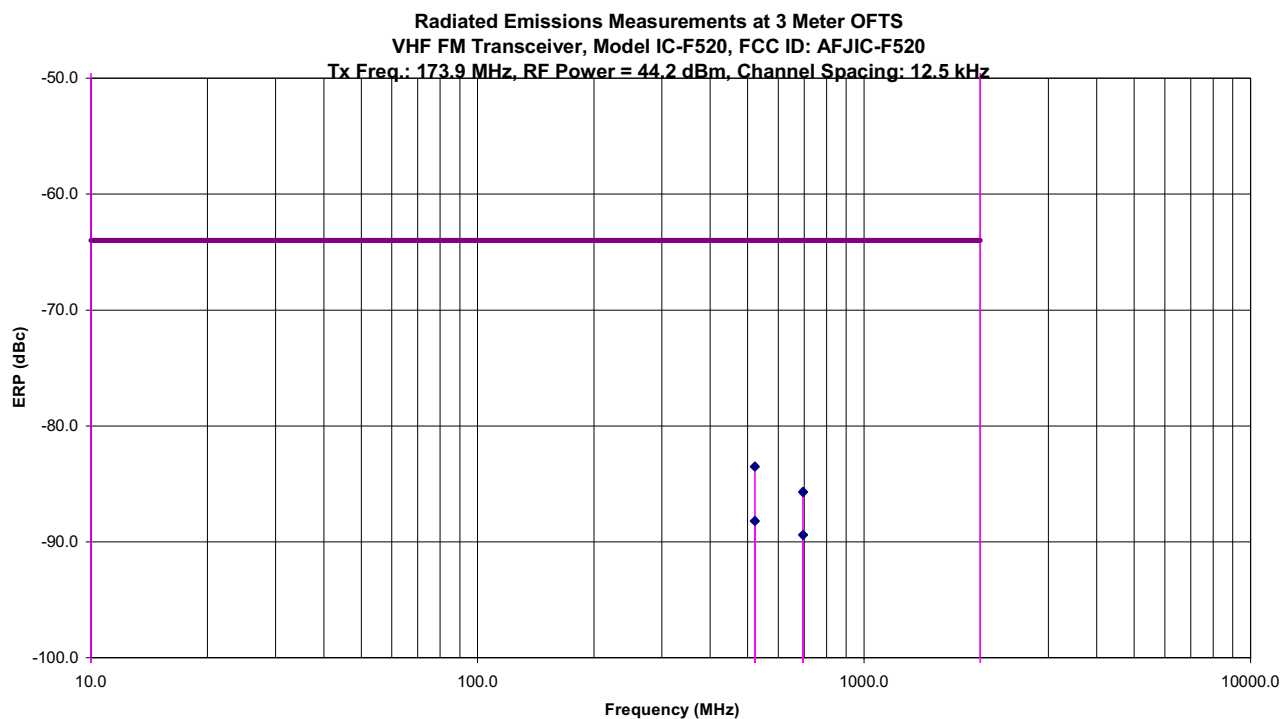

**ULTRATECH GROUP OF LABS**

3000 Bristol Circle, Oakville, Ontario, Canada L6H 6G4  
 Tel. #: 905-829-1570, Fax. #: 905-829-8050, Email: [vic@ultratech-labs.com](mailto:vic@ultratech-labs.com), Website: <http://www.ultratech-labs.com>

File #: ICOM35-FTX  
 Jan. 28, 2002

- Assessed by ITI (UK) Competent Body, NVLAP (USA) Accreditation Body & ACA/AUSTEL (Australia), VCCI (Japan)
- Accredited by Industry Canada (Canada) under ACC-LAB (Europe/Canada MRA and APEC/Canada MRA)
- Recognized/Listed by FCC (USA)
- All test results contained in this engineering test report are traceable to National Institute of Standards and Technology (NIST)

## 6.13. TRANSIENT FREQUENCY BEHAVIOR @ 90.214

### 6.13.1. Limits

Transient frequencies must be within the maximum frequency difference limits during the time intervals indicated:

Time intervals <sup>1, 2</sup>	Maximum frequency difference <sup>3</sup>	All equipment
		150 to 174 MHz
Transient Frequency Behavior for Equipment Designed to Operate on 25 kHz Channels		
$t_1$ <sup>4</sup>	± 25.0 kHz	5.0 ms
$t_2$ <sup>4</sup>	± 12.5 kHz	20.0 ms
$t_3$ <sup>4</sup>	± 25.0 kHz	5.0 ms
Transient Frequency Behavior for Equipment Designed to Operate on 12.5 kHz Channels		
$t_1$ <sup>4</sup>	± 12.5 kHz	5.0 ms
$t_2$ <sup>4</sup>	± 6.25 kHz	20.0 ms
$t_3$ <sup>4</sup>	± 12.5 kHz	5.0 ms

Notes:

- $t_{on}$  is the instant when a 1 kHz test signal is completely suppressed, including any capture time due to phasing.  
 $t_1$  is the time period immediately following  $t_{on}$ .  
 $t_2$  is the time period immediately following  $t_1$ .  
 $t_3$  is the time period from the instant when the transmitter is turned off until  $t_{off}$ .  
 $t_{off}$  is the instant when the 1 kHz test signal starts to rise.
- During the time from the end of  $t_2$  to the beginning of  $t_3$ , the frequency difference must not exceed the limits specified in § 90.213.
- Difference between the actual transmitter frequency and the assigned transmitter frequency.
- If the transmitter carrier output power rating is 6 watts or less, the frequency difference during this time period may exceed the maximum frequency difference for this time period.

### 6.13.2. Method of Measurements

Refer to Exhibit 8, § 8.6 of this test report and ANSI/TIA/EIA - 603 - 1992, Sec. 2.2.19, Page 83

---

#### ULTRATECH GROUP OF LABS

3000 Bristol Circle, Oakville, Ontario, Canada L6H 6G4  
 Tel. #: 905-829-1570, Fax. #: 905-829-8050, Email: [vic@ultratech-labs.com](mailto:vic@ultratech-labs.com), Website: <http://www.ultratech-labs.com>

File #: ICOM35-FTX  
 Jan. 28, 2002

- Assessed by ITI (UK) Competent Body, NVLAP (USA) Accreditation Body & ACA/AUSTEL (Australia), VCCI (Japan)
- Accredited by Industry Canada (Canada) under ACC-LAB (Europe/Canada MRA and APEC/Canada MRA)
- Recognized/Listed by FCC (USA)
- All test results contained in this engineering test report are traceable to National Institute of Standards and Technology (NIST)



### 6.13.3. Test Equipment List

Test Instruments	Manufacturer	Model No.	Serial No.	Frequency Range
Audio Signal Generator	Krohn-Hite	2000	462	0.03 Hz ~ 30 MHz
RF Synthesized Signal Generator	Fluke	6061A	4770301	10 kHz – 1050 MHz
Radio Communication Test Set	Marconi Instruments	2955	132037/226	400kHz - 1000 MHz
Network Combiner	Mini-Circuit	15542	--	DC to 32 GHz
Infinium Digitizing Oscilloscope	Hewlett Packard	54810A	US38380192	DC to 500 MHz, 1 Gsa/s
RF Detector	Amphenol	UG-1094/U1050	--	--
Attenuator	Weinschel Corp	2320-34	BH-7876	DC – 18 GHz

### 6.13.4. Test Arrangement

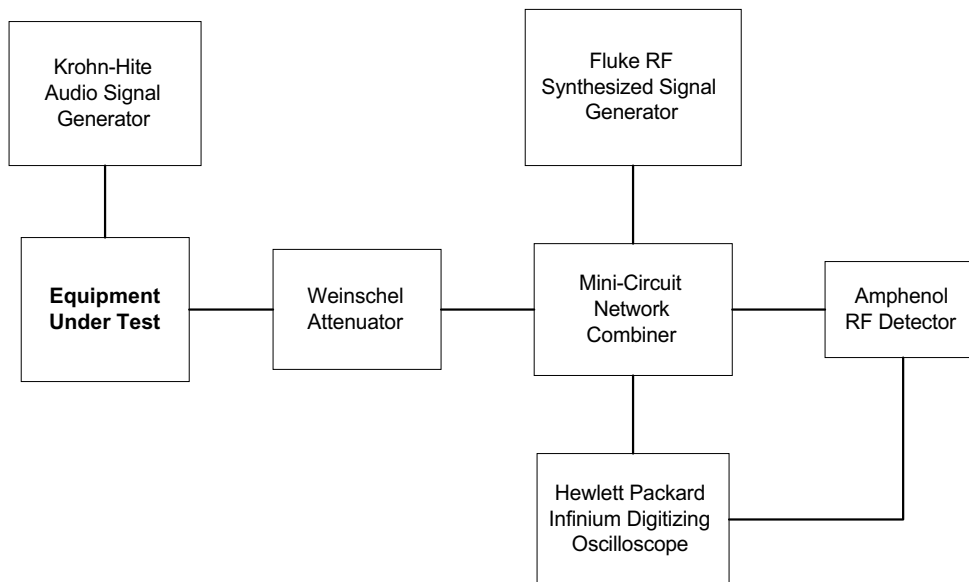

#### ULTRATECH GROUP OF LABS

3000 Bristol Circle, Oakville, Ontario, Canada L6H 6G4  
 Tel. #: 905-829-1570, Fax. #: 905-829-8050, Email: [vic@ultratech-labs.com](mailto:vic@ultratech-labs.com), Website: <http://www.ultratech-labs.com>

File #: ICOM35-FTX  
 Jan. 28, 2002

- Assessed by ITI (UK) Competent Body, NVLAP (USA) Accreditation Body & ACA/AUSTEL (Australia), VCCI (Japan)
- Accredited by Industry Canada (Canada) under ACC-LAB (Europe/Canada MRA and APEC/Canada MRA)
- Recognized/Listed by FCC (USA)
- All test results contained in this engineering test report are traceable to National Institute of Standards and Technology (NIST)

### 6.13.5. Test Data

**Remark:**

Test data plots for the following results can be found in Annex 1, plots # 25 to 32.

- **12.5 kHz Channel Spacing Operation**

Time Interval	Maximum Transient Frequency	Transient Frequency Limit
Test Configuration #1: FM with 1 kHz Sine Wave Signal, Freq Dev = $\pm 12.5$ kHz		
t <sub>1</sub> (5 ms) Switch ON Condition	4.0 kHz	12.5 kHz
t <sub>2</sub> (20 ms) Switch On Condition	0	12.5 kHz
After t <sub>2</sub> (5 ms) Switch On Condition	0	FCC Limit = $\pm 1100$ Hz (2.5 ppm @ 136.10 MHz)
Before t <sub>3</sub> (5 ms) Switch Off Condition	0	FCC Limit = $\pm 1100$ Hz (2.5 ppm @ 136.10 MHz)
t <sub>3</sub> (5 ms) Switch Off Condition	0	12.5 kHz
Test Configuration #2: Unmodulated		
t <sub>1</sub> (5 ms) Switch ON Condition	4.0kHz	12.5 kHz or no limit for RF Output Power < 6 Watts
t <sub>2</sub> (20 ms) Switch On Condition	0	12.5 kHz
After t <sub>2</sub> (5 ms) Switch On Condition	0	FCC Limit = $\pm 1000$ Hz (2.5 ppm @ 136.10 MHz)
Before t <sub>3</sub> (5 ms) Switch Off Condition	0	FCC Limit = $\pm 1000$ Hz (2.5 ppm @ 136.10 MHz)
t <sub>3</sub> (5 ms) Switch Off Condition	1.6 kHz	25 kHz or no limit for RF Output Power < 6 Watts

**ULTRATECH GROUP OF LABS**

3000 Bristol Circle, Oakville, Ontario, Canada L6H 6G4  
 Tel. #: 905-829-1570, Fax. #: 905-829-8050, Email: [vic@ultratech-labs.com](mailto:vic@ultratech-labs.com), Website: <http://www.ultratech-labs.com>

File #: ICOM35-FTX  
 Jan. 28, 2002

- Assessed by ITI (UK) Competent Body, NVLAP (USA) Accreditation Body & ACA/AUSTEL (Australia), VCCI (Japan)
- Accredited by Industry Canada (Canada) under ACC-LAB (Europe/Canada MRA and APEC/Canada MRA)
- Recognized/Listed by FCC (USA)
- All test results contained in this engineering test report are traceable to National Institute of Standards and Technology (NIST)

• **25 kHz Channel Spacing Operation**

Time Interval	Maximum Transient Frequency	Transient Frequency Limit
Test Configuration #1: FM with 1 kHz Sine Wave Signal, Freq Dev = $\pm 25$ kHz		
t <sub>1</sub> (5 ms) Switch ON Condition	+0.45	25 kHz
t <sub>2</sub> (20 ms) Switch On Condition	0	25 kHz
After t <sub>2</sub> (5 ms) Switch On Condition	0	FCC Limit = $\pm 680.5$ Hz (5 ppm @ 136.10 MHz)
Before t <sub>3</sub> (5 ms) Switch Off Condition	0	FCC Limit = $\pm 680.5$ Hz
t <sub>3</sub> (5 ms) Switch Off Condition	0	25 kHz
Test Configuration #2: Unmodulated		
t <sub>1</sub> (5 ms) Switch ON Condition	+3.125	25 kHz
t <sub>2</sub> (20 ms) Switch On Condition	0	25 kHz
After t <sub>2</sub> (5 ms) Switch On Condition	0	FCC Limit = $\pm 680.5$ Hz (5 ppm @ 136.10 MHz)
Before t <sub>3</sub> (5 ms) Switch Off Condition	0	FCC Limit = $\pm 680.5$ Hz (5 ppm @ 136.10 MHz)
t <sub>3</sub> (5 ms) Switch Off Condition	0	25 kHz

**ULTRATECH GROUP OF LABS**

3000 Bristol Circle, Oakville, Ontario, Canada L6H 6G4  
 Tel. #: 905-829-1570, Fax. #: 905-829-8050, Email: [vic@ultratech-labs.com](mailto:vic@ultratech-labs.com), Website: <http://www.ultratech-labs.com>

File #: ICOM35-FTX  
 Jan. 28, 2002

- Assessed by ITI (UK) Competent Body, NVLAP (USA) Accreditation Body & ACA/AUSTEL (Australia), VCCI (Japan)
- Accredited by Industry Canada (Canada) under ACC-LAB (Europe/Canada MRA and APEC/Canada MRA)
- Recognized/Listed by FCC (USA)
- All test results contained in this engineering test report are traceable to National Institute of Standards and Technology (NIST)

## EXHIBIT 7. MEASUREMENT UNCERTAINTY

The measurement uncertainties stated were calculated in accordance with the requirements of NIST Technical Note 1297 and NIS 81 (1994)

### 7.1. RADIATED EMISSION MEASUREMENT UNCERTAINTY

CONTRIBUTION (Radiated Emissions)	PROBABILITY DISTRIBUTION	UNCERTAINTY (+ dB)	
		3 m	10 m
Antenna Factor Calibration	Normal (k=2)	$\pm 1.0$	$\pm 1.0$
Cable Loss Calibration	Normal (k=2)	$\pm 0.3$	$\pm 0.5$
EMI Receiver specification	Rectangular	$\pm 1.5$	$\pm 1.5$
Antenna Directivity	Rectangular	+0.5	+0.5
Antenna factor variation with height	Rectangular	$\pm 2.0$	$\pm 0.5$
Antenna phase center variation	Rectangular	0.0	$\pm 0.2$
Antenna factor frequency interpolation	Rectangular	$\pm 0.25$	$\pm 0.25$
Measurement distance variation	Rectangular	$\pm 0.6$	$\pm 0.4$
Site imperfections	Rectangular	$\pm 2.0$	$\pm 2.0$
Mismatch: Receiver VRC $\Gamma_1 = 0.2$ Antenna VRC $\Gamma_R = 0.67(Bi) 0.3 (Lp)$ Uncertainty limits $20\text{Log}(1+\Gamma_1\Gamma_R)$	U-Shaped	+1.1 -1.25	$\pm 0.5$
System repeatability	Std. Deviation	$\pm 0.5$	$\pm 0.5$
Repeatability of EUT		-	-
Combined standard uncertainty	Normal	+2.19 / -2.21	+1.74 / -1.72
Expanded uncertainty U	Normal (k=2)	+4.38 / -4.42	+3.48 / -3.44

Calculation for maximum uncertainty when 3m biconical antenna including a factor of k=2 is used:

$$U = 2u_c(y) = 2x(+2.19) = +4.38 \text{ dB} \quad \text{And} \quad U = 2u_c(y) = 2x(-2.21) = -4.42 \text{ dB}$$

#### ULTRATECH GROUP OF LABS

3000 Bristol Circle, Oakville, Ontario, Canada L6H 6G4  
 Tel. #: 905-829-1570, Fax. #: 905-829-8050, Email: [vic@ultratech-labs.com](mailto:vic@ultratech-labs.com), Website: <http://www.ultratech-labs.com>

File #: ICOM35-FTX  
 Jan. 28, 2002

- Assessed by ITI (UK) Competent Body, NVLAP (USA) Accreditation Body & ACA/AUSTEL (Australia), VCCI (Japan)
- Accredited by Industry Canada (Canada) under ACC-LAB (Europe/Canada MRA and APEC/Canada MRA)
- Recognized/Listed by FCC (USA)
- All test results contained in this engineering test report are traceable to National Institute of Standards and Technology (NIST)

## EXHIBIT 8. MEASUREMENT METHODS

### 8.1. CONDUCTED POWER MEASUREMENTS

- The following shall be applied to the combination(s) of the radio device and its intended antenna(e).
- If the RF level is user adjustable, all measurements shall be made with the highest power level available to the user for that combination.
- The following method of measurement shall apply to both conducted and radiated measurements.
- The radiated measurements are performed at the Ultratech Calibrated Open Field Test Site.
- The measurement shall be performed using normal operation of the equipment with modulation.

Test procedure shall be as follows:

#### Step 1: Duty Cycle measurements if the transmitter's transmission is transient

- Using a EMI Receiver with the frequency span set to 0 Hz and the sweep time set at a suitable value to capture the envelope peaks and the duty cycle of the transmitter output signal;
- The duty cycle of the transmitter,  $x = \text{Tx on} / (\text{Tx on} + \text{Tx off})$  with  $0 < x < 1$ , is measure and recorded in the test report. For the purpose of testing, the equipment shall be operated with a duty cycle that is equal or more than 0.1.

#### Step 2: Calculation of Average EIRP. See Figure 1

- The average output power of the transmitter shall be determined using a wideband, calibrated RF average power meter with the power sensor with an integration period that exceeds the repetition period of the transmitter by a factor 5 or more. The observed value shall be recorded as "A" (in dBm);
- The e.i.r.p. shall be calculated from the above measured power output "A", the observed duty cycle x, and the applicable antenna assembly gain "G" in dBi, according to the formula:

$$\text{EIRP} = \text{A} + \text{G} + 10\log(1/x)$$

{ X = 1 for continuous transmission =>  $10\log(1/x) = 0 \text{ dB}$  }

Figure 1.

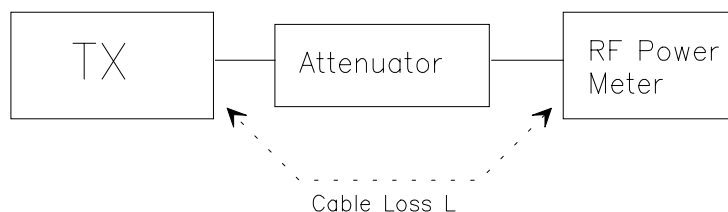

#### ULTRATECH GROUP OF LABS

3000 Bristol Circle, Oakville, Ontario, Canada L6H 6G4  
Tel. #: 905-829-1570, Fax. #: 905-829-8050, Email: [vic@ultratech-labs.com](mailto:vic@ultratech-labs.com), Website: <http://www.ultratech-labs.com>

File #: ICOM35-FTX  
Jan. 28, 2002

- Assessed by ITI (UK) Competent Body, NVLAP (USA) Accreditation Body & ACA/AUSTEL (Australia), VCCI (Japan)
- Accredited by Industry Canada (Canada) under ACC-LAB (Europe/Canada MRA and APEC/Canada MRA)
- Recognized/Listed by FCC (USA)
- All test results contained in this engineering test report are traceable to National Institute of Standards and Technology (NIST)

## 8.2. RADIATED POWER MEASUREMENTS (ERP & EIRP) USING SUBSTITUTION METHOD

### 8.2.1. Maximizing RF Emission Level (E-Field)

- (a) The measurements was performed with full rf output power and modulation.
- (b) Test was performed at listed 3m open area test site (listed with FCC, IC, ITI, NVLAP, ACA & VCCI).
- (c) The transmitter under test was placed at the specified height on a non-conducting turntable (80 cm height)
- (d) The BICONILOG antenna (20 MHz to 1 GHz) or HORN antenna (1 GHz to 18 GHz) was used for measuring.
- (e) Load an appropriate correction factors file in EMI Receiver for correcting the field strength reading level

Total Correction Factor recorded in the EMI Receiver = Cable Loss + Antenna Factor

$E \text{ (dBuV/m)} = \text{Reading (dBuV)} + \text{Total Correction Factor (dB/m)}$

- (f) Set the EMI Receiver and #2 as follows:

Center Frequency:	test frequency
Resolution BW:	100 kHz
Video BW:	same
Detector Mode:	positive
Average:	off
Span:	3 x the signal bandwidth

- (g) The test antenna was lowered or raised from 1 to 4 meters until the maximum signal level was detected.
- (h) The transmitter was rotated through  $360^\circ$  about a vertical axis until a higher maximum signal was received.
- (i) The test antenna was lowered or raised again from 1 to 4 meters until a maximum was obtained. This level was recorded.
- (j) The recorded reading was corrected to the true field strength level by adding the antenna factor, cable loss and subtracting the pre-amplifier gain.
- (k) The above steps were repeated with both transmitters' antenna and test receiving antenna placed in vertical and horizontal polarization. Both readings with the antennas placed in vertical and horizontal polarization shall be recorded.
- (l) Repeat for all different test signal frequencies

---

### ULTRATECH GROUP OF LABS

3000 Bristol Circle, Oakville, Ontario, Canada L6H 6G4  
Tel. #: 905-829-1570, Fax. #: 905-829-8050, Email: [vic@ultratech-labs.com](mailto:vic@ultratech-labs.com), Website: <http://www.ultratech-labs.com>

File #: ICOM35-FTX  
Jan. 28, 2002

- Assessed by ITI (UK) Competent Body, NVLAP (USA) Accreditation Body & ACA/AUSTEL (Australia), VCCI (Japan)
- Accredited by Industry Canada (Canada) under ACC-LAB (Europe/Canada MRA and APEC/Canada MRA)
- Recognized/Listed by FCC (USA)
- All test results contained in this engineering test report are traceable to National Institute of Standards and Technology (NIST)

## 8.2.2. Measuring the EIRP of Spurious/Harmonic Emissions using Substitution Method

- (a) Set the EMI Receiver (for measuring E-Field) and Receiver #2 (for measuring EIRP) as follows:

Center Frequency: equal to the signal source  
Resolution BW: 10 kHz  
Video BW: same  
Detector Mode: positive  
Average: off  
Span: 3 x the signal bandwidth

- (b) Load an appropriate correction factors file in EMI Receiver for correcting the field strength reading level

Total Correction Factor recorded in the EMI Receiver = Cable Loss + Antenna Factor  
 $E \text{ (dBuV/m)} = \text{Reading (dBuV)} + \text{Total Correction Factor (dB/m)}$

- (c) Select the frequency and E-field levels obtained in the Section 8.2.1 for ERP/EIRP measurements.  
(d) Substitute the EUT by a signal generator and one of the following transmitting antenna (substitution antenna):  
◆ DIPOLE antenna for frequency from 30-1000 MHz or  
◆ HORN antenna for frequency above 1 GHz }.  
(e) Mount the transmitting antenna at 1.5 meter high from the ground plane.  
(f) Use one of the following antenna as a receiving antenna:  
◆ DIPOLE antenna for frequency from 30-1000 MHz or  
◆ HORN antenna for frequency above 1 GHz }.  
(g) If the DIPOLE antenna is used, tune it's elements to the frequency as specified in the calibration manual.  
(h) Adjust both transmitting and receiving antenna in a VERTICAL polarization.  
(i) Tune the EMI Receivers to the test frequency.  
(j) Lower or raise the test antenna from 1 to 4 meters until the maximum signal level was detected.  
(k) The transmitter was rotated through 360° about a vertical axis until a higher maximum signal was received.  
(l) Lower or raise the test antenna from 1 to 4 meters until the maximum signal level was detected.  
(m) Adjust input signal to the substitution antenna until an equal or a known related level to that detected from the transmitter was obtained in the test receiver.  
(n) Record the power level read from the Average Power Meter and calculate the ERP/EIRP as follows:

$$P = P1 - L1 = (P2 + L2) - L1 = P3 + A + L2 - L1$$

$$EIRP = P + G1 = P3 + L2 - L1 + A + G1$$

$$ERP = EIRP - 2.15 \text{ dB}$$

$$\text{Total Correction factor in EMI Receiver \# 2} = L2 - L1 + G1$$

Where: P: Actual RF Power fed into the substitution antenna port after corrected.

P1: Power output from the signal generator

P2: Power measured at attenuator A input

P3: Power reading on the Average Power Meter

EIRP: EIRP after correction

ERP: ERP after correction

- (o) Adjust both transmitting and receiving antenna in a HORIZONTAL polarization, then repeat step (k) to (o)  
(p) Repeat step (d) to (o) for different test frequency  
(q) Repeat steps (c) to (j) with the substitution antenna oriented in horizontal polarization.  
(r) Actual gain of the EUT's antenna is the difference of the measured EIRP and measured RF power at the RF port. Correct the antenna gain if necessary.:

---

### ULTRATECH GROUP OF LABS

3000 Bristol Circle, Oakville, Ontario, Canada L6H 6G4

Tel. #: 905-829-1570, Fax. #: 905-829-8050, Email: [vic@ultratech-labs.com](mailto:vic@ultratech-labs.com), Website: <http://www.ultratech-labs.com>

File #: ICOM35-FTX

Jan. 28, 2002

- Assessed by ITI (UK) Competent Body, NVLAP (USA) Accreditation Body & ACA/AUSTEL (Australia), VCCI (Japan)
- Accredited by Industry Canada (Canada) under ACC-LAB (Europe/Canada MRA and APEC/Canada MRA)
- Recognized/Listed by FCC (USA)
- All test results contained in this engineering test report are traceable to National Institute of Standards and Technology (NIST)

Figure 2

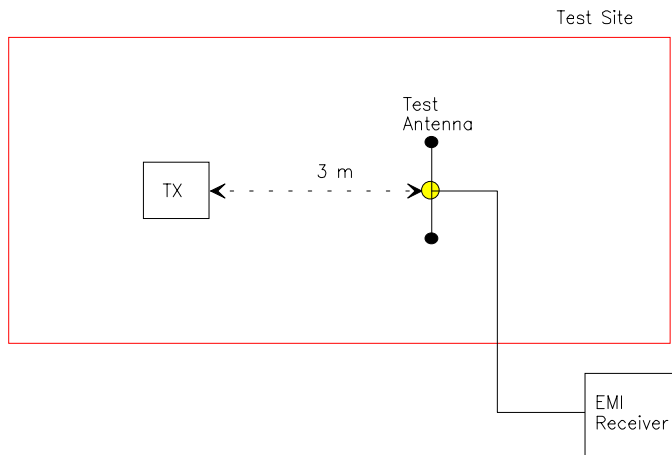
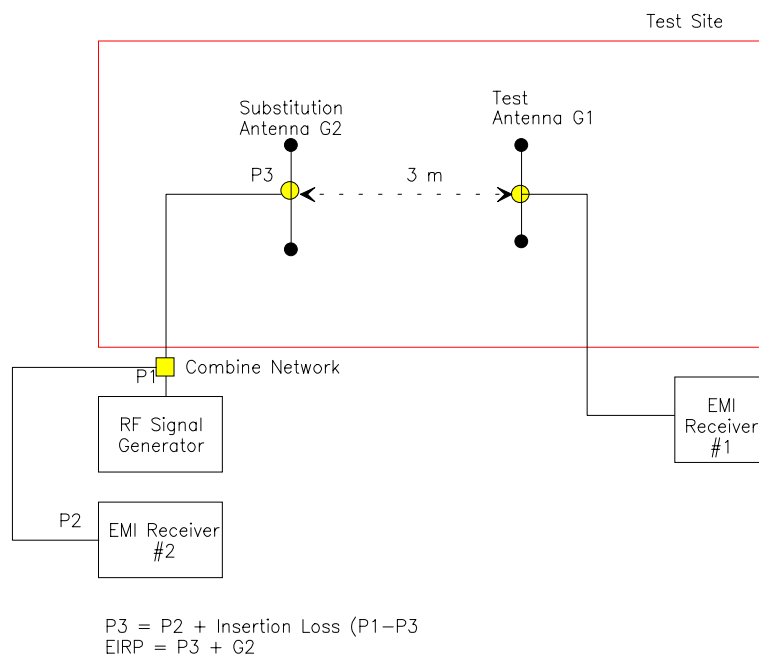

Figure 3



**ULTRATECH GROUP OF LABS**

3000 Bristol Circle, Oakville, Ontario, Canada L6H 6G4  
 Tel. #: 905-829-1570, Fax. #: 905-829-8050, Email: [vic@ultratech-labs.com](mailto:vic@ultratech-labs.com), Website: <http://www.ultratech-labs.com>

File #: ICOM35-FTX  
 Jan. 28, 2002

- Assessed by ITI (UK) Competent Body, NVLAP (USA) Accreditation Body & ACA/AUSTEL (Australia), VCCI (Japan)
- Accredited by Industry Canada (Canada) under ACC-LAB (Europe/Canada MRA and APEC/Canada MRA)
- Recognized/Listed by FCC (USA)
- All test results contained in this engineering test report are traceable to National Institute of Standards and Technology (NIST)



### 8.3. FREQUENCY STABILITY

Refer to FCC @ 2.1055.

- (a) The frequency stability shall be measured with variation of ambient temperature as follows: From -30 to +50 centigrade except that specified in subparagraph (2) & (3) of this paragraph.
- (b) Frequency measurements shall be made at extremes of the specified temperature range and at intervals of not more than 10 centigrade through the range. A period of time sufficient to stabilize all of the components of the oscillator circuit at each temperature level shall be allowed prior to frequency measurement. The short-term transient effects on the frequency of the transmitter due to keying (except for broadcast transmitters) and any heating element cycling normally occurring at each ambient temperature level also shall be shown. Only the portion or portions of the transmitter containing the frequency determining and stability circuitry need be subjected to the temperature variation test.
- (d) The frequency stability supply shall be measured with variation of primary supply voltage as follows:
  - (1) Vary primary supply voltage from 85 to 115 percent of the nominal value for other than hand carried battery equipment.
  - (2) For hand carried, battery powered equipment, reduce primary supply voltage to the battery operating end point which shall be specified by the manufacturer.
  - (3) The supply voltage shall be measured at the input to the cable normally provide with the equipment, or at the power supply terminals if cables are not normally provided. Effects on frequency of transmitter keying (except for broadcast transmitters) and any heating element cycling at the nominal supply voltage and at each extreme also shall be shown.
- (e) When deemed necessary, the Commission may require tests of frequency stability under conditions in addition to those specifically set out in paragraphs (a), (b), (c) and (d) of this section. (For example, measurements showing the effect of proximity to large metal objects, or of various types of antennas, may be required for portable equipment).

---

#### ULTRATECH GROUP OF LABS

3000 Bristol Circle, Oakville, Ontario, Canada L6H 6G4  
Tel. #: 905-829-1570, Fax. #: 905-829-8050, Email: [vic@ultratech-labs.com](mailto:vic@ultratech-labs.com), Website: <http://www.ultratech-labs.com>

File #: ICOM35-FTX  
Jan. 28, 2002

- Assessed by ITI (UK) Competent Body, NVLAP (USA) Accreditation Body & ACA/AUSTEL (Australia), VCCI (Japan)
- Accredited by Industry Canada (Canada) under ACC-LAB (Europe/Canada MRA and APEC/Canada MRA)
- Recognized/Listed by FCC (USA)
- All test results contained in this engineering test report are traceable to National Institute of Standards and Technology (NIST)

## 8.4. EMISSION MASK

**Voice or Digital Modulation Through a Voice Input Port @ 2.1049(c)(1)**- The transmitter was modulated by a 2.5 KHz tone signal at an input level 16 dB greater than that required to produce 50% modulation (e.g.  $\pm 2.5$  KHz peak deviation at 1 KHz modulating frequency). The input level was established at the frequency of maximum response of the audio modulating circuit.

**Digital Modulation Through a Data Input Port @ 2.1049(h)**- Transmitters employing digital modulation techniques - when modulated by an input signal such that its amplitude and symbol rate represent the maximum rated conditions under which the equipment will be operated. The signal shall be applied through any filter networks, pseudo-random generators or other devices required in normal service. Additionally, the Emission Masks shall be shown for operation with any devices used for modifying the spectrum when such devices are operational at the discretion of the user.

The following EMI Receiver bandwidth shall be used for measurement of Emission Mask/Out-of-Band Emission Measurements:

- (1) For 25 kHz Channel Spacing: RBW = 300 Hz
- (2) For 12.5 kHz or 6.25 kHz Channel Spacings: RBW = 100 Hz

The all cases the Video Bandwidth shall be equal or greater than the measuring bandwidth.

## 8.5. SPURIOUS EMISSIONS (CONDUCTED)

With transmitter modulation characteristics described in Out-of-Band Emissions measurements @ 2.1049, the transmitter spurious and harmonic emissions were scanned. The spurious and harmonic emissions were measured with the EMI Receiver controls set as RBW = 30 kHz minimum , VBW  $\geq$  RBW and SWEEP TIME = AUTO). The transmitter was operated at a full rated power output, and modulated as follows:

**FCC 47 CFR, Para. 2.1057 - Frequency spectrum to be investigated**- The spectrum was investigated from the lowest radio generated in the equipment up to at least the 10<sup>th</sup> harmonic of the carrier frequency or to the highest frequency practicable in the present state of the art of measuring techniques, whichever is lower. Particular attention should be paid to harmonics and subharmonics of the carrier frequency. Radiation at the frequencies of multiplier stages should be checked. The amplitude of spurious emissions which are attenuated more than 20 dB below the permissible value need not be reported.

**FCC 47 CFR, Para. 2.1051 - Spurious Emissions at Antenna Terminal**- The radio frequency voltage or powers generated within the equipment and appearing on a spurious frequency shall be checked at the equipment output terminals when properly loaded with a suitable artificial antenna. Curves or equivalent data shall show the magnitude of the harmonic and other spurious emission that can be detected when the equipment is operated under the conditions specified in 2.1049 as appropriate. The magnitude of spurious emissions which are attenuated more than 20 dB below the permissible value need not be specified.

---

### ULTRATECH GROUP OF LABS

3000 Bristol Circle, Oakville, Ontario, Canada L6H 6G4  
Tel. #: 905-829-1570, Fax. #: 905-829-8050, Email: [vic@ultratech-labs.com](mailto:vic@ultratech-labs.com), Website: <http://www.ultratech-labs.com>

File #: ICOM35-FTX  
Jan. 28, 2002

- Assessed by ITI (UK) Competent Body, NVLAP (USA) Accreditation Body & ACA/AUSTEL (Australia), VCCI (Japan)
- Accredited by Industry Canada (Canada) under ACC-LAB (Europe/Canada MRA and APEC/Canada MRA)
- Recognized/Listed by FCC (USA)
- All test results contained in this engineering test report are traceable to National Institute of Standards and Technology (NIST)

## 8.6. TRANSIENT FREQUENCY BEHAVIOR

1. Connect the transmitter under tests as shown in the above block diagram
2. Set the signal generator to the assigned frequency and modulate with a 1 kHz tone at  $\pm 12.5$  kHz deviation and its output level to be 50 dB below the transmitter rf output at the test receiver end.
3. Set the horizontal sweep rate on the storage scope to 10 milliseconds per division and adjust the display to continuously view the 1000 Hz tone from the Demodulator Output Port (DOP) of the Test Receiver. Adjust the vertical scale amplitude control of the scope to display the 1000 Hz at  $\pm 4$  divisions vertical Center at the display.
4. Adjust the scope so it will trigger on an increasing magnitude from the RF trigger signal of the transmitter under test when the transmitter was turned on. Set the controls to store the display.
5. The output at the DOP, due to the change in the ratio of the power between the signal generator input power and transmitter output power will, because of the capture effect of the test receiver, produce a change in display: For the first part of the sweep it will show the 1 kHz test signal. Then once the receiver's demodulator has been captured by the transmitter power, the display will show the frequency difference from the assigned frequency to the actual transmitter frequency versus time. The instant when the 1 kHz test signal is completely suppressed (including any capture time due to phasing) is considered to be  $t_m$ . The trace should be maintained within the allowed divisions during the period  $t_1$  and  $t_2$ .
6. During the time from the end of  $t_2$  to the beginning of  $t_3$  the frequency difference should not exceed the limits set by the FCC in Part 90.214 and the outlined in the Carrier Frequency Stability sections. The allowed limit is equal to FCC frequency tolerance limits specified in FCC 90.213.
7. Repeat the above steps when the transmitter was turned off for measuring  $t_3$ .

---

### ULTRATECH GROUP OF LABS

3000 Bristol Circle, Oakville, Ontario, Canada L6H 6G4  
Tel. #: 905-829-1570, Fax. #: 905-829-8050, Email: [vic@ultratech-labs.com](mailto:vic@ultratech-labs.com), Website: <http://www.ultratech-labs.com>

File #: ICOM35-FTX  
Jan. 28, 2002

- Assessed by ITI (UK) Competent Body, NVLAP (USA) Accreditation Body & ACA/AUSTEL (Australia), VCCI (Japan)
- Accredited by Industry Canada (Canada) under ACC-LAB (Europe/Canada MRA and APEC/Canada MRA)
- Recognized/Listed by FCC (USA)
- All test results contained in this engineering test report are traceable to National Institute of Standards and Technology (NIST)