

MFA **M. Flom Associates, Inc. - Global Compliance Center**
3356 North San Marcos Place, Suite 107, Chandler, Arizona 85225-7176
www.mflom.com general@mflom.com (480) 926-3100, FAX: 926-3598

Date: March 17, 2000

Federal Communications Commission
Via: Electronic Filing

Attention: Authorization & Evaluation Division

Applicant: Icom Incorporated
Equipment: IC-F4TR-3
FCC ID: AFJIC-F4TR-3
FCC Rules: 90

Gentlemen:

On behalf of the Applicant, enclosed please find Application Form 731, Engineering Test Report and all pertinent documentation, the whole for approval of the referenced equipment as shown.

Filing fees are attached.

We trust the same is in order. Should you need any further information, kindly contact the writer who is authorized to act as agent.

Sincerely yours,



William H. Graff, Director
of Engineering

enclosure(s)
cc: Applicant
WHG/cvr

LIST OF EXHIBITS
(FCC **CERTIFICATION** (TRANSMITTERS) - REVISED 9/28/98)

APPLICANT: Icom Incorporated

FCC ID: AFJIC-F4TR-3

BY APPLICANT:

1. LETTER OF AUTHORIZATION
2. IDENTIFICATION DRAWINGS, 2.1033(c)(11)
 - LABEL
 - LOCATION OF LABEL
 - COMPLIANCE STATEMENT
 - LOCATION OF COMPLIANCE STATEMENT
3. PHOTOGRAPHS, 2.1033(c)(12)
4. DOCUMENTATION: 2.1033(c)
 - (3) USER MANUAL
 - (9) TUNE UP INFO
 - (10) SCHEMATIC DIAGRAM
 - (10) CIRCUIT DESCRIPTION
 - BLOCK DIAGRAM
 - PARTS LIST
 - ACTIVE DEVICES
5. PART 90.203(e) & (g) ATTESTATION

BY M.F.A. INC.

- A. TESTIMONIAL & STATEMENT OF CERTIFICATION
- B. STATEMENT OF QUALIFICATIONS

MFA **M. Flom Associates, Inc. - Global Compliance Center**
3356 North San Marcos Place, Suite 107, Chandler, Arizona 85225-7176
www.mflom.com general@mflom.com (480) 926-3100, FAX: 926-3598

Sub-part
2.1033 (c) :

EQUIPMENT IDENTIFICATION

FCC ID: AFJIC-F4TR-3

NAMEPLATE DRAWING

ATTACHED, EXHIBIT 1.

LOCATION

AS PER LABEL DRAWING(S)

DATE OF REPORT

March 17, 2000

SUPERVISED BY:



William H. Graff, Director
of Engineering

THE APPLICANT HAS BEEN CAUTIONED AS TO THE FOLLOWING:

15.21 INFORMATION TO USER.

The users manual or instruction manual for an intentional radiator shall caution the user that changes or modifications not expressly approved by the party responsible for compliance could void the user's authority to operate the equipment.

15.27(a) SPECIAL ACCESSORIES.

Equipment marketed to a consumer must be capable of complying with the necessary regulations in the configuration in which the equipment is marketed. Where special accessories, such as shielded cables and/or special connectors are required to enable an unintentional or intentional radiator to comply with the emission limits in this part, the equipment must be marketed with, i.e. shipped and sold with, those special accessories. However, in lieu of shipping or packaging the special accessories with the unintentional or intentional radiator, the responsible party may employ other methods of ensuring that the special accessories are provided to the consumer, without additional charge.

Information detailing any alternative method used to supply the special accessories for a grant of equipment authorization or retained in the verification records, as appropriate. The party responsible for the equipment, as detailed in § 2.909 of this chapter, shall ensure that these special accessories are provided with the equipment. The instruction manual for such devices shall include appropriate instructions on the first page of text concerned with the installation of the device that these special accessories must be used with the device. It is the responsibility of the user to use the needed special accessories supplied with the equipment.

TABLE OF CONTENTS

<u>RULE</u>	<u>DESCRIPTION</u>	<u>PAGE</u>
	Test Report	1
2.1033(c)	General Information Required	2
2.1033(c)(14)	Rule Summary	5
	Standard Test Conditions and Engineering Practices	6
2.1046(a)	Carrier Output Power (Conducted)	7
2.1051	Unwanted Emissions (Transmitter Conducted)	9
2.1053(a)	Field Strength of Spurious Radiation	13
2.1049(c)(1)	Emission Masks (Occupied Bandwidth)	16
90.214	Transient Frequency Behavior	20
2.1047(a)	Audio Low Pass Filter (Voice Input)	30
2.1047(a)	Audio Frequency Response	33
2.1047(b)	Modulation Limiting	35
2.1055(a)(1)	Frequency Stability (Temperature Variation)	38
2.1055(b)(1)	Frequency Stability (Voltage Variation)	41
2.202(g)	Necessary Bandwidth and Emission Bandwidth	42

PAGE NO. 1 of 42.

Required information per ISO/IEC Guide 25-1990, paragraph 13.2:

- a) TEST REPORT
- b) Laboratory: M. Flom Associates, Inc.
 (FCC: 31040/SIT) 3356 N. San Marcos Place, Suite 107
 (Canada: IC 2044) Chandler, AZ 85224
- c) Report Number: d0030055
- d) Client: Icom America, Inc.
 2380 - 116th Ave. N. E.
 P.O. C-90029
 Bellevue, Washington 98009-9029
- e) Identification: IC-F4TR-3
 FCC ID: AFJIC-F4TR-3
 Description: UHF-FM Handheld Transceiver
- f) EUT Condition: Not required unless specified in individual tests.
- g) Report Date: March 17, 2000
 EUT Received: March 3, 2000
- h, j, k): As indicated in individual tests.
- i) Sampling method: No sampling procedure used.
- l) Uncertainty: In accordance with MFA internal quality manual.
- m) Supervised by:
- 
 William H. Graff, Director
 of Engineering
- n) Results: The results presented in this report relate only to the item tested.
- o) Reproduction: This report must not be reproduced, except in full, without written permission from this laboratory.

PAGE NO.

2 of 42.

LIST OF GENERAL INFORMATION REQUIRED FOR CERTIFICATION

IN ACCORDANCE WITH FCC RULES AND REGULATIONS,
VOLUME II, PART 2 AND TO

90

Sub-part 2.1033(c) (1): NAME AND ADDRESS OF APPLICANT:

Icom Incorporated
1-6-19 Kamikurazukuri
Hirano-ku
Osaka, Japan 547

MANUFACTURER:

Applicant

(c) (2): FCC ID: AFJIC-F4TR-3MODEL NO: IC-F4TR-3(c) (3): INSTRUCTION MANUAL(S):

PLEASE SEE ATTACHED EXHIBITS

(c) (4): TYPE OF EMISSION: 16K0F3E, 11K0F3E(c) (5): FREQUENCY RANGE, MHz: 480 to 512(c) (6): POWER RATING, Watts: 1 to 4
x Switchable Variable N/A

FCC GRANT NOTES: **BF** - The output power is continuously
variable from the value listed above to
20% - 25% of the value listed.

(c) (7): MAXIMUM POWER RATING, Watts: 300

M. Flom Associates, Inc. is accredited by the American Association for Laboratory Association (A2LA) as shown in the scope below.



THE AMERICAN ASSOCIATION FOR LABORATORY ACCREDITATION

ACCREDITED LABORATORY

A2LA has accredited

M. FLOM ASSOCIATES, INC.
Chandler, AZ

for technical competence in the field of

Electrical (EMC) Testing

The accreditation covers the specific tests and types of tests listed on the agreed scope of accreditation. This laboratory meets the requirements of ISO/IEC Guide 25-1990 "General Requirements for the Competence of Calibration and Testing Laboratories" (equivalent to relevant requirements of the ISO 9000 series of standards) and any additional program requirements in the identified field of testing.

Presented this 24th day of November, 1998.



Peter Abney
President
For the Accreditation Council
Certificate Number 1008.01
Valid to December 31, 2000

For tests or types of tests to which this accreditation applies, please refer to the laboratory's Electrical (EMC) Scope of Accreditation



American Association for Laboratory Accreditation

SCOPE OF ACCREDITATION TO ISO/IEC GUIDE 25-1990 AND EN 45001

M. FLOM ASSOCIATES, INC.
Electronic Testing Laboratory
3356 North San Marcos Place, Suite 107
Chandler, AZ 85225
Morton Flom Phone: 480 926 3100

ELECTRICAL (EMC)

Valid to: December 31, 2000 Certificate Number: 1008-01

In recognition of the successful completion of the A2LA evaluation process, accreditation is granted to this laboratory to perform the following electromagnetic compatibility tests:

Tests	Standard(s)
RF Emissions	FCC Part 15 (Subparts B and C) using ANSI C63.4-1992; CISPR 11; CISPR 13; CISPR 14; CISPR 22; EN 55011; EN 55013; EN 55014; EN 55022; EN 50081-1; EN 50081-2; FCC Part 18; ICES-003; AS/NZS 1044; AS/NZS 1053; AS/NZS 3548; AS/NZS 4251.1; CNS 13438
RF Immunity	EN 50082-1; EN 50082-2; AS/NZS 4251.1
Radiated Susceptibility	EN 61000-4-3; ENV 50140; ENV 50204; IEC 1000-4-3; IEC 801-3
ESD	EN 61000-4-2; IEC 1000-4-2; IEC 801-2
EFT	EN 61000-4-4; IEC 1000-4-4; IEC 801-4
Surge	EN 61000-4-5; ENV 50142; IEC 1000-4-5; IEC 801-5
47 CFR (FCC)	2, 21, 22, 23, 24, 74, 80, 87, 90, 95, 97

Revised 2/2/2000

Peter Abney

5301 Buckeystown Pike, Suite 350 • Frederick, MD 21704-8370 • Phone: 301 644 3248 • Fax: 301 662 2974

"This laboratory is accredited by the American Association for Laboratory Accreditation (A2LA) and the results shown in this report have been determined in accordance with the laboratory's terms of accreditation unless stated otherwise in the report."

Should this report contain any data for tests for which we are not accredited, or which have been undertaken by a subcontractor that is not A2LA accredited, such data would not covered by this laboratory's A2LA accreditation.

PAGE NO. 4 of 42.

Subpart 2.1033 (continued)

(c) (8): VOLTAGES & CURRENTS IN ALL ELEMENTS IN FINAL R. F. STAGE, INCLUDING FINAL TRANSISTOR OR SOLID STATE DEVICE:

COLLECTOR CURRENT, A = per manual
 COLLECTOR VOLTAGE, Vdc = per manual
 SUPPLY VOLTAGE, Vdc = 9.6

(c) (9): TUNE-UP PROCEDURE:

PLEASE SEE ATTACHED EXHIBITS

(c) (10): CIRCUIT DIAGRAM/CIRCUIT DESCRIPTION:

Including description of circuitry & devices provided for determining and stabilizing frequency, for suppression of spurious radiation, for limiting modulation and limiting power.

PLEASE SEE ATTACHED EXHIBITS

(c) (11): LABEL INFORMATION:

PLEASE SEE ATTACHED EXHIBITS

(c) (12): PHOTOGRAPHS:

PLEASE SEE ATTACHED EXHIBITS

(c) (13): DIGITAL MODULATION DESCRIPTION:

ATTACHED EXHIBITS
x N/A

(c) (14): TEST AND MEASUREMENT DATA:

FOLLOWS

PAGE NO.

5 of 42.

Sub-part

2.1033(c) (14):

TEST AND MEASUREMENT DATA

All tests and measurement data shown were performed in accordance with FCC Rules and Regulations, Volume II; Part 2, Sub-part J, Sections 2.947, 2.1033(c), 2.1041, 2.1046, 2.1047, 2.1079, 2.1051, 2.1053, 2.1055, 2.1057 and the following individual Parts:

- _____ 21 - Domestic Public Fixed Radio Services
- _____ 22 - Public Mobile Services
- _____ 22 Subpart H - Cellular Radiotelephone Service
- _____ 22.901(d) - Alternative technologies and auxiliary services
- _____ 23 - International Fixed Public Radiocommunication services
- _____ 24 - Personal Communications Services
- _____ 74 Subpart H - Low Power Auxiliary Stations
- _____ 80 - Stations in the Maritime Services
- _____ 80 Subpart E - General Technical Standards
- _____ 80 Subpart F - Equipment Authorization for Compulsory Ships
- _____ 80 Subpart K - Private Coast Stations and Marine Utility Stations
- _____ 80 Subpart S - Compulsory Radiotelephone Installations for Small Passenger Boats
- _____ 80 Subpart T - Radiotelephone Installation Required for Vessels on the Great Lakes
- _____ 80 Subpart U - Radiotelephone Installations Required by the Bridge-to-Bridge Act
- _____ 80 Subpart V - Emergency Position Indicating Radiobeacons (EPIRB'S)
- _____ 80 Subpart W - Global Maritime Distress and Safety System (GMDSS)
- _____ 80 Subpart X - Voluntary Radio Installations
- _____ 87 - Aviation Services
- x 90 - Private Land Mobile Radio Services
- _____ 94 - Private Operational-Fixed Microwave Service
- _____ 95 Subpart A - General Mobile Radio Service (GMRS)
- _____ 95 Subpart C - Radio Control (R/C) Radio Service
- _____ 95 Subpart D - Citizens Band (CB) Radio Service
- _____ 95 Subpart E - Family Radio Service
- _____ 95 Subpart F - Interactive Video and Data Service (IVDS)
- _____ 97 - Amateur Radio Service
- _____ 101 - Fixed Microwave Services

PAGE NO.

6 of 42.

STANDARD TEST CONDITIONS
and
ENGINEERING PRACTICES

Except as noted herein, the following conditions and procedures were observed during the testing:

In accordance with ANSI C63.4-1992, section 6.1.9, and unless otherwise indicated in the specific measurement results, the ambient temperature of the actual EUT was maintained within the range of 10° to 40°C (50° to 104 °F) unless the particular equipment requirements specify testing over a different temperature range. Also, unless otherwise indicated, the humidity levels were in the range of 10% to 90% relative humidity.

Prior to testing, the EUT was tuned up in accordance with the manufacturer's alignment procedures. All external gain controls were maintained at the position of maximum and/or optimum gain throughout the testing.

Measurement results, unless otherwise noted, are worst case measurements.

PAGE NO. 7 of 42.
NAME OF TEST: Carrier Output Power (Conducted)
SPECIFICATION: 47 CFR 2.1046(a)
GUIDE: ANSI/TIA/EIA-603-1992, Paragraph 2.2.1
TEST EQUIPMENT: As per attached page

MEASUREMENT PROCEDURE

1. The EUT was connected to a resistive coaxial attenuator of normal load impedance, and the unmodulated output power was measured by means of an R. F. Power Meter.
2. Measurement accuracy is $\pm 3\%$.

MEASUREMENT RESULTS
(Worst case)

FREQUENCY OF CARRIER, MHz = 500.1, 480.1, 511.9

<u>POWER SETTING</u>	<u>R. F. POWER, WATTS</u>
Low	1
High	4

SUPERVISED BY:



William H. Graff, Director
of Engineering

TRANSMITTER POWER CONDUCTED MEASUREMENTS

TEST 1: R. F. POWER OUTPUT
 TEST 2: FREQUENCY STABILITY

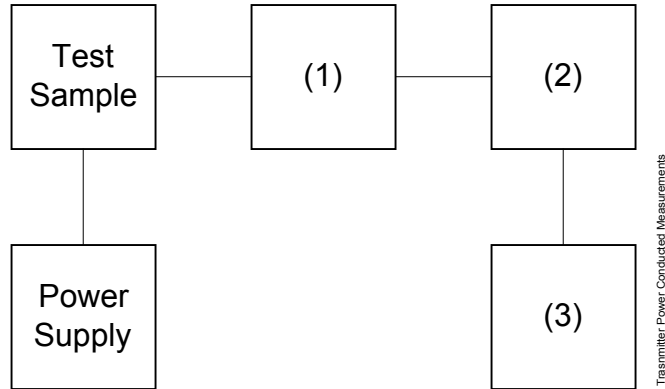

Asset	Description (as applicable)	s/n
(1)	<u>COAXIAL ATTENUATOR</u>	
i00122	Narda 766-10	7802
i00123	Narda 766-10	7802A
i00069	Bird 8329 (30 dB)	1006
i00113	Sierra 661A-3D	1059
(2)	<u>POWER METERS</u>	
i00014	HP 435A	1733A05836
i00039	HP 436A	2709A26776
i00020	HP 8901A POWER MODE	2105A01087
(3)	<u>FREQUENCY COUNTER</u>	
i00042	HP 5383A	1628A00959
i00019	HP 5334B	2704A00347
i00020	HP 8901A FREQUENCY MODE	2105A01087

PAGE NO. 9 of 42.

NAME OF TEST: Unwanted Emissions (Transmitter Conducted)

SPECIFICATION: 47 CFR 2.1051

GUIDE: ANSI/TIA/EIA-603-1992, Paragraph 2.2.13

TEST EQUIPMENT: As per attached page

MEASUREMENT PROCEDURE

1. The emissions were measured for the worst case as follows:
 - (a): within a band of frequencies defined by the carrier frequency plus and minus one channel.
 - (b): from the lowest frequency generated in the EUT and to at least the 10th harmonic of the carrier frequency, or 40 GHz, whichever is lower.
2. The magnitude of spurious emissions that are attenuated more than 20 dB below the permissible value need not be specified.
3. MEASUREMENT RESULTS: ATTACHED FOR WORST CASE

FREQUENCY OF CARRIER, MHz	=	500.1, 480.1, 511.9
SPECTRUM SEARCHED, GHz	=	0 to 10 x F _c
MAXIMUM RESPONSE, Hz	=	2820
ALL OTHER EMISSIONS	=	≥ 20 dB BELOW LIMIT
LIMIT(S), dBc		
	- (50+10xLOG P)	= -50 (1 Watt)
	- (50+10xLOG P)	= -56 (4 Watts)

SUPERVISED BY:



William H. Graff, Director
of Engineering

TRANSMITTER SPURIOUS EMISSION

TEST A. OCCUPIED BANDWIDTH (IN-BAND SPURIOUS)
 TEST B. OUT-OF-BAND SPURIOUS

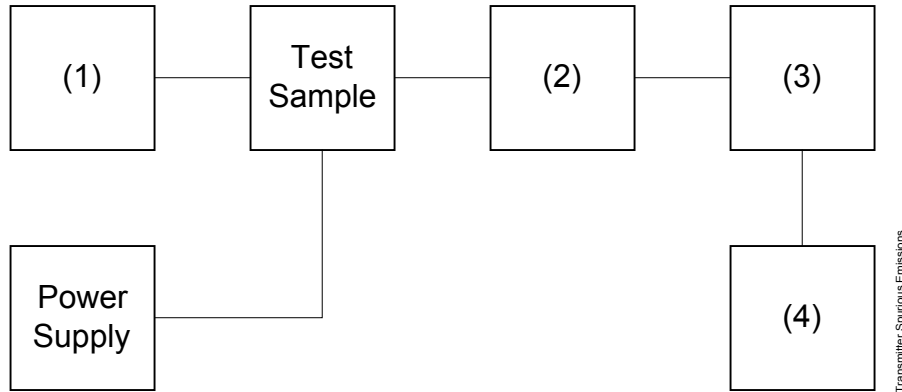

Asset Description (as applicable)	s/n
<u>(1) AUDIO OSCILLATOR/GENERATOR</u>	
i00010 HP 204D	1105A04683
i00017 HP 8903A	2216A01753
i00012 HP 3312A	1432A11250
<u>(2) COAXIAL ATTENUATOR</u>	
i00122 Narda 766-10	7802
i00123 Narda 766-10	7802A
i00069 Bird 8329 (30 dB)	1006
i00113 Sierra 661A-3D	1059
<u>(3) FILTERS; NOTCH, HP, LP, BP</u>	
i00126 Eagle TNF-1	100-250
i00125 Eagle TNF-1	50-60
i00124 Eagle TNF-1	250-850
<u>(4) SPECTRUM ANALYZER</u>	
i00048 HP 8566B	2511A01467
i00029 HP 8563E	3213A00104

PAGE NO. 11 of 42.

NAME OF TEST: Unwanted Emissions (Transmitter Conducted)
 g0030062: 2000-Mar-08 Wed 15:30:00
 STATE: 1:Low Power

FREQUENCY TUNED, MHz	FREQUENCY EMISSION, MHz	LEVEL, dBm	LEVEL, dBc	MARGIN, dB
480.100000	960.155800	-51.5	-81.5	-31.5
500.100000	1000.201400	-49.4	-79.4	-29.4
511.900000	1023.797900	-49	-79	-29
480.100000	1440.329500	-51.5	-81.5	-31.5
500.100000	1500.298400	-47.3	-77.3	-27.3
511.900000	1535.691000	-49.9	-79.9	-29.9
480.100000	1920.395700	-49.3	-79.3	-29.3
500.100000	2000.437400	-51.5	-81.5	-31.5
511.900000	2047.570100	-51.2	-81.2	-31.2
480.100000	2400.497300	-49.8	-79.8	-29.8
500.100000	2500.519600	-50.9	-80.9	-30.9
511.900000	2559.497100	-52.5	-82.5	-32.5
480.100000	2880.593800	-53.2	-83.2	-33.2
500.100000	3000.642900	-52.9	-82.9	-32.9
511.900000	3071.392200	-52.8	-82.8	-32.8
480.100000	3360.689400	-54.1	-84.1	-34.1
500.100000	3500.678400	-53.6	-83.6	-33.6
511.900000	3583.268300	-53.8	-83.8	-33.8
480.100000	3840.762300	-53.5	-83.5	-33.5
500.100000	4000.784500	-53.3	-83.3	-33.3
511.900000	4095.190100	-53.2	-83.2	-33.2
480.100000	4320.880400	-52.8	-82.8	-32.8
500.100000	4500.887400	-53.2	-83.2	-33.2
511.900000	4607.056700	-52.7	-82.7	-32.7
480.100000	4800.963000	-52.6	-82.6	-32.6
500.100000	5001.050000	-52.4	-82.4	-32.4
511.900000	5118.994400	-53.1	-83.1	-33.1
480.100000	5281.087100	-53.1	-83.1	-33.1
500.100000	5501.146000	-53.1	-83.1	-33.1
511.900000	5630.896500	-53.4	-83.4	-33.4
480.100000	5761.237300	-51.9	-81.9	-31.9
500.100000	6001.197400	-47	-77	-27
511.900000	6142.756100	-47.3	-77.3	-27.3
480.100000	6241.274900	-47.1	-77.1	-27.1
500.100000	6501.324400	-46.8	-76.8	-26.8
511.900000	6654.696500	-47.5	-77.5	-27.5
480.100000	6721.443900	-47.6	-77.6	-27.6
500.100000	7001.366300	-47.6	-77.6	-27.6
511.900000	7166.637100	-47.6	-77.6	-27.6
480.100000	7201.456400	-46.3	-76.3	-26.3
500.100000	7501.487300	-47.5	-77.5	-27.5
511.900000	7678.527300	-48.4	-78.4	-28.4

PAGE NO. 12 of 42.

NAME OF TEST: Unwanted Emissions (Transmitter Conducted)
 g0030063: 2000-Mar-08 Wed 15:39:00
 STATE: 2:High Power

FREQUENCY TUNED, MHz	FREQUENCY EMISSION, MHz	LEVEL, dBm	LEVEL, dBc	MARGIN, dB
480.100000	960.236700	-41.9	-78.8	-21.9
500.100000	1000.193900	-40.8	-77.7	-20.8
511.900000	1023.831900	-41.2	-78.1	-21.2
480.100000	1440.296600	-39.9	-76.8	-19.9
500.100000	1500.290100	-38.3	-75.2	-18.3
511.900000	1535.704400	-36.7	-73.6	-16.7
480.100000	1920.387400	-40.9	-77.8	-20.9
500.100000	2000.407300	-38	-74.9	-18
511.900000	2047.587100	-41.5	-78.4	-21.5
480.100000	2400.484700	-40.9	-77.8	-20.9
500.100000	2500.516700	-42.6	-79.5	-22.6
511.900000	2559.505400	-42.3	-79.2	-22.3
480.100000	2880.593200	-43.4	-80.3	-23.4
500.100000	3000.629300	-43.4	-80.3	-23.4
511.900000	3071.440100	-42.7	-79.6	-22.7
480.100000	3360.744700	-43.4	-80.3	-23.4
500.100000	3500.651500	-43.5	-80.4	-23.5
511.900000	3583.301900	-42.6	-79.5	-22.6
480.100000	3840.778200	-43.3	-80.2	-23.3
500.100000	4000.837500	-43.1	-80	-23.1
511.900000	4095.165100	-42.9	-79.8	-22.9
480.100000	4320.885600	-42.7	-79.6	-22.7
500.100000	4500.938400	-42.6	-79.5	-22.6
511.900000	4607.062600	-43.7	-80.6	-23.7
480.100000	4801.008300	-42	-78.9	-22
500.100000	5000.966300	-43	-79.9	-23
511.900000	5119.009100	-43.2	-80.1	-23.2
480.100000	5281.146100	-43	-79.9	-23
500.100000	5501.126600	-41.5	-78.4	-21.5
511.900000	5630.904500	-43.4	-80.3	-23.4
480.100000	5761.223500	-42.9	-79.8	-22.9
500.100000	6001.153000	-37.5	-74.4	-17.5
511.900000	6142.787300	-37.8	-74.7	-17.8
480.100000	6241.256800	-37.3	-74.2	-17.3
500.100000	6501.319500	-37.1	-74	-17.1
511.900000	6654.657800	-36.4	-73.3	-16.4
480.100000	6721.367700	-35.8	-72.7	-15.8
500.100000	7001.413300	-37.3	-74.2	-17.3
511.900000	7166.552100	-37.8	-74.7	-17.8
480.100000	7201.505800	-37	-73.9	-17
500.100000	7501.519600	-36.9	-73.8	-16.9
511.900000	7678.464900	-37.6	-74.5	-17.6

PAGE NO. 13 of 42.
NAME OF TEST: Field Strength of Spurious Radiation
SPECIFICATION: 47 CFR 2.1053(a)
GUIDE: ANSI/TIA/EIA-603-1992, Paragraph 2.2.12
TEST EQUIPMENT: As per attached page

MEASUREMENT PROCEDURE

1. A description of the measurement facilities was filed with the FCC and was found to be in compliance with the requirements of Section 2.948, by letter from the FCC dated March 3, 1997, FILE 31040/SIT. All pertinent changes will be reported to the Commission by up-date prior to March 2000.
2. At first, in order to locate all spurious frequencies and approximate amplitudes, and to determine proper equipment functioning, the test sample was set up at a distance of three meters from the test instrument. Valid spurious signals were determined by switching the power on and off.
3. In the field, the test sample was placed on a wooden turntable above ground at three (or thirty) meters away from the search antenna. Excess power leads were coiled near the power supply.

The cables were oriented in order to obtain the maximum response. At each emission frequency, the turntable was rotated and the search antennas were raised and lowered vertically.
4. The emission was observed with both a vertically polarized and a horizontally polarized search antenna and the worst case was used.
6. The field strength of each emission within 20 dB of the limit was recorded and corrected with the appropriate cable and transducer factors.
7. The worst case for all channels is shown.
8. Measurement results: ATTACHED FOR WORST CASE

PAGE NO. 15 of 42.

NAME OF TEST: Field Strength of Spurious Radiation
 g0030135: 2000-Mar-15 Wed 10:30:00
 STATE: 2:High Power

FREQUENCY TUNED, MHz	FREQUENCY EMISSION, MHz	METER, dBuV	CF, dB	ERP, dBm	MARGIN, dB
500.100000	1000.195000	34.57	27	-35.8	-15.8
500.100000	1500.295000	33.22	30.79	-33.4	-13.4
500.100000	2000.405000	25.04	33.81	-38.5	-18.6
500.100000	2500.505000	22.55	36.43	-38.4	-18.4
500.100000	3000.595000	23.48	37.6	-36.3	-16.3
500.100000	3500.695000	17.08	38.94	-41.4	-21.4
500.100000	4000.795000	8.82	40.1	-48.5	-28.5
500.100000	4500.898000	3.67	41.58	-52.1	-32.2

PAGE NO. 16 of 42.
NAME OF TEST: Emission Masks (Occupied Bandwidth)
SPECIFICATION: 47 CFR 2.1049(c) (1)
GUIDE: ANSI/TIA/EIA-603-1992, Paragraph 2.2.11
TEST EQUIPMENT: As per previous page

MEASUREMENT PROCEDURE

1. The EUT and test equipment were set up as shown on the following page, with the Spectrum Analyzer connected.
2. For EUTs supporting audio modulation, the audio signal generator was adjusted to the frequency of maximum response and with output level set for ± 2.5 kHz deviation (or 50% modulation). With level constant, the signal level was increased 16 dB.
3. For EUTs supporting digital modulation, the digital modulation mode was operated to its maximum extent.
4. The Occupied Bandwidth was measured with the Spectrum Analyzer controls set as shown on the test results.
5. MEASUREMENT RESULTS: ATTACHED

PAGE NO. 17 of 42.

NAME OF TEST: Emission Masks (Occupied Bandwidth)
g0030064: 2000-Mar-08 Wed 15:49:00
STATE: 2:High Power

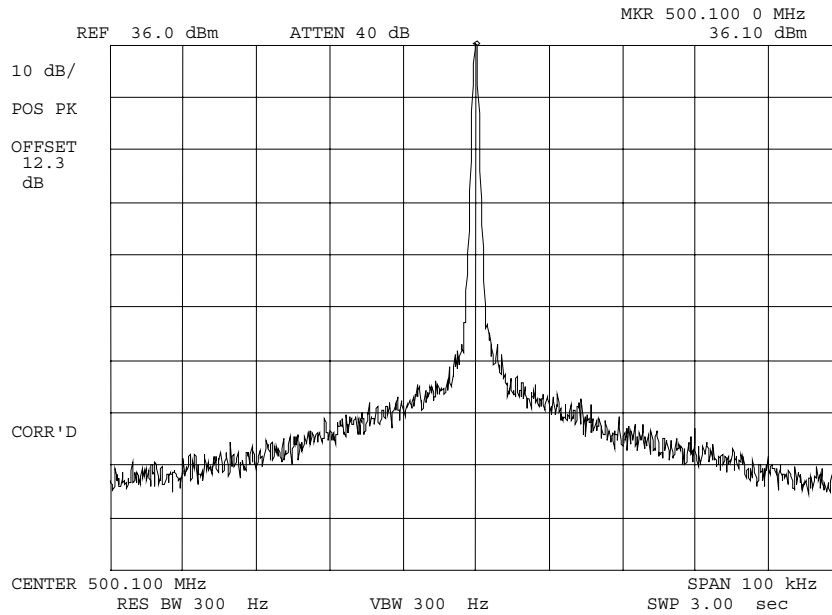

POWER: HIGH
MODULATION: NONE

SUPERVISED BY:

William H. Graff, Director
of Engineering

PAGE NO. 18 of 42.

NAME OF TEST: Emission Masks (Occupied Bandwidth)
g0030065: 2000-Mar-08 Wed 15:51:00
STATE: 2:High Power

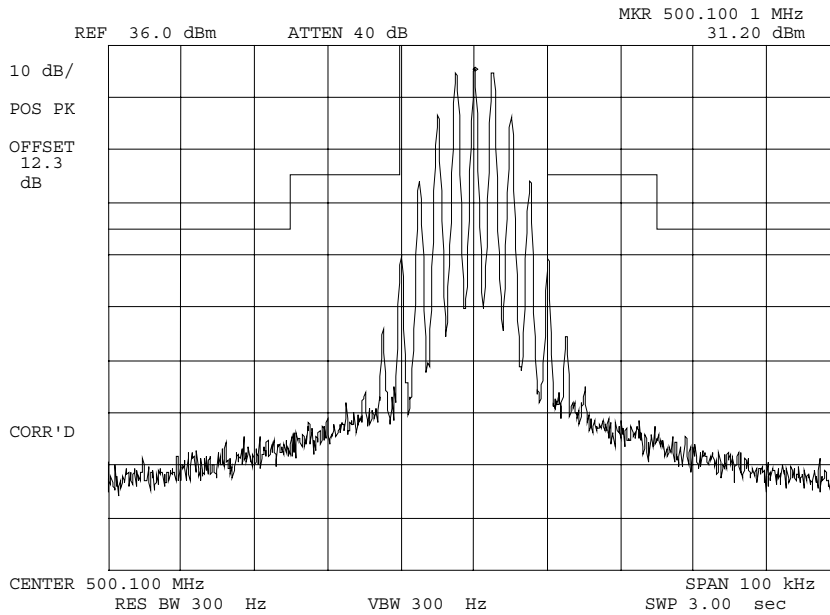

POWER:	HIGH
MODULATION:	VOICE: 2500 Hz SINE WAVE
	MASK: B, VHF/UHF 25kHz,
	w/LPF

SUPERVISED BY:

William H. Graff, Director
of Engineering

PAGE NO. 19 of 42.

NAME OF TEST: Emission Masks (Occupied Bandwidth)
g0030066: 2000-Mar-08 Wed 15:52:00
STATE: 2:High Power

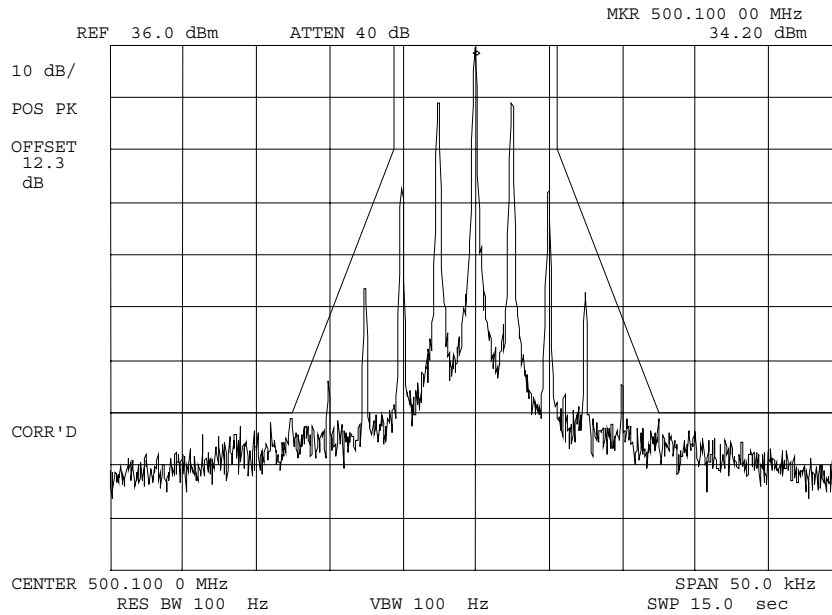

POWER: HIGH
MODULATION: VOICE: 2500 Hz SINE WAVE
MASK: D, VHF/UHF 12.5kHz BW

SUPERVISED BY:

William H. Graff, Director
of Engineering

PAGE NO. 20 of 42.
NAME OF TEST: Transient Frequency Behavior
SPECIFICATION: 47 CFR 90.214
GUIDE: ANSI/TIA/EIA-603-1992, Paragraph 2.2.19
TEST EQUIPMENT: As per attached page

MEASUREMENT PROCEDURE

1. The EUT was setup as shown on the attached page, following TIA/EIA-603 steps a, b, and c as a *guide*.
2. The transmitter was turned on.
3. Sufficient attenuation was provided so that the transmitter carrier level measured at the output of the combiner was 40 dB below the maximum input level of the test receiver. This level was recorded as step f.
4. The transmitter was turned off.
5. An RF signal generator (1) modulated with a 1 kHz tone at either 25, 12.5, or 6.25 kHz deviation, and set to the same frequency as the assigned transmitter frequency, (2) was adjusted to a level -20 dB below the level recorded for step f, as measured at the output of the combiner. This level was then fixed for the remainder of the test and is recorded at step h.
6. The oscilloscope was setup using TIA/EIA-603 steps j and k as a guide, and to either 10 ms/div (UHF) or 5 ms/div (VHF).
7. The 30 dB attenuator was removed, the transmitter was turned on, and the level of the carrier at the output of the combiner was recorded as step l.
8. The carrier on-time as referenced in TIA/EIA-603 steps m, n, and o was captured and plotted. The carrier off-time as referenced in TIA/EIA-603 steps p, q, r, and s was captured and plotted.

LEVELS MEASURED:

<u>step f</u> , dBm	=	-15.4
<u>step h</u> , dBm	=	-36.7
<u>step l</u> , dBm	=	14.1

SUPERVISED BY:



William H. Graff, Director
of Engineering

TRANSIENT FREQUENCY BEHAVIOR

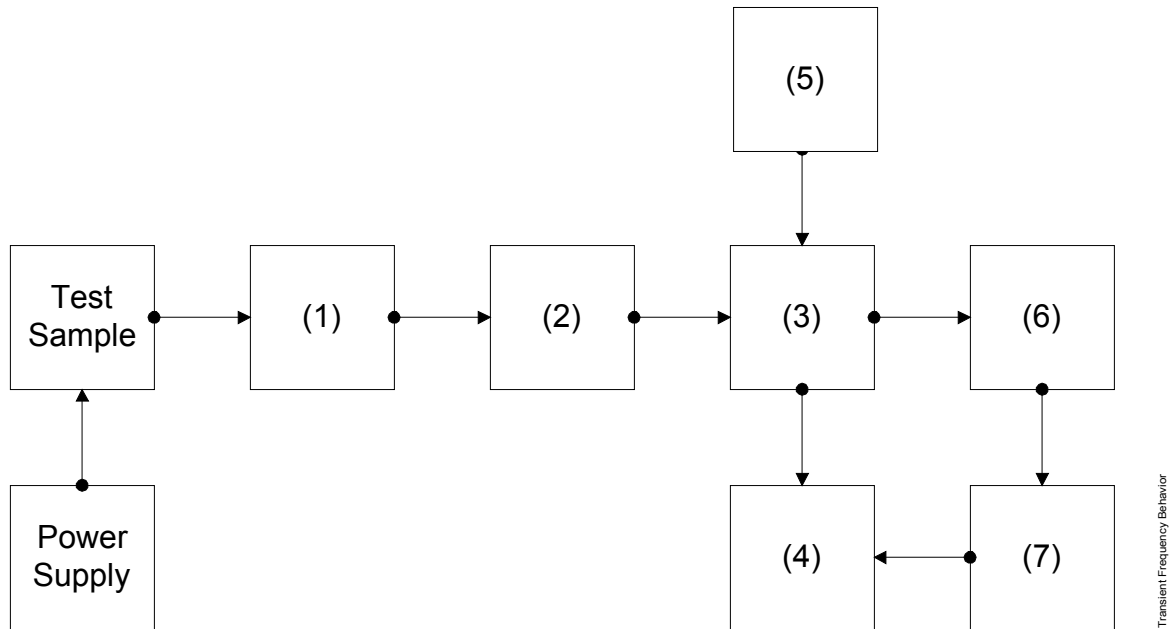

Asset	Description (as applicable)	s/n
(1)	<u>ATTENUATOR</u> (Removed after 1st step)	
	i00112 Philco 30 dB	989
(2)	<u>ATTENUATOR</u>	
	i00112 Philco 30 dB	989
	i00172 Bird 30 dB	989
	i00122 Narda 10 dB	7802
	i00123 Narda 10 dB	7802A
	i00110 Kay Variable	145-387
(3)	<u>COMBINER</u>	
	i00154 4 x 25 Ω COMBINER	154
(4)	<u>CRYSTAL DETECTOR</u>	
	i00159 HP 8470B	1822A10054
(5)	<u>RF SIGNAL GENERATOR</u>	
	i00018 HP 8656A	2228A03472
	i00031 HP 8656A	2402A06180
	i00067 HP 8920A	3345U01242
(6)	<u>MODULATION ANALYZER</u>	
	i00020 HP 8901A	2105A01087
(7)	<u>SCOPE</u>	
	i00030 HP 54502A	2927A00209

PAGE NO.

23 of 42.

NAME OF TEST: Transient Frequency Behavior
g0030068: 2000-Mar-08 Wed 16:04:00
STATE: 2:High Power

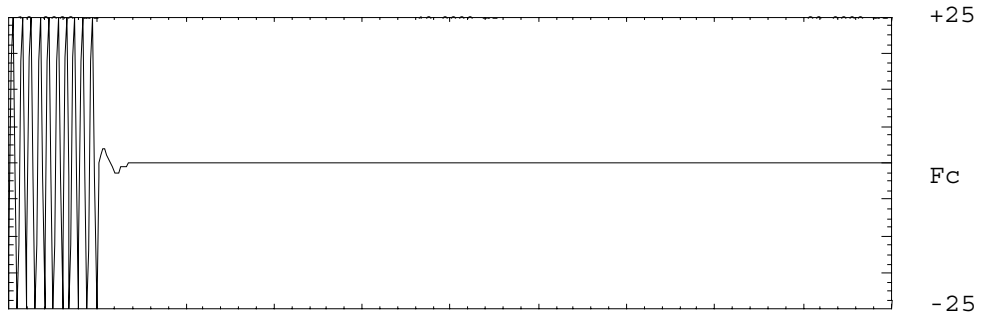

```

      Min/Max      Ref/Res      RefGen - Mod
Mod:  10.0 MHz/20  10.0000 Hz  100000  1  2 (1M chn)

      Min/Max      Ref/Res      RefGen - Mod
Chan1:  10.0 MHz/20  10.0000 Hz  100000  1  2 (1M chn)

      Min/Max      Ref/Res      RefGen - Mod
Chan2:  10.0 MHz/20  10.0000 Hz  100000  1  2 (1M chn)
  
```

POWER:
MODULATION:
DESCRIPTION:

HIGH
Ref Gen=25 kHz Deviation
CARRIER ON TIME

SUPERVISED BY:

William H. Graff
 William H. Graff, Director
 of Engineering

PAGE NO. 25 of 42.

NAME OF TEST: Transient Frequency Behavior
 g0030070: 2000-Mar-08 Wed 16:07:00
 STATE: 2:High Power

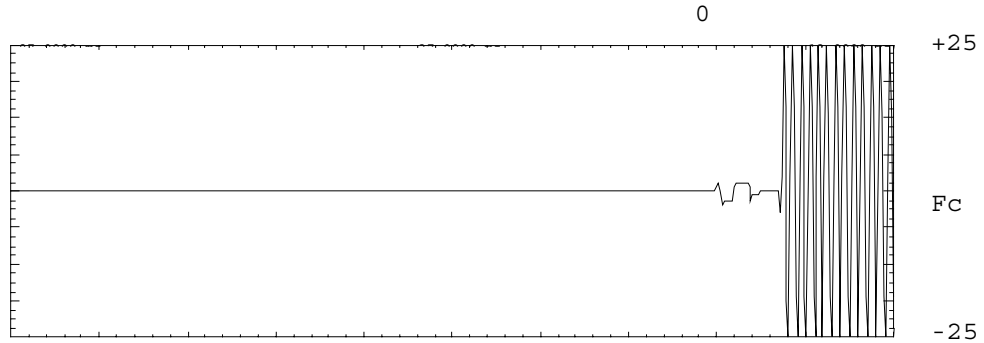

```

      Min/Max      Ref/Res      RefGen - Mod
Mod:  10.000000  20.000000  0.000000  0.000000
      Channel 1      Resolution  Offset  Scale  Units
      -----
      Channel 1      200.000000  0.000000  1.000  1  dB (1Mhz)
      Modulation:  Freq
      Resolution:  200.000000
      Modulation:  Freq
      Units:      1.000000
      Resolution:  200.000000
    
```

POWER: HIGH
 MODULATION: Ref Gen=25 kHz Deviation
 DESCRIPTION: CARRIER OFF TIME

SUPERVISED BY:

William H. Graff, Director
 of Engineering

PAGE NO. 26 of 42.

NAME OF TEST: Transient Frequency Behavior
 g0030071: 2000-Mar-08 Wed 16:09:00
 STATE: 2:High Power

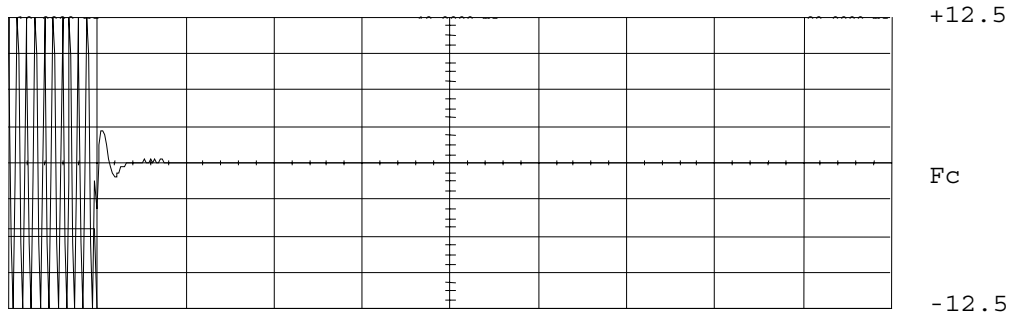

Trace	Timebase	Delay/Div	Reflexion	Mode
Trace1 1	200 ns/div	0.0000 ns	1.000 1	2 (M) (M)
Trace1 2	2.00 ns/div	0.0000 ns	1.000 1	2 (M) (M)

Modulation mode: FSK
 On Modulation Edge of base
 Modulation Time: 1.000 ns (carrier width 5.000)
 Modulation: 10.000 ns

POWER:
 MODULATION:
 DESCRIPTION:

HIGH
 Ref Gen=12.5 kHz Deviation
 CARRIER ON TIME

SUPERVISED BY:

William H. Graff
 William H. Graff, Director
 of Engineering

PAGE NO. 27 of 42.

NAME OF TEST: Transient Frequency Behavior
 g0030072: 2000-Mar-08 Wed 16:09:00
 STATE: 2:High Power

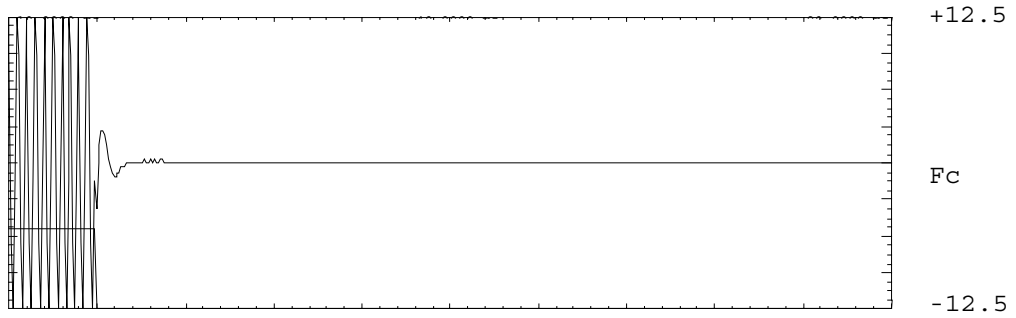

Trace	Timebase	Delay/Div	Reference	Mode
Trace1 1	200 ns/div	0.0000 ns	1.000	2 (AM Mod)
Trace1 2	2.00 ns/div	0.0000 ns	1.000	2 (AM Mod)

Modulation Mode: FSK
 On Negative Edge of base
 Modulation Type: 1
 Base: 1.000 MHz (Carrier Mode: FSK)
 FSK: 10.000 Hz

POWER:
 MODULATION:
 DESCRIPTION:

HIGH
 Ref Gen=12.5 kHz Deviation
 CARRIER ON TIME

SUPERVISED BY:

William H. Graff
 William H. Graff, Director
 of Engineering

PAGE NO. 28 of 42.

NAME OF TEST: Transient Frequency Behavior
 g0030073: 2000-Mar-08 Wed 16:11:00
 STATE: 2:High Power

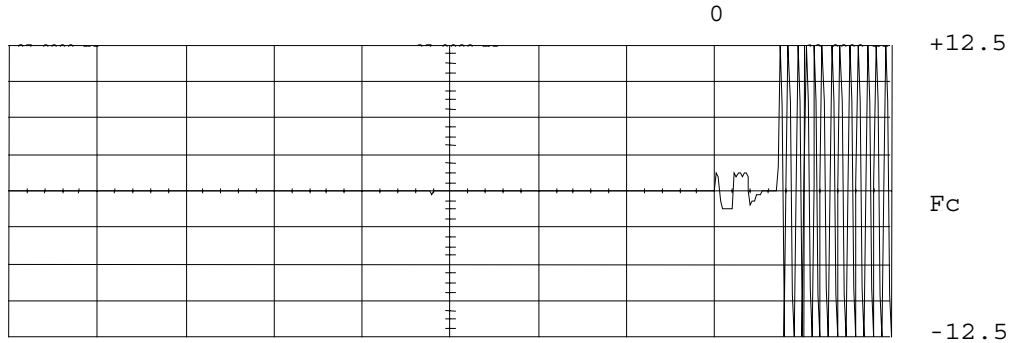

```

      Min/Max      Rate/Sec      Ref/Sec      Mod-
Main      10.0 mV/div      20.0000 Hz      1.000 1 2 (1M ohm)

      Channel 1      20.0 mV/div      20.0000 Hz      1.000 1 2 (1M ohm)

      Modulation Mode: Freq
      Modulation Rate: 20.0000 Hz
      Modulation Type: 1
      Modulation: 200.000 Hz (Carrier Width: 5.000)
      Modulation: 40.000 Hz
    
```

POWER:
 MODULATION:
 DESCRIPTION:

HIGH
 Ref Gen=12.5 kHz Deviation
 CARRIER OFF TIME

SUPERVISED BY:

William H. Graff
 William H. Graff, Director
 of Engineering

PAGE NO.

29 of 42.

NAME OF TEST: Transient Frequency Behavior
g0030074: 2000-Mar-08 Wed 16:11:00
STATE: 2:High Power

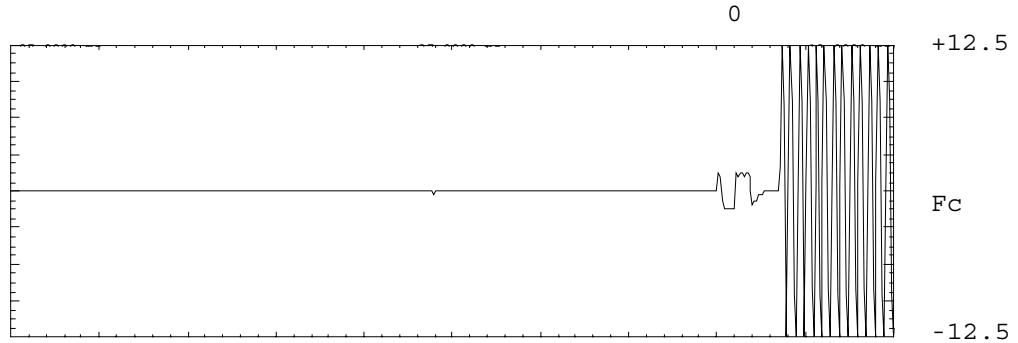

```

             Min/Max      Ref/Res      Refs     Mod
Mod     10.0 mV/div      20.000 Hz      1000     1000000
-----
channel 1  20.0 mV/div      20.000 Hz      1.000     1.000000
-----
           Mod/Res     Refs
As resolution 20.0 Hz
Resolution 20.0 Hz
Span 200.000 Hz (center freq 1.000 MHz)
10.0000 Hz

```

POWER:
MODULATION:
DESCRIPTION:

HIGH
Ref Gen=12.5 kHz Deviation
CARRIER OFF TIME

SUPERVISED BY:

William H. Graff
 William H. Graff, Director
 of Engineering

PAGE NO. 30 of 42.
NAME OF TEST: Audio Low Pass Filter (Voice Input)
SPECIFICATION: 47 CFR 2.1047(a)
GUIDE: ANSI/TIA/EIA-603-1992, Paragraph 2.2.15
TEST EQUIPMENT: As per attached page

MEASUREMENT PROCEDURE

1. The EUT and test equipment were set up such that the audio input was connected at the input to the modulation limiter, and the modulated stage.
2. The audio output was connected at the output to the modulated stage.
3. MEASUREMENT RESULTS: ATTACHED

TRANSMITTER TEST SET-UP

- TEST A. MODULATION CAPABILITY/DISTORTION
- TEST B. AUDIO FREQUENCY RESPONSE
- TEST C. HUM AND NOISE LEVEL
- TEST D. RESPONSE OF LOW PASS FILTER
- TEST E. MODULATION LIMITING

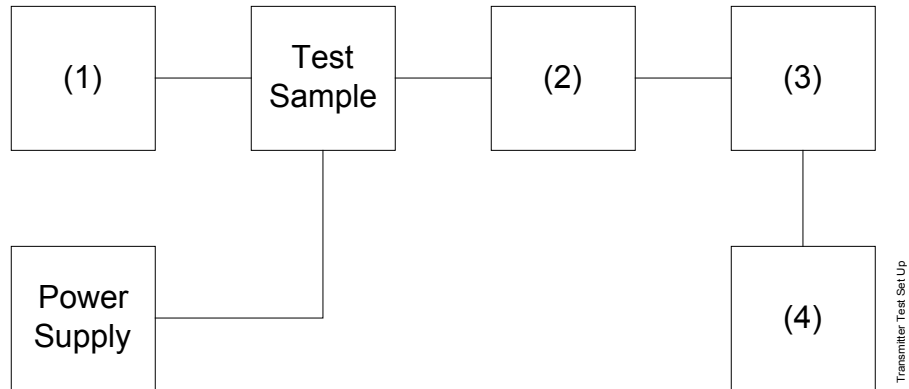

Asset Description (as applicable)	s/n
(1) <u>Audio Oscillator</u>	
i00010 HP 204D	1105A04683
i00017 HP 8903A	2216A01753
i00118 HP 33120A	US36002064
(2) <u>COAXIAL ATTENUATOR</u>	
i00122 NARDA 766-10	7802
i00123 NARDA 766-10	7802A
i00113 SIERRA 661A-3D	1059
i00069 BIRD 8329 (30 dB)	10066
(3) <u>MODULATION ANALYZER</u>	
i00020 HP 8901A	2105A01087
(4) <u>AUDIO ANALYZER</u>	
i00017 HP 8903A	2216A01753

PAGE NO.

32 of 42.

NAME OF TEST: Audio Low Pass Filter (Voice Input)
g0030005: 2000-Mar-07 Tue 14:29:00
STATE: 0:General

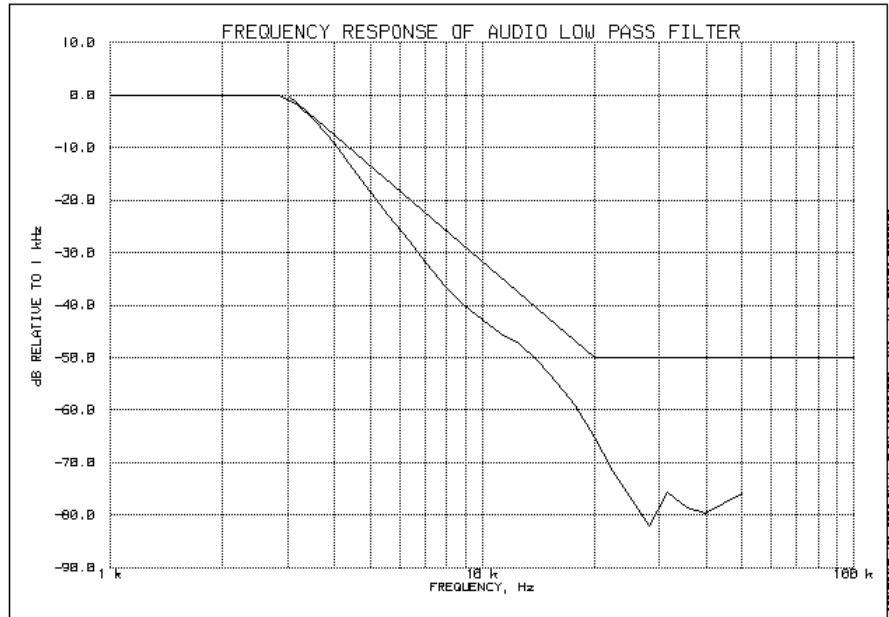

SUPERVISED BY:

William H. Graff, Director
of Engineering

PAGE NO. 33 of 42.
NAME OF TEST: Audio Frequency Response
SPECIFICATION: 47 CFR 2.1047(a)
GUIDE: ANSI/TIA/EIA-603-1992, Paragraph 2.2.6
TEST EQUIPMENT: As per previous page

MEASUREMENT PROCEDURE

1. The EUT and test equipment were set up as shown on the following page.
2. The audio signal generator was connected to the audio input circuit/microphone of the EUT.
3. The audio signal input was adjusted to obtain 20% modulation at 1 kHz, and this point was taken as the 0 dB reference level.
4. With input levels held constant and below limiting at all frequencies, the audio signal generator was varied from 100 Hz to 50 kHz.
5. The response in dB relative to 1 kHz was then measured, using the HP 8901A Modulation Analyzer.
6. MEASUREMENT RESULTS: ATTACHED

PAGE NO. 34 of 42.

NAME OF TEST: Audio Frequency Response
 g0030002: 2000-Mar-07 Tue 14:15:00
 STATE: 0:General

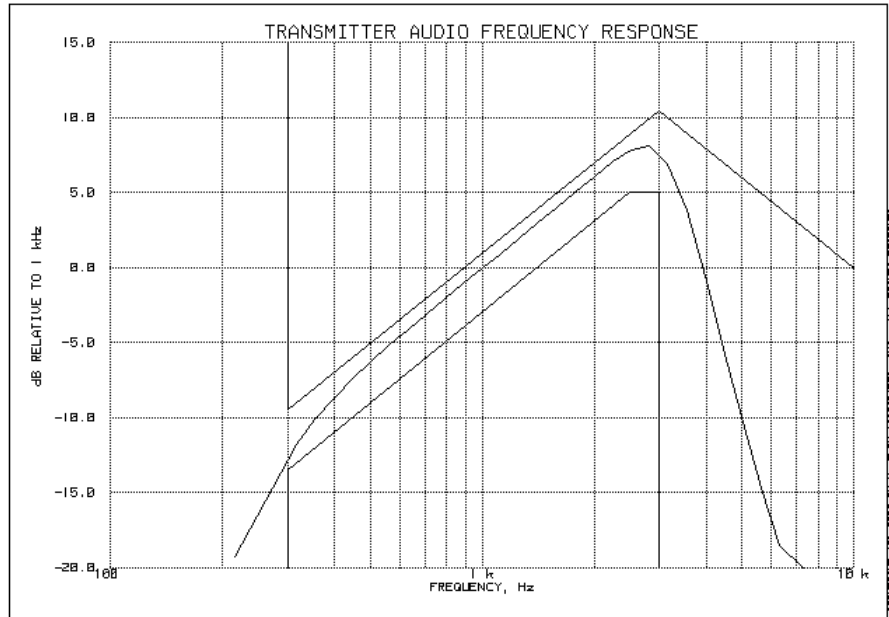

Frequency of Maximum Audio Response, Hz = 2820

Additional points:

FREQUENCY, Hz	LEVEL, dB
300	-12.81
20000	-23.51
30000	-23.53
50000	-23.49

SUPERVISED BY:

William H. Graff, Director
 of Engineering

PAGE NO. 35 of 42.
NAME OF TEST: Modulation Limiting
SPECIFICATION: 47 CFR 2.1047(b)
GUIDE: ANSI/TIA/EIA-603-1992, Paragraph 2.2.3
TEST EQUIPMENT: As per previous page

MEASUREMENT PROCEDURE

1. The signal generator was connected to the input of the EUT as for "Frequency Response of the Modulating Circuit."
2. The modulation response was measured for each of three frequencies (one of which was the frequency of maximum response), and the input voltage was varied and was observed on an HP 8901A Modulation Analyzer.
3. The input level was varied from 30% modulation (± 1.5 kHz deviation) to at least 20 dB higher than the saturation point.
4. Measurements were performed for both negative and positive modulation and the respective results were recorded.
5. MEASUREMENT RESULTS: ATTACHED

PAGE NO.

36 of 42.

NAME OF TEST: Modulation Limiting
g0030006: 2000-Mar-07 Tue 14:34:00
STATE: 0:General

Positive
Peaks:

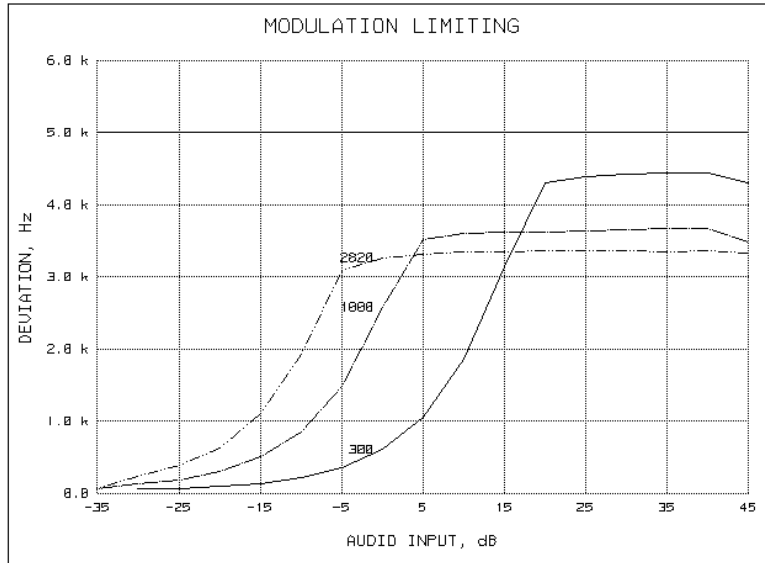

Negative
Peaks:

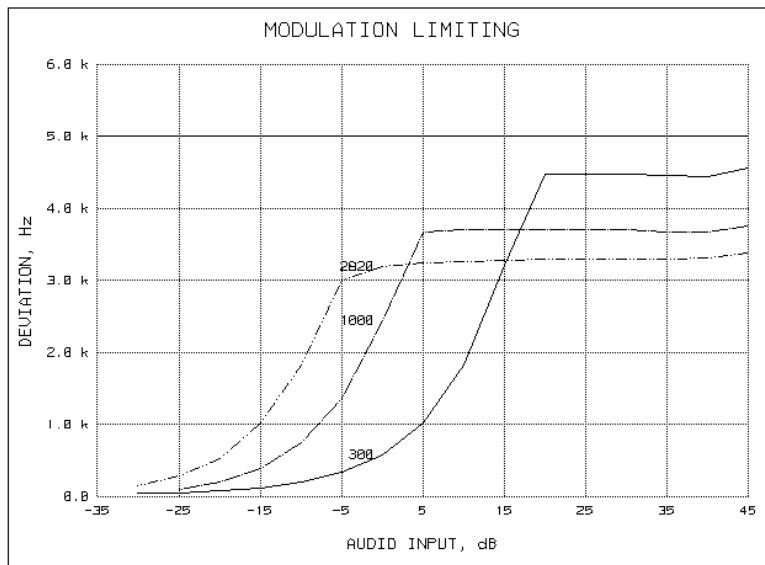

SUPERVISED BY:

William H. Graff, Director
of Engineering

PAGE NO.

37 of 42.

NAME OF TEST: Modulation Limiting
g0030007: 2000-Mar-07 Tue 14:44:00
STATE: 0:General

Positive
Peaks:

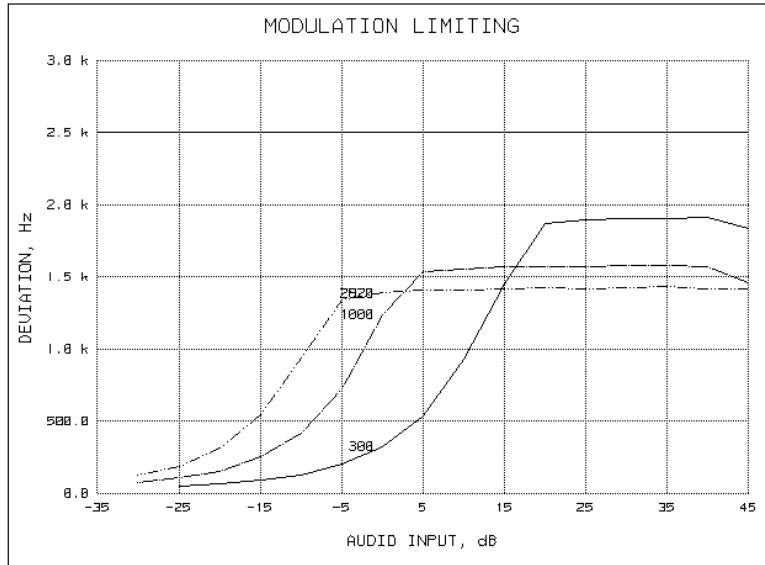

Negative
Peaks:

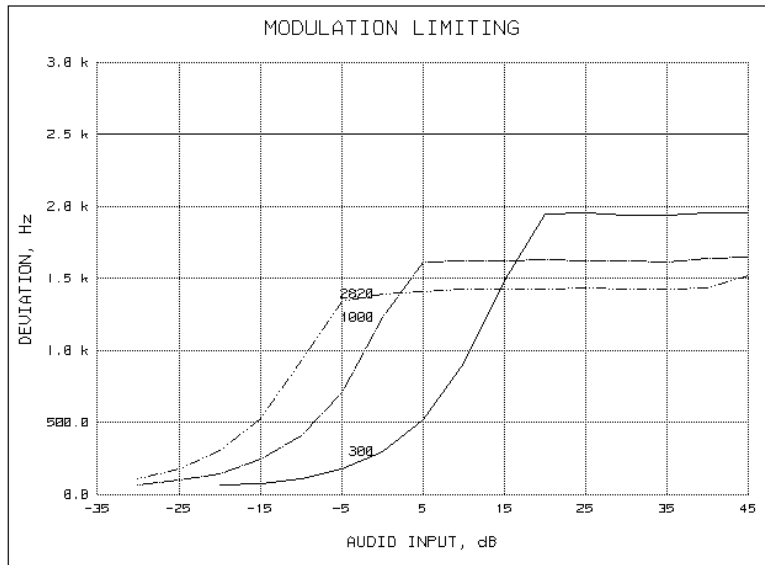

SUPERVISED BY:

William H. Graff, Director
of Engineering

PAGE NO. 38 of 42.
NAME OF TEST: Frequency Stability (Temperature Variation)
SPECIFICATION: 47 CFR 2.1055(a)(1)
GUIDE: ANSI/TIA/EIA-603-1992, Paragraph 2.2.2
TEST CONDITIONS: As Indicated
TEST EQUIPMENT: As per previous page

MEASUREMENT PROCEDURE

1. The EUT and test equipment were set up as shown on the following page.
2. With all power removed, the temperature was decreased to -30°C and permitted to stabilize for three hours. Power was applied and the maximum change in frequency was noted within one minute.
3. With power OFF, the temperature was raised in 10°C steps. The sample was permitted to stabilize at each step for at least one-half hour. Power was applied and the maximum frequency change was noted within one minute.
4. The temperature tests were performed for the worst case.
5. MEASUREMENT RESULTS: ATTACHED

TRANSMITTER TEST SET-UP

- TEST A. OPERATIONAL STABILITY
- TEST B. CARRIER FREQUENCY STABILITY
- TEST C. OPERATIONAL PERFORMANCE STABILITY
- TEST D. HUMIDITY
- TEST E. VIBRATION
- TEST F. ENVIRONMENTAL TEMPERATURE
- TEST G. FREQUENCY STABILITY: TEMPERATURE VARIATION
- TEST H. FREQUENCY STABILITY: VOLTAGE VARIATION

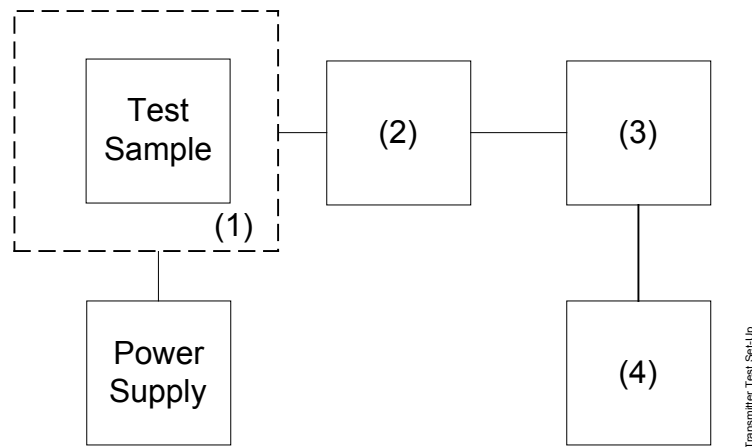

Asset Description (as applicable)	s/n
<u>(1) TEMPERATURE, HUMIDITY, VIBRATION</u>	
i00027 Tenny Temp. Chamber	9083-765-234
i00 Weber Humidity Chamber	
i00 L.A.B. RVH 18-100	
<u>(2) COAXIAL ATTENUATOR</u>	
i00122 NARDA 766-10	7802
i00123 NARDA 766-10	7802A
i00113 SIERRA 661A-3D	1059
i00069 BIRD 8329 (30 dB)	10066
<u>(3) R.F. POWER</u>	
i00014 HP 435A POWER METER	1733A05839
i00039 HP 436A POWER METER	2709A26776
i00020 HP 8901A POWER MODE	2105A01087
<u>(4) FREQUENCY COUNTER</u>	
i00042 HP 5383A	1628A00959
i00019 HP 5334B	2704A00347
i00020 HP 8901A	2105A01087

PAGE NO.

40 of 42.

NAME OF TEST: Frequency Stability (Temperature Variation)
g0030008: 2000-Mar-08 Wed 17:10:00
STATE: 0:General

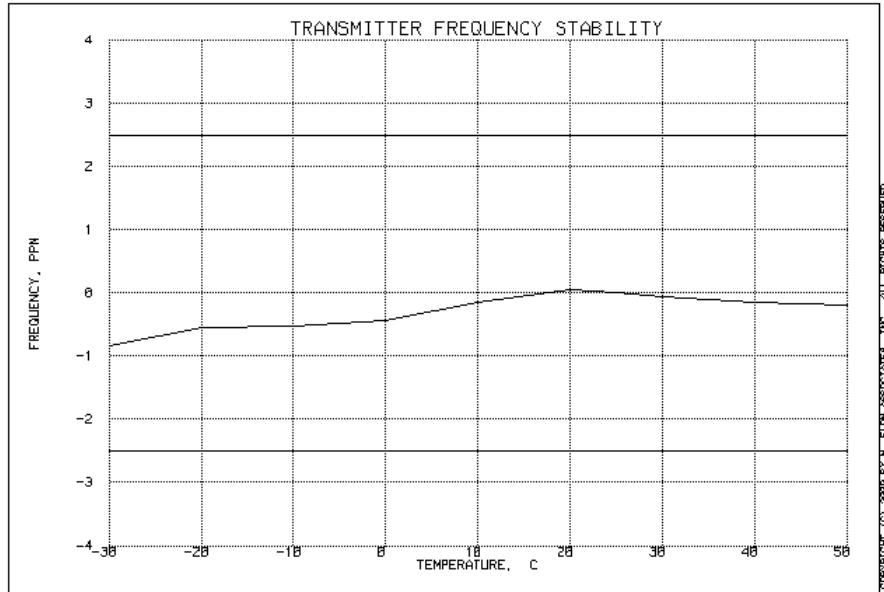

SUPERVISED BY:

William H. Graff, Director
of Engineering

PAGE NO. 41 of 42.
NAME OF TEST: Frequency Stability (Voltage Variation)
SPECIFICATION: 47 CFR 2.1055(b) (1)
GUIDE: ANSI/TIA/EIA-603-1992, Paragraph 2.2.2
TEST EQUIPMENT: As per previous page

MEASUREMENT PROCEDURE

1. The EUT was placed in a temperature chamber at 25±5°C and connected as for "Frequency Stability - Temperature Variation" test.
2. The power supply voltage to the EUT was varied from 85% to 115% of the nominal value measured at the input to the EUT.
3. The variation in frequency was measured for the worst case.

RESULTS: Frequency Stability (Voltage Variation)
g0030054: 2000-Mar-07 Tue 15:10:20
STATE: 0:General

LIMIT, ppm = 2.5
LIMIT, Hz = 1250
BATTERY END POINT (Voltage) = 6.2

% of STV	Voltage	Frequency, MHz	Change, Hz	Change, ppm
85	8.16	500.099970	-30	-0.06
100	9.6	500.100000	0	0.00
115	11.04	500.100020	20	0.04
65	6.2	500.099920	-80	-0.16

SUPERVISED BY:



William H. Graff, Director
of Engineering

PAGE NO. 42 of 42.
NAME OF TEST: Necessary Bandwidth and Emission Bandwidth
SPECIFICATION: 47 CFR 2.202 (g)

MODULATION = 16K0F3E

NECESSARY BANDWIDTH CALCULATION:
 MAXIMUM MODULATION (M), kHz = 3
 MAXIMUM DEVIATION (D), kHz = 5
 CONSTANT FACTOR (K) = 1
 NECESSARY BANDWIDTH (B_N), kHz = (2xM) + (2xDxK)
 = 16.0

MODULATION = 11K0F3E

NECESSARY BANDWIDTH CALCULATION:
 MAXIMUM MODULATION (M), kHz = 3
 MAXIMUM DEVIATION (D), kHz = 2.5
 CONSTANT FACTOR (K) = 1
 NECESSARY BANDWIDTH (B_N), kHz = (2xM) + (2xDxK)
 = 11.0

SUPERVISED BY: 
 William H. Graff, Director
 of Engineering

TESTIMONIAL
AND
STATEMENT OF CERTIFICATION

THIS IS TO CERTIFY THAT:

1. THAT the application was prepared either by, or under the direct supervision of, the undersigned.
2. THAT the technical data supplied with the application was taken under my direction and supervision.
3. THAT the data was obtained on representative units, randomly selected.
4. THAT, to the best of my knowledge and belief, the facts set forth in the application and accompanying technical data are true and correct.

CERTIFYING ENGINEER:



William H. Graff, Director
of Engineering