

MFA **M. Flom Associates, Inc. - Global Compliance Center**
3356 North San Marcos Place, Suite 107, Chandler, Arizona 85225-7176
www.mflom.com general@mflom.com (480) 926-3100, FAX: 926-3598

Date: August 3, 2000

Federal Communications Commission
Via: Electronic Filing

Attention: Authorization & Evaluation Division

Applicant: Icom Incorporated
Equipment: IC-F30GT and IC-F30GS
FCC ID: AFJIC-F30G
FCC Rules: 22, 74, 90

Gentlemen:

On behalf of the Applicant, enclosed please find Application Form 731, Engineering Test Report and all pertinent documentation, the whole for approval of the referenced equipment as shown.

Filing fees are attached.

We trust the same is in order. Should you need any further information, kindly contact the writer who is authorized to act as agent.

Sincerely yours,

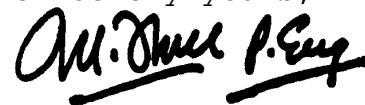

Morton Flom, P. Eng.

enclosure(s)
cc: Applicant
MF/cvr

LIST OF EXHIBITS
(FCC **CERTIFICATION** (TRANSMITTERS) - REVISED 9/28/98)

APPLICANT: Icom Incorporated

FCC ID: AFJIC-F30G

BY APPLICANT:

1. LETTER OF AUTHORIZATION
2. IDENTIFICATION DRAWINGS, 2.1033(c)(11)
 - ___ LABEL
 - ___ LOCATION OF LABEL
 - ___ COMPLIANCE STATEMENT
 - ___ LOCATION OF COMPLIANCE STATEMENT
3. PHOTOGRAPHS, 2.1033(c)(12)
4. DOCUMENTATION: 2.1033(c)
 - (3) USER MANUAL
 - (9) TUNE UP INFO
 - (10) SCHEMATIC DIAGRAM
 - (10) CIRCUIT DESCRIPTION
 - BLOCK DIAGRAM
 - PARTS LIST
 - ACTIVE DEVICES
5. PART 90.203(e) & (g) ATTESTATION

BY M.F.A. INC.

- A. TESTIMONIAL & STATEMENT OF CERTIFICATION
- B. STATEMENT OF QUALIFICATIONS

MFA **M. Flom Associates, Inc. - Global Compliance Center**
3356 North San Marcos Place, Suite 107, Chandler, Arizona 85225-7176
www.mflom.com general@mflom.com (480) 926-3100, FAX: 926-3598

Sub-part
2.1033 (c) :

EQUIPMENT IDENTIFICATION

FCC ID: AFJIC-F30G

NAMEPLATE DRAWING

ATTACHED, EXHIBIT 1.

LOCATION

AS PER LABEL DRAWING(S)

DATE OF REPORT

August 3, 2000

SUPERVISED BY:



Morton Flom, P. Eng.

THE APPLICANT HAS BEEN CAUTIONED AS TO THE FOLLOWING:

15.21 INFORMATION TO USER.

The users manual or instruction manual for an intentional radiator shall caution the user that changes or modifications not expressly approved by the party responsible for compliance could void the user's authority to operate the equipment.

15.27(a) SPECIAL ACCESSORIES.

Equipment marketed to a consumer must be capable of complying with the necessary regulations in the configuration in which the equipment is marketed. Where special accessories, such as shielded cables and/or special connectors are required to enable an unintentional or intentional radiator to comply with the emission limits in this part, the equipment must be marketed with, i.e. shipped and sold with, those special accessories. However, in lieu of shipping or packaging the special accessories with the unintentional or intentional radiator, the responsible party may employ other methods of ensuring that the special accessories are provided to the consumer, without additional charge.

Information detailing any alternative method used to supply the special accessories for a grant of equipment authorization or retained in the verification records, as appropriate. The party responsible for the equipment, as detailed in § 2.909 of this chapter, shall ensure that these special accessories are provided with the equipment. The instruction manual for such devices shall include appropriate instructions on the first page of text concerned with the installation of the device that these special accessories must be used with the device. It is the responsibility of the user to use the needed special accessories supplied with the equipment.

TABLE OF CONTENTS

<u>RULE</u>	<u>DESCRIPTION</u>	<u>PAGE</u>
	Test Report	1
2.1033(c)	General Information Required	2
2.1033(c)(14)	Rule Summary	6
	Standard Test Conditions and Engineering Practices	7
2.1046(a)	Carrier Output Power (Conducted)	8
2.1051	Unwanted Emissions (Transmitter Conducted)	10
2.1053(a)	Field Strength of Spurious Radiation	14
2.1049(c)(1)	Emission Masks (Occupied Bandwidth)	17
90.214	Transient Frequency Behavior	24
2.1047(a)	Audio Low Pass Filter (Voice Input)	34
2.1047(a)	Audio Frequency Response	37
2.1047(b)	Modulation Limiting	39
2.1055(a)(1)	Frequency Stability (Temperature Variation)	42
2.1055(b)(1)	Frequency Stability (Voltage Variation)	45
2.202(g)	Necessary Bandwidth and Emission Bandwidth	46

PAGE NO. 1 of 46.

Required information per ISO/IEC Guide 25-1990, paragraph 13.2:

- a) TEST REPORT
- b) Laboratory: M. Flom Associates, Inc.
 (FCC: 31040/SIT) 3356 N. San Marcos Place, Suite 107
 (Canada: IC 2044) Chandler, AZ 85224
- c) Report Number: d0080019
- d) Client: Icom America, Inc.
 2380 - 116th Ave. N. E.
 P.O. C-90029
 Bellevue, Washington 98009-9029
- e) Identification: IC-F30GT and IC-F30GS
 FCC ID: AFJIC-F30G
 Description: VHF FM Handheld Transceiver
- f) EUT Condition: Not required unless specified in individual tests.
- g) Report Date: August 3, 2000
 EUT Received: July 19, 2000
- h, j, k): As indicated in individual tests.
- i) Sampling method: No sampling procedure used.
- l) Uncertainty: In accordance with MFA internal quality manual.
- m) Supervised by: 
 Morton Flom, P. Eng.
- n) Results: The results presented in this report relate only to the item tested.
- o) Reproduction: This report must not be reproduced, except in full, without written permission from this laboratory.

PAGE NO. 2 of 46.

LIST OF GENERAL INFORMATION REQUIRED FOR CERTIFICATIONIN ACCORDANCE WITH FCC RULES AND REGULATIONS,
VOLUME II, PART 2 AND TO

22, 74, 90

Sub-part 2.1033(c) (1): NAME AND ADDRESS OF APPLICANT:Icom Incorporated
1-6-19 Kamikurazukuri
Hirano-ku
Osaka, Japan 547MANUFACTURER:Icom Incorporated
6-9-16 Kamihigashi
Hirano-Ku
Osaka, Japan 547(c) (2): FCC ID: AFJIC-F30GMODEL NO: IC-F30GT and IC-F30GS(c) (3): INSTRUCTION MANUAL(S):

PLEASE SEE ATTACHED EXHIBITS

(c) (4): TYPE OF EMISSION: 16K0F3E, 11K0F3E(c) (5): FREQUENCY RANGE, MHz: 136 to 174(c) (6): POWER RATING, Watts: 1 to 5
x Switchable ___ Variable ___ N/AFCC GRANT NOTE: BF - The output power is
switchable from the value
listed in this entry to
20%-25% of the value
listed.(c) (7): MAXIMUM POWER RATING, Watts: 300

PAGE NO.

3 of 46.

INFORMATION FOR PUSH-TO-TALK DEVICES

Type and number of antenna to be used for this device:

Maximum antenna gain for antenna indicated above:

Can this device sustain continuous operation with respect to its hardware capabilities and allowable operating functions?

Other hardware or operating restrictions that could limit a person's RF Exposure:

Source-based time-averaging (see 2.1093 of rules) applicable to reduce the average output power:

If device has headset and belt-clip accessories that would allow body-worn operations, what is the minimum separation distance between the antenna and the user's body in this operating configuration?

Can device access wire-line services to make phone calls, either directly or through an operator?

Can specific operating instructions be given to users to eliminate any potential RF Exposure concerns for both front-of-the-face and body-worn operating configurations?

Other applicable information the applicant may provide that can serve as effective means for ensuring RF Exposure compliance:

M. Flom Associates, Inc. is accredited by the American Association for Laboratory Association (A2LA) as shown in the scope below.



THE AMERICAN ASSOCIATION FOR LABORATORY ACCREDITATION

ACCREDITED LABORATORY

A2LA has accredited

M. FLOM ASSOCIATES, INC.
Chandler, AZ

for technical competence in the field of

Electrical (EMC) Testing

The accreditation covers the specific tests and types of tests listed on the agreed scope of accreditation. This laboratory meets the requirements of ISO/IEC Guide 25-1990 "General Requirements for the Competence of Calibration and Testing Laboratories" (equivalent to relevant requirements of the ISO 9000 series of standards) and any additional program requirements in the identified field of testing.

Presented this 24th day of November, 1998.



Peter Abney
President
For the Accreditation Council
Certificate Number 1008.01
Valid to December 31, 2000

For tests or types of tests to which this accreditation applies, please refer to the laboratory's Electrical (EMC) Scope of Accreditation



American Association for Laboratory Accreditation

SCOPE OF ACCREDITATION TO ISO/IEC GUIDE 25-1990 AND EN 45001

M. FLOM ASSOCIATES, INC.
Electronic Testing Laboratory
3356 North San Marcos Place, Suite 107
Chandler, AZ 85225
Morton Flom Phone: 480 926 3100

ELECTRICAL (EMC)

Valid to: December 31, 2000 Certificate Number: 1008-01

In recognition of the successful completion of the A2LA evaluation process, accreditation is granted to this laboratory to perform the following electromagnetic compatibility tests:

Tests	Standard(s)
RF Emissions	FCC Part 15 (Subparts B and C) using ANSI C63 4-1992; CISPR 11; CISPR 13; CISPR 14; CISPR 22; EN 55011; EN 55013; EN 55014; EN 55022; EN 50081-1; EN 50081-2; FCC Part 18; ICES-003; AS/NZS 1044; AS/NZS 1053; AS/NZS 3548; AS/NZS 4251.1; CNS 13438
RF Immunity	EN 50082-1; EN 50082-2; AS/NZS 4251.1
Radiated Susceptibility	EN 61000-4-3; ENV 50140; ENV 50204; IEC 1000-4-3; IEC 801-3
ESD	EN 61000-4-2; IEC 1000-4-2; IEC 801-2
EFT	EN 61000-4-4; IEC 1000-4-4; IEC 801-4
Surge	EN 61000-4-5; ENV 50142; IEC 1000-4-5; IEC 801-5
47 CFR (FCC)	2, 21, 22, 23, 24, 74, 80, 87, 90, 95, 97

Revised 2/2/2000

Peter Abney

5301 Buckeystown Pike, Suite 350 • Frederick, MD 21704-8370 • Phone: 301 644 3248 • Fax: 301 662 2974

"This laboratory is accredited by the American Association for Laboratory Accreditation (A2LA) and the results shown in this report have been determined in accordance with the laboratory's terms of accreditation unless stated otherwise in the report."

Should this report contain any data for tests for which we are not accredited, or which have been undertaken by a subcontractor that is not A2LA accredited, such data would not covered by this laboratory's A2LA accreditation.

PAGE NO. 5 of 46.

Subpart 2.1033 (continued)

(c) (8): VOLTAGES & CURRENTS IN ALL ELEMENTS IN FINAL R. F. STAGE, INCLUDING FINAL TRANSISTOR OR SOLID STATE DEVICE:

COLLECTOR CURRENT, A = per manual
 COLLECTOR VOLTAGE, Vdc = per manual
 SUPPLY VOLTAGE, Vdc = 7.5

(c) (9): TUNE-UP PROCEDURE:

PLEASE SEE ATTACHED EXHIBITS

(c) (10): CIRCUIT DIAGRAM/CIRCUIT DESCRIPTION:

Including description of circuitry & devices provided for determining and stabilizing frequency, for suppression of spurious radiation, for limiting modulation and limiting power.

PLEASE SEE ATTACHED EXHIBITS

(c) (11): LABEL INFORMATION:

PLEASE SEE ATTACHED EXHIBITS

(c) (12): PHOTOGRAPHS:

PLEASE SEE ATTACHED EXHIBITS

(c) (13): DIGITAL MODULATION DESCRIPTION:

ATTACHED EXHIBITS
 N/A

(c) (14): TEST AND MEASUREMENT DATA:

FOLLOWS

PAGE NO.

6 of 46.

Sub-part

2.1033(c) (14):

TEST AND MEASUREMENT DATA

All tests and measurement data shown were performed in accordance with FCC Rules and Regulations, Volume II; Part 2, Sub-part J, Sections 2.947, 2.1033(c), 2.1041, 2.1046, 2.1047, 2.1079, 2.1051, 2.1053, 2.1055, 2.1057 and the following individual Parts:

- 21 - Domestic Public Fixed Radio Services
- 22 - Public Mobile Services
- 22 Subpart H - Cellular Radiotelephone Service
- 22.901(d) - Alternative technologies and auxiliary services
- 23 - International Fixed Public Radiocommunication services
- 24 - Personal Communications Services
- 74 Subpart H - Low Power Auxiliary Stations
- 80 - Stations in the Maritime Services
- 80 Subpart E - General Technical Standards
- 80 Subpart F - Equipment Authorization for Compulsory Ships
- 80 Subpart K - Private Coast Stations and Marine Utility Stations
- 80 Subpart S - Compulsory Radiotelephone Installations for Small Passenger Boats
- 80 Subpart T - Radiotelephone Installation Required for Vessels on the Great Lakes
- 80 Subpart U - Radiotelephone Installations Required by the Bridge-to-Bridge Act
- 80 Subpart V - Emergency Position Indicating Radiobeacons (EPIRB'S)
- 80 Subpart W - Global Maritime Distress and Safety System (GMDSS)
- 80 Subpart X - Voluntary Radio Installations
- 87 - Aviation Services
- 90 - Private Land Mobile Radio Services
- 94 - Private Operational-Fixed Microwave Service
- 95 Subpart A - General Mobile Radio Service (GMRS)
- 95 Subpart C - Radio Control (R/C) Radio Service
- 95 Subpart D - Citizens Band (CB) Radio Service
- 95 Subpart E - Family Radio Service
- 95 Subpart F - Interactive Video and Data Service (IVDS)
- 97 - Amateur Radio Service
- 101 - Fixed Microwave Services

PAGE NO.

7 of 46.

STANDARD TEST CONDITIONS
and
ENGINEERING PRACTICES

Except as noted herein, the following conditions and procedures were observed during the testing:

In accordance with ANSI C63.4-1992, section 6.1.9, and unless otherwise indicated in the specific measurement results, the ambient temperature of the actual EUT was maintained within the range of 10° to 40°C (50° to 104 °F) unless the particular equipment requirements specify testing over a different temperature range. Also, unless otherwise indicated, the humidity levels were in the range of 10% to 90% relative humidity.

Prior to testing, the EUT was tuned up in accordance with the manufacturer's alignment procedures. All external gain controls were maintained at the position of maximum and/or optimum gain throughout the testing.

Measurement results, unless otherwise noted, are worst case measurements.

PAGE NO. 8 of 46.
NAME OF TEST: Carrier Output Power (Conducted)
SPECIFICATION: 47 CFR 2.1046(a)
GUIDE: ANSI/TIA/EIA-603-1992, Paragraph 2.2.1
TEST EQUIPMENT: As per attached page

MEASUREMENT PROCEDURE

1. The EUT was connected to a resistive coaxial attenuator of normal load impedance, and the unmodulated output power was measured by means of an R. F. Power Meter.
2. Measurement accuracy is $\pm 3\%$.

MEASUREMENT RESULTS
(Worst case)

FREQUENCY OF CARRIER, MHz = 155.05, 136.05, 173.95

POWER SETTING	R. F. POWER, WATTS
Low	1
High	5

SUPERVISED BY:

Morton Flom, P. Eng.

TRANSMITTER POWER CONDUCTED MEASUREMENTS

TEST 1: R. F. POWER OUTPUT
 TEST 2: FREQUENCY STABILITY

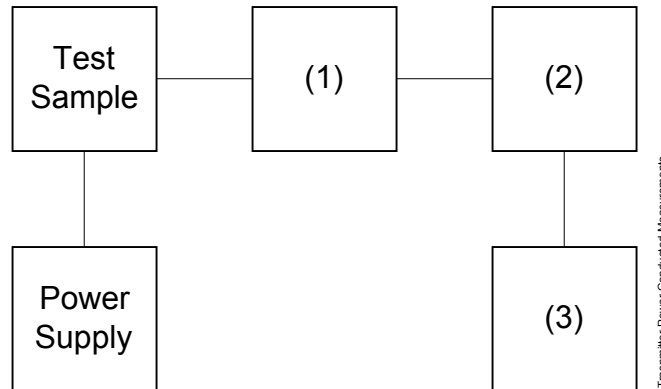

Asset	Description (as applicable)	s/n
(1)	<u>COAXIAL ATTENUATOR</u>	
i00122	Narda 766-10	7802
i00123	Narda 766-10	7802A
i00069	Bird 8329 (30 dB)	1006
i00113	Sierra 661A-3D	1059
(2)	<u>POWER METERS</u>	
i00014	HP 435A	1733A05836
i00039	HP 436A	2709A26776
i00020	HP 8901A POWER MODE	2105A01087
(3)	<u>FREQUENCY COUNTER</u>	
i00042	HP 5383A	1628A00959
i00019	HP 5334B	2704A00347
i00020	HP 8901A FREQUENCY MODE	2105A01087

PAGE NO. 10 of 46.

NAME OF TEST: Unwanted Emissions (Transmitter Conducted)

SPECIFICATION: 47 CFR 2.1051

GUIDE: ANSI/TIA/EIA-603-1992, Paragraph 2.2.13

TEST EQUIPMENT: As per attached page

MEASUREMENT PROCEDURE

1. The emissions were measured for the worst case as follows:
 - (a): within a band of frequencies defined by the carrier frequency plus and minus one channel.
 - (b): from the lowest frequency generated in the EUT and to at least the 10th harmonic of the carrier frequency, or 40 GHz, whichever is lower.
2. The magnitude of spurious emissions that are attenuated more than 20 dB below the permissible value need not be specified.
3. MEASUREMENT RESULTS: ATTACHED FOR WORST CASE

FREQUENCY OF CARRIER, MHz	=	155.05, 136.05, 173.95
SPECTRUM SEARCHED, GHz	=	0 to 10 x F _c
MAXIMUM RESPONSE, Hz	=	2240
ALL OTHER EMISSIONS	=	≥ 20 dB BELOW LIMIT
LIMIT(S), dBc		
	- (50+10xLOG P)	= -50 (1 Watt)
	- (50+10xLOG P)	= -57 (5 Watts)

SUPERVISED BY:

Morton Flom, P. Eng.

TRANSMITTER SPURIOUS EMISSION

TEST A. OCCUPIED BANDWIDTH (IN-BAND SPURIOUS)
 TEST B. OUT-OF-BAND SPURIOUS

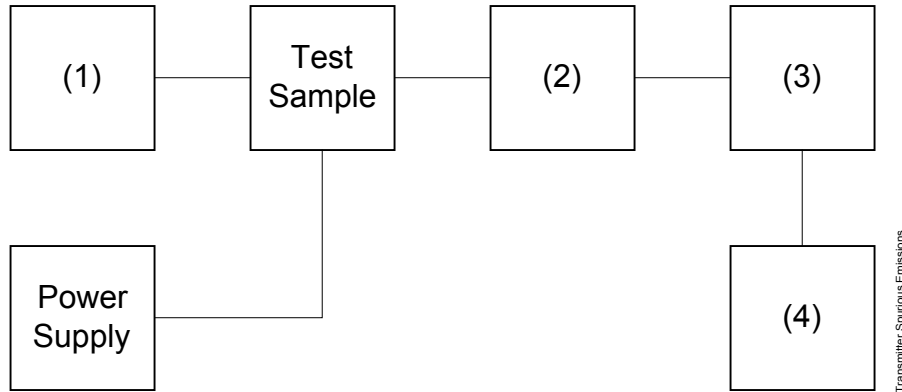

Asset Description (as applicable)	s/n
<u>(1) AUDIO OSCILLATOR/GENERATOR</u>	
i00010 HP 204D	1105A04683
i00017 HP 8903A	2216A01753
i00012 HP 3312A	1432A11250
<u>(2) COAXIAL ATTENUATOR</u>	
i00122 Narda 766-10	7802
i00123 Narda 766-10	7802A
i00069 Bird 8329 (30 dB)	1006
i00113 Sierra 661A-3D	1059
<u>(3) FILTERS; NOTCH, HP, LP, BP</u>	
i00126 Eagle TNF-1	100-250
i00125 Eagle TNF-1	50-60
i00124 Eagle TNF-1	250-850
<u>(4) SPECTRUM ANALYZER</u>	
i00048 HP 8566B	2511A01467
i00029 HP 8563E	3213A00104

PAGE NO. 12 of 46.

NAME OF TEST: Unwanted Emissions (Transmitter Conducted)
 g0070728: 2000-Jul-21 Fri 15:06:00
 STATE: 1:Low Power

FREQUENCY TUNED, MHz	FREQUENCY EMISSION, MHz	LEVEL, dBm	LEVEL, dBc	MARGIN, dB
136.050000	272.108000	-48	-78	-28
155.050000	310.114000	-45.4	-75.4	-25.4
173.950000	347.900000	-47.8	-77.8	-27.8
136.050000	408.143000	-51.1	-81.1	-31.1
155.050000	465.409000	-53.3	-83.3	-33.3
173.950000	522.001000	-52	-82	-32
136.050000	544.359000	-52	-82	-32
155.050000	620.215000	-47.3	-77.3	-27.3
136.050000	680.142000	-52.2	-82.2	-32.2
173.950000	695.907000	-52.2	-82.2	-32.2
155.050000	775.426000	-53.1	-83.1	-33.1
136.050000	816.294000	-52.3	-82.3	-32.3
173.950000	869.776000	-51.7	-81.7	-31.7
155.050000	929.856000	-52.3	-82.3	-32.3
136.050000	952.525000	-52.5	-82.5	-32.5
173.950000	1043.359000	-53	-83	-33
155.050000	1085.814000	-52.1	-82.1	-32.1
136.050000	1088.364000	-52.8	-82.8	-32.8
173.950000	1217.430000	-52.9	-82.9	-32.9
136.050000	1223.986000	-52.6	-82.6	-32.6
155.050000	1240.609000	-52.5	-82.5	-32.5
136.050000	1360.015000	-52.5	-82.5	-32.5
173.950000	1391.351000	-52.6	-82.6	-32.6
155.050000	1395.561000	-51.6	-81.6	-31.6
136.050000	1496.316000	-52.4	-82.4	-32.4
155.050000	1550.551000	-51.7	-81.7	-31.7
173.950000	1565.514000	-52.2	-82.2	-32.2
136.050000	1632.997000	-51.7	-81.7	-31.7
155.050000	1705.553000	-51.1	-81.1	-31.1
173.950000	1739.230000	-51.9	-81.9	-31.9
136.050000	1768.553000	-51.2	-81.2	-31.2
155.050000	1860.108000	-51.9	-81.9	-31.9
136.050000	1904.609000	-52	-82	-32
173.950000	1913.701000	-51.6	-81.6	-31.6
155.050000	2015.196000	-51.1	-81.1	-31.1
136.050000	2040.769000	-51.8	-81.8	-31.8
173.950000	2086.961000	-51.5	-81.5	-31.5
155.050000	2170.903000	-50.1	-80.1	-30.1
173.950000	2261.812000	-51.1	-81.1	-31.1
155.050000	2325.508000	-50.8	-80.8	-30.8
173.950000	2435.518000	-50.4	-80.4	-30.4
173.950000	2608.752000	-53	-83	-33

PAGE NO. 13 of 46.

NAME OF TEST: Unwanted Emissions (Transmitter Conducted)
 g0070727: 2000-Jul-21 Fri 15:02:00
 STATE: 2:High Power

FREQUENCY TUNED, MHz	FREQUENCY EMISSION, MHz	LEVEL, dBm	LEVEL, dBc	MARGIN, dB
136.050000	272.101000	-42.3	-79.2	-22.3
155.050000	310.353000	-43.3	-80.2	-23.3
173.950000	347.445000	-42.5	-79.4	-22.5
136.050000	408.085000	-43	-79.9	-23
155.050000	464.819000	-42.8	-79.7	-22.8
173.950000	521.644000	-42.8	-79.7	-22.8
136.050000	543.787000	-42.3	-79.2	-22.3
155.050000	620.149000	-43.2	-80.1	-23.2
136.050000	680.492000	-43.8	-80.7	-23.8
173.950000	695.970000	-43.3	-80.2	-23.3
155.050000	775.538000	-43.1	-80	-23.1
136.050000	816.721000	-43.6	-80.5	-23.6
173.950000	869.808000	-42.6	-79.5	-22.6
155.050000	930.498000	-43	-79.9	-23
136.050000	952.383000	-43.4	-80.3	-23.4
173.950000	1043.871000	-43.1	-80	-23.1
155.050000	1085.679000	-42.5	-79.4	-22.5
136.050000	1088.654000	-43.1	-80	-23.1
173.950000	1217.632000	-42.7	-79.6	-22.7
136.050000	1224.467000	-42.9	-79.8	-22.9
155.050000	1240.542000	-43.2	-80.1	-23.2
136.050000	1360.703000	-42.9	-79.8	-22.9
173.950000	1391.893000	-43.3	-80.2	-23.3
155.050000	1394.998000	-42.6	-79.5	-22.6
136.050000	1496.658000	-43.4	-80.3	-23.4
155.050000	1550.218000	-43.4	-80.3	-23.4
173.950000	1565.381000	-42.3	-79.2	-22.3
136.050000	1632.581000	-42.9	-79.8	-22.9
155.050000	1705.575000	-42.7	-79.6	-22.7
173.950000	1739.778000	-41.4	-78.3	-21.4
136.050000	1768.198000	-42	-78.9	-22
155.050000	1860.332000	-42.1	-79	-22.1
136.050000	1904.837000	-42.4	-79.3	-22.4
173.950000	1913.016000	-43.4	-80.3	-23.4
155.050000	2015.475000	-42.2	-79.1	-22.2
136.050000	2040.985000	-41.4	-78.3	-21.4
173.950000	2087.614000	-42.4	-79.3	-22.4
155.050000	2171.002000	-40.7	-77.6	-20.7
173.950000	2261.381000	-41.6	-78.5	-21.6
155.050000	2325.755000	-41.3	-78.2	-21.3
173.950000	2435.670000	-41.2	-78.1	-21.2
173.950000	2609.727000	-42.8	-79.7	-22.8

PAGE NO. 14 of 46.
NAME OF TEST: Field Strength of Spurious Radiation
SPECIFICATION: 47 CFR 2.1053(a)
GUIDE: ANSI/TIA/EIA-603-1992, Paragraph 2.2.12
TEST EQUIPMENT: As per attached page

MEASUREMENT PROCEDURE

1. A description of the measurement facilities was filed with the FCC and was found to be in compliance with the requirements of Section 2.948, by letter from the FCC dated March 3, 1997, FILE 31040/SIT. All pertinent changes will be reported to the Commission by up-date prior to March 2003.
2. At first, in order to locate all spurious frequencies and approximate amplitudes, and to determine proper equipment functioning, the test sample was set up at a distance of three meters from the test instrument. Valid spurious signals were determined by switching the power on and off.
3. In the field, the test sample was placed on a wooden turntable above ground at three (or thirty) meters away from the search antenna. Excess power leads were coiled near the power supply.

The cables were oriented in order to obtain the maximum response. At each emission frequency, the turntable was rotated and the search antennas were raised and lowered vertically.
4. The emission was observed with both a vertically polarized and a horizontally polarized search antenna and the worst case was used.
6. The field strength of each emission within 20 dB of the limit was recorded and corrected with the appropriate cable and transducer factors.
7. The worst case for all channels is shown.
8. Measurement results: ATTACHED FOR WORST CASE

PAGE NO. 16 of 46.

NAME OF TEST: Field Strength of Spurious Radiation

ALL OTHER EMISSIONS = ≥ 20 dB BELOW LIMIT

EMISSION, MHz/HARMONIC	SPURIOUS LEVEL, dBc	
	Low	High
2nd to 10th	<-75	<-75

SUPERVISED BY:

Morton Flom, P. Eng.

PAGE NO. 17 of 46.
NAME OF TEST: Emission Masks (Occupied Bandwidth)
SPECIFICATION: 47 CFR 2.1049(c)(1)
GUIDE: ANSI/TIA/EIA-603-1992, Paragraph 2.2.11
TEST EQUIPMENT: As per previous page

MEASUREMENT PROCEDURE

1. The EUT and test equipment were set up as shown on the following page, with the Spectrum Analyzer connected.
2. For EUTs supporting audio modulation, the audio signal generator was adjusted to the frequency of maximum response and with output level set for $\pm 2.5/\pm 1.25$ kHz deviation (or 50% modulation). With level constant, the signal level was increased 16 dB.
3. For EUTs supporting digital modulation, the digital modulation mode was operated to its maximum extent.
4. The Occupied Bandwidth was measured with the Spectrum Analyzer controls set as shown on the test results.
5. MEASUREMENT RESULTS: ATTACHED

PAGE NO. 18 of 46.

NAME OF TEST: Emission Masks (Occupied Bandwidth)
g0070722: 2000-Jul-21 Fri 14:49:00
STATE: 1:Low Power

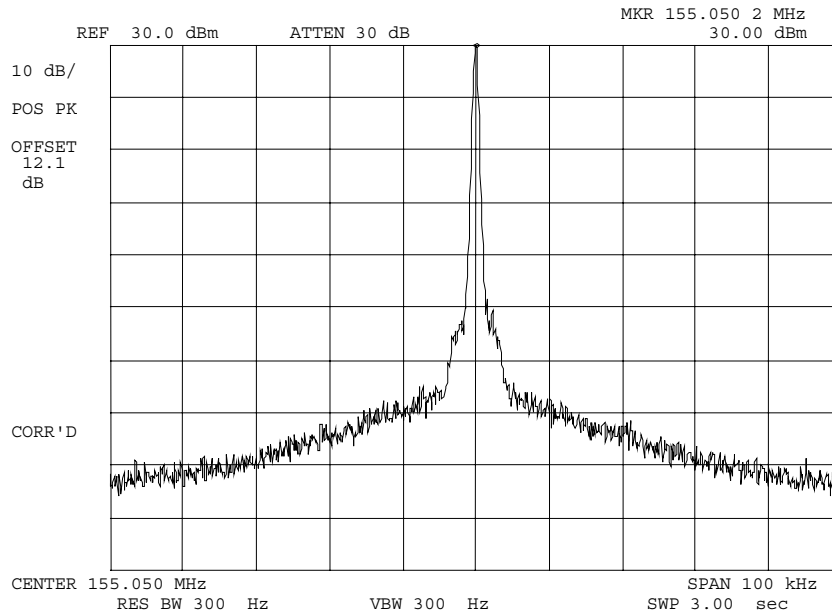

POWER: LOW
MODULATION: NONE

SUPERVISED BY:

Morton Flom, P. Eng.

PAGE NO. 19 of 46.

NAME OF TEST: Emission Masks (Occupied Bandwidth)
g0070724: 2000-Jul-21 Fri 14:55:00
STATE: 1:Low Power

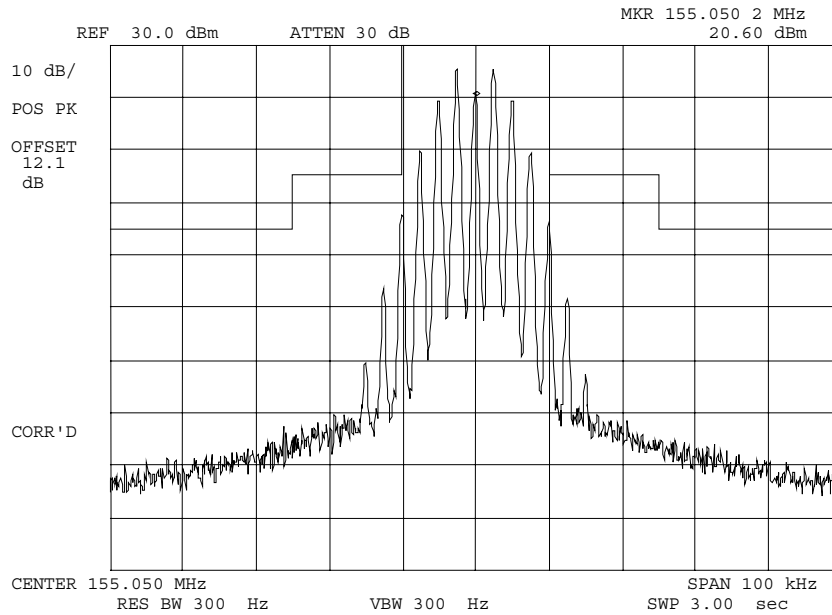

POWER:
MODULATION:

LOW
VOICE: 2500 Hz SINE WAVE
MASK: B, VHF/UHF 25kHz,
w/LPF

SUPERVISED BY:

Morton Flom P. Eng.
Morton Flom, P. Eng.

PAGE NO. 20 of 46.

NAME OF TEST: Emission Masks (Occupied Bandwidth)
g0070726: 2000-Jul-21 Fri 15:00:00
STATE: 1:Low Power

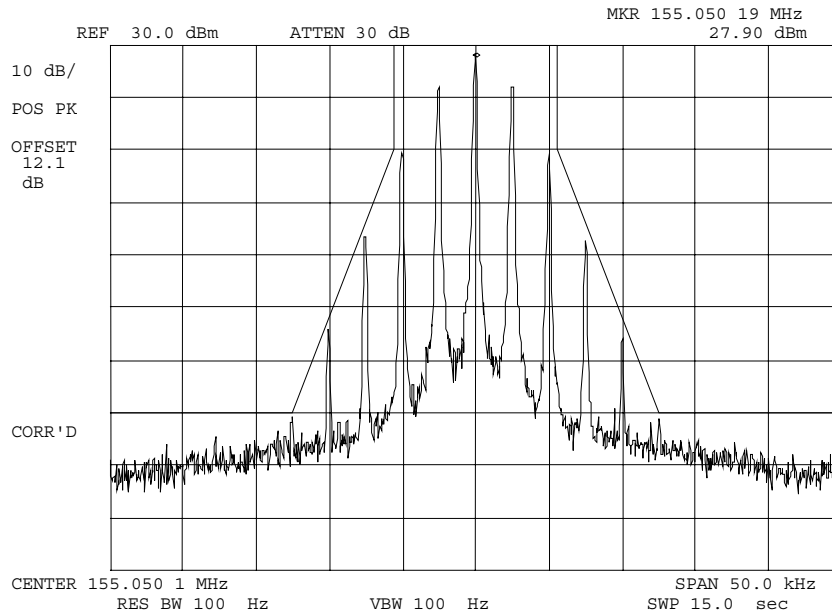

POWER:
MODULATION:

LOW
VOICE: 2500 Hz SINE WAVE
MASK: D, VHF/UHF 12.5kHz BW

SUPERVISED BY:

Morton Flom P. Eng.
Morton Flom, P. Eng.

PAGE NO. 21 of 46.

NAME OF TEST: Emission Masks (Occupied Bandwidth)
g0070721: 2000-Jul-21 Fri 14:46:00
STATE: 2:High Power

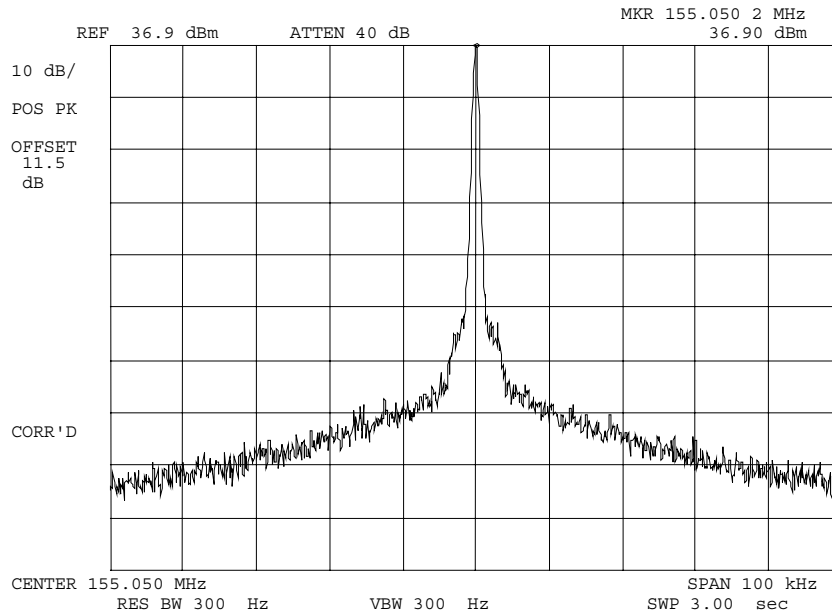

POWER: HIGH
MODULATION: NONE

SUPERVISED BY:

Morton Flom, P. Eng.

PAGE NO.

22 of 46.

NAME OF TEST: Emission Masks (Occupied Bandwidth)
g0070723: 2000-Jul-21 Fri 14:54:00
STATE: 2:High Power

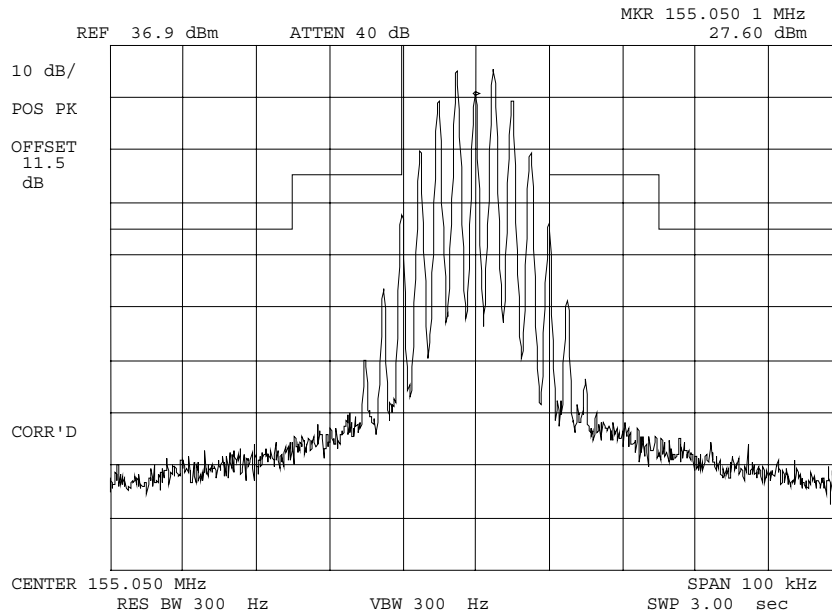

POWER:
MODULATION:

HIGH
VOICE: 2500 Hz SINE WAVE
MASK: B, VHF/UHF 25kHz,
w/LPF

SUPERVISED BY:

Morton Flom, P. Eng.

PAGE NO. 23 of 46.

NAME OF TEST: Emission Masks (Occupied Bandwidth)
g0070725: 2000-Jul-21 Fri 14:59:00
STATE: 2:High Power

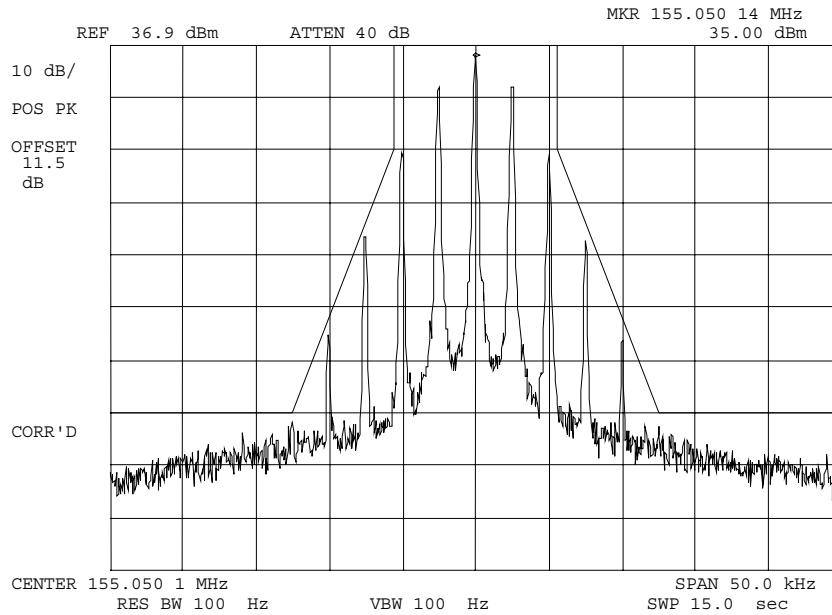

POWER: HIGH
MODULATION: VOICE: 2500 Hz SINE WAVE
MASK: D, VHF/UHF 12.5kHz BW

SUPERVISED BY:

Morton Flom P. Eng.
Morton Flom, P. Eng.

PAGE NO. 24 of 46.
NAME OF TEST: Transient Frequency Behavior
SPECIFICATION: 47 CFR 90.214
GUIDE: ANSI/TIA/EIA-603-1992, Paragraph 2.2.19
TEST EQUIPMENT: As per attached page

MEASUREMENT PROCEDURE

1. The EUT was setup as shown on the attached page, following TIA/EIA-603 steps a, b, and c as a *guide*.
2. The transmitter was turned on.
3. Sufficient attenuation was provided so that the transmitter carrier level measured at the output of the combiner was 40 dB below the maximum input level of the test receiver. This level was recorded as step f.
4. The transmitter was turned off.
5. An RF signal generator (1) modulated with a 1 kHz tone at either 25, 12.5, or 6.25 kHz deviation, and set to the same frequency as the assigned transmitter frequency, (2) was adjusted to a level -20 dB below the level recorded for step f, as measured at the output of the combiner. This level was then fixed for the remainder of the test and is recorded at step h.
6. The oscilloscope was setup using TIA/EIA-603 steps j and k as a guide, and to either 10 ms/div (UHF) or 5 ms/div (VHF).
7. The 30 dB attenuator was removed, the transmitter was turned on, and the level of the carrier at the output of the combiner was recorded as step l.
8. The carrier on-time as referenced in TIA/EIA-603 steps m, n, and o was captured and plotted. The carrier off-time as referenced in TIA/EIA-603 steps p, q, r, and s was captured and plotted.

LEVELS MEASURED:

<u>step f</u> , dBm	=	-2.8
<u>step h</u> , dBm	=	-35.1
<u>step l</u> , dBm	=	15.7

Morton Flom P. Eng.

SUPERVISED BY: Morton Flom, P. Eng.

TRANSIENT FREQUENCY BEHAVIOR

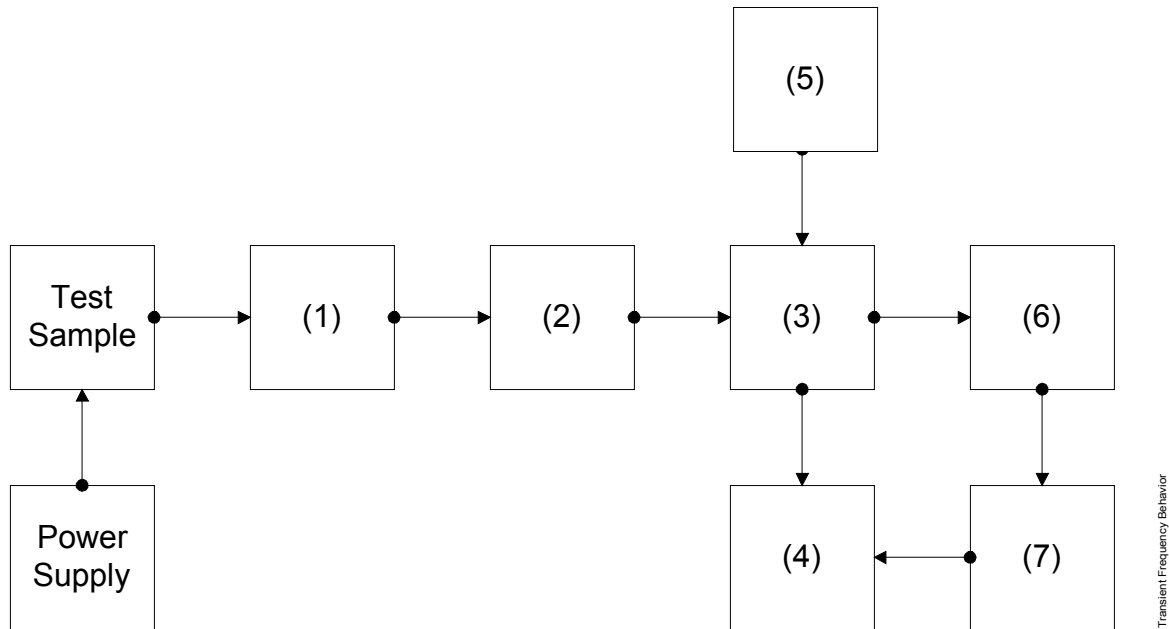

Asset	Description (as applicable)	s/n
(1)	<u>ATTENUATOR</u> (Removed after 1st step)	
	i00112 Philco 30 dB	989
(2)	<u>ATTENUATOR</u>	
	i00112 Philco 30 dB	989
	i00172 Bird 30 dB	989
	i00122 Narda 10 dB	7802
	i00123 Narda 10 dB	7802A
	i00110 Kay Variable	145-387
(3)	<u>COMBINER</u>	
	i00154 4 x 25 Ω COMBINER	154
(4)	<u>CRYSTAL DETECTOR</u>	
	i00159 HP 8470B	1822A10054
(5)	<u>RF SIGNAL GENERATOR</u>	
	i00018 HP 8656A	2228A03472
	i00031 HP 8656A	2402A06180
	i00067 HP 8920A	3345U01242
(6)	<u>MODULATION ANALYZER</u>	
	i00020 HP 8901A	2105A01087
(7)	<u>SCOPE</u>	
	i00030 HP 54502A	2927A00209

PAGE NO.

28 of 46.

NAME OF TEST: Transient Frequency Behavior
g0070731: 2000-Jul-21 Fri 15:39:00
STATE: 2:High Power

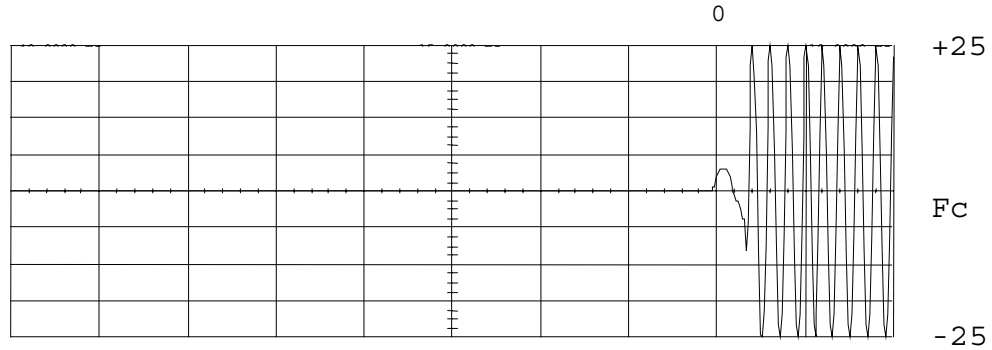

```

Main           Minibase      Rate/Dev      RefGen -     Mod-
              5.00 MHz/div      15.0000 MHz      System      Resolution

Channel 1      Resolution      Offset      Scale      Units
              500 MHz/div      0.00000 MHz      1.000      1      dB (1M offset)

Resolution = 500 MHz
Ref Resolution = 500 MHz
Main Span = 1.00000 MHz (Center Freq = 0 MHz)
Main Freq = 40.000 MHz

```

POWER:
MODULATION:
DESCRIPTION:

HIGH
Ref Gen=25 kHz Deviation
CARRIER OFF TIME

SUPERVISED BY:

Morton Flom P. Eng.
Morton Flom, P. Eng.

PAGE NO.

32 of 46.

NAME OF TEST: Transient Frequency Behavior
 g0070735: 2000-Jul-21 Fri 15:53:00
 STATE: 2:High Power

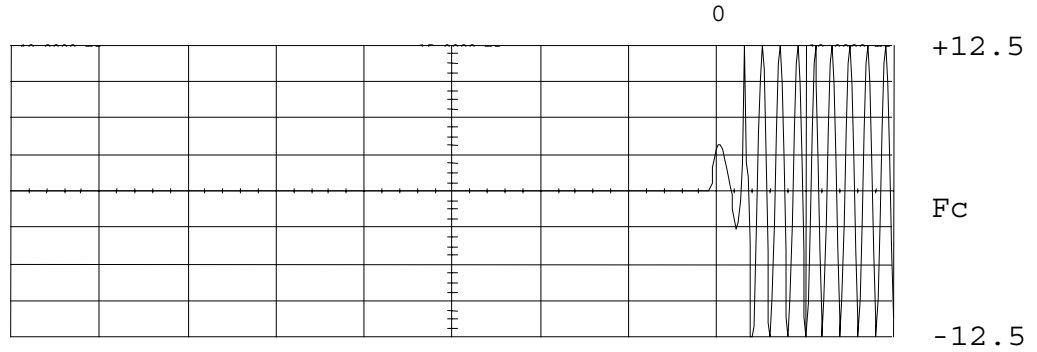

```

Main           Modulation      Rate/Dev      RefGen      Mod-
              5.00 MHz/300      15.0000 Hz      1000000      1000000
Channel 1      300 MHz/300      0.0000 Hz      1.000 1      2 (1M chn)
Modulation Mode: FSK
Modulation Rate: 15.0000 Hz
Modulation Dev: 300.0000 Hz
Modulation Type: FSK
Modulation Rate: 15.0000 Hz
Modulation Dev: 300.0000 Hz
    
```

POWER:
 MODULATION:
 DESCRIPTION:

HIGH
 Ref Gen=12.5 kHz Deviation
 CARRIER OFF TIME

SUPERVISED BY:

Morton Flom P. Eng.
 Morton Flom, P. Eng.

PAGE NO.

33 of 46.

NAME OF TEST: Transient Frequency Behavior
g0070736: 2000-Jul-21 Fri 15:53:00
STATE: 2:High Power

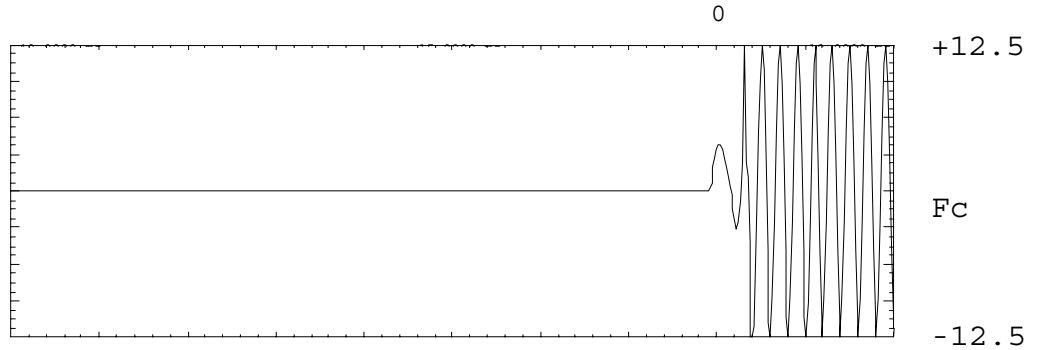

```

      Minibits  Rate/Sec  RefGen  Mod
Mod  5.00 MHz/div  15.0000 Hz  10000  1
-----
channel 1  300 MHz/div  0.00000 Hz  1.000  1  2 (1M chn)
-----
      Modulation  Mod  Rate
As Resolution Rate 05  1000
Modulation Rate 1
Rate 1 10000 Hz (Resolution 1.0M)
Rate 2 10.000 Hz

```

POWER:
MODULATION:
DESCRIPTION:

HIGH
Ref Gen=12.5 kHz Deviation
CARRIER OFF TIME

SUPERVISED BY:

Morton Flom P. Eng.
Morton Flom, P. Eng.

PAGE NO. 34 of 46.
NAME OF TEST: Audio Low Pass Filter (Voice Input)
SPECIFICATION: 47 CFR 2.1047(a)
GUIDE: ANSI/TIA/EIA-603-1992, Paragraph 2.2.15
TEST EQUIPMENT: As per attached page

MEASUREMENT PROCEDURE

1. The EUT and test equipment were set up such that the audio input was connected at the input to the modulation limiter, and the modulated stage.
2. The audio output was connected at the output to the modulated stage.
3. MEASUREMENT RESULTS: ATTACHED

TRANSMITTER TEST SET-UP

- TEST A. MODULATION CAPABILITY/DISTORTION
- TEST B. AUDIO FREQUENCY RESPONSE
- TEST C. HUM AND NOISE LEVEL
- TEST D. RESPONSE OF LOW PASS FILTER
- TEST E. MODULATION LIMITING

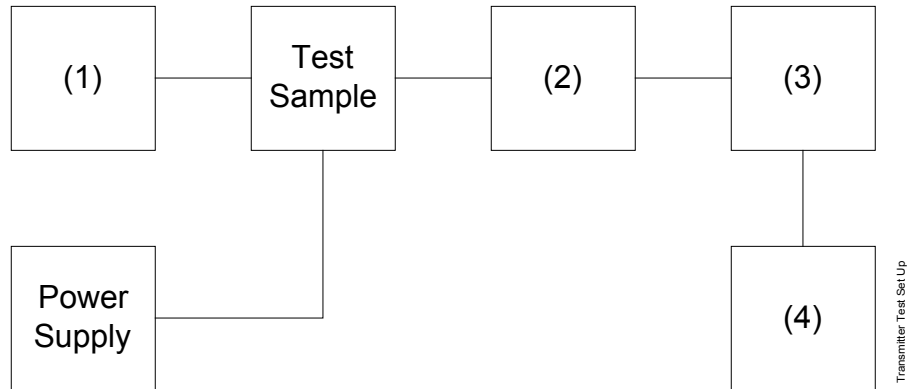

Asset Description (as applicable)	s/n
(1) <u>Audio Oscillator</u>	
i00010 HP 204D	1105A04683
i00017 HP 8903A	2216A01753
i00118 HP 33120A	US36002064
(2) <u>COAXIAL ATTENUATOR</u>	
i00122 NARDA 766-10	7802
i00123 NARDA 766-10	7802A
i00113 SIERRA 661A-3D	1059
i00069 BIRD 8329 (30 dB)	10066
(3) <u>MODULATION ANALYZER</u>	
i00020 HP 8901A	2105A01087
(4) <u>AUDIO ANALYZER</u>	
i00017 HP 8903A	2216A01753

PAGE NO.

36 of 46.

NAME OF TEST: Audio Low Pass Filter (Voice Input)
g0070612: 2000-Jul-21 Fri 14:20:00
STATE: 0:General

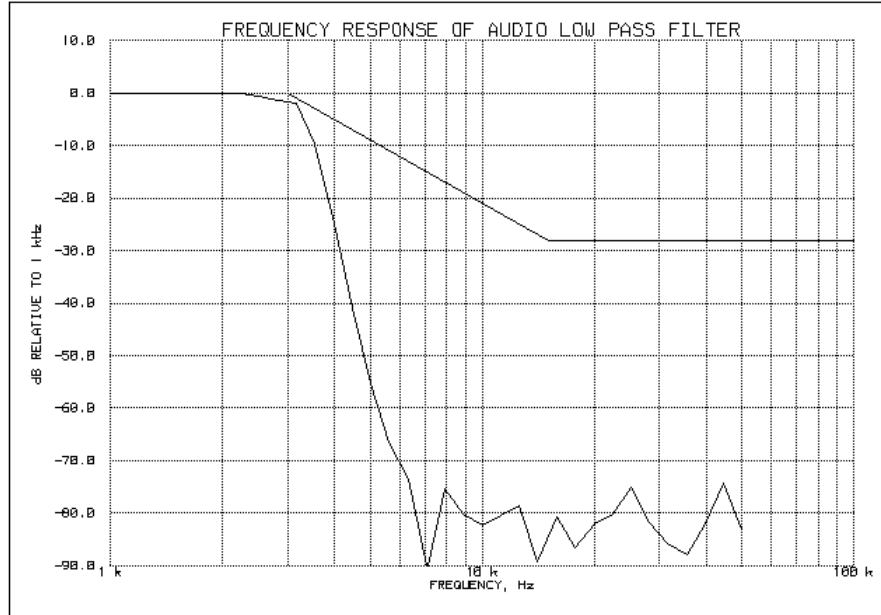

SUPERVISED BY:

Morton Flom, P. Eng.

PAGE NO. 37 of 46.
NAME OF TEST: Audio Frequency Response
SPECIFICATION: 47 CFR 2.1047(a)
GUIDE: ANSI/TIA/EIA-603-1992, Paragraph 2.2.6
TEST EQUIPMENT: As per previous page

MEASUREMENT PROCEDURE

1. The EUT and test equipment were set up as shown on the following page.
2. The audio signal generator was connected to the audio input circuit/microphone of the EUT.
3. The audio signal input was adjusted to obtain 20% modulation at 1 kHz, and this point was taken as the 0 dB reference level.
4. With input levels held constant and below limiting at all frequencies, the audio signal generator was varied from 100 Hz to 50 kHz.
5. The response in dB relative to 1 kHz was then measured, using the HP 8901A Modulation Analyzer.
6. MEASUREMENT RESULTS: ATTACHED

PAGE NO. 38 of 46.

NAME OF TEST: Audio Frequency Response
 g0070611: 2000-Jul-21 Fri 14:18:00
 STATE: 0:General

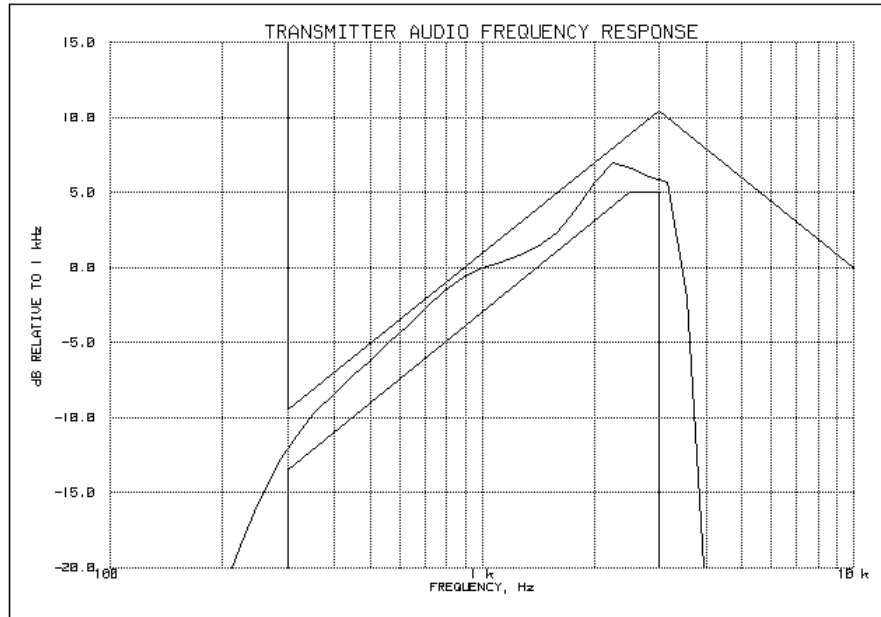

Frequency of Maximum Audio Response, Hz = 2240

Additional points:

FREQUENCY, Hz	LEVEL, dB
300	-12.01
20000	-31.63
30000	-31.78
50000	-31.64

Morton P. Eng

SUPERVISED BY:

Morton Flom, P. Eng.

PAGE NO. 39 of 46.
NAME OF TEST: Modulation Limiting
SPECIFICATION: 47 CFR 2.1047(b)
GUIDE: ANSI/TIA/EIA-603-1992, Paragraph 2.2.3
TEST EQUIPMENT: As per previous page

MEASUREMENT PROCEDURE

1. The signal generator was connected to the input of the EUT as for "Frequency Response of the Modulating Circuit."
2. The modulation response was measured for each of three frequencies (one of which was the frequency of maximum response), and the input voltage was varied and was observed on an HP 8901A Modulation Analyzer.
3. The input level was varied from 30% modulation (± 1.5 kHz deviation) to at least 20 dB higher than the saturation point.
4. Measurements were performed for both negative and positive modulation and the respective results were recorded.
5. MEASUREMENT RESULTS: ATTACHED

PAGE NO.

40 of 46.

NAME OF TEST: Modulation Limiting
g0070613: 2000-Jul-21 Fri 14:24:00
STATE: 0:General

Positive
Peaks:

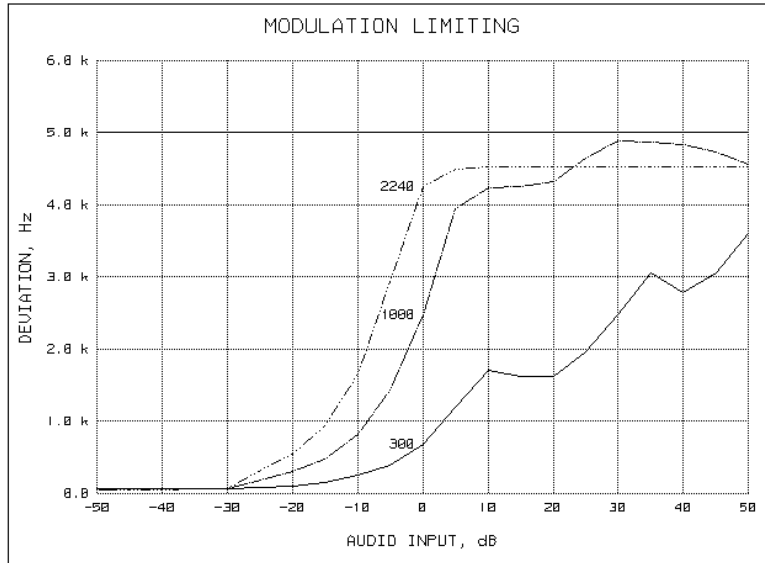

Negative
Peaks:

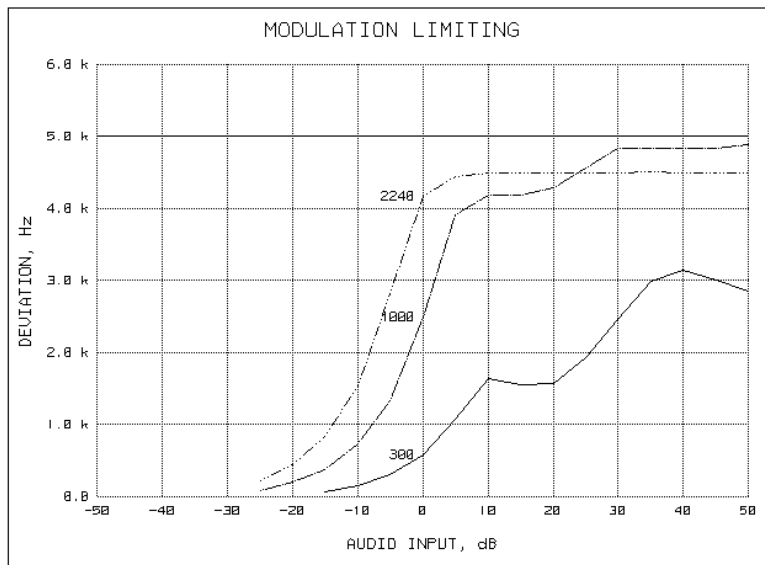

SUPERVISED BY:

Morton Flom, P. Eng.

PAGE NO.

41 of 46.

NAME OF TEST: Modulation Limiting
g0070614: 2000-Jul-21 Fri 14:28:00
STATE: 0:General

Positive
Peaks:

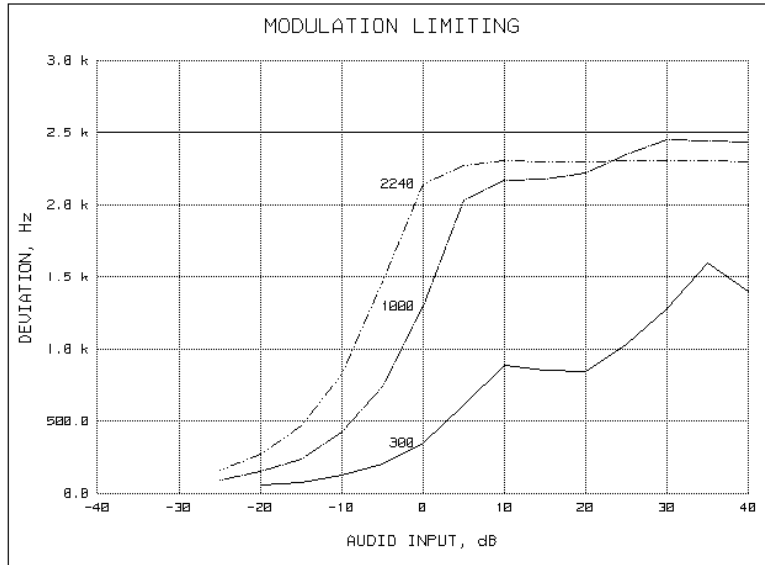

Negative
Peaks:

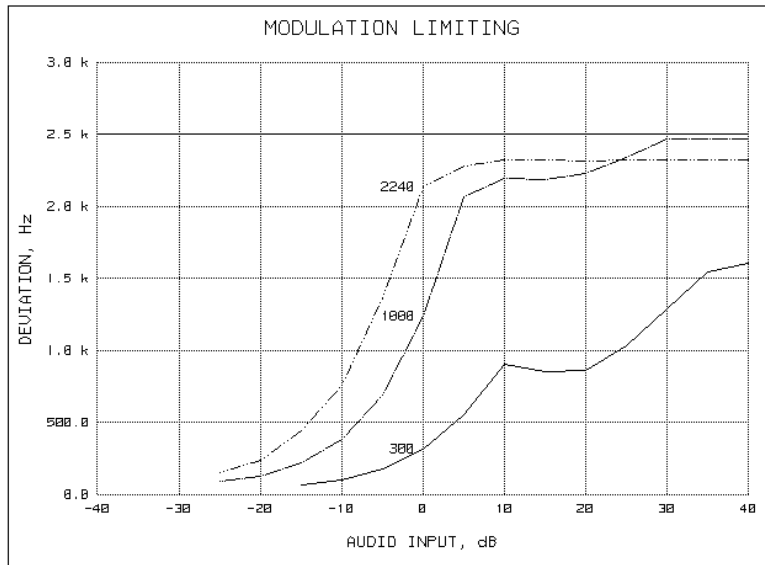

SUPERVISED BY:

Morton Flom, P. Eng.

PAGE NO. 42 of 46.
NAME OF TEST: Frequency Stability (Temperature Variation)
SPECIFICATION: 47 CFR 2.1055(a)(1)
GUIDE: ANSI/TIA/EIA-603-1992, Paragraph 2.2.2
TEST CONDITIONS: As Indicated
TEST EQUIPMENT: As per previous page

MEASUREMENT PROCEDURE

1. The EUT and test equipment were set up as shown on the following page.
2. With all power removed, the temperature was decreased to -30°C and permitted to stabilize for three hours. Power was applied and the maximum change in frequency was noted within one minute.
3. With power OFF, the temperature was raised in 10°C steps. The sample was permitted to stabilize at each step for at least one-half hour. Power was applied and the maximum frequency change was noted within one minute.
4. The temperature tests were performed for the worst case.
5. MEASUREMENT RESULTS: ATTACHED

TRANSMITTER TEST SET-UP

- TEST A. OPERATIONAL STABILITY
- TEST B. CARRIER FREQUENCY STABILITY
- TEST C. OPERATIONAL PERFORMANCE STABILITY
- TEST D. HUMIDITY
- TEST E. VIBRATION
- TEST F. ENVIRONMENTAL TEMPERATURE
- TEST G. FREQUENCY STABILITY: TEMPERATURE VARIATION
- TEST H. FREQUENCY STABILITY: VOLTAGE VARIATION

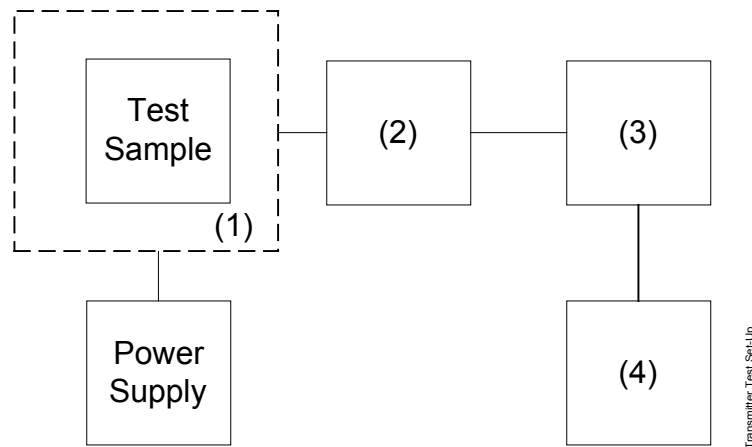

Asset Description (as applicable)	s/n
<u>(1) TEMPERATURE, HUMIDITY, VIBRATION</u>	
i00027 Tenny Temp. Chamber	9083-765-234
i00 Weber Humidity Chamber	
i00 L.A.B. RVH 18-100	
<u>(2) COAXIAL ATTENUATOR</u>	
i00122 NARDA 766-10	7802
i00123 NARDA 766-10	7802A
i00113 SIERRA 661A-3D	1059
i00069 BIRD 8329 (30 dB)	10066
<u>(3) R.F. POWER</u>	
i00014 HP 435A POWER METER	1733A05839
i00039 HP 436A POWER METER	2709A26776
i00020 HP 8901A POWER MODE	2105A01087
<u>(4) FREQUENCY COUNTER</u>	
i00042 HP 5383A	1628A00959
i00019 HP 5334B	2704A00347
i00020 HP 8901A	2105A01087

PAGE NO.

44 of 46.

NAME OF TEST: Frequency Stability (Temperature Variation)
g0070709: 2000-Jul-27 Thu 15:43:00
STATE: 0:General

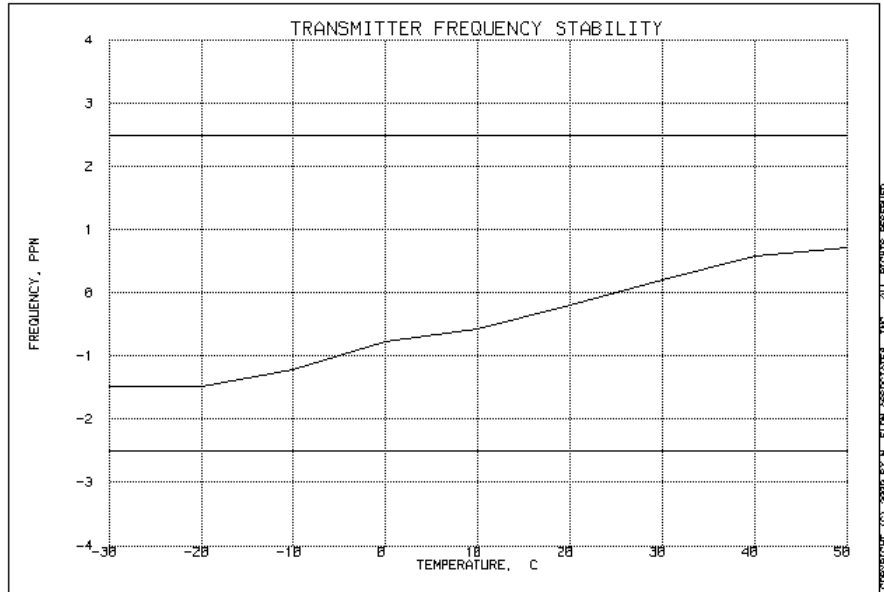

SUPERVISED BY:

Morton Flom, P. Eng.

PAGE NO. 45 of 46.
NAME OF TEST: Frequency Stability (Voltage Variation)
SPECIFICATION: 47 CFR 2.1055(b)(1)
GUIDE: ANSI/TIA/EIA-603-1992, Paragraph 2.2.2
TEST EQUIPMENT: As per previous page

MEASUREMENT PROCEDURE

1. The EUT was placed in a temperature chamber at 25±5°C and connected as for "Frequency Stability - Temperature Variation" test.
2. The power supply voltage to the EUT was varied from 85% to 115% of the nominal value measured at the input to the EUT.
3. The variation in frequency was measured for the worst case.

RESULTS: Frequency Stability (Voltage Variation)
g0070720: 2000-Jul-21 Fri 14:40:54
STATE: 0:General

LIMIT, ppm = 2.5
LIMIT, Hz = 388
BATTERY END POINT (Voltage) = 6

% of STV	Voltage	Frequency, MHz	Change, Hz	Change, ppm
85	6.37	155.050000	0	0.00
100	7.5	155.050000	0	0.00
115	8.62	155.050000	0	0.00
80	6	155.050000	0	0.00

SUPERVISED BY:

Morton Flom, P. Eng.

PAGE NO. 46 of 46.
NAME OF TEST: Necessary Bandwidth and Emission Bandwidth
SPECIFICATION: 47 CFR 2.202 (g)

MODULATION = 16K0F3E

NECESSARY BANDWIDTH CALCULATION:

MAXIMUM MODULATION (M), kHz = 3
 MAXIMUM DEVIATION (D), kHz = 5
 CONSTANT FACTOR (K) = 1
 NECESSARY BANDWIDTH (B_N), kHz = (2xM) + (2xDxK)
 = 16.0

MODULATION = 11K0F3E

NECESSARY BANDWIDTH CALCULATION:

MAXIMUM MODULATION (M), kHz = 3
 MAXIMUM DEVIATION (D), kHz = 2.5
 CONSTANT FACTOR (K) = 1
 NECESSARY BANDWIDTH (B_N), kHz = (2xM) + (2xDxK)
 = 11.0

SUPERVISED BY:

Morton Flom, P. Eng.

TESTIMONIAL
AND
STATEMENT OF CERTIFICATION

THIS IS TO CERTIFY THAT:

1. THAT the application was prepared either by, or under the direct supervision of, the undersigned.
2. THAT the technical data supplied with the application was taken under my direction and supervision.
3. THAT the data was obtained on representative units, randomly selected.
4. THAT, to the best of my knowledge and belief, the facts set forth in the application and accompanying technical data are true and correct.

CERTIFYING ENGINEER:



Morton Flom, P. Eng.