

ENGINEERING TEST REPORT

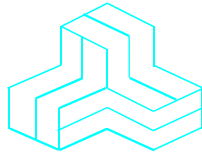

UHF-FM Hand Held Transceiver
Model No.: IC-F21-1 & IC-F21S-1
FCC ID: AFJIC-F21-1

Applicant: **Icom Incorporated**
1-1-32, Kamiminami
Hirano-ku, Osaka
Japan, 547-0003

Tested in Accordance With

Federal Communications Commission (FCC)
47 CFR, Parts 2 & 90
Licensed Non-Broadcast Radio Transceivers
Operating in the Frequency Band 400-430 MHz (12.5 kHz and 25 kHz Channel Spacings)

UltraTech's File No.: ICOM33-FTX

This Test report is Issued under the Authority of
Tri M. Luu, Professional Engineer,
Vice President of Engineering
UltraTech Group of Labs

Date: November 30, 2001



Report Prepared by: Tri Luu / Dan Huynh

Tested by: Hung Trinh, RFI/EMI Technician

Issued Date: November 30, 2001

Test Dates: Oct. 15-30, 2001

The results in this Test Report apply only to the sample(s) tested, and the sample tested is randomly selected.

UltraTech

3000 Bristol Circle, Oakville, Ontario, Canada, L6H 6G4
Telephone (905) 829-1570 Facsimile (905) 829-8050

Website: www.ultratech-labs.com Email: vhk.ultratech@sympatico.ca

TABLE OF CONTENTS

EXHIBIT 1. SUBMITTAL CHECK LIST.....	1
EXHIBIT 2. INTRODUCTION	2
2.1. SCOPE	2
2.2. RELATED SUBMITTAL(S)/GRANT(S)	2
2.3. NORMATIVE REFERENCES	2
EXHIBIT 3. PERFORMANCE ASSESSMENT	3
3.1. CLIENT INFORMATION	3
3.2. EQUIPMENT UNDER TEST (EUT) INFORMATION	3
3.3. EUT'S TECHNICAL SPECIFICATIONS	4
3.4. LIST OF EUT'S PORTS	4
EXHIBIT 4. EUT OPERATION CONDITIONS AND CONFIGURATIONS DURING TESTS	5
4.1. CLIMATE TEST CONDITIONS.....	5
4.2. OPERATIONAL TEST CONDITIONS & ARRANGEMENT FOR TEST SIGNALS	5
EXHIBIT 5. SUMMARY OF TEST RESULTS	6
5.1. LOCATION OF TESTS	6
5.2. APPLICABILITY & SUMMARY OF EMC EMISSION TEST RESULTS	6
5.3. MODIFICATIONS INCORPORATED IN THE EUT FOR COMPLIANCE PURPOSES	6
5.4. DEVIATION OF STANDARD TEST PROCEDURES	6
EXHIBIT 6. MEASUREMENTS, EXAMINATIONS & TEST DATA FOR EMC EMISSIONS.....	7
6.1. TEST PROCEDURES	7
6.2. MEASUREMENT UNCERTAINTIES	7
6.3. MEASUREMENT EQUIPMENT USED:.....	7
6.4. ESSENTIAL/PRIMARY FUNCTIONS AS DECLARED BY THE MANUFACTURER.....	7
6.5. RF POWER OUTPUT @ FCC 2.1046 & 90.205	8
6.5.1. <i>Limits @ FCC 90.205</i>	8
6.5.2. <i>Method of Measurements</i>	8
6.5.3. <i>Test Equipment List</i>	8
6.5.4. <i>Test Arrangement</i>	8
6.5.5. <i>Test Data</i>	9
6.6. RF EXPOSURE REQUIREMENTS @ 2.1093	11
6.7. FREQUENCY STABILITY @ FCC 2.1055 & 90.213	12
6.7.1. <i>Limits @ FCC 90.213</i>	12
6.7.2. <i>Method of Measurements</i>	12
6.7.3. <i>Test Equipment List</i>	12
6.7.4. <i>Test Arrangement</i>	12
6.7.5. <i>Test Data</i>	13
6.8. EMISSION MASK @ FCC 2.1049, 90.209 & 90.210	14
6.8.1. <i>Limits @ FCC 90.209 & 90.210</i>	14
6.8.2. <i>Method of Measurements</i>	14

ULTRATECH GROUP OF LABS

3000 Bristol Circle, Oakville, Ontario, Canada L6H 6G4
Tel. #: 905-829-1570, Fax. #: 905-829-8050, Email: vhk.ultratech@sympatico.ca, Website: <http://www.ultratech-labs.com>

File #: ICOM33-FTX
November 30, 2001

- Assessed by ITI (UK) Competent Body, NVLAP (USA) Accreditation Body & ACA/AUSTEL (Australia), VCCI (Japan)
- Accredited by Industry Canada (Canada) under ACC-LAB (Europe/Canada MRA and APEC/Canada MRA)
- Recognized/Listed by FCC (USA)
- All test results contained in this engineering test report are traceable to National Institute of Standards and Technology (NIST)

6.8.3.	Test Equipment List	14
6.8.4.	Test Arrangement	14
6.8.5.	Test Data.....	14
6.9.	AUDIO FREQUENCY RESPONSE @ FCC 2.1047(A) AND 90.242(B)(8).....	15
6.9.1.	Limits @ FCC 2.1047(a) and 90.242(b)(8).....	15
6.9.2.	Method of Measurements.....	15
6.9.3.	Test Equipment List	15
6.9.4.	Test Arrangement	15
6.9.5.	Test Data.....	16
6.10.	MODULATION LIMITING @ FCC 2.1047(B) & 90.210.....	22
6.10.1.	Limits @ FCC 2.1047(b) and 90.210	22
6.10.2.	Method of Measurements.....	22
6.10.3.	Test Equipment List	22
6.10.4.	Test Arrangement	22
6.10.5.	Test Data.....	23
6.11.	TRANSMITTER ANTENNA POWER SPURIOUS/HARMONIC CONDUCTED EMISSIONS @ FCC 90.210.....	27
6.11.1.	Limits @ 90.210.....	27
6.11.2.	Method of Measurements.....	27
6.11.3.	Test Equipment List	27
6.11.4.	Test Arrangement	27
6.11.5.	Test Data.....	28
6.12.	TRANSMITTER SPURIOUS/HARMONIC RADIATED EMISSIONS @ FCC 90.210.....	31
6.12.1.	Limits @ FCC 90.210.....	31
6.12.2.	Method of Measurements.....	31
6.12.3.	Test Equipment List	31
6.12.4.	Test Arrangement	32
6.12.5.	Test Data.....	33
6.13.	TRANSIENT FREQUENCY BEHAVIOR @ 90.214	37
6.13.1.	Limits	37
6.13.2.	Method of Measurements.....	37
6.13.3.	Test Equipment List	38
6.13.4.	Test Arrangement	38
6.13.5.	Test Data.....	39
EXHIBIT 7.	MEASUREMENT UNCERTAINTY.....	41
7.1.	RADIATED EMISSION MEASUREMENT UNCERTAINTY	41
EXHIBIT 8.	MEASUREMENT METHODS.....	42
8.1.	CONDUCTED POWER MEASUREMENTS.....	42
8.2.	RADIATED POWER MEASUREMENTS (ERP & EIRP) USING SUBSTITUTION METHOD.....	43
8.2.1.	Maximizing RF Emission Level (E-Field).....	43
8.2.2.	Measuring the EIRP of Spurious/Harmonic Emissions using Substitution Method.....	44
8.3.	FREQUENCY STABILITY	46
8.4.	EMISSION MASK	47
8.5.	SPURIOUS EMISSIONS (CONDUCTED).....	47
8.6.	TRANSIENT FREQUENCY BEHAVIOR	48

ULTRATECH GROUP OF LABS

3000 Bristol Circle, Oakville, Ontario, Canada L6H 6G4
Tel. #: 905-829-1570, Fax. #: 905-829-8050, Email: yhk.ultratech@sympatico.ca, Website: <http://www.ultratech-labs.com>

File #: ICOM33-FTX
November 30, 2001

- Assessed by ITI (UK) Competent Body, NVLAP (USA) Accreditation Body & ACA/AUSTEL (Australia), VCCI (Japan)
- Accredited by Industry Canada (Canada) under ACC-LAB (Europe/Canada MRA and APEC/Canada MRA)
- Recognized/Listed by FCC (USA)
- All test results contained in this engineering test report are traceable to National Institute of Standards and Technology (NIST)

EXHIBIT 1. SUBMITTAL CHECK LIST

Annex No.	Exhibit Type	Description of Contents	Quality Check (OK)
--	Test Report	<ul style="list-style-type: none"> Exhibit 1: Submittal check lists Exhibit 2: Introduction Exhibit 3: Performance Assessment Exhibit 4: EUT Operation and Configuration during Tests Exhibit 5: Summary of test Results Exhibit 6: Measurement Data Exhibit 7: Measurement Uncertainty Exhibit 8: Measurement Methods 	OK
1	Test Data Plots	<ul style="list-style-type: none"> Occupied Bandwidth, Plots # 1 to 6 Emission Mask D, Plots # 7 to 12 Spurious Emissions at Antenna Terminals, Plots # 13 to 24 Transient Frequency Behavior, Plots # 25 to 32 	OK
2	Test Setup Photos	Radiated Emissions Test Setup Photos	OK
3	External Photos of EUT	External EUT Photos	OK
4	Internal Photos of EUT	Internal EUT Photos	OK
5	Cover Letters	Letter from Ultratech for Certification Request	OK
6	Attestation Statements	<ul style="list-style-type: none"> Letter from the Applicant to appoint Ultratech to act as an agent Letter from the Applicant to request for Confidentiality Filing Confirmation to meet the FCC Rules, Parts 90.203(e) and (g) Blocked Frequency 	OK
7	ID Label/Location Info	ID Label Location of ID Label	OK
8	Block Diagram	IC-F21/S Block Diagram	OK
9	Schematic Diagrams	<ul style="list-style-type: none"> General Schematic Diagram Main Schematic Diagram SW-A SW-B 	OK
10	Parts List/Tune Up Info	<ul style="list-style-type: none"> Chassis Parts List Main Parts List SW-A Parts List SW-B Parts List 	OK
11	Operational Description	Explanation of the Operation for FX-2458 (IC-F21)	OK
12	RF Exposure Info	SAR Test Report	OK
13	Users Manual	Icom Instruction Manual	OK

Note: The Block Diagram, Schematics, Parts List, Operational Description and User Manual provided are for the IC-F21/S, which is same as the IC-F21-1 and IC-F21S-1.

ULTRATECH GROUP OF LABS

3000 Bristol Circle, Oakville, Ontario, Canada L6H 6G4
 Tel. #: 905-829-1570, Fax. #: 905-829-8050, Email: yhk.ultratech@sympatico.ca, Website: <http://www.ultratech-labs.com>

File #: ICOM33-FTX
 November 30, 2001

- Assessed by ITI (UK) Competent Body, NVLAP (USA) Accreditation Body & ACA/AUSTEL (Australia), VCCI (Japan)
- Accredited by Industry Canada (Canada) under ACC-LAB (Europe/Canada MRA and APEC/Canada MRA)
- Recognized/Listed by FCC (USA)
- All test results contained in this engineering test report are traceable to National Institute of Standards and Technology (NIST)

EXHIBIT 2. INTRODUCTION

2.1. SCOPE

Reference:	FCC Parts 2 and 90
Title:	Telecommunication – 47 Code of Federal Regulations (CFR), Parts 2 and 90
Purpose of Test:	To gain FCC Certification Authorization for Radio Operating in the Frequency Band 400-430 MHz (12.5 kHz and 25 kHz Channel Spacings).
Test Procedures:	Both conducted and radiated emissions measurements were conducted in accordance with American National Standards Institute ANSI C63.4 - American National Standard for Methods of Measurement of Radio-Noise Emissions from Low-Voltage Electrical and Electronic Equipment in the Range of 9 kHz to 40 GHz.

2.2. RELATED SUBMITTAL(S)/GRANT(S)

None

2.3. NORMATIVE REFERENCES

Publication	Year	Title
FCC CFR Parts 0-19 & 80-End	2000	Code of Federal Regulations – Telecommunication
ANSI C63.4	1992	American National Standard for Methods of Measurement of Radio-Noise Emissions from Low-Voltage Electrical and Electronic Equipment in the Range of 9 kHz to 40 GHz
CISPR 22 & EN 55022	1997 1998	Limits and Methods of Measurements of Radio Disturbance Characteristics of Information Technology Equipment
CISPR 16-1		Specification for Radio Disturbance and Immunity measuring apparatus and methods

ULTRATECH GROUP OF LABS

3000 Bristol Circle, Oakville, Ontario, Canada L6H 6G4
Tel. #: 905-829-1570, Fax. #: 905-829-8050, Email: yhk.ultratech@sympatico.ca, Website: <http://www.ultratech-labs.com>

File #: ICOM33-FTX
November 30, 2001

- Assessed by ITI (UK) Competent Body, NVLAP (USA) Accreditation Body & ACA/AUSTEL (Australia), VCCI (Japan)
- Accredited by Industry Canada (Canada) under ACC-LAB (Europe/Canada MRA and APEC/Canada MRA)
- Recognized/Listed by FCC (USA)
- All test results contained in this engineering test report are traceable to National Institute of Standards and Technology (NIST)

EXHIBIT 3. PERFORMANCE ASSESSMENT

3.1. CLIENT INFORMATION

APPLICANT	
Name:	Icom Incorporated
Address:	1-1-32, Kamiminami Hirano-ku, Oaska Japan, 547-0003
Contact Person:	Mr. Takashi Aoki Phone #: +81-66-793-5302 Fax #: +81-66-793-0013 Email Address: export@icom.co.jp

MANUFACTURER	
Name:	Icom Incorporated
Address:	1-1-32, Kamiminami Hirano-ku, Oaska Japan, 547-0003
Contact Person:	Mr. Takashi Aoki Phone #: +81-66-793-5302 Fax #: # +81-66-793-0013 Email Address: export@icom.co.jp

3.2. EQUIPMENT UNDER TEST (EUT) INFORMATION

The following information (with the exception of the Date of Receipt) has been supplied by the applicant.

Brand Name:	Icom Incorporated
Product Name:	UHF-FM Hand Held Transceiver
Model Name or Number:	IC-F21-1 and IC-F21S-1
Serial Number:	Test Sample
Type of Equipment:	Licensed Non-Broadcast Radio Communication Equipment
External Power Supply:	N/A
Transmitting/Receiving Antenna Type:	Non-Integral

ULTRATECH GROUP OF LABS

3000 Bristol Circle, Oakville, Ontario, Canada L6H 6G4
Tel. #: 905-829-1570, Fax. #: 905-829-8050, Email: yhk.ultratech@sympatico.ca, Website: <http://www.ultratech-labs.com>

File #: ICOM33-FTX
November 30, 2001

- Assessed by ITI (UK) Competent Body, NVLAP (USA) Accreditation Body & ACA/AUSTEL (Australia), VCCI (Japan)
- Accredited by Industry Canada (Canada) under ACC-LAB (Europe/Canada MRA and APEC/Canada MRA)
- Recognized/Listed by FCC (USA)
- All test results contained in this engineering test report are traceable to National Institute of Standards and Technology (NIST)

3.3. EUT'S TECHNICAL SPECIFICATIONS

TRANSMITTER	
Equipment Type:	<input checked="" type="checkbox"/> Portable <input type="checkbox"/> Mobile <input type="checkbox"/> Base Station (fixed use)
Intended Operating Environment:	<input checked="" type="checkbox"/> Commercial <input checked="" type="checkbox"/> Light Industry & Heavy Industry
Power Supply Requirement:	7.2 Vdc (Icom Ni-Cd battery pack)
RF Output Power Rating:	Conducted: 4 W Hi and 1 W Lo (switchable) ERP: 6.38 W Hi and 1.88 W Lo (switchable)
Operating Frequency Range:	400-430MHz
RF Output Impedance:	50 Ohms
Channel Spacing:	12.5 and 25 kHz
Frequency Tolerance	2.5ppm
Emission Designation*:	11K0F3E and 16K0F3E
Antenna Connector Type:	J connector

* For an average case of commercial telephony, the Necessary Bandwidth is calculated as follows:

For FM Voice Modulation:

Channel Spacing = 12.5 kHz, D = 2.5 kHz max., K = 1, M = 3 kHz

$$B_n = 2M + 2DK = 2(3) + 2(2.5)(1) = \mathbf{11 \text{ kHz}}$$

Emission Designation: 11K0F3E

Channel Spacing = 25 kHz, D = 5 kHz max., K = 1, M = 3 kHz

$$B_n = 2M + 2DK = 2(3) + 2(5)(1) = \mathbf{16 \text{ kHz}}$$

Emission Designation: 16K0F3E

3.4. LIST OF EUT'S PORTS

Port Number	EUT's Port Description	Number of Identical Ports	Connector Type	Cable Type (Shielded/Non-shielded)
1	Antenna Connector	1	J Connector	N/A
2	SP/MIC	1	Speaker /Microphone Jack	Shielded

NOTE:

Ports of the EUT which in normal operation were connected to ancillary equipment through interconnecting cables via a representative interconnecting cable to simulate the input/output characteristics. RF input/output was correctly terminated to the 50 Ohms RF Load.

ULTRATECH GROUP OF LABS

3000 Bristol Circle, Oakville, Ontario, Canada L6H 6G4
 Tel. #: 905-829-1570, Fax. #: 905-829-8050, Email: yhk.ultratech@sympatico.ca, Website: <http://www.ultratech-labs.com>

File #: ICOM33-FTX
 November 30, 2001

- Assessed by ITI (UK) Competent Body, NVLAP (USA) Accreditation Body & ACA/AUSTEL (Australia), VCCI (Japan)
- Accredited by Industry Canada (Canada) under ACC-LAB (Europe/Canada MRA and APEC/Canada MRA)
- Recognized/Listed by FCC (USA)
- All test results contained in this engineering test report are traceable to National Institute of Standards and Technology (NIST)

EXHIBIT 4. EUT OPERATION CONDITIONS AND CONFIGURATIONS DURING TESTS

4.1. CLIMATE TEST CONDITIONS

The climate conditions of the test environment are as follows:

Temperature:	21°C
Humidity:	51%
Pressure:	102 kPa
Power input source:	7.2 Vdc (Icom Ni-Cd battery pack)

4.2. OPERATIONAL TEST CONDITIONS & ARRANGEMENT FOR TEST SIGNALS

Operating Modes:	The transmitter was operated in a continuous transmission mode with the carrier modulated as specified in the Test Data.
Special Test Software:	None
Special Hardware Used:	None
Transmitter Test Antenna:	The EUT is tested with the transmitter antenna port terminated to a 50 Ohms RF Load.

Transmitter Test Signals	
Frequency Band(s):	Near lowest, near middle & near highest frequencies of each frequency band(s) that the transmitter covers:
▪ 400-430 MHz	• 400.05, 415.05 and 429.95 MHz
Transmitter Wanted Output Test Signals:	
▪ RF Power Output (measured maximum output power):	4.1 Watts (measured at antenna terminal)
▪ Normal Test Modulation:	FM modulation with 2.5 kHz sine wave signal.
▪ Modulating Signal Source:	External

ULTRATECH GROUP OF LABS

3000 Bristol Circle, Oakville, Ontario, Canada L6H 6G4
Tel. #: 905-829-1570, Fax. #: 905-829-8050, Email: yhk.ultratech@sympatico.ca, Website: <http://www.ultratech-labs.com>

File #: ICOM33-FTX
November 30, 2001

- Assessed by ITI (UK) Competent Body, NVLAP (USA) Accreditation Body & ACA/AUSTEL (Australia), VCCI (Japan)
- Accredited by Industry Canada (Canada) under ACC-LAB (Europe/Canada MRA and APEC/Canada MRA)
- Recognized/Listed by FCC (USA)
- All test results contained in this engineering test report are traceable to National Institute of Standards and Technology (NIST)

EXHIBIT 5. SUMMARY OF TEST RESULTS

5.1. LOCATION OF TESTS

All of the measurements described in this report were performed at Ultratech Group of Labs located in the city of Oakville, Province of Ontario, Canada.

Radiated Emissions were performed at the Ultratech's 3 Meter Open Field Test Site (OFTS) situated in the Town of Oakville, province of Ontario.

The above site have been calibrated in accordance with ANSI C63.4, and found to be in compliance with the requirements of Sec. 2.948 of the FCC Rules. The descriptions and site measurement data of the Oakville Open Field Test Site has been filed with FCC office (FCC File No.: 31040/SIT 1300B3) and Industry Canada office (Industry Canada File No.: IC2049). Last Date of Site Calibration: August 8, 2001.

5.2. APPLICABILITY & SUMMARY OF EMC EMISSION TEST RESULTS

FCC Paragraph	Test Requirements	Applicability (Yes/No)
90.205 & 2.1046	RF Power Output	Yes
1.1307, 1.1310, 2.1091 & 2.1093	RF Exposure Limit	Yes
90.213 & 2.1055	Frequency Stability	Yes
2.1047(a) & 90.242(b)(8)	Audio Frequency Response	Yes
90.210 & 2.1047(b)	Modulation Limiting	Yes
90.209 90.210 & 2.1049	Emission Limitation & Emission Mask	Yes
90.210, 2.1057 & 2.1051	Emission Limits - Spurious Emissions at Antenna Terminal	Yes
90.210, 2.1057 & 2.1053	Emission Limits - Field Strength of Spurious Emissions	Yes
90.214	Transient Frequency Behavior	Yes

5.3. MODIFICATIONS INCORPORATED IN THE EUT FOR COMPLIANCE PURPOSES

None

5.4. DEVIATION OF STANDARD TEST PROCEDURES

None

ULTRATECH GROUP OF LABS

3000 Bristol Circle, Oakville, Ontario, Canada L6H 6G4
Tel. #: 905-829-1570, Fax. #: 905-829-8050, Email: yhk.ultratech@sympatico.ca, Website: <http://www.ultratech-labs.com>

File #: ICOM33-FTX
November 30, 2001

- Assessed by ITI (UK) Competent Body, NVLAP (USA) Accreditation Body & ACA/AUSTEL (Australia), VCCI (Japan)
- Accredited by Industry Canada (Canada) under ACC-LAB (Europe/Canada MRA and APEC/Canada MRA)
- Recognized/Listed by FCC (USA)
- All test results contained in this engineering test report are traceable to National Institute of Standards and Technology (NIST)

EXHIBIT 6. MEASUREMENTS, EXAMINATIONS & TEST DATA FOR EMC EMISSIONS

6.1. TEST PROCEDURES

This section contains test results only, details of test methods and procedures can be found in Exhibit 8 of this report

6.2. MEASUREMENT UNCERTAINTIES

The measurement uncertainties stated were calculated in accordance with requirements of UKAS Document NIS 81 with a confidence level of 95%. Please refer to Exhibit 7 for Measurement Uncertainties.

6.3. MEASUREMENT EQUIPMENT USED:

The measurement equipment used complied with the requirements of the Standards referenced in the Methods & Procedures ANSI C63.4:1992 and CISPR 16-1.

6.4. ESSENTIAL/PRIMARY FUNCTIONS AS DECLARED BY THE MANUFACTURER

The essential function of the EUT is to correctly communicate data to and from radios over RF link.

ULTRATECH GROUP OF LABS

3000 Bristol Circle, Oakville, Ontario, Canada L6H 6G4
Tel. #: 905-829-1570, Fax. #: 905-829-8050, Email: yhk.ultratech@sympatico.ca, Website: <http://www.ultratech-labs.com>

File #: ICOM33-FTX
November 30, 2001

- Assessed by ITI (UK) Competent Body, NVLAP (USA) Accreditation Body & ACA/AUSTEL (Australia), VCCI (Japan)
- Accredited by Industry Canada (Canada) under ACC-LAB (Europe/Canada MRA and APEC/Canada MRA)
- Recognized/Listed by FCC (USA)
- All test results contained in this engineering test report are traceable to National Institute of Standards and Technology (NIST)

6.5. RF POWER OUTPUT @ FCC 2.1046 & 90.205

6.5.1. Limits @ FCC 90.205

Refer to 47 CFR § 90.205 for specification details.

6.5.2. Method of Measurements

Refer to sections 8.1 and 8.2 of this test report for measurement methods.

- The transmitter terminal was coupled to the power meter through a 20 dB attenuator
- Power of the transmitter channel near the lowest, middle and highest of each frequency block/band were measured using the power meter, and the reading was corrected by added the calibrated attenuator's attenuation value and cable loss.
- The RF Output was turned on with standard modulation applied.

6.5.3. Test Equipment List

Test Instruments	Manufacturer	Model No.	Serial No.	Frequency Range
Spectrum Analyzer/ EMI Receiver	Hewlett Packard	HP 8546A	...	9 kHz to 5.6 GHz with built-in 30 dB Gain Pre-selector, QP, Average & Peak Detectors.
Attenuator(s)	Bird	DC – 22 GHz
Spectrum Analyzer/ EMI Receiver	Advantest	R3271	15050203	100 Hz – 26.5 GHz
Attenuator(s)	Weinschel Corp	24-20-34	BJ2357	DC – 8.5 GHz
Dipole Antenna	EMCO	3121C	8907-440	30 MHz – 1 GHz
Dipole Antenna	EMCO	3121C	8907-434	30 MHz – 1 GHz
Power Meter	Hewlett Packard	436A	1725A02249	10 kHz – 50 GHz, sensor dependent
Power Sensor	Hewlett Packard	8481A	2702A68983	10 MHz – 18 GHz
Synthesize Sweeper	Hewlett Packard	83752B	3610A00457	0.01 – 20 GHz

6.5.4. Test Arrangement

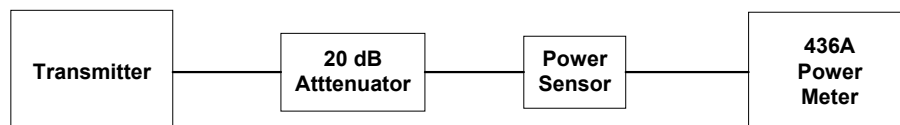

ULTRATECH GROUP OF LABS

3000 Bristol Circle, Oakville, Ontario, Canada L6H 6G4
 Tel. #: 905-829-1570, Fax. #: 905-829-8050, Email: yhk.ultratech@sympatico.ca, Website: <http://www.ultratech-labs.com>

File #: ICOM33-FTX
 November 30, 2001

- Assessed by ITI (UK) Competent Body, NVLAP (USA) Accreditation Body & ACA/AUSTEL (Australia), VCCI (Japan)
- Accredited by Industry Canada (Canada) under ACC-LAB (Europe/Canada MRA and APEC/Canada MRA)
- Recognized/Listed by FCC (USA)
- All test results contained in this engineering test report are traceable to National Institute of Standards and Technology (NIST)

6.5.5. Test Data

6.5.5.1. RF Power at RF Output Port

Transmitter Channel Output	Fundamental Frequency (MHz)	Measured Power (dBm)	Power Rating (dBm)
High Power, Narrow Band (12.5kHz channel spacing)			
Lowest	400.05	36.1	36.0
Middle	415.05	36.1	36.0
Highest	429.95	36.1	36.0
High Power, Wide Band (25kHz channel spacing)			
Lowest	400.05	36.1	36.0
Middle	415.05	36.1	36.0
Highest	429.95	36.1	36.0
Low Power, Narrow Band (12.5kHz channel spacing)			
Lowest	400.05	30.4	30.0
Middle	415.05	30.4	30.0
Highest	429.95	30.4	30.0
Low Power, Wide Band (25kHz channel spacing)			
Lowest	400.05	30.4	30.0
Middle	415.05	30.4	30.0
Highest	429.95	30.4	30.0

ULTRATECH GROUP OF LABS

3000 Bristol Circle, Oakville, Ontario, Canada L6H 6G4
 Tel. #: 905-829-1570, Fax. #: 905-829-8050, Email: vhk.ultratech@sympatico.ca, Website: <http://www.ultratech-labs.com>

File #: ICOM33-FTX
 November 30, 2001

- Assessed by ITI (UK) Competent Body, NVLAP (USA) Accreditation Body & ACA/AUSTEL (Australia), VCCI (Japan)
- Accredited by Industry Canada (Canada) under ACC-LAB (Europe/Canada MRA and APEC/Canada MRA)
- Recognized/Listed by FCC (USA)
- All test results contained in this engineering test report are traceable to National Institute of Standards and Technology (NIST)

6.5.5.2. ERP Using Substitution Method

High Power Narrow Band (12.5kHz channel spacing)						
Frequency (MHz)	Peak E-Field @ 3m (dBμV/m)	Antenna Polarization (V/H)	Peak Power From Signal GEN. Ps – Cable loss (dBm)	Substitution Dipole Antenna Gain Gd (dBi)	Measured Peak ERP = Ps+Gd-2.15 (dBm)	Measured Peak EIRP = ERP+2.15 (dBm)
400.05	137.46	V	37.0	1.15	36.00	38.15
400.05	138.59	H	37.9	1.15	36.90	39.05
415.05	137.66	V	38.0	0.88	36.73	38.88
415.05	136.88	H	36.1	0.88	34.83	36.98
429.95	137.92	V	39.5	0.70	38.05	40.20
429.95	134.88	H	35.1	0.70	33.65	35.80

The maximum measured ERP is 38.05 dBm (6.38 Watts) at "Hi" power setting, as indicated in the above table.

Low Power Narrow Band (12.5kHz channel spacing)						
Frequency (MHz)	Peak E-Field @ 3m (dBμV/m)	Antenna Polarization (V/H)	Peak Power From Signal GEN. Ps – Cable loss (dBm)	Substitution Dipole Antenna Gain Gd (dBi)	Measured Peak ERP = Ps+Gd-2.15 (dBm)	Measured Peak EIRP = ERP+2.15 (dBm)
400.05	131.34	V	30.9	1.15	29.90	32.05
400.05	131.64	H	31.0	1.15	30.00	32.15
415.05	131.74	V	32.0	0.88	30.73	32.88
415.05	130.79	H	30.0	0.88	28.73	30.88
429.95	132.39	V	34.2	0.70	32.75	34.90
429.95	129.72	H	29.9	0.70	28.45	30.60

The maximum measured ERP is 32.75 dBm (1.88 Watts) at "Lo" power setting, as indicated in the above table.

ULTRATECH GROUP OF LABS

3000 Bristol Circle, Oakville, Ontario, Canada L6H 6G4
 Tel. #: 905-829-1570, Fax. #: 905-829-8050, Email: yhk.ultratech@sympatico.ca, Website: <http://www.ultratech-labs.com>

File #: ICOM33-FTX
 November 30, 2001

- Assessed by ITI (UK) Competent Body, NVLAP (USA) Accreditation Body & ACA/AUSTEL (Australia), VCCI (Japan)
- Accredited by Industry Canada (Canada) under ACC-LAB (Europe/Canada MRA and APEC/Canada MRA)
- Recognized/Listed by FCC (USA)
- All test results contained in this engineering test report are traceable to National Institute of Standards and Technology (NIST)

6.6. RF EXPOSURE REQUIREMENTS @ 2.1093

Complies with Limits for Occupational/Controlled exposure, please refer to SAR test report for details.

ULTRATECH GROUP OF LABS

3000 Bristol Circle, Oakville, Ontario, Canada L6H 6G4
Tel. #: 905-829-1570, Fax. #: 905-829-8050, Email: yhk.ultratech@sympatico.ca, Website: <http://www.ultratech-labs.com>

File #: ICOM33-FTX
November 30, 2001

- Assessed by ITI (UK) Competent Body, NVLAP (USA) Accreditation Body & ACA/AUSTEL (Australia), VCCI (Japan)
- Accredited by Industry Canada (Canada) under ACC-LAB (Europe/Canada MRA and APEC/Canada MRA)
- Recognized/Listed by FCC (USA)
- All test results contained in this engineering test report are traceable to National Institute of Standards and Technology (NIST)

6.7. FREQUENCY STABILITY @ FCC 2.1055 & 90.213

6.7.1. Limits @ FCC 90.213

Refer to 47 CFR §90.213 for specification details.

Frequency Range (MHz)	Channel Spacing (kHz)	Frequency Stability (ppm)		
		Fixed and Base Stations	Mobile Stations	
			> 2 Watts	≤ 2 Watts
421 - 512	25	2.5	5.0	5.0
	12.5	1.5	2.5	2.5
	6.25	0.1	0.5	0.5

6.7.2. Method of Measurements

Refer to Exhibit 8, § 8.3 of this report for measurement details

6.7.3. Test Equipment List

Test Instruments	Manufacturer	Model No.	Serial No.	Frequency Range
EMI Receiver/ EMI Receiver	Hewlett Packard	HP 8593EM	3412A00103	9 kHz – 26.5 GHz
Attenuator(s)	Bird	DC – 22 GHz
Temperature & Humidity Chamber	Tenney	T5	9723B	-40° to +60° C range

6.7.4. Test Arrangement

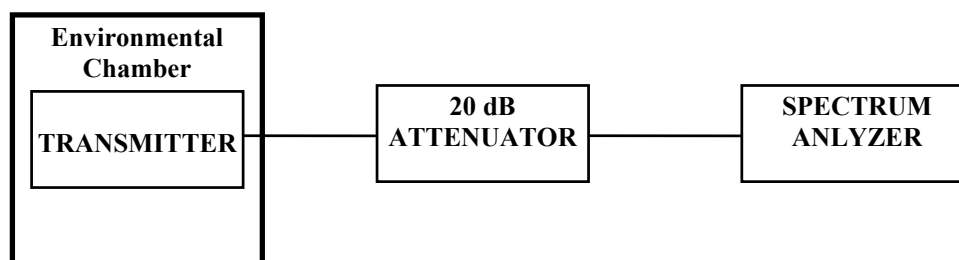

ULTRATECH GROUP OF LABS

3000 Bristol Circle, Oakville, Ontario, Canada L6H 6G4
 Tel. #: 905-829-1570, Fax. #: 905-829-8050, Email: yhk.ultratech@sympatico.ca, Website: <http://www.ultratech-labs.com>

File #: ICOM33-FTX
 November 30, 2001

- Assessed by ITI (UK) Competent Body, NVLAP (USA) Accreditation Body & ACA/AUSTEL (Australia), VCCI (Japan)
- Accredited by Industry Canada (Canada) under ACC-LAB (Europe/Canada MRA and APEC/Canada MRA)
- Recognized/Listed by FCC (USA)
- All test results contained in this engineering test report are traceable to National Institute of Standards and Technology (NIST)

6.7.5. Test Data

Product Name:	UHF-FM Hand Held Transceiver
Model No.:	IC-F21-1 AND IC-F21S-1
Center Frequency:	400.05 MHz
Full Power Level:	4.1 Watts
Frequency Tolerance Limit (Worst Case):	± 2.5 ppm or ± 1000.125 Hz at 400.05 MHz
Max. Frequency Tolerance Measured:	+714 Hz or 1.78 ppm
Input Voltage Rating:	7.2 Vdc

CENTER FREQUENCY & RF POWER OUTPUT VARIATION			
Ambient Temperature (°C)	Supply Voltage (Nominal) 7.2 Volts dc	Supply Voltage (85% of Nominal) 6.43 Volts dc	Supply Voltage (115% of Nominal) 8.3 Volts dc
	Hz	Hz	Hz
-30	+714	n/a	n/a
-20	+657	n/a	n/a
-10	+560	n/a	n/a
0	+310	n/a	n/a
+10	+130	n/a	n/a
+20	+94	+173	+14
+30	+71	n/a	n/a
+40	+78	n/a	n/a
+50	+235	n/a	n/a

ULTRATECH GROUP OF LABS

3000 Bristol Circle, Oakville, Ontario, Canada L6H 6G4
 Tel. #: 905-829-1570, Fax. #: 905-829-8050, Email: yhk.ultratech@sympatico.ca, Website: <http://www.ultratech-labs.com>

File #: ICOM33-FTX
 November 30, 2001

- Assessed by ITI (UK) Competent Body, NVLAP (USA) Accreditation Body & ACA/AUSTEL (Australia), VCCI (Japan)
- Accredited by Industry Canada (Canada) under ACC-LAB (Europe/Canada MRA and APEC/Canada MRA)
- Recognized/Listed by FCC (USA)
- All test results contained in this engineering test report are traceable to National Institute of Standards and Technology (NIST)

6.8. EMISSION MASK @ FCC 2.1049, 90.209 & 90.210

6.8.1. Limits @ FCC 90.209 & 90.210

Emissions shall be attenuated below the mean output power of the transmitter as follows:

Frequency Band (MHz)	Channel Spacing (kHz)	Authorized Bandwidth (kHz)	Recommended Frequency Deviation (KHz)	Applicable Emissions Mask	
				Mask for equipment with audio low pass filter	Mask for equipment without audio low pass filter
421 - 512	25	20	5	B	C
	12.5	11.25	2.5	D	D
	6.25	6	1.25	E	E

6.8.2. Method of Measurements

Refer to § 8.4 of this report for measurement details

6.8.3. Test Equipment List

Test Instruments	Manufacturer	Model No.	Serial No.	Frequency Range
Spectrum Analyzer/EMI Receiver	Hewlett Packard	HP 8593EM	3412A00103	9 kHz – 26.5 GHz
Attenuator(s)	Bird	DC – 22 GHz
Audio Oscillator	Hewlett Packard	HP 204C	0989A08798	DC to 1.2 MHz

6.8.4. Test Arrangement

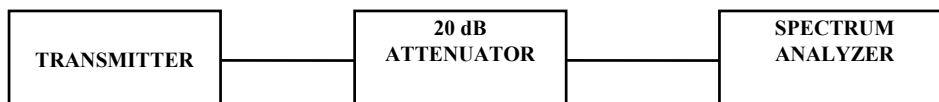

6.8.5. Test Data

Conform. Please refer to Annex 1, test data plots # 1 to 12 for details of measurements of the 99% Occupied Bandwidth and Emission Mask.

ULTRATECH GROUP OF LABS

3000 Bristol Circle, Oakville, Ontario, Canada L6H 6G4
 Tel. #: 905-829-1570, Fax. #: 905-829-8050, Email: yhk.ultratech@sympatico.ca, Website: <http://www.ultratech-labs.com>

File #: ICOM33-FTX
 November 30, 2001

- Assessed by ITI (UK) Competent Body, NVLAP (USA) Accreditation Body & ACA/AUSTEL (Australia), VCCI (Japan)
- Accredited by Industry Canada (Canada) under ACC-LAB (Europe/Canada MRA and APEC/Canada MRA)
- Recognized/Listed by FCC (USA)
- All test results contained in this engineering test report are traceable to National Institute of Standards and Technology (NIST)

6.9. AUDIO FREQUENCY RESPONSE @ FCC 2.1047(a) AND 90.242(B)(8)

6.9.1. Limits @ FCC 2.1047(a) and 90.242(b)(8)

No limit is required by FCC for audio frequency response. However, FCC recommends the Audio Frequency Response to be tested to show the roll-off curve at 3 kHz.

Recommended Limits: The attenuation of low pass filter between the frequencies of 3 kHz and 20 kHz shall be greater than the attenuation at 1kHz by at least: $60\text{Log}_{10}(f/3)$ decibels where "f" is the frequency in kHz. At frequency above 20 kHz, the attenuation shall be 50 dB greater than the attenuation at 1 kHz.

6.9.2. Method of Measurements

The rated audio input signal was applied to the input of the audio lowpass filter (or of all modulation stages) using an audio oscillator, this input signal level and its corresponding output signal were then measured and recorded using the FFT (Audio) EMI Receiver. Tests were repeated at different audio signal frequencies from 0 to 50 kHz.

6.9.3. Test Equipment List

Test Instruments	Manufacturer	Model No.	Serial No.	Frequency Range
FFT (audio) EMI Receiver	Advantest	R9211E	...	10 mHz – 100 kHz, 1 MHz Input Impedance
Audio Oscillator	Hewlett Packard	HP 204C	0989A08798	DC to 1.2 MHz

6.9.4. Test Arrangement

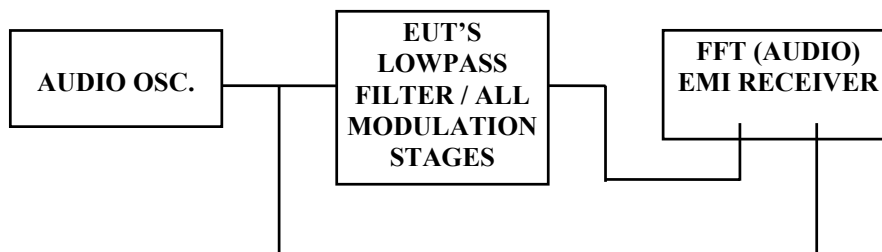

ULTRATECH GROUP OF LABS

3000 Bristol Circle, Oakville, Ontario, Canada L6H 6G4
 Tel. #: 905-829-1570, Fax. #: 905-829-8050, Email: yhk.ultratech@sympatico.ca, Website: <http://www.ultratech-labs.com>

File #: ICOM33-FTX
 November 30, 2001

- Assessed by ITI (UK) Competent Body, NVLAP (USA) Accreditation Body & ACA/AUSTEL (Australia), VCCI (Japan)
- Accredited by Industry Canada (Canada) under ACC-LAB (Europe/Canada MRA and APEC/Canada MRA)
- Recognized/Listed by FCC (USA)
- All test results contained in this engineering test report are traceable to National Institute of Standards and Technology (NIST)

6.9.5. Test Data

- 12.5 kHz Channel Spacing**

FREQUENCY (kHz)	AUDIO IN (dBV)	AUDIO OUT (dBV)	ATTEN. (OUT - IN) (dB)	ATTEN. wrt. 1 kHz (dB)	FCC LIMIT (dB)	PASS/ FAIL
0.10	-36.4	-62.4	-26.0	-49.1	0.0	PASS
0.20	-36.4	-57.5	-21.1	-44.2	0.0	PASS
0.30	-36.4	-33.9	2.5	-20.6	0.0	PASS
0.40	-36.4	-25.8	10.6	-12.5	0.0	PASS
0.50	-36.4	-22.2	14.2	-8.9	0.0	PASS
0.60	-36.4	-19.7	16.7	-6.4	0.0	PASS
0.70	-36.4	-18.0	18.4	-4.7	0.0	PASS
0.80	-36.4	-16.4	20.0	-3.1	0.0	PASS
0.90	-36.4	-14.0	22.4	-0.7	0.0	PASS
1.00	-36.4	-13.3	23.1	0.0	0.0	PASS
1.10	-36.4	-12.6	23.8	0.7	0.0	PASS
1.20	-36.4	-12.3	24.1	1.0	0.0	PASS
1.30	-36.4	-11.8	24.6	1.5	0.0	PASS
1.40	-36.4	-11.3	25.1	2.0	0.0	PASS
1.50	-36.4	-11.3	25.1	2.0	0.0	PASS
1.60	-36.4	-11.5	24.9	1.8	0.0	PASS
1.70	-36.4	-12.3	24.1	1.0	0.0	PASS
1.80	-36.4	-12.6	23.8	0.7	0.0	PASS
1.90	-36.4	-12.6	23.8	0.7	0.0	PASS
2.00	-36.4	-12.8	23.6	0.5	0.0	PASS
2.10	-36.4	-13.4	23.0	-0.1	0.0	PASS
2.20	-36.4	-14.3	22.1	-1.0	0.0	PASS
2.30	-36.4	-14.7	21.7	-1.4	0.0	PASS
2.40	-36.4	-14.8	21.6	-1.5	0.0	PASS
2.50	-36.4	-15.2	21.2	-1.9	0.0	PASS
2.60	-36.4	-15.8	20.6	-2.5	0.0	PASS
2.70	-36.4	-16.8	19.6	-3.5	0.0	PASS
2.80	-36.4	-17.5	18.9	-4.2	0.0	PASS
2.90	-36.4	-17.8	18.6	-4.5	0.0	PASS
3.00	-36.4	-18.5	17.9	-5.2	0.0	PASS
3.50	-36.4	-25.5	10.9	-12.2	-4.0	PASS
4.00	-36.4	-34.2	2.2	-20.9	-7.5	PASS
4.50	-36.4	-43.3	-6.9	-30.0	-10.6	PASS
5.00	-36.4	-50.7	-14.3	-37.4	-13.3	PASS
5.50	-36.4	-57.7	-21.3	-44.4	-15.8	PASS

Continued ...

ULTRATECH GROUP OF LABS

3000 Bristol Circle, Oakville, Ontario, Canada L6H 6G4
 Tel. #: 905-829-1570, Fax. #: 905-829-8050, Email: yhk.ultratech@sympatico.ca, Website: <http://www.ultratech-labs.com>

File #: ICOM33-FTX
 November 30, 2001

- Assessed by ITI (UK) Competent Body, NVLAP (USA) Accreditation Body & ACA/AUSTEL (Australia), VCCI (Japan)
- Accredited by Industry Canada (Canada) under ACC-LAB (Europe/Canada MRA and APEC/Canada MRA)
- Recognized/Listed by FCC (USA)
- All test results contained in this engineering test report are traceable to National Institute of Standards and Technology (NIST)

FREQUENCY (kHz)	AUDIO IN (dBV)	AUDIO OUT (dBV)	ATTEN. (OUT - IN) (dB)	ATTEN. wrt. 1 kHz (dB)	FCC LIMIT (dB)	PASS/ FAIL
6.00	-36.4	-63.7	-27.3	-50.4	-18.1	PASS
6.50	-36.4	-68.9	-32.5	-55.6	-20.1	PASS
7.00	-36.4	-73.1	-36.7	-59.8	-22.1	PASS
8.00	-36.4	-81.6	-45.2	-68.3	-25.6	PASS
9.00	-36.4	-88.5	-52.1	-75.2	-28.6	PASS
9.50	-36.4	-90.0	-53.6	-76.7	-30.0	PASS
10.00	-36.4	-93.0	-56.6	-79.7	-31.4	PASS
12.00	-36.4	-108.0	-71.6	-94.7	-36.1	PASS
14.00	-36.4	<-120.0	<<-83.6	<-106.7	-40.1	PASS
15.00	-36.4	<-120.0	<-83.6	<-106.7	-41.9	PASS
16.00	-36.4	<-120.0	<-83.6	<-106.7	-43.6	PASS
18.00	-36.4	<-120.0	<-83.6	<-106.7	-46.7	PASS
20.00	-36.4	<-120.0	<-83.6	<-106.7	-49.4	PASS
25.00	-36.4	<-120.0	<-83.6	<-106.7	-50.0	PASS
30.00	-36.4	<-120.0	<-83.6	<-106.7	-50.0	PASS
35.00	-36.4	<-120.0	<-83.6	<-106.7	-50.0	PASS
40.00	-36.4	<-120.0	<-83.6	<-106.7	-50.0	PASS
45.00	-36.4	<-120.0	<-83.6	<-106.7	-50.0	PASS
50.00	-36.4	<-120.0	<-83.6	<-106.7	-50.0	PASS

ULTRATECH GROUP OF LABS

3000 Bristol Circle, Oakville, Ontario, Canada L6H 6G4
 Tel. #: 905-829-1570, Fax. #: 905-829-8050, Email: yhk.ultratech@sympatico.ca, Website: <http://www.ultratech-labs.com>

File #: ICOM33-FTX
 November 30, 2001

- Assessed by ITI (UK) Competent Body, NVLAP (USA) Accreditation Body & ACA/AUSTEL (Australia), VCCI (Japan)
- Accredited by Industry Canada (Canada) under ACC-LAB (Europe/Canada MRA and APEC/Canada MRA)
- Recognized/Listed by FCC (USA)
- All test results contained in this engineering test report are traceable to National Institute of Standards and Technology (NIST)

AUDIO FREQUENCY RESPONSE
ICOM UHF-FM Hand Held Transceiver, Model IC-F21-1 (12.5 KHz Channel Spacing)
FCC ID: AFJIC-F21-1

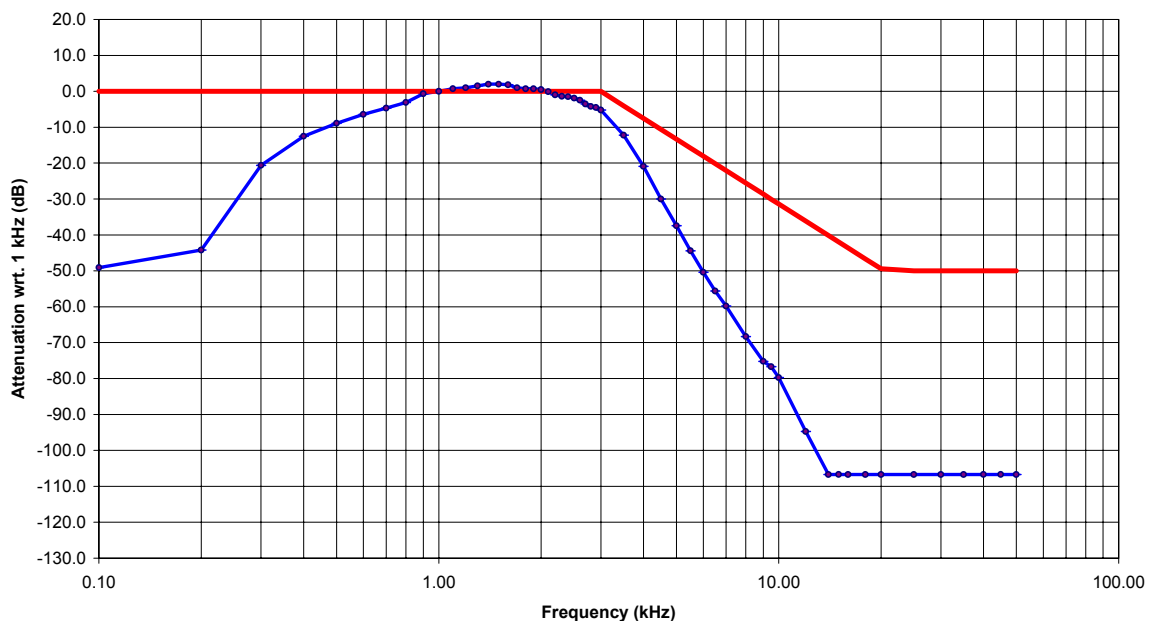

ULTRATECH GROUP OF LABS

3000 Bristol Circle, Oakville, Ontario, Canada L6H 6G4
Tel. #: 905-829-1570, Fax. #: 905-829-8050, Email: yhk.ultratech@sympatico.ca, Website: <http://www.ultratech-labs.com>

File #: ICOM33-FTX
November 30, 2001

- Assessed by ITI (UK) Competent Body, NVLAP (USA) Accreditation Body & ACA/AUSTEL (Australia), VCCI (Japan)
- Accredited by Industry Canada (Canada) under ACC-LAB (Europe/Canada MRA and APEC/Canada MRA)
- Recognized/Listed by FCC (USA)
- All test results contained in this engineering test report are traceable to National Institute of Standards and Technology (NIST)

• **25 kHz Channel Spacing**

FREQUENCY (kHz)	AUDIO IN (dBV)	AUDIO OUT (dBV)	ATTEN. (OUT - IN) (dB)	ATTEN. wrt. 1 kHz (dB)	FCC LIMIT (dB)	PASS/ FAIL
0.10	-36.3	-76.9	-40.6	-69.5	0	PASS
0.20	-36.3	-52.3	-16.0	-44.9	0.0	PASS
0.30	-36.3	-28.2	8.1	-20.8	0.0	PASS
0.40	-36.3	-20.2	16.1	-12.8	0.0	PASS
0.50	-36.3	-16.6	19.7	-9.2	0.0	PASS
0.60	-36.3	-14.0	22.3	-6.6	0.0	PASS
0.70	-36.3	-12.3	24.0	-4.9	0.0	PASS
0.80	-36.3	-10.5	25.8	-3.1	0.0	PASS
0.90	-36.3	-8.7	27.6	-1.3	0.0	PASS
1.00	-36.3	-7.4	28.9	0.0	0.0	PASS
1.10	-36.3	-6.7	29.6	0.7	0.0	PASS
1.20	-36.3	-6.3	30.0	1.1	0.0	PASS
1.30	-36.3	-5.8	30.5	1.6	0.0	PASS
1.40	-36.3	-5.3	31.0	2.1	0.0	PASS
1.50	-36.3	-5.2	31.1	2.2	0.0	PASS
1.60	-36.3	-5.5	30.8	1.9	0.0	PASS
1.70	-36.3	-6.2	30.1	1.2	0.0	PASS
1.80	-36.3	-6.5	29.8	0.9	0.0	PASS
1.90	-36.3	-6.5	29.8	0.9	0.0	PASS
2.00	-36.3	-6.7	29.6	0.7	0.0	PASS
2.10	-36.3	-7.3	29.0	0.1	0.0	PASS
2.20	-36.3	-8.2	28.1	-0.8	0.0	PASS
2.30	-36.3	-8.2	28.1	-0.8	0.0	PASS
2.40	-36.3	-8.7	27.6	-1.3	0.0	PASS
2.50	-36.3	-9.1	27.2	-1.7	0.0	PASS
2.60	-36.3	-9.7	26.6	-2.3	0.0	PASS
2.70	-36.3	-10.7	25.6	-3.3	0.0	PASS
2.80	-36.3	-11.3	25.0	-3.9	0.0	PASS
2.90	-36.3	-11.6	24.7	-4.2	0.0	PASS
3.00	-36.3	-12.5	23.8	-5.1	0.0	PASS
3.50	-36.3	-19.8	16.5	-12.4	-4.0	PASS
4.00	-36.3	-28.6	7.7	-21.2	-7.5	PASS
4.50	-36.3	-37.5	-1.2	-30.1	-10.6	PASS
5.00	-36.3	-44.9	-8.6	-37.5	-13.3	PASS
5.50	-36.3	-51.9	-15.6	-44.5	-15.8	PASS
6.00	-36.3	-58.0	-21.7	-50.6	-18.1	PASS
6.50	-36.3	-63.5	-27.2	-56.1	-20.1	PASS

Continued ...

ULTRATECH GROUP OF LABS

3000 Bristol Circle, Oakville, Ontario, Canada L6H 6G4
 Tel. #: 905-829-1570, Fax. #: 905-829-8050, Email: yhk.ultratech@sympatico.ca, Website: <http://www.ultratech-labs.com>

File #: ICOM33-FTX
 November 30, 2001

- Assessed by ITI (UK) Competent Body, NVLAP (USA) Accreditation Body & ACA/AUSTEL (Australia), VCCI (Japan)
- Accredited by Industry Canada (Canada) under ACC-LAB (Europe/Canada MRA and APEC/Canada MRA)
- Recognized/Listed by FCC (USA)
- All test results contained in this engineering test report are traceable to National Institute of Standards and Technology (NIST)

FREQUENCY (kHz)	AUDIO IN (dBV)	AUDIO OUT (dBV)	ATTEN. (OUT - IN) (dB)	ATTEN. wrt. 1 kHz (dB)	FCC LIMIT (dB)	PASS/ FAIL
7.00	-36.3	-68.9	-32.6	-61.5	-22.1	PASS
7.50	-36.3	-73.0	-36.7	-65.6	-23.9	PASS
8.00	-36.3	-80.5	-44.2	-73.1	-25.6	PASS
9.00	-36.3	-84.0	-47.7	-76.6	-28.6	PASS
9.50	-36.3	-86.4	-50.1	-79.0	-30.0	PASS
10.00	-36.3	-89.1	-52.8	-81.7	-31.4	PASS
12.00	-36.3	-101.7	-65.4	-94.3	-36.1	PASS
14.00	-36.3	-101.7	-65.4	-94.3	-40.1	PASS
15.00	-36.3	-109.7	-73.4	-102.3	-41.9	PASS
18.00	-36.3	-107.9	-71.6	-100.5	-46.7	PASS
20.00	-36.3	<-120.0	<-83.7	<-112.6	-49.4	PASS
25.00	-36.3	<-120.0	<-83.7	<-112.6	-50.0	PASS
30.00	-36.3	<-120.0	<-83.7	<-112.6	-50.0	PASS
35.00	-36.3	<-120.0	<-83.7	<-112.6	-50.0	PASS
40.00	-36.3	<-120.0	<-83.7	<-112.6	-50.0	PASS
45.00	-36.3	<-120.0	<-83.7	<-112.6	-50.0	PASS
50.00	-36.3	<-120.0	<-83.7	<-112.6	-50.0	PASS

ULTRATECH GROUP OF LABS

3000 Bristol Circle, Oakville, Ontario, Canada L6H 6G4
 Tel. #: 905-829-1570, Fax. #: 905-829-8050, Email: yhk.ultratech@sympatico.ca, Website: <http://www.ultratech-labs.com>

File #: ICOM33-FTX
 November 30, 2001

- Assessed by ITI (UK) Competent Body, NVLAP (USA) Accreditation Body & ACA/AUSTEL (Australia), VCCI (Japan)
- Accredited by Industry Canada (Canada) under ACC-LAB (Europe/Canada MRA and APEC/Canada MRA)
- Recognized/Listed by FCC (USA)
- All test results contained in this engineering test report are traceable to National Institute of Standards and Technology (NIST)

AUDIO FREQUENCY RESPONSE
ICOM UHF-FM Hand Held Transceiver, Model IC-F21-1 (25 KHz Channel Spacing)
FCC ID: AFJIC-F21-1

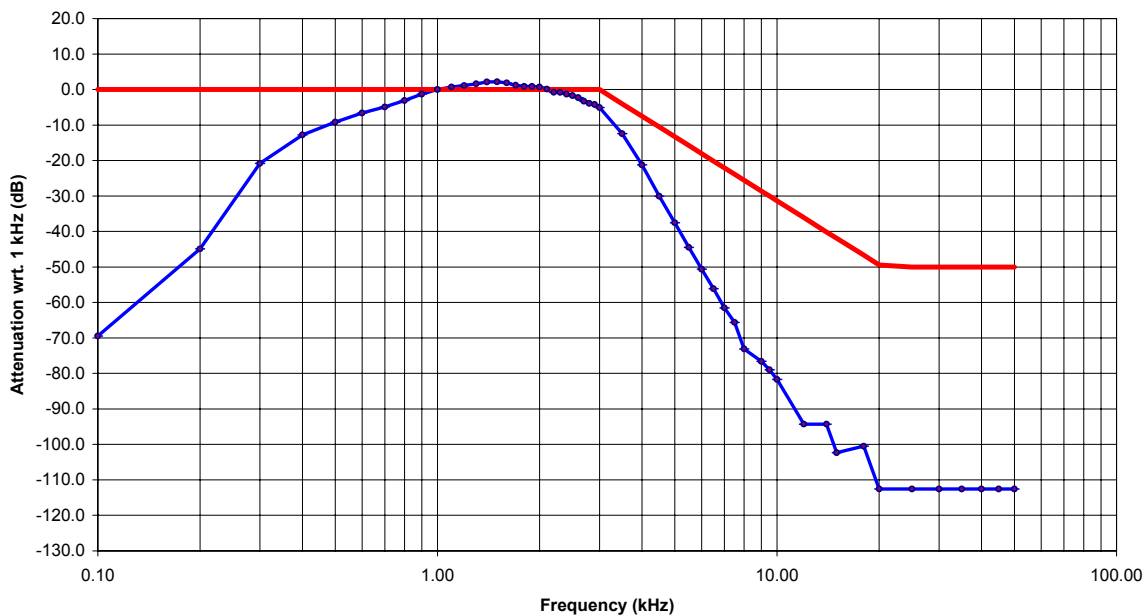

ULTRATECH GROUP OF LABS

3000 Bristol Circle, Oakville, Ontario, Canada L6H 6G4
Tel. #: 905-829-1570, Fax. #: 905-829-8050, Email: yhk.ultratech@sympatico.ca, Website: <http://www.ultratech-labs.com>

File #: ICOM33-FTX
November 30, 2001

- Assessed by ITI (UK) Competent Body, NVLAP (USA) Accreditation Body & ACA/AUSTEL (Australia), VCCI (Japan)
- Accredited by Industry Canada (Canada) under ACC-LAB (Europe/Canada MRA and APEC/Canada MRA)
- Recognized/Listed by FCC (USA)
- All test results contained in this engineering test report are traceable to National Institute of Standards and Technology (NIST)

6.10. MODULATION LIMITING @ FCC 2.1047(b) & 90.210

6.10.1. Limits @ FCC 2.1047(b) and 90.210

Recommended frequency deviation characteristics are given below:

- 2.5 kHz for 12.5 kHz Channel Spacing
- 5 kHz for 25 kHz Channel Spacing System

6.10.2. Method of Measurements

For Audio Transmitter: The carrier frequency deviation was measured with the tone input signal level varied from 0 Vp to audio input rating level plus 16 dB at frequencies 0.1, 0.5, 1.0, 3.0 and 5.0 kHz. The maximum deviation was recorded at each test condition.

For Data Transmitter with Maximum Frequency Deviation set by Factory:- The EUT was set at maximum frequency deviation, and its peak frequency deviation was then measured using EUT's internal random data source.

6.10.3. Test Equipment List

Test Instruments	Manufacturer	Model No.	Serial No.	Frequency Range
Communication Analyzer	Rohde & Schawrz	SMF02	879988/057	400 kHz - 1000 MHz including AF & RF Signal Generators, SINAD, DISTORTION, DEVIATION meters and etc

6.10.4. Test Arrangement

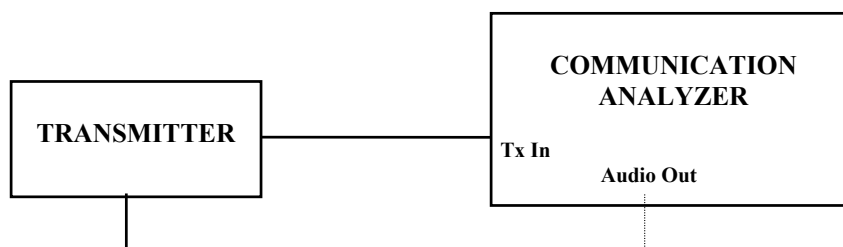

ULTRATECH GROUP OF LABS

3000 Bristol Circle, Oakville, Ontario, Canada L6H 6G4
 Tel. #: 905-829-1570, Fax. #: 905-829-8050, Email: yhk.ultratech@sympatico.ca, Website: <http://www.ultratech-labs.com>

File #: ICOM33-FTX
 November 30, 2001

- Assessed by ITI (UK) Competent Body, NVLAP (USA) Accreditation Body & ACA/AUSTEL (Australia), VCCI (Japan)
- Accredited by Industry Canada (Canada) under ACC-LAB (Europe/Canada MRA and APEC/Canada MRA)
- Recognized/Listed by FCC (USA)
- All test results contained in this engineering test report are traceable to National Institute of Standards and Technology (NIST)

6.10.5. Test Data

12.5 KHz Spacing Operation						
MODULATING SIGNAL LEVEL (mVrms)	PEAK FREQUENCY DEVIATION (kHz)					MAXIMUM LIMIT (kHz)
	at the following modulating frequency:					
	0.1 kHz	0.5 kHz	1.0 kHz	3.0 kHz	5.0 kHz	
10	1.3	1.4	1.4	1.4	1.5	2.5
20	1.4	1.5	1.5	1.3	1.6	2.5
30	1.4	1.6	1.6	1.2	1.7	2.5
40	1.4	1.6	1.7	1.2	0.5	2.5
50	1.4	1.7	1.7	1.2	0.5	2.5
60	1.4	1.8	1.8	1.2	0.5	2.5
80	1.4	1.9	1.9	1.2	0.5	2.5
100	1.4	2.0	2.0	1.2	0.5	2.5
120	1.4	2.2	2.1	1.2	0.5	2.5
140	1.4	2.3	2.1	1.2	0.5	2.5
160	1.4	2.4	2.3	1.2	0.5	2.5
180	1.5	2.4	2.4	1.2	0.5	2.5
200	1.5	2.4	2.4	1.2	0.5	2.5
250	1.5	2.4	2.4	1.2	0.5	2.5
300	1.6	2.4	2.4	1.2	0.5	2.5
350	1.6	2.4	2.4	1.2	0.5	2.5
400	1.6	2.4	2.4	1.2	0.5	2.5
450	1.6	2.4	2.4	1.2	0.5	2.5
500	1.6	2.4	2.4	1.2	0.5	2.5

ULTRATECH GROUP OF LABS

3000 Bristol Circle, Oakville, Ontario, Canada L6H 6G4
 Tel. #: 905-829-1570, Fax. #: 905-829-8050, Email: yhk.ultratech@sympatico.ca, Website: <http://www.ultratech-labs.com>

File #: ICOM33-FTX
 November 30, 2001

- Assessed by ITI (UK) Competent Body, NVLAP (USA) Accreditation Body & ACA/AUSTEL (Australia), VCCI (Japan)
- Accredited by Industry Canada (Canada) under ACC-LAB (Europe/Canada MRA and APEC/Canada MRA)
- Recognized/Listed by FCC (USA)
- All test results contained in this engineering test report are traceable to National Institute of Standards and Technology (NIST)

Voice Signal Input Level = STD MOD Level + 16 dB = 25.3 dBmVrms + 16 = **41.3 dBmVrms**

12.5 KHz Spacing Operation		
MODULATING FREQUENCY (KHz)	PEAK FREQUENCY DEVIATION (KHz)	MAXIMUM LIMIT (KHz)
0.1	1.4	2.5
0.2	1.7	2.5
0.4	2.2	2.5
0.6	2.2	2.5
0.8	2.2	2.5
1.0	2.1	2.5
1.2	2.2	2.5
1.4	2.2	2.5
1.6	2.3	2.5
1.8	2.2	2.5
2.0	2.0	2.5
2.5	1.6	2.5
3.0	1.2	2.5
3.5	0.8	2.5
4.0	0.6	2.5
4.5	0.5	2.5
5.0	0.4	2.5
6.0	0.4	2.5
7.0	0.4	2.5
8.0	0.4	2.5
9.0	0.4	2.5
10.0	0.4	2.5

ULTRATECH GROUP OF LABS

3000 Bristol Circle, Oakville, Ontario, Canada L6H 6G4
 Tel. #: 905-829-1570, Fax. #: 905-829-8050, Email: yhk.ultratech@sympatico.ca, Website: <http://www.ultratech-labs.com>

File #: ICOM33-FTX
 November 30, 2001

- Assessed by ITI (UK) Competent Body, NVLAP (USA) Accreditation Body & ACA/AUSTEL (Australia), VCCI (Japan)
- Accredited by Industry Canada (Canada) under ACC-LAB (Europe/Canada MRA and APEC/Canada MRA)
- Recognized/Listed by FCC (USA)
- All test results contained in this engineering test report are traceable to National Institute of Standards and Technology (NIST)

25 KHz Spacing Operation						
MODULATING SIGNAL LEVEL (mVrms)	PEAK FREQUENCY DEVIATION (kHz) at the following modulating frequency:					MAXIMUM LIMIT (kHz)
	0.1 kHz	0.5 kHz	1.0 kHz	3.0 kHz	5.0 kHz	
10	2.5	2.5	2.4	2.5	2.5	5.0
20	2.5	2.6	2.5	2.6	2.7	5.0
30	2.5	2.7	2.6	2.7	3.0	5.0
40	2.5	2.8	2.8	2.0	3.1	5.0
50	2.5	2.9	2.8	2.0	3.3	5.0
60	2.5	2.9	2.9	2.0	3.6	5.0
80	2.5	3.1	3.1	2.0	0.6	5.0
100	2.5	3.2	3.2	2.0	0.6	5.0
120	2.5	3.3	3.3	2.0	0.6	5.0
140	2.6	3.5	3.4	2.0	0.6	5.0
160	2.6	4.4	3.6	2.0	0.6	5.0
180	2.6	4.4	3.7	2.0	0.6	5.0
200	2.6	4.4	3.8	2.0	0.6	5.0
250	2.6	4.5	4.4	2.0	0.6	5.0
300	2.7	4.5	4.5	2.0	0.6	5.0
350	2.7	4.5	4.5	2.1	0.6	5.0
400	2.8	4.5	4.5	2.1	0.6	5.0
450	2.8	4.5	4.5	2.1	0.6	5.0
500	2.8	4.5	4.5	2.1	0.6	5.0

ULTRATECH GROUP OF LABS

3000 Bristol Circle, Oakville, Ontario, Canada L6H 6G4
 Tel. #: 905-829-1570, Fax. #: 905-829-8050, Email: yhk.ultratech@sympatico.ca, Website: <http://www.ultratech-labs.com>

File #: ICOM33-FTX
 November 30, 2001

- Assessed by ITI (UK) Competent Body, NVLAP (USA) Accreditation Body & ACA/AUSTEL (Australia), VCCI (Japan)
- Accredited by Industry Canada (Canada) under ACC-LAB (Europe/Canada MRA and APEC/Canada MRA)
- Recognized/Listed by FCC (USA)
- All test results contained in this engineering test report are traceable to National Institute of Standards and Technology (NIST)

Voice Signal Input Level = STD MOD Level + 16 dB = 37.6 dBmVrms + 16 = 53.6 dBmVrms

25 KHz Spacing Operation		
MODULATING FREQUENCY (KHz)	PEAK FREQUENCY DEVIATION (KHz)	MAXIMUM LIMIT (KHz)
0.1	2.8	5.0
0.2	4.9	5.0
0.4	4.5	5.0
0.6	4.4	5.0
0.8	4.4	5.0
1.0	4.4	5.0
1.2	4.4	5.0
1.4	4.4	5.0
1.6	4.3	5.0
1.8	4.1	5.0
2.0	3.8	5.0
2.5	2.8	5.0
3.0	2.0	5.0
3.5	1.4	5.0
4.0	1.0	5.0
4.5	0.7	5.0
5.0	0.7	5.0
6.0	0.5	5.0
7.0	0.4	5.0
8.0	0.4	5.0
9.0	0.3	5.0
10.0	0.4	5.0

ULTRATECH GROUP OF LABS

3000 Bristol Circle, Oakville, Ontario, Canada L6H 6G4
 Tel. #: 905-829-1570, Fax. #: 905-829-8050, Email: yhk.ultratech@sympatico.ca, Website: <http://www.ultratech-labs.com>

File #: ICOM33-FTX
 November 30, 2001

- Assessed by ITI (UK) Competent Body, NVLAP (USA) Accreditation Body & ACA/AUSTEL (Australia), VCCI (Japan)
- Accredited by Industry Canada (Canada) under ACC-LAB (Europe/Canada MRA and APEC/Canada MRA)
- Recognized/Listed by FCC (USA)
- All test results contained in this engineering test report are traceable to National Institute of Standards and Technology (NIST)

6.11. TRANSMITTER ANTENNA POWER SPURIOUS/HARMONIC CONDUCTED EMISSIONS @ FCC 90.210

6.11.1. Limits @ 90.210

Emissions shall be attenuated below the mean output power of the transmitter as follows:

FCC Rules	Frequency Range	Attenuation Limit (dBc)
90.210(b)&(c)	10 MHz to Lowest frequency of the radio to 10 th harmonic of the highest frequency of the radio	43+10*log(P)
90.210(d)	10 MHz to Lowest frequency of the radio to 10 th harmonic of the highest frequency of the radio	50+10*log(P) or 70 dBc whichever is less

6.11.2. Method of Measurements

Refer to Exhibit 8 § 8.5 of this report for measurement details

6.11.3. Test Equipment List

Test Instruments	Manufacturer	Model No.	Serial No.	Frequency Range
Spectrum Analyzer/ EMI Receiver	Hewlett Packard	HP 8593EM	3412A00103	9 kHz – 26.5 GHz
Attenuator(s)	Bird	DC – 22 GHz
Audio Oscillator	Hewlett Packard	HP 204C	0989A08798	DC to 1.2 MHz
Highpass Filter, Microphase	Microphase	CR220HID	IIT111000AC	Cut-off Frequency at 600 MHz, 1.3 GHz or 4 GHz

6.11.4. Test Arrangement

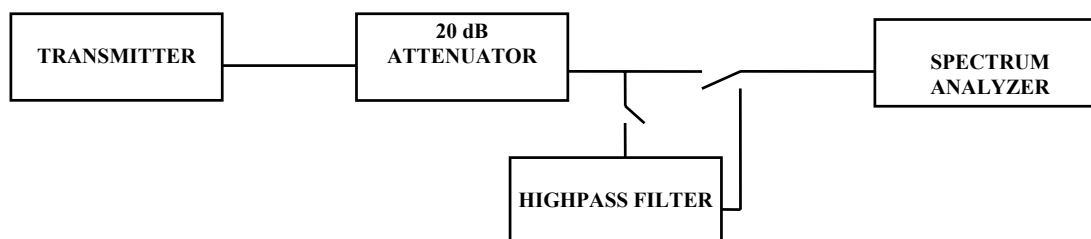

ULTRATECH GROUP OF LABS

3000 Bristol Circle, Oakville, Ontario, Canada L6H 6G4
 Tel. #: 905-829-1570, Fax. #: 905-829-8050, Email: yhk.ultratech@sympatico.ca, Website: <http://www.ultratech-labs.com>

File #: ICOM33-FTX
 November 30, 2001

- Assessed by ITI (UK) Competent Body, NVLAP (USA) Accreditation Body & ACA/AUSTEL (Australia), VCCI (Japan)
- Accredited by Industry Canada (Canada) under ACC-LAB (Europe/Canada MRA and APEC/Canada MRA)
- Recognized/Listed by FCC (USA)
- All test results contained in this engineering test report are traceable to National Institute of Standards and Technology (NIST)

6.11.5. Test Data

Remark:

- Test data plots for the following results can be found in Annex 1, plots # 13 to 24.
- The spurious/harmonic emissions from 25 kHz Channel Spacing operation was found to be the same as those of 12.5 kHz Channel Spacing operation. 12.5 KHz Channel Spacing was chosen to be tested for worst case since it's FCC Limits is lower { $50+10*\log(\text{Power in watts}) = 56.1 \text{ dBc}$ for 4.1 Watts output and 50.4 dBc for 1.1 Watts output}

▪ **Near Lowest Frequency (400.05 MHz)**

Fundamental
 Frequency: 400.05 MHz, Narrow Band (12.5kHz channel spacing)
 RF Output Power: 4.1 Watts
 Modulation: FM modulation with 2.5 kHz sine wave signal

FREQUENCY (MHz)	TRANSMITTER CONDUCTED ANTENNA EMISSIONS		LIMIT (dBc)	MARGIN (dB)	PASS/ FAIL
	(dBm)	(dBc)			
400.05	36.1	--	--	--	--
800.10	-49.9	-86.0	-56.1	-29.9	PASS
1200.15	-47.6	-83.7	-56.1	-27.6	PASS
1600.20	-56.9	-93.0	-56.1	-36.9	PASS

The emissions were scanned from 10 MHz to 5 GHz and all emissions within 40 dB below the limits were recorded. Refer to plots # 13 & 14

Fundamental
 Frequency: 400.05 MHz, Narrow Band (12.5kHz channel spacing)
 RF Output Power: 1.1 Watts
 Modulation: FM modulation with 2.5 kHz sine wave signal

FREQUENCY (MHz)	TRANSMITTER CONDUCTED ANTENNA EMISSIONS		LIMIT (dBc)	MARGIN (dB)	PASS/ FAIL
	(dBm)	(dBc)			
400.05	30.4	--	--	--	--
800.10	-44.2	-74.6	-50.4	-24.2	PASS
1200.15	-55.3	-85.7	-50.4	-35.3	PASS
1600.20	-59.4	-89.8	-50.4	-39.4	PASS

The emissions were scanned from 10 MHz to 5 GHz and all emissions within 40 dB below the limits were recorded. Refer to plots # 19 & 20

ULTRATECH GROUP OF LABS

3000 Bristol Circle, Oakville, Ontario, Canada L6H 6G4
 Tel. #: 905-829-1570, Fax. #: 905-829-8050, Email: yhk.ultratech@sympatico.ca, Website: <http://www.ultratech-labs.com>

File #: ICOM33-FTX
 November 30, 2001

- Assessed by ITI (UK) Competent Body, NVLAP (USA) Accreditation Body & ACA/AUSTEL (Australia), VCCI (Japan)
- Accredited by Industry Canada (Canada) under ACC-LAB (Europe/Canada MRA and APEC/Canada MRA)
- Recognized/Listed by FCC (USA)
- All test results contained in this engineering test report are traceable to National Institute of Standards and Technology (NIST)

▪ **Near Middle Frequency (415.05 MHz)**

Fundamental Frequency: 415.05 MHz, Narrow Band (12.5kHz channel spacing)
 RF Output Power: 4.1 Watts
 Modulation: FM modulation with 2.5 kHz sine wave signal

FREQUENCY (MHz)	TRANSMITTER CONDUCTED ANTENNA EMISSIONS		LIMIT (dBc)	MARGIN (dB)	PASS/FAIL
	(dBm)	(dBc)			
415.05	36.1	--	--	--	--
830.10	-56.3	-92.4	-56.1	-36.3	PASS
1245.15	-46.8	-82.9	-56.1	-26.8	PASS
1660.20	-59.7	-95.8	-56.1	-39.7	PASS
2075.25	-51.3	-87.4	-56.1	-31.3	PASS

The emissions were scanned from 10 MHz to 5 GHz and all emissions within 40 dB below the limits were recorded. Refer to plots # 15 & 16

Fundamental Frequency: 415.05 MHz, Narrow Band (12.5kHz channel spacing)
 RF Output Power: 1.1 Watt
 Modulation: FM modulation with 2.5 kHz sine wave signal

FREQUENCY (MHz)	TRANSMITTER CONDUCTED ANTENNA EMISSIONS		LIMIT (dBc)	MARGIN (dB)	PASS/FAIL
	(dBm)	(dBc)			
415.05	30.4	--	--	--	--
830.10	-54.8	-85.2	-50.4	-34.8	PASS
1245.15	-54.2	-84.6	-50.4	-34.2	PASS
1660.20	-57.8	-88.2	-50.4	-37.8	PASS

The emissions were scanned from 10 MHz to 5 GHz and all emissions within 40 dB below the limits were recorded. Refer to plots # 21 & 22

ULTRATECH GROUP OF LABS

3000 Bristol Circle, Oakville, Ontario, Canada L6H 6G4
 Tel. #: 905-829-1570, Fax. #: 905-829-8050, Email: yhk.ultratech@sympatico.ca, Website: <http://www.ultratech-labs.com>

File #: ICOM33-FTX
 November 30, 2001

- Assessed by ITI (UK) Competent Body, NVLAP (USA) Accreditation Body & ACA/AUSTEL (Australia), VCCI (Japan)
- Accredited by Industry Canada (Canada) under ACC-LAB (Europe/Canada MRA and APEC/Canada MRA)
- Recognized/Listed by FCC (USA)
- All test results contained in this engineering test report are traceable to National Institute of Standards and Technology (NIST)

▪ **Near Highest Frequency (429.95 MHz)**

Fundamental Frequency: 429.95 MHz, Narrow Band (12.5kHz channel spacing)
 RF Output Power: 4.1 Watts
 Modulation: FM modulation with 2.5 kHz sine wave signal

FREQUENCY (MHz)	TRANSMITTER CONDUCTED ANTENNA EMISSIONS		LIMIT (dBc)	MARGIN (dB)	PASS/FAIL
	(dBm)	(dBc)			
429.95	36.1	--	--	--	--
859.90	-57.3	-93.4	-56.1	-37.3	PASS
1289.85	-45.1	-81.2	-56.1	-25.1	PASS
1719.80	-59.6	-95.7	-56.1	-39.6	PASS
2149.75	-53.9	-90.0	-56.1	-33.9	PASS

The emissions were scanned from 10 MHz to 5 GHz and all emissions within 40 dB below the limits were recorded. Refer to plots # 17 & 18 details

Fundamental Frequency: 429.95 MHz, Narrow Band (12.5kHz channel spacing)
 RF Output Power: 1.1 Watts
 Modulation: FM modulation with 2.5 kHz sine wave signal

FREQUENCY (MHz)	TRANSMITTER CONDUCTED ANTENNA EMISSIONS		LIMIT (dBc)	MARGIN (dB)	PASS/FAIL
	(dBm)	(dBc)			
429.95	30.4	--	--	--	--
859.90	-56.5	-86.9	-50.4	-36.5	PASS
1289.85	-57.2	-87.6	-50.4	-37.2	PASS
1719.80	-59.1	-89.5	-50.4	-39.1	PASS

The emissions were scanned from 10 MHz to 5 GHz and all emissions within 40 dB below the limits were recorded. Refer to plots # 23 & 24 for details.

ULTRATECH GROUP OF LABS

3000 Bristol Circle, Oakville, Ontario, Canada L6H 6G4
 Tel. #: 905-829-1570, Fax. #: 905-829-8050, Email: yhk.ultratech@sympatico.ca, Website: <http://www.ultratech-labs.com>

File #: ICOM33-FTX
 November 30, 2001

- Assessed by ITI (UK) Competent Body, NVLAP (USA) Accreditation Body & ACA/AUSTEL (Australia), VCCI (Japan)
- Accredited by Industry Canada (Canada) under ACC-LAB (Europe/Canada MRA and APEC/Canada MRA)
- Recognized/Listed by FCC (USA)
- All test results contained in this engineering test report are traceable to National Institute of Standards and Technology (NIST)

6.12. TRANSMITTER SPURIOUS/HARMONIC RADIATED EMISSIONS @ FCC 90.210

6.12.1. Limits @ FCC 90.210

Emissions shall be attenuated below the mean output power of the transmitter as follows:

FCC Rules	Frequency Range	Attenuation Limit (dBc)
90.210(b)&(c)	10 MHz to Lowest frequency of the radio to 10 th harmonic of the highest frequency of the radio	43+10*log(P)
90.210(d)	10 MHz to Lowest frequency of the radio to 10 th harmonic of the highest frequency of the radio	50+10*log(P) or 70 dBc whichever is less

6.12.2. Method of Measurements

Refer to Exhibit 8, § 8.2 of this report for measurement details

6.12.3. Test Equipment List

Test Instruments	Manufacturer	Model No.	Serial No.	Frequency Range
Spectrum Analyzer/ EMI Receiver	Advantest	R3271	15050203	100 Hz to 32 GHz with external mixer for frequency above 32 GHz
Microwave Amplifier	Hewlett Packard	HP 83017A	3116A00661	1 GHz to 26.5 GHz
Active Loop Antenna	EMCO	6507	8906-1167	1 kHz – 30 MHz
Biconilog Antenna	EMCO	3143	1029	20 MHz to 2 GHz
Horn Antenna	EMCO	3155	9701-5061	1 GHz – 18 GHz
Horn Antenna with Mixer	EMCO	3160-09	1007	18 GHz – 26.5 GHz
Horn Antenna with Mixer	EMCO	3160-10	1001	26.5 GHz – 40 GHz

ULTRATECH GROUP OF LABS

3000 Bristol Circle, Oakville, Ontario, Canada L6H 6G4
 Tel. #: 905-829-1570, Fax. #: 905-829-8050, Email: yhk.ultratech@sympatico.ca, Website: <http://www.ultratech-labs.com>

File #: ICOM33-FTX
 November 30, 2001

- Assessed by ITI (UK) Competent Body, NVLAP (USA) Accreditation Body & ACA/AUSTEL (Australia), VCCI (Japan)
- Accredited by Industry Canada (Canada) under ACC-LAB (Europe/Canada MRA and APEC/Canada MRA)
- Recognized/Listed by FCC (USA)
- All test results contained in this engineering test report are traceable to National Institute of Standards and Technology (NIST)

6.12.4. Test Arrangement

The following drawings show details of the test setup for radiated emissions measurements

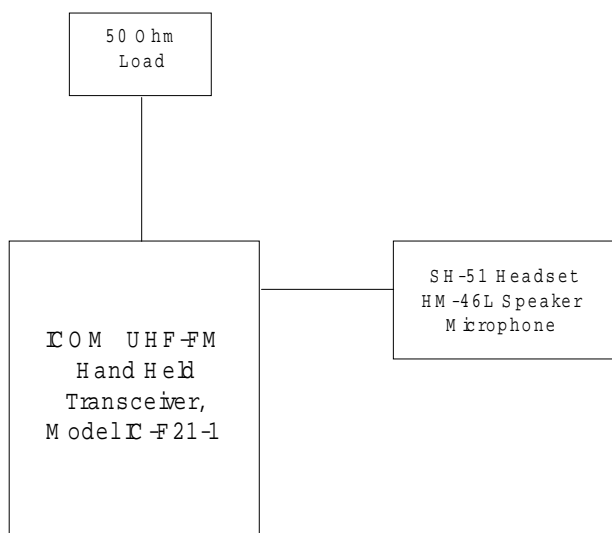

ULTRATECH GROUP OF LABS

3000 Bristol Circle, Oakville, Ontario, Canada L6H 6G4
Tel. #: 905-829-1570, Fax. #: 905-829-8050, Email: yhk.ultratech@sympatico.ca, Website: <http://www.ultratech-labs.com>

File #: ICOM33-FTX
November 30, 2001

- Assessed by ITI (UK) Competent Body, NVLAP (USA) Accreditation Body & ACA/AUSTEL (Australia), VCCI (Japan)
- Accredited by Industry Canada (Canada) under ACC-LAB (Europe/Canada MRA and APEC/Canada MRA)
- Recognized/Listed by FCC (USA)
- All test results contained in this engineering test report are traceable to National Institute of Standards and Technology (NIST)

6.12.5. Test Data

Remark:

- (1) The spurious/harmonic emissions from 25 kHz Channel Spacing operation was found to be the same as those of 12.5 kHz Channel Spacing operation. Therefore, 12.5 KHz Channel Spacing was chosen to be tested for worst case since it's limit is more stringent.
- (2) The emissions were scanned from 10 MHz to 5 GHz and all emissions within 20 dB below the limits were recorded.
- (3) All data reported are the worst case obtained with the EUT oriented in 3 different orthogonal positions. Please refer to the photographs of the test setup for details.

6.12.5.1. Lowest Frequency (400.05 MHz) - Hi Power

Fundamental Frequency: 400.05 MHz
 RF Output Power: 4.1 Watts Hi - conducted power
 Modulation: FM modulation with 2.5 kHz sine wave signal

Frequency (MHz)	E-Field Level @3m (dBμV/m)	ERP Measured by Substitution Method		EMI Receiver Detector (Peak/QP)	Antenna Plane (H/V)	Limit (dBc)	Margin (dB)	Pass / Fail
		(dBm)	(dBc)					
400.05	137.5	36.0	--	Peak	V	--	--	Pass
400.05	138.6	36.9	--	Peak	H	--	--	Pass
800.10	66.3	-30.8	-67.7	Peak	V	-56.9	-10.8	Pass
800.10	68.0	-32.3	-69.2	Peak	H	-56.9	-12.3	Pass
1200.15	65.5	-37.0	-73.9	Peak	V	-56.9	-17.0	Pass
1200.15	63.5	-35.6	-72.5	Peak	H	-56.9	-15.6	Pass
3200.40	62.0	-40.0	-76.9	Peak	V	-56.9	-20.0	Pass
3200.40	64.0	-39.1	-76.0	Peak	H	-56.9	-19.1	Pass
4000.50	63.8	-38.1	-75.0	Peak	V	-56.9	-18.1	Pass
4000.50	66.8	-36.4	-73.3	Peak	V	-56.9	-16.4	Pass

ULTRATECH GROUP OF LABS

3000 Bristol Circle, Oakville, Ontario, Canada L6H 6G4
 Tel. #: 905-829-1570, Fax. #: 905-829-8050, Email: vhk.ultratech@sympatico.ca, Website: <http://www.ultratech-labs.com>

File #: ICOM33-FTX
 November 30, 2001

- Assessed by ITI (UK) Competent Body, NVLAP (USA) Accreditation Body & ACA/AUSTEL (Australia), VCCI (Japan)
- Accredited by Industry Canada (Canada) under ACC-LAB (Europe/Canada MRA and APEC/Canada MRA)
- Recognized/Listed by FCC (USA)
- All test results contained in this engineering test report are traceable to National Institute of Standards and Technology (NIST)

6.12.5.2. Lowest Frequency (400.05 MHz) - Lo Power

Fundamental Frequency: 400.05 MHz
 RF Output Power: 1.1 Watts Lo - conducted power
 Modulation: FM modulation with 2.5 kHz sine wave signal

Frequency (MHz)	E-Field Level @3m (dBμV/m)	ERP Measured by Substitution Method		EMI Receiver Detector (Peak/QP)	Antenna Plane (H/V)	Limit (dBc)	Margin (dB)	Pass / Fail
		(dBm)	(dBc)					
400.05	131.3	29.9	--	Peak	V	--	--	--
400.05	131.6	30.0	--	Peak	H	--	--	--
800.10	75.6	-24.4	-54.4	Peak	V	-50.0	-4.4	Pass
800.10	74.0	-30.5	-60.5	Peak	H	-50.0	-10.5	Pass
1200.15	64.1	-37.7	-67.7	Peak	V	-50.0	-17.7	Pass
3200.40	62.0	-38.9	-68.9	Peak	V	-50.0	-18.9	Pass
3200.40	64.6	-36.7	-66.7	Peak	H	-50.0	-16.7	Pass
4000.50	61.9	-40.0	-70.0	Peak	V	-50.0	-20.0	Pass

6.12.5.3. Middle Frequency (415.05 MHz) - Hi Power

Fundamental Frequency: 415.05 MHz (12.5 KHz Channel Spacing)
 RF Output Power: 4.1 Watts (Hi) - conducted power
 Modulation: FM modulation with 2.5 kHz sine wave signal

Frequency (MHz)	E-Field Level @3m (dBμV/m)	ERP Measured by Substitution Method		EMI Receiver Detector (Peak/QP)	Antenna Plane (H/V)	Limit (dBc)	Margin (dB)	Pass / Fail
		(dBm)	(dBc)					
415.05	137.7	36.7	--	Peak	V	--	--	--
415.05	136.9	34.8	--	Peak	H	--	--	--
830.10	65.4	-34.9	-71.6	Peak	V	-56.7	-14.9	Pass
830.10	67.0	-33.7	-70.4	Peak	H	-56.7	-13.7	Pass

ULTRATECH GROUP OF LABS

3000 Bristol Circle, Oakville, Ontario, Canada L6H 6G4
 Tel. #: 905-829-1570, Fax. #: 905-829-8050, Email: vhk.ultratech@sympatico.ca, Website: <http://www.ultratech-labs.com>

File #: ICOM33-FTX
 November 30, 2001

- Assessed by ITI (UK) Competent Body, NVLAP (USA) Accreditation Body & ACA/AUSTEL (Australia), VCCI (Japan)
- Accredited by Industry Canada (Canada) under ACC-LAB (Europe/Canada MRA and APEC/Canada MRA)
- Recognized/Listed by FCC (USA)
- All test results contained in this engineering test report are traceable to National Institute of Standards and Technology (NIST)

6.12.5.4. Middle Frequency (415.05 MHz) - Lo Power

Fundamental Frequency: 415.05 MHz (12.5 KHz Channel Spacing)
 RF Output Power: 1.1 Watts Lo - Conducted Power
 Modulation: FM modulation with 2.5 kHz sine wave signal

Frequency (MHz)	E-Field Level @3m (dBμV/m)	ERP Measured by Substitution Method		EMI Receiver Detector (Peak/QP)	Antenna Plane (H/V)	Limit (dBc)	Margin (dB)	Pass / Fail
		(dBm)	(dBc)					
415.05	131.7	29.9	--	Peak	V	--	--	--
415.05	131.6	30.0	--	Peak	H	--	--	--
830.10	76.3	-34.9	-64.9	Peak	V	-50.0	-14.9	Pass
830.10	76.2	-33.7	-63.7	Peak	H	-50.0	-13.7	Pass

6.12.5.5. Highest Frequency (429.95 MHz) - Hi Power

Fundamental Frequency: 429.95 MHz
 RF Output Power: 4.1 Watts Hi - Conducted Power
 Modulation: FM modulation with 2.5 kHz sine wave signal

Frequency (MHz)	E-Field Level @3m (dBμV/m)	ERP Measured by Substitution Method		EMI Receiver Detector (Peak/QP)	Antenna Plane (H/V)	Limit (dBc)	Margin (dB)	Pass / Fail
		(dBm)	(dBc)					
429.95	137.9	38.1	--	Peak	V	--	--	--
429.95	134.9	33.7	--	Peak	H	--	--	--
859.90	64.0	-34.0	-72.1	Peak	V	-58.1	-14.0	Pass
859.90	63.8	-35.9	-74.0	Peak	H	-58.1	-15.9	Pass
1289.85	62.3	-38.0	-76.1	Peak	V	-58.1	-18.0	Pass
1289.85	64.7	-38.0	-76.1	Peak	H	-58.1	-18.0	Pass
2149.75	63.6	-38.0	-76.1	Peak	V	-58.1	-18.0	Pass
2149.75	64.6	-37.7	-75.8	Peak	V	-58.1	-17.7	Pass
2579.70	63.9	-39.5	-77.6	Peak	V	-58.1	-19.5	Pass
3439.60	64.1	-37.4	-75.5	Peak	V	-58.1	-17.4	Pass
3439.60	68.0	-35.6	-73.7	Peak	V	-58.1	-15.6	Pass

ULTRATECH GROUP OF LABS

3000 Bristol Circle, Oakville, Ontario, Canada L6H 6G4
 Tel. #: 905-829-1570, Fax. #: 905-829-8050, Email: yhk.ultratech@sympatico.ca, Website: <http://www.ultratech-labs.com>

File #: ICOM33-FTX
 November 30, 2001

- Assessed by ITI (UK) Competent Body, NVLAP (USA) Accreditation Body & ACA/AUSTEL (Australia), VCCI (Japan)
- Accredited by Industry Canada (Canada) under ACC-LAB (Europe/Canada MRA and APEC/Canada MRA)
- Recognized/Listed by FCC (USA)
- All test results contained in this engineering test report are traceable to National Institute of Standards and Technology (NIST)

6.12.5.6. Highest Frequency (429.95 MHz) - Lo Power

Fundamental Frequency: 429.95 MHz
 RF Output Power: 1.1 Watts Lo - Conducted Power
 Modulation: FM modulation with 2.5 kHz sine wave signal

Frequency (MHz)	E-Field Level @3m (dBμV/m)	ERP Measured by Substitution Method		EMI Receiver Detector (Peak/QP)	Antenna Plane (H/V)	Limit (dBc)	Margin (dB)	Pass / Fail
		(dBm)	(dBc)					
429.95	132.4	32.8	--	Peak	V	--	--	--
429.95	129.7	28.5	--	Peak	H	--	--	--
859.90	71.6	-29.5	-62.3	Peak	V	-52.8	-9.5	Pass
859.90	74.7	-29.8	-62.6	Peak	H	-52.8	-9.8	Pass
1289.85	62.4	-36.9	-69.7	Peak	V	-52.8	-16.9	Pass
1289.85	60.9	-39.6	-72.4	Peak	H	-52.8	-19.6	Pass
2579.70	63.7	-37.8	-70.6	Peak	V	-52.8	-17.8	Pass
3439.60	62.1	-39.5	-72.3	Peak	V	-52.8	-19.5	Pass

ULTRATECH GROUP OF LABS

3000 Bristol Circle, Oakville, Ontario, Canada L6H 6G4
 Tel. #: 905-829-1570, Fax. #: 905-829-8050, Email: yhk.ultratech@sympatico.ca, Website: <http://www.ultratech-labs.com>

File #: ICOM33-FTX
 November 30, 2001

- Assessed by ITI (UK) Competent Body, NVLAP (USA) Accreditation Body & ACA/AUSTEL (Australia), VCCI (Japan)
- Accredited by Industry Canada (Canada) under ACC-LAB (Europe/Canada MRA and APEC/Canada MRA)
- Recognized/Listed by FCC (USA)
- All test results contained in this engineering test report are traceable to National Institute of Standards and Technology (NIST)

6.13. TRANSIENT FREQUENCY BEHAVIOR @ 90.214

6.13.1. Limits

Transient frequencies must be within the maximum frequency difference limits during the time intervals indicated:

Time intervals ^{1, 2}	Maximum frequency difference ³	All equipment	
		150 to 174 MHz	421 to 512 MHz
Transient Frequency Behavior for Equipment Designed to Operate on 25 kHz Channels			
t_1 ⁴	± 25.0 kHz	5.0 ms	10.0 ms
t_2	± 12.5 kHz	20.0 ms	25.0 ms
t_3 ⁴	± 25.0 kHz	5.0 ms	10.0 ms
Transient Frequency Behavior for Equipment Designed to Operate on 12.5 kHz Channels			
t_1 ⁴	± 12.5 kHz	5.0 ms	10.0 ms
t_2	± 6.25 kHz	20.0 ms	25.0 ms
t_3 ⁴	± 12.5 kHz	5.0 ms	10.0 ms

Notes:

- t_{on} is the instant when a 1 kHz test signal is completely suppressed, including any capture time due to phasing.
 t_1 is the time period immediately following t_{on} .
 t_2 is the time period immediately following t_1 .
 t_3 is the time period from the instant when the transmitter is turned off until t_{off} .
 t_{off} is the instant when the 1 kHz test signal starts to rise.
- During the time from the end of t_2 to the beginning of t_3 , the frequency difference must not exceed the limits specified in § 90.213.
- Difference between the actual transmitter frequency and the assigned transmitter frequency.
- If the transmitter carrier output power rating is 6 watts or less, the frequency difference during this time period may exceed the maximum frequency difference for this time period.

6.13.2. Method of Measurements

Refer to Exhibit 8, § 8.6 of this test report and ANSI/TIA/EIA - 603 - 1992, Sec. 2.2.19, Page 83

ULTRATECH GROUP OF LABS

3000 Bristol Circle, Oakville, Ontario, Canada L6H 6G4
 Tel. #: 905-829-1570, Fax. #: 905-829-8050, Email: yhk.ultratech@sympatico.ca, Website: <http://www.ultratech-labs.com>

File #: ICOM33-FTX
 November 30, 2001

- Assessed by ITI (UK) Competent Body, NVLAP (USA) Accreditation Body & ACA/AUSTEL (Australia), VCCI (Japan)
- Accredited by Industry Canada (Canada) under ACC-LAB (Europe/Canada MRA and APEC/Canada MRA)
- Recognized/Listed by FCC (USA)
- All test results contained in this engineering test report are traceable to National Institute of Standards and Technology (NIST)

6.13.3. Test Equipment List

Test Instruments	Manufacturer	Model No.	Serial No.	Frequency Range
Audio Signal Generator	Krohn-Hite	2000	462	0.03 Hz ~ 30 MHz
RF Synthesized Signal Generator	Fluke	6061A	4770301	10 kHz – 1050 MHz
Radio Communication Test Set	Marconi Instruments	2955	132037/226	400kHz - 1000 MHz
Network Combiner	Mini-Circuit	15542	--	DC to 32 GHz
Infinium Digitizing Oscilloscope	Hewlett Packard	54810A	US38380192	DC to 500 MHz, 1 Gsa/s
RF Detector	Amphenol	UG-1094/U1050	--	--
Attenuator	Weinschel Corp	2320-34	BH-7876	DC – 18 GHz

6.13.4. Test Arrangement

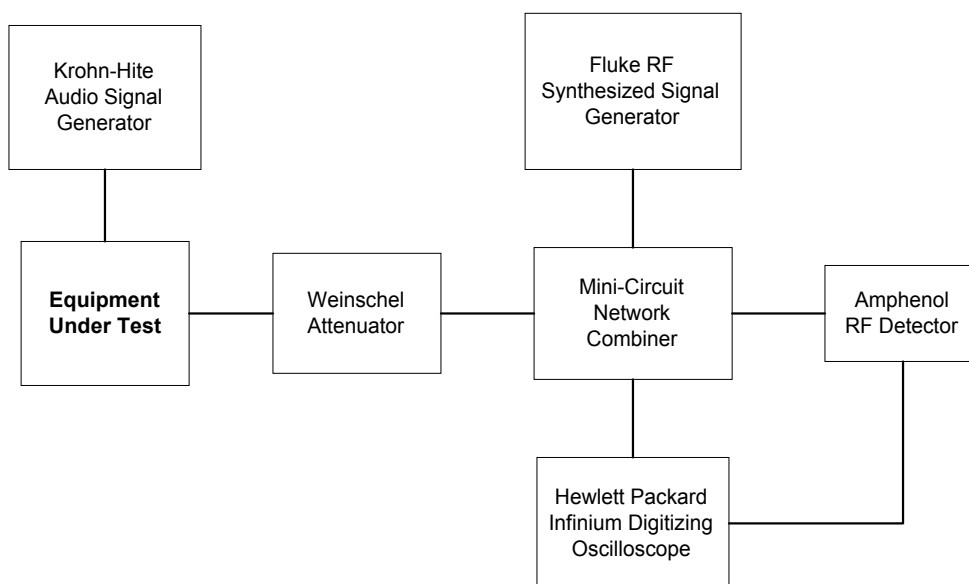

ULTRATECH GROUP OF LABS

3000 Bristol Circle, Oakville, Ontario, Canada L6H 6G4
 Tel. #: 905-829-1570, Fax. #: 905-829-8050, Email: yhk.ultratech@sympatico.ca, Website: <http://www.ultratech-labs.com>

File #: ICOM33-FTX
 November 30, 2001

- Assessed by ITI (UK) Competent Body, NVLAP (USA) Accreditation Body & ACA/AUSTEL (Australia), VCCI (Japan)
- Accredited by Industry Canada (Canada) under ACC-LAB (Europe/Canada MRA and APEC/Canada MRA)
- Recognized/Listed by FCC (USA)
- All test results contained in this engineering test report are traceable to National Institute of Standards and Technology (NIST)

6.13.5. Test Data

Remark:

Test data plots for the following results can be found in Annex 1, plots # 25 to 32.

• **12.5 kHz Channel Spacing Operation**

Time Interval	Maximum Transient Frequency	Transient Frequency Limit
Test Configuration #1: Unmodulated		
t ₁ (10 ms) Switch ON Condition	-3.1 kHz	12.5 kHz or no limit for RF Output Power < 6 Watts
t ₂ (25 ms) Switch On Condition	0	12.5 kHz
After t ₂ (10 ms) Switch On Condition	0	FCC Limit = ± 1000 Hz (2.5 ppm @ 400.05 MHz)
Before t ₃ (10 ms) Switch Off Condition	0	FCC Limit = ± 1000 Hz (2.5 ppm @ 400.05 MHz)
t ₃ (10 ms) Switch Off Condition	> +12.5 kHz	12.5 kHz or no limit for RF Output Power < 6 Watts
Test Configuration #2: FM modulation with 2.5 KHz Sine Wave		
t ₁ (10 ms) Switch ON Condition	+5.5 kHz	12.5 kHz or no limit for RF Output Power < 6 Watts
t ₂ (25 ms) Switch On Condition	0	12.5 kHz
After t ₂ (10 ms) Switch On Condition	0	FCC Limit = ± 1000 Hz (2.5 ppm @ 400.05 MHz)
Before t ₃ (10 ms) Switch Off Condition	0	FCC Limit = ± 1000 Hz (2.5 ppm @ 400.05 MHz)
t ₃ (10 ms) Switch Off Condition	+11.5 kHz	25 kHz or no limit for RF Output Power < 6 Watts

ULTRATECH GROUP OF LABS

3000 Bristol Circle, Oakville, Ontario, Canada L6H 6G4
 Tel. #: 905-829-1570, Fax. #: 905-829-8050, Email: yhk.ultratech@sympatico.ca, Website: <http://www.ultratech-labs.com>

File #: ICOM33-FTX
 November 30, 2001

- Assessed by ITI (UK) Competent Body, NVLAP (USA) Accreditation Body & ACA/AUSTEL (Australia), VCCI (Japan)
- Accredited by Industry Canada (Canada) under ACC-LAB (Europe/Canada MRA and APEC/Canada MRA)
- Recognized/Listed by FCC (USA)
- All test results contained in this engineering test report are traceable to National Institute of Standards and Technology (NIST)

• **25 kHz Channel Spacing Operation**

Time Interval	Maximum Transient Frequency	Transient Frequency Limit
Test Configuration #1: Unmodulated		
t ₁ (10 ms) Switch ON Condition	-5 kHz	25 kHz or no limit for RF Output Power < 6 Watts
t ₂ (25 ms) Switch On Condition	0	25 kHz
After t ₂ (10 ms) Switch On Condition	0	FCC Limit = ± 2000 Hz (5 ppm @ 400.05 MHz)
Before t ₃ (10 ms) Switch Off Condition	0	FCC Limit = ± 2000 Hz (2.5 ppm @ 400.05 MHz)
t ₃ (10 ms) Switch Off Condition	+21.9 KHz	25 kHz or no limit for RF Output Power < 6 Watts
Test Configuration #2: FM modulation with 2.5 KHz Sine Wave		
t ₁ (10 ms) Switch ON Condition	+8.1 kHz	25 kHz or no limit for RF Output Power < 6 Watts
t ₂ (25 ms) Switch On Condition	0	25 kHz
After t ₂ (10 ms) Switch On Condition	0	FCC Limit = ± 2000 Hz (5 ppm @ 400.05 MHz)
Before t ₃ (10 ms) Switch Off Condition	0	FCC Limit = ± 2000 Hz (5 ppm @ 400.05 MHz)
t ₃ (10 ms) Switch Off Condition	+21.5 kHz	25 kHz or no limit for RF Output Power < 6 Watts

ULTRATECH GROUP OF LABS

3000 Bristol Circle, Oakville, Ontario, Canada L6H 6G4
 Tel. #: 905-829-1570, Fax. #: 905-829-8050, Email: yhk.ultratech@sympatico.ca, Website: <http://www.ultratech-labs.com>

File #: ICOM33-FTX
 November 30, 2001

- Assessed by ITI (UK) Competent Body, NVLAP (USA) Accreditation Body & ACA/AUSTEL (Australia), VCCI (Japan)
- Accredited by Industry Canada (Canada) under ACC-LAB (Europe/Canada MRA and APEC/Canada MRA)
- Recognized/Listed by FCC (USA)
- All test results contained in this engineering test report are traceable to National Institute of Standards and Technology (NIST)

EXHIBIT 7. MEASUREMENT UNCERTAINTY

The measurement uncertainties stated were calculated in accordance with the requirements of NIST Technical Note 1297 and NIS 81 (1994)

7.1. RADIATED EMISSION MEASUREMENT UNCERTAINTY

CONTRIBUTION (Radiated Emissions)	PROBABILITY DISTRIBUTION	UNCERTAINTY (\pm dB)	
		3 m	10 m
Antenna Factor Calibration	Normal (k=2)	± 1.0	± 1.0
Cable Loss Calibration	Normal (k=2)	± 0.3	± 0.5
EMI Receiver specification	Rectangular	± 1.5	± 1.5
Antenna Directivity	Rectangular	± 0.5	± 0.5
Antenna factor variation with height	Rectangular	± 2.0	± 0.5
Antenna phase center variation	Rectangular	0.0	± 0.2
Antenna factor frequency interpolation	Rectangular	± 0.25	± 0.25
Measurement distance variation	Rectangular	± 0.6	± 0.4
Site imperfections	Rectangular	± 2.0	± 2.0
Mismatch: Receiver VRC $\Gamma_1 = 0.2$ Antenna VRC $\Gamma_R = 0.67(\text{Bi}) 0.3 (\text{Lp})$ Uncertainty limits $20\text{Log}(1 \pm \Gamma_1 \Gamma_R)$	U-Shaped	+1.1 -1.25	± 0.5
System repeatability	Std. Deviation	± 0.5	± 0.5
Repeatability of EUT		-	-
Combined standard uncertainty	Normal	+2.19 / -2.21	+1.74 / -1.72
Expanded uncertainty U	Normal (k=2)	+4.38 / -4.42	+3.48 / -3.44

Calculation for maximum uncertainty when 3m biconical antenna including a factor of k=2 is used:

$$U = 2u_c(y) = 2x(+2.19) = +4.38 \text{ dB} \quad \text{And} \quad U = 2u_c(y) = 2x(-2.21) = -4.42 \text{ dB}$$

ULTRATECH GROUP OF LABS

3000 Bristol Circle, Oakville, Ontario, Canada L6H 6G4
 Tel. #: 905-829-1570, Fax. #: 905-829-8050, Email: yhk.ultratech@sympatico.ca, Website: <http://www.ultratech-labs.com>

File #: ICOM33-FTX
 November 30, 2001

- Assessed by ITI (UK) Competent Body, NVLAP (USA) Accreditation Body & ACA/AUSTEL (Australia), VCCI (Japan)
- Accredited by Industry Canada (Canada) under ACC-LAB (Europe/Canada MRA and APEC/Canada MRA)
- Recognized/Listed by FCC (USA)
- All test results contained in this engineering test report are traceable to National Institute of Standards and Technology (NIST)

EXHIBIT 8. MEASUREMENT METHODS

8.1. CONDUCTED POWER MEASUREMENTS

- The following shall be applied to the combination(s) of the radio device and its intended antenna(e).
- If the RF level is user adjustable, all measurements shall be made with the highest power level available to the user for that combination.
- The following method of measurement shall apply to both conducted and radiated measurements.
- The radiated measurements are performed at the Ultratech Calibrated Open Field Test Site.
- The measurement shall be performed using normal operation of the equipment with modulation.

Test procedure shall be as follows:

Step 1: Duty Cycle measurements if the transmitter's transmission is transient

- Using a EMI Receiver with the frequency span set to 0 Hz and the sweep time set at a suitable value to capture the envelope peaks and the duty cycle of the transmitter output signal;
- The duty cycle of the transmitter, $x = T_x \text{ on} / (T_x \text{ on} + T_x \text{ off})$ with $0 < x < 1$, is measure and recorded in the test report. For the purpose of testing, the equipment shall be operated with a duty cycle that is equal or more than 0.1.

Step 2: Calculation of Average EIRP. See Figure 1

- The average output power of the transmitter shall be determined using a wideband, calibrated RF average power meter with the power sensor with an integration period that exceeds the repetition period of the transmitter by a factor 5 or more. The observed value shall be recorded as "A" (in dBm);
- The e.i.r.p. shall be calculated from the above measured power output "A", the observed duty cycle x , and the applicable antenna assembly gain "G" in dBi, according to the formula:

$$\text{EIRP} = \text{A} + \text{G} + 10\log(1/x)$$

$$\{ X = 1 \text{ for continuous transmission } \Rightarrow 10\log(1/x) = 0 \text{ dB} \}$$

Figure 1.

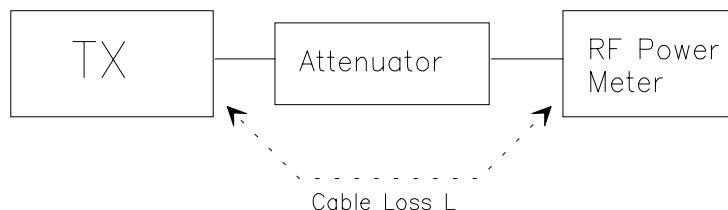

ULTRATECH GROUP OF LABS

3000 Bristol Circle, Oakville, Ontario, Canada L6H 6G4
Tel. #: 905-829-1570, Fax. #: 905-829-8050, Email: yhk.ultratech@sympatico.ca, Website: <http://www.ultratech-labs.com>

File #: ICOM33-FTX
November 30, 2001

- Assessed by ITI (UK) Competent Body, NVLAP (USA) Accreditation Body & ACA/AUSTEL (Australia), VCCI (Japan)
- Accredited by Industry Canada (Canada) under ACC-LAB (Europe/Canada MRA and APEC/Canada MRA)
- Recognized/Listed by FCC (USA)
- All test results contained in this engineering test report are traceable to National Institute of Standards and Technology (NIST)

8.2. RADIATED POWER MEASUREMENTS (ERP & EIRP) USING SUBSTITUTION METHOD

8.2.1. Maximizing RF Emission Level (E-Field)

- (a) The measurements was performed with full rf output power and modulation.
- (b) Test was performed at listed 3m open area test site (listed with FCC, IC, ITI, NVLAP, ACA & VCCI).
- (c) The transmitter under test was placed at the specified height on a non-conducting turntable (80 cm height)
- (d) The BICONILOG antenna (20 MHz to 1 GHz) or HORN antenna (1 GHz to 18 GHz) was used for measuring.
- (e) Load an appropriate correction factors file in EMI Receiver for correcting the field strength reading level

Total Correction Factor recorded in the EMI Receiver = Cable Loss + Antenna Factor

$E \text{ (dBuV/m)} = \text{Reading (dBuV)} + \text{Total Correction Factor (dB/m)}$

- (f) Set the EMI Receiver and #2 as follows:

Center Frequency:	test frequency
Resolution BW:	100 kHz
Video BW:	same
Detector Mode:	positive
Average:	off
Span:	3 x the signal bandwidth

- (g) The test antenna was lowered or raised from 1 to 4 meters until the maximum signal level was detected.
- (h) The transmitter was rotated through 360° about a vertical axis until a higher maximum signal was received.
- (i) The test antenna was lowered or raised again from 1 to 4 meters until a maximum was obtained. This level was recorded.
- (j) The recorded reading was corrected to the true field strength level by adding the antenna factor, cable loss and subtracting the pre-amplifier gain.
- (k) The above steps were repeated with both transmitters' antenna and test receiving antenna placed in vertical and horizontal polarization. Both readings with the antennas placed in vertical and horizontal polarization shall be recorded.
- (l) Repeat for all different test signal frequencies

ULTRATECH GROUP OF LABS

3000 Bristol Circle, Oakville, Ontario, Canada L6H 6G4
Tel. #: 905-829-1570, Fax. #: 905-829-8050, Email: yhk.ultratech@sympatico.ca, Website: <http://www.ultratech-labs.com>

File #: ICOM33-FTX
November 30, 2001

- Assessed by ITI (UK) Competent Body, NVLAP (USA) Accreditation Body & ACA/AUSTEL (Australia), VCCI (Japan)
- Accredited by Industry Canada (Canada) under ACC-LAB (Europe/Canada MRA and APEC/Canada MRA)
- Recognized/Listed by FCC (USA)
- All test results contained in this engineering test report are traceable to National Institute of Standards and Technology (NIST)

8.2.2. Measuring the EIRP of Spurious/Harmonic Emissions using Substitution Method

- (a) Set the EMI Receiver (for measuring E-Field) and Receiver #2 (for measuring EIRP) as follows:

Center Frequency: equal to the signal source
Resolution BW: 10 kHz
Video BW: same
Detector Mode: positive
Average: off
Span: 3 x the signal bandwidth

- (b) Load an appropriate correction factors file in EMI Receiver for correcting the field strength reading level

Total Correction Factor recorded in the EMI Receiver = Cable Loss + Antenna Factor
 $E \text{ (dBuV/m)} = \text{Reading (dBuV)} + \text{Total Correction Factor (dB/m)}$

- (c) Select the frequency and E-field levels obtained in the Section 8.2.1 for ERP/EIRP measurements.
(d) Substitute the EUT by a signal generator and one of the following transmitting antenna (substitution antenna):
◆ DIPOLE antenna for frequency from 30-1000 MHz or
◆ HORN antenna for frequency above 1 GHz }.
(e) Mount the transmitting antenna at 1.5 meter high from the ground plane.
(f) Use one of the following antenna as a receiving antenna:
◆ DIPOLE antenna for frequency from 30-1000 MHz or
◆ HORN antenna for frequency above 1 GHz }.
(g) If the DIPOLE antenna is used, tune it's elements to the frequency as specified in the calibration manual.
(h) Adjust both transmitting and receiving antenna in a VERTICAL polarization.
(i) Tune the EMI Receivers to the test frequency.
(j) Lower or raise the test antenna from 1 to 4 meters until the maximum signal level was detected.
(k) The transmitter was rotated through 360° about a vertical axis until a higher maximum signal was received.
(l) Lower or raise the test antenna from 1 to 4 meters until the maximum signal level was detected.
(m) Adjust input signal to the substitution antenna until an equal or a known related level to that detected from the transmitter was obtained in the test receiver.
(n) Record the power level read from the Average Power Meter and calculate the ERP/EIRP as follows:

$$P = P1 - L1 = (P2 + L2) - L1 = P3 + A + L2 - L1$$

$$EIRP = P + G1 = P3 + L2 - L1 + A + G1$$

$$ERP = EIRP - 2.15 \text{ dB}$$

$$\text{Total Correction factor in EMI Receiver \# 2} = L2 - L1 + G1$$

Where: P: Actual RF Power fed into the substitution antenna port after corrected.
P1: Power output from the signal generator
P2: Power measured at attenuator A input
P3: Power reading on the Average Power Meter
EIRP: EIRP after correction
ERP: ERP after correction

- (o) Adjust both transmitting and receiving antenna in a HORIZONTAL polarization, then repeat step (k) to (o)
(p) Repeat step (d) to (o) for different test frequency
(q) Repeat steps (c) to (j) with the substitution antenna oriented in horizontal polarization.
(r) Actual gain of the EUT's antenna is the difference of the measured EIRP and measured RF power at the RF port. Correct the antenna gain if necessary.:

ULTRATECH GROUP OF LABS

3000 Bristol Circle, Oakville, Ontario, Canada L6H 6G4
Tel. #: 905-829-1570, Fax. #: 905-829-8050, Email: vhk.ultratech@sympatico.ca, Website: <http://www.ultratech-labs.com>

File #: ICOM33-FTX
November 30, 2001

- Assessed by ITI (UK) Competent Body, NVLAP (USA) Accreditation Body & ACA/AUSTEL (Australia), VCCI (Japan)
- Accredited by Industry Canada (Canada) under ACC-LAB (Europe/Canada MRA and APEC/Canada MRA)
- Recognized/Listed by FCC (USA)
- All test results contained in this engineering test report are traceable to National Institute of Standards and Technology (NIST)

Figure 2

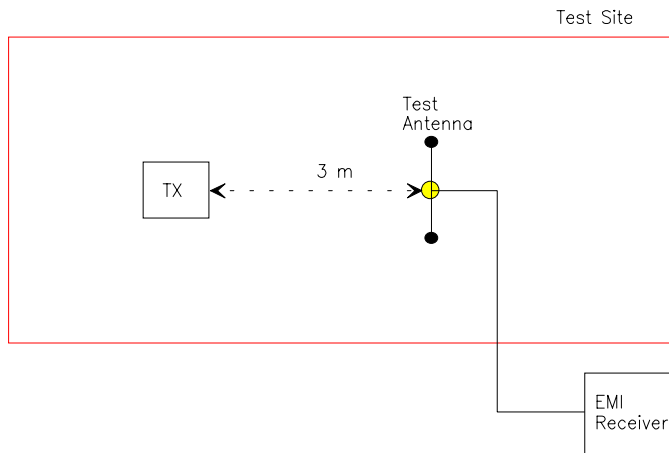
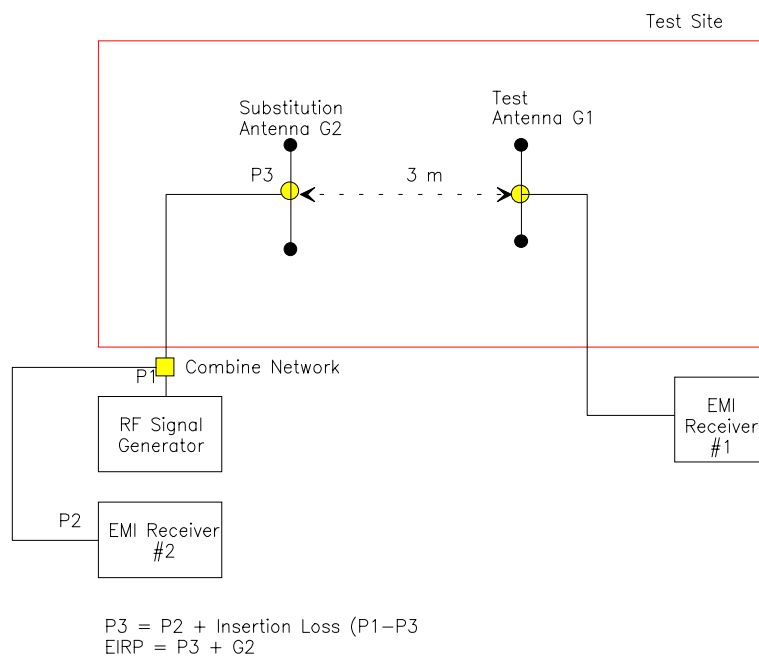

Figure 3



ULTRATECH GROUP OF LABS

3000 Bristol Circle, Oakville, Ontario, Canada L6H 6G4
 Tel. #: 905-829-1570, Fax. #: 905-829-8050, Email: yhk.ultratech@sympatico.ca, Website: <http://www.ultratech-labs.com>

File #: ICOM33-FTX
 November 30, 2001

- Assessed by ITI (UK) Competent Body, NVLAP (USA) Accreditation Body & ACA/AUSTEL (Australia), VCCI (Japan)
- Accredited by Industry Canada (Canada) under ACC-LAB (Europe/Canada MRA and APEC/Canada MRA)
- Recognized/Listed by FCC (USA)
- All test results contained in this engineering test report are traceable to National Institute of Standards and Technology (NIST)

8.3. FREQUENCY STABILITY

Refer to FCC @ 2.1055.

- (a) The frequency stability shall be measured with variation of ambient temperature as follows: From -30 to +50 centigrade except that specified in subparagraph (2) & (3) of this paragraph.
- (b) Frequency measurements shall be made at extremes of the specified temperature range and at intervals of not more than 10 centigrade through the range. A period of time sufficient to stabilize all of the components of the oscillator circuit at each temperature level shall be allowed prior to frequency measurement. The short-term transient effects on the frequency of the transmitter due to keying (except for broadcast transmitters) and any heating element cycling normally occurring at each ambient temperature level also shall be shown. Only the portion or portions of the transmitter containing the frequency determining and stability circuitry need be subjected to the temperature variation test.
- (d) The frequency stability supply shall be measured with variation of primary supply voltage as follows:
 - (1) Vary primary supply voltage from 85 to 115 percent of the nominal value for other than hand carried battery equipment.
 - (2) For hand carried, battery powered equipment, reduce primary supply voltage to the battery operating end point which shall be specified by the manufacturer.
 - (3) The supply voltage shall be measured at the input to the cable normally provide with the equipment, or at the power supply terminals if cables are not normally provided. Effects on frequency of transmitter keying (except for broadcast transmitters) and any heating element cycling at the nominal supply voltage and at each extreme also shall be shown.
- (e) When deemed necessary, the Commission may require tests of frequency stability under conditions in addition to those specifically set out in paragraphs (a), (b), (c) and (d) of this section. (For example, measurements showing the effect of proximity to large metal objects, or of various types of antennas, may be required for portable equipment).

ULTRATECH GROUP OF LABS

3000 Bristol Circle, Oakville, Ontario, Canada L6H 6G4
Tel. #: 905-829-1570, Fax. #: 905-829-8050, Email: vhk.ultratech@sympatico.ca, Website: <http://www.ultratech-labs.com>

File #: ICOM33-FTX
November 30, 2001

- Assessed by ITI (UK) Competent Body, NVLAP (USA) Accreditation Body & ACA/AUSTEL (Australia), VCCI (Japan)
- Accredited by Industry Canada (Canada) under ACC-LAB (Europe/Canada MRA and APEC/Canada MRA)
- Recognized/Listed by FCC (USA)
- All test results contained in this engineering test report are traceable to National Institute of Standards and Technology (NIST)

8.4. EMISSION MASK

Voice or Digital Modulation Through a Voice Input Port @ 2.1049(c)(1):- The transmitter was modulated by a 2.5 KHz tone signal at an input level 16 dB greater than that required to produce 50% modulation (e.g.: ± 2.5 KHz peak deviation at 1 KHz modulating frequency). The input level was established at the frequency of maximum response of the audio modulating circuit.

Digital Modulation Through a Data Input Port @ 2.1049(h):- Transmitters employing digital modulation techniques - when modulated by an input signal such that its amplitude and symbol rate represent the maximum rated conditions under which the equipment will be operated. The signal shall be applied through any filter networks, pseudo-random generators or other devices required in normal service. Additionally, the Emission Masks shall be shown for operation with any devices used for modifying the spectrum when such devices are operational at the discretion of the user.

The following EMI Receiver bandwidth shall be used for measurement of Emission Mask/Out-of-Band Emission Measurements:

- (1) For 25 kHz Channel Spacing: RBW = 300 Hz
- (2) For 12.5 kHz or 6.25 kHz Channel Spacings: RBW = 100 Hz

The all cases the Video Bandwidth shall be equal or greater than the measuring bandwidth.

8.5. SPURIOUS EMISSIONS (CONDUCTED)

With transmitter modulation characteristics described in Out-of-Band Emissions measurements @ 2.1049, the transmitter spurious and harmonic emissions were scanned. The spurious and harmonic emissions were measured with the EMI Receiver controls set as RBW = 30 kHz minimum, VBW \geq RBW and SWEEP TIME = AUTO). The transmitter was operated at a full rated power output, and modulated as follows:

FCC 47 CFR, Para. 2.1057 - Frequency spectrum to be investigated:- The spectrum was investigated from the lowest radio generated in the equipment up to at least the 10th harmonic of the carrier frequency or to the highest frequency practicable in the present state of the art of measuring techniques, whichever is lower. Particular attention should be paid to harmonics and subharmonics of the carrier frequency. Radiation at the frequencies of multiplier stages should be checked. The amplitude of spurious emissions which are attenuated more than 20 dB below the permissible value need not be reported.

FCC 47 CFR, Para. 2.1051 - Spurious Emissions at Antenna Terminal:- The radio frequency voltage or powers generated within the equipment and appearing on a spurious frequency shall be checked at the equipment output terminals when properly loaded with a suitable artificial antenna. Curves or equivalent data shall show the magnitude of the harmonic and other spurious emission that can be detected when the equipment is operated under the conditions specified in 2.1049 as appropriate. The magnitude of spurious emissions which are attenuated more than 20 dB below the permissible value need not be specified.

ULTRATECH GROUP OF LABS

3000 Bristol Circle, Oakville, Ontario, Canada L6H 6G4
Tel. #: 905-829-1570, Fax. #: 905-829-8050, Email: vhk.ultratech@sympatico.ca, Website: <http://www.ultratech-labs.com>

File #: ICOM33-FTX
November 30, 2001

- Assessed by ITI (UK) Competent Body, NVLAP (USA) Accreditation Body & ACA/AUSTEL (Australia), VCCI (Japan)
- Accredited by Industry Canada (Canada) under ACC-LAB (Europe/Canada MRA and APEC/Canada MRA)
- Recognized/Listed by FCC (USA)
- All test results contained in this engineering test report are traceable to National Institute of Standards and Technology (NIST)

8.6. TRANSIENT FREQUENCY BEHAVIOR

1. Connect the transmitter under tests as shown in the above block diagram
2. Set the signal generator to the assigned frequency and modulate with a 1 kHz tone at ± 12.5 kHz deviation and its output level to be 50 dB below the transmitter rf output at the test receiver end.
3. Set the horizontal sweep rate on the storage scope to 10 milliseconds per division and adjust the display to continuously view the 1000 Hz tone from the Demodulator Output Port (DOP) of the Test Receiver. Adjust the vertical scale amplitude control of the scope to display the 1000 Hz at ± 4 divisions vertical Center at the display.
4. Adjust the scope so it will trigger on an increasing magnitude from the RF trigger signal of the transmitter under test when the transmitter was turned on. Set the controls to store the display.
5. The output at the DOP, due to the change in the ratio of the power between the signal generator input power and transmitter output power will, because of the capture effect of the test receiver, produce a change in display: For the first part of the sweep it will show the 1 kHz test signal. Then once the receiver's demodulator has been captured by the transmitter power, the display will show the frequency difference from the assigned frequency to the actual transmitter frequency versus time. The instant when the 1 kHz test signal is completely suppressed (including any capture time due to phasing) is considered to be t_{on} . The trace should be maintained within the allowed divisions during the period t_1 and t_2 .
6. During the time from the end of t_2 to the beginning of t_3 the frequency difference should not exceed the limits set by the FCC in Part 90.214 and the outlined in the Carrier Frequency Stability sections. The allowed limit is equal to FCC frequency tolerance limits specified in FCC 90.213.
7. Repeat the above steps when the transmitter was turned off for measuring t_3 .

ULTRATECH GROUP OF LABS

3000 Bristol Circle, Oakville, Ontario, Canada L6H 6G4
Tel. #: 905-829-1570, Fax. #: 905-829-8050, Email: yhk.ultratech@sympatico.ca, Website: <http://www.ultratech-labs.com>

File #: ICOM33-FTX
November 30, 2001

- Assessed by ITI (UK) Competent Body, NVLAP (USA) Accreditation Body & ACA/AUSTEL (Australia), VCCI (Japan)
- Accredited by Industry Canada (Canada) under ACC-LAB (Europe/Canada MRA and APEC/Canada MRA)
- Recognized/Listed by FCC (USA)
- All test results contained in this engineering test report are traceable to National Institute of Standards and Technology (NIST)