

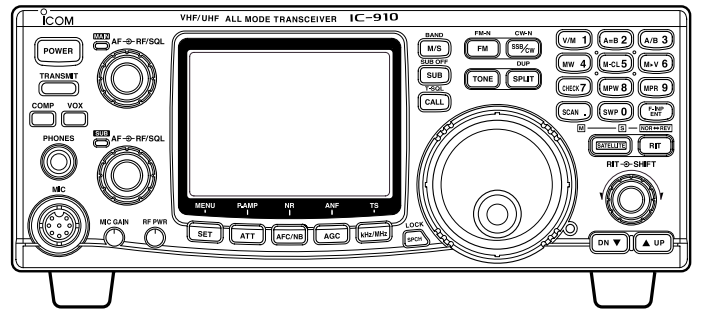

# INSTRUCTION MANUAL

## VHF/UHF ALL MODE TRANSCEIVER **IC-910H**



---

## IMPORTANT

---

**READ THIS INSTRUCTION MANUAL CAREFULLY** before attempting to operate the transceiver.

**SAVE THIS INSTRUCTION MANUAL.** This manual contains important safety and operating instructions for the IC-910H.

---

## EXPLICIT DEFINITIONS

---

WORD	DEFINITION
<b>⚠ WARNING</b>	Personal injury, fire hazard or electric shock may occur.
<b>⚠ CAUTION</b>	Equipment damage may occur.
<b>NOTE</b>	If disregarded, inconvenience only. No risk of personal injury, fire or electric shock.

---

## PRECAUTIONS

---

**⚠ WARNING HIGH VOLTAGE! NEVER** attach an antenna or internal antenna connector during transmission. This may result in an electrical shock or burn.

**⚠ NEVER** apply AC to the [DC13.8V] jack on the transceiver rear panel. This could cause a fire or ruin the transceiver.

**⚠ NEVER** apply more than 16 V DC, such as a 24 V battery, to the [DC13.8V] jack on the transceiver rear panel. This could cause a fire or ruin the transceiver.

**⚠ NEVER** let metal, wire or other objects touch any internal part or connectors on the rear panel of the transceiver. This may result in an electric shock.

**⚠ NEVER** expose the transceiver to rain, snow or any liquids.

**AVOID** using or placing the transceiver in areas with temperatures below  $-10^{\circ}\text{C}$  ( $+14^{\circ}\text{F}$ ) or above  $+60^{\circ}\text{C}$  ( $+140^{\circ}\text{F}$ ). Be aware that temperatures on a vehicle's dashboard can exceed  $80^{\circ}\text{C}$  ( $+176^{\circ}\text{F}$ ), resulting in permanent damage to the transceiver if left there for extended periods.

**AVOID** placing the transceiver in excessively dusty environments or in direct sunlight.

**AVOID** placing the transceiver against walls or putting anything on top of the transceiver. This will obstruct heat dissipation.

Place unit in a secure place to avoid inadvertent use by children.

During mobile operation, **DO NOT** operate the transceiver without running the vehicle's engine. When the transceiver power is ON and your vehicle's engine is OFF, the vehicle's battery will soon become exhausted.

Make sure the transceiver power is OFF before starting the vehicle. This will avoid possible damage to the transceiver by ignition voltage spikes.

During maritime mobile operation, keep the transceiver and microphone as far away as possible from the magnetic navigation compass to prevent erroneous indications.

**BE CAREFUL!** The heatsink will become hot when operating the transceiver continuously for long periods.

**BE CAREFUL!** If a linear amplifier is connected, set the transceiver's RF output power to less than the linear amplifier's maximum input level, otherwise, the linear amplifier will be damaged.

Use Icom microphones only (supplied or optional). Other manufacturer's microphones have different pin assignments, and connection to the IC-910H may damage the transceiver.



Versions of the IC-910H which display the "CE" symbol on the serial number seal, comply with the European harmonised standard ETS300 684 (EMC product standard for Commercially Available Amateur Radio Equipment).

<p><b>IMPORTANT</b> ..... i</p> <p><b>EXPLICIT DEFINITIONS</b> ..... i</p> <p><b>PRECAUTIONS</b> ..... i</p> <p><b>1 TABLE OF CONTENTS</b> ..... 1</p> <p><b>2 PANEL DESCRIPTION</b> ..... 2–13</p> <ul style="list-style-type: none"> <li>■ Front panel ..... 2</li> <li>■ Function display ..... 10</li> <li>■ Rear panel ..... 12</li> </ul> <p><b>3 INSTALLATION AND CONNECTIONS</b> ..... 14–17</p> <ul style="list-style-type: none"> <li>■ Unpacking ..... 14</li> <li>■ Grounding ..... 14</li> <li>■ Selecting a location ..... 14</li> <li>■ Antenna connection ..... 14</li> <li>■ Required connections ..... 15</li> <li>■ Advanced connections ..... 16</li> <li>■ Power supply connections ..... 17</li> </ul> <p><b>4 BASIC OPERATION</b> ..... 18–25</p> <ul style="list-style-type: none"> <li>■ Initial settings ..... 18</li> <li>■ When first applying power (CPU resetting) ..... 18</li> <li>■ MAIN and SUB bands ..... 19</li> <li>■ Operating band selection ..... 20</li> <li>■ VFO description ..... 21</li> <li>■ Frequency setting ..... 22</li> <li>■ SUB band OFF ..... 24</li> <li>■ SUB tuning dial ..... 24</li> <li>■ Dial lock function ..... 25</li> </ul> <p><b>5 RECEIVE AND TRANSMIT</b> .. 26–39</p> <ul style="list-style-type: none"> <li>■ Functions for receive ..... 26</li> <li>■ RIT function ..... 27</li> <li>■ IF shift function ..... 27</li> <li>■ AGC time constant ..... 28</li> <li>■ AFC function ..... 28</li> <li>■ FM center indicator ..... 28</li> <li>■ Attenuator ..... 29</li> <li>■ Simple band scope ..... 29</li> <li>■ Noise blanker ..... 30</li> <li>■ Tone squelch operation ..... 30</li> <li>■ Optional DSP functions ..... 31</li> <li>■ Functions for transmit ..... 32</li> <li>■ Transmit via microphone ..... 32</li> </ul>	<ul style="list-style-type: none"> <li>■ Indications during transmit ..... 32</li> <li>■ FM mode operation ..... 33</li> <li>■ VOX operation ..... 33</li> <li>■ Repeater operation ..... 34</li> <li>■ SSB mode operation ..... 36</li> <li>■ Speech compressor ..... 36</li> <li>■ Split frequency operation ..... 37</li> <li>■ Full duplex operation ..... 37</li> <li>■ Connections for CW ..... 38</li> <li>■ CW mode operation ..... 38</li> </ul> <p><b>6 MEMORY OPERATION</b> ..... 40–44</p> <ul style="list-style-type: none"> <li>■ Memory channels ..... 40</li> <li>■ Operation on a memory channel .. 40</li> <li>■ Programming in VFO mode ..... 41</li> <li>■ Programming in memory mode .... 41</li> <li>■ Blank channels ..... 42</li> <li>■ Frequency transferring ..... 42</li> <li>■ Memory clearing ..... 43</li> <li>■ Call channels ..... 43</li> <li>■ Memo pads ..... 44</li> </ul> <p><b>7 SCANS</b> ..... 45–47</p> <ul style="list-style-type: none"> <li>■ Scan types ..... 45</li> <li>■ Preparation ..... 45</li> <li>■ Programmed scan operation ..... 46</li> <li>■ Memory scan operation ..... 46</li> <li>■ Memory select scan ..... 47</li> <li>■ Tone scan ..... 47</li> </ul> <p><b>8 SATELLITE OPERATION</b> ..... 48–51</p> <ul style="list-style-type: none"> <li>■ Satellite communications outline .. 48</li> <li>■ Satellite notes ..... 48</li> <li>■ Entering into the satellite mode .... 48</li> <li>■ Setting the satellite VFO ..... 49</li> <li>■ Tracking selection ..... 49</li> <li>■ Preparation ..... 50</li> <li>■ Satellite operation ..... 51</li> <li>■ Satellite memory ..... 51</li> </ul> <p><b>9 DATA COMMUNICATION</b> ..... 52–54</p> <ul style="list-style-type: none"> <li>■ Functions for AFSK ..... 52</li> <li>■ Connections for AFSK ..... 52</li> <li>■ Operating mode notes ..... 53</li> <li>■ Operating frequency notes ..... 53</li> <li>■ AFSK operation ..... 53</li> <li>■ Setting the ACC socket ..... 54</li> </ul>	<p><b>10 SET MODE</b> ..... 55–69</p> <ul style="list-style-type: none"> <li>■ Set mode description ..... 55</li> <li>■ General set mode ..... 56</li> <li>■ FM set mode ..... 60</li> <li>■ SSB/CW set mode ..... 62</li> <li>■ Scan set mode ..... 64</li> <li>■ Memo pad set mode ..... 64</li> <li>■ Compressor set mode ..... 64</li> <li>■ VOX set mode ..... 65</li> <li>■ Attenuator set mode ..... 65</li> <li>■ Transmit set mode ..... 66</li> <li>■ NR set mode ..... 67</li> <li>■ SWP set mode ..... 67</li> <li>■ RIT/SHIFT set mode ..... 68</li> <li>■ Speech set mode ..... 69</li> </ul> <p><b>11 OPTION INSTALLATIONS</b> ... 70–76</p> <ul style="list-style-type: none"> <li>■ Internal view ..... 70</li> <li>■ Opening the transceiver's case .... 71</li> <li>■ UT-102 VOICE SYNTHESIZER UNIT ..... 71</li> <li>■ UT-106 DSP UNIT ..... 72</li> <li>■ UX-910 1200 MHz BAND UNIT ..... 73</li> <li>■ CR-293 HIGH STABILITY CRYSTAL UNIT ..... 74</li> <li>■ FL-132/FL-133 CW NARROW FILTER ..... 75</li> </ul> <p><b>12 MAINTENANCE</b> ..... 76–77</p> <ul style="list-style-type: none"> <li>■ Troubleshooting ..... 76</li> <li>■ Fuse replacement ..... 77</li> <li>■ CPU resetting ..... 77</li> </ul> <p><b>13 CONTROL COMMAND</b> ..... 78–79</p> <ul style="list-style-type: none"> <li>■ Remote jack (CI-V) information .... 78</li> </ul> <p><b>14 SPECIFICATIONS</b> ..... 80</p> <p><b>15 OPTIONS</b> ..... 81</p>
---	---	--

## SUPPLIED ACCESSORIES

The transceiver comes with the following accessories.

	Qty.
① DC power cable (OPC-657A) .....	1
② Hand microphone (HM-12) .....	1
③ Spare fuses (FGB 30 A) .....	2
④ Spare fuse (FGB 4 A) .....	1

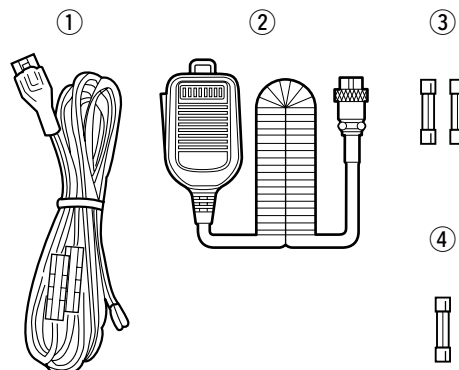

## ■ Front panel

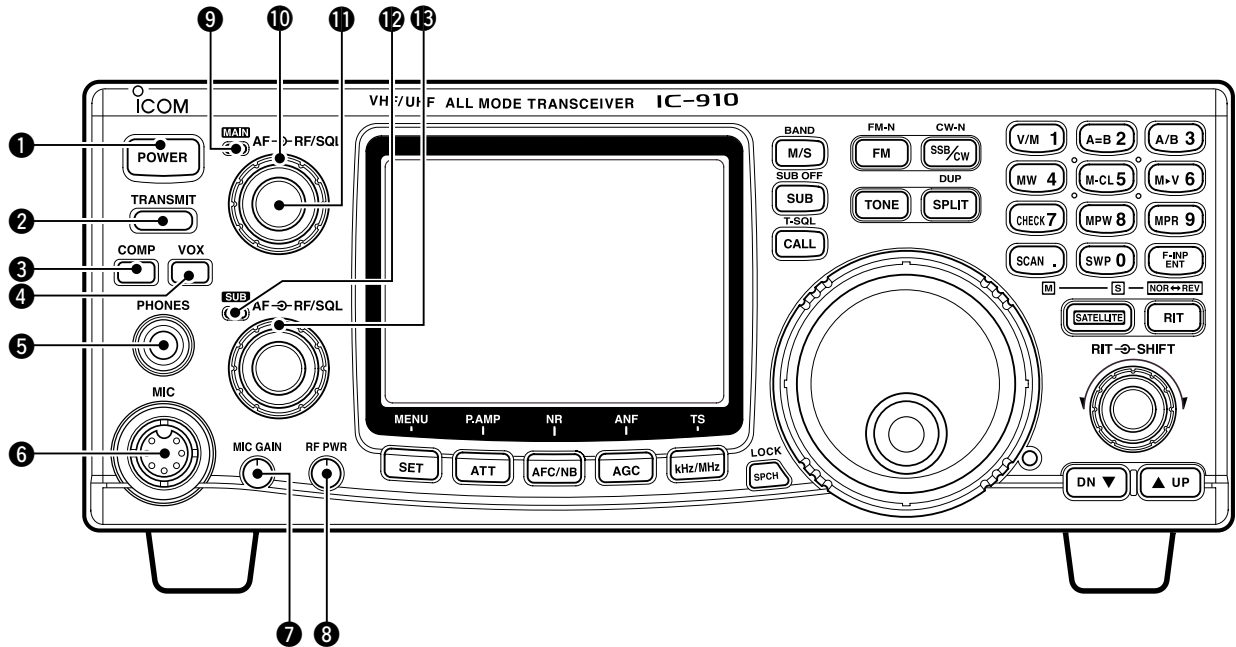

### 1 POWER SWITCH [POWER]

- ➔ Push momentarily to turn power ON.
- ➔ Push for 2 sec. to turn power OFF.

### 2 TRANSMIT SWITCH [TRANSMIT]

Push to select transmitting or receiving.

### 3 COMPRESSION SWITCH [COMP] (p. 36)

Push to switch the speech compressor function ON and OFF.

- The speech compressor increases average RF output power, improving signal strength and readability in SSB.

### 4 VOX SWITCH [VOX] (p. 33)

Push to switch the VOX function ON and OFF.

- The VOX (Voice-Operated Transmission) function toggles between transmit and receive with your voice. This function provides an opportunity to input log entries into your computer, etc., while operating.

### 5 HEADPHONE JACK [PHONES]

Accepts headphones.

- Output power: 5 mW with 8–16 Ω load.
- When headphones are connected, the internal speaker or connected external speaker does not function.
- The MAIN and SUB band audio can be mixed or separated when using stereo headphones according to set mode settings. (p. 57)

### 6 MICROPHONE CONNECTOR [MIC]

Accepts the supplied or optional microphone.

- See p. 81 for appropriate microphones.
- See p. 15 for microphone connector information.

### 7 MIC GAIN CONTROL [MIC GAIN]

Adjusts microphone input gain.

Recommended level for  
an Icom microphone

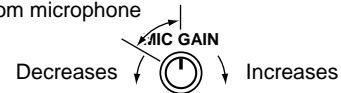

### ✓ How to set the microphone gain.

Set the [MIC] control so that the [MAIN]/[SUB] indicator (ALC indicator) some times lights brighter during normal voice transmission in SSB mode.

### 8 RF POWER CONTROL [RF PWR]

Continuously varies the RF output power from minimum to maximum.

144 MHz band	5–100 W
430(440) MHz band	5–75 W
1200 MHz band	1–10 W (optional UX-910)



**9 MAIN BAND INDICATOR [MAIN]**

- ➔ Lights green while the squelch is opened or a signal is received on the MAIN band; lights red while transmitting on the MAIN band.
  - While transmitting, the indicator also shows ALC condition. Brightness increases more than usual when the ALC function is activated.
- ➔ Flashes when an off-frequency signal is received and the FM center detector is activated. (p. 28)

**10 RF GAIN CONTROL/SQUELCH CONTROL [RF/SQL] (outer control)**

Adjusts the RF gain and squelch threshold level for the MAIN band. The squelch removes noise output from the speaker (closed condition) when no signal is received.

- The squelch is particularly effective for FM. It is also available for other modes.
- 12 to 13 o'clock position is recommended for any setting of the [RF/SQL] control.
- The squelch threshold position for SSB/CW mode can be set from 12 or 13 o'clock position in SSB/CW set mode. (p. 62)
- The control can be set as 'Auto' (RF gain control in SSB and CW; squelch control in FM) or squelch control (RF gain is fixed at maximum) in set mode as follows. (p. 56)

MODE	SET MODE SETTING		
	AUTO	SQL	RF GAIN + SQL
SSB, CW	RF GAIN	SQL	RF GAIN + SQL
FM	SQL	SQL	SQL

**•When setting as RF gain/squelch control**

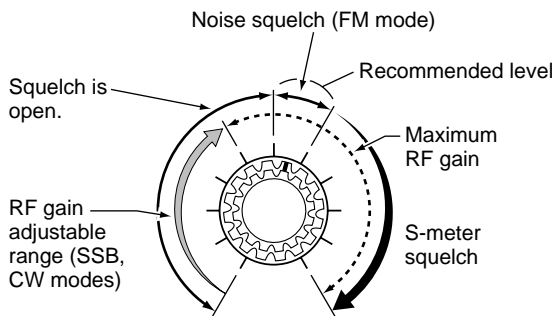

**•When functioning as RF gain control (Squelch is fixed open; SSB, CW only)**

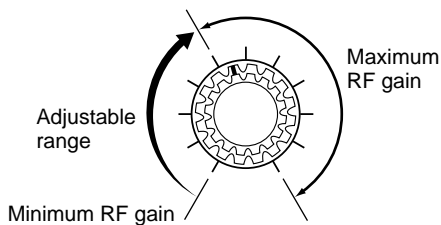

**•When functioning as squelch control (RF gain is fixed at maximum.)**

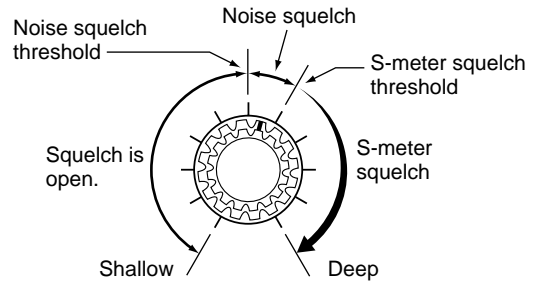

**11 AF CONTROL [AF] (inner control)**

Varies the audio output level from the speaker for the MAIN band.

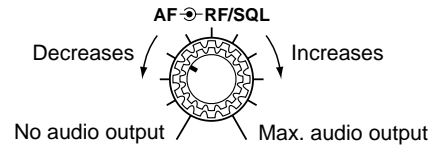

**12 SUB BAND INDICATOR [SUB]**

Lights green while the squelch is opened or a signal is received on the SUB band; lights red while transmitting in satellite operation.

**13 RF GAIN CONTROL/SQUELCH CONTROL [RF/SQL] (outer control)**

Adjusts the RF gain and squelch threshold level for the SUB band. The squelch removes noise output from the speaker (closed condition) when no signal is received.

■ Front panel (continued)

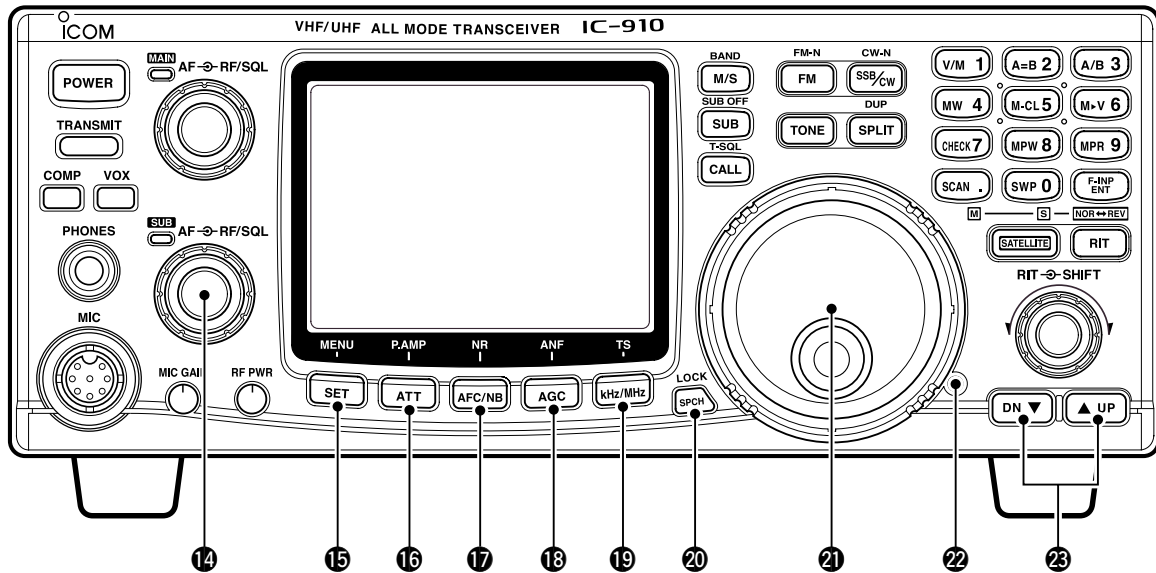

**14 AF CONTROL [AF]** (inner control)  
 Varies the audio output level from the speaker for the SUB band.

**15 SET•MENU SWITCH [SET•MENU]** (p. 55)

- ➔ Push this switch then one of [FM], [SSB/CW], [RIT], [SCAN], [NR], [TRANSMIT], [COMP], [VOX], [ATT], [SWP], [MPW] or [SPCH] to enter the independent item set mode.
- ➔ Push for 1 sec. to enter the set mode for commonly used item settings.



For 1 sec.

**16 ATTENUATOR•PRE-AMP SWITCH [ATT•P.AMP]**

- ➔ Push to switch the attenuator function ON and OFF. (p. 29) Use this function to protect from signal distortion from excessively strong signals.
- The attenuation level is independently adjustable for 144 MHz or 430(440) MHz band in the ATT set mode. The optional 1200 MHz band attenuation level is fixed and is approx. 20 dB. (p. 65)



For 1 sec.

- ➔ Push for 1 sec. to switch the connected pre-amplifier ON and OFF, when an optional pre-amplifier unit, AG-25, AG-35 and/or AG-1200, is connected. (p. 16)

**DO NOT** connect any equipment, such as an SWR or power meter between the transceiver and preamplifier. In such case, the preamplifier may not activate properly.

**17 AUTO FREQUENCY CONTROL/NOISE BLANKER•NOISE REDUCTION SWITCH [AFC/NB•NR]**



For 1 sec.

- ➔ During FM/FM narrow mode operation, push to switch the AFC (Automatic Frequency Control) function ON and OFF. (p. 28)
  - Automatically tunes the operating frequency, when an off-frequency signal is received, in 100 kHz steps. This function also follows the signal even if the frequency is shifted.
- ➔ During SSB or CW mode operation, push to switch the noise blanker function ON and OFF. (p. 30)
  - Reduces pulse-type noise, such as ignition noise from a vehicle.
- ➔ Push for 1 sec. to switch the noise reduction function ON and OFF when an optional DSP unit, UT-106, is installed. (p. 31)
  - Reduces unwanted noise and pulls out the desired signal only for clear readability.

**18 AUTO GAIN CONTROL•AUTO NOTCH FILTER SWITCH [AGC•ANF]**



- ➔ Push to switch the time constant of the automatic gain control to SLOW and FAST for the MAIN band.\* (p. 28)
  - SLOW selection (“FAGC” disappears) during SSB (USB or LSB) operation, FAST selection (“FAGC” appears) during CW, data operation and while tuning with fast tuning dial rotation are recommended.

\*The AGC time constant can be selected on the MAIN band only. FAST selection is fixed on the SUB band.



For 1 sec.

- ➔ Push for 1 sec. to switch the automatic notch filter function ON and OFF when the optional DSP unit, UT-106, is installed. (p. 31)
  - Reduces interference signals such as beat, RTTY or CW signals and the notch frequency automatically follows the interfering signal.

**19 kHz/MHz•TUNING STEP SELECTION SWITCH [kHz/MHz] (p. 22)**



- ➔ Push to select tuning step for the tuning dial or scanning from 1 kHz, 1 MHz step and regular tuning step\* in sequence
  - “▼” appears above the 1 kHz or 1 MHz digit when 1 kHz or 1 MHz tuning step is selected, respectively.

\*The regular tuning step is selected for each operating mode as follows.



For 1 sec.

- ➔ Push for 1 sec. to enter the regular tuning step selection mode.
  - The tuning step can be selected for each operating mode independently.
  - SSB/CW mode: 1, 10, 50 and 100 Hz step; FM mode: 0.1, 5, 6.25, 10, 12.5, 20, 25 and 100 kHz step can be selected by rotating the tuning dial.

**20 SPEECH•LOCK SWITCH [SPCH•LOCK]**



- ➔ Announces the receiving signal strength and/or selected readout frequency when the optional UT-102 is installed. (pgs. 69, 71)



For 1 sec.

- ➔ Push for 1 sec. to switch the tuning dial lock function ON and OFF to prevent accidental setting changes. (p. 25)

**21 TUNING DIAL**

Changes the displayed frequency, selects set mode items, etc.

**22 BRAKE ADJUSTMENT SCREW**

- Adjust the tension of the tuning dial.
  - Rotate clockwise to increase the tension; counterclockwise to decrease the tension.

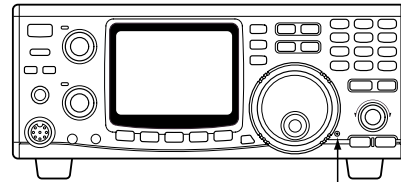

Brake adjustment screw

**23 MEMORY CHANNEL UP/DOWN SWITCHES [▲ UP]/[DOWN ▼] (p. 40)**



OR



- ➔ Push [▲ UP] to change the memory channel up; push [DOWN ▼] to change the memory channel down.
  - Memory channel changes continuously while holding either switch.
  - Memory channels can be selected both in VFO and memory modes.



OR



For 1 sec.

■ Front panel (continued)

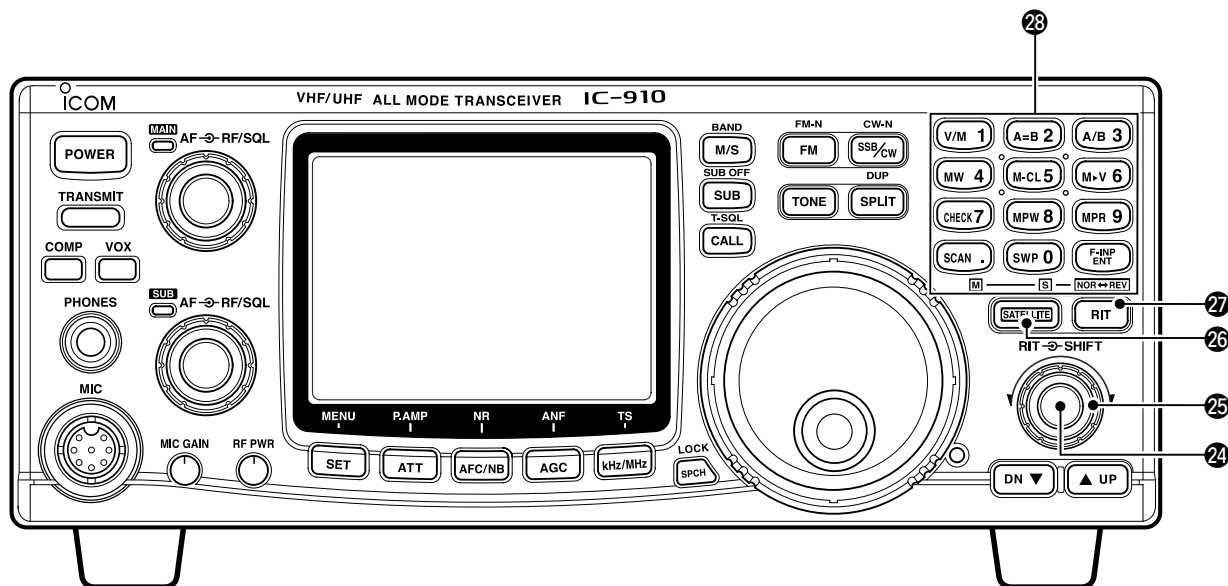

24 RIT CONTROL [RIT] (p. 27)

Shifts the receive frequency without changing the transmit frequency for the MAIN band only while the RIT function is activated.

- SSB/CW mode :  $\pm 1.0$  kHz\* in 10 Hz step
- FM mode :  $\pm 5.0$  kHz\* in 50 Hz step

\*For 1200 MHz band;  $\pm 2.0$  kHz and  $\pm 10.0$  kHz, respectively when the optional UX-910 is installed.

•By using the Sub dial function, the RIT control can be used as the MAIN/SUB tuning dial or the SUB band IF shift control. See page 24 for details.

25 IF SHIFT CONTROL [SHIFT]

Shifts the center frequency of the receiver's IF pass-band within 1.2 kHz range.

- By using the Sub dial function, the IF shift control can be used as the MAIN/SUB tuning dial or the SUB band IF shift control. See page 24 for details.

✓ What is the Sub dial function?

The [RIT] and [SHIFT] controls are used for RIT and IF shift controls for the MAIN band by default. However, the Sub dial function assigns these controls as the MAIN/SUB tuning dial or the SUB band IF shift control. (p. 24, 68)

26 SATELLITE SWITCH [SATELLITE]

 ➔ Push to enter satellite mode (RX on MAIN, TX on SUB band). Push again to return to the condition before entering into the satellite mode.

 ➔ Push to enter satellite mode using the current operating frequencies when pushing for 1 sec.

For 1 sec.

 For 1 sec.

- To change the normal and reverse satellite operations, push [F-INP/ENT] for 1 sec.

27 RIT SWITCH [RIT] (p. 27)

 ➔ Push to switch the RIT control activity ON and OFF.

- "RIT" indicator appears when the RIT function is in use.

 ➔ Push for 1 sec. to switch the Sub dial function ON and OFF.

For 1 sec.







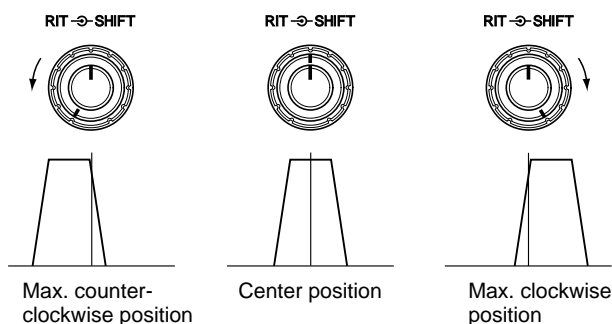





- "RIT" indicator flashes and the [RIT] and [SHIFT] controllers acts as the controllers specified in the RIT/SHIFT set mode. (p. 68)

28 KEYPAD

Numeral and other function keys for tuning and activating functions. See the table at right.





Switch	Switch action when pushed	Switch action when pushed for 1 sec.
	<ul style="list-style-type: none"> <li>•Enters numeral "1" when entering an operating frequency. (p. 23)</li> <li>•Switches between VFO and memory mode. (p. 40)</li> </ul>	
	Enters numeral "2" when entering an operating frequency. (p. 23)	Equalizes the condition of the VFO A and B. (p. 21)
	<ul style="list-style-type: none"> <li>•Enters numeral "3" when entering an operating frequency. (p. 23)</li> <li>•Switches between VFO A and B during VFO mode operation. (p. 21)</li> </ul>	Shows 10 Hz and 1 Hz digits of operating frequency on both the MAIN and SUB bands while pushing and holding. (p. 22)
	Enters numeral "4" when entering an operating frequency. (p. 23)	Stores the set conditions into a memory channel. (p. 41)
	Enters numeral "5" when entering an operating frequency. (p. 23)	Clears stored contents of memory channel to be a blank channel. (p. 43)
	Enters numeral "6" when entering an operating frequency. (p. 23)	Transfers the contents of a memory channel into either the VFO A or B. (p. 42)
	Enters numeral "7" when entering an operating frequency. (p. 23)	Opens squelch for monitoring the operating or transmit frequency, and the frequency indication automatically changes to transmit frequency in the case of duplex or split operation. (p. 34)
	<ul style="list-style-type: none"> <li>•Enters numeral "8" when entering an operating frequency. (p. 23)</li> <li>•Stores the displayed operating conditions into MEMO PAD channel (p. 44)</li> </ul>	
	<ul style="list-style-type: none"> <li>•Enters numeral "9" when entering an operating frequency. (p. 23)</li> <li>•Re-calls the contents in the MEMO PAD channel. (p. 44)</li> </ul>	
	<ul style="list-style-type: none"> <li>•Enters decimal point "." for entering below the "MHz" digits when entering an operating frequency.</li> <li>•Starts and cancels scanning function. (p. 46)</li> <li>•Turns OFF the SUB band frequency indication during satellite operation. In this case, only the MAIN band frequency can be tuned by rotating the tuning dial. (p. 49)</li> </ul>	Starts and cancels tone scan when the repeater tone or tone squelch is activated in FM (narrow) operation. (p. 47)
	<ul style="list-style-type: none"> <li>•Enters numeral "0" when entering an operating frequency. (p. 23)</li> <li>•Switches sweep function for the bandscope ON and OFF. (p. 29)</li> <li>•Turns OFF the MAIN band frequency indication during satellite operation. In this case, only the SUB band frequency can be tuned by rotating the tuning dial. (p. 49)</li> </ul>	
	Enables operating frequency entering from the keypad. See page 23 for details.	Used to change memory channel during memory mode operation by rotating the tuning dial while pushing and holding. (p. 40)

■ Front panel (continued)

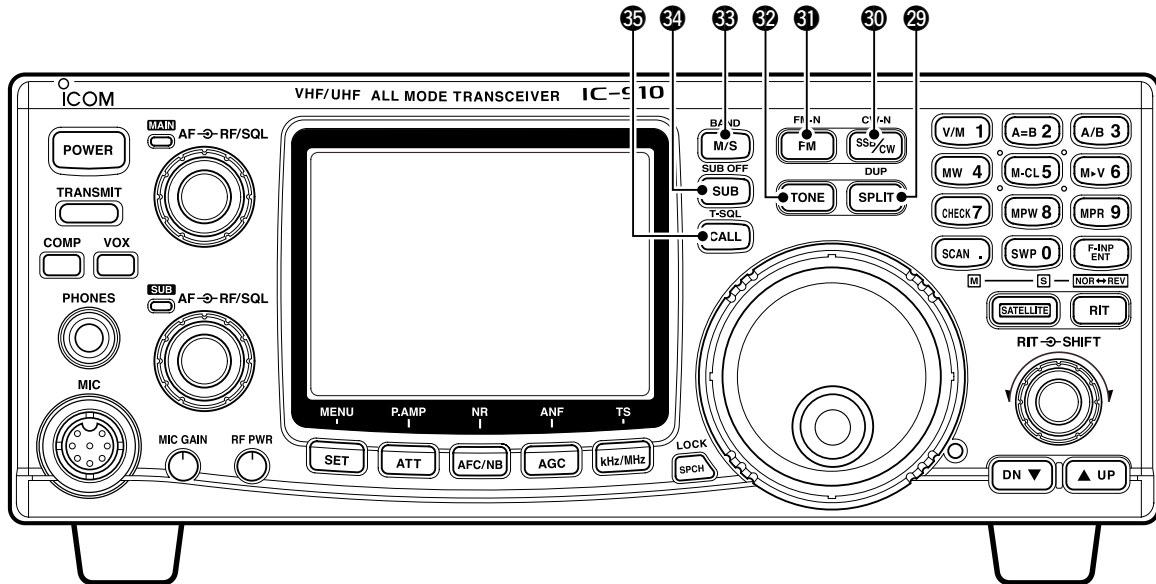

**29 SPLIT•DUPLEX SWITCH [SPLIT•DUP]**



➔ Push to turn the split function, with the VFO A and B, ON and OFF. (p. 37)  
 •The split operation is not available for the SUB band.



For 1 sec.

➔ Push for 1 sec. to select the duplex (repeater) direction or to turn the function OFF. (p. 34)  
 •The duplex operation is not available for the SUB band.

**30 SSB/CW•CW-NARROW SWITCH [SSB/CW•CW-N]**



➔ Push to switch the operating mode between SSB and CW. (p. 23)



For 1 sec.

➔ Push for 1 sec. to switch the operating mode between USB and LSB or between CW and CW narrow during SSB or CW mode, respectively.

**31 FM•FM-NARROW SWITCH [FM•FM-N]** (p. 23)



➔ Push to switch the operating mode between FM and FM repeater mode.  
 •The duplex operation can be made in MAIN band only, it cannot be operated in SUB band.



For 1 sec.

➔ Push for 1 sec. to switch the operating mode between FM and FM-N (FM narrow).  
 •The FM-N mode cannot be selected in 1200 MHz band operation.

**32 TONE SWITCH [TONE]**



➔ Push to turn the tone encoder function ON and OFF in FM mode. (p. 31; except for European version)  
 •“T” indicator appears in the display when the tone encoder is activated.  
 ➔ Push to transmit a 1750 Hz repeater tone in FM mode for European version.

**Available repeater tones** (Unit: Hz)

67.0	85.4	107.2	136.5	165.5	186.2	210.7	254.1
69.3	88.5	110.9	141.3	167.9	189.9	218.1	
71.9	91.5	114.8	146.2	171.3	192.8	225.7	
74.4	94.8	118.8	151.4	173.8	196.6	229.1	
77.0	97.4	123.0	156.7	177.3	199.5	233.6	
79.7	100.0	127.3	159.8	179.9	203.5	241.8	
82.5	103.5	131.8	162.2	183.5	206.5	250.3	

**33 MAIN/SUB CHANGE•BAND SWITCH [M/S•BAND]**



➔ Push to replace the MAIN band's frequency and mode with the SUB band's. (p. 19)



For 1 sec.

➔ Push for 1 sec. to change the operating band during single band operation or when the optional band unit, UX-910, is installed. (p. 20)

**34 SUB•SUB OFF SWITCH [SUB•SUB OFF]**



➔ Push to enable the SUB band control from the tuning dial, keypad, etc. (p. 19)  
 •“SUB” indicator appears.



➔ Push for 1 sec. to turn the SUB band readout indication ON and OFF. (p. 24)

For 1 sec.

**35 CALL•TONE SQUELCH SWITCH [CALL•T-SQL]**



➔ Push to select the call channel of the operating band. The call channel can be selected from both the VFO and memory mode operation. (p. 43)



➔ Push for 1 sec. to turn the tone squelch function ON and OFF during FM mode operation. (p. 30)

For 1 sec.

•“T-SQL” indicator appears when the tone squelch is activated.

## ■ Function display

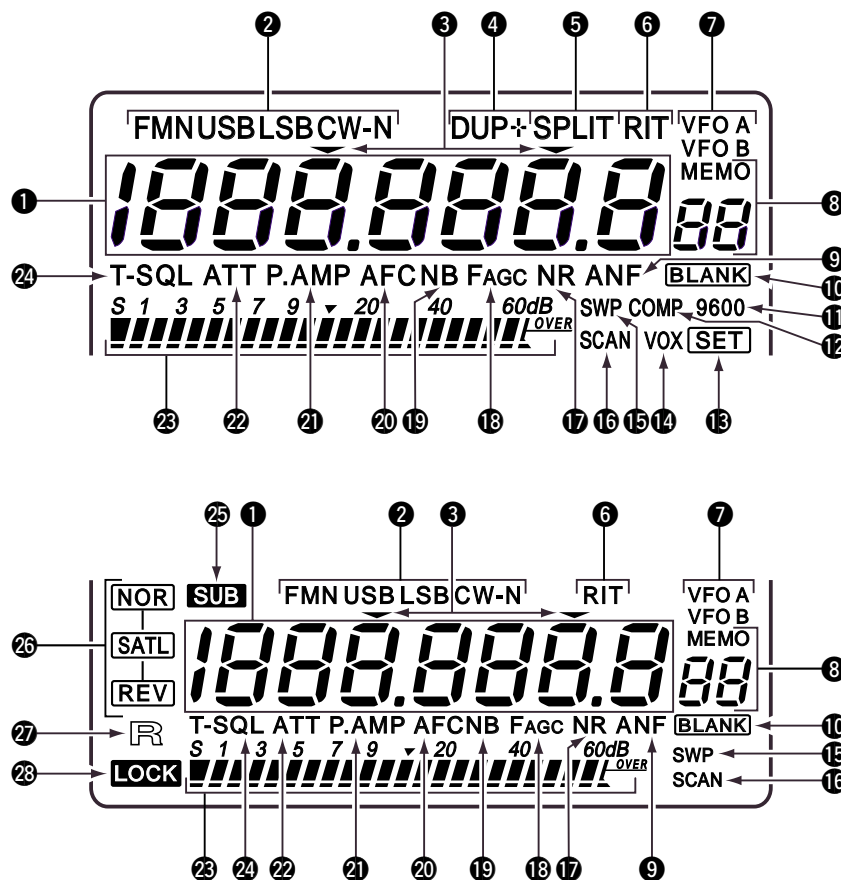

- 1 FREQUENCY READOUTS** (p. 22)  
Shows the operating frequency.  
• Setting item name is indicated during set mode. (p. 55)
- 2 MODE INDICATOR** (p. 23)  
Shows the selected operation mode.
- 3 TUNING STEP INDICATOR** (p. 22)  
Appears when the 1 kHz or 1 MHz tuning step is selected.
- 4 DUPLEX INDICATOR** (p. 34)  
Either “DUP–” or “DUP+” appears during duplex (repeater) operation.
- 5 SPLIT INDICATOR** (p. 37)  
Appears during split operation.
- 6 RIT INDICATOR** (p. 27)  
➔ Appears while the RIT function is activated.  
➔ Flashes while the SUB dial function is activated.
- 7 VFO INDICATOR** (p. 21)  
Either VFO A or VFO B appears during VFO operation.

- 8 MEMORY MODE INDICATORS/MEMORY CHANNEL NUMBER READOUTS** (p. 40)  
The memory mode indicator appears during memory mode operation and the memory channel number readout shows the selected memory channel number during both the memory and VFO mode operation.

### ✓ *Memory channel number readout*

In addition to the memory channel number indication, the memory channel number readout indicates 10 Hz and 1 Hz digits of operating frequency while rotating the tuning dial in SSB or CW mode with 10 or 1 Hz tuning step. After 2 sec. from tuning dial operation, the readout indicates the memory channel number.

- 9 AUTO NOTCH FILTER INDICATOR** (p. 31)  
Appears when the optional DSP unit, UT-106, is installed, and the ANF (Automatic Notch Filter) function is activated.
- 10 BLANK INDICATOR** (p. 42)  
Appears when the selected memory channel has not been programmed or has been cleared.

- 11 DATA TRANSMISSION SPEED INDICATOR** (p. 52)  
Appears when 9600 bps speed is selected for packet transmission.
- 12 SPEECH COMPRESSOR INDICATOR** (p. 36)  
Appears when the speech compressor is activated.
- 13 SET INDICATOR** (p. 55)  
Appears when [SET] is pushed.  
Disappears after any switch is pushed.
- 14 VOX INDICATOR** (p. 33)  
Appears when the VOX function is activated.
- 15 SWEEP INDICATOR** (p. 29)  
Flashes while the simple bandscope function is activated.
- 16 SCAN INDICATOR** (p. 46)  
Flashes while scanning.
- 17 NOISE REDUCTION INDICATOR** (p. 31)  
Appears when the optional DSP unit, UT-106, is installed and the noise reduction is activated.
- 18 AGC TIME CONSTANT INDICATOR** (p. 28)  
Appears when the FAST AGC time constant is selected; disappears when the SLOW AGC time constant is selected.
- 19 NOISE BLANKER INDICATOR** (p. 30)  
Appears when the noise blanker function is activated.
- 20 AUTO FREQUENCY CONTROL INDICATOR** (p. 28)  
Appears when the AFC (Automatic Frequency Control) function is activated.
- 21 PRE-AMP INDICATOR** (p. 16)  
Appears when the optional pre-amplifier unit, AG-25, AG-35 and/or AG-1200, is connected and the pre-amplifier function is activated.
- 22 ATTENUATOR INDICATOR** (p. 29)  
Appears when the attenuator is activated.
- 23 MULTI-FUNCTION BAR METER**
- ➔ Shows the receiving signal strength as an S-meter while receiving. Peak hold function is available and can be switched ON and OFF in regular set mode. (pgs. 26, 56)
  - ➔ Shows the relative transmit output power level as an RF power indicator during transmit. (p. 32)
  - ➔ Shows signal availability in the sweeping band, and the “▼” indicator indicates the center of the sweeping frequency band.
- 24 TONE SQUELCH INDICATOR** (pgs. 30, 34)  
“T” appears when the tone encoder function is activated; “T-SQL” appears when the tone squelch function is activated.
- 25 SUB INDICATOR** (p. 19)  
Appears when the SUB band access is enabled.
- 26 SATELLITE INDICATOR** (p. 49)  
Appears while satellite operation mode is selected.
- **SATL** - **NOR** : Satellite operation with normal mode is selected.
  - **SATL** - **REV** : Satellite operation with reverse mode is selected.
- 27 REMOTE INDICATOR** (p. 78)  
Appears when the transceiver is controlled remotely via the optional CI-V level converter, CT-17.
- 28 LOCK INDICATOR** (p. 25)  
Appears when the dial lock function is activated.

■ Rear panel

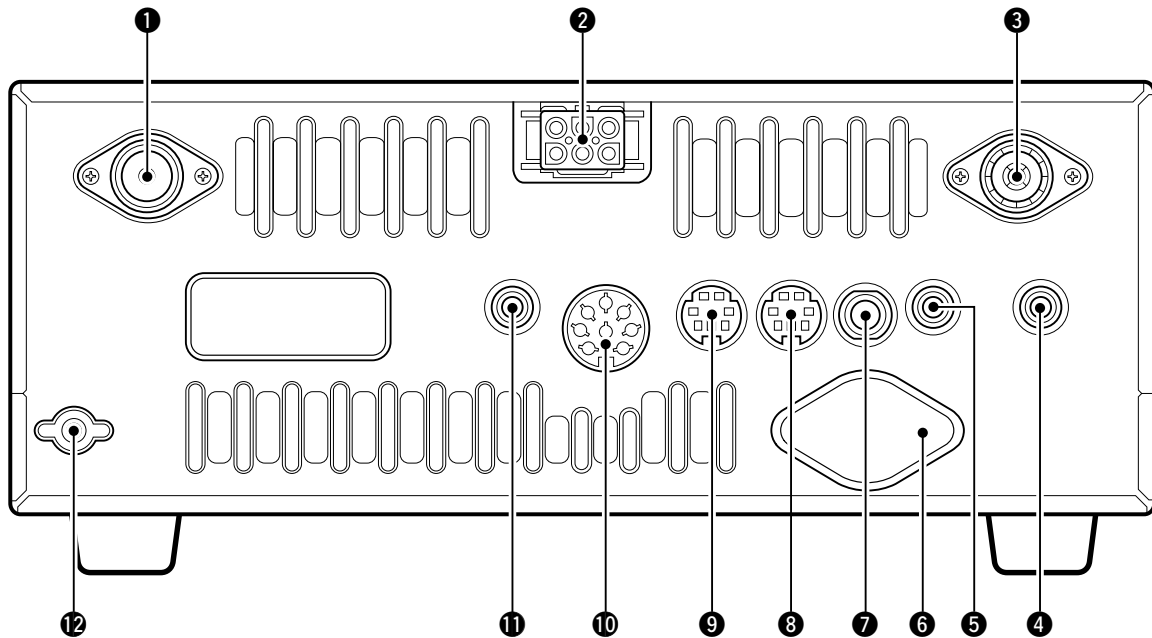

**1 430(440) MHz ANTENNA CONNECTOR** (p. 15)  
Accepts a 50 Ω antenna with a type-N connector.

**2 DC POWER SOCKET [DC 13.8V]** (p. 17)  
Accepts 13.8 V DC through the supplied DC power cable (OPC-657A).

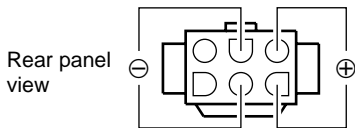

**7 KEY JACK [KEY]** (p. 15)  
Accepts a paddle, a straight key or external electronic keyer with 1/8 inch standard plug.

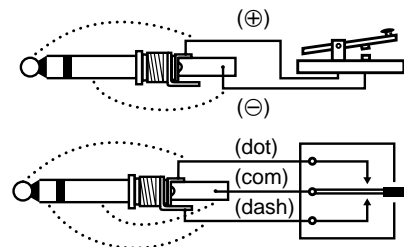

**3 144 MHz ANTENNA CONNECTOR** (p. 15)  
Accept a 50 Ω antenna with a PL-259 connector.

**4 SUB BAND EXTERNAL SPEAKER JACK [SP (SUB)]**

**5 MAIN BAND EXTERNAL SPEAKER JACK [SP (MAIN)]** (p. 16)

Accepts a 4–8 Ω speaker.  
By connecting an external speaker for each or both jacks, the audio for both the MAIN and SUB bands is output as follows.

	MAIN AF	SUB AF
<b>No</b>	Int. SP	Int. SP
<b>SP (MAIN)</b>	Ext. SP	Ext. SP
<b>SP (SUB)</b>	Int. SP	Ext. SP
<b>Both</b>	Ext. SP (MAIN)	Ext. SP (SUB)

**8 SUB BAND DATA SOCKET [DATA (SUB)]**  
**9 MAIN BAND DATA SOCKET [DATA (MAIN)]**

(p. 13)  
6-pin mini plug DIN jack to connect a TNC, etc. for high speed data communications.  
Simultaneous data communications are provided by equipping independent data sockets for both MAIN and SUB bands.

**10 ACCESSORY SOCKET [ACC(1)]**  
Enables connection of external equipment such as a TNC for data communications, etc.  
•See the right table for socket information.

**11 CI-V REMOTE CONTROL JACK [REMOTE]** (p. 78)  
Designed for use with a personal computer via the optional CT-17 for remote control of transceiver functions.

**6 1200 MHz ANTENNA CONNECTOR** (p. 15)  
Available when the optional 1200 MHz band unit is installed. Accepts a 50 Ω antenna with a type-N connector.

**12 GROUND TERMINAL [GND]** (p. 14)  
Connect this terminal to a ground to prevent electrical shocks and other problems.

◇ ACC SOCKETS

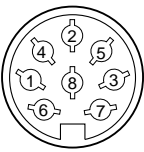
ACC(1) Socket	Pin No.	Pin Name	Description	Specification
	1	NC	No connection.	
	2	GND	Connect to ground.	
	3	SEND	Input terminal to transmit the transceiver in relation to the external equipment. (Grounded: transmits)	Transmit voltage : -0.5 to +0.8 V Output current : Less than 20 mA Input current (Tx) : Less than 200 mA
	4	MOD	Input terminal for the modulation circuit.	Output impedance : 10 kΩ Input level : 100 mV rms
	5	AF	Output terminal for AF signals from the AF detector circuit. Output level is fixed, regardless of [AF] control.	Output impedance : 4.7 kΩ Output level : 100–300 mV rms
	6	SQLS	Output terminal for squelch condition (Open/Close). Outputs grounded level signal when squelch is opened.	Squelch open : Less than 0.3 V/5 mA Squelch close : More than 6.0 V/100 μA
	7	13.8 V	Output terminal for 13.8 V DC, in relation to the [POWER].	Output current : Less than 1 A
	8	ALC	Input terminal for ALC control.	Input impedance : More than 10 kΩ Control voltage : -4 to 0 V

◇ DATA SOCKETS

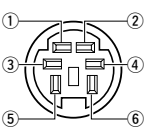
DATA Socket	Pin No.	Pin Name	Description
	1	DATA IN	Input terminal for data (common for both 1200 and 9600 bps)
	2	GND	Ground line for the DATA IN, DATA OUT and AF OUT.
	3	PTTP	Transmits when this terminal is grounded.
	4	DATA OUT	Received data output terminal for 9600 bps operation.
	5	AF OUT	Received data output terminal for 1200 bps operation.
	6	SQL	Output terminal for squelch condition (Open/Close). Outputs grounded level signal when squelch is opened, +8 V level signal when squelch is closed.

## ■ Unpacking

After unpacking, immediately report any damage to the delivering carrier or dealer. Keep the shipping cartons.

For a description and a diagram of accessory equipment included with the IC-910H, see 'Supplied accessories' on p. 1 of this manual.

## ■ Grounding

To prevent electrical shock, television interference (TVI), broadcast interference (BCI) and other problems, ground the transceiver through the GROUND terminal on the rear panel.

For best results, connect a heavy gauge wire or strap to a long earth-sunk copper rod. Make the distance between the [GND] terminal and ground as short as possible.

**⚠ WARNING: NEVER** connect the [GND] terminal to a gas or electric pipe, since the connection could cause an explosion or electric shock.

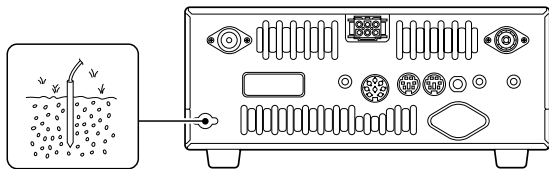

## ■ Selecting a location

Select a location for the transceiver that allows adequate air circulation, free from extreme heat, cold, or vibrations, and away from TV sets, TV antenna elements, radios and other electro-magnetic sources.

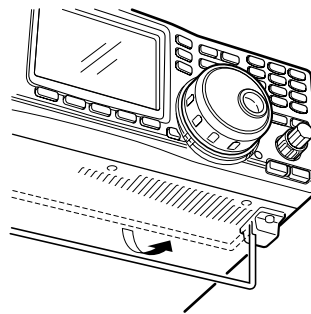

The base of the transceiver has an adjustable stand for desk-top use. Set the stand to depending on your operating conditions.

## ■ Antenna connection

For radio communications, the antenna is of critical importance, along with output power and sensitivity. Select antenna(s), such as a well-matched 50 Ω antenna, and feedline. 1.5:1 or better of Voltage Standing Wave Ratio (VSWR) is recommended for your desired band. Of course, the transmission line should be a coaxial cable.

**⚠ CAUTION:** Protect your transceiver from lightning by using a lightning arrester.

### PL-259 CONNECTOR INSTALLATION EXAMPLE

- ① Slide the coupling ring down. Strip the cable jacket and soft solder.
- ② Strip the cable as shown at left. Soft solder the center conductor.
- ③ Slide the connector body on and solder it.
- ④ Screw the coupling ring onto the connector body.

### TYPE-N CONNECTOR INSTALLATION EXAMPLE

- ① Slide the nut, rubber gasket and clamp over the coaxial cable, then cut the end of the cable evenly.
- ② Strip the cable and fold the braid back over the clamp.
- ③ Soft solder the center conductor. Install the center conductor pin and solder it.
- ④ Carefully slide the plug body into place aligning the center conductor pin on the cable. Tighten the nut onto the plug body.  
Be sure the center conductor is the same height as the plug body.

30 mm ≈ 9/8 in    10 mm ≈ 3/8 in    1-2 mm ≈ 1/16 in



## Required connections

### •Front panel

**HEADPHONES**

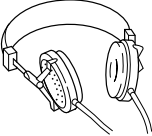

Input impedance:  
8–16 Ω  
Audio output power:  
5 mW with 8 Ω load  
Output power may differ  
according to the headphone

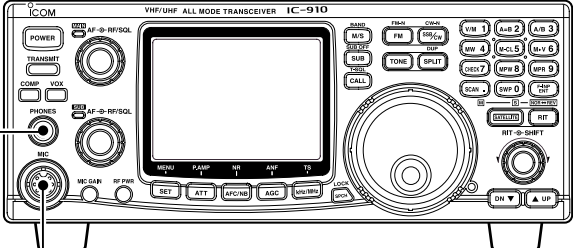

**HM-12 HAND MICROPHONE**



**SM-20 DESKTOP MICROPHONE (optional)**



**MICROPHONE CONNECTOR (Front panel view)**

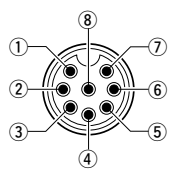

- ① MIC (Microphone input)
- ② +8V (Max. 8 V DC 10 mA)
- ③ MIC U/D (Frequency up/down)
- ④ SQL S (Squelch switch)
- ⑤ PTT
- ⑥ GND (PTT ground)
- ⑦ GND (Microphone ground)
- ⑧ AF OUT (varies with [AF])

**CAUTION: DO NOT** short pin 2 to ground as this can damage the internal 8 V regulator. DC voltage is applied to pin 1 for microphone operation. Take care when using a non-Icom microphone.

### •Rear panel

**[430(440)MHz ANT]**  
(p. 14)

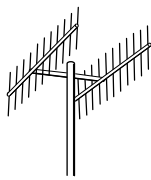

**DC POWER SUPPLY (p. 17)**

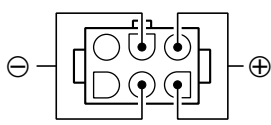

13.8 V DC  
More than 25 A

**[144MHz ANT]** (p. 14)

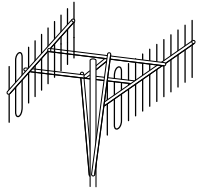

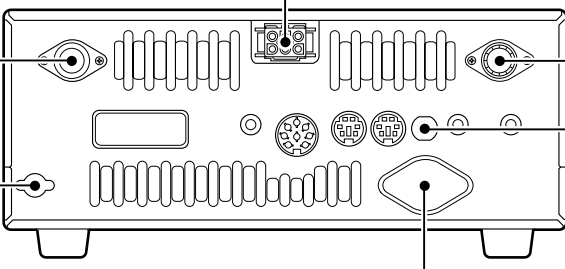

**GROUND (p. 14)**

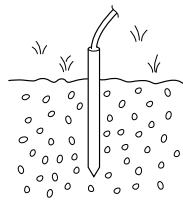

**[1200MHz ANT]** (p. 14)

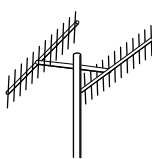

Required for optional UX-910 operation.

**[KEY] jack (p. 38)**

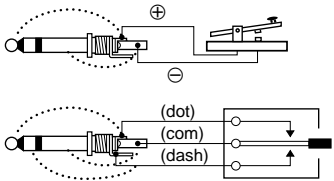

(dot)  
(com)  
(dash)

## ■ Advanced connections

### • Front panel

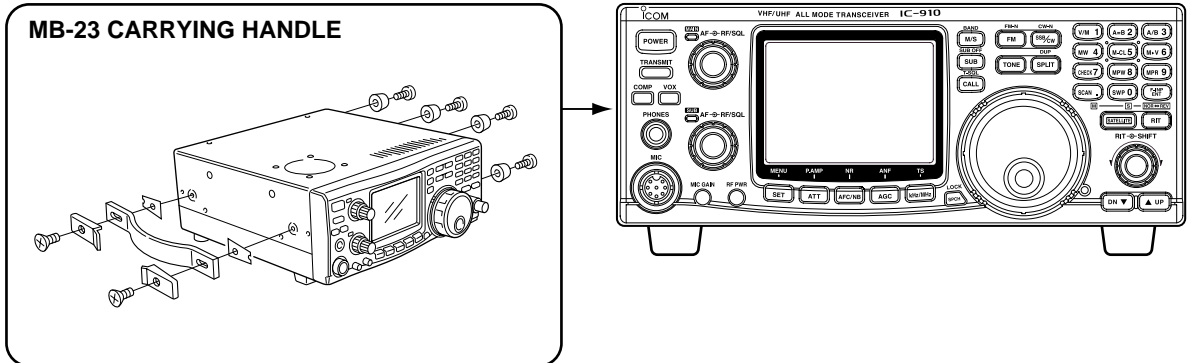

### • Rear panel

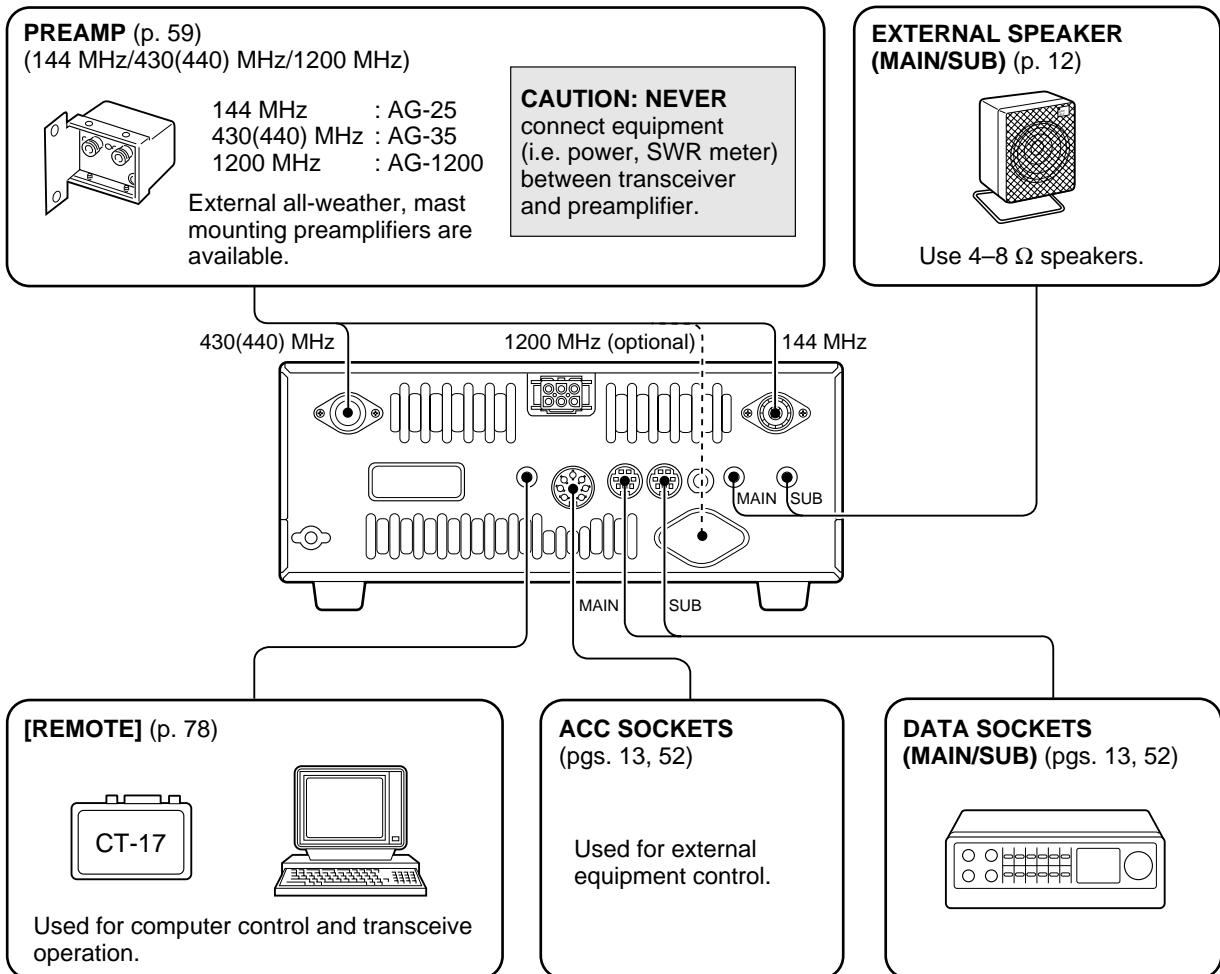

## ■ Power supply connections

Use an optional DC power supply with a 25 A capacity and above when operating the transceiver with AC power. Refer to the diagrams below.

**CAUTION:** Before connecting the DC power cable, check the following important items. Make sure:

- The [POWER] switch is OFF.
- Output voltage of the power source is 12–15 V when you use a non-Icom power supply.
- DC power cable polarity is correct.
  - Red : positive ⊕ terminal
  - Black : negative ⊖ terminal

### CONNECTING A DC POWER SUPPLY

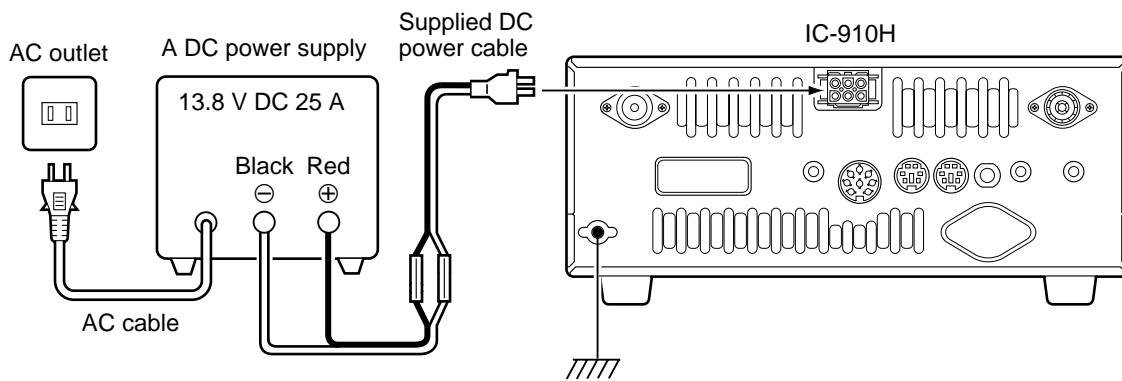

### CONNECTING A VEHICLE BATTERY

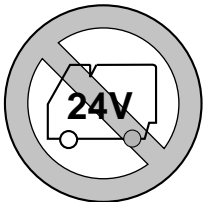

**NEVER connect to** a 24 V battery.



**NEVER use** the cigarette lighter socket as a power source.

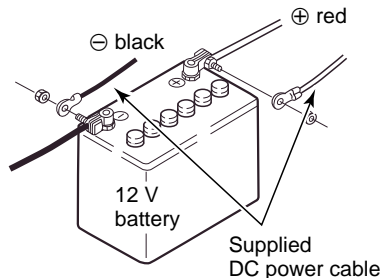
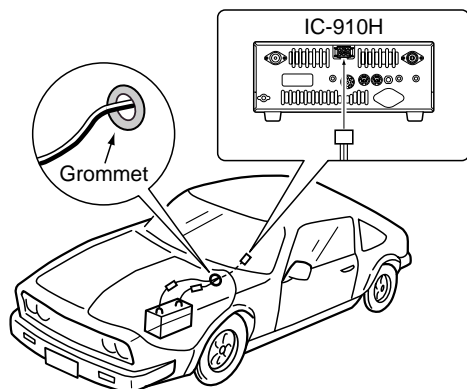

**NOTE:** Use terminals for the cable connections.

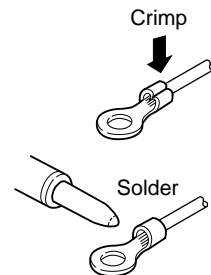

### ■ Initial settings

After resetting the transceiver, set controls and switches as shown in the figure below.

CCW : Max. counterclockwise

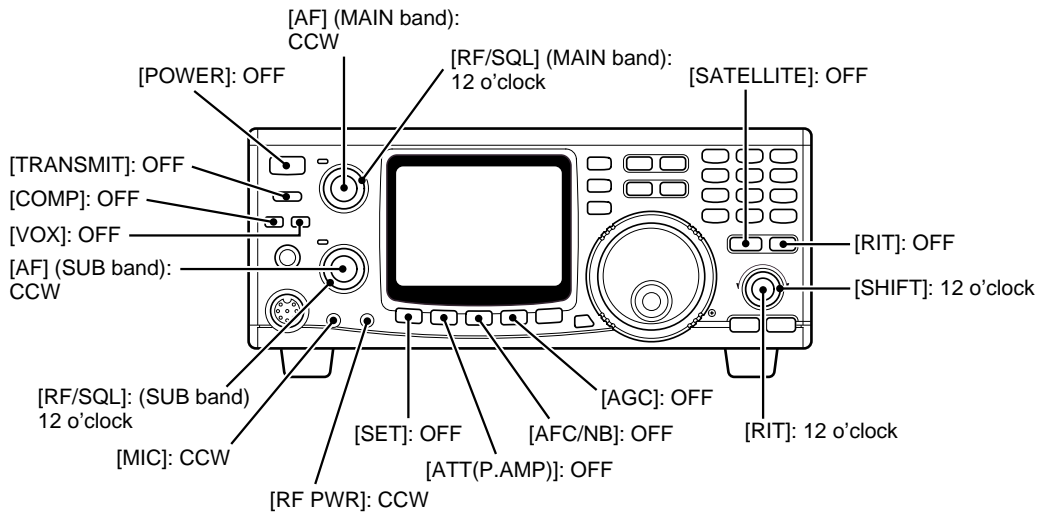

Turn power ON, then check the display. If any of the following indicators appear, turn them OFF as follows:

- Quick tuning step indicator “▼” : Push [kHz/MHz].
- RIT indicator “RIT” : Push [RIT].
- Split indicator “SPLIT” : Push [SPLIT].

### ■ When first applying power (CPU resetting)

Before first applying power, make sure all connections required for your system are complete by referring to Chapter 3. Then, reset the transceiver using the following procedure.

- ① Make sure the transceiver power is OFF.
- ② While pushing [MW 4] and [M-CL 5], push [POWER] to turn power ON.
  - The internal CPU is reset.
  - The transceiver displays its initial VFO frequencies when resetting is complete.

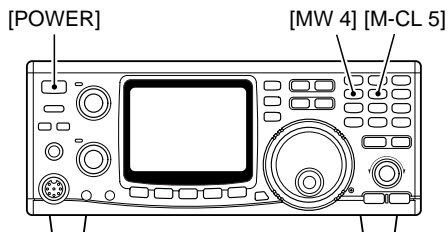
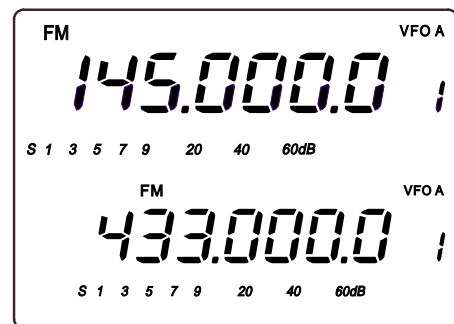

Resetting **CLEARs** all programmed contents in memory channels and returns programmed values in set mode to default values.

## ■ MAIN and SUB bands

The IC-910H has dual bands: 144 MHz and 430(440) MHz. These bands can be assigned to the MAIN and SUB bands for operating convenience.

Each MAIN and SUB bands have independent features.

The MAIN band is the operation for both transmit and receive, and is displayed in the upper area of the function display. The SUB band is the operation for only receive, and is displayed in the lower area of the function display.

- Simultaneous receive on both the MAIN and SUB bands is possible, however the transmission can only be transmitted on the MAIN band— not on the SUB band.
- In the case of satellite operation mode, the SUB band is used for the transmission band.

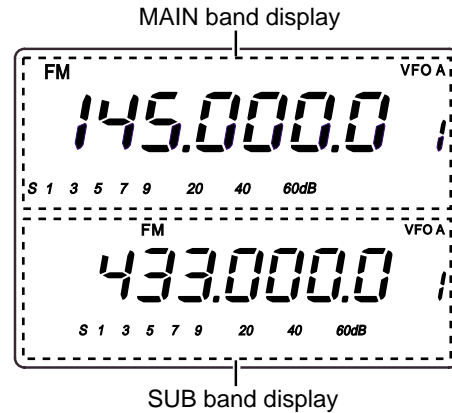

### ◇ Exchanging the MAIN and SUB bands

The function display shows both the MAIN and SUB band frequencies and both bands can receive signals simultaneously.

Assign 144 MHz or 430(440) MHz band, whichever band you want to transmit or be called on, as the MAIN band.

➔ Push [M/S] to exchange the MAIN and SUB bands.

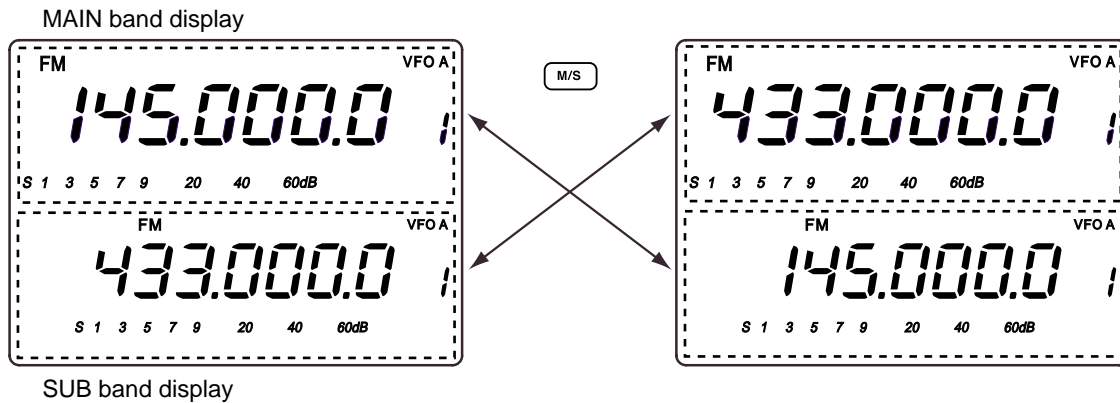

### ◇ Accessing the SUB band

Normally, any operations, such as tuning, operating mode selection, memory channel selection and programming, etc., are performed on the MAIN band. However, these operations can be performed on the SUB band by using the SUB band access capability.

➔ Push [SUB] to switch the SUB band access capability ON and OFF.

- “SUB” indicator appears while the SUB band access capability is activated.
- Even during SUB band access, transmission cannot be made on the SUB band.

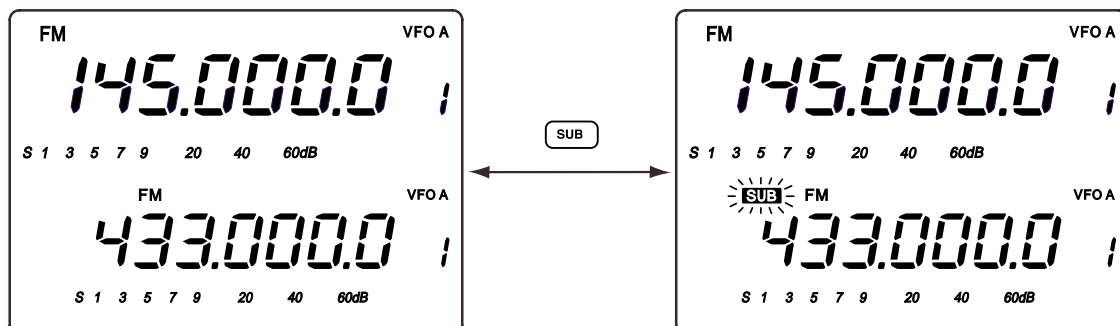

## 4 BASIC OPERATION

### ■ Operating band selection (optional UX-910 is required)

The IC-910H can be used on the additional 1200 MHz band with the optional UX-910. The operating band can be selected by pushing [M/S•BAND] for 1 sec.

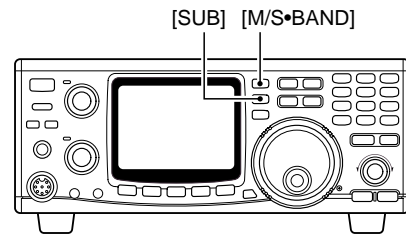

#### ◆ Selecting on the MAIN band

- ① Push [SUB] to cancel the SUB band access, if required.
- ② Push [M/S•BAND] for 1 sec. to select operating band.

**NOTE:** The same operating band cannot be assigned on both MAIN and SUB bands, simultaneously.

Select 1200 MHz to MAIN band.

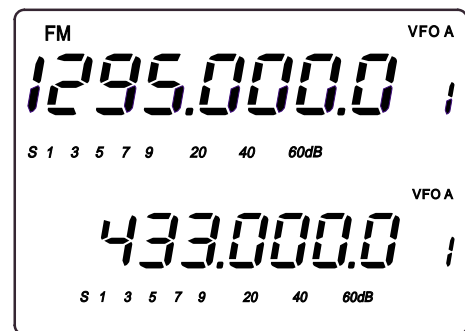

#### ◆ Selecting on the SUB band

- ① Push [SUB] to enable the SUB band access.
  - "SUB" indicator appears.
- ② Push [M/S•BAND] for 1 sec. to select operating band.

Select 1200 MHz to SUB band.

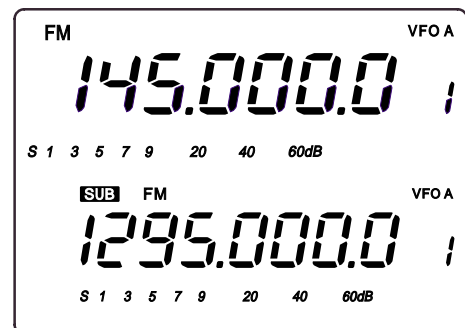

## ■ VFO description

The IC-910H has two VFOs for both bands, specially suited for instant selection of 2 frequencies or split frequency operation. The VFOs are called VFO A and VFO B. You can use the desired VFO to call up a frequency and operating mode for your operation.

VFO is an abbreviation of Variable Frequency Oscillator, and traditionally refers to an oscillator.

### ◇ Selecting the VFO A/B

➔ Push [A/B 3] to switch between the VFO A and VFO B.

### ◇ VFO equalization

➔ Push [A=B 2] for 1 sec. to equalize the undisplayed VFO condition to the displayed VFO.  
• 3 beeps sound when the VFO equalization is completed.

#### **CONVENIENT**

##### **Use two VFOs as a quick memory**

When you find a new station, but you wish to continue searching, the two VFO system can be used for quick memory storage.

- ① Push [A=B 2] for 1 sec. to store the displayed frequency into the undisplayed VFO.
- ② Continue searching for stations.
- ③ Push [A/B 3] to retrieve the stored frequency.
- ④ To continue searching for stations, push [A/B 3] again.

#### VFO selection

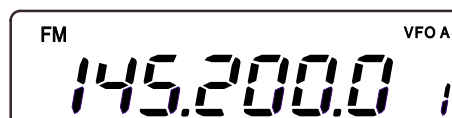

#### displayed VFO

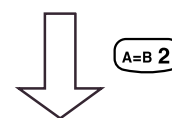

#### undisplayed VFO

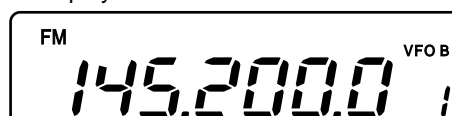

Equalizes the undisplayed VFO condition to the displayed VFO.

## 4 BASIC OPERATION

### ■ Frequency setting

The IC-910H has several tuning steps and a [kHz/MHz] switch for convenient frequency tuning.

- ① Push [M/S] to select the desired frequency band as the MAIN band; or push [SUB] to access the SUB band.
- ② Rotate the tuning dial to select the frequency.
  - The memory channel number changes to the 10 and 1 Hz digits when rotating the tuning dial with 1, 10, 100 Hz and 6.25 kHz tuning steps.
  - When you want to check the 10 and 1 Hz digits during memory channel number indication, push and hold [A/B] (10 and 1 Hz digits are indicated while holding).

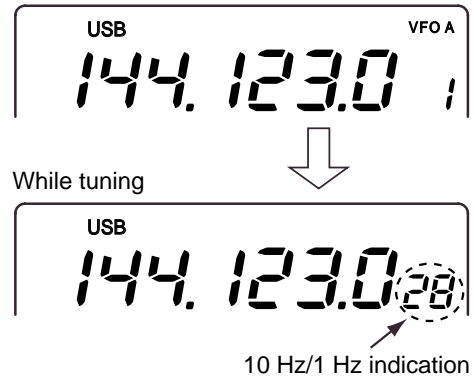

### ◇ Tuning step selection

Tuning steps can be pre-set independently for FM and SSB/CW. The following steps are selectable.

- FM : 0.1, 5, 6.25, 10, 12.5, 20, 25 or 100 kHz
- SSB/CW : 1, 10, 50 or 100 Hz

- ① Push [M/S] to select the desired frequency band as the MAIN band; or push [SUB] to access the SUB band.
- ② Push [FM] or [SSB/CW] to select the desired operation mode.
- ③ Push [kHz/MHz•TS] for 1 sec. to enter the tuning step set mode.
- ④ Rotate the tuning dial to select the desired tuning step.
- ⑤ Push [kHz/MHz•TS] to return to previous display.

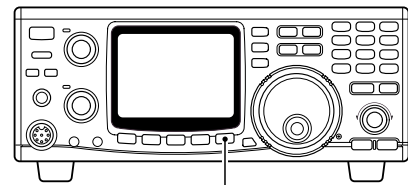

[kHz/MHz•TS] for 1 sec.

FM mode tuning step set mode

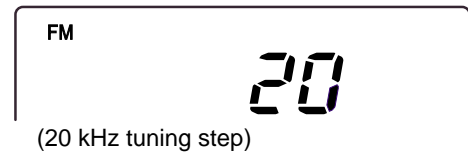

SSB/CW mode tuning step set mode



### ◇ Quick tuning step

The operating frequency can be changed in 1 kHz steps or 1 MHz steps for quick tuning.

- ➔ Push [kHz/MHz•TS] to switch the quick tuning step in sequence 1 kHz, 1 MHz and OFF.

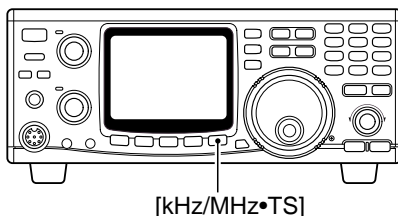

[kHz/MHz•TS]

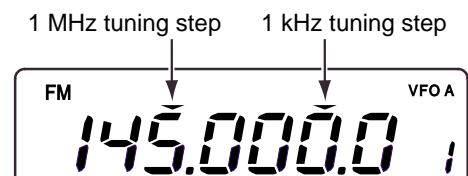



### ◆ Frequency setting with the keypad

The operating frequency can be directly entered from the keypad.

- ① Push [F-INP ENT] to access the keypad frequency entry.
  - All digits of frequency indication disappear.
- ② Push numeral keys to enter the desired operating frequency.
  - The entered number is indicated from the 100 Hz digit.
- ③ Push [F-INP ENT] to set the frequency.

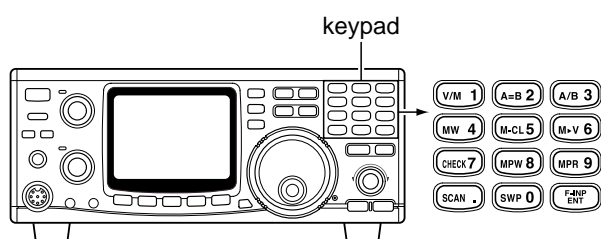

#### [EXAMPLE]

145.3400 MHz

[F-INP ENT] [1] [4] [5] [.] [3] [4] [F-INP]

435.0000 MHz

[F-INP ENT] [4] [3] [5] [.] [F-INP ENT]

439.1200 MHz

[F-INP ENT] [4] [3] [9] [.] [1] [2] [F-INP ENT]

439.1200 MHz to 439.2604 MHz

[F-INP ENT] [.] [2] [6] [0] [4] [F-INP ENT]

Pushing numeral keys to 100 Hz digit without pushing [.] also sets the desired operating frequency.

### ◆ Operating mode selection

SSB (USB/LSB), CW, CW-N (CW narrow), FM and FM-N (FM narrow) modes are available in the IC-910H. Select the desired operation mode as follows.

#### • Selecting SSB mode

- ➔ Push [SSB/CW] to select USB mode.
  - USB mode is generally used for SSB phone operation on the VHF and UHF bands.
  - Push [SSB/CW] for 1 sec. after USB mode selection to switch between USB and LSB mode.

#### • Selecting CW mode

- ➔ Push [SSB/CW] to select CW mode.
  - Push [SSB/CW] for 1 sec. after CW mode selection to switch between CW and CW narrow mode.

The optional CW narrow filter, FL-132 or FL-133, is required for the MAIN or SUB bands, respectively. In satellite operation, the optional FL-133 is necessary to operate CW narrow mode in the MAIN (receive) band. No audio is output until the optional CW narrow filter is installed in the CW narrow mode.

#### • Selecting FM mode

- ➔ Push [FM] to select FM mode.
  - Push [FM] after FM mode selection to turn the repeater mode (duplex negative with repeater tone ON) ON and OFF.
  - Push [FM] for 1 sec. after FM mode selection to switch between FM and FM narrow mode.

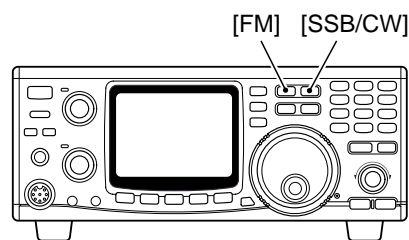

## 4 BASIC OPERATION

### ■ SUB band OFF

The SUB band indication can be deactivated to simplify operation.

- ➔ Push [SUB•SUB OFF] for 1 sec. to turn the SUB band indication ON and OFF.
  - Push [M/S•BAND] for 1 sec. to change the operating band. (p. 20)

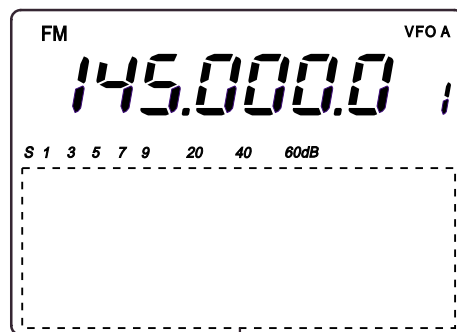
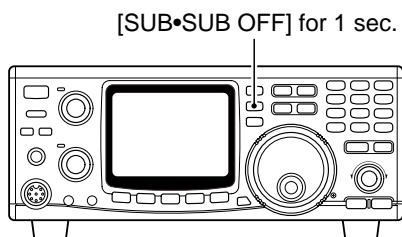

SUB band indication OFF.

### ■ SUB tuning dial

The IC-910H has a large main tuning dial for frequency setting. In addition, the [RIT] or [SHIFT] controls can be used as a SUB tuning dial for dual band simultaneous tuning, etc. The SUB tuning dial changes the operating frequency continuously at a variable speed.

To use the SUB tuning dial function, assign the function to either the [RIT] or [SHIFT] control using the RIT/SHIFT set mode.

▨ The assigned control can be used for its original function, however, both functions cannot be used simultaneously.

#### ◆ When the [RIT] control is assigned as SUB tuning dial

- ① Push [RIT] for 1 sec.
  - “RIT” indicator flashes when the SUB tuning dial function is activated.
- ② Rotate [RIT] control for the desired tuning direction and speed.
  - Tuning speed can be adjusted in  $\pm 5$  steps.
- ③ Set [RIT] control to the center position to stop tuning.
  - A beep tone sounds when [RIT] control is set to the center.
- ④ Push [RIT] to cancel the SUB tuning dial function.

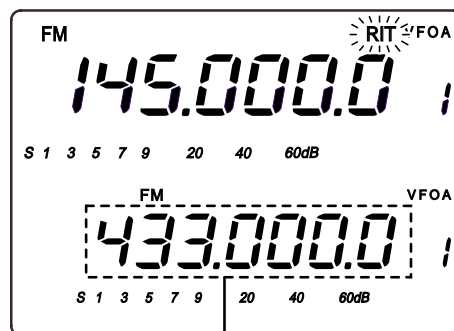

While [RIT] is flashing, SUB band can be controlled with sub dial function.

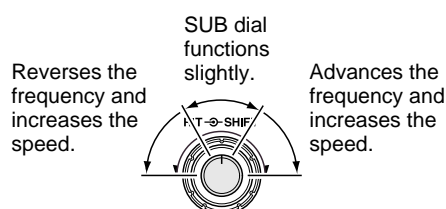

### ◆ SUB tuning dial assignment

- ① Push [SET] then [RIT] to enter the RIT/SHIFT set mode.
- ② Push [DN ▼] or [▲ UP] to select [RIT] or [SHIFT] control to be assigned.
  - “rit nob” or “SFt nob” appears.
- ③ Rotate the tuning dial to select the condition as described below.
  - Pushing [M-CL 5] for 1 sec. selects the default setting.
- ④ Push [SET] to exit from the RIT/SHIFT set mode.

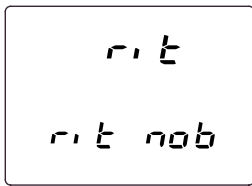
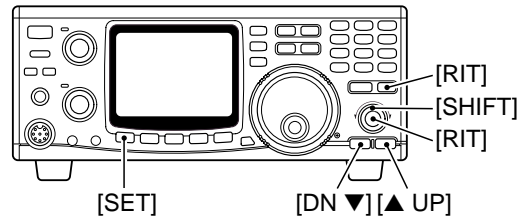

The [RIT] control functions as [RIT] even when the SUB tuning dial function is in use. (default)

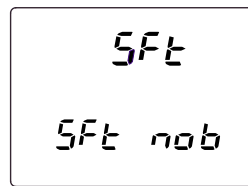

The [SHIFT] control functions as [SHIFT] even when the SUB tuning dial function is in use. (default)



The [RIT] control can be used for MAIN band tuning.

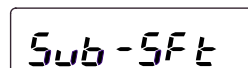

The [SHIFT] control can be used for SUB band IF shift control.

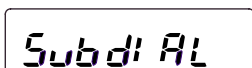

The [RIT] control can be used for SUB band tuning.



The [SHIFT] control can be used for MAIN band tuning.

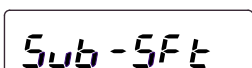

The [RIT] control can be used for SUB band IF shift control.

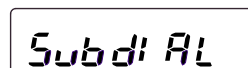

The [SHIFT] control can be used for SUB band tuning.

### ■ Dial lock function

The dial lock function prevents accidental changes caused by the tuning dial (including the SUB tuning dial function).

- ➔ Push [SPCH•LOCK] for 1 sec. to turn the dial lock function ON and OFF.
  - “LOCK” indicator appears while the dial lock function is activated.

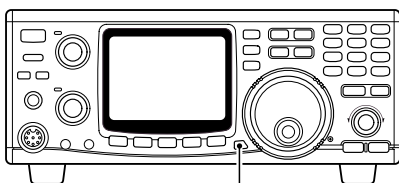

[SPCH•LOCK] for 1 sec.

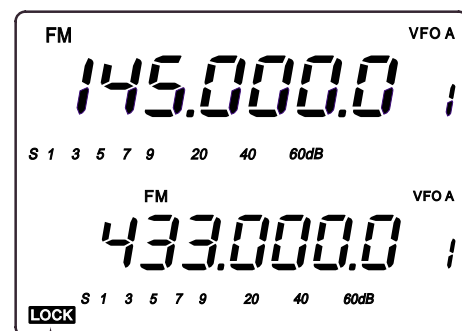

LOCK indicator

## ■ Functions for receive

### ◆ Volume setting

- ➔ Rotate [AF] control for the specified operating band (MAIN or SUB) to output a suitable audio level.

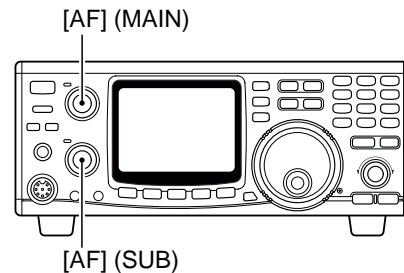

### ◆ Squelch setting

The squelch removes noise output from the speaker (closed position) when no signal is received. The squelch is particularly effective for FM. It is also available for other modes.

With the default setting, noise squelch and S-meter squelch in FM, RF gain and S-meter squelch in SSB/CW mode operation are assigned to [RF/SQL] control. The assignment can be changed in the general set mode. (p. 56)

#### •When operating in FM

- ① Rotate [RF/SQL] fully counterclockwise.
- ② Rotate [RF/SQL] clockwise to the position where the noise just disappears.
  - MAIN/SUB band indicator also goes OFF.

By rotating [RF/SQL] to a deeper position (clockwise), the S-meter will move and the S-meter squelch function will be activated. When the S-meter squelch is activated, weak signals, weaker than the S-meter squelch set level, are ignored.

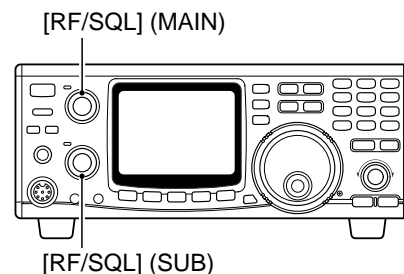

#### •When operating in SSB/CW

- ① Rotate [RF/SQL] fully counterclockwise.
- ② Rotate [RF/SQL] clockwise to the position where the maximum RF gain (S-meter bar disappears), MAIN/SUB band indicator goes OFF, and floor noise disappears.
  - With the default setting, the squelch opens at 12 o'clock position, however, the squelch threshold level can be set to 13 o'clock (1 o'clock) position in the SSB/CW set mode. (p. 62)
  - When rotating [RF/SQL] counterclockwise, RF gain decreases (lower sensitivity) and the S-meter bar appears to indicate the receivable RF signal level.

## ■ RIT function

The RIT (Receive Incremental Tuning) function compensates for off-frequencies of the communicating station without moving the transmit frequency.

The RIT function can be used for the MAIN band only. The function affects the MAIN band even when accessing the SUB band.

- ① Push [RIT] to turn the RIT function ON.
  - “RIT” indicator appears.
- ② Rotate [RIT] control to cancel the off-frequencies.
  - Rotate [RIT] control to the center position, after communication.
- ③ Push [RIT] to cancel the RIT function.
  - “RIT” indicator disappears.

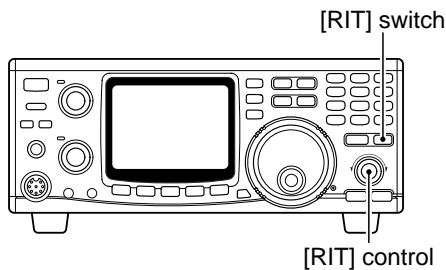

### ◇ RIT variable range

- SSB/CW mode :  $\pm 1.0$  kHz in 10 Hz steps ( $\pm 2.0$  kHz for optional 1200 MHz band)
- FM mode :  $\pm 5.0$  kHz in 50 Hz steps ( $\pm 10.0$  kHz for optional 1200 MHz band)

#### FM mode



RIT variable range is displayed for 2 sec. and then returns to frequency indication.

#### SSB mode



RIT variable range is displayed for 2 sec. and then returns to frequency indication.

## ■ IF shift function

The IF shift function electronically changes the pass-band frequency of the IF (Intermediate Frequency) and cuts out higher or lower frequency components of the IF to reject interference. The function shifts the IF frequency up to  $\pm 1.2$  kHz in 100 Hz steps in SSB/CW mode. The IF shift is especially useful in SSB operation and not available in FM mode.

The IF shift function can be used for the SUB band using the SUB tuning dial function (p. 24)

### ◇ MAIN band IF shift operation

- ① Set the [SHIFT] control to its center position when there is no interference.
- ② Rotate the [SHIFT] control to adjust for minimum interference signal level.
  - The audio tone may change while the IF shift is in use.

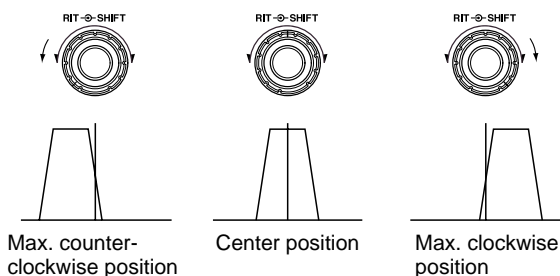

### ◇ SUB band IF shift operation

- ① Assign the SUB band IF shift function to either [RIT] or [SHIFT] control using the RIT/SHIFT set mode (p. 68).
- ② Push [RIT] for 1 sec. to turn the SUB tuning dial function ON.
  - “RIT” indicator flashes.
- ③ Rotate [RIT] or [SHIFT] control for a minimum interference signal level.
- ④ Push [RIT] to cancel the SUB tuning dial function.
  - “RIT” indicator disappears.
  - Set [RIT] or [SHIFT] control to the center position after the communication.

▨ In satellite operation mode, the SUB tuning dial function cannot be activated. Therefore, the [SHIFT] control acts as an IF shift for the receive band (displayed in the upper area).

## ■ AGC time constant

The AGC (Automatic Gain Control) controls receiver gain to produce a constant output level even when the received signal strength is varied by fading, etc. Use AGC slow for normal phone operation; AGC fast for receiving data and searching for signals.

- ➔ Push [AGC] to switch the time constant between fast and slow.
  - “FAGC” indicator appears when AGC fast is selected.
  - The AGC time constant is fixed in FM mode regardless of the FAGC indicator.

The SUB band’s AGC is automatically selected as slow in SSB and fast in CW. AGC time constant cannot be changed in FM mode.

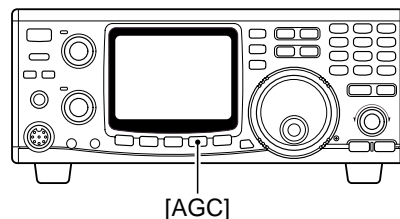

## ■ AFC function

The AFC (Automatic Frequency Control) automatically tunes the operating frequency when receiving an off-frequency signal or receiving signal shifts in FM or FM narrow mode.

- ➔ Push [AFC/NB] to turn the AFC function ON and OFF.
  - “AFC” indicator appears when the AFC function is activated.

/// When strong nearby signals are available, the AFC function may tune to those signals.

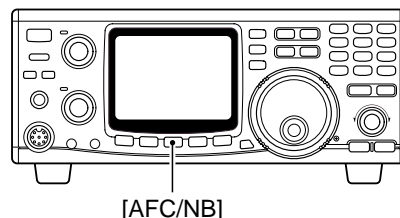

## ■ FM center indicator

The MAIN/SUB band indicators indicate the received signal deviation in FM mode. When an off-center signal is received, the indicator flashes.

When an off-center signal is received, rotate the tuning dial or use the RIT function to illuminate the indicator continuously.

The FM center indicator can be turned OFF using the FM set mode. (p. 61)

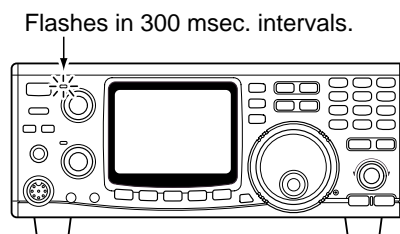

## ■ Attenuator

The attenuator prevents desired signals from distorting when very strong signals are near the desired frequency, or when very strong electric fields, such as from broadcasting stations are near from your location.

The attenuator can be set to both or either band separately, and the attenuation level can be set for each band independently.

- ➔ Push [ATT] to turn the attenuator ON and OFF.
  - “ATT” indicator appears when the attenuator is activated.

### ◆ Setting the attenuation level

- ① Push [M/S•BAND] or [SUB] to select the desired band of the attenuation level to be set.
- ② Push [SET] then [ATT] to enter the attenuator set mode.
- ③ Rotate the tuning dial to select attenuation level.
  - Push [M-CL 5] to return to the default value.
- ④ Push [SET] to exit the attenuator set mode.

/// **NOTE:** When using the noise blanker, received audio may be distorted if they are excessively strong.

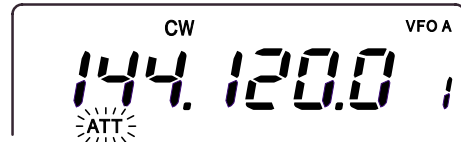
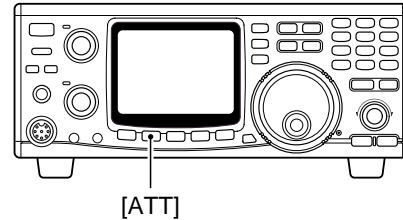

### /// Attenuation levels

144 MHz/	0–100% variable
430(440) MHz bands	Approx. 15 dB attenuation at 100% setting
1200 MHz band	Approx. 20 dB fixed (optional)

## ■ Simple band scope

This function allows you to visually “sweep” an area surrounding the set frequency for other signals. Detected signals are indicated graphically on the S-meter.

- ① Set the operating frequency and mode.
- ② Push [SWP 0] to turn the simple band scope function ON and OFF.
  - “SWP” indicator flashes when the simple band scope function is activated.
  - Detected signals are indicated using the S-meter and “▼” indicator, displayed above the S-meter, shows the center frequency (displayed frequency).
  - The signal availability is detected by the noise squelch condition (open or close).
- ③ To monitor the detected signal, rotate the tuning dial to set the appearing “dot” of the S-meter to below the “▼” indicator.
  - The frequency readout shows the detected signal frequency.

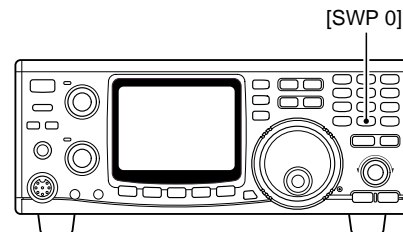

Shows ±10 channels around the displayed frequency.

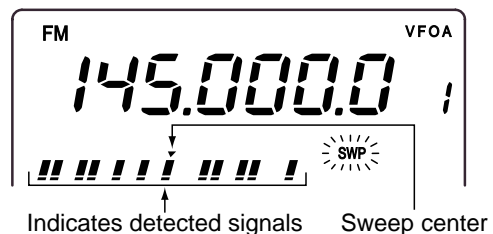

### ◆ Setting sweeping time interval

- ① Push [SET] then [SWP 0] to enter the sweep set mode.
- ② Rotate the tuning dial to select sweeping time interval.
  - Push [M-CL 5] to return to the default value.
- ③ Push [SWP 0] to exit the sweep set mode.

## ■ Noise blanker

When operating in SSB or CW mode, pulse-type noise may be received such as from car ignitions. In this case, the noise blanker eliminates such noise.

The noise blanker is effective on both the MAIN and SUB bands but cannot be used for FM, or non-pulse-type noise.

- ➔ Push [AFC/NB] to turn the noise blanker function ON and OFF.
  - “NB” indicator appears when the noise blanker is activated.
  - The noise blanker turns ON or OFF for both bands simultaneously.

⚡ When using the noise blanker, received audio may be distorted if the signals are excessively strong.

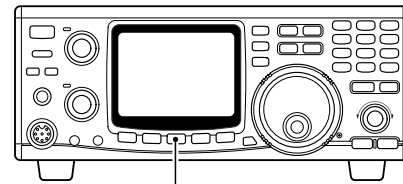

[AFC/NB]

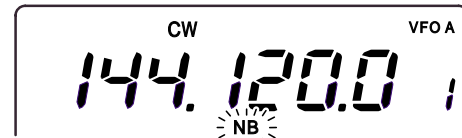

## ■ Tone squelch operation

The tone squelch opens only when receiving a signal with the same pre-programmed subaudible tone. You can silently wait for a call from group members using the same tone. You can check the tone frequency using the tone scan function if desired. (p. 47)

- ① Select the desired band by pushing [M/S•BAND].
- ② Push [FM] to select FM mode, then set the desired frequency.
- ③ Push [CALL•T-SQL] for 1 sec. to activate the tone squelch.
  - “T-SQL” indicator appears.
- ④ When the signal with correct tone is received, the squelch opens and audio can be heard.
  - When a signal with incorrect tone or no tone is received, the squelch does not open, however, the S-meter indicates the signal strength.
  - Push and hold [CHECK 7] to open the squelch manually and keep pushing to monitor.
- ⑤ Operate the transceiver in a normal way (push [PTT] to transmit; release [PTT] to receive).
- ⑥ Push [CALL•T-SQL] for 1 sec. to cancel the tone squelch.
  - “T-SQL” indicator disappears.

### ◆ Setting the tone squelch frequency

The tone squelch frequencies can be independently set for each band.

- ① Push [M/S•BAND] to select the band for the tone squelch frequency to be set.
- ② Push [SET] then [FM] to enter the FM set mode.
- ③ Push [DN ▼] or [▲ UP] to select tone squelch frequency item.
- ④ Rotate the tuning dial to select the desired tone squelch frequency.
- ⑤ Push [FM] to exit from the FM set mode.

#### Tone frequency list

unit: Hz

67.0	85.4	107.2	136.5	165.5	186.2	210.7	254.1
69.3	88.5	110.9	141.3	167.9	189.9	218.1	
71.9	91.5	114.8	146.2	171.3	192.8	225.7	
74.4	94.8	118.8	151.4	173.8	196.6	229.1	
77.0	97.4	123.0	156.7	177.3	199.5	233.6	
79.7	100.0	127.3	159.8	179.9	203.5	241.8	
82.5	103.5	131.8	162.2	183.5	206.5	250.3	

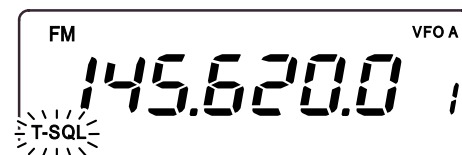
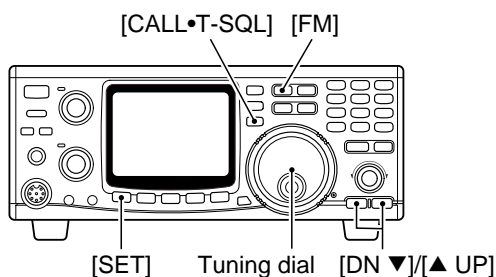



## Optional DSP functions

optional UT-106

To activate the following functions, the optional DSP unit, UT-106, must be installed for both or either the MAIN and/or SUB bands.

### ◆ NR (Noise Reduction) function

This function reduces noise components and picks out desired signals which are buried in noise. The received audio signals are converted to digital signals and then the desired signals are separated from the noise. The noise reduction function is available for all operating modes.

- ① Push [M/S•BAND] or [SUB] to select the band you wish to activate, if required.
- ② Push [AFC/NB•NR] for 1 sec. to turn the noise reduction function ON and OFF.
  - “NR” indicator appears while the automatic notch filter is activated.

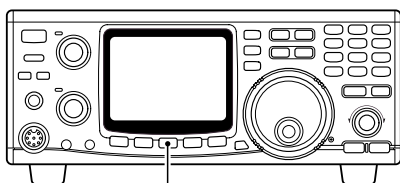

[AFC/NB•NR] for 1 sec.

### ◆ ANF (Automatic Notch Filter) function

This function automatically attenuates beat tones, tuning signals, etc., even if they are moving. The automatic notch filter functions in SSB/FM modes.

- ① Push [M/S•BAND] or [SUB] to select the band you wish to activate, if required.
- ② Push [AGC•ANF] for 1 sec. to turn the automatic notch filter function ON and OFF.
  - “ANF” indicator appears while the automatic notch filter is activated.

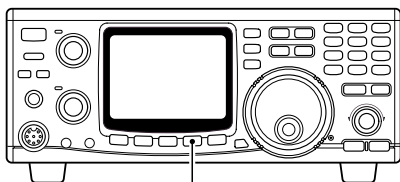

[AGC•ANF] for 1 sec.

### ◆ Setting the noise reduction level

- ① Push [SET] then [AFC/NB•NR] to enter the noise reduction set mode.
- ② Rotate the tuning dial to select the desired noise reduction level.
  - Push [M-CL 5] for 1 sec. to return to the default value.
- ③ Push [AFC/NB•NR] to exit from the noise reduction set mode.

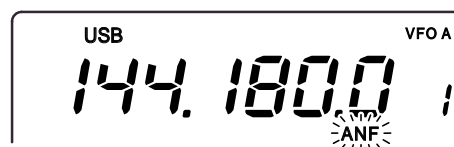
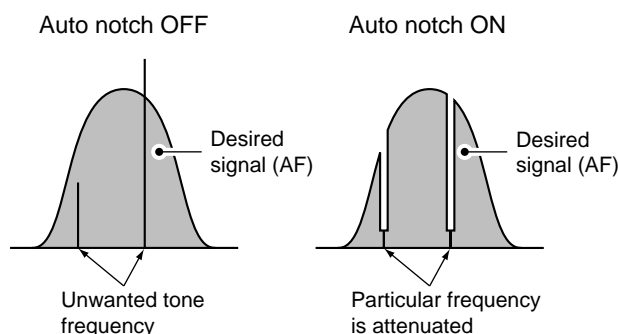
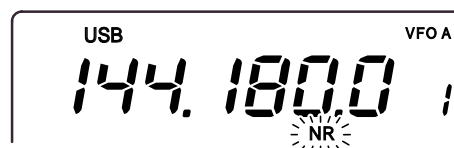

## ■ Functions for transmit

### ◆ Output power

The transmit output power can be continuously adjusted with [RF PWR].

Available power

- 144 MHz band : 5–100 W
- 430(440) MHz band : 5–75 W
- 1200 MHz band : 1–10 W (optional)

**NOTE:** To prevent interference, listen on the frequency to make sure the frequency is clear before transmitting by pushing [CHECK 7].

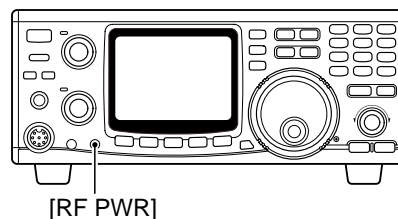

## ■ Transmission via microphone

When transmitting with a microphone, push [PTT] and speak into the microphone at a normal voice level.

To maximize the readability of your transmitted signal (voice), pause a few sec. after pushing [PTT]. Do not hold the microphone too close to your mouth.

### ◆ Microphone gain

Rotate [MIC GAIN] clockwise to increase, counter-clockwise to decrease the microphone gain.

9–12 o'clock position is recommended for [MIC GAIN].

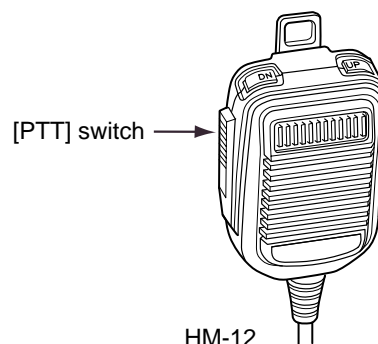

## ■ Indications during transmit

### ◆ Transmit indicator

The MAIN band indicator lights red while transmitting. However, the SUB band indicator lights red during satellite operation.

### ◆ RF power indicator

The S-meter for the MAIN band is used as the RF power indicator to indicate the relative output power level. However, the S-meter for the SUB band is used as the RF power indicator during satellite operation.

### ◆ Time-out timer

The time-out timer limits the continuously transmittable time period, and is selectable from 3, 5, 10, 20, 30 min. and OFF in TRANSMIT set mode. (p. 66)

### ◆ PTT lock function

Deactivate [PTT] and [TRANSMIT] switches. The function can be switched ON and OFF in TRANSMIT set mode. (p. 66)

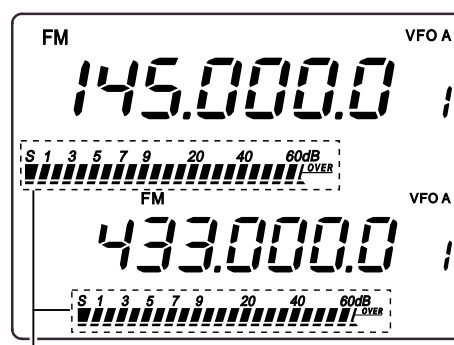

S-meter while receiving  
RF power indicator while transmitting

## ■ FM mode operation

- ① Push [M/S•BAND] to select the desired band.
- ② Push [FM] to select FM mode.
  - “FM” indicator appears.
  - Push [FM] again to select repeater operation after FM mode selection. “DUP–” and “T” indicators appear.
  - Push [FM] for 1 sec. to select FM narrow mode after FM mode selection. “FMN” indicator appears.
- ③ Rotate the tuning dial to set the desired frequency.
- ④ Push [PTT] to transmit.
  - The MAIN band indicator lights red.

- ⑤ Speak into the microphone at a normal voice level.
  - Setting the [MIC GAIN] control to 10–12 o'clock is recommended.
- ⑥ Release [PTT] to receive.

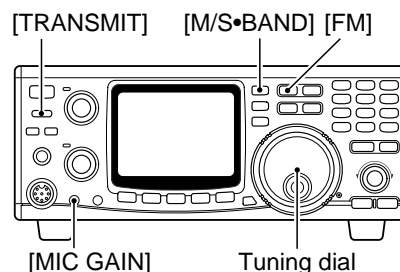

## ■ VOX operation (for SSB and FM)

The VOX (Voice-operated Transmission) function switches between transmit and receive with your voice. This function provides an opportunity to input log entries into your computer, etc., while operating.

- ① Push [M/S•BAND] to select the desired band.
- ② Push either [SSB/CW] or [FM] to select phone mode (USB, LSB or FM).
- ③ Push [VOX] to switch the VOX function ON and OFF.
  - “VOX” indicator appears while the VOX function is activated.

### ◆ Adjusting the VOX gain

- ① Push [SET] then [VOX] to enter the VOX set mode.
- ② Push [DN ▼] or [▼ UP] to select the VOX gain item.
  - “GAIN” is displayed.
- ③ Rotate the tuning dial to adjust the VOX gain while speaking into the microphone at a normal voice level, until the transceiver begins transmitting.
  - With too sensitive a setting, the transceiver may transmit with other than your voice, such as noise, receiving signal, etc.
  - Push [M-CL 5] for 1 sec. to return to the default value.
- ④ Push [VOX] to exit VOX set mode.

### ◆ Adjusting the anti-VOX gain

- ① Push [SET] then [VOX] to enter the VOX set mode.
- ② Push [DN ▼] or [▲ UP] to select anti-VOX gain item.
  - “Anti” is displayed.
- ③ Rotate the tuning dial to adjust the anti-VOX gain while receiving a signal with a suitable audio output level, to the point where the transceiver does not transmit with the audio output from the speaker.
  - Push [M-CL 5] for 1 sec. to return to the default value.
- ④ Push [VOX] to exit VOX set mode.

### ◆ Adjusting the VOX delay

- ① Push [SET] then [VOX] to enter the VOX set mode.
- ② Push [DN ▼] or [▲ UP] to select the VOX delay item.
  - “dELAY” is displayed.
- ③ Rotate the tuning dial to adjust the VOX delay time while speaking into the microphone at a normal speed, to a convenient interval before returning to receive.
  - Push [M-CL 5] for 1 sec. to return to the default value.
- ④ Push [VOX] to exit VOX set mode.

## ■ Repeater operation

A repeater amplifies received signals and re-transmits them at a different frequency. When using a repeater, the transmit frequency is shifted from the receive frequency by an offset frequency.

### ◆ Setting the auto repeater range

The auto repeater function automatically turns ON the duplex operation with specified shift direction and tone encoder when the operating frequency is set in the desired frequency range. To activate the auto repeater function, the following operations are necessary.

- ① Set one edge frequency of the desired frequency range.
  - Push [M/S•BAND] to select the desired band if required.
  - Push [FM] to select FM mode if required.
- ② Set the desired repeater conditions.
  - Both one-touch repeater and manual repeater setting are acceptable.
- ③ Push [DN ▼] or [▲ UP] to select the memory channel 1.
  - The memory channel 3 or 5 is also acceptable.
- ④ Push [MW 4] for 1 sec. to program the contents into the memory.
  - 3 beep tones may sound.
- ⑤ Set the other side edge frequency of the desired frequency range.
- ⑥ Push [▲ UP] to select the memory channel 2.
  - Select memory channel 4 or 6, respectively if the memory channel 3 or 5 is selected in step ③.
- ⑦ Push [MW 4] for 1 sec. to program the contents into the memory.
- ⑧ Repeat steps ① to ⑦ to program other ranges.
- ⑨ Push [POWER] for 1 sec. to turn the power OFF once, then push [POWER] to turn the power ON while pushing and holding [FM] and [TONE].
  - The memory channels can be used for normal operation after programming.

### ◆ Setting the shift direction for the one-touch repeater function

- ① Push [M/S•BAND] or [SUB] to select the desired frequency band.
- ② Push [SET] then [FM] to enter the FM set mode.
- ③ Push [DN ▼] or [▲ UP] to select shift direction item.
  - “o\_touch” and “rPt” are displayed.
- ④ Rotate the tuning dial to select the desired direction.
  - “DUP–” or “DUP+” is selectable.
- ⑤ Push [FM] to exit from the FM set mode.

- ⑩ Push [SET] then [FM] to enter the FM set mode.
- ⑪ Push [DN ▼] or [▲ UP] to select auto repeater item.
  - “AutorPt” is displayed.
- ⑫ Rotate the tuning dial to turn the auto repeater function ON.
  - U.S.A. version:
    - “on1” Activates duplex only.
    - “on2” Activates duplex and tone.
    - “oFF” Auto repeater function is turned OFF.
  - Korea version:
    - “ON” Activates duplex and tone.
    - “OFF” Auto repeater function is turned OFF.
- ⑬ Push [FM] to exit from the FM set mode.

▨ **NOTE:** All repeater ranges for available bands must be programmed at the same time. Otherwise, the previously programmed ranges will be lost.

### ◆ Frequency range and shift direction

#### •U.S.A. version

FREQUENCY RANGE	SHIFT DIRECTION
145.2000– 145.4999 MHz 146.6100– 146.9999 MHz	“DUP–” appears
147.0000– 147.3999 MHz	“DUP+” appears
442.0000– 444.9999 MHz	“DUP+” appears
447.0000– 449.9999 MHz	“DUP–” appears
1282.0000–1295.9999 MHz	“DUP–” appears

#### •Korea version

FREQUENCY RANGE	SHIFT DIRECTION
439.0000– 440.0000 MHz	“DUP–” appears
1290.0000–1293.0000 MHz	“DUP–” appears

### ◆ Manual repeater setting (non-European versions)

- ① Set the desired frequency.
  - Push [M/S•BAND] to select the desired band if required.
  - Push [FM] to select FM mode if required.
- ② Push [SPLIT•DUP] for 1 sec. to select the duplex operation and the shift direction.
  - “DUP–” or “DUP+” indicator appears, depending on the selection.
  - Set the offset frequency in the FM set mode, if required.
- ③ Push [TONE] to activate the tone encoder.
  - “T” indicator appears.
  - Set the tone frequency in the FM set mode, if required.
- ④ Push [SPLIT•DUP] for 1 sec. and [TONE] to cancel the duplex operation and deactivate the tone encoder.
  - “DUP–” or “DUP+” and “T” indicators disappear.

### ◆ Using the one-touch repeater function

By using the pre-programmed offset frequency, shift direction and tone frequency, quick and simple repeater operation can be made.

The default values for offset frequency and direction are as follows:

144 MHz band	: -0.600 MHz
430(440) MHz band	: -5.000 MHz (other than below)
	-7.200 MHz (European version)
	-1.600 MHz (Swedish version)
1200 MHz band	: -20.000 MHz (optional)
Tone frequency	: 88.5 Hz

- ① Push [M/S•BAND] to select the desired frequency band.
- ② Push [FM] to select FM mode.
- ③ Rotate the tuning dial to input the desired repeater frequency.
  - Direct frequency input using the keypad can be used for frequency setting.

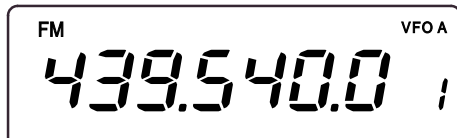

- ④ Push [FM] to select the repeater operation mode.
  - "DUP—" and "T" indicators appear.

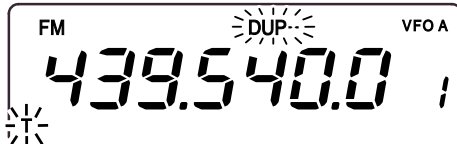

### ◆ Setting tone frequency

#### (non-European versions)

- ① Push [M/S•BAND] to select the desired frequency band.
- ② Push [SET] then [FM] to enter the FM set mode.
- ③ Push [DN ▼] or [▲ UP] to select the tone frequency item.
  - "ton," selected band (144/430(440)/1200) and "T" indicator appear.
- ④ Rotate the tuning dial to set the desired tone frequency.
- ⑤ Push [FM] to exit from the FM set mode.

- ⑤ Push [PTT] to access the repeater.

Shifts 5 MHz when transmitted.

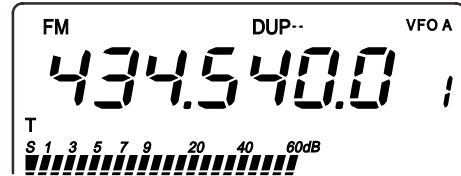

- ⑥ Release [PTT] to receive a signal from the repeater.
- ⑦ Push [FM] to cancel the duplex operation mode.
  - "DUP—" and "T" indicators disappear.

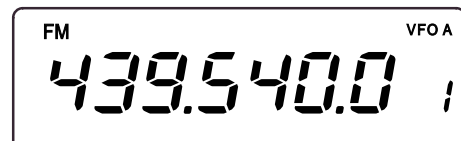

### ◆ Setting offset frequency

- ① Push [M/S•BAND] or [SUB] to select the desired frequency band.
- ② Push [SET] then [FM] to enter the FM set mode.
- ③ Push [DN ▼] or [▲ UP] to select the offset frequency item.
  - "duP" and selected band (144/430(440)/1200) appear.
- ④ Rotate the tuning dial to set the desired tone frequency.
- ⑤ Push [FM] to exit from the FM set mode.

## ■ SSB mode operation

- ① Push [M/S•BAND] to select the desired frequency band.
- ② Push [SSB/CW] to select USB or LSB mode.
  - Push [SSB/CW] for 1 sec. to switch between USB and LSB when either the USB or LSB has been selected.
- ③ Rotate the tuning dial to set the desired frequency.
- ④ Push [PTT] to transmit and speak into the microphone at a normal voice level.
- ⑤ Rotate [MIC GAIN] so that the MAIN band indicator periodically lights red brightly.
  - The brightness increases when the ALC is activated.
- ⑥ Release [PTT] to receive.

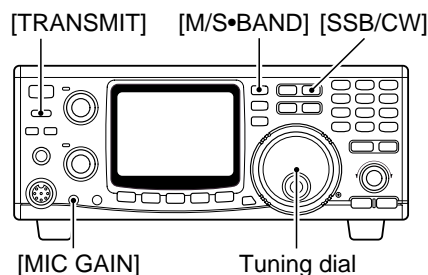

### ▨ ALC indicator

While transmitting, the MAIN/SUB band indicator shows the ALC condition. Brightness increases more than usual when the ALC function is activated.

### ▨ VOX function

The VOX (Voice-operated Transmission) function is available for switching between transmit and receive with your voice. See p. 33 for details.

## ■ Speech compressor

The speech compressor increases average RF output power, improving signal strength and readability in SSB. The IC-910H has a built-in, low-distortion speech compressor circuit.

- ➔ Push [COMP] to turn the speech compressor ON and OFF.
  - Either USB or LSB should be selected.
  - “COMP” indicator appears when the speech compressor is activated.

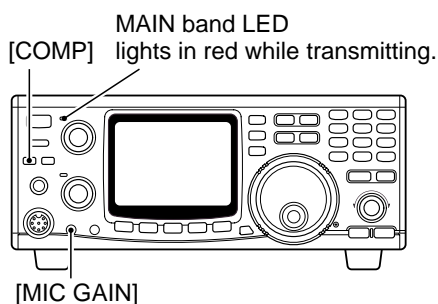

### ◆ Compression level setting

- ① Select USB or LSB mode.
- ② Preset the transceiver as follows:
  - [COMP] function : OFF
  - [RF POWER] control : Max. counterclockwise
- ③ Transmit at your normal voice level.
- ④ Adjust the [MIC GAIN] control so that the MAIN band indicator periodically lights red brightly whether or not you speak softly or loudly.
- ⑤ Push [COMP] to turn the speech compressor ON.
- ⑥ Push [SET] then [COMP] to enter the COMP set mode.
- ⑦ Rotate the tuning dial to adjust the compression level to the point where the maximum value and the MAIN band indicator brightness does not increase, whether or not you speak softly or loudly.
  - When the MAIN band indicator continuously lights red with increased brightness, your transmitted voice may be distorted.
  - It's a good idea to adjust the compressor level by monitoring with an other transceiver or receiver, if you have one, or with an other station.
- ⑧ Push [COMP] to exit the COMP set mode.

## ■ Split frequency operation

Split frequency operation allows you to transmit and receive on two different frequencies in the same frequency band. Split frequency operation uses 2 frequencies, one in VFO A and the other in VFO B.

- ① Set a receive frequency in VFO mode.
  - Either VFO A or VFO B can be used.
- ② Push [A=B 2] for 1 sec.
  - The undisplayed VFO contents are cleared and equalized to the displayed frequency.
- ③ To change the receive frequency, rotate the tuning dial.

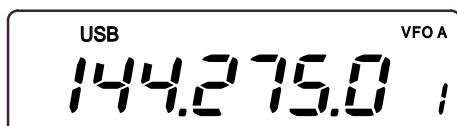

- ④ To replace the transmit and receive frequencies, push [A/B 3].

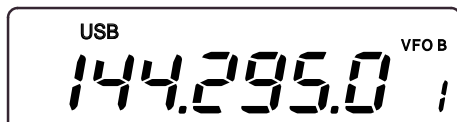

- ⑤ To change the transmit frequency, rotate the tuning dial while pushing [CHECK 7].

## ■ Full duplex operation

The MAIN and SUB bands are activated independently, therefore, simultaneous transmission and reception in different frequency bands are possible.

- ① Push [M/S•BAND] to select the desired frequency band for transmission.
  - Push [V/M 1] to select VFO or memory mode, if desired.
  - Push [SSB/CW] or [FM] to select the desired operating mode.
- ② Rotate the tuning dial to set the desired frequency.
  - Direct frequency input from the keypad is also available.
- ③ Push [SUB] to enable the SUB band access.
  - Push [M/S•BAND] for 1 sec. to select the desired frequency band, if desired. (when the optional UX-910 is installed.)
  - Push [V/M 1] to select VFO or memory mode, if desired.
  - Push [SSB/CW] or [FM] to select the desired operating mode.
- ④ Push [PTT] to transmit.

- ⑥ Push [SPLIT].
  - “SPLIT” indicator appears.
  - Now you can receive on the displayed VFO and transmit on the undisplayed VFO.
  - To monitor the transmit frequency, push [CHECK 7].

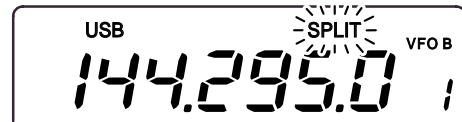

- ⑦ Push [SPLIT] to cancel the split frequency operation.
  - “SPLIT” indicator disappears.

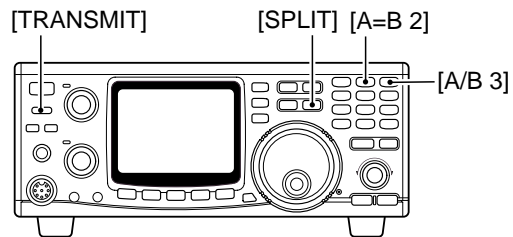

Cross mode communication can be performed using the split function. (e.g. USB and CW)

### •SUB band mute function

The SUB band mute function mutes receiving audio from the SUB band while transmitting.

- ① Push [SET] then [TRANSMIT] to enter the TRANSMIT set mode.
- ② Push [DN ▼] or [▲ UP] to select the SUB band mute item.
  - “Audio” is displayed.
- ③ Rotate the tuning dial to turn the SUB band mute function ON and OFF.
  - Push [M-CL 5] for 1 sec. to return to the default setting.
- ④ Push [TRANSMIT] to exit from the TRANSMIT set mode.

## ■ Connections for CW

Before operating in CW, select the paddle type using the SSB/CW set mode.

- ① Push [SSB/CW] to select CW mode.  
•“CW” indicator appears.
- ② Push [SET] then [SSB/CW] to enter the SSB/CW set mode.

- ③ Push [DN▼] or [▲UP] to select the paddle type item.  
•“PADDLE” is displayed.
- ④ Rotate the tuning dial to select the paddle type.  
•Push [M-CL 5] for 1 sec. to return to the default setting.
- ⑤ Push [SSB/CW] to exit the SSB/CW set mode.

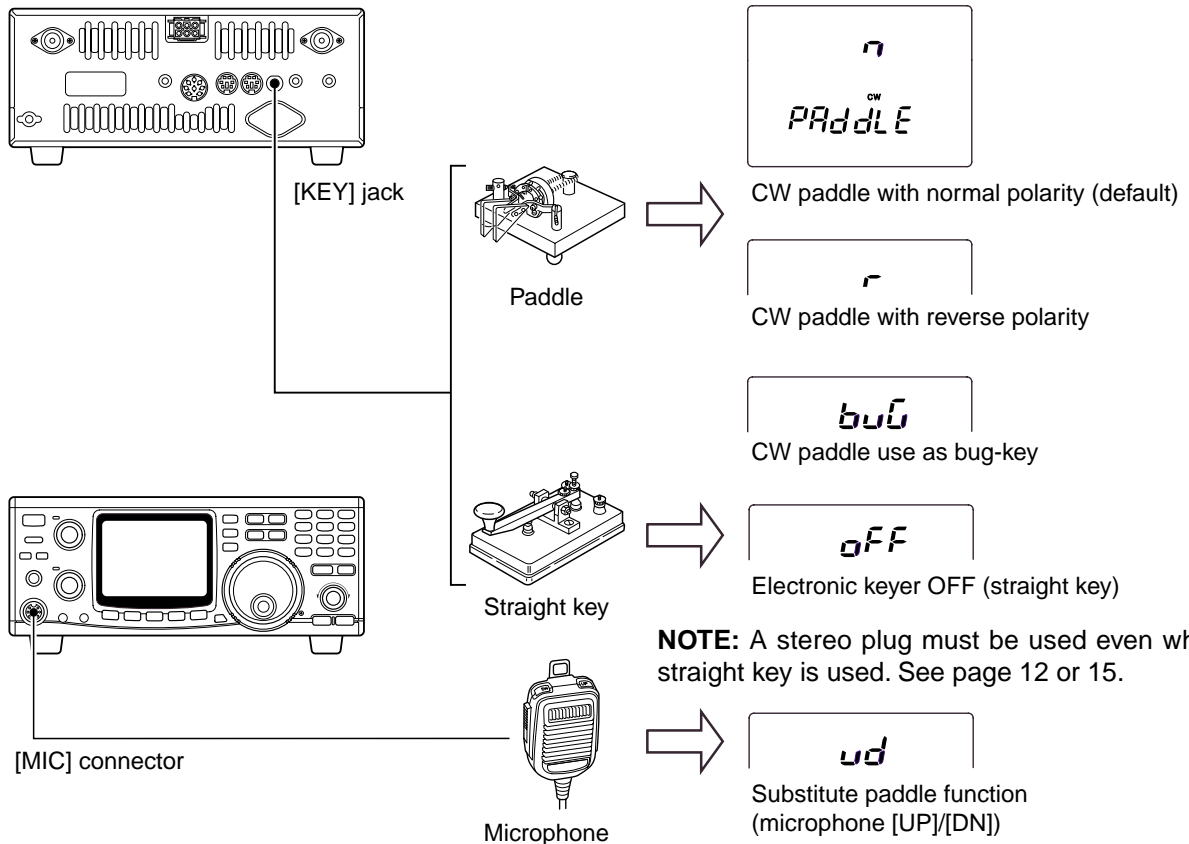

**NOTE:** A stereo plug must be used even when a straight key is used. See page 12 or 15.

**NOTE:** [UP]/[DN] keying does not function while pushing [PTT] on the microphone. Push [TRANSMIT] on the front panel or use the semi break-in function in this case.

## ■ CW mode operation

- ① Connect a paddle or straight key as above.
- ② Push [M/S•BAND] to select the desired frequency band.
- ③ Push [SSB/CW] to select CW mode.  
•Push [SSB/CW] for 1 sec. to select CW narrow mode after the CW mode selection when the optional CW narrow filter, FL-132 (for MAIN band) or FL-133 (for SUB band), is installed.
- ④ Rotate the tuning dial to set the operating frequency.
- ⑤ Push [TRANSMIT] to set the transceiver to transmit mode.  
•The MAIN band indicator lights red.

- ⑥ Operate the paddle or key to transmit the CW signal.
- ⑦ Push [TRANSMIT] to return to receive mode.

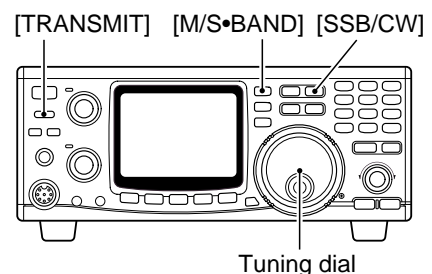



### ◆ Setting keying speed

- ① Push [SET] then [SSB/CW] to enter the SSB/CW set mode.
- ② Push [DN▼] or [▲UP] to select the keying speed item.
  - “SPEEd” is displayed.
- ③ Rotate the tuning dial to adjust the keying speed to the desired speed.
  - Keying speed can be selected from 6–60 wpm.
  - Push [M-CL 5] for 1 sec. to return to the default value.
- ④ Push [SSB/CW] to exit the SSB/CW set mode.

### ◆ Setting semi break-in function

- ① Push [SET] then [SSB/CW] to enter the SSB/CW set mode.
- ② Push [DN▼] or [▲UP] to select the semi break-in item.
  - “br-In” is displayed.
- ③ Rotate the tuning dial to turn the semi break-in function ON and OFF.
  - Push [M-CL 5] for 1 sec. to return to the default setting.
- ④ Push [DN▼] or [▲UP] to select the delay time item.
  - “dELAy” is displayed.
- ⑤ Rotate the tuning dial to set the delay time to the desired time period.
  - Delay time can be selected from 2.0–13.0 sec. in 0.1 sec. steps.
  - Push [M-CL 5] for 1 sec. to return to the default value.
- ⑥ Push [SSB/CW] to exit the SSB/CW set mode.

### ◆ Setting keying weight

- ① Push [SET] then [SSB/CW] to enter the SSB/CW set mode.
- ② Push [DN▼] or [▲UP] to select the keying weight item.
  - “rAtio” is displayed.
- ③ Rotate the tuning dial to adjust the keying weight ratio to the desired level.
  - Keying weight ratio can be selected from 1:1:2.8 to 1:1:4.5.
  - Push [M-CL 5] for 1 sec. to return to the default value.
- ④ Push [SSB/CW] to exit the SSB/CW set mode.

### ◆ Setting CW pitch

- ① Push [SET] then [SSB/CW] to enter the SSB/CW set mode.
- ② Push [DN▼] or [▲UP] to select the CW pitch item.
  - “Pitch” is displayed.
- ③ Rotate the tuning dial to adjust the CW pitch to the desired pitch.
  - CW pitch can be adjusted within 300–900 Hz range.
  - Push [M-CL 5] for 1 sec. to return to the default value.
- ④ Push [SSB/CW] to exit the SSB/CW set mode.

### ◆ Setting side tone

- ① Push [SET] then [SSB/CW] to enter the SSB/CW set mode.
- ② Push [DN▼] or [▲UP] to select the side tone item.
  - “SidE-t” is displayed.
- ③ Rotate the tuning dial to adjust the side tone level to the desired level.
  - Push [M-CL 5] for 1 sec. to return to the default value.
- ④ Push [SSB/CW] to exit the SSB/CW set mode.

### KEYING WEIGHT EXAMPLE: Morse code “K”

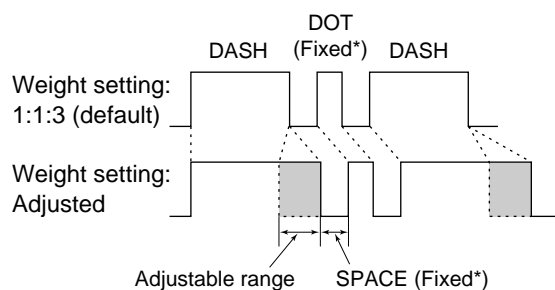

\*SPACE and DOT length can be adjusted with the keying speed only.

## Memory channels

The IC-910H has 106 memory channels (99 for regular, 6 scan edges and 1 call) and they are equipped for each frequency band for storing the most often used frequencies and operating mode, as well as tone frequency, offset frequency, etc.

Memory Channel	Description
1–99	Regular memory channels. Programs operating frequency, mode, subaudible tone activity with frequency and split/duplex conditions.
1A/1b–3A/3b	Scan edge channels. Programs edge frequencies for programmed scan.
C	Call channel recalls a specified frequency on the instant. Programs operating frequency, mode, etc., and is available for each band, independently.

## Operation on a memory channel

Frequency and mode, etc., can be changed in a memory channel. However, they will be cleared if [MW 4] is not pushed.

### Memory channel selection

- Push [V/M 1] to select memory channel mode.
  - “MEMO” indicator appears.
- Push [DN ▼] or [▲UP] to select the desired memory channel.
  - Memory channel changes continuously while holding [DN ▼] or [▲UP].
  - The tuning dial rotation while pushing [F-INP ENT] also selects memory channel.
- Push [V/M 1] to return to VFO mode.

### During VFO mode operation

By pushing [DN ▼] or [▲UP] during VFO mode operation, memory channel is also selectable. However, the frequency readout does not change in this case, only the memory channel number changes.

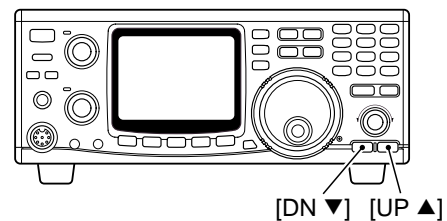

[V/M 1] Select memory mode



[DN ▼] [▲UP] Select memory channel

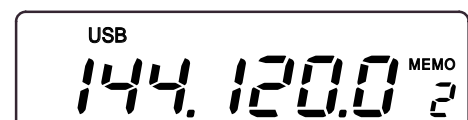

## ■ Programming in VFO mode

Memory channel programming can be performed either in VFO mode or in memory mode.

- ① Set the desired operating frequency and mode in VFO mode.
  - Push [V/M 1] to select VFO mode, if required.
  - Tone frequency, offset frequency, etc., can also be programmed.
  - Input the frequency from the keypad  
Push [F-INP ENT] ⇒ [1] ⇒ [4] ⇒ [4] ⇒ [.] ⇒ [2] ⇒ [6] ⇒ [8] ⇒ [F-INP ENT]
- ② Push [DN ▼] or [▲ UP] to select the desired memory channel to be programmed.
- ③ Push [MW 4] for 1 sec. to program the displayed frequency and operating mode into the memory channel.

To check the programmed contents, push [V/M 1] to select memory mode.

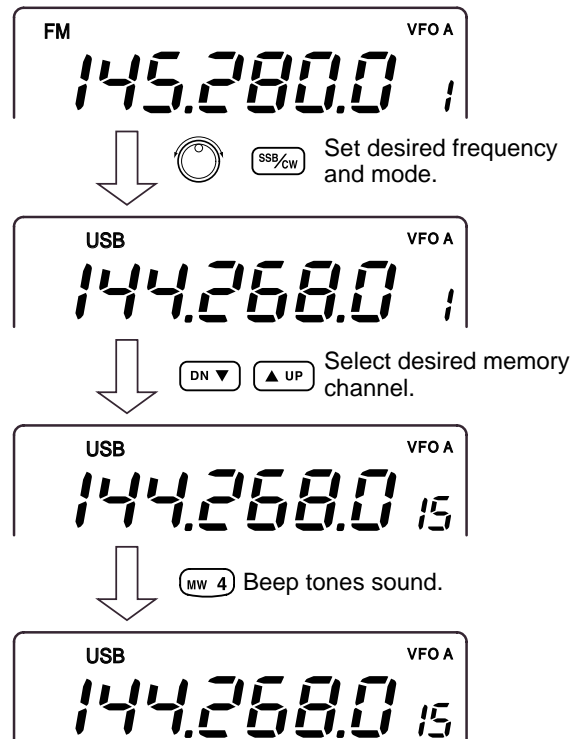

## ■ Programming in memory mode

- ① Push [V/M 1] to select memory mode.
- ② Push [DN ▼] or [▲ UP] to select the desired memory channel to be programmed.
  - The tuning dial rotation while pushing [F-INP ENT] also selects memory channel.
- ③ Set the desired operating frequency and mode in the memory mode.
  - Tone frequency, offset frequency, etc., can also be programmed.
  - Set the desired operating frequency using with the keypad when programming into blank channels. The tuning dial rotation for frequency setting cannot be performed when a blank channel is selected.
  - Input the frequency from the keypad  
Push [F-INP ENT] ⇒ [1] ⇒ [4] ⇒ [4] ⇒ [.] ⇒ [1] ⇒ [6] ⇒ [4] ⇒ [F-INP ENT]
- ④ Push [MW 4] for 1 sec. to program the displayed frequency and operating mode into the memory channel.

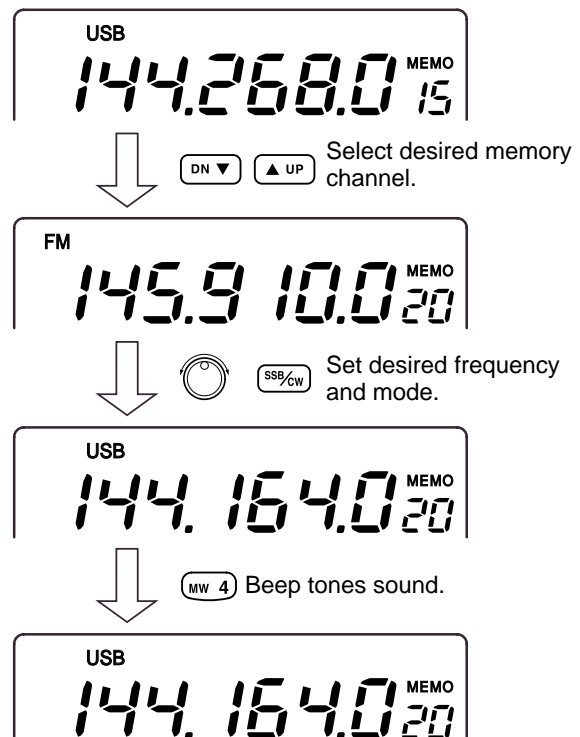

### Blank channels

Memory channels 6–99 are blank channels by factory default. They have no contents programmed.

When a blank channel is selected, the “BLANK” indicator appears and the frequency band is displayed 2 sec. after the selection.

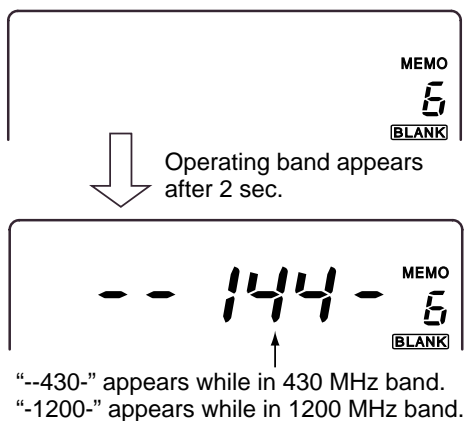

### Frequency transferring

The frequency and operating mode in a memory channel can be transferred to the VFO.

Frequency transferring can be performed in either VFO mode or memory mode.

#### Transferring in memory mode

This is useful for transferring frequency and operating mode while operating in memory mode.

When you have changed the frequency or operating mode in the selected memory channel:

- **Displayed** frequency and mode are transferred.
- **Programmed** frequency and mode in the memory channel are not transferred, and they remain in the memory channel.

- ① Push [DN ▼] or [▲UP] to select the memory channel to be transferred in memory mode.
  - And, set the frequency or operating mode if required.
- ② Push [M▶V 6] for 1 sec. to transfer the frequency and operating mode.
  - Displayed frequency and operating mode are transferred to the VFO.
- ③ Push [V/M 1] to return to VFO mode.

#### Programming a blank channel

- ① Push [V/M 1] to select VFO mode.
- ② Set the desired operating frequency, mode, etc.
- ③ Push [MW 4] for 1 sec. to program the memory channel.
  - “BLANK” indicator disappears.

#### Transferring in VFO mode

This is useful for transferring programmed contents to VFO.

- ① Push [V/M 1] to select VFO mode.
- ② Push [DN ▼] or [▲UP] to select the memory channel to be transferred.
  - “BLANK” appears if the selected memory channel is a blank channel. In this case transferring is impossible.
- ③ Push [M▶V 6] for 1 sec. to transfer the frequency and operating mode.
  - Transferred frequency and operating mode appear on the frequency readout.

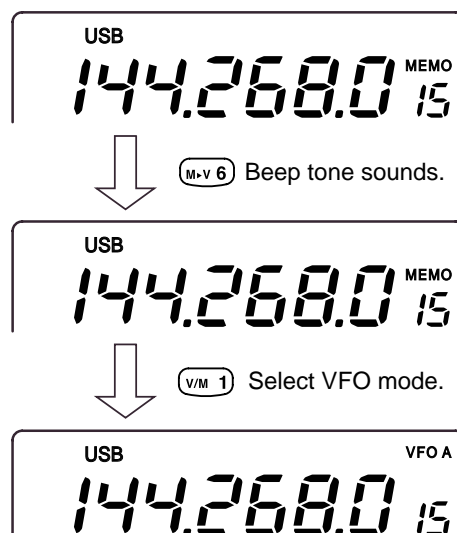

## ■ Memory clearing

Any unnecessary memory channels can be cleared. The cleared memory channels become blank channels.

- ① Push [V/M 1] to select memory mode.
- ② Push [DN▼] or [▲UP] to select the desired memory channel to be cleared.
- ③ Push [M-CL 5] for 1 sec. to clear the contents.
  - The programmed frequency and operating mode disappear.
  - “BLANK” indicator appears.
- ④ To clear other memory channels, repeat steps ② and ③.

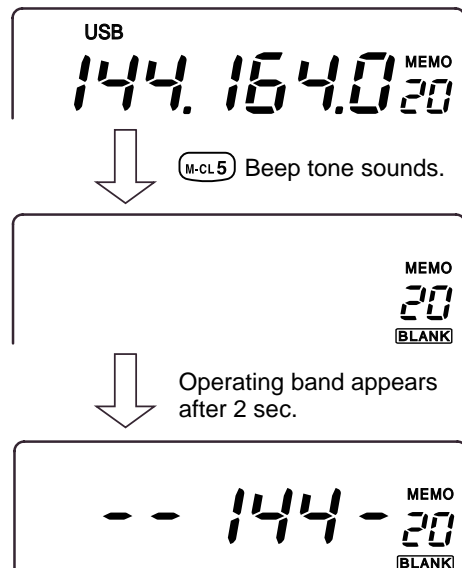

## ■ Call channel

The call channel is a one-touch accessible channel for recalling your most-often-used frequency. The IC-910H has one call channel for each frequency band.

### ◆ Call up a call channel

- ① Push [M/S•BAND] or [SUB] to select the desired frequency band.
- ② Push [CALL] to select the call channel.
- ③ Push [CALL] or [V/M 1] to return to previous display.

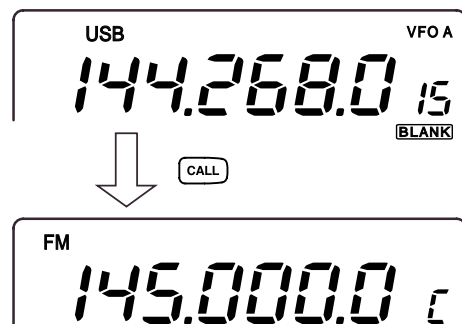

### ◆ Call channel programming

- ① Push [M/S•BAND] or [SUB] to select the desired frequency band.
- ② Push [CALL] to select the call channel.
- ③ Enter the desired frequency using the keypad.
  - e.g.; When programming 145.8200 MHz.
  - Push [F-INP ENT] ⇒ [1] ⇒ [4] ⇒ [5] ⇒ [.] ⇒ [8] ⇒ [2] ⇒ [F-INP ENT]
  - Select operating mode if required.
- ④ Push [MW 4] for 1 sec. to program the call channel.

### ◆ Transferring call channel contents

- ① Push [M/S•BAND] or [SUB] to select the desired frequency band.
- ② Push [CALL] to select the call channel.
- ③ Push [M▶V 6] for 1 sec. to transfer the call channel contents.

## ■ Memo pads

The IC-910H has a memo pad function for each frequency band to store frequency and operating mode for easy write and recall. The memo pads are separate from memory channels.

The default number of memo pads is 5, however, this can be increased to 10 in the memo pad set mode (p. 64) if desired.

Memo pads are convenient when you want to memorize a frequency and operating mode temporarily, such as when you find a DX station in a pile-up, or when a desired station is busy for a long time and you want to temporarily search for other stations.

Use the transceiver's memo pads instead of relying on hastily scribbled notes that are easily misplaced.

### ◆ Writing frequencies and operating modes into memo pads

You can simply store the accessed readout frequency and operating mode by pushing [MPW 8].

When you write a 6th (or 11th) frequency and operating mode, the oldest written frequency and operating mode are automatically erased to make room for the new settings.

Each memo pad must have its own unique combination of frequency and operating mode; memo pads having identical settings cannot be written.

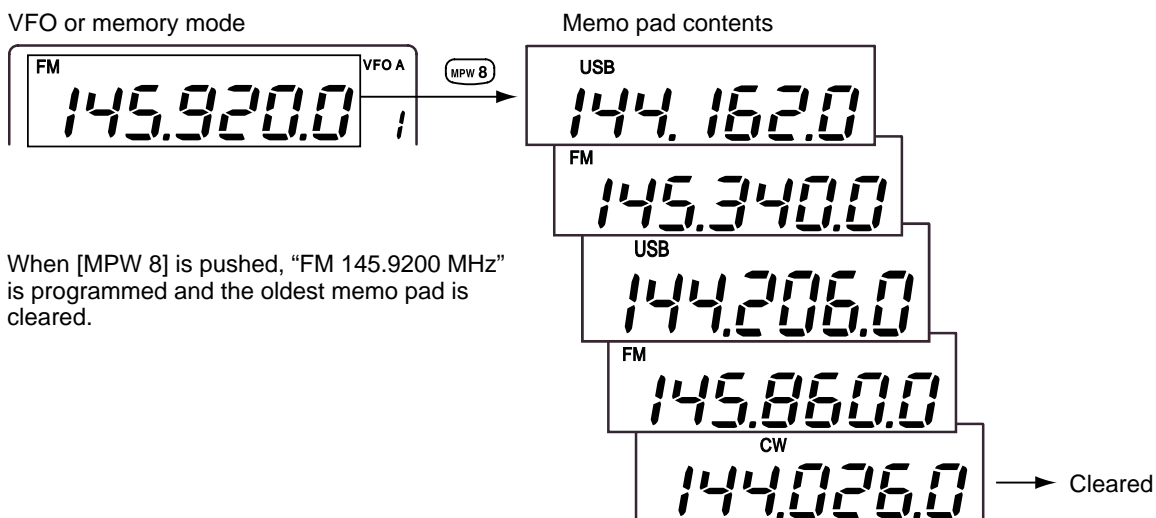

### ◆ Calling up a frequency from a memo pad

You can simply call up the desired frequency and operating mode of a memo pad by pushing [MPR 9].

- Both VFO and memory modes can be used.
- The frequency and operating mode are called up, starting from the most recently written.

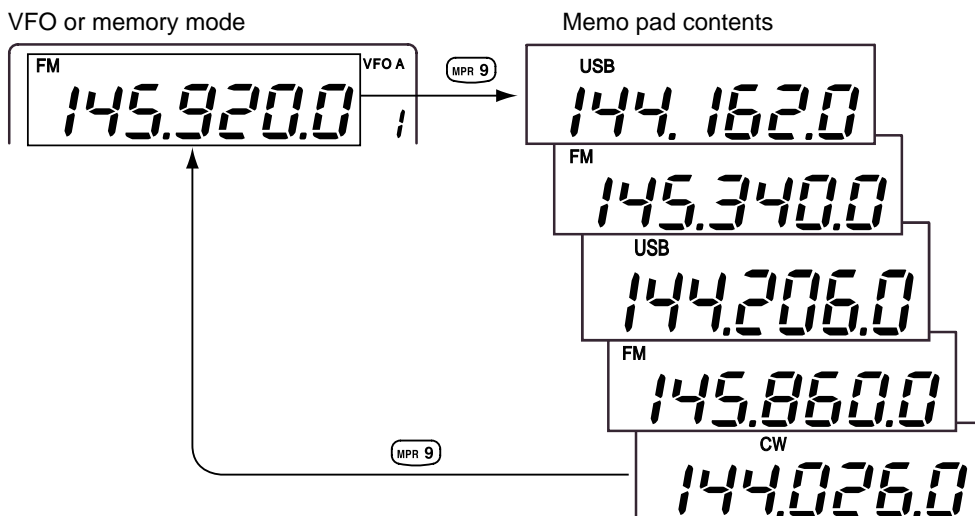

## ■ Scan types

Scanning searches for signals automatically and makes it easier to locate new stations for contact or listening purposes. The IC-910H has several scan types; programmed scan, memory scan and mode select scan.

The scanning operation can be performed independently for MAIN and SUB band. And to search a sub-audible tone frequency for a repeater frequency, a tone scan is also available.

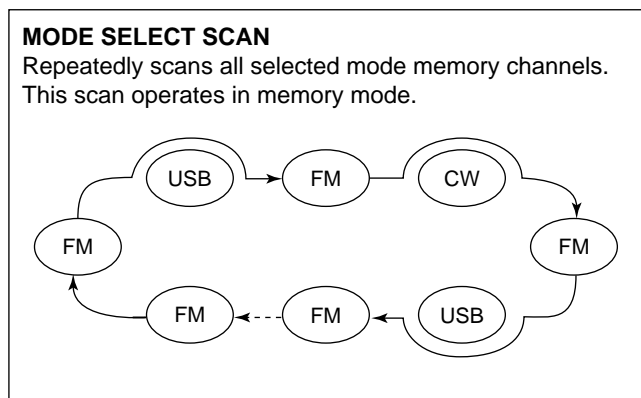
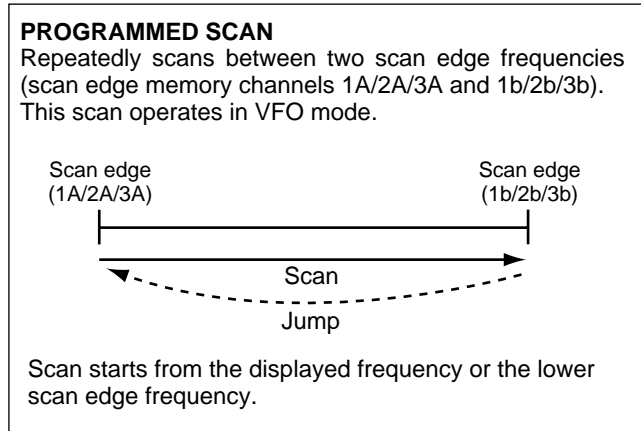
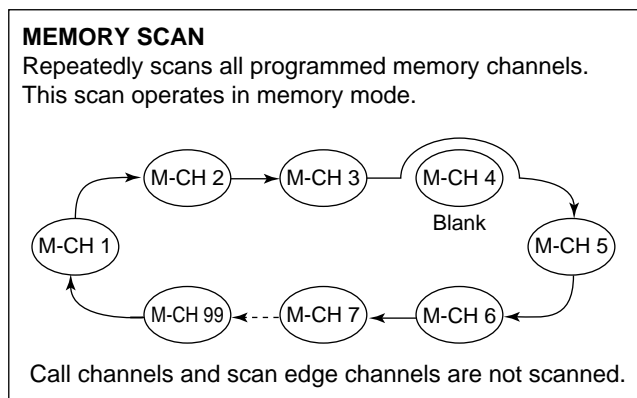

## ■ Preparation

### • Squelch condition

Set the [RF/SQ] control as for regular operation.

### • When receiving a signal

- Scan pauses for 10 sec. when receiving a signal, then resumes.
- When a signal disappears while scan is paused, scan resumes approx. 3 sec. later.

### • Scan resume ON/OFF

You can select the scan to resume or cancel when receiving a signal, in the scan set mode. Scan resume ON/OFF must be set before operating a scan. See details described at right for ON/OFF setting.

### • Scan start/stop operation

Push [SCAN.] to start and cancel scanning.

### • Scan speed

Scan speed can be selected from 2 levels, high (default) or low, in the scan set mode. See details described at right.

### • Setting scan resume condition

- ① Push [SET] then [SCAN.] to enter the scan set mode.
- ② Push [DN▼] or [▲UP] to select the scan resume item.
  - "SC-rES" is displayed.
- ③ Rotate the tuning dial to select scan resume condition from ON and OFF.
  - "ON": scan resumes, "OFF": scan cancels
  - Push [M-CL-5] for 1 sec. to return to the default setting.
- ④ Push [SCAN.] to exit from the scan set mode.

### • Setting scan speed

- ① Push [SET] then [SCAN.] to enter the scan set mode.
- ② Push [DN▼] or [▲UP] to select the scan speed item.
  - "SC-SPd" is displayed.
- ③ Rotate the tuning dial to select scan resume condition from HI and Lo.
  - Push [M-CL-5] for 1 sec. to return to the default setting.
- ④ Push [SCAN.] to exit from the scan set mode.

## Programmed scan operation

Scans specified frequency range, programmed in the memory channel 1A/1b, 2A/2b and 3A/3b. Before starting the programmed scan, scan edges should be programmed in these channels.

### Selecting scanning range

- ① Push [M/S•BAND] or [SUB] to select the desired frequency band to be scanned.
- ② Push [SET] then [SCAN .] to enter the scan set mode.
- ③ Push [DN ▼] or [▲ UP] to select the programmed scan item.
  - “P-SCAN” is displayed.
- ④ Rotate the tuning dial to select the desired scanning range from 1A-1b, 2A-2b and 3A-3b.
  - Push [M-CL 5] for 1 sec. to return to the default setting.
- ⑤ Push [SCAN .] to exit from the scan set mode.

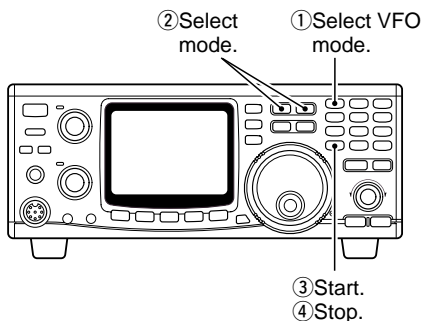

### Starting the programmed scan

- ① Push [M/S•BAND] or [SUB] to select the desired frequency band to be scanned.
- ② Push [V/M 1] to select VFO mode.
- ③ Select the desired operating mode.
  - The operating mode can also be changed while scanning.
- ④ Push [SCAN .] to start the programmed scan.
  - “SCAN” indicator flashes.
  - The tuning step setting is used for the scanning step.
  - 1 kHz or 1 MHz tuning step can also be used as the scanning step.
- ⑤ Push [SCAN .] to cancel the scan.

/// If the same frequency is programmed into the scan edge memory channel 1A and 1b, 2A and 2b or 3A and 3b, programmed scan does not start.

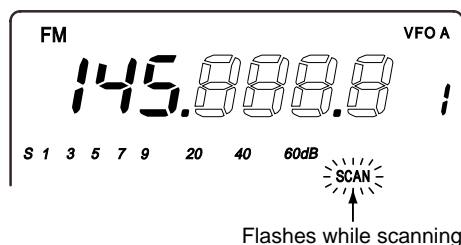

## Memory scan operation

Scans programmed memory channels only. Blank channels and programmed scan edge channels (1A/1b, 2A/2b and 3A/3b) are not scanned.

- ① Push [M/S•BAND] or [SUB] to select the desired frequency band to be scanned.
- ② Push [V/M 1] to select memory mode.
- ③ Push [SCAN .] to start the memory scan.
  - “SCAN” indicator flashes.
  - Pushing [SPCH•LOCK] for 1 sec. during scan starts mode select scan and “LOCK” indicator appears. (p. 47)
- ④ Push [SCAN .] to cancel the scan.

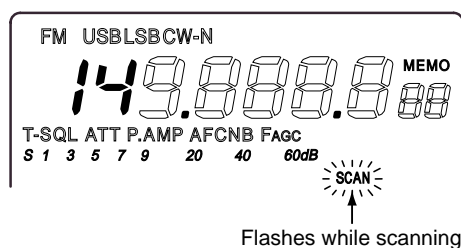
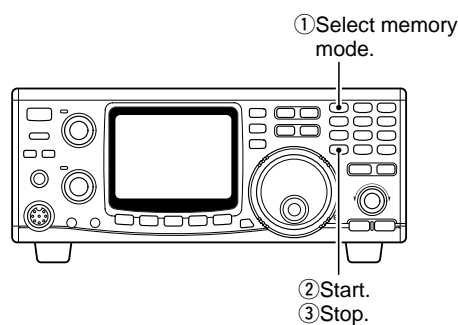



## ■ Mode select scan

Scans the memory channels, desired operating mode is programmed, only.

- ① Push [M/S•BAND] or [SUB] to select the desired frequency band to be scanned.
- ② Push [V/M 1] to select memory mode.
- ③ Push [SSB/CW] or [FM] to select the desired operating mode to be scanned.
  - The operating mode can also be changed during scan.
- ④ Push [SPCH•LOCK] for 1 sec.
  - “LOCK” indicator appears.
- ⑤ Push [SCAN .] to start the mode select scan.
  - “SCAN” indicator flashes.
- ⑥ Push [SCAN .] to cancel the scan.

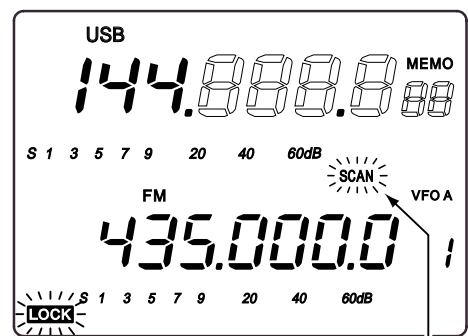
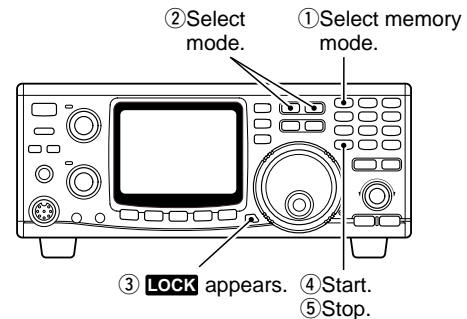

Flashes while scanning

## ■ Tone scan

The transceiver can detect a subaudible tone frequency in a received signal. By monitoring a signal that is being transmitted on a repeater input frequency, you can determine the tone frequency required to access the repeater.

- ① Set the desired frequency or memory channel to be checked for a tone frequency.
- ② Push [FM] to select FM mode.
- ③ Push [TONE] or [CALL•T-SQL] for 1 sec. to activate the subaudible tone.
  - “T” or “T-SQL” indicator appears.
- ④ Push [SCAN .] for 1 sec. to start the tone scan.
  - “SCAN” indicator flashes while scanning.
  - Scan stops when a subaudible tone is detected.
  - Scan becomes slower or quicker, respectively when the noise squelch is open or closed.
- ⑤ Push [SCAN .] for 1 sec. to cancel the scan.

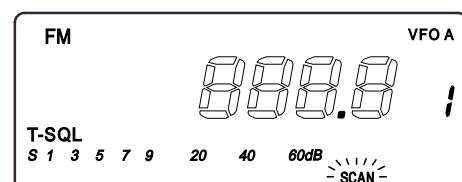
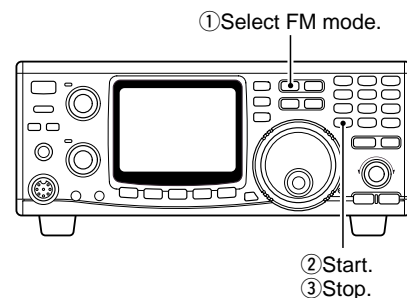

Flashes while scanning

/// **NOTE:** The tone scan automatically changes tone frequency setting to the detected tone frequency.

## ■ Satellite communications outline

Both satellite mode B (435 MHz uplink, 145 MHz downlink) and mode J (145 MHz uplink, 435 MHz downlink) can be operated from the IC-910H, and mode L can be operated when the optional UX-910 1200 MHz BAND UNIT is installed.

Satellite communications is possible only when a satellite is in view and its transponder is activated.

### Orbit information

Orbit information describes satellite location, reaching angles, etc. This information may be available in ham magazines or organization issues, such as from ARRL, RSGB handbook, etc.

Appropriate satellite tracking software is also convenient.

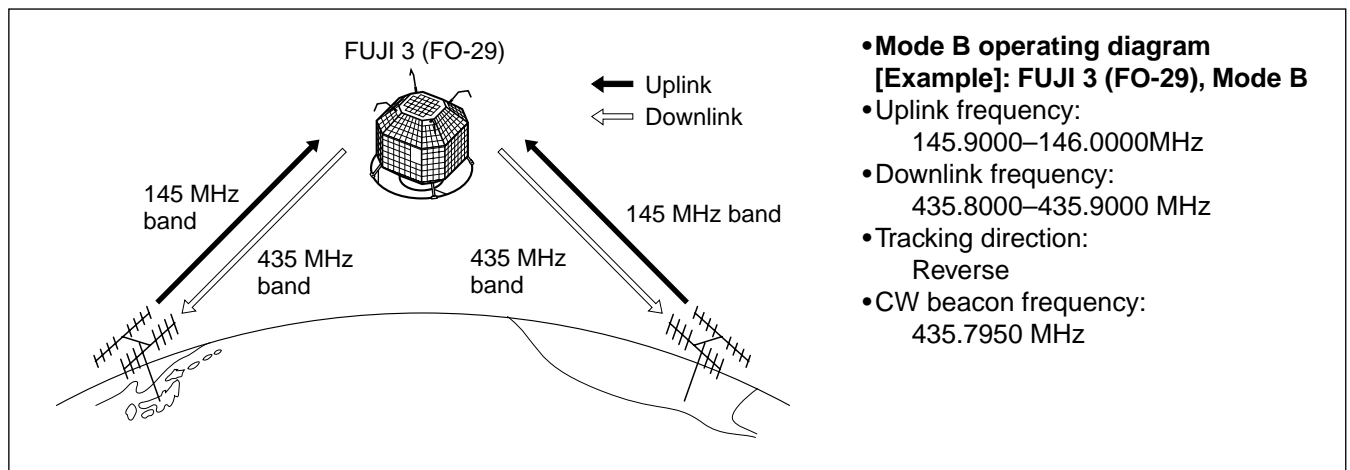

## ■ Satellite notes

1. **NEVER** set the output power too high. Too much power will shorten the satellite's life. Set your transmit power so that your downlink signal level is lower than the beacon's signal level.
2. Confirm a satellite's operating mode in advance through documentation (magazines, etc.) or via appropriate satellite tracking software. In the wrong mode, you cannot use the satellite even if you receive its beacon signal.
3. Preamplifiers may be necessary to receive satellite signals. Optional AG-25, AG-35 and AG-1200 (for UX-910) are available to use with the IC-910H. (p. 16)
4. When you use a reverse tracking satellite in SSB mode, use the LSB for the uplink frequency and USB for the downlink frequency.
  - When using a normal tracking satellite in SSB mode, use USB for both the uplink and downlink frequencies.

## ■ Entering into the satellite mode

Operating frequencies in satellite mode can be set both before and after entering into the satellite mode. Normal and reverse tracking are available.

### ◆ Transferring the VFO frequency to the satellite VFO

- ① Set the downlink frequency (receive) in the MAIN band.
- ② Set the uplink frequency (transmit) in the SUB band.

- ③ Push [SATELLITE] for 1 sec. to transfer the frequencies, set in steps ① and ②, into the satellite VFO.

- Satellite mode is automatically selected after transferring.
- "SATL" indicator with either "NOR" or "REV" indicator appears.
- VFO and memory mode indications are displayed in the SUB band (lower area) during satellite mode.

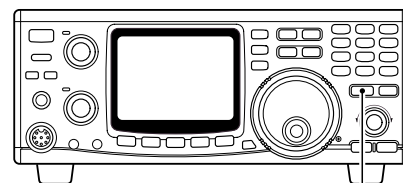

[SATELLITE] for 1 sec.

## ■ Setting the satellite VFO

- ① Push [SATELLITE] to enter the satellite mode.
  - “SATL” indicator with either “NOR” or “REV” indicator appears.
- ② Push [V/M 1] to toggle satellite VFO and memory mode.
  - VFO or memory mode indicator is displayed in the SUB band (lower area).
- ③ Push [SCAN . M] to enable the downlink frequency tuning.
  - Uplink frequency indication disappears.
  - Rotate the tuning dial to set the downlink frequency and push [SSB/CW] to select the operating mode.
  - Push [SCAN . M] again after the tuning.

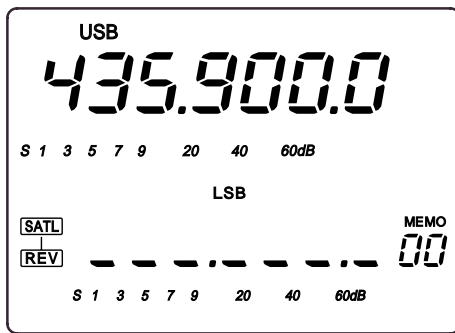

- ④ Push [SWP 0 S] to enable the uplink frequency tuning.
  - Downlink frequency indication disappears.
  - Push [SWP 0 S] again after the tuning.

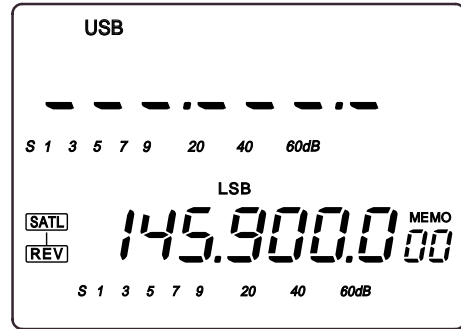

**NOTE:** To select the operating mode for the uplink, push [SUB] to enable the SUB band access.

## ■ Tracking selection

- Push [F-INP ENT NOR↔REV] for 1 sec. to switch between normal and reverse tracking.

### ◆ Normal tracking

Both downlink and uplink frequencies increase or decrease in the same step simultaneously by tuning dial rotation.

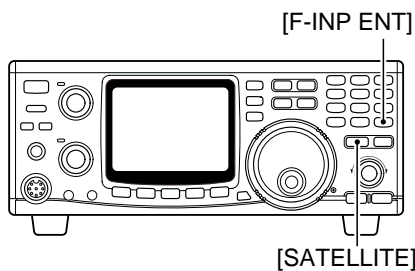

### ◆ Reverse tracking

The downlink frequency follows the tuning dial rotation, however, the uplink frequency changes in the reverse direction to the tuning dial rotation in the same step.

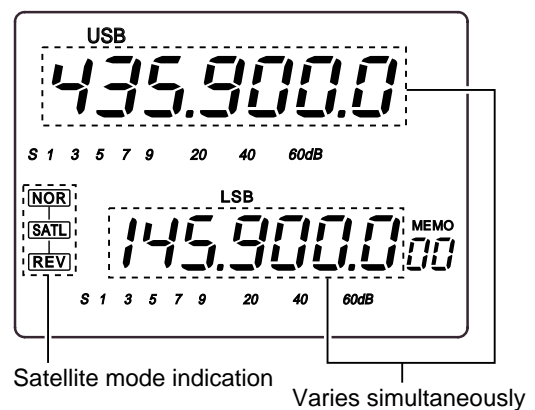

## 8 SATELLITE OPERATION

### ■ Preparation

- ① Decide on a usable satellite.
- ② Confirm the approximate location of the satellite and operating mode (e.g. "B," "J," etc.) through documentation (magazine, etc.) or via appropriate satellite tracking software.
- ③ Set the antenna direction for the desired satellite.
- ④ Select satellite mode on the transceiver.
  - Push [SATELLITE].
  - Push [F-INP ENT] [NOR↔REV] for 1 sec. to select tracking mode if desired.
- ⑤ Select operating mode.

Satellite	Downlink (MAIN band)	Uplink (SUB band)
Reverse tracking type	USB (or CW)	LSB (or CW)
Normal tracking type	USB (or CW)	USB (or CW)

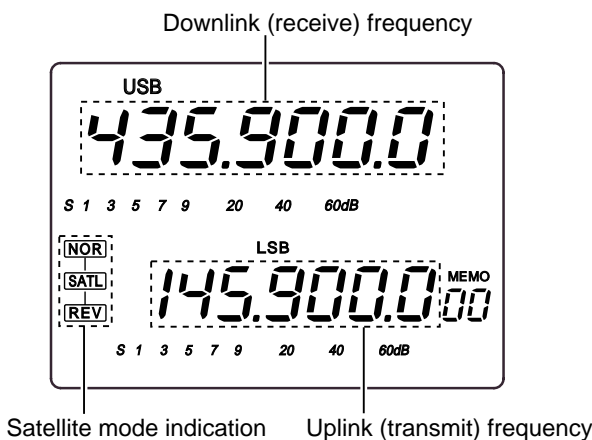

- ⑥ Set the downlink frequency (MAIN band) to the beacon frequency.
  - Refer to a ham magazine or book for detailed information.
  - Adjust the antenna direction so that the S-meter shows to its strongest level.
  - The S-meter level should be noted for transmit power adjustment during a loop test.

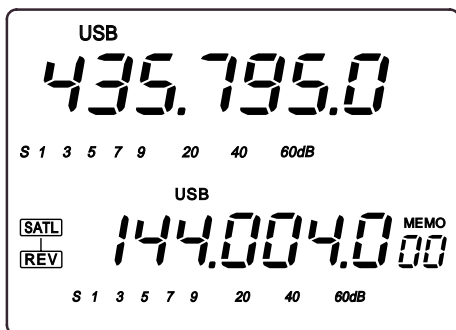

- ⑦ Perform a loop test.
  - Set the downlink frequency (MAIN band) to a vacant frequency within the satellite's coverage.
  - Push [SWP 0] then, set the uplink frequency (SUB band) while transmitting a single tone such as a whistle to find your downlink signal and monitor your own signal correctly. Push [SWP 0] after setting.

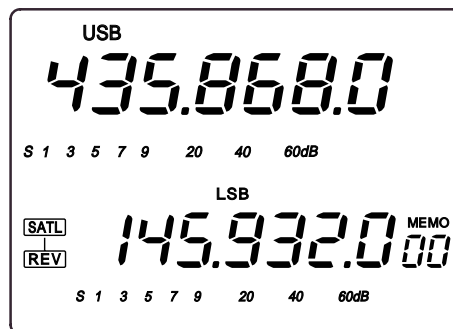

**NOTE:** To avoid excessive power, set the output power so that the downlink signal strength is lower than the beacon's strength.

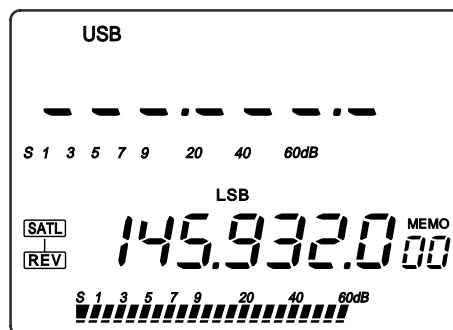

- ⑧ Set the desired frequency to begin your satellite communications.
  - Both the downlink and uplink frequencies are changed simultaneously.
- ⑨ When your downlink audio drifts (Doppler effect), push [SWP 0] then rotate the tuning dial to adjust the uplink frequency (SUB band) only. Push [SWP 0] again after setting.
  - When a particular station's audio is off frequency, use the RIT function (push [RIT]).
- ⑩ To exit the satellite operation, push [SATELLITE].

**CONVENIENT:** As the transceiver has 10 satellite memory channels, once set, desired satellite frequencies can be recalled instantly.

**NOTE:** As the downlink (MAIN band) signal is applied to the SUB band unit in-circuitry in satellite mode, an optional FL-133 CW NARROW FILTER is necessary to operate CW-N mode.

## ■ Satellite operation

When your own signal can be received with a loop test, satellite communication can be performed.

- ① Rotate the tuning dial to re-tune the uplink frequency after pushing [SWP 0  $\square$ ], when shifting a frequency with the Doppler effect.
  - The downlink frequency readout (MAIN band) disappears.
- ② Rotate the tuning dial to re-tune the downlink frequency after pushing [SCAN .  $\square$ ], when the operating station's signal frequency is shifted.
  - RIT function can also be used for downlink frequency tuning within  $\pm 1$  kHz range.

## ■ Satellite memory

The IC-910H has 10 satellite memory channels to memorize both uplink and downlink frequencies and operating modes, etc.

### ◆ Satellite memory selection

- ① Push [SATELLITE] to enter the satellite mode.
- ② Push [V/M 1] to select satellite memory mode.
  - “MEMO” indicator and memory channel number are displayed beside the uplink frequency (SUB band) indication.
  - Push [V/M 1] again to select satellite VFO.
- ③ Push [DN  $\blacktriangledown$ ] or [ $\blacktriangle$  UP] to select the desired satellite mode memory channel.
  - The channels 00–09 are selectable.
  - By pushing and holding either switch, the satellite memory channel changes continuously.

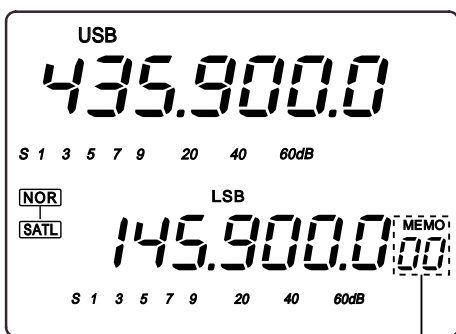

Satellite memory indication

### ◆ Satellite memory programming

- ① Select the desired satellite memory channel.
  - Push [SATELLITE] to enter the satellite mode.
  - Push [V/M 1] to select satellite VFO mode.
  - Push [DN  $\blacktriangledown$ ] or [ $\blacktriangle$  UP] to select the desired satellite mode memory channel.
- ② Set the desired downlink frequency to the MAIN band and uplink frequency to the SUB band, as well as operating mode.
  - Push [SCAN .  $\square$ ] for downlink tuning, push [SWP 0  $\square$ ] for uplink frequency tuning.
  - Push [SUB] before the operating mode selection when selecting operating mode for the uplink.
- ③ Push [MW 4] for 1 sec. to program the set contents to the satellite memory channel.
  - 3 beep tones sound.

/// **NOTE:** Tracking selection, normal or reverse, is not programmed in the satellite memory channels.

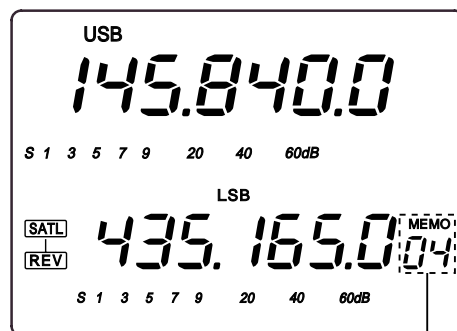

Select the desired satellite memory

## ■ Functions for AFSK

The IC-910H does not have an FSK mode for RTTY, AMTOR, PACKET, etc., however, you can operate these using AFSK in SSB or FM mode.

The transceiver accepts data speed of up to 9600 bps. When using 9600 bps, set the transceiver to the 9600 bps data mode using the general set mode. (p. 57)

When operating AFSK, connect external equipment to the DATA (MAIN or SUB) or ACC socket on the rear panel, or to the microphone connector on the front panel as in the diagram below.

### OPERATION NOTES FOR 9600 bps

- Set the transceiver to 9600 bps data mode. - See p. 57.
- Set AFSK/GMSK output level of the terminal unit to 0.4 V p-p (0.2 V rms).  
- When exceeding 0.5 V p-p (0.25 V rms), the transceiver's modulation limiter stops modulation.  
- At this time, the [RX/TX] indicator's brightness fades.
- AF output from the transceiver is continuous and is not cut by the squelch circuit.

## ■ Connections for AFSK

### ◆ Connections via [DATA] socket

Use FM mode for 9600 bps operation.  
Use SSB or FM mode for 1200 bps operation.

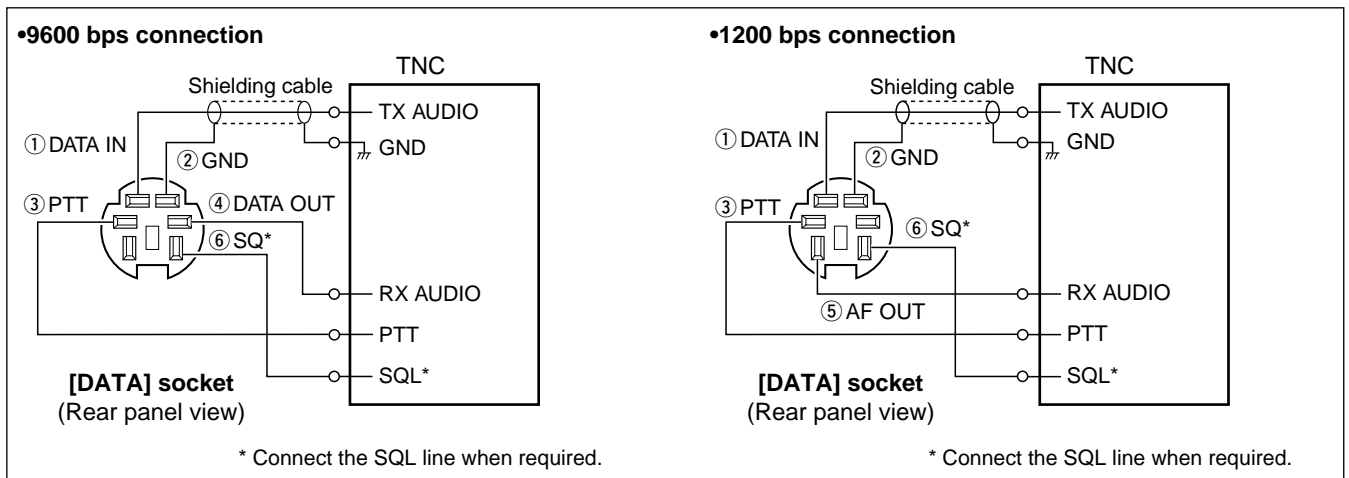

### ◆ Connections via [ACC(1)] socket or [MIC] connector

Use FM mode for 9600 bps operation.  
Use SSB or FM mode for 1200 bps operation.

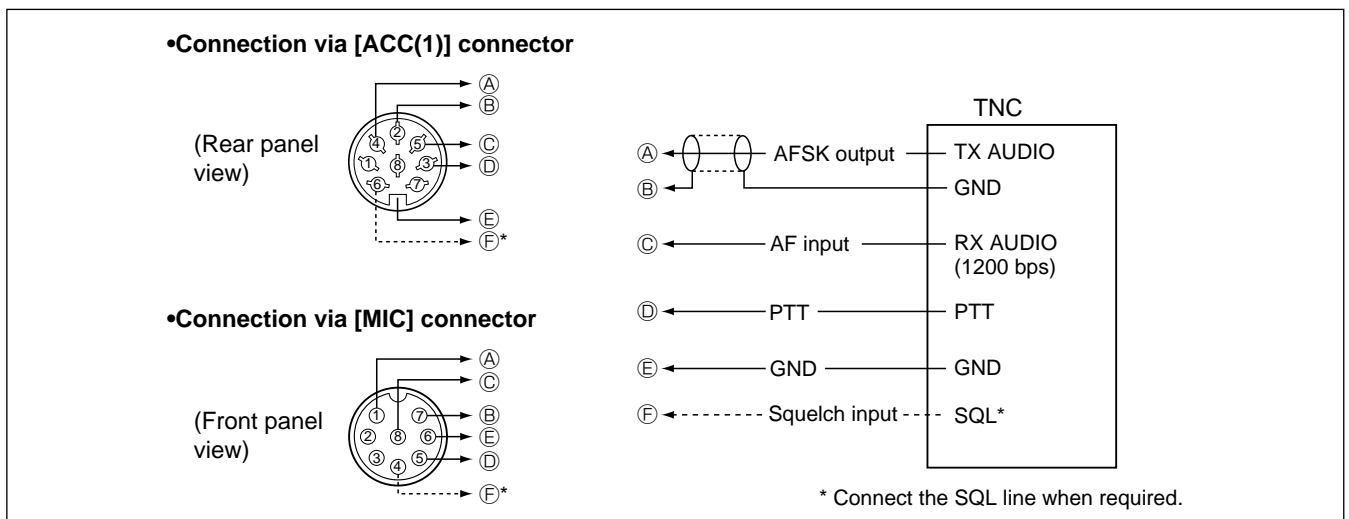

## ■ Operating mode notes

Use FM mode for 9600 bps operation.  
Use SSB or FM mode for 1200 bps operation.

## ■ AFSK operation

Connect external equipment to either the [DATA] (MAIN or SUB) or [ACC(1)] socket as described on the previous page. Set the ACC socket using the general set mode in advance when you operate via the ACC socket. (See below.)

- ① Push [M/S•BAND] to select the desired frequency band.
- ② Push [FM] or [SSB/CW] to select the desired operating mode.
  - LSB is normally used.
  - FM is used for PACKET.
- ③ Adjust the audio output level with [AF] control.
  - Use [RF/SQL] when required.
- ④ Adjust the desired RF output power.
  - When using the [MIC] connector for external equipment connection, the [MIC GAIN] control should be adjusted.
- ⑤ Select operating mode.
- ⑥ Control the transceiver from the connected PC or TNC (TU).

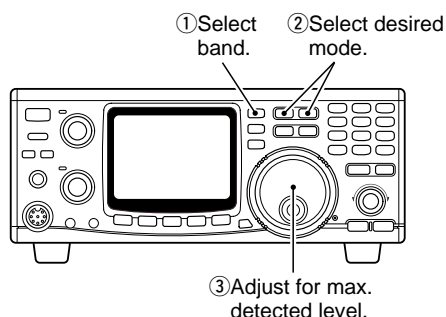

## ■ Operating frequency notes

### ◆ Operating notes for RTTY and AMTOR

RTTY or AMTOR operating frequency in LSB mode differs from the displayed frequency.

**[Your operating freq.] = [Displayed freq.] – 2125 Hz**  
(when the frequencies of the RTTY demodulator in your TNC or TU are — mark = 2125 Hz and space = 2295 Hz).

### ◆ Operating notes for PACKET

PACKET operating frequency in LSB mode differs from the displayed frequency.

**[Your operating freq.] = [Displayed freq.] – 2125 Hz**  
(when the frequencies of the PACKET demodulator in your TNC are — 2125 Hz/2315 Hz).

### ◆ Frequency setting example for AFSK

- When operating RTTY at 144.090 MHz:

Set "LSB 144.092125 MHz" (if you use mark=2125 Hz and space=2295 Hz).

- When operating PACKET at 144.110 MHz:

Set "LSB 144.112215 MHz" (if you use 2115 Hz/2315 Hz).

### IMPORTANT:

- Remove the microphone from the [MIC] connector when operating below 1200 bps rate to protect from noise coming from the microphone.
- During 9600 bps rate operation, noise signals from the microphone may not effect PACKET signals. However, PACKET signal transmission is interrupted when [PTT] is pushed.
- Remove the ACC plug, or turn the TNC power OFF during phone operation (SSB or FM). The modulation input from the [ACC(1)] socket is always applied to the modulation circuit.

### ◆ Connections via front panel

When connecting a TNC or Scan converter, etc. to the [MIC] connector, [MIC GAIN] and [AF] adjustments are required. The [MIC] connector accepts up to 1200 bps. Use SSB or FM mode for operation.

▨ [MIC GAIN] and [AF] control adjustments are required.

### ◆ Adjusting the transmit signal output from the TNC

When setting the data transmission speed to 9600 bps, the data signal coming from the TNC is applied exclusively to the internal limiter circuitry to control the transmission.

/// **NEVER** apply data levels from the TNC of over 0.6 V p-p, otherwise the transceiver automatically cancels the transmission.

#### 1. When using a level meter or synchroscope, adjust the TX audio output level (DATA IN level) from the TNC as follows.

0.4 V p-p (0.2 V rms): recommended level  
0.2–0.5 V p-p (0.1–0.25 V rms): acceptable level

#### 2. When NOT using a measurement device.

- ① Connect the transceiver to a TNC.
- ② Enter a test mode (“CAL”, etc.) to the TNC, then transmit some test data.
- ③ *When the transceiver fails to transmit the test data or transmits sporadically (TX indicator does not appear or flashes):*  
- Decrease the TNC output level until the transmit indicator lights continuously.  
*When transmission is not successful even though the TX indicator lights continuously:*  
- Increase the TNC output level.

## ■ Setting the ACC socket

When operating AFSK, set the specifications of the ACC socket to fit your TNC or scan converter in advance.

- ① Push [SET] for 1 sec. to enter the set mode.
- ② Push [DN ▼] or [▲ UP] to select the 9600 bps data mode setting item, then rotate the tuning dial to turn the 9600 bps rate ON and OFF  
Push [SWP 0] again after setting.
  - “9600” is displayed.
  - 9600 bps data rate is selected when ON, and a slower data rate is selected when OFF is selected.
  - Push [M-CL 5] for 1 sec to return to the default setting.
- ③ Push [▲ UP] to select ACC socket pins 5 and 6 setting item, then rotate the tuning dial to select from “nor” (normal) and “Sub” (sub).
  - “ACC P5.6” is displayed.
  - When “nor” (normal) is selected, the ACC socket (pins 5 and 6) outputs MAIN band signals. When “Sub” is selected, the ACC socket outputs SUB band signals.
  - Push [M-CL 5] for 1 sec to return to the default setting.

/// **NOTE:** Select “nor” (normal) when operating data mode in satellite mode.

- ④ Push [▲ UP] to select the modulation signal input level setting item, then rotate the tuning dial to select from “HI” and “Lo” (sub).
  - “ACC.t-AF” is displayed.
  - HI: 200 mV rms, Lo: 2 mV rms
  - Push [M-CL 5] for 1 sec to return to the default setting.
  - This setting is ignored when 9600 bps data mode (②) is selected and 1.0 V p-p is set as a fixed value.
- ⑤ Push [SET] to exit from the set mode.



## ■ Set mode description

Set mode is used for programming infrequently changed values or conditions of functions. The IC-910H has a regular set mode and additional 12 independent set modes for simple condition changing.

### ◇ Set mode operation

- ① Push [SET] for 1 sec. to enter the general set mode.
- ② Push [DN ▼] or [UP ▲] to select the desired item.
- ③ Set the desired condition using the tuning dial.
  - Push [M-CL 5] for 1 sec. to select a default condition or value.
- ④ Push [SET] to exit the set mode.

### ◇ Independent set mode operation

- ① Push [SET].

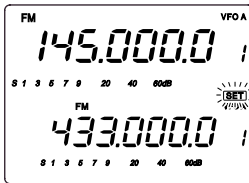

- ② Push 1 of following switches/keys to enter the independent set mode.  
[SPCH], [FM], [SSB/CW], [SCAN], [MPW], [COMP], [VOX], [TRANSMIT], [NR], [RIT], [ATT], [SWP]

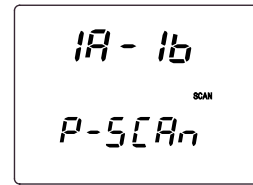

- ③ Push [DN ▼] or [UP ▲] to select the desired item.
- ④ Set the desired condition using the tuning dial.
  - Push [M-CL 5] for 1 sec. to select a default condition or value.

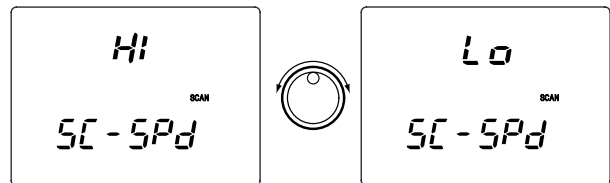

- ⑤ Push the applicable switch, pushed in step ②, or [SET] to exit the set mode.

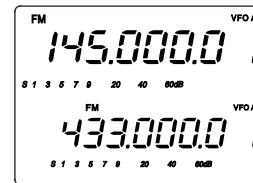

### •SET MODE FLOW CHART

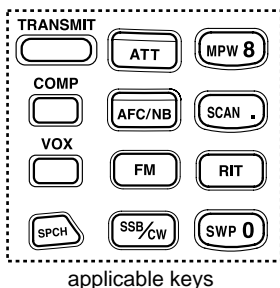
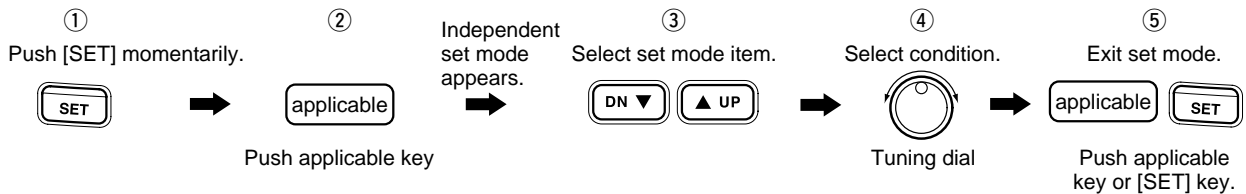
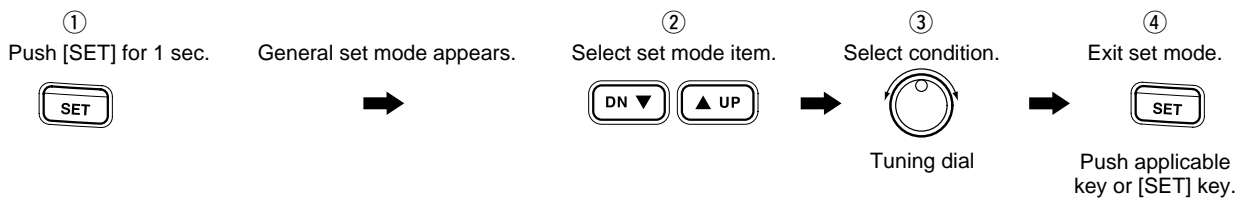

## ■ General set mode

### Display backlight brightness

Adjust backlight brightness for the function display to the desired level within 0 (dark) to 100 (bright) range.



### Beep tone

Adjust key touch beep output level to the desired level within 0 (no output) to 100 (max. output) range.



### RF/SQL control assignment

Assign [RF/SQL] control function from rF/SqL, Auto and SqL.

- rF/SqL : RF gain and squelch controls are combined for SSB/CW mode. Acts as squelch control for FM mode.
- Auto : Acts as either an RF gain or squelch control depending on operating mode.
- SqL : Acts as squelch control for all modes. RF gain is set to maximum level in this setting.

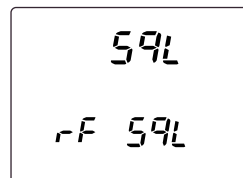
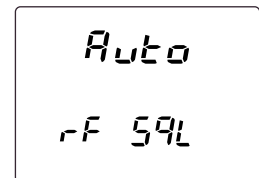
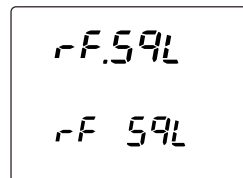

### Peak hold function

Turn the S-meter peak hold function ON or OFF. The peak level is indicated for approx. 0.5 sec. when this function is activated.

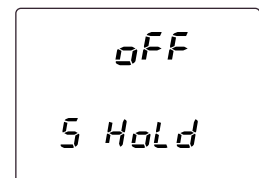
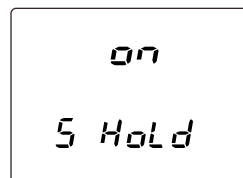

**Microphone UP/DN speed**

Select continuous changing speed with microphone's [UP]/[DN] operation from high and low.

Tuning step selection	HI	Lo
Below 1 kHz	50 steps/sec.	25 steps/sec.
Above 1 kHz below 1 MHz	20 steps/sec.	10 steps/sec.
1 MHz or Memory Channel	5 steps/sec.	2.5 steps/sec.

HI  
ud

Lo  
ud

**9600 bps data transmission**

Turn the 9600 bps data transmission capability ON and OFF.

- on : For 9600 bps data transmission.
- off : For the regular audio (or slower data) transmission only.

off  
9600

on  
9600

**Auto TS function**

Turn the auto TS function ON and OFF.

This function temporarily changes tuning step when rotating the tuning dial quickly.

The auto TS function automatically selects a 10 or 50 Hz tuning step, when 1 or 10 Hz tuning step is used for regular operation, respectively.

on  
Auto-tS

off  
Auto-tS

**Fine tuning indication**

Turn the fine tuning indication (10 and 1 Hz digit indication) during the tuning dial rotation ON and OFF.

Fine\_on  
Fr-diSP

Fine\_off  
Fr-diSP

**Headphone audio**

Switch the audio output separation capability for the headphones ON and OFF.

- on : The MAIN and SUB band audio is separated in right (MAIN) and left (SUB) channels when using stereo headphones.
- off : The MAIN and SUB band audio is mixed.

on  
SEPA

off  
SEPA

**ACC socket Pin 5 and Pin 6**

Select the band for output signals from the ACC socket pins 5 (AF) and 6 (SQL) from normal and sub.

- nor : Outputs MAIN band's signals.
- Sub : Outputs SUB band's signals.

nor  
ACC P5.6

Sub  
ACC P5.6

**ACC socket Pin 8**

Assign the ACC socket pin 8 action/connection from ALC and microphone up/down.

- ALC : Inputs ALC signal.
- ud : Inputs up/down signals from the microphone.

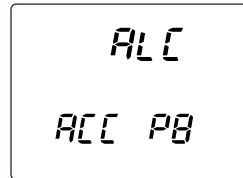

**ACC socket Pin 4/DATA socket Pin 1**

Select modulation signal input level from high and low.

- HI : High modulation signal level (200 mV rms)
- Lo : Low modulation signal level (2 mV rms)

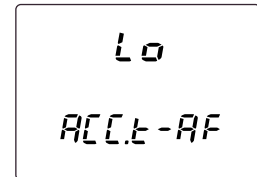

**ACC socket Pin 3 for 144 MHz band**

Switch the SEND signal output for 144 MHz band operation ON and OFF.

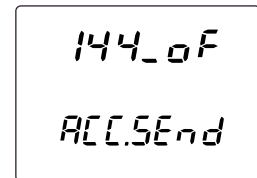
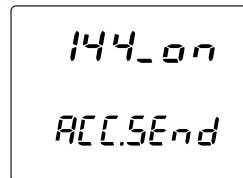

**ACC socket Pin 3 for 430(440) MHz band**

Switch the SEND signal output for 430(440) MHz band operation ON and OFF.

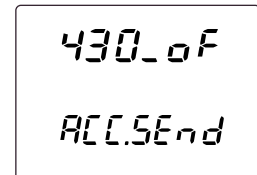
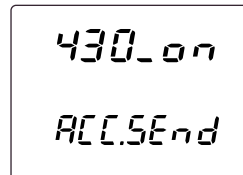

**ACC socket Pin 3 for 1200 MHz band**

Switch the SEND signal output for 1200 MHz band operation ON and OFF.

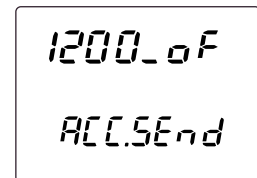
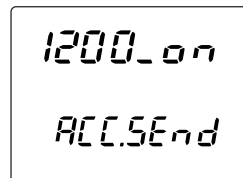

**Preamplifier controller for 144 MHz**

Switch the preamplifier control capability ON and OFF. When using the optional AG-25, ON must be selected. Otherwise, the preamplifier is never activated.

/// **DO NOT** connect any equipment, such as an SWR or power meter, between the transceiver and preamplifier. In such case, the preamplifier may not activate properly.

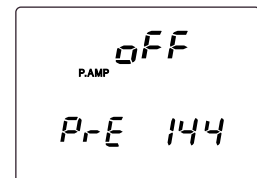
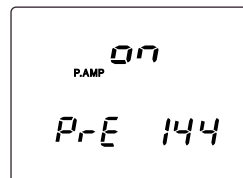

**Preamplifier controller for 430(440) MHz**

Switch the preamplifier control capability ON and OFF. When using the optional AG-35, ON must be selected. Otherwise, the preamplifier is never activated.

**DO NOT** connect any equipment, such as an SWR or power meter, between the transceiver and preamplifier. In such case, the preamplifier may not activate properly.

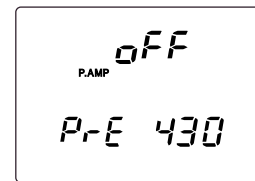
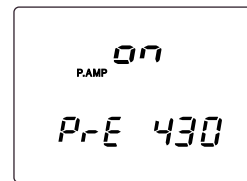
**Preamplifier controller for 1200 MHz**

Switch the preamplifier control capability ON and OFF. When using the optional AG-1200, ON must be selected. Otherwise, the preamplifier is never activated.

**DO NOT** connect any equipment, such as an SWR or power meter, between the transceiver and preamplifier. In such case, the preamplifier may not activate properly.

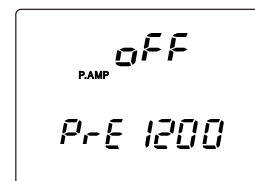
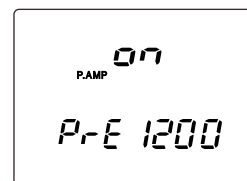
**CI-V address**

To distinguish between equipment, each CI-V transceiver has its own Icom standard address in hexadecimal code. The IC-910H's address is 60H.

When 2 or more IC-910Hs are connected to an optional CT-17 CI-V LEVEL CONVERTER, select a different address for each IC-910H in the range 01H to 7FH.

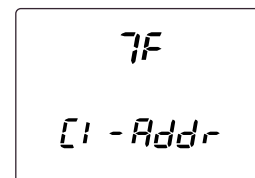
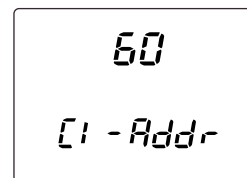
**CI-V baud rate**

Select transfer rate for CI-V remote control from Auto, 300, 1200, 4800, 9600 and 19200 bps.

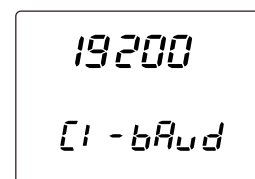
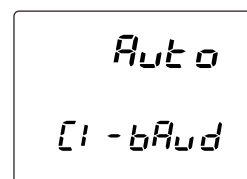
**CI-V transceive**

Transceive operation is possible with the IC-910H connected to other Icom transceivers or receivers.

When "on" is selected, changing the operating frequency, operating mode, etc. on the IC-910H automatically changes those of connected transceivers (or receivers) and vice versa.

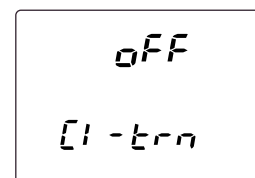
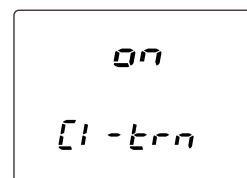

## ■ FM set mode

### Offset frequency for 144 MHz

Set the offset frequency for duplex (repeater) operation within 0–10.00000 MHz range.

This item is displayed when the 144 MHz band is accessed, including the SUB band access capability.

•Default value: 0.6000

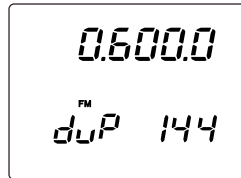

### Offset frequency for 430(440) MHz

Set the offset frequency for duplex (repeater) operation within 0–10.00000 MHz range.

This item is displayed when the 430(440) MHz band is accessed, including the SUB band access capability.

•Default value: 5.0000

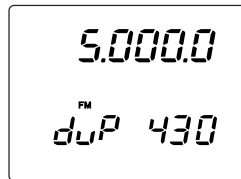

### Offset frequency for 1200 MHz

Set the offset frequency for duplex (repeater) operation within 0–100.00000 MHz range.

This item is displayed when the 1200 MHz band is accessed, including the SUB band access capability.

•Default value: 20.0000

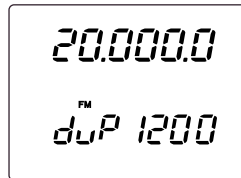

### Tone encoder frequency for 144 MHz (non-European versions)

Select tone encoder frequency for accessing a repeater, etc. from one of 50 available tone frequencies.

This item is displayed when the 144 MHz band is accessed, including the SUB band access capability.

•Default value: 88.5

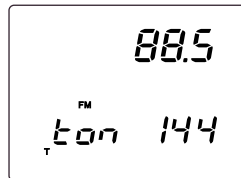

### Tone encoder frequency for 430(440) MHz (non-European versions)

Select tone encoder frequency for accessing a repeater, etc. from one of 50 available tone frequencies.

This item is displayed when the 430(440) MHz band is accessed, including the SUB band access capability.

•Default value: 88.5

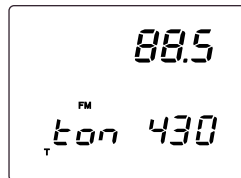

### Tone encoder frequency for 1200 MHz (non-European versions)

Select tone encoder frequency for accessing a repeater, etc. from one of 50 available tone frequencies.

This item is displayed when the 1200 MHz band is accessed, including the SUB band access capability.

•Default value: 88.5

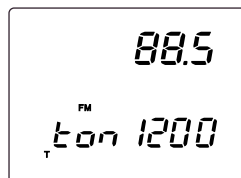

### Tone squelch frequency for 144 MHz

Select tone squelch frequency from one of 50 available tone frequencies.

This item is displayed when the 144 MHz band is accessed, including the SUB band access capability.

•Default value: 88.5

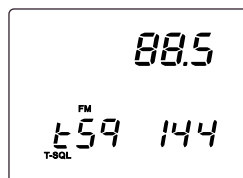

### Tone squelch frequency for 430(440) MHz

Select tone squelch frequency from one of 50 available tone frequencies.

This item is displayed when the 430(440) MHz band is accessed, including the SUB band access capability.

•Default value: 88.5

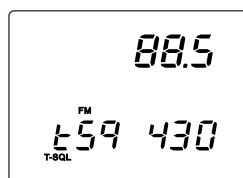

### Tone squelch frequency for 1200 MHz

Select tone squelch frequency from one of 50 available tone frequencies.

This item is displayed when the 1200 MHz band is accessed, including the SUB band access capability.

•Default value: 88.5

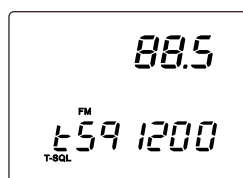

### One-touch repeater shift direction (non-European versions)

Select shift direction for one-touch repeater function from DUP- and DUP+.

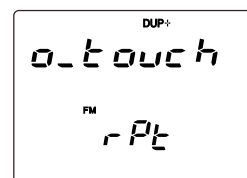

### Auto repeater function (U.S.A. and Korea versions)

Turn the auto repeater function ON and OFF.

To activate the auto repeater function, ON must be selected in this setting after programming the auto repeater frequency range. (p. 34)

#### U.S.A. version:

- “on1” Activates duplex only.
- “on2” Activates duplex and tone.
- “oFF” Auto repeater function is turned OFF.

#### Korea version:

- “ON” Activates duplex and tone.
- “OFF” Auto repeater function is turned OFF.

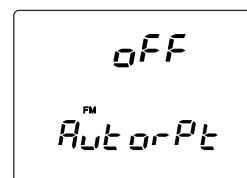
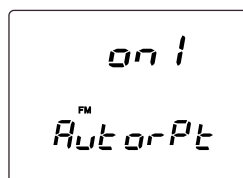

### FM center indicator

Turn the FM center indication ON and OFF.

When the indication is turned ON and the received signal is off-center in FM mode, the receive indicator (green) flashes.

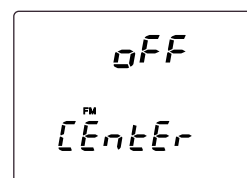
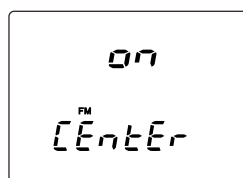

## ■ SSB/CW set mode

### Squelch threshold

Select the squelch threshold level from 12 and 13 o'clock.

- 12 : The squelch closes around the 12 o'clock position of the [SQL] control.
- 13 : The squelch closes around the 13 o'clock position of the [SQL] control.

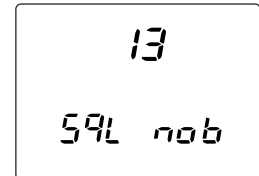
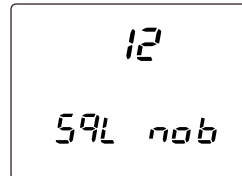

### Carrier frequency

Adjust the carrier frequency for SSB (USB/LSB) mode operation within -200 to +200 Hz range in 10 Hz steps.

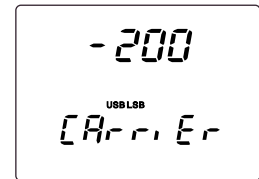
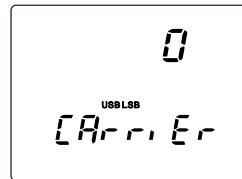

### CW pitch frequency

Adjust the CW pitch frequency within 300 to 900 Hz range in 10 Hz steps.

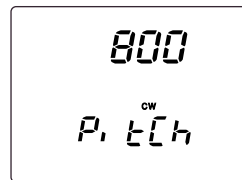

### CW keying speed adjustment

Adjust the built-in electric keyer keying speed to the desired level within 6 to 60 WPM range.

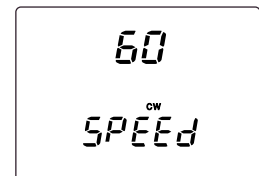
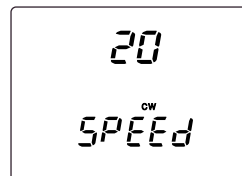

### Semi break-in

Turn the semi break-in function ON and OFF.

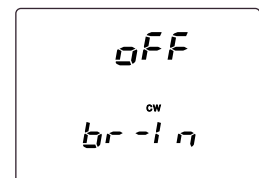
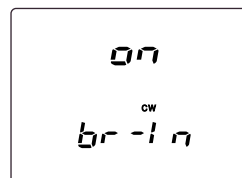

### CW break-in delay

Adjust the CW break-in delay time to the desired level within 2.0 to 13.0 sec. range in 0.1 sec. steps.

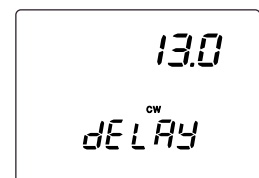
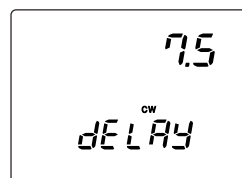



### AF control relation

Turn the relation of [AF] control for CW side tone output level ON and OFF.

- on : CW side tone output level is adjustable via [AF] control adjustment.
- oFF : CW side tone output level is fixed regardless of [AF] control setting.

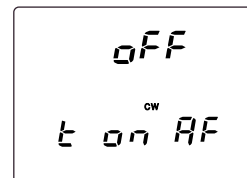

### CW side tone output level

Adjust the CW side tone output to the desired level within 0 (no output) to 100 (maximum output) range.

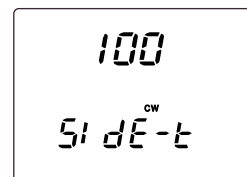
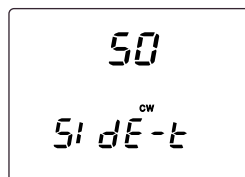

### Key type

Select the key type from normal, reverse, bug, OFF and microphone [UP]/[DN].

- n : Use built-in electronic keyer.
- r : Use built-in electronic keyer with reversed polarity.
- buG : Use built-in electronic keyer as bug key.
- oFF : Use external electronic keyer or straight key.
- ud : Use microphone's [UP]/[DN] as a paddle.

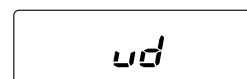
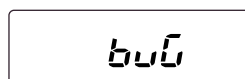
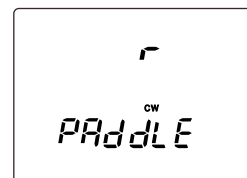
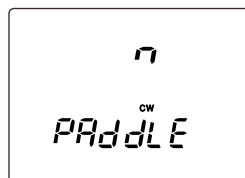

### CW dot-dash ratio

Adjust the CW dot-dash ratio to the desired level within 1:1:2.8 to 1:1:4.5 range.

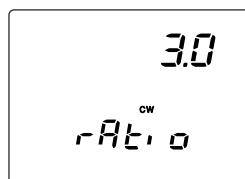

### C/N type for 1200 MHz

Select the C/N type for the 1200 MHz band operation from type 1 and 2.

- tyPE 1 : Provides better characteristics for nearby interference in FM mode operation.
- tyPE 2 : Provides lower noise level just around the signal in SSB/CW mode operation.

This item is displayed only when the optional UX-910 is installed.

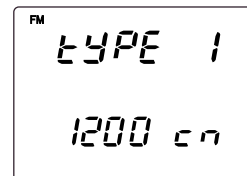
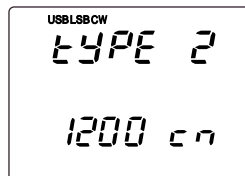

## ■ Scan set mode

### Programmed scanning range

Select the programmed scan range from 1A-1b, 2A-2b and 3A-3b.

- 1A-1b : Scans within the range programmed in the memory channel 1A and 1b.
- 2A-2b : Scans within the range programmed in the memory channel 2A and 2b.
- 3A-3b : Scans within the range programmed in the memory channel 3A and 3b.

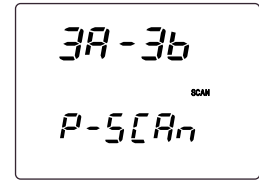
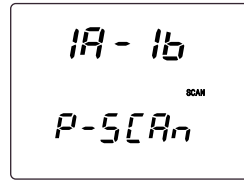

### Scan resume condition

Select the scan resume condition from ON and OFF.

- on : Scan resumes.
- oFF : Scan cancels when a signal is received.

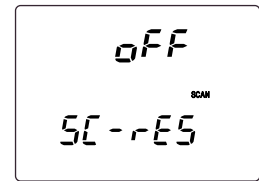
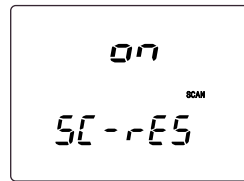

### Scanning speed

Select the scanning speed from high and low.

Scan type	HI	Lo
Memory scan (Mode select)	20 CH/sec.	10 CH/sec.
Prog. scan (TS<1 kHz)	50 steps/sec.	25 steps/sec.
Prog. scan (TS>1 kHz)	20 steps/sec.	10 steps/sec.
Tone scan	20 steps/sec.	10 steps/sec.

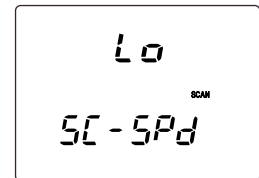
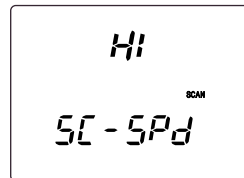

## ■ Memo pad set mode

### Number of memo pad channels

Select the number of memo pad channels available from 5 and 10.

- 5 : 5 memo pad channels can be used.
- 10 : 10 memo pad channels can be used.

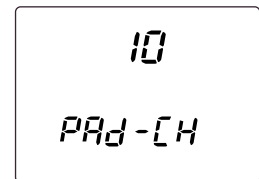
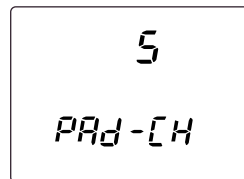

## ■ Compressor set mode

### Compression level

Adjust the compression level for the speech compressor to the desired level within 0–100% range.

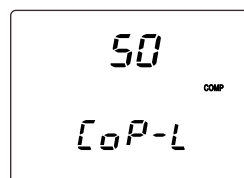

## ■ VOX set mode

### VOX sensitivity

Adjust the VOX sensitivity within 0–100% range.

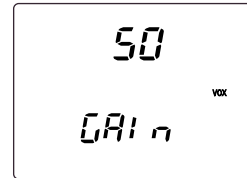

### VOX delay time

Adjust the transmit-to-receive switching delay to the desired level within 0.0 sec. to 2.0 sec. range in 0.1 sec. steps.

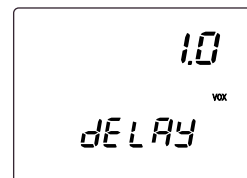

### Anti VOX

Adjust the anti VOX gain within 0–100% range.

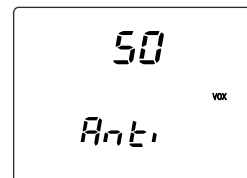

## ■ Attenuator set mode

### Attenuation level for 144 MHz

Adjust the attenuation level to the desired level within 0–100% range for the 144 MHz band operation.

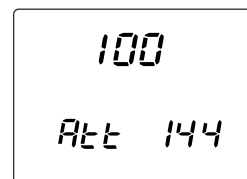

### Attenuation level for 430(440) MHz

Adjust the attenuation level to the desired level within 0–100% range for the 430(440) MHz band operation.

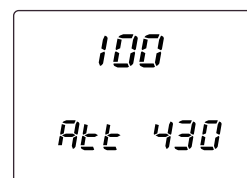

## ■ Transmit set mode

### Time-out timer

Select the time period for the time-out timer function from OFF, 3, 5, 10, 20 and 30 min.



### PTT lock

Turn the transmission inhibit capability ON and OFF. Any control for transmission is inhibited when this item is ON.

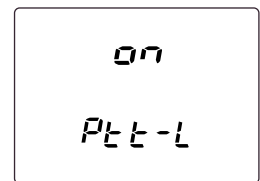
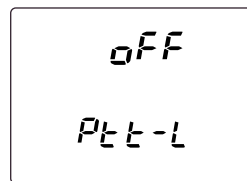

### SUB band mute

Turn the SUB band audio mute function ON and OFF. The SUB band audio is muted while transmitting when this function is turned ON.

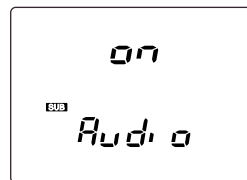

## ■ NR set mode

### Noise reduction level for 144 MHz

Adjust the noise reduction level to the desired level within 0–15 for the 144 MHz band operation.

Adjust it to the level that noise signals are reduced, and received audio has no distortion.

This item is displayed only when the optional UT-106 is installed.

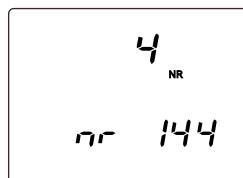

### Noise reduction level for 430(440) MHz

Adjust the noise reduction level to the desired level within 0–15 for the 430(440) MHz band operation.

Adjust it to the level that noise signals are reduced, and received audio has no distortion.

This item is displayed only when the optional UT-106 is installed.

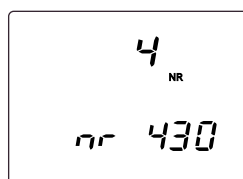

### Noise reduction level for 1200 MHz

Adjust the noise reduction level to the desired level within 0–15 for the 1200 MHz band operation.

Adjust it to the level that noise signals are reduced, and received audio has no distortion.

This item is displayed only when the optional UT-106 is installed.

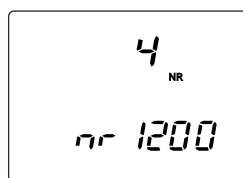

## ■ SWP set mode

### Sweeping interval

Select the sweeping interval for the simple band scope function from 3, 5 and 10 sec.

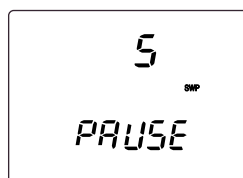

## ■ RIT/SHIFT set mode

### RIT control assignment

Assign [RIT] control function from rit, dIAL, SubdIAL and Sub-SFt.

- rit : [RIT] control functions as RIT control.
- dIAL : [RIT] control functions as tuning dial for MAIN band.
- SubdIAL : [RIT] control functions as tuning dial for SUB band.
- Sub-SFt : [RIT] control functions as IF shift control for SUB band.

rit  
rit nob

dIAL  
rit nob

SubdIAL

Sub-SFt

### SHIFT control assignment

Assign [SHIFT] control function from SFt, Sub-SFt, dIAL and SubdIAL.

- SFt : [SHIFT] control functions as IF shift control.
- Sub-SFt : [SHIFT] control functions as IF shift control for SUB band.
- dIAL : [SHIFT] control functions as tuning dial for MAIN band.
- SubdIAL : [SHIFT] control functions as tuning dial for SUB band.

SFt  
SFt nob

Sub-SFt  
SFt nob

dIAL

SubdIAL

### RIT indication

Turn the RIT adjusting value indication ON and OFF. The value is displayed while adjusting when this function is turned ON.

on  
rit di SP

off  
rit di SP

## ■ Speech set mode

### Output level

Adjust the speech audio output level within 0 (no output) to 100 (maximum output) range.

- Default value: 50

50  
SPEECH

100  
SPEECH

### Announcement language

Select the announcement language from English, Japanese and OFF.

- EnG : Announces in English.
- JPn : Announces in Japanese
- oFF : No announcement.

EnG  
SPC-LAn

JPn  
SPC-LAn

### Announcement speed

Select the announcement speed from high and low.

- HI : Faster announcement.
- Lo : Slower announcement.

HI  
SPC-SPd

Lo  
SPC-SPd

### S-meter level announcement

Turn the S-meter level announcement capability ON and OFF.

- on : Announces S-meter level with the operating frequency and mode.
- oFF : Announces the operating frequency and mode only.

on  
SPC-S, G

oFF  
SPC-S, G

# 11 OPTION INSTALLATIONS

## Internal view

### • Top view — PA unit

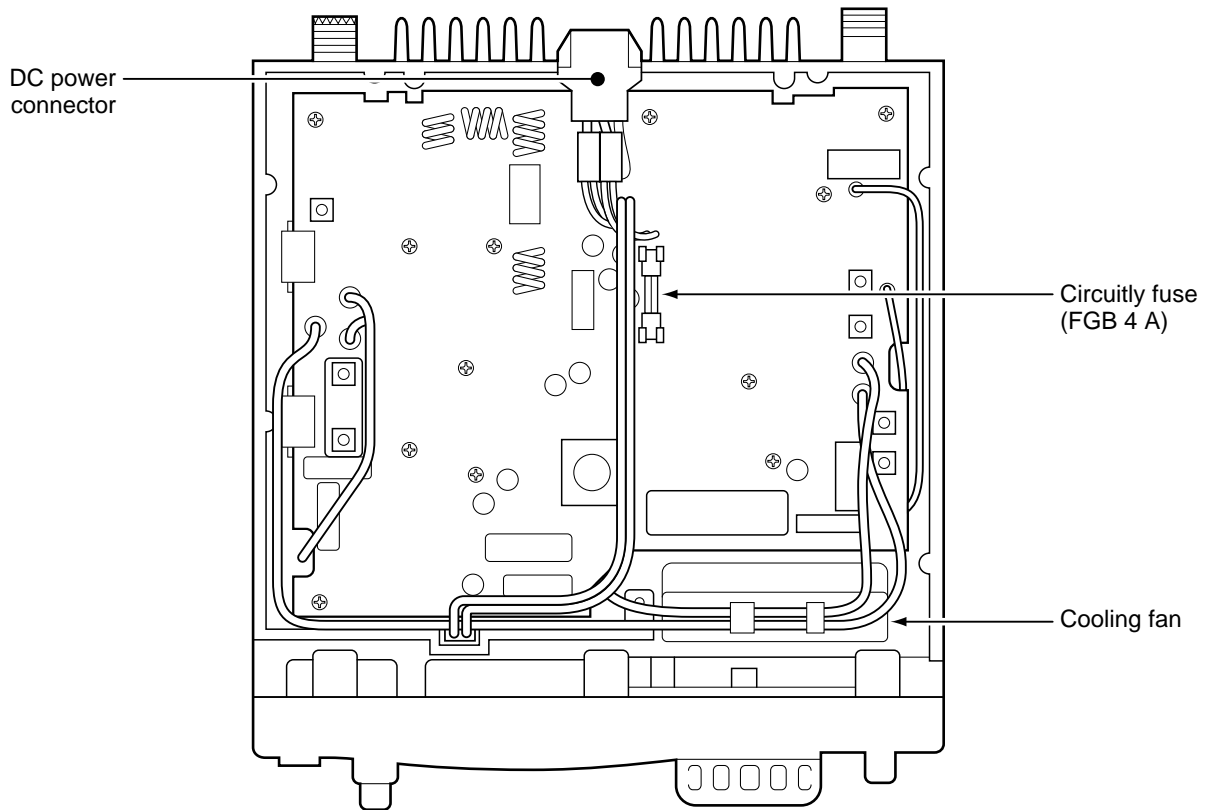

### • Bottom view — PLL/MAIN unit

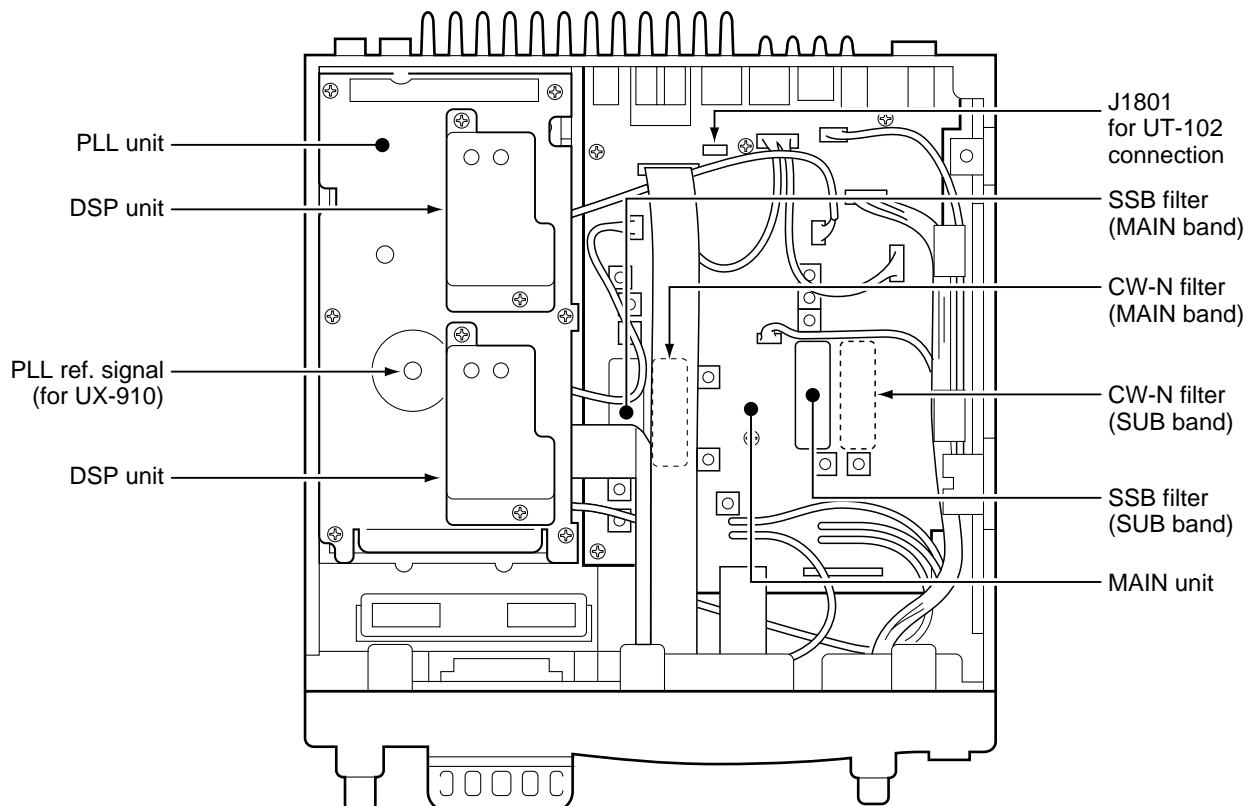



## ■ Opening the transceiver's case

Follow the case and cover opening procedures shown here when you want to install an optional unit or adjust the internal units, etc.

- ① Remove the 5 screws from the top of the transceiver and the 4 screws from the sides, then lift up the top cover.
- ② Turn the transceiver upside down.
- ③ Remove the 5 screws from the bottom of the transceiver, then lift up the bottom cover.

**CAUTION:** DISCONNECT the DC power cable from the transceiver before performing any work on the transceiver. Otherwise, there is a danger of electric shock and/or equipment damage.

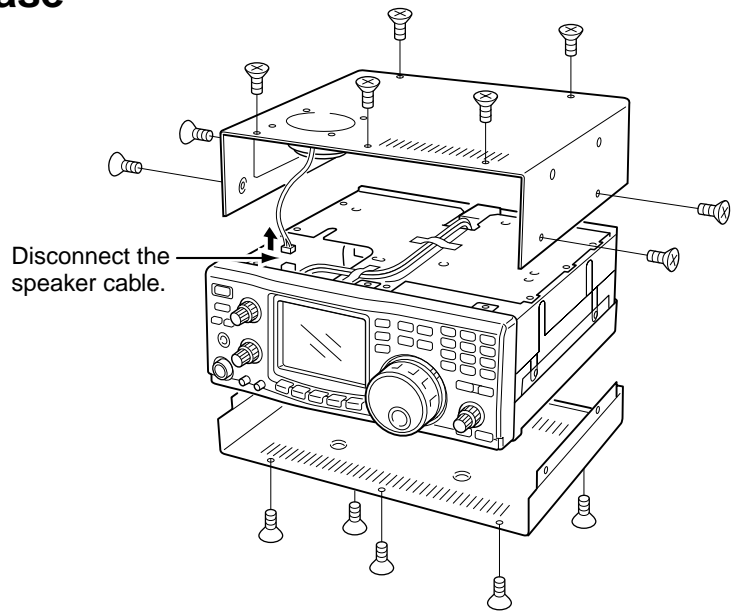

## ◆ Opening the PA unit cover

- ① Remove the 8 screws and grounding plate from the PA unit cover.
- ② Remove fastening tape from the inside power cable.

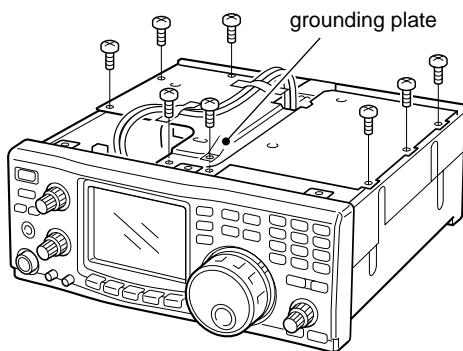

- ③ Slide the PA unit cover as shown below.

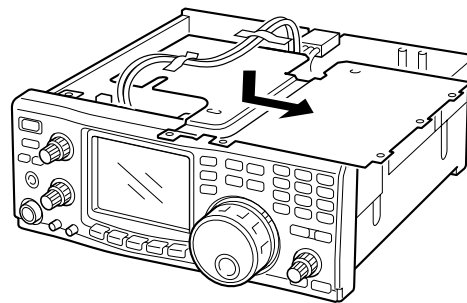

## ■ UT-102 VOICE SYNTHESIZER UNIT

The UT-102 announces the accessed readout's frequency, mode, etc. (S-meter level can also be announced—p. 69) in a clear, electronically-generated voice, in English (or Japanese).

➔ Push [SPCH] to announce the frequency, etc.

- ① Remove the bottom cover as shown above.
  - Remove the UX-910 if you have installed it. (p. 73)
- ② Remove the protective paper attached to the bottom of the UT-102 to expose the adhesive strip.
- ③ Plug UT-102 into J1801 on the MAIN unit as shown in the diagram at right.
- ④ Return the bottom cover to its original position.
- ⑤ Set the speech level, announcement language and S-meter announcement in the speech set mode (p. 69) if desired.

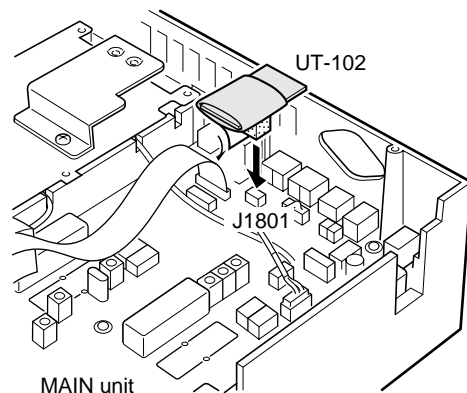

## ■ UT-106 DSP UNIT

The UT-106 provides AF DSP functions such as noise reduction and auto notch.

Up to 2 DSP units can be installed for simultaneous DSP operation for both MAIN and SUB bands.

When only 1 DSP unit is installed, DSP functions can be operated in either the MAIN or SUB band, whichever is being accessed.

### RECOMMENDATION:

When installing only 1 DSP unit, you can install into either front or rear panel side. However, installing a DSP unit into the front panel side may be easier and also safer.

### ◆ Installing 1st DSP unit (front panel side)

- ① Remove the top and bottom covers.
  - Remove the UX-910 if you have installed it. (p. 73)
- ② Remove the shielding plate.
- ③ Remove the connection cable from J1751 on the MAIN unit. Connect the cable into J1 on the UT-106.
- ④ Plug the connection cable (P1) from the UT-106 to J1751 on the MAIN unit.
- ⑤ Plug the flat cable into J3 on the UT-106 and to J1771 on the MAIN unit.
  - Take care of the conductor direction.
  - Attach the Velcro tape to the UT-106 and PLL unit shielding plate.
- ⑥ Return the shielding plate, top cover and bottom cover to their original positions.

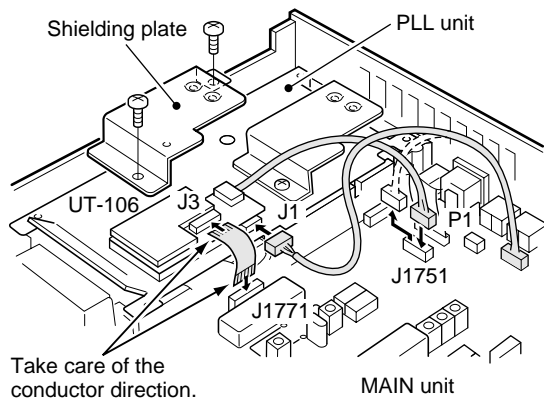

### ◆ Installing 2nd DSP unit (rear panel side)

- ① Remove the top and bottom covers.
  - Remove the UX-910 if you have installed it. (p. 73)
- ② Remove the shielding plate.
- ③ Remove the connection cable from J1761 on the MAIN unit. Connect the cable into J1 on the UT-106.

The cable between J1221 on the MAIN and J1 on the DSP unit, must be set in the groove of the chassis (see diagram below). Otherwise, the cable may be damaged when re-turning the shield plate to its original position.

- ④ Plug the connection cable (P1) from the UT-106 to J1761 on the MAIN unit.
- ⑤ Plug the flat cable into J3 on the UT-106 and to J1781 on the MAIN unit.
  - Take care of the conductor direction.
  - Attach the Velcro tape to the UT-106 and PLL unit shielding plate.
- ⑥ Return the shielding plate, top cover and bottom cover to their original positions.

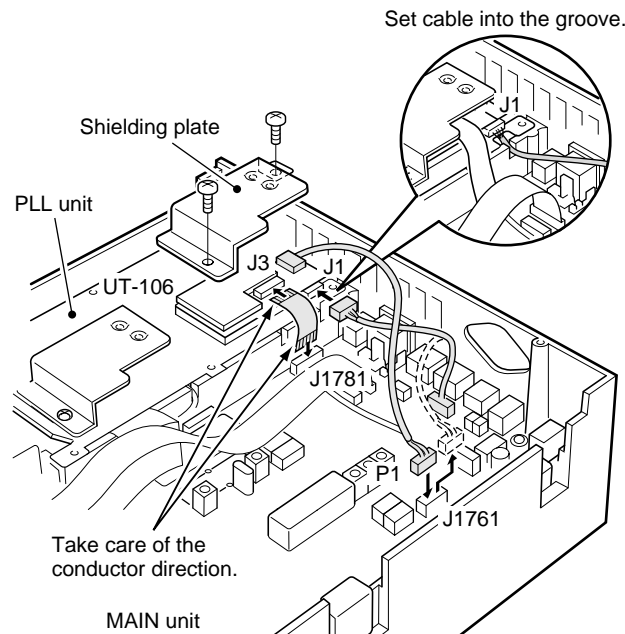

## ■ UX-910 1200 MHz BAND UNIT

The UX-910 is a band unit for 1200 MHz band operation. FM, SSB (USB/LSB), CW and CW narrow mode operations are available.

- ① Remove the bottom cover as shown in the diagram on p. 71.
- ② Remove the antenna plate from the chassis using a standard screw driver.

**WARNING!**

**NEVER** attempt to remove the antenna plate using your finger, this may result in injury.

- ③ Connect the FFC (Flexible Flat Cable) of the UX-910 to J2 on the MAIN unit, DC power cable to the power connector (W305) from the PA unit and the coaxial cable to the J541 on the PLL unit.

**CAUTION**

**NEVER** catch the cables from the optional DSP unit(s) between chassis and the UX-910, this may damage the DSP unit(s) and/or transceiver.

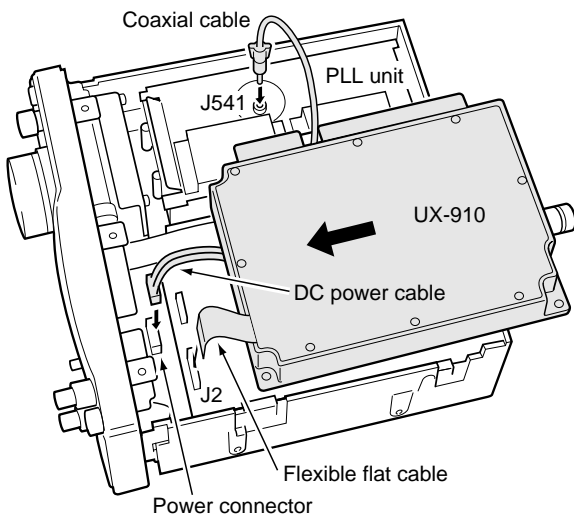

- ④ Place the UX-910 using the supplied 4 screws.

**BE CAREFUL** not to drop the supplied screws inside the transceiver.

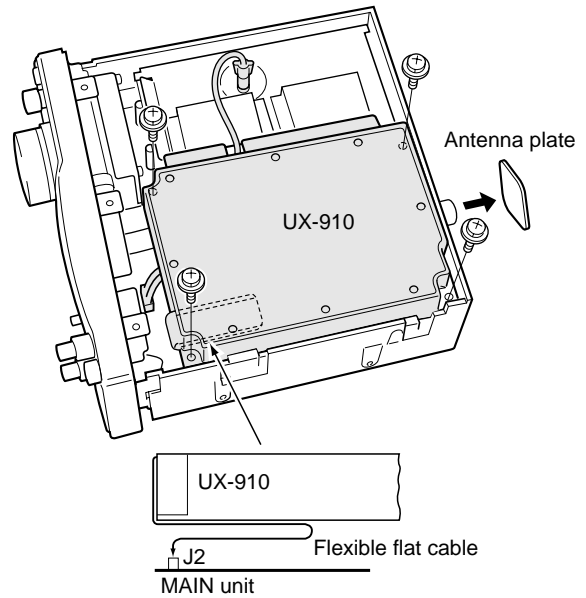

Turn the flexible flat cable up under the UX-910.

- ⑤ Return the bottom cover to its original position.

## ■ CR-293 HIGH STABILITY CRYSTAL UNIT

By installing the CR-293, the total frequency stability of the transceiver will be improved.

- ① Remove the bottom cover as shown in the diagram on p. 71.
  - Remove the UX-910 if you have installed it. (p. 73)
- ② Remove the 6 screws from the PLL shield cover, then lift up the PLL shield cover.

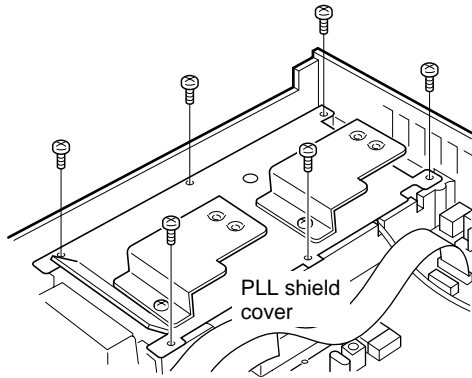

- ③ Disconnect the FFC (Flexible Flat Cable) from the DISPLAY unit and the connection cable connectors from J501 and J1051 on the MAIN unit.
- ④ Remove the 5 screws from the PLL unit, then lift up the PLL unit.

- ⑤ Unsolder the original reference crystal, then remove it.
  - The original reference crystal unit is soldered at both top and bottom sides of the PCB (Printed Circuit Board).

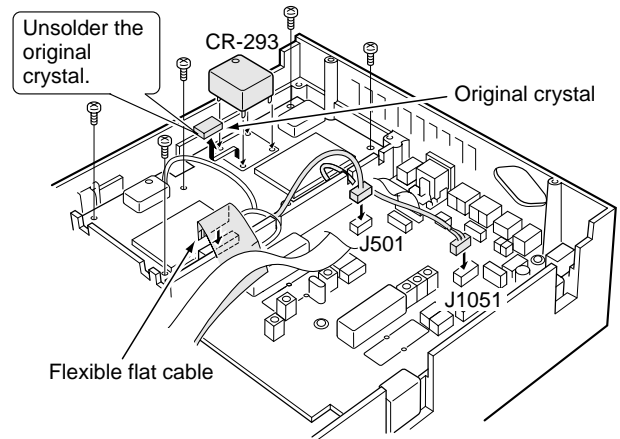

- ⑥ Install the CR-293 and solder the leads.
- ⑦ Return the PLL unit, PLL shield cover and bottom cover to their original positions.

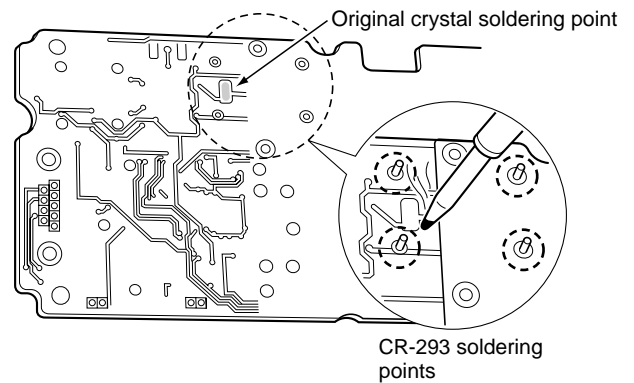

## ■ FL-132/FL-133 CW NARROW FILTER

The IC-910H has a CW narrow mode to provide better S/N (Signal-to-Noise), or to reject interference. To operate the CW narrow mode, an optional CW narrow filter is necessary.

**NOTE:** For CW narrow mode during satellite operation, the FL-133 (for SUB band filter) is necessary since the SUB band circuit is used for receiving, although the MAIN band display shows receive frequency.

FILTER	Passband width	
	at -6 dB	at -60 dB
Built-in filter	2.3 kHz	4.2 kHz
FL-132/133	500 Hz	1.34 kHz

- ① Remove the bottom cover as shown in the diagram on p. 71.
  - Remove the UX-910 if you have installed it. (p. 73)
- ② Disconnect the connection cable connectors from J501 and J1051 on the MAIN unit.
- ③ Remove the 2 clips.

**WARNING!**

**BE CAREFUL** not to pinch your finger with the clip.

- ④ Remove the 6 screws from the MAIN unit, then lift up the MAIN unit.

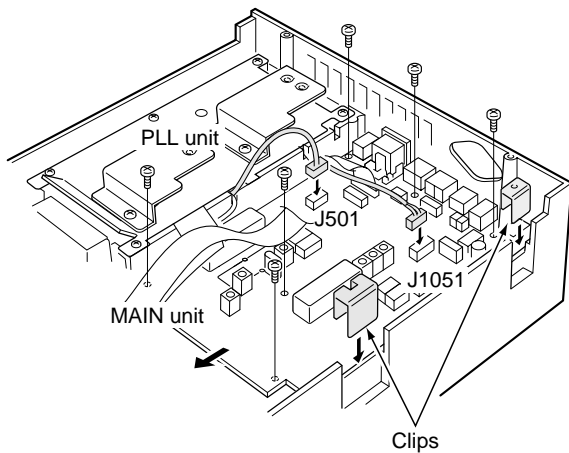

- ⑤ Install FL-132 or FL-133 to the specified position on the MAIN unit.

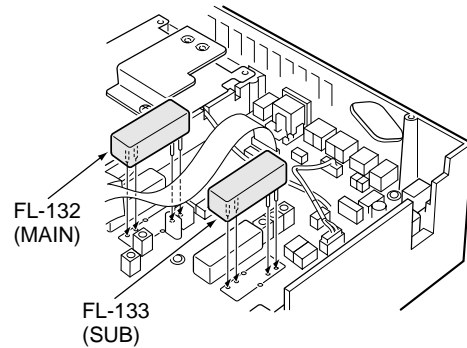

- ⑥ Solder then cut the leads, keeping 2–3 mm (1/8") of the leads from the bottom of the MAIN unit.
- ⑦ Return the MAIN unit and clips to their original positions.
- ⑧ Re-connect the connection cable connector to J501 and J1051 on the MAIN unit.
- ⑨ Return the bottom cover to the original position.

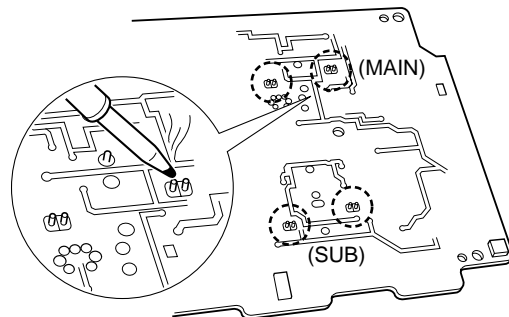

# 11 MAINTENANCE

## ■ Troubleshooting

The following chart is designed to help you correct problems which are not equipment malfunctions.

If you are unable to locate the cause of a problem or solve it through the use of this chart, contact your nearest Icom Dealer or Service Center.

	PROBLEM	POSSIBLE CAUSE	SOLUTION	REF.
POWER	Power does not come on when [POWER] is pushed.	<ul style="list-style-type: none"> <li>•DC power cable is improperly connected.</li> <li>•Fuse is blown.</li> </ul>	<ul style="list-style-type: none"> <li>•Reconnect the DC power cable correctly.</li> <li>•Check the cause, then replace the fuse with a spare one. (Fuses are installed in the DC power cable and the internal PA unit.)</li> </ul>	<p>–</p> <p>p. 77</p>
	No sounds comes from the speaker.	<ul style="list-style-type: none"> <li>•Volume level is too low.</li> <li>•The squelch is closed.</li> <li>•The transceiver is in the transmitting condition.</li> </ul>	<ul style="list-style-type: none"> <li>•Rotate [AF] clockwise to obtain a suitable listening level.</li> <li>•Rotate [RF/SQL] to 12 o'clock position to open the squelch.</li> <li>•Push [TRANSMIT] to receive or check the SEND line of an external unit, if desired.</li> </ul>	<p>p. 26</p> <p>p. 26</p> <p>pgs. 2, 13</p>
RECEIVE	Sensitivity is low.	<ul style="list-style-type: none"> <li>•The antenna is not connected properly.</li> <li>•The attenuator is activated.</li> <li>•The S-meter squelch is activated.</li> </ul>	<ul style="list-style-type: none"> <li>•Reconnect to the antenna connector.</li> <li>•Push [ATT] to turn the attenuator OFF.</li> <li>•Rotate [RF/SQL] to the position where the noise just disappears.</li> </ul>	<p>–</p> <p>p. 29</p> <p>p. 26</p>
	Received audio is distorted.	<ul style="list-style-type: none"> <li>•Incorrect sideband (USB/LSB) is selected.</li> <li>•Receiving an FM signal.</li> <li>•Noise blanker is activated.</li> <li>•Noise reduction is activated.</li> </ul>	<ul style="list-style-type: none"> <li>•Switch USB and LSB by pushing [SSB/CW] for 1 sec.</li> <li>•Push [FM] to select FM mode.</li> <li>•Push [AFC/NB] to turn the noise blanker function OFF.</li> <li>•Set the noise reduction level in the NR set mode for maximum readability using [SET] and [AFC/NB•NR], or turn OFF the function by pushing [AFC/NB•NR] for 1 sec.</li> </ul>	<p>p. 23</p> <p>p. 23</p> <p>p. 30</p> <p>p. 31</p>
TRANSMIT	Transmitting is impossible.	<ul style="list-style-type: none"> <li>•PTT lock function is activated.</li> </ul>	<ul style="list-style-type: none"> <li>•Turn the PTT lock function OFF in the TRANSMIT set mode using [SET] and [TRANSMIT].</li> </ul>	<p>p. 66</p>
	Output power is too low.	<ul style="list-style-type: none"> <li>•[RF PWR] is set too far counterclockwise.</li> <li>•[MIC GAIN] is set too far counterclockwise.</li> </ul>	<ul style="list-style-type: none"> <li>•Rotate [RF PWR] clockwise.</li> <li>•Rotate [MIC GAIN] clockwise.</li> </ul>	<p>p. 32</p> <p>p. 32</p>
	No contact possible with another station.	<ul style="list-style-type: none"> <li>•Split frequency operation or duplex operation is activated.</li> <li>•RIT function is activated.</li> </ul>	<ul style="list-style-type: none"> <li>•Push [SPLIT] momentarily or for 1 sec. to turn the split or duplex function OFF.</li> <li>•Push [RIT] to turn the RIT function OFF.</li> </ul>	<p>p. 37</p> <p>p. 27</p>
	Transmitted signals are distorted.	<ul style="list-style-type: none"> <li>•[MIC GAIN] too far clockwise.</li> </ul>	<ul style="list-style-type: none"> <li>•Set [MIC GAIN] to a suitable level.</li> </ul>	<p>p. 32</p>
	Repeater cannot be accessed.	<ul style="list-style-type: none"> <li>•Duplex operation is not activated.</li> <li>•No subaudible tone or incorrect tone frequency is selected.</li> </ul>	<ul style="list-style-type: none"> <li>•Push [SPLIT•DUP] for 1 sec. to turn duplex operation ON.</li> <li>•Push [TONE] to activate the subaudible tone or select a suitable tone frequency in the FM set mode using [SET] and [FM].</li> </ul>	<p>p. 34</p> <p>p. 35</p>
	Programmed scan does not start.	<ul style="list-style-type: none"> <li>•VFO mode is not selected.</li> <li>•[RF/SQL] is assigned to RF gain and squelch is opened.</li> </ul>	<ul style="list-style-type: none"> <li>•Push [V/M 1] to select VFO mode.</li> <li>•Reset [RF/SQL] control assignment and set it to the threshold point.</li> </ul>	<p>p. 21</p> <p>p. 26</p>
SCAN	Memory scan does not start.	<ul style="list-style-type: none"> <li>•Memory mode is not selected.</li> <li>•No memory channels are programmed.</li> </ul>	<ul style="list-style-type: none"> <li>•Push [V/M 1] to select memory mode.</li> <li>•Program desired frequencies into memory channels.</li> </ul>	<p>p. 40</p> <p>p. 41</p>
	Mode select scan does not start.	<ul style="list-style-type: none"> <li>•Mode select scan mode has not been selected.</li> <li>•Only one channel is programmed with the selected operating mode.</li> </ul>	<ul style="list-style-type: none"> <li>•Push [SPCH•LOCK] for 1 sec. on the desired operating mode programmed channel.</li> <li>•Program more than two channels with the desired operating mode.</li> </ul>	<p>p. 47</p> <p>p. 41</p>
	No announcement when [SPCH] is pushed.	<ul style="list-style-type: none"> <li>•The voice synthesizer unit has not been installed.</li> <li>•The announcement level is set to "0" or too low.</li> <li>•The announcement language is set to "OFF"</li> </ul>	<ul style="list-style-type: none"> <li>•Install the optional vice synthesizer unit, UT-102.</li> <li>•Set the announcement level to a suitable level in the SPCH set mode using [SET] and [SPCH].</li> <li>•Set the announcement language to "Eng" (or JPN) in the SPCH set mode using [SET] and [SPCH].</li> </ul>	<p>p. 71</p> <p>p. 69</p> <p>p. 69</p>
DISPLAY	The displayed frequency does not change properly.	<ul style="list-style-type: none"> <li>•The dial lock function is activated.</li> <li>•The internal CPU has malfunctioned.</li> </ul>	<ul style="list-style-type: none"> <li>•Push [SPCH•LOCK] to turn the lock function OFF.</li> <li>•Reset the CPU.</li> </ul>	<p>p. 25</p> <p>p. 77</p>

## ■ Fuse replacement

If a fuse blows or the transceiver stops functioning, try to find the source of the problem, and replace the damaged fuse with a new, rated fuse.

**CAUTION:** DISCONNECT the DC power cable from the transceiver when changing a fuse.

The IC-910H has 2 types of fuses installed for transceiver protection.

- DC power cable fuses ..... FGB 30 A
- Circuitry fuse ..... FGB 4 A

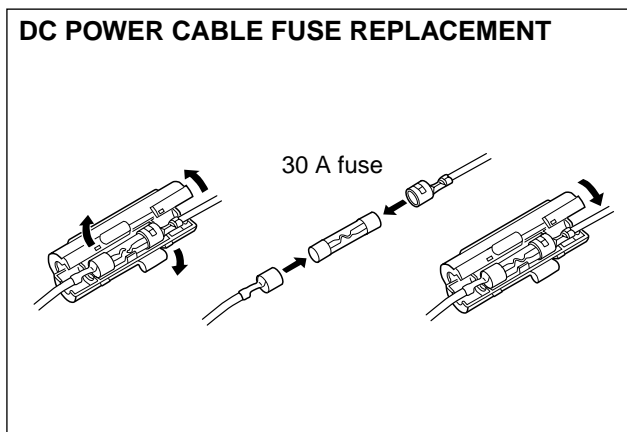

### CIRCUITRY FUSE REPLACEMENT

The 13.8 V DC from the DC power cable is applied to all units in the IC-910H, except for the power amplifier, through the circuitry fuse. This fuse is installed in the PA unit.

- ① Remove the top cover as shown on p. 71.
- ② Remove the 11 screws from the PA shielding plate, then remove the plate.
- ③ Replace the circuitry fuse as shown in the diagram at right.
- ④ Replace the PA shielding plate and top cover.

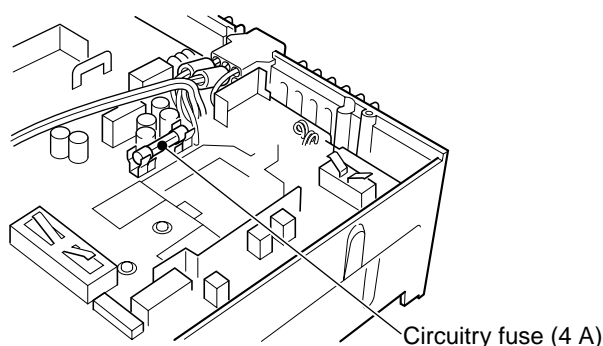

## ■ CPU resetting

Resetting **CLEAR**s all programmed contents in memory channels and returns programmed values in set mode to default values.

When first applying power or when the function seems to be displaying erroneous information, reset the CPU as follows:

- ① Make sure the transceiver power is OFF.
- ② While pushing [MW 4] and [M-CL 5], push [POWER] to turn power ON.
  - The internal CPU is reset.
  - The transceiver displays its initial VFO frequencies when resetting is complete.

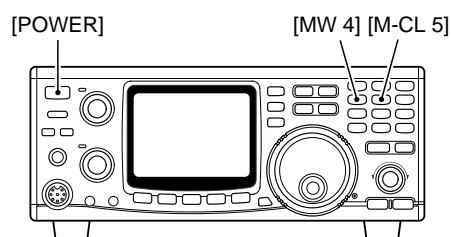

# 13 CONTROL COMMAND

## Remote jack (CI-V) information

### •CI-V connection example

The transceiver can be connected through an optional CT-17 CI-V LEVEL CONVERTER to a personal computer equipped with an RS-232C port. The Icom Communications Interface-V (CI-V) controls the following functions of the transceiver.

Up to 4 Icom CI-V transceivers or receivers can be connected to a personal computer equipped with an RS-232C port. See p. 59 for setting the CI-V condition using set mode.

### •Data format

The CI-V system can be operated using the following data formats. Data formats differ according to command numbers. A data area or sub command is added for some commands.

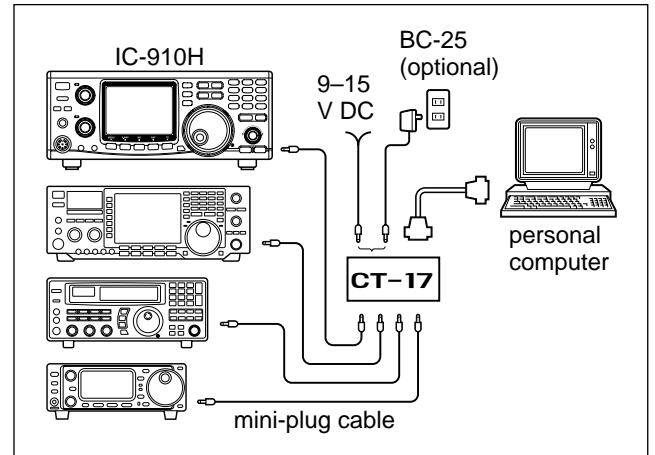

### CONTROLLER TO IC-910H

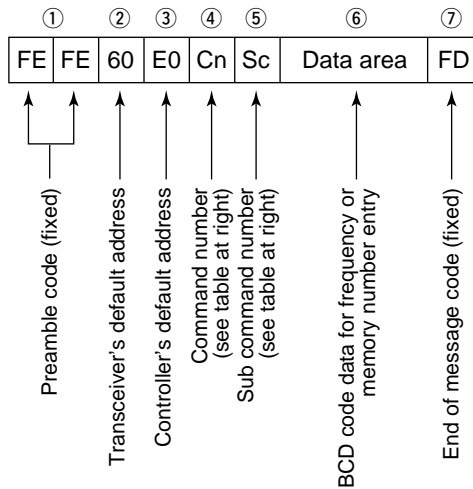

### OK MESSAGE TO CONTROLLER

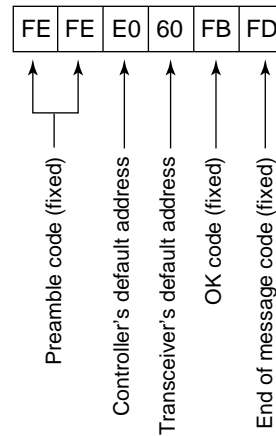

### IC-910H TO CONTROLLER

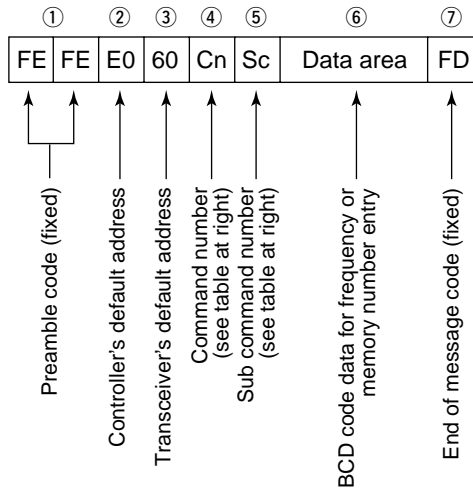

### NG MESSAGE TO CONTROLLER

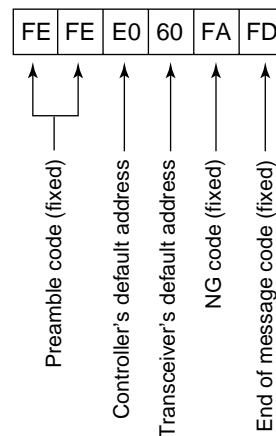



Command	Sub command	Description
00	—	Send frequency data for transceive.
01	xx	Send mode data for transceive. Read band edge frequencies.
02	—	Read operating frequency data.
03	—	Read operating mode data.
04	—	Set operating frequency.
05	—	
06	00	Set LSB.
	01	Set USB.
	03	Set CW.
	04	Set FM.
07	—	Select VFO mode.
	00	Select VFO A.
	01	Select VFO B.
	A0	Equalize VFO A and VFO B.
	B0	Switch VFO A and VFO B.
	D0	Select MAIN VFO.
D1	Select SUB VFO.	
08	—	Select memory mode.
	01-0106*	Select memory channel. *1A=0100 1b=0101 2A=0102 2b=0103 3A=0104 3b=0105 Call=0106
09	—	Memory write.
0A	—	Transfer memory contents to VFO.
0B	—	Memory clear.
0C	—	Read duplex offset frequency.
0D	—	Set duplex offset frequency.
0E	00	Cancel scan.
	01	Start scan.
	D0	Set scan resume OFF.
	D3	Set scan resume ON.
0F	00	Turn the split function OFF.
	01	Turn the split function ON.
	10	Set simplex operation.
	11	Set DUP- operation.
12	Set DUP+ operation.	
10	00	Set 1 Hz tuning step.
	01	Set 10 Hz tuning step.
	02	Set 50 Hz tuning step.
	03	Set 100 Hz tuning step.
	04	Set 1 kHz tuning step.
	05	Set 5 kHz tuning step.
	06	Set 6.25 kHz tuning step.
	07	Set 10 kHz tuning step.
	08	Set 12.5 kHz tuning step.
	09	Set 20 kHz tuning step.
	10	Set 25 kHz tuning step.
11	Set 100 kHz tuning step.	
11	00	Turn attenuator OFF.
	20	Turn attenuator ON.

Command	Sub command	Description
13	00	Announce all S-meter levels, displayed frequency and mode.
	01	Announce displayed frequency.
	02	Announce operating mode.
14	01	[AF] level setting (0=max. CCW; 128=center; 255=max. CW).
	02	[RF GAIN] level setting (0=max. CCW; 255=max. CW).
	03	[SQL] level setting (0=max. CCW; 255=max. CW).
	04	[IF SHIFT] level setting (0=max. CCW; 128=center; 255=max. CW).
	06	Set noise reduction level (0=0%; 255=100%).
	09	Set CW pitch (0=300 Hz; 255=900 Hz).
	0A	[RF PWR] level setting (0=max. CCW; 128=center; 255=max. CW).
	0B	[MIC GAIN] level setting (0=max. CCW; 128=center; 255=max. CW).
	0C	Key speed setting (0=6 wpm; 255=60 wpm).
	0E	Set mic. compressor level (0=0%; 255=100%).
0F	Set break-in delay (0=2.0 sec; 255=13.0 sec.).	
15	01	Read squelch condition (open or closed).
	02	Read S-meter level.
16	02	Set pre-amp (0=OFF; 1=ON).
	12	Set AGC (0=Slow; 1=Fast).
	22	Set noise blanker (0=OFF; 1=ON).
	40	Set noise reduction level (0=OFF; 1-15=ON).
	+level data 41	Set auto notch filter (0=OFF; 1=ON).
	42	Set subaudible tone (0=OFF; 1=ON).
	43	Set tone squelch (0=OFF; 1=ON).
	44	Set mic. compressor (0=OFF; 1=ON).
	46	Set VOX (0=OFF; 1=ON).
	47	Set break-in (0=OFF; 1=ON).
4A	Set AFC (0=OFF; 1=ON).	
19	00	Read the transceiver ID.
1A	00	Read/write memory channel.
	01	Set satellite memory.
	02	Set VOX gain level (0=0%; 255=100%).
	+level data 03	Set VOX delay (0=0 sec.; 20=2.0 sec.).
	+level data 04	Set anti-VOX (0=0%; 255=100%).
	+level data 05	Attenuation level setting (0=0%; 255=100%).
	+level data 06	Set RIT (0=OFF; 1=ON; 2=Sub dial).
	07	Set satellite mode (0=OFF; 1=ON).
08	Set simple bandscope (0=OFF; 1=ON).	

# 14 SPECIFICATIONS

## •General

•Frequency coverage : (Unit: MHz)

Version	144 MHz	430(440) MHz	1200 MHz*1
U.S.A.	Tx: 144.0–148.0 Rx: 136.0–174.0*2	Tx: 430.0–450.0 Rx: 420.0–480.0*3	Tx: 1240.0–1300.0 Rx: 1240.0–1320.0*4
Europe	144.0–146.0	430.0–440.0	1240.0–1300.0
Australia	144.0–148.0	430.0–450.0	1240.0–1300.0
Sweden	144.0–146.0	432.0–438.0	1240.0–1300.0

\*1 Optional UX-910

\*2 Guaranteed range is 144.0–148.0 MHz.

\*3 Guaranteed range is 430.0–450.0 MHz.

\*4 Guaranteed range is 1240.0–1300.0 MHz.

- Mode : USB, LSB, CW, FM, FM-N\*  
\*Not available in 1200 MHz
- No. of memory Ch. : 212 (99 regular, 6 scan edges, 1 calls for each band) plus 10 satellite memories)
- Antenna connector : SO-239 (50 Ω; VHF)  
Type-N (50 Ω; UHF)
- Usable temp. range : –10°C to +60°C;  
+14°F to +140°F
- Frequency stability : Less than ±3 ppm  
(–10 to 60°C; +14 to +140°F)
- Frequency resolution : 1 Hz minimum
- Power supply : 13.8 V DC ±15%  
(negative ground)
- Current drain (at 13.8 V DC; approx.):  
Transmit Max. power 23.0 A  
Receive Standby 2.0 A  
(3.0 A; UX-910)  
Max. audio 2.5 A  
(3.5 A; UX-910)
- Dimensions : 241(W)×94(H)×239(D) mm  
(projections not included) 9½(W)×3½(H)×9½(D) in
- Weight (approx.) : 4.5 kg; 10 lb  
(5.35 kg; 11 lb 13 oz w/UX-910)
- ACC 1 connector : 8-pin DIN connector
- CI-V connector : 2-conductor 3.5(d) mm (1/8")
- DATA connectors : 6-pin mini DIN × 2  
(for MAIN and SUB)
- Transmitter
- Output power (continuously adjustable):  
144 MHz 5–100 W  
430(440) MHz 5–75 W  
1200 MHz 1–10 W (optional UX-910)
- Modulation system :  
SSB Balanced modulation  
FM Variable reactance modulation
- Spurious emission :  
144/430(440) MHz More than 60 dB  
1200 MHz More than 50 dB
- Carrier suppression : More than 40 dB
- Unwanted sideband : More than 40 dB suppression
- Microphone connector : 8-pin connector (600 Ω)
- KEY connector : 3-conductor 3.5(d) mm (1/4")

## •Receiver

- Receive system :  
VHF SSB, CW Single conversion superheterodyne  
FM Double conversion superheterodyne  
UHF SSB, CW Double conversion superheterodyne  
FM Triple conversion superheterodyne
- Intermediate frequencies: (Unit: MHz)

		MAIN BAND			SUB BAND		
		1st	2nd	3rd	1st	2nd	3rd
144 MHz	SSB	10.8500	—	—	10.9500	—	—
	CW	10.8491	—	—	10.9491	—	—
	FM	10.8500	0.455	—	10.9500	0.455	—
430(440) MHz	SSB	71.2500	10.8500	—	71.3500	10.9500	—
	CW	71.2491	10.8491	—	71.3491	10.9491	—
	FM	71.2500	10.8500	0.455	71.3500	10.9500	0.455
1200 MHz	SSB	243.8500	10.8500	—	243.9500	10.9500	—
	CW	243.8491	10.8491	—	243.9491	10.9491	—
	FM	243.8500	10.8500	0.455	243.9500	10.9500	0.455

- Sensitivity :  
SSB, CW (10 dB S/N) Less than 0.11 μV  
FM (12 dB SINAD) Less than 0.18 μV
- Squelch sensitivity (threshold):  
SSB, CW Less than 1.0 μV  
FM Less than 0.18 μV
- Selectivity :  
SSB, CW : More than 2.3 kHz/–6 dB  
Less than 4.2 kHz/–60 dB\*  
FM : More than 15.0 kHz/–6 dB  
Less than 30.0 kHz/–60 dB\*  
FM-N : More than 6.0 kHz/–6 dB  
Less than 18.0 kHz/–36 dB  
CW-N : More than 0.5 kHz/–6 dB  
(w/FL-132 or FL-133) Less than 1.34 kHz/–60 dB\*  
\*Except 1200 MHz band
- Spurious and image rejection ratio:  
144/430(440) MHz : More than 60 dB  
1200 MHz : More than 50 dB
- AF output power : More than 2.0 W at 10% distortion with an 8 Ω load (at 13.8 V DC)
- RIT variable range :  
144/430(440) MHz : ±1.0 kHz (SSB, CW)  
±5.0 kHz (FM)  
1200 MHz : ±2.0 kHz (SSB, CW)  
±10.0 kHz (FM)
- IF SHIFT variable range : More than ±1.2 kHz
- PHONES connector : 3-conductor 6.35(d) mm (1/4")
- Ext. SP connectors : 2-conductor 3.5 (d) mm (1/8")  
/8Ω × 2 (for MAIN and SUB)

**All stated specifications are typical and subject to change without notice or obligation.**

**CR-293 HIGH STABILITY CRYSTAL UNIT**



Frequency stability:  $\pm 0.5$  ppm  
(0°C to +60°C)

**FL-132 (for MAIN band)  
FL-133 (for SUB band and satellite operation)  
CW NARROW FILTERS**

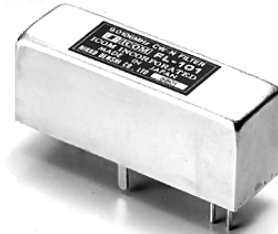

Have good shape factor and provide better CW reception during crowded band conditions. 500 Hz/-6 dB

**HM-12 HAND MICROPHONE**



Hand microphone equipped with [UP]/[DOWN] switches. Same as that supplied with the transceiver.

**SP-21 EXTERNAL SPEAKER**



Designed for base station operation.  
• Input impedance: 8  $\Omega$   
• Max. input power: 5 W

**SM-20 DESKTOP MICROPHONE**



Unidirectional, electret microphone for base station operation. Includes [UP] and [DOWN] switches and a low cut function.

**UT-106 DSP UNIT**



Allows AF DSP capabilities, including noise reduction and auto notch filter.

**UX-910 1200 MHz BAND UNIT**

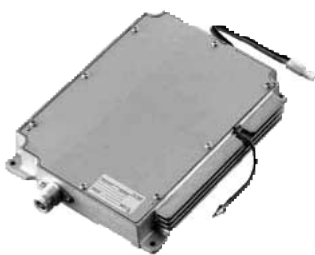

Allows you additional all mode operation on the 1200 MHz band.

**MB-23 CARRYING HANDLE**



Carrying handle, convenient for portable operation.

**CT-17 CI-V LEVEL CONVERTER**



For remote transceiver control using a personal computer. You can change frequencies, operating mode, memory channels, etc.

**AG-25 (for 144 MHz band),  
AG-35 (for 430(440) MHz band),  
AG-1200 (for 1200 MHz band)  
WEATHER-PROOF PREAMPLIFIERS**

External all-weather, mast mounting preamplifiers for compensating for coaxial cable loss.

**IC-MB5 MOBILE MOUNTING BRACKET**

Transceiver mounting bracket for mobile operation.

**SP-7 EXTERNAL SPEAKER**

Compact speaker for base station operation.

**UT-102 VOICE SYNTHESIZER UNIT**

Announces the receive frequency, mode and S-meter level in a clear, electronically-generated voice, in English (or Japanese).

**Count on us!**

