



# Test Report – FCC Part 15B Unintentional Radiator

## Applicant: Icom Incorporated

Signature:

A handwritten signature in blue ink, appearing to read "Tim Royer".

Sr. EMC Engineer  
EMC-003838-NE



Name & Title:

Tim Royer, EMC Engineer

Date of Signature

9/4/2024

Signature:

A handwritten signature in black ink, appearing to read "Kristoffer Costa".

Name & Title:

Kristoffer Costa, EMC Technician

Date of Signature

9/4/2024

This test report relates only to the items tested as identified and is not valid for any subsequent changes or modifications made to the equipment under test.

## Table of Contents

<b>1.</b>	<b>APPLICANT INFORMATION.....</b>	<b>4</b>
1.1	TEST RESULT SUMMARY.....	4
<b>2.</b>	<b>LOCATION OF TESTING.....</b>	<b>5</b>
2.1	TEST LABORATORY.....	5
<b>3.</b>	<b>TEST SAMPLE(S) (EUT/DUT).....</b>	<b>5</b>
3.1	DESCRIPTION OF THE EUT.....	6
3.2	CONFIGURATION OF EUT.....	7
3.3	TEST SETUP OF EUT.....	7
<b>4.</b>	<b>TEST METHODS &amp; APPLICABLE REGULATORY LIMITS.....</b>	<b>8</b>
4.1	TEST METHODS/STANDARDS/GUIDANCE.....	8
<b>5.</b>	<b>MEASUREMENT UNCERTAINTY.....</b>	<b>8</b>
<b>6.</b>	<b>ENVIRONMENTAL CONDITIONS.....</b>	<b>8</b>
<b>7.</b>	<b>LIST OF TEST EQUIPMENT AND TEST FACILITY.....</b>	<b>9</b>
<b>8.</b>	<b>TEST RESULTS.....</b>	<b>10</b>
8.1	38 DB REJECTION.....	11
8.2	RADIATED EMISSIONS.....	12
8.2.1	Scanning Receiver Function, 30 MHz to 200 MHz, Horizontal/ Vertical Polarity Plot.....	13
8.2.2	Scanning Receiver Function, 30 MHz to 200 MHz, Horizontal/ Vertical Polarity Table.....	14
8.2.3	Scanning Receiver Function, 200 MHz to 1000 MHz, Horizontal/ Vertical Polarity Plot.....	15
8.2.4	Scanning Receiver Function, 200 MHz to 1000 MHz, Horizontal/ Vertical Polarity Table.....	16
8.2.5	Scanning Receiver Function, above 1000 MHz, Horizontal/ Vertical Polarity Plot.....	17
8.2.6	Scanning Receiver Function, above 1000 MHz, Horizontal/ Vertical Polarity Table.....	18
8.2.7	30 MHz, 30 MHz to 200 MHz, Horizontal/ Vertical Polarity Plot.....	19
8.2.8	30 MHz, 30 MHz to 200 MHz, Horizontal/ Vertical Polarity Table.....	20
8.2.9	30 MHz, 200 MHz to 1000 MHz, Horizontal/ Vertical Polarity Plot.....	21
8.2.10	30 MHz, 200 MHz to 1000 MHz, Horizontal/ Vertical Polarity Table.....	22
8.2.11	30 MHz, above 1000 MHz, Horizontal/ Vertical Polarity Plot.....	23
8.2.12	30 MHz, above 1000 MHz, Horizontal/ Vertical Polarity Table.....	24
8.2.13	45 MHz, 30 MHz to 200 MHz, Horizontal/ Vertical Polarity Plot.....	25
8.2.14	45 MHz, 30 MHz to 200 MHz, Horizontal/ Vertical Polarity Table.....	26
8.2.15	45 MHz, 200 MHz to 1000 MHz, Horizontal/ Vertical Polarity Plot.....	27
8.2.16	45 MHz, 200 MHz to 1000 MHz, Horizontal/ Vertical Polarity Table.....	28
8.2.17	45 MHz, above 1000 MHz, Horizontal/ Vertical Polarity Plot.....	29
8.2.18	45 MHz, above 1000 MHz, Horizontal/ Vertical Polarity Table.....	30
8.2.19	60 MHz, 30 MHz to 200 MHz, Horizontal/ Vertical Polarity Plot.....	31
8.2.20	60 MHz, 30 MHz to 200 MHz, Horizontal/ Vertical Polarity Table.....	32
8.2.21	60 MHz, 200 MHz to 1000 MHz, Horizontal/ Vertical Polarity Plot.....	33
8.2.22	60 MHz, 200 MHz to 1000 MHz, Horizontal/ Vertical Polarity Table.....	34
8.2.23	60 MHz, above 1000 MHz, Horizontal/ Vertical Polarity Plot.....	35
8.2.24	60 MHz, above 1000 MHz, Horizontal/ Vertical Polarity Table.....	36
8.3	CONDUCTED EMISSIONS.....	37

8.3.1	Scanning, Line 1 Plot .....	38
8.3.2	Scanning, Line 1 Table .....	39
8.3.3	Scanning, Line 2 Plot .....	40
8.3.4	Scanning, Line 2 Table .....	41
8.3.5	30 MHz, Line 1 Plot .....	42
8.3.6	30 MHz, Line 1 Table .....	43
8.3.7	30 MHz, Line 2 Plot .....	44
8.3.8	30 MHz, Line 2 Table .....	45
8.3.9	45 MHz, Line 1 Plot .....	46
8.3.10	45 MHz, Line 1 Table .....	47
8.3.11	45 MHz, Line 2 Plot .....	48
8.3.12	45 MHz, Line 2 Table .....	49
8.3.13	60 MHz, Line 1 Plot .....	50
8.3.14	60 MHz, Line 1 Table .....	51
8.3.15	60 MHz, Line 2 Plot .....	52
8.3.16	60 MHz, Line 2 Table .....	53
9.	STATEMENTS OF COMPATIBILITY WITH FCC RULES – PART 15.121.....	54
10.	ANNEX-B – TEST SETUP PHOTOGRAPHS .....	55
11.	HISTORY OF TEST REPORT CHANGES .....	55

## 1. Applicant Information

Applicant: Icom Incorporated  
 Address: 1-1-32 Kamininami  
 Hirano-Ku, Osaka, 547-0003, Japan

### 1.1 Test Result Summary

The following test procedure was used ANSI C63.4-2014. Full test results are available in this report.

No additions to the test methods were needed. There were no deviations, or exclusions from the test methods. No test results are from external providers or from the customer. The test results relate only to the items tested. Timco does not offer opinions and interpretations, only a pass/fail statement.

Clauses	Description of the Requirements	Result (Pass, Fail or N/A)
Applicable Clauses from FCC 15 B		
15.107	Conducted Emission Limits	Pass
15.111 (a)	Receiver Conducted Power	N/A
15.121	38 dB Rejection	Pass
15.109	Radiated Emission Limits	Pass

## 2. Location of Testing

### 2.1 Test Laboratory

Timco Engineering Inc. is a subsidiary of Industrial Inspection & Analysis, Inc. ("IIA"). Testing was performed at IIA's permanent laboratory located at 13146 NW 86<sup>th</sup> Drive, Suite 400, Alachua, Florida 32615.

FCC test firm # 578780

FCC Designation # US1070

FCC site registration is under A2LA certificate # 0955.01

ISED Canada test site registration # 2056A

EU Notified Body # 1177

For all designations see A2LA scope # 0955.01

## 3. Test Sample(s) (EUT/DUT)

The test sample was received: 8/12/2024

Dates of Testing: 8/19/2024 – 8/23/2024

### 3.1 Description of the EUT

A description as well as unambiguous identification of the EUT(s) tested. Where more than one sample is required for technical reasons (such as the use of connected units for the purpose of conducted output power testing where the product units will have integral antennas), each specific test shall identify which unit was tested.

Identification	
Brief Description	Scanning Receiver
Model(s) #	IC-7760
Firmware version	N/A
Software version	N/A
Serial Number	N/A

Technical Characteristics	
Antenna Connector	N/A
Voltage Rating (AC or Batt.)	110 VAC

Note: Information such as antenna gain, firmware/software numbers are provided by manufacturer and cannot be validated by the test lab.

### 3.2 Configuration of EUT

Band (MHz)	Mode	Number of Ant.
N/A	Operational (Main- Mode 1)	1

#### Operating conditions during Testing:

No modifications of the device under test (including firmware, specific software settings, and input/output signal levels to the EUT).

#### Peripherals used during Testing:

No peripherals used.

### 3.3 Test Setup of EUT

Equipment, antenna, and cable arrangement. The setup of the equipment and cable or wire placement on the test site that produces the highest radiated and the highest ac power-line conducted emissions shall be shown clearly and described. Information on the orientation of portable equipment during testing shall be included. Drawings or photographs may be used for this purpose.

Test Setups are included in the test report.

#### 4. Test methods & Applicable Regulatory Limits

##### 4.1 Test methods/Standards/Guidance

The measurement was performed as per ANSI 63.4. Full test results are available in this report.

##### Limits and Regulatory Limits:

- 1) FCC 15.109 (2015)

#### 5. Measurement Uncertainty

Parameter	Uncertainty (dB)
Conducted Emissions	± 3.14 dB
Radiated Emissions (9kHz – 30 MHz)	± 3.08 dB
Radiated Emissions (30 – 200 MHz)	± 2.16 dB
Radiated Emissions (200 – 1000 MHz)	± 2.15 dB
Radiated Emissions (1 GHz – 18 GHz)	± 2.14 dB
Radiated Emissions (18 GHz – 40 GHz)	± 2.31 dB

**Note:** The uncertainties provided in this table represent an expanded uncertainty expressed at approximately the 95% confidence level using a coverage factor of K=2.

#### 6. Environmental Conditions

##### Temperature & Humidity

Measurements performed at the test site did not exceed the following:

Parameter	Measurement
Temperature	23 C +/- 5%
Humidity	55% +/- 5%
Barometric Pressure	30.05 in Hg

**Note:** Specific environmental conditions that are applicable to a specific test are available in the test result section.



## 7. List of Test Equipment and Test Facility

The test equipment used identified by type, manufacturer, serial number, or other identification and the date on which the next calibration or service check is due.

Description of the firmware or software used to operate EUT for testing purposes.

A complete list of all test equipment used shall be included with the test report. The manufacturer’s model and serial numbers, and date of last calibration, and calibration interval shall be included. Measurement cable loss, measuring instrument bandwidth and detector function, video bandwidth, if appropriate, and antenna factors shall also be included where applicable.

### List of Test Equipment

Test Equipment						
Type	Device	Manufacturer	Model	SN#	Current Cal	Cal Due
Antenna	Biconical 1057	Eaton	94455-1	1057	11/19/21	11/18/2024
Antenna, NSA	Log-Periodic 1243	Eaton	96005	1243	5/4/21	11/18/2024
Antenna	Double-Ridged Horn/ETS Horn 1	ETS-Lindgren	3117	00035923	5/31/23	11/18/2024
CHAMBER	CHAMBER	Panashield	3M	N/A	12/29/23	12/18/2025
Pre-amp	Pre-amp	RF-LAMBDA	RLNA00M45GA	NA	7/27/22	7/26/2025
Receiver	EMI Test Receiver R&S ESW44	Rohde & Schwarz	ESW44	103049	10/13/21	10/12/2024
LISN	LISN (Primary)	Electro-Metrics	ANS-25/2	2604	11/10/23	11/10/2026

## 8. Test Results

The results of the test are usually indicated in the form of tables, spectrum analyzer plots, charts, sample calculations, as appropriate for each test procedure.

A description and/or a block diagram of the test setup is usually provided.

The measurement results, along with the appropriate limits for comparison, may be presented in tabular or graphical form. In addition, any variation in the measurement environment may be reported if applicable (e.g., a significant change of temperature that could affect the cable loss and amplifier response).

### Units of measurement

Unless noted otherwise in the referenced standard, the measurements of ac power-line conducted emissions and conducted power output will be reported in units of dB $\mu$ V. Unless noted otherwise in the referenced standard, the measurements of radiated emissions will be reported in units of decibels, referenced to one microvolt per meter (dB $\mu$ V/m) for electric fields, or to one ampere per meter (dBA/m) for magnetic fields, at the distance specified in the appropriate standards or requirements. The measurements of antenna-conducted power for receivers may be reported in units of dB $\mu$ V if the impedance of the measuring instrument is also reported. Otherwise, antenna-conducted power will be reported in units of decibels referenced to one milliwatt (dBm). All formulas for data conversions and conversion factors, if used, will be included in this measurement report.

#### Example:

Freq (MHz)	Meter Reading	+ ACF	+CL	= FS
33	20 dB $\mu$ V	+ 10.36 dB/m	+0.40 dB	=30.36 dB $\mu$ V/m @ 3m

$$\text{EIRP} = \text{Pcond (dBm)} + \text{dBi}$$

## 8.1 38 dB Rejection

### 15.121 (b)

Except as provided in paragraph (c) of this section, scanning receivers shall reject any signals from the Cellular Radiotelephone Service frequency bands that are 38 dB or lower based upon a 12 dB SINAD measurement, which is considered the threshold where a signal can be clearly discerned from any interference that may be present.

Mode	38 dB Rejection Result
1 (Main)	Pass

## 8.2 Radiated Emissions

Limits from FCC 15.109 and test procedure from ANSI C63.4-2014.

### Radiated Test Setup, 30 – 1000 MHz

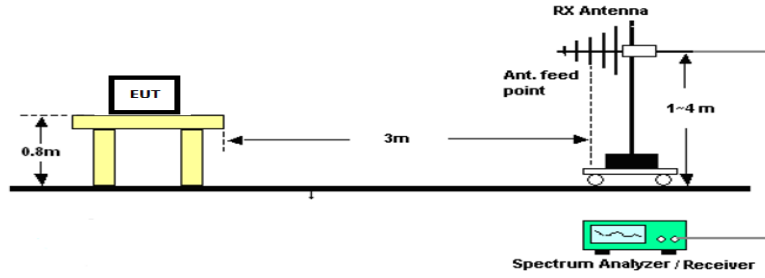

### Radiated Test Setup, Above 1000 MHz

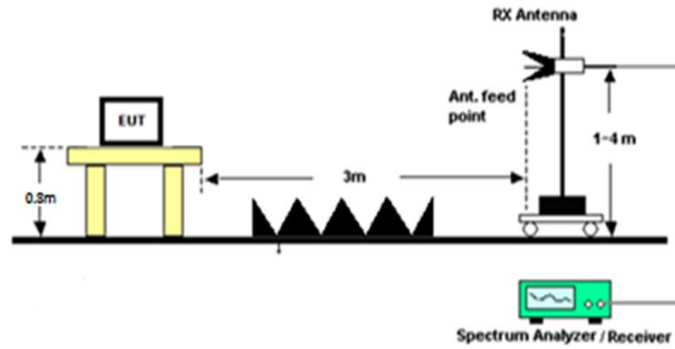

### 8.2.1 Scanning Receiver Function, 30 MHz to 200 MHz, Horizontal/ Vertical Polarity Plot

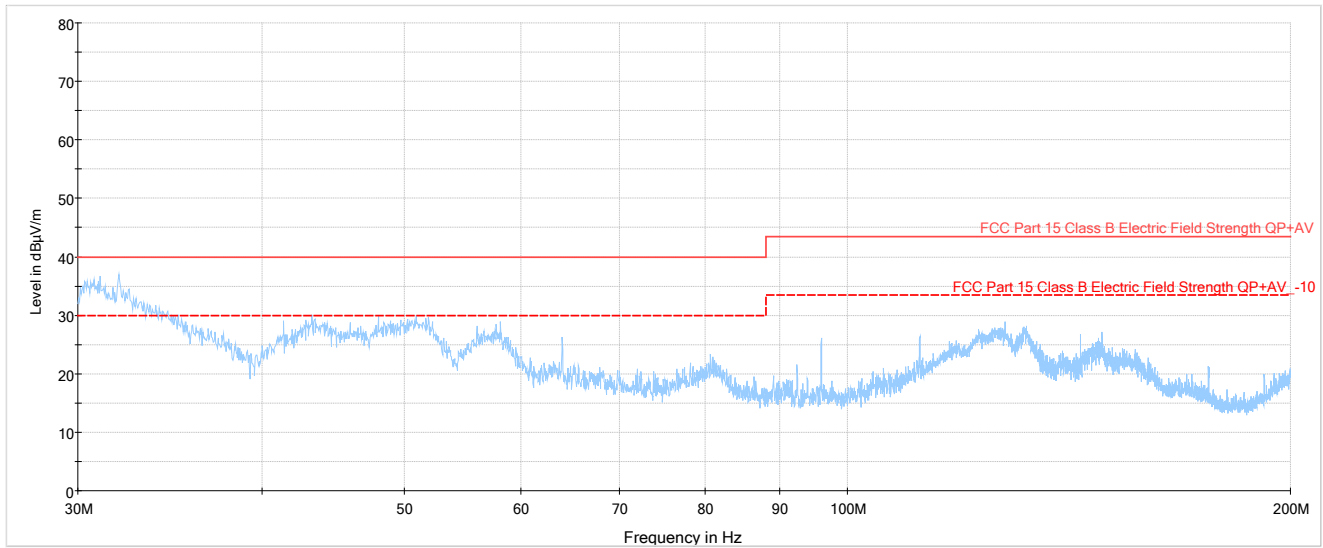

## 8.2.2 Scanning Receiver Function, 30 MHz to 200 MHz, Horizontal/ Vertical Polarity Table

Test

### Final Result

Frequency (MHz)	QuasiPeak (dBμV/m)	CAverage (dBμV/m)	Limit (dBμV/m)	Margin (dB)	Meas. Time (ms)	Bandwidth (kHz)	Height (cm)	Pol	Azimuth (deg)	Corr. (dB/m)	Comment
---	---	---	---	---	---	---	---		---	---	

### 8.2.3 Scanning Receiver Function, 200 MHz to 1000 MHz, Horizontal/ Vertical Polarity Plot

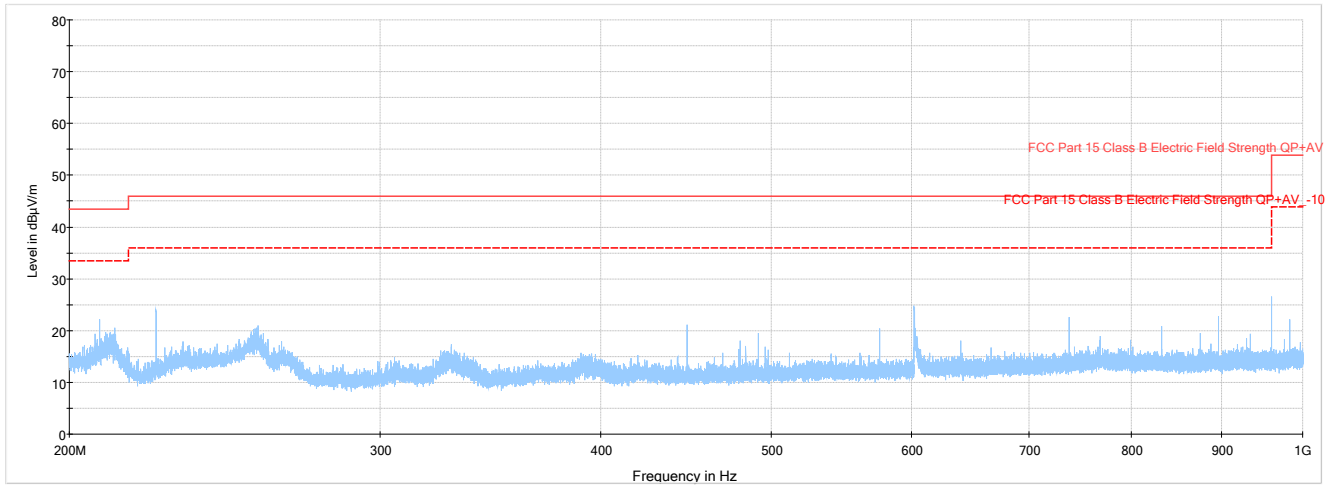

### 8.2.4 Scanning Receiver Function, 200 MHz to 1000 MHz, Horizontal/ Vertical Polarity Table

Test

#### Final Result

Frequency (MHz)	QuasiPeak (dBµV/m)	CAverage (dBµV/m)	Limit (dBµV/m)	Margin (dB)	Meas. Time (ms)	Bandwidth (kHz)	Height (cm)	Pol	Azimuth (deg)	Corr. (dB/m)	Comment
---	---	---	---	---	---	---	---		---	---	



### 8.2.5 Scanning Receiver Function, above 1000 MHz, Horizontal/ Vertical Polarity Plot

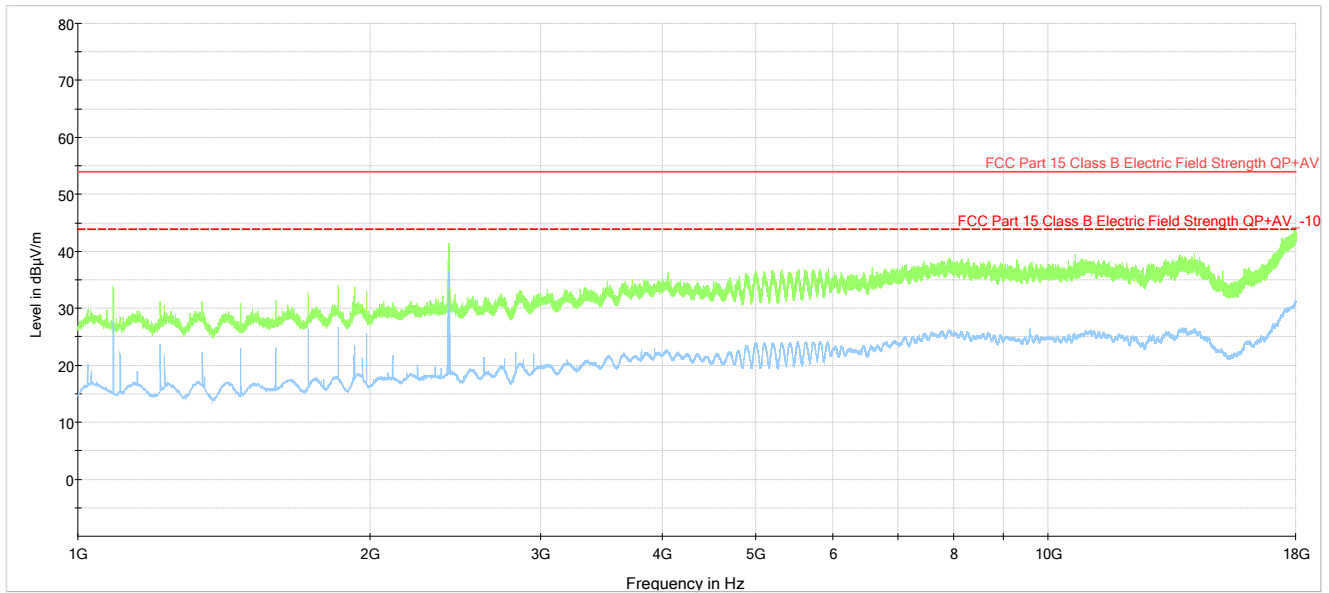

### 8.2.6 Scanning Receiver Function, above 1000 MHz, Horizontal/ Vertical Polarity Table

Test

#### Final Result

Frequency (MHz)	QuasiPeak (dBµV/m)	CAverage (dBµV/m)	Limit (dBµV/m)	Margin (dB)	Meas. Time (ms)	Bandwidth (kHz)	Height (cm)	Pol	Azimuth (deg)	Corr. (dB/m)	Comment
---	---	---	---	---	---	---	---		---	---	

### 8.2.7 30 MHz, 30 MHz to 200 MHz, Horizontal/ Vertical Polarity Plot

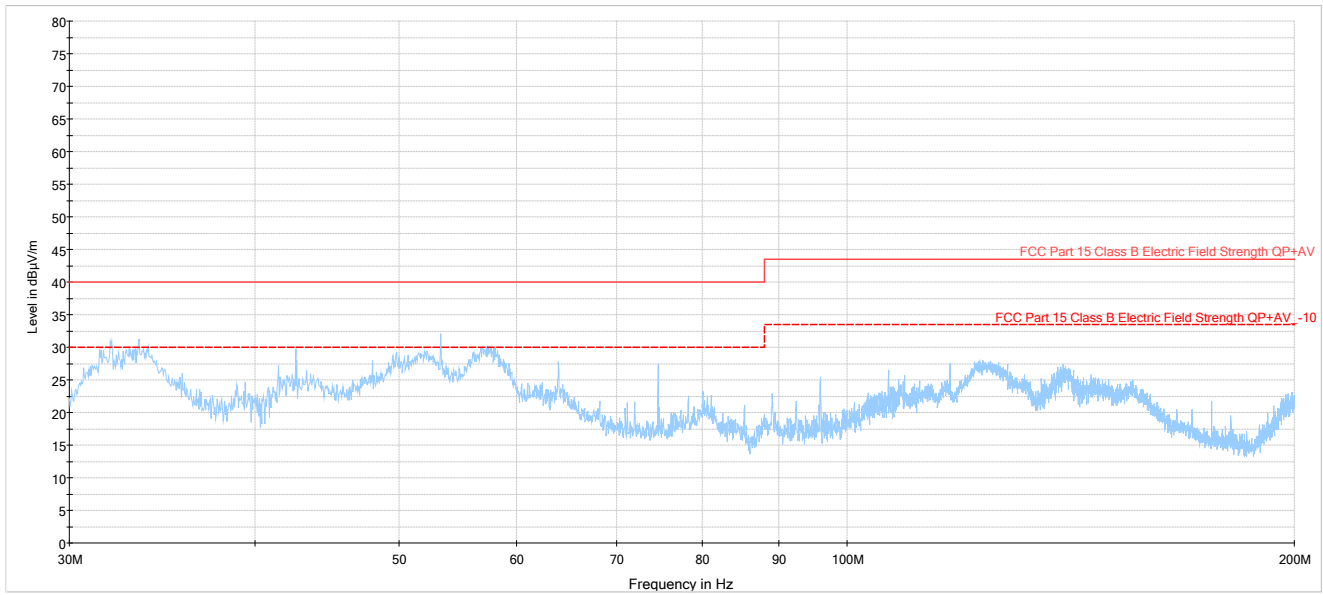

### 8.2.8 30 MHz, 30 MHz to 200 MHz, Horizontal/ Vertical Polarity Table

Test

#### Final Result

Frequency (MHz)	QuasiPeak (dB $\mu$ V/m)	CAverage (dB $\mu$ V/m)	Limit (dB $\mu$ V/m)	Margin (dB)	Meas. Time (ms)	Bandwidth (kHz)	Height (cm)	Pol	Azimuth (deg)	Corr. (dB/m)	Comment
---	---	---	---	---	---	---	---		---	---	

### 8.2.9 30 MHz, 200 MHz to 1000 MHz, Horizontal/ Vertical Polarity Plot

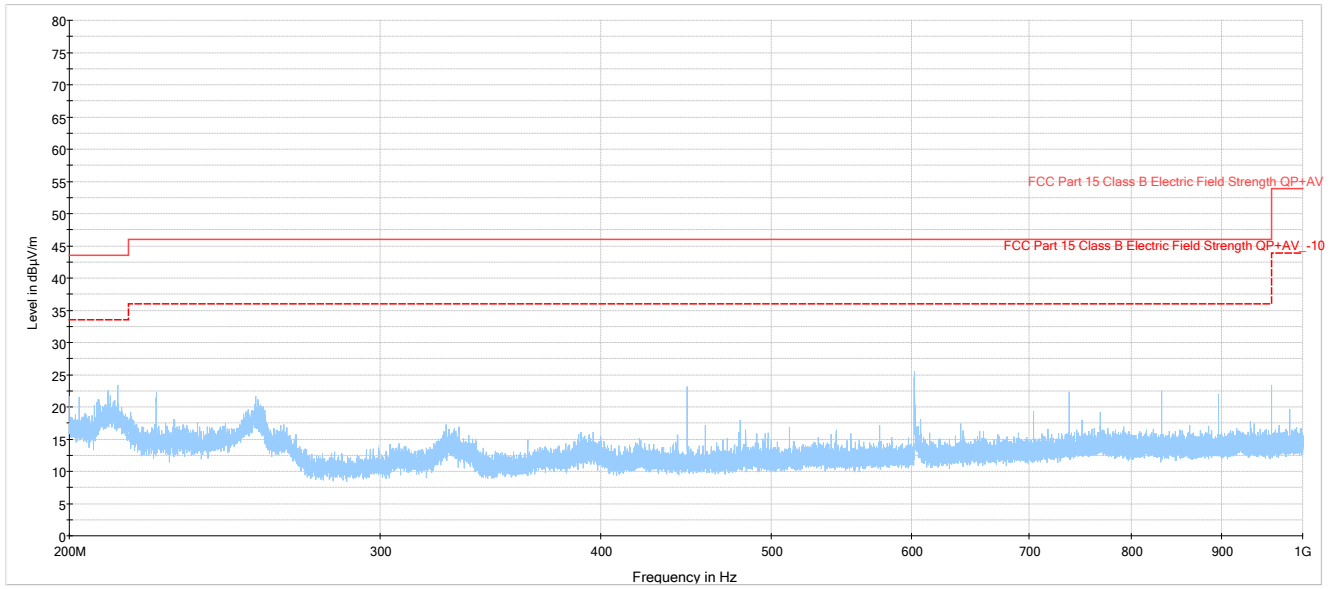

### 8.2.10 30 MHz, 200 MHz to 1000 MHz, Horizontal/ Vertical Polarity Table

Test

#### Final Result

Frequency (MHz)	QuasiPeak (dBµV/m)	CAverage (dBµV/m)	Limit (dBµV/m)	Margin (dB)	Meas. Time (ms)	Bandwidth (kHz)	Height (cm)	Pol	Azimuth (deg)	Corr. (dB/m)	Comment
---	---	---	---	---	---	---	---		---	---	

### 8.2.11 30 MHz, above 1000 MHz, Horizontal/ Vertical Polarity Plot

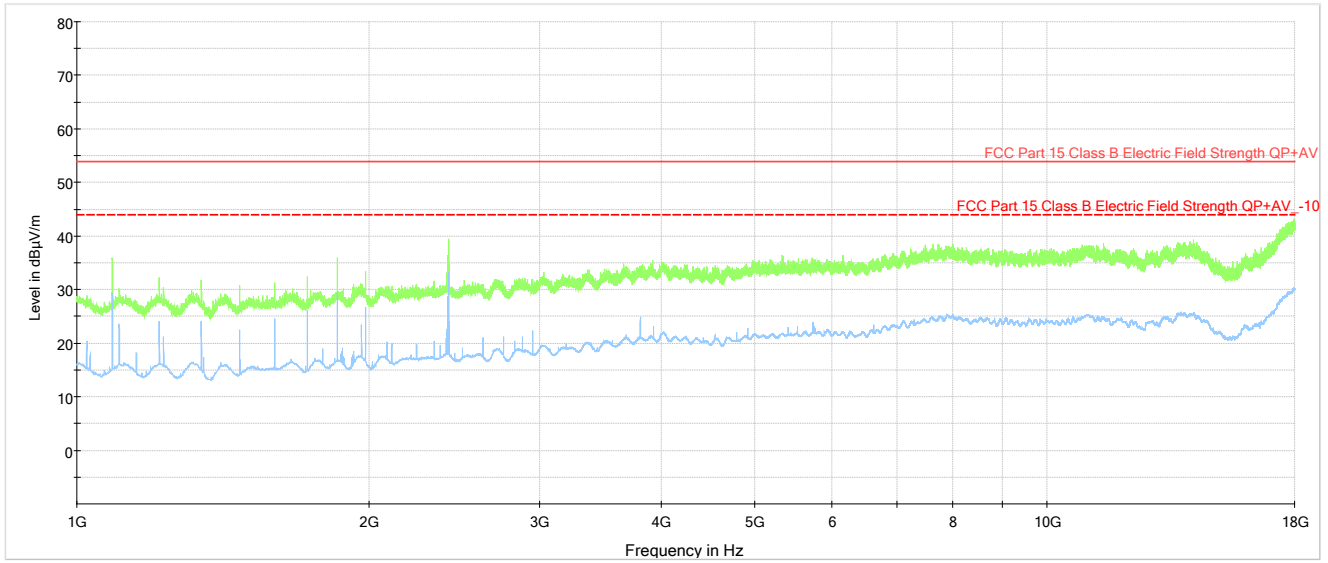

### 8.2.12 30 MHz, above 1000 MHz, Horizontal/ Vertical Polarity Table

Test

#### Final Result

Frequency (MHz)	MaxPeak (dBμV/m)	CAverage (dBμV/m)	Limit (dBμV/m)	Margin (dB)	Meas. Time (ms)	Bandwidth (kHz)	Height (cm)	Pol	Azimuth (deg)	Corr. (dB/m)	Comment
---	---	---	---	---	---	---	---		---	---	



### 8.2.13 45 MHz, 30 MHz to 200 MHz, Horizontal/ Vertical Polarity Plot

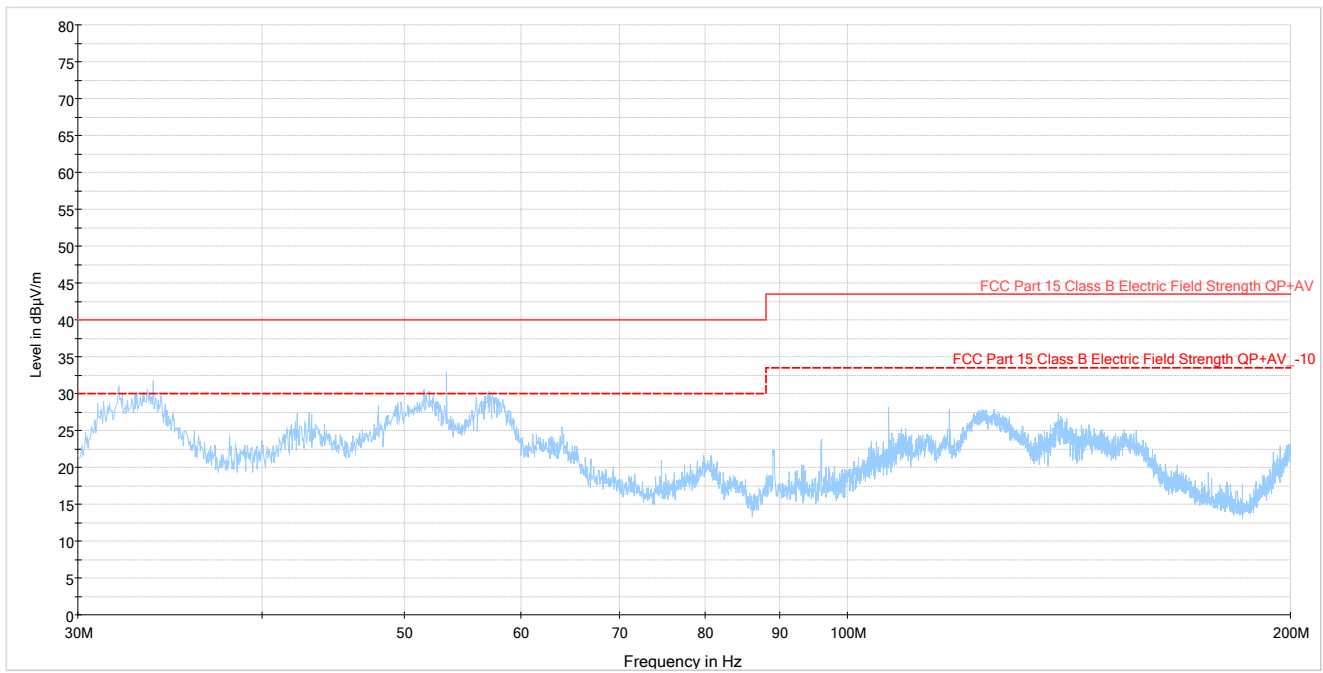

### 8.2.14 45 MHz, 30 MHz to 200 MHz, Horizontal/ Vertical Polarity Table

Test

#### Final Result

Frequency (MHz)	QuasiPeak (dBµV/m)	CAverage (dBµV/m)	Limit (dBµV/m)	Margin (dB)	Meas. Time (ms)	Bandwidth (kHz)	Height (cm)	Pol	Azimuth (deg)	Corr. (dB/m)	Comment
---	---	---	---	---	---	---	---		---	---	

### 8.2.15 45 MHz, 200 MHz to 1000 MHz, Horizontal/ Vertical Polarity Plot

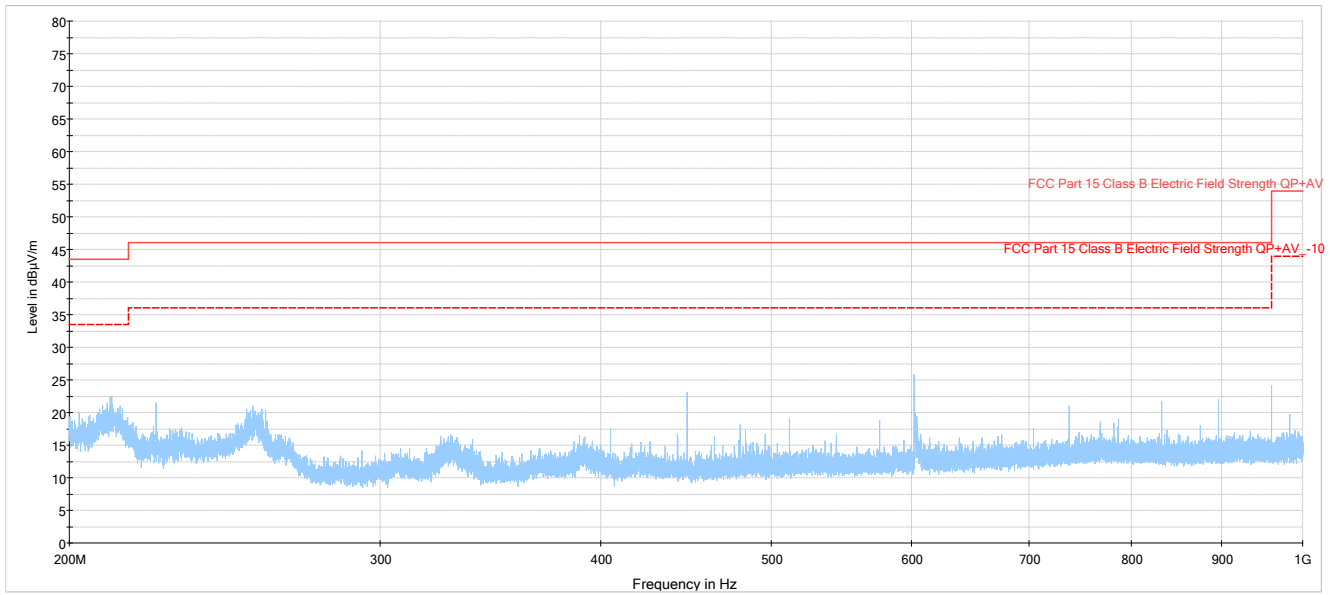

8.2.16 45 MHz, 200 MHz to 1000 MHz, Horizontal/ Vertical Polarity Table

Test

**Final Result**

Frequency (MHz)	QuasiPeak (dBµV/m)	CAverage (dBµV/m)	Limit (dBµV/m)	Margin (dB)	Meas. Time (ms)	Bandwidth (kHz)	Height (cm)	Pol	Azimuth (deg)	Corr. (dB/m)	Comment
---	---	---	---	---	---	---	---		---	---	

### 8.2.17 45 MHz, above 1000 MHz, Horizontal/ Vertical Polarity Plot

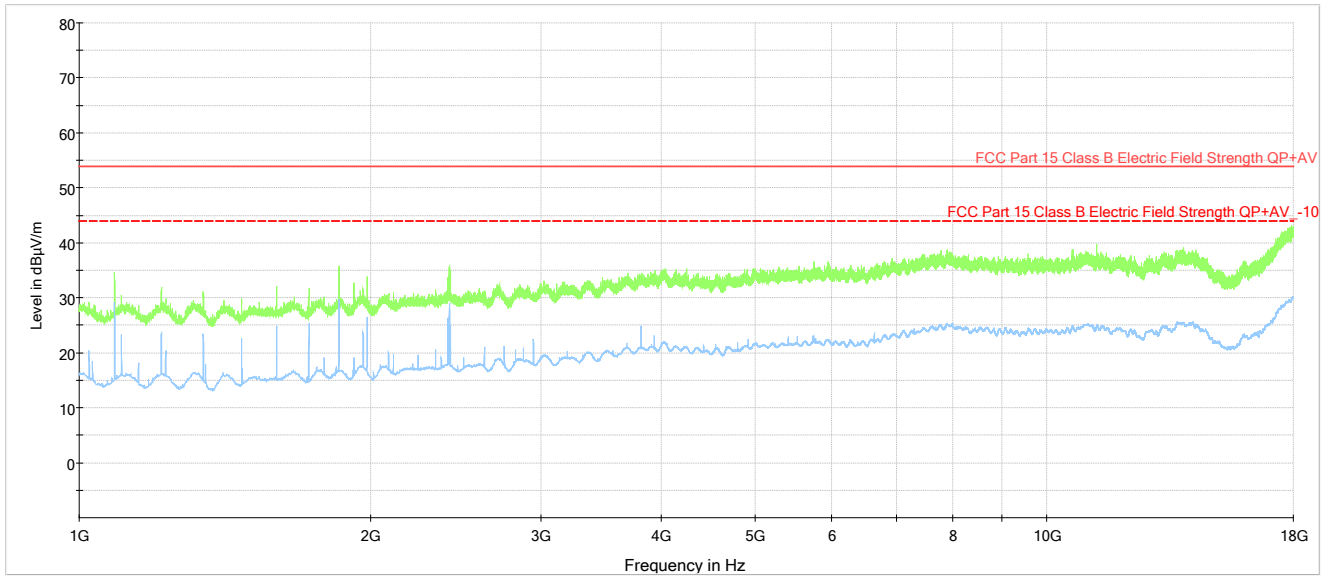

### 8.2.18 45 MHz, above 1000 MHz, Horizontal/ Vertical Polarity Table

Test

#### Final Result

Frequency (MHz)	QuasiPeak (dBµV/m)	CAverage (dBµV/m)	Limit (dBµV/m)	Margin (dB)	Meas. Time (ms)	Bandwidth (kHz)	Height (cm)	Pol	Azimuth (deg)	Corr. (dB/m)	Comment
---	---	---	---	---	---	---	---		---	---	

### 8.2.19 60 MHz, 30 MHz to 200 MHz, Horizontal/ Vertical Polarity Plot

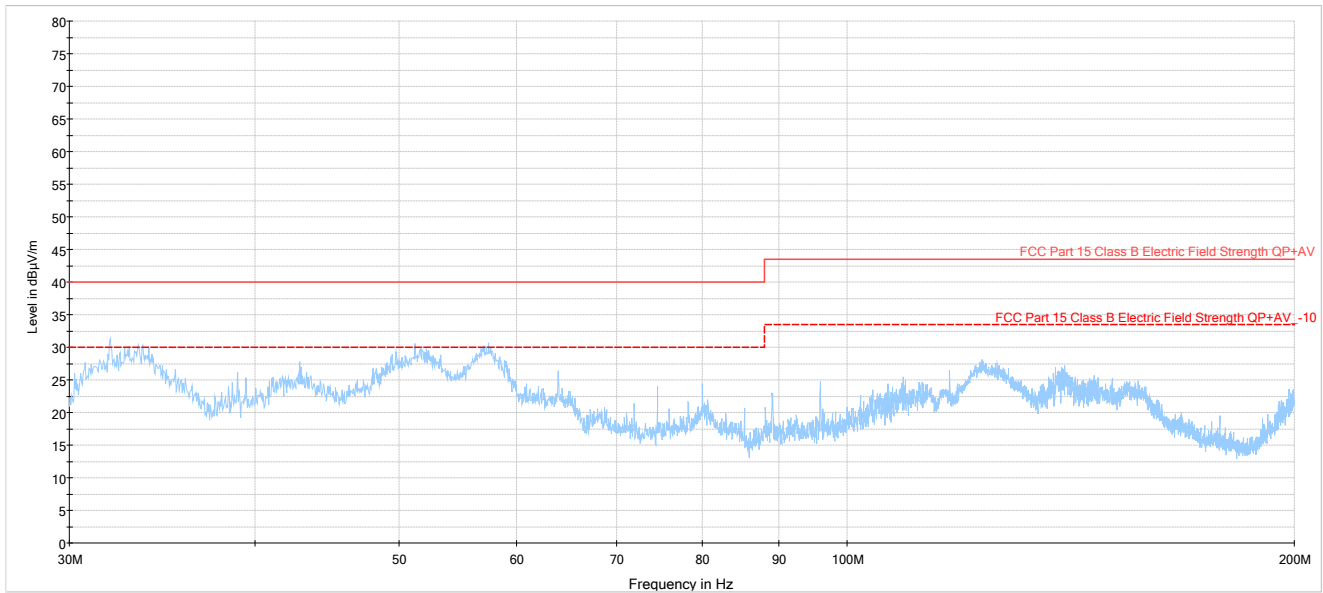

### 8.2.20 60 MHz, 30 MHz to 200 MHz, Horizontal/ Vertical Polarity Table

Test

#### Final Result

Frequency (MHz)	QuasiPeak (dBµV/m)	CAverage (dBµV/m)	Limit (dBµV/m)	Margin (dB)	Meas. Time (ms)	Bandwidth (kHz)	Height (cm)	Pol	Azimuth (deg)	Corr. (dB/m)	Comment
---	---	---	---	---	---	---	---		---	---	



### 8.2.21 60 MHz, 200 MHz to 1000 MHz, Horizontal/ Vertical Polarity Plot

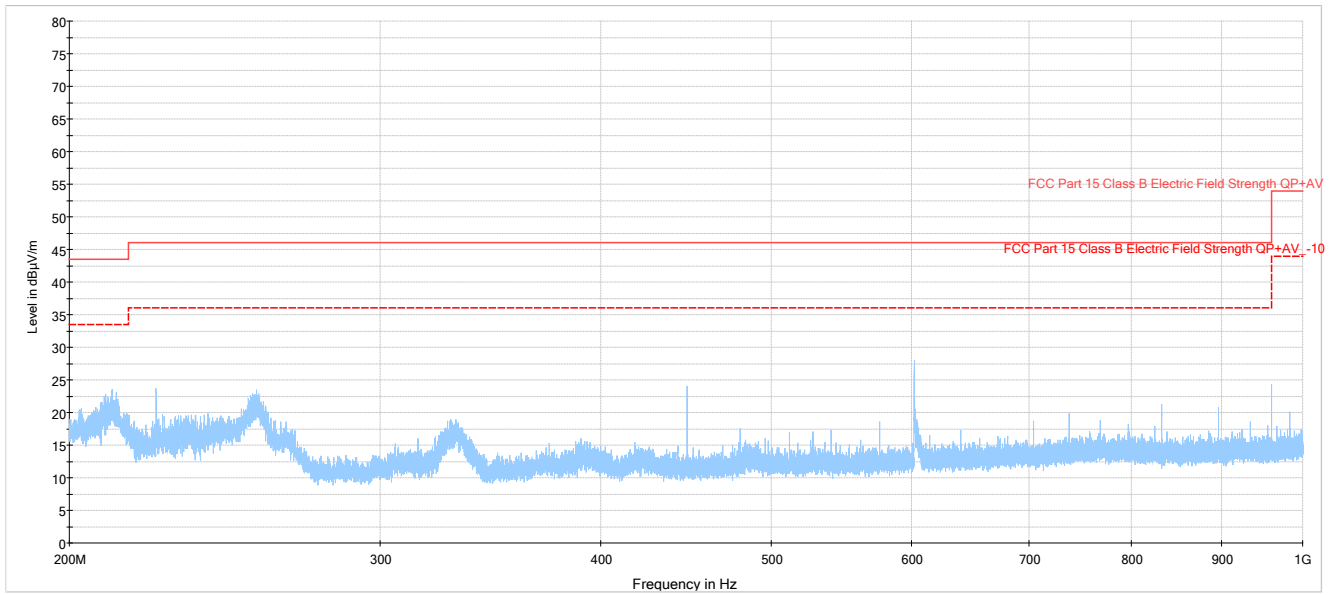

### 8.2.22 60 MHz, 200 MHz to 1000 MHz, Horizontal/ Vertical Polarity Table

Test

#### Final Result

Frequency (MHz)	QuasiPeak (dBµV/m)	CAverage (dBµV/m)	Limit (dBµV/m)	Margin (dB)	Meas. Time (ms)	Bandwidth (kHz)	Height (cm)	Pol	Azimuth (deg)	Corr. (dB/m)	Comment
---	---	---	---	---	---	---	---		---	---	

### 8.2.23 60 MHz, above 1000 MHz, Horizontal/ Vertical Polarity Plot

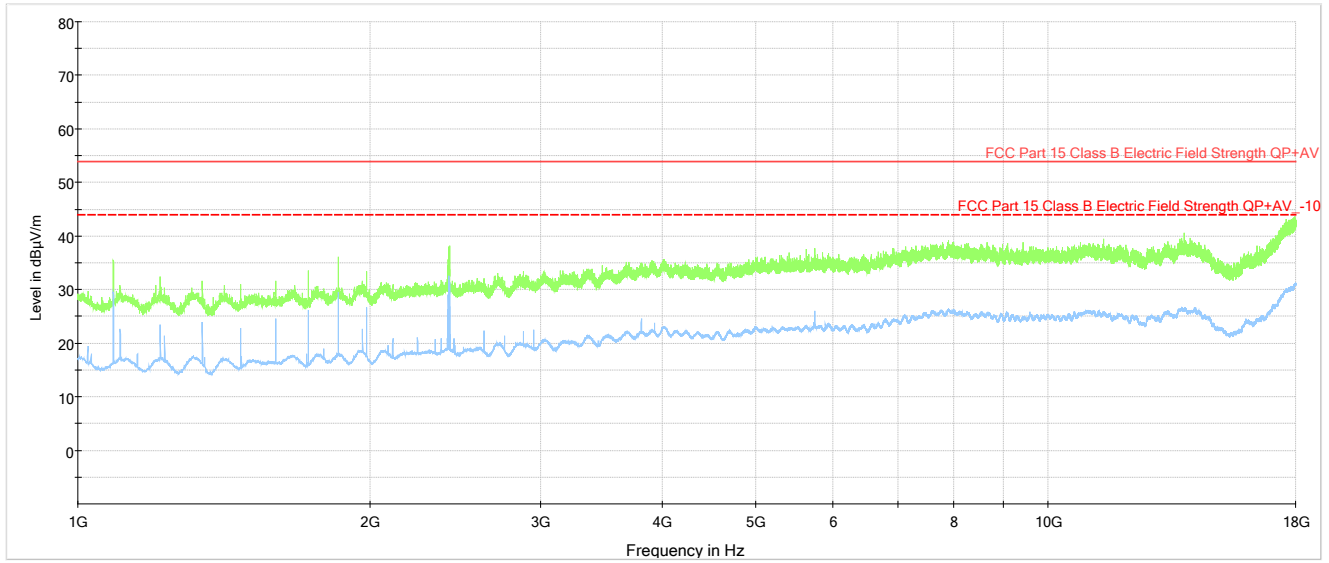

### 8.2.24 60 MHz, above 1000 MHz, Horizontal/ Vertical Polarity Table

Test

#### Final Result

Frequency (MHz)	QuasiPeak (dBμV/m)	CAverage (dBμV/m)	Limit (dBμV/m)	Margin (dB)	Meas. Time (ms)	Bandwidth (kHz)	Height (cm)	Pol	Azimuth (deg)	Corr. (dB/m)	Comment
---	---	---	---	---	---	---	---		---	---	

### 8.3 Conducted Emissions

Limits from FCC 15.107 and test procedure from ANSI C63.4-2014.

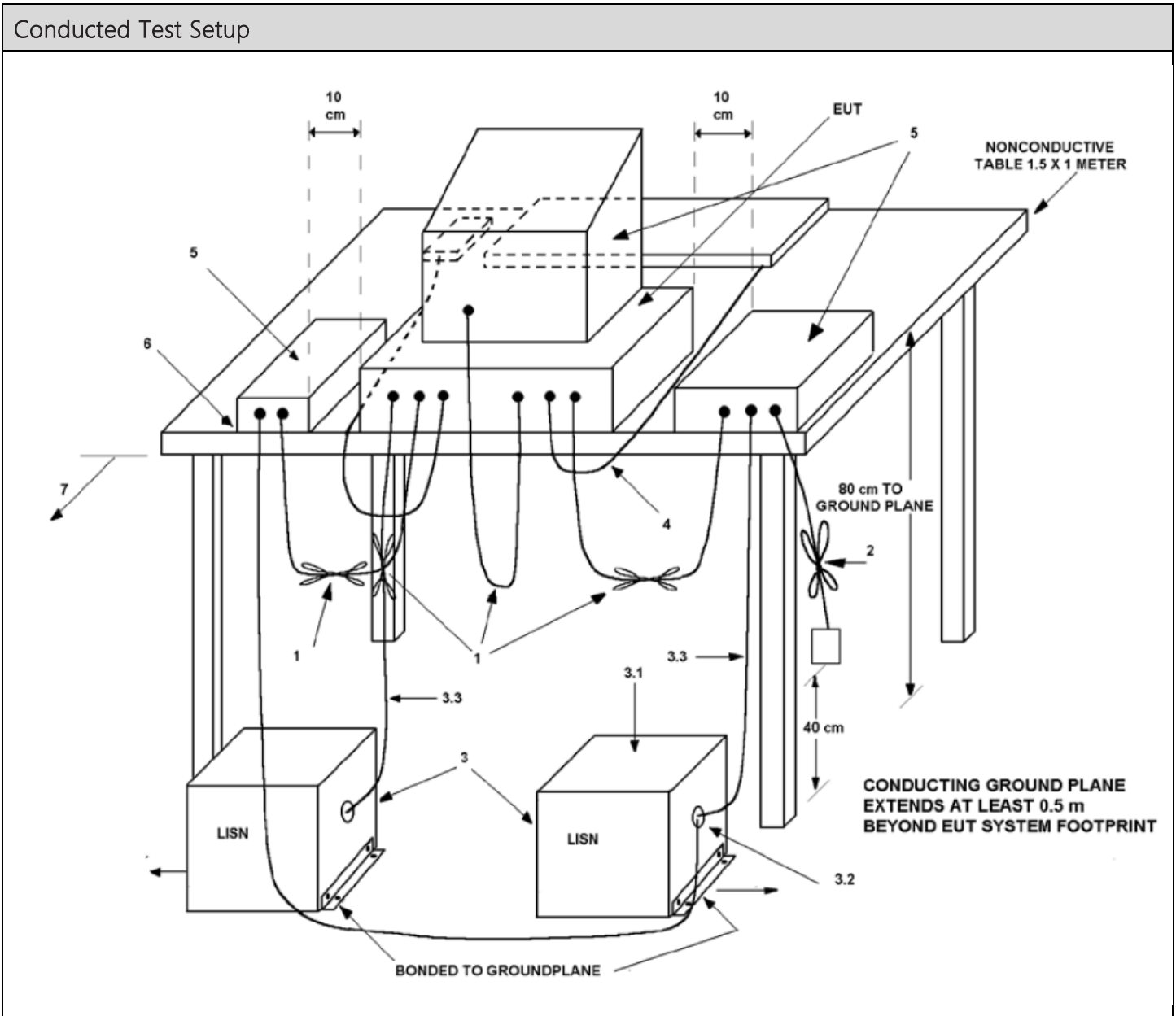

### 8.3.1 Scanning, Line 1 Plot

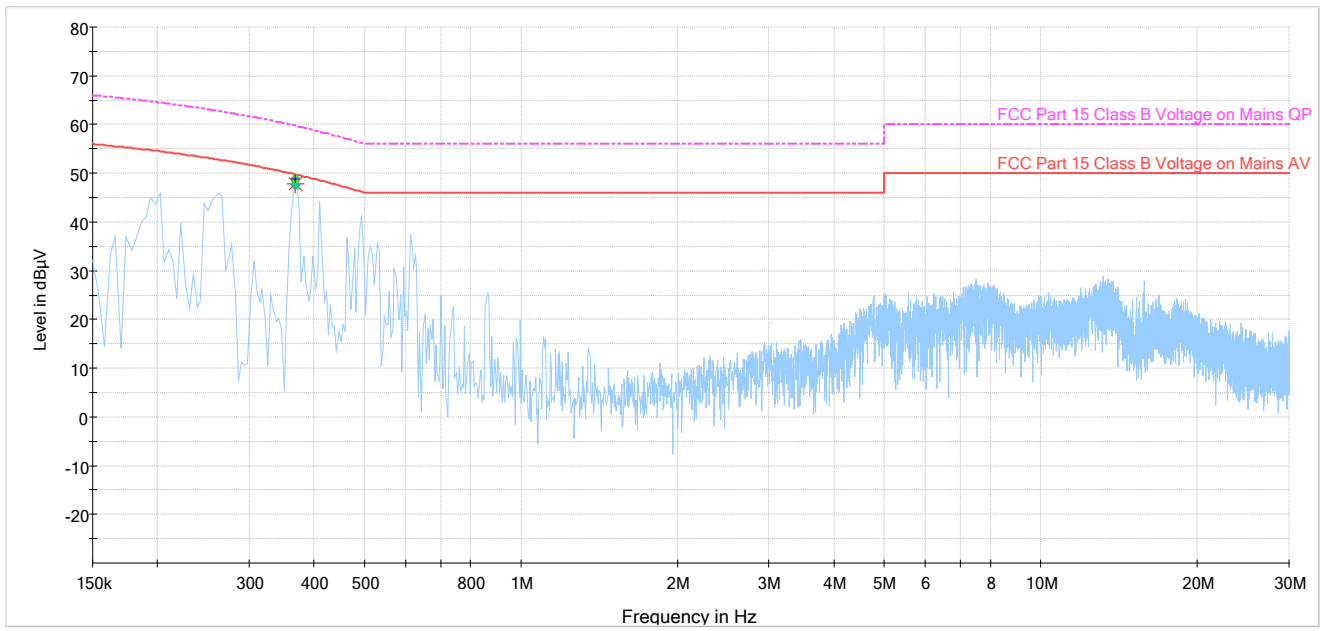

### 8.3.2 Scanning, Line 1 Table

Test

---

#### Final Result

Frequency (MHz)	CAverage (dBμV)	QuasiPeak (dBμV)	Limit (dBμV)	Margin (dB)	Meas. Time (ms)	Bandwidth (kHz)	Line	Filter	Corr. (dB)	Comment
0.368000	---	48.91	59.77	10.86	1000.0	9.000	N	OFF	0.1	
0.368000	47.69	---	49.77	2.08	1000.0	9.000	N	OFF	0.1	

### 8.3.3 Scanning, Line 2 Plot

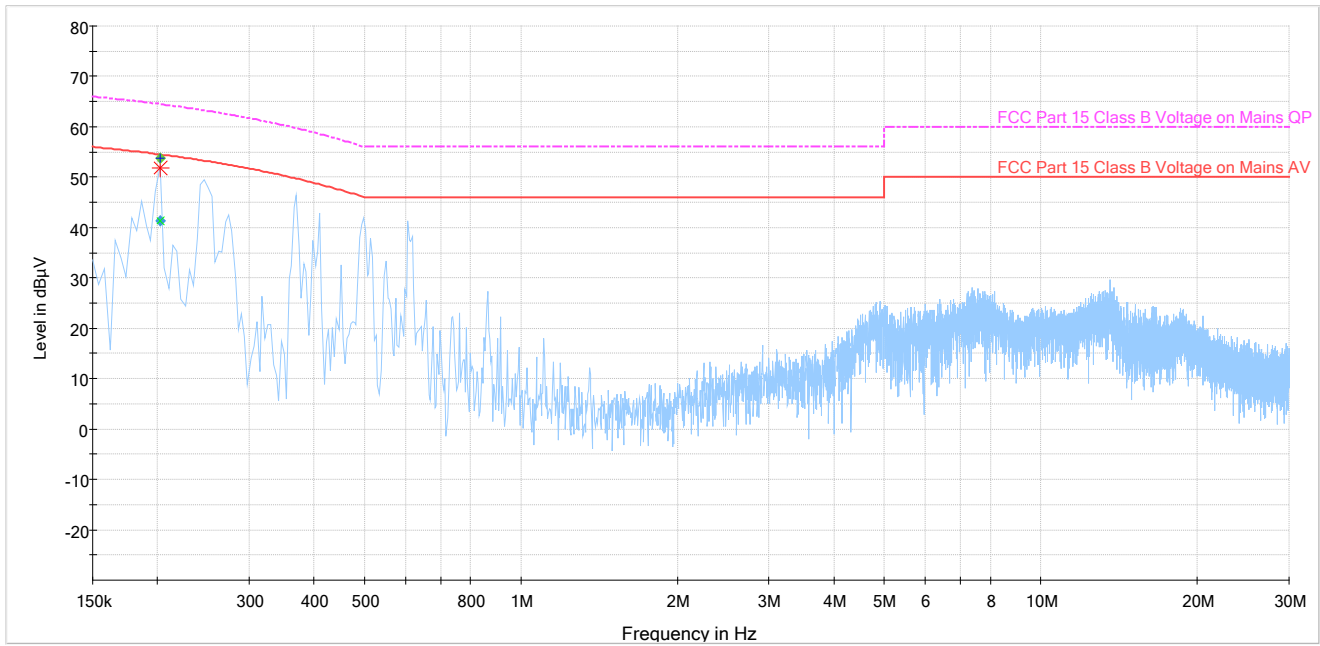



### 8.3.4 Scanning, Line 2 Table

Test

#### Final Result

Frequency (MHz)	CAverage (dBµV)	QuasiPeak (dBµV)	Limit (dBµV)	Margin (dB)	Meas. Time (ms)	Bandwidth (kHz)	Line	Filter	Corr. (dB)	Comment
0.202000	---	53.82	64.51	10.69	1000.0	9.000	N	OFF	0.1	
0.202000	41.25	---	54.51	13.26	1000.0	9.000	N	OFF	0.1	

### 8.3.5 30 MHz, Line 1 Plot

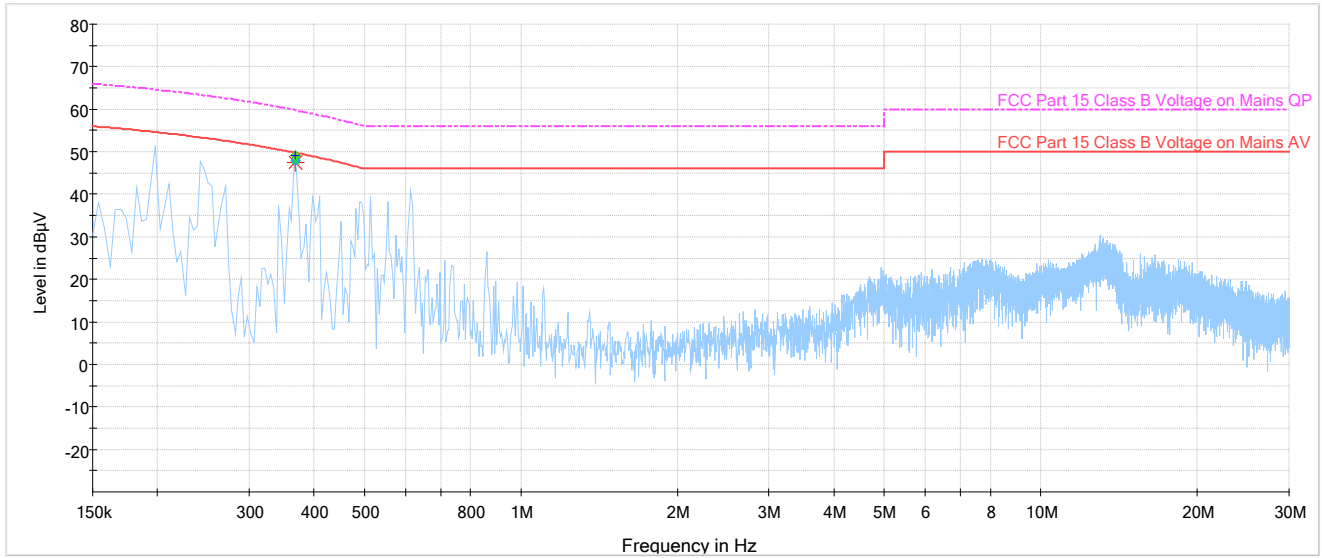

### 8.3.6 30 MHz, Line 1 Table

Test

#### Final Result

Frequency (MHz)	CAverage (dBμV)	QuasiPeak (dBμV)	Limit (dBμV)	Margin (dB)	Meas. Time (ms)	Bandwidth (kHz)	Line	Filter	Corr. (dB)	Comment
0.368000	---	49.02	59.77	10.75	1000.0	9.000	N	OFF	0.1	
0.368000	48.05	---	49.77	1.72	1000.0	9.000	N	OFF	0.1	

### 8.3.7 30 MHz, Line 2 Plot

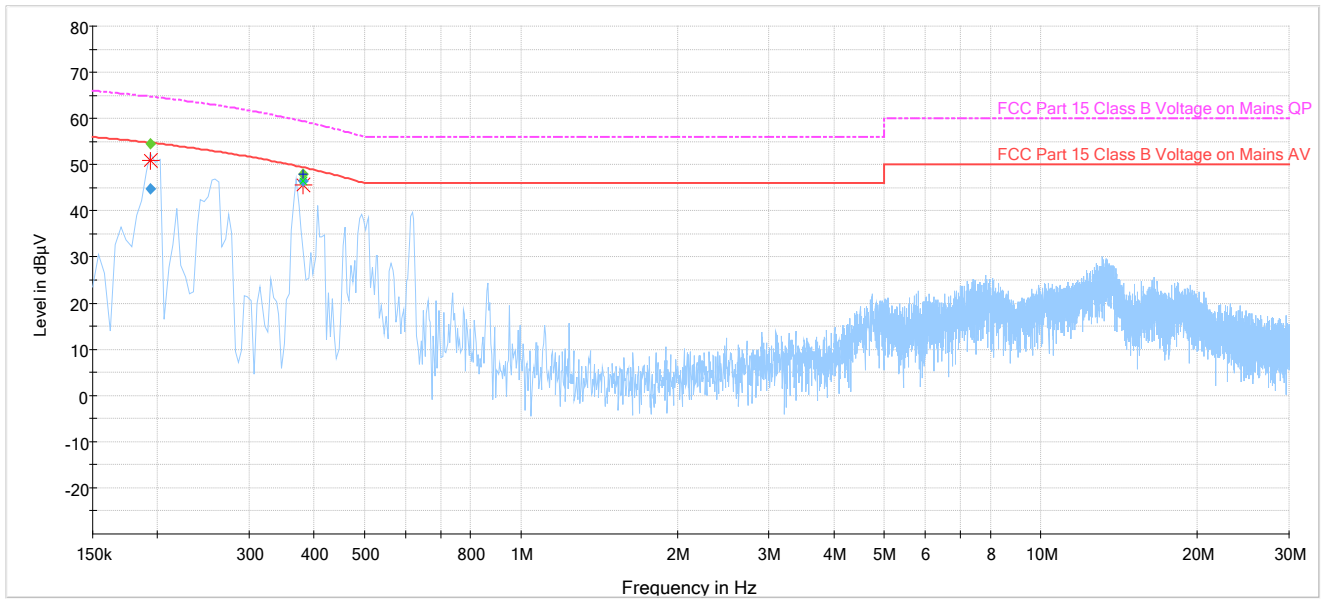

### 8.3.8 30 MHz, Line 2 Table

Test

---

#### Final Result

Frequency (MHz)	CAverage (dBμV)	QuasiPeak (dBμV)	Limit (dBμV)	Margin (dB)	Meas. Time (ms)	Bandwidth (kHz)	Line	Filter	Corr. (dB)	Comment
0.194000	---	54.60	64.74	10.14	1000.0	9.000	N	OFF	0.1	
0.194000	44.69	---	54.74	10.05	1000.0	9.000	N	OFF	0.1	
0.380000	---	47.83	59.43	11.60	1000.0	9.000	N	OFF	0.1	
0.380000	46.50	---	49.43	2.93	1000.0	9.000	N	OFF	0.1	

### 8.3.9 45 MHz, Line 1 Plot

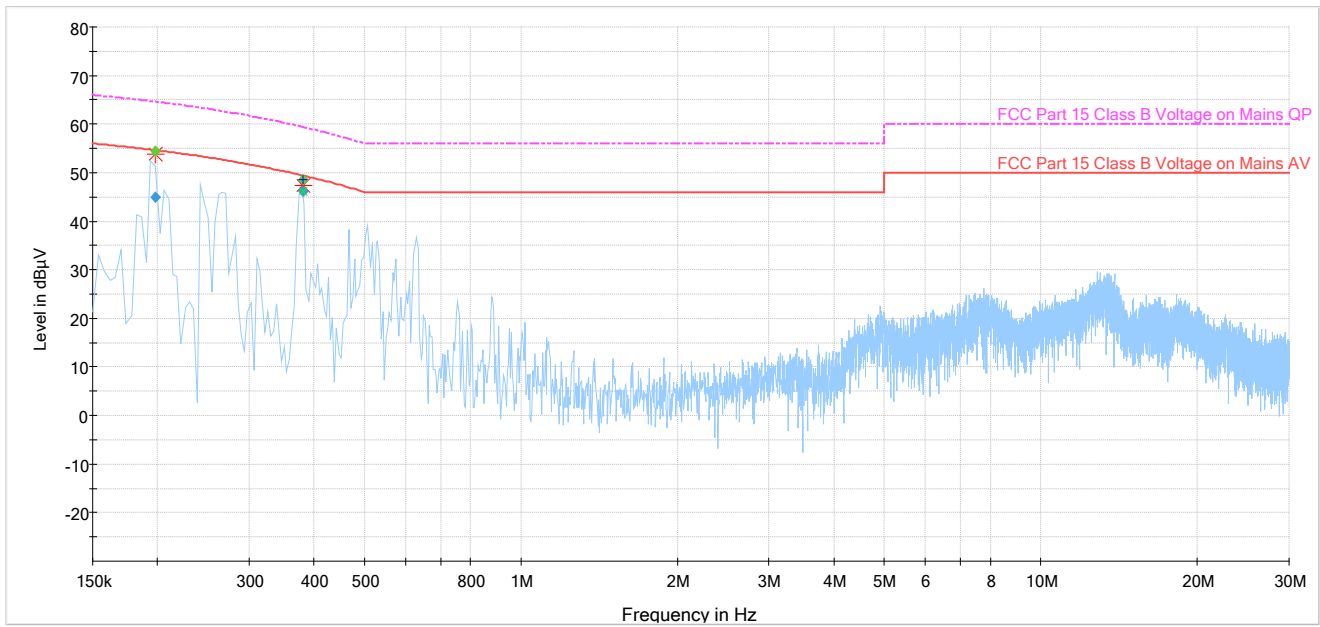

### 8.3.10 45 MHz, Line 1 Table

Test

---

#### Final Result

Frequency (MHz)	CAverage (dBµV)	QuasiPeak (dBµV)	Limit (dBµV)	Margin (dB)	Meas. Time (ms)	Bandwidth (kHz)	Line	Filter	Corr. (dB)	Comment
0.198000	---	54.38	64.63	10.24	1000.0	9.000	N	OFF	0.1	
0.198000	44.84	---	54.63	9.78	1000.0	9.000	N	OFF	0.1	
0.380000	---	48.48	59.43	10.95	1000.0	9.000	N	OFF	0.1	
0.380000	46.23	---	49.43	3.20	1000.0	9.000	N	OFF	0.1	

### 8.3.11 45 MHz, Line 2 Plot

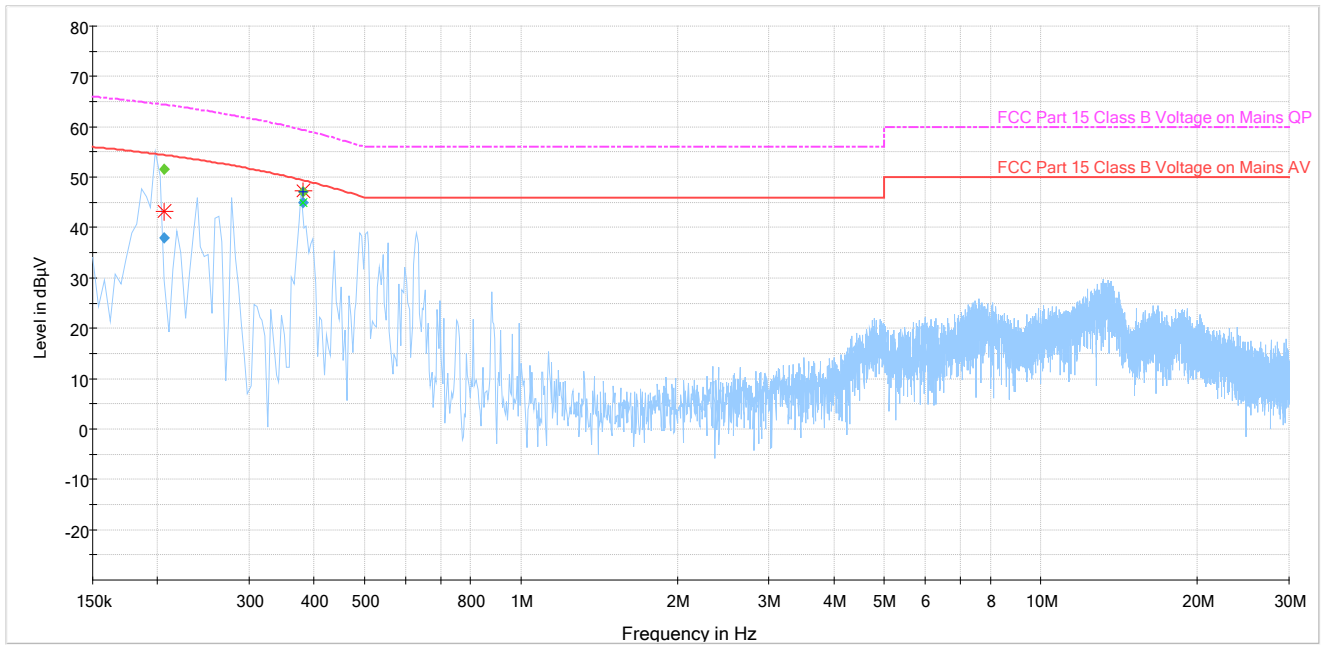



### 8.3.12 45 MHz, Line 2 Table

Test

---

#### Final Result

Frequency (MHz)	CAverage (dBμV)	QuasiPeak (dBμV)	Limit (dBμV)	Margin (dB)	Meas. Time (ms)	Bandwidth (kHz)	Line	Filter	Corr. (dB)	Comment
0.206000	---	51.50	64.40	12.90	1000.0	9.000	N	OFF	0.1	
0.206000	37.87	---	54.40	16.53	1000.0	9.000	N	OFF	0.1	
0.380000	---	47.13	59.43	12.30	1000.0	9.000	N	OFF	0.1	
0.380000	45.01	---	49.43	4.42	1000.0	9.000	N	OFF	0.1	

### 8.3.13 60 MHz, Line 1 Plot

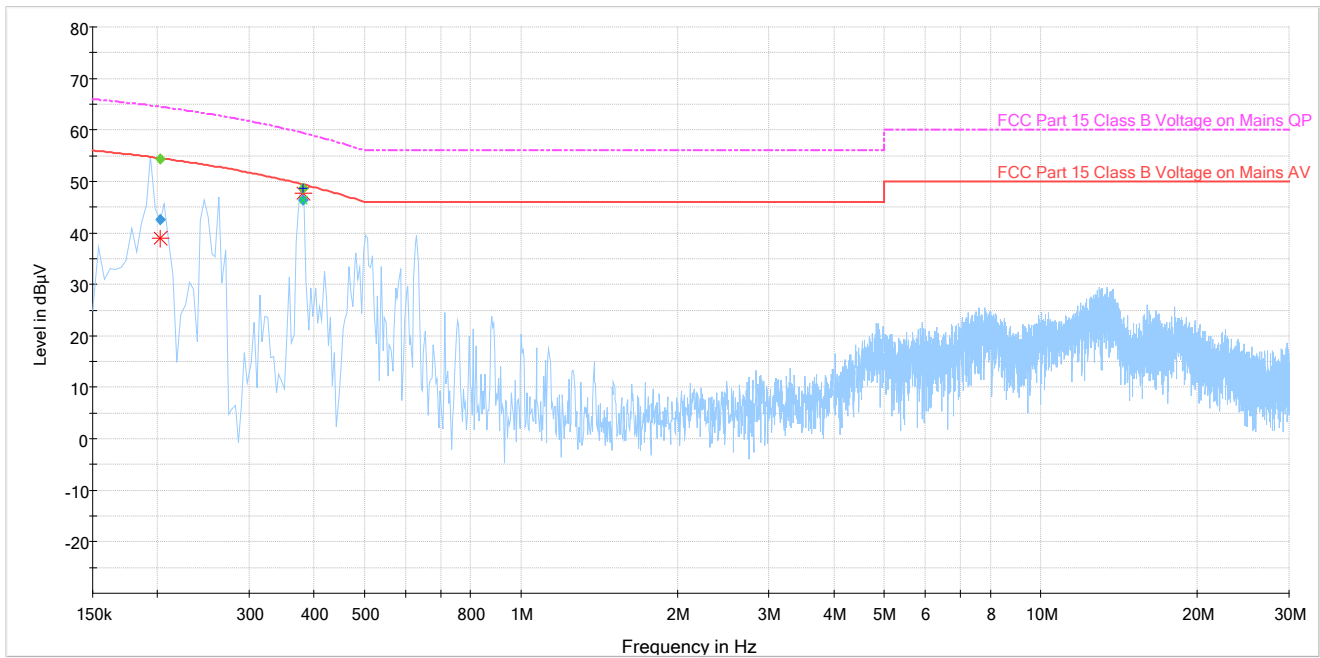

### 8.3.14 60 MHz, Line 1 Table

Test

#### Final Result

Frequency (MHz)	CAverage (dBµV)	QuasiPeak (dBµV)	Limit (dBµV)	Margin (dB)	Meas. Time (ms)	Bandwidth (kHz)	Line	Filter	Corr. (dB)	Comment
0.202000	---	54.27	64.51	10.24	1000.0	9.000	N	OFF	0.1	
0.202000	42.48	---	54.51	12.04	1000.0	9.000	N	OFF	0.1	
0.380000	---	48.59	59.43	10.84	1000.0	9.000	N	OFF	0.1	
0.380000	46.46	---	49.43	2.97	1000.0	9.000	N	OFF	0.1	

### 8.3.15 60 MHz, Line 2 Plot

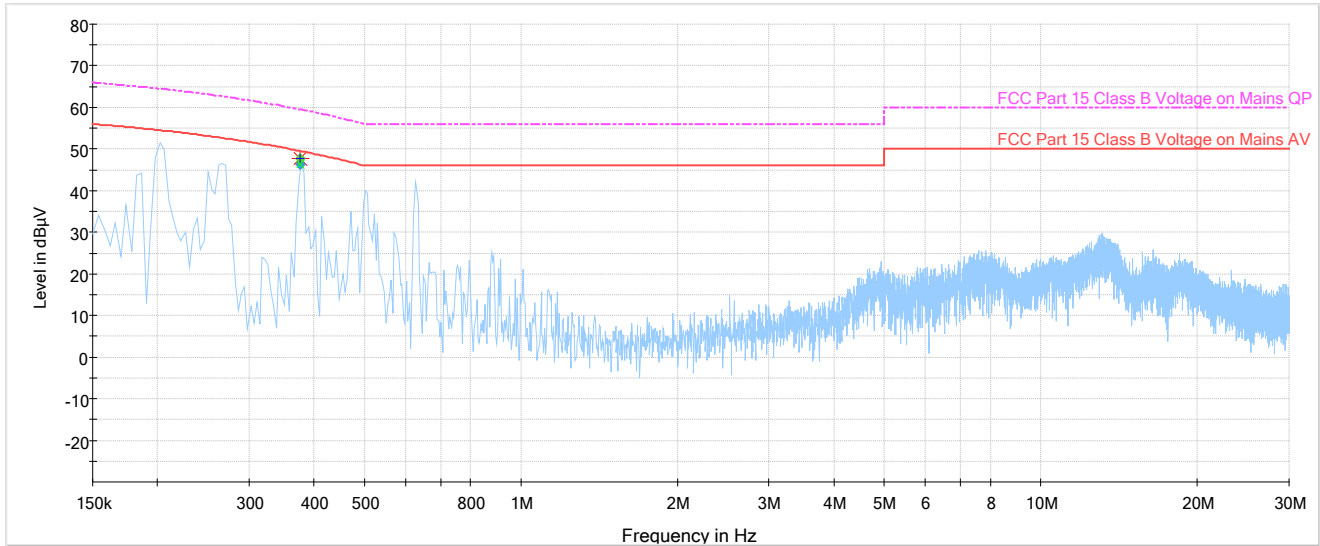

### 8.3.16 60 MHz, Line 2 Table

Test

#### Final Result

Frequency (MHz)	CAverage (dBµV)	QuasiPeak (dBµV)	Limit (dBµV)	Margin (dB)	Meas. Time (ms)	Bandwidth (kHz)	Line	Filter	Corr. (dB)	Comment
0.376000	---	47.84	59.54	11.70	1000.0	9.000	N	OFF	0.1	
0.376000	46.36	---	49.54	3.18	1000.0	9.000	N	OFF	0.1	

## 9. Statements of Compatibility with FCC Rules – part 15.121

This scanning receiver cannot be used or modified to receive cellular radiotelephony frequencies. This is achieved by the key features described in detailed statements below.

Statement assessing the vulnerability of {cust\_desc} to possible modifications and describing design steps taken to make the tuning, control and filtering circuitry inaccessible (15.121 (a)): The receiver portion of the equipment under this application scans the frequency bands 88MHz to 450 MHz. The receiver circuitry cannot be altered to enable it to scan the cellular bands by means of clipping the leads of components, installing a diode and/or jumper wire, or by any other such simple modification. Nor can the receiver be made to scan the cellular bands by replacing a plug-in semiconductor chip, because no such plug-in chips are utilized anywhere in the receiver. The semiconductor chips that are utilized in the tuning function of the equipment cannot be reprogrammed. The tuning, control and filtering circuitry of the receiver is controlled by a microprocessor firmware, which is unalterable by the user (and it is also unalterable by the manufacturer's own support and distribution staff, and their resellers). Any attempt to modify the circuitry cannot therefore result in achieving access to the cellular bands but is likely to make the receiver inoperable.

## 10. ANNEX-B – Test Setup Photographs

Test setup photographs are located in a separate document.

## 11. History of Test Report Changes

Test Report #	Revision #	Description	Date of Issue
TR_15483-24_Main_FCC 15B_Scanning Receiver_	1	Initial release	9/4/2024
	2	Revised page 1	9/12/2024



13146 NW 86<sup>th</sup> Drive, Suite 400, Alachua, Florida 32615  
(352) 472-5500 / [testing@industrial-ia.com](mailto:testing@industrial-ia.com)

---

END OF TEST REPORT

---