

ENGINEERING TEST REPORT

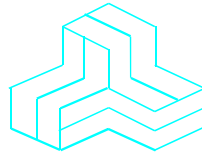

Iridium Active Antenna
Model: AH-41
FCC ID: AFJ420310

Applicant:

ICOM Incorporated
1-1-32, Kamiminami, Hirano-ku
Osaka, Japan, 547-0003

Tested in Accordance With

Federal Communications Commission (FCC)
47 CFR, Parts 2 and 25 (Subpart C)

UltraTech's File No.: 21ICOM534_FCC25

This Test report is Issued under the Authority of
Tri M. Luu
Vice President of Engineering
UltraTech Group of Labs

Date: March 26, 2021

Report Prepared by: Dan Huynh

Tested by: Hung Trinh

Issued Date: March 26, 2021

Test Dates: March 11 - 22, 2021

- *The results in this Test Report apply only to the sample(s) tested, and the sample tested is randomly selected.*
- *This report must not be used by the client to claim product endorsement by any agency of the US Government.*
- *This test report shall not be reproduced, except in full, without a written approval from UltraTech*

UltraTech

3000 Bristol Circle, Oakville, Ontario, Canada, L6H 6G4

Tel.: (905) 829-1570 Fax.: (905) 829-8050

Website: www.ultratech-labs.com, Email: vic@ultratech-labs.com, Email: tri@ultratech-labs.com



1309



CA0001-2049



AT-1945



SL2-IN-E-1119R



Korea KCC-RRR

CA0001

TABLE OF CONTENTS

EXHIBIT 1. INTRODUCTION..... 1

1.1. SCOPE 1

1.2. RELATED SUBMITTAL(S)/GRANT(S)..... 1

1.3. NORMATIVE REFERENCES..... 1

EXHIBIT 2. PERFORMANCE ASSESSMENT 2

2.1. CLIENT INFORMATION 2

2.2. EQUIPMENT UNDER TEST (EUT) INFORMATION 2

2.3. EUT’S TECHNICAL SPECIFICATIONS 3

2.4. LIST OF EUT’S PORTS 3

2.5. ANCILLARY EQUIPMENT 3

EXHIBIT 3. EUT OPERATING CONDITIONS AND CONFIGURATIONS DURING TESTS 4

3.1. CLIMATE TEST CONDITIONS 4

3.2. OPERATIONAL TEST CONDITIONS & ARRANGEMENT FOR TEST SIGNALS 4

EXHIBIT 4. SUMMARY OF TEST RESULTS..... 5

4.1. LOCATION OF TESTS..... 5

4.2. APPLICABILITY & SUMMARY OF EMC EMISSION TEST RESULTS 5

4.3. MODIFICATIONS INCORPORATED IN THE EUT FOR COMPLIANCE PURPOSES..... 5

4.4. DEVIATION OF STANDARD TEST PROCEDURES..... 5

EXHIBIT 5. TEST DATA 6

5.1. RF POWER OUTPUT [§§ 2.1046 & 25.204(A)] 6

5.2. OCCUPIED BANDWIDTH AND EMISSION LIMITATIONS [§§ 2.1049 & 25.202(F)] 8

5.3. TRANSMITTER SPURIOUS EMISSIONS AT ANTENNA TERMINALS [§§ 2.1053, 25.202 & 25.216] 16

5.4. TRANSMITTER SPURIOUS/HARMONIC RADIATED EMISSIONS [§§ 2.1053 25.202 & 25.216] 24

5.5. EXPOSURE OF HUMANS TO RF FIELD [§§ 1.1310 & 2.1091] 27

EXHIBIT 6. TEST EQUIPMENT LIST 29

EXHIBIT 7. MEASUREMENT UNCERTAINTY 30

EXHIBIT 1. INTRODUCTION

1.1. SCOPE

Reference:	FCC Parts 2 and 25
Title:	Code of Federal Regulations (CFR), Title 47 Telecommunication – Parts 2 & 25
Purpose of Test:	FCC Equipment Authorization Certification for Part 25 Satellite Communications Radio operating in the Frequency Band 1616.0 MHz to 1626.5 MHz
Test Procedures:	<ul style="list-style-type: none">• ANSI C63.26-2015• ANSI C63.4

1.2. RELATED SUBMITTAL(S)/GRANT(S)

None.

1.3. NORMATIVE REFERENCES

Publication	Year	Title
FCC CFR Parts 0-19, 80-End	2021	Code of Federal Regulations, Title 47 – Telecommunication
ANSI C63.4	2014	American National Standard for Methods of Measurement of Radio- Noise Emissions from Low-Voltage Electrical and Electronic Equipment in the Range of 9 kHz to 40 GHz
ANSI/TIA-603-E	2016	Land Mobile FM or PM Communications Equipment Measurement and Performance Standards
ANSI C63.26	2015	American National Standard for Compliance Testing of Transmitters Used in Licensed Radio Services

EXHIBIT 2. PERFORMANCE ASSESSMENT

2.1. CLIENT INFORMATION

Applicant	
Name:	Icom Incorporated
Address:	1-1-32, Kamiminami Hirano-ku, Osaka Japan, 547-0003
Contact Person:	Mr. Atsushi Tomiyama Phone #: +81 6 6793 5302 Fax #: +81 6 6793 0013 Email Address: world_support@icom.co.jp

Manufacturer	
Name:	Icom Incorporated
Address:	1-1-32, Kamiminami Hirano-ku, Osaka Japan, 547-0003
Contact Person:	Mr. Atsushi Tomiyama Phone #: +81 6 6793 5302 Fax #: +81 6 6793 0013 Email Address: world_support@icom.co.jp

2.2. EQUIPMENT UNDER TEST (EUT) INFORMATION

The following information (with the exception of the Date of Receipt) has been supplied by the applicant.

Brand Name:	ICOM Incorporated
Product Name:	Iridium Active Antenna
Model Name or Number:	AH-41
Serial Number:	11000310
Type of Equipment:	Amplifier
Power Supply Requirement:	+28.5 VDC
Transmitting/Receiving Antenna Type:	Integral
Primary User Functions of EUT:	Power amplifier

2.3. EUT'S TECHNICAL SPECIFICATIONS

Transmitter	
Equipment Type:	Mobile
Intended Operating Environment:	Commercial, industrial or business environment
Power Supply Requirement:	+28.5 VDC
RF Output Power Rating:	+37.7 dBm ± 1dBm (at +23.3 dBm input)
Operating Frequency Range:	1616.0 MHz to 1626.5 MHz
RF Output Impedance:	50 Ω
Channel Spacing:	N/A
Modulation Employed:	DE-BPSK
Emission Designation:	V7W
Antenna Connector Type:	Integral

2.4. LIST OF EUT'S PORTS

Port Number	EUT's Port Description	Number of Identical Ports	Connector Type	Cable Type (Shielded/Non-shielded)
1	RX UNIT Connector	1	SMA	Shielded
1	TX UNIT Connector	1	SMA	Shielded
1	RF Input	1	N	Shielded

2.5. ANCILLARY EQUIPMENT

Ancillary Equipment # 1	
Description:	AC adapter
Brand name:	Jet Icom Inc
Model Name or Number:	BC-2286A-601DA15
Connected to EUT's Port:	Power Box BC-253

Ancillary Equipment # 2	
Description:	Power Box
Brand name:	Icom
Model Name or Number:	BC-253
Connected to EUT's Port:	N port of EUT

Ancillary Equipment # 3	
Description:	Icom Handset
Brand name:	Icom
Model Name or Number:	IC-SAT100
Connected to EUT's Port:	Power Box BC-253

ULTRATECH GROUP OF LABS

3000 Bristol Circle, Oakville, Ontario, Canada L6H 6G4
 Tel. #: 905-829-1570, Fax. #: 905-829-8050, Email: vic@ultratech-labs.com, Website: <http://www.ultratech-labs.com>

File #: 211COM534_FCC25
 March 26, 2021

All test results contained in this engineering test report are traceable to National Institute of Standards and Technology (NIST)

EXHIBIT 3. EUT OPERATING CONDITIONS AND CONFIGURATIONS DURING TESTS

3.1. CLIMATE TEST CONDITIONS

The climate conditions of the test environment are as follows:

Temperature:	21°C - 24°C
Humidity:	45% to 58%
Pressure:	102 kPa
Power input source:	+28.5 VDC via AC Adapter and Power Box

3.2. OPERATIONAL TEST CONDITIONS & ARRANGEMENT FOR TEST SIGNALS

Operating Modes:	The transmitter was operated in a continuous transmission mode with the carrier modulated as specified in the Test Data.
Special Test Software:	N/A
Special Hardware Used:	N/A
Transmitter Test Antenna:	The EUT is tested with the transmitter antenna port terminated to a 50 Ω Load/with integral antenna for radiated emissions test.

Transmitter Test Signals	
Frequency Band(s):	1616.0 MHz to 1626.5 MHz
Test Frequency(ies):	Channel 1: 1616.020833 MHz Channel 121: 1621.020825 MHz Channel 240: 1625.979151 MHz
Transmitter Wanted Output Test Signals:	
<ul style="list-style-type: none"> • Transmitter Power (measured maximum output power): • Normal Test Modulation: • Modulating signal source: 	37.81 dBm (6.04 W) V7W External

EXHIBIT 4. SUMMARY OF TEST RESULTS

4.1. LOCATION OF TESTS

All of the measurements described in this report were performed at Ultratech Group of Labs located in the city of Oakville, Province of Ontario, Canada.

Radiated Emissions were performed at the Ultratech's 3-10 TDK Semi-Anechoic Chamber situated in the Town of Oakville, province of Ontario. This test site been calibrated in accordance with ANSI C63.4, and found to be in compliance with the requirements of Sec. 2.948 of the FCC Rules. The descriptions and site measurement data of the Oakville 3-10 TDK Semi-Anechoic Chamber has been filed with ANAB File No.: AT-1945.

4.2. APPLICABILITY & SUMMARY OF EMC EMISSION TEST RESULTS

FCC Section(s)	Test Requirements	Applicability (Yes/No)
2.1046 & 25.204(a),(c) & (d)	RF Power Output	Yes
2.1047(a)	Modulation Characteristics - Audio Frequency Response	N/A
2.1047(b)	Modulation Characteristics - Modulation Limiting	N/A
2.1049, 25.202(f)	Occupied Bandwidth and Emission Limitations	Yes
2.1051, 2.1057, 25.202(f) & 25.216	Spurious Emissions at Antenna Terminals	Yes
2.1053, 2.1057, 25.202(f) & 25.216	Field Strength of Spurious Radiation	Yes
2.1055 & 25.202(d)	Frequency Stability	N/A
1.1307, 1.1310 & 2.1091	Radiofrequency Radiation Exposure Evaluation	Yes

4.3. MODIFICATIONS INCORPORATED IN THE EUT FOR COMPLIANCE PURPOSES

None.

4.4. DEVIATION OF STANDARD TEST PROCEDURES

None.

ULTRATECH GROUP OF LABS

3000 Bristol Circle, Oakville, Ontario, Canada L6H 6G4
Tel. #: 905-829-1570, Fax. #: 905-829-8050, Email: vic@ultratech-labs.com, Website: <http://www.ultratech-labs.com>

File #: 211COM534_FCC25
March 26, 2021

All test results contained in this engineering test report are traceable to National Institute of Standards and Technology (NIST)

EXHIBIT 5. TEST DATA

5.1. RF POWER OUTPUT [§§ 2.1046 & 25.204(a)]

5.1.1. Limits

§25.204 Power limits for earth stations

(a) In bands shared coequally with terrestrial radio communication services, the equivalent isotropically radiated power transmitted in any direction towards the horizon by an earth station, other than an ESV, operating in frequency bands between 1 and 15 GHz, shall not exceed the following limits except as provided for in paragraph (c) of this section:

- + 40 dBW in any 4 kHz band for $\theta \leq 0^\circ$
- + 40 + 3θ dBW in any 4 kHz band for $0^\circ < \theta \leq 5^\circ$

where θ is the angle of elevation of the horizon viewed from the center of radiation of the antenna of the earth station and measured in degrees as positive above the horizontal plane and negative below it.

5.1.2. Method of Measurements

ANSI C63.26 Section 5.2.

5.1.3. Test Arrangement

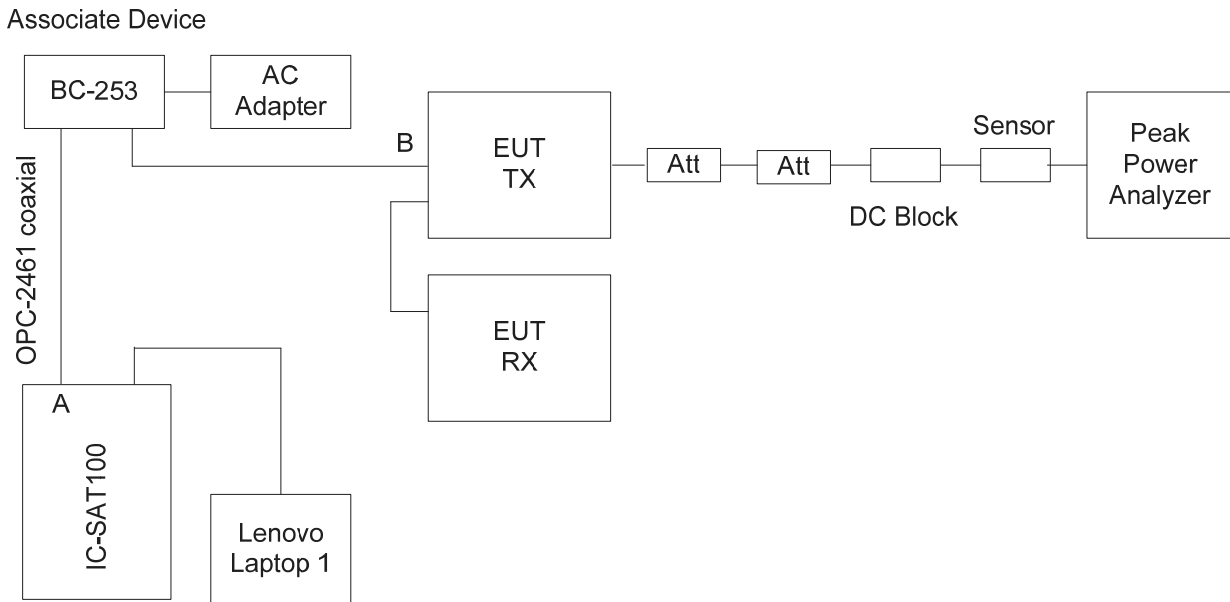

Associate Device

Output of SAT100 is around 36.23dBm (at A)

Cable assembly loss included BC-253 box is 12.81dB (from A to B)

5.1.4. Test Data

Remark: Antenna peak gain = -3 dBi

Channel	Frequency (MHz)	Input to EUT (dBm)	Output from EUT (dBm)	Antenna Gain (dBi)	EIRP (dBm)
1	1616.020833	23.42	37.81	-3	34.81
121	1621.020825	23.38	37.74	-3	34.74
240	1625.979151	23.41	37.57	-3	34.57

5.2. OCCUPIED BANDWIDTH AND EMISSION LIMITATIONS [§§ 2.1049 & 25.202(f)]

5.2.1. Limits

§25.202 (f) Emission limitations

Except for SDARS terrestrial repeaters and as provided for in paragraph (i), the mean power of emissions shall be attenuated below the mean output power of the transmitter in accordance with the schedule set forth in paragraphs (f)(1) through (f)(4) of this section. The out-of-band emissions of SDARS terrestrial repeaters shall be attenuated in accordance with the schedule set forth in paragraph (h) of this section.

(1) In any 4 kHz band, the center frequency of which is removed from the assigned frequency by more than 50 percent up to and including 100 percent of the authorized bandwidth: 25 dB;

(2) In any 4 kHz band, the center frequency of which is removed from the assigned frequency by more than 100 percent up to and including 250 percent of the authorized bandwidth: 35 dB;

(3) In any 4 kHz band, the center frequency of which is removed from the assigned frequency by more than 250 percent of the authorized bandwidth: An amount equal to 43 dB plus 10 times the logarithm (to the base 10) of the transmitter power in watts;

(4) In any event, when an emission outside of the authorized bandwidth causes harmful interference, the Commission may, at its discretion, require greater attenuation than specified in paragraphs (f) (1), (2) and (3) of this section.

5.2.2. Method of Measurements

47 CFR 2.1049 and ANSI C63.26 Sections 5.4 and 5.7.

5.2.3. Test Arrangement

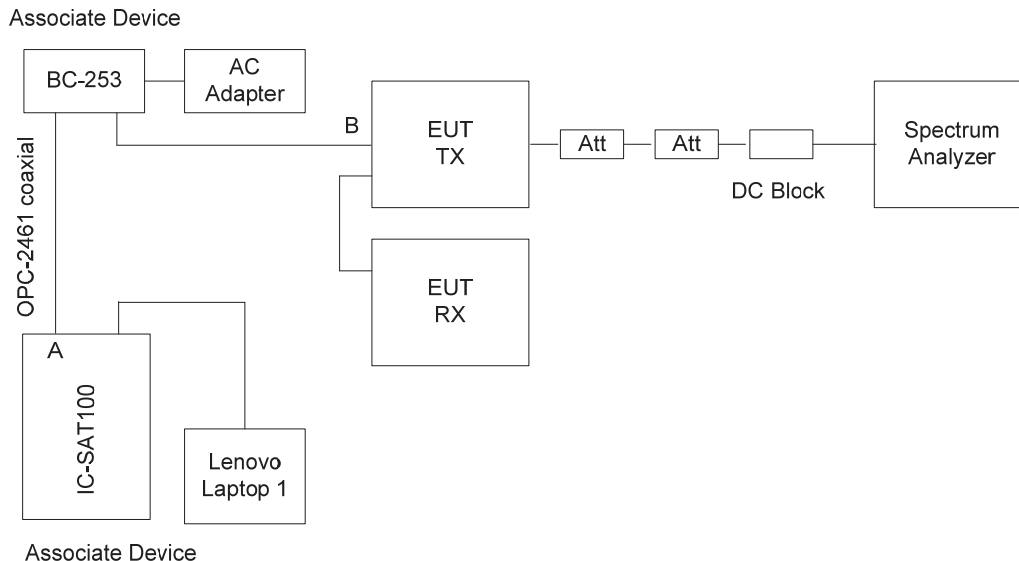

Output of SAT100 is around 36.23dBm (at A)

Cable assembly loss included BC-253 box is 12.81dB (from A to B)

5.2.4. Test Data

5.2.4.1. 99% Occupied Bandwidth

Channel	Frequency (MHz)	Input 99% Occupied Bandwidth (kHz)	Output 99% Occupied Bandwidth (kHz)
1	1616.020833	29.42	29.90
121	1621.020825	29.42	29.42
240	1625.979151	29.42	29.81

* See the following plots for details of measurements

Plot 5.2.4.1.1. 99% Occupied Bandwidth, Ch 1, 1616.020833 MHz (Input Bandwidth)

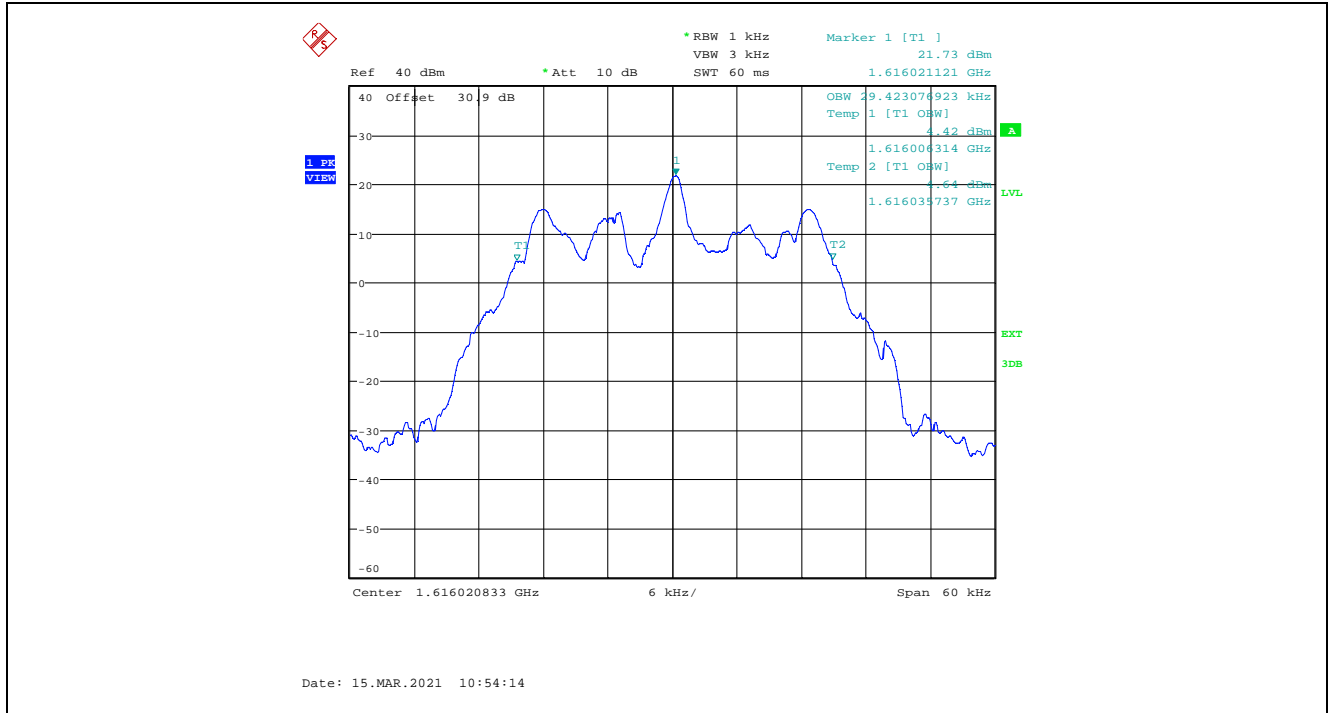

Plot 5.2.4.1.2. 99% Occupied Bandwidth, Ch 1, 1616.020833 MHz (Output Bandwidth)

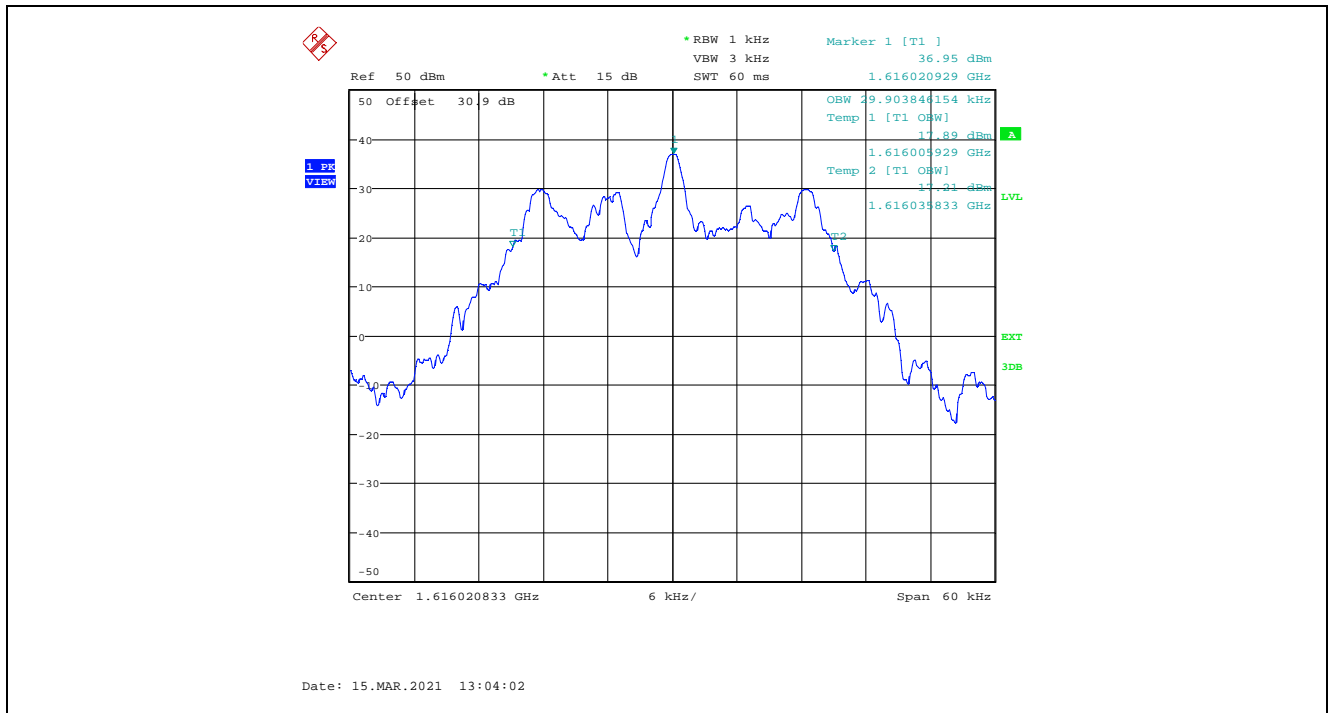

Plot 5.2.4.1.3. 99% Occupied Bandwidth, Ch 121, 1621.020825 MHz (Input Bandwidth)

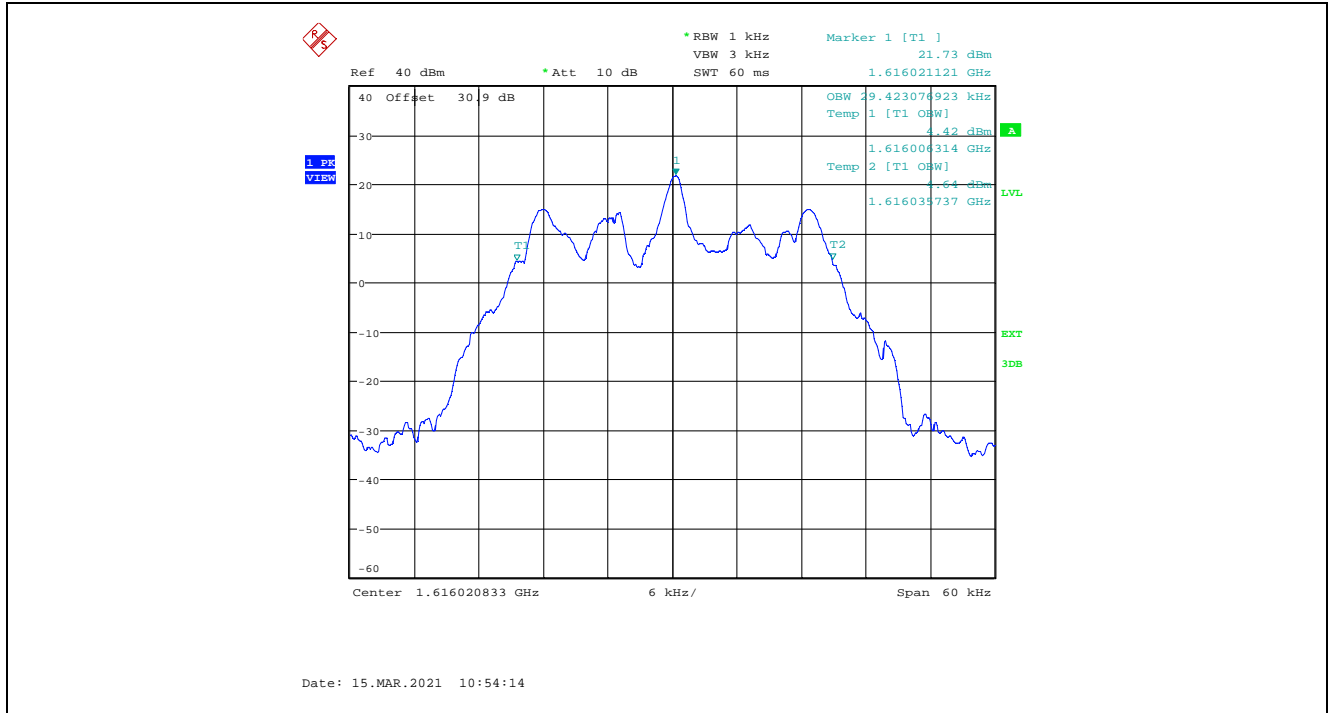

Plot 5.2.4.1.4. 99% Occupied Bandwidth, Ch 121, 1621.020825 MHz (Output Bandwidth)

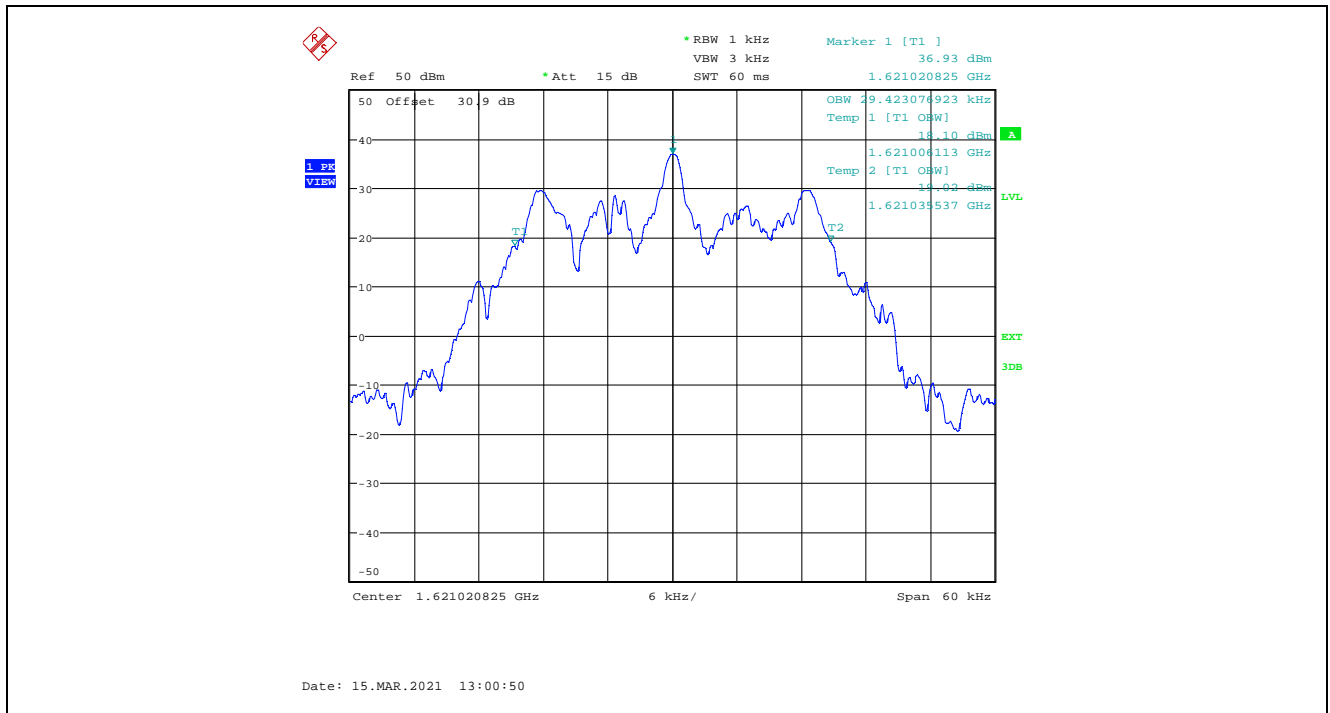

Plot 5.2.4.1.5. 99% Occupied Bandwidth, Ch 240, 1625.979151 MHz (Input Bandwidth)

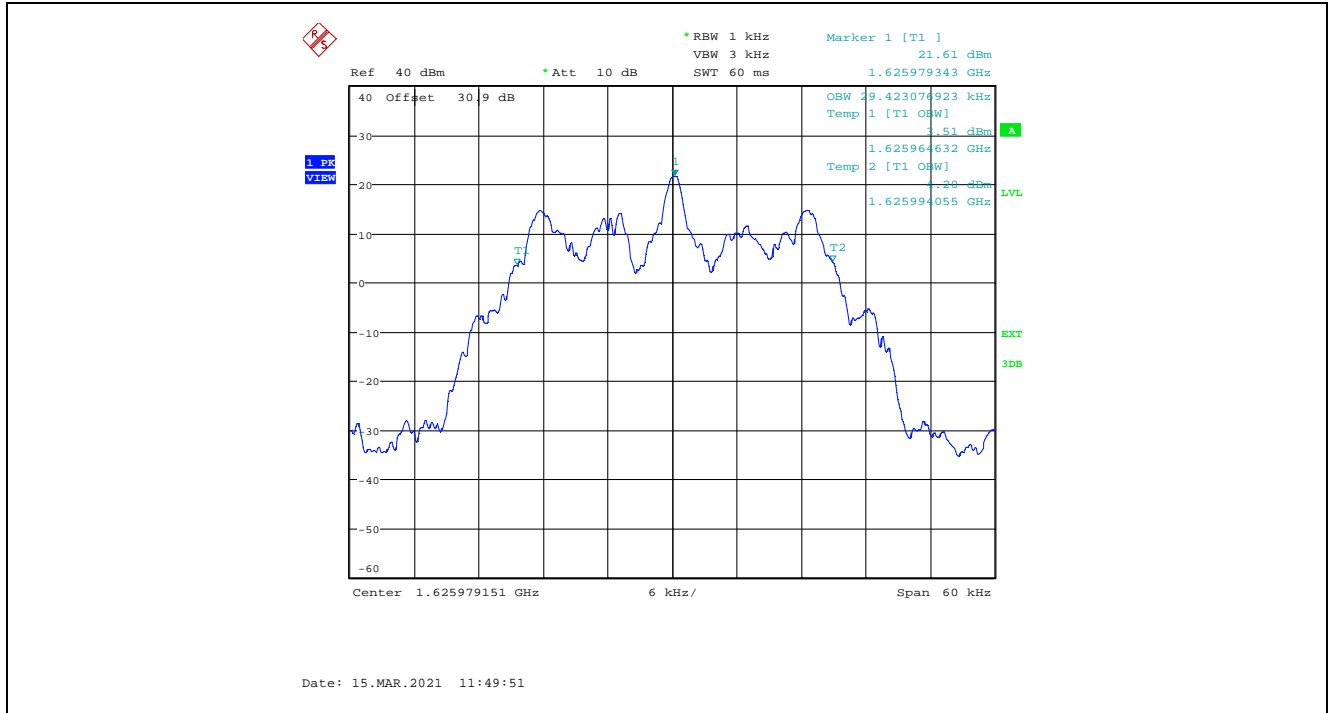

Plot 5.2.4.1.6. 99% Occupied Bandwidth, Ch 240, 1625.979151 MHz (Output Bandwidth)

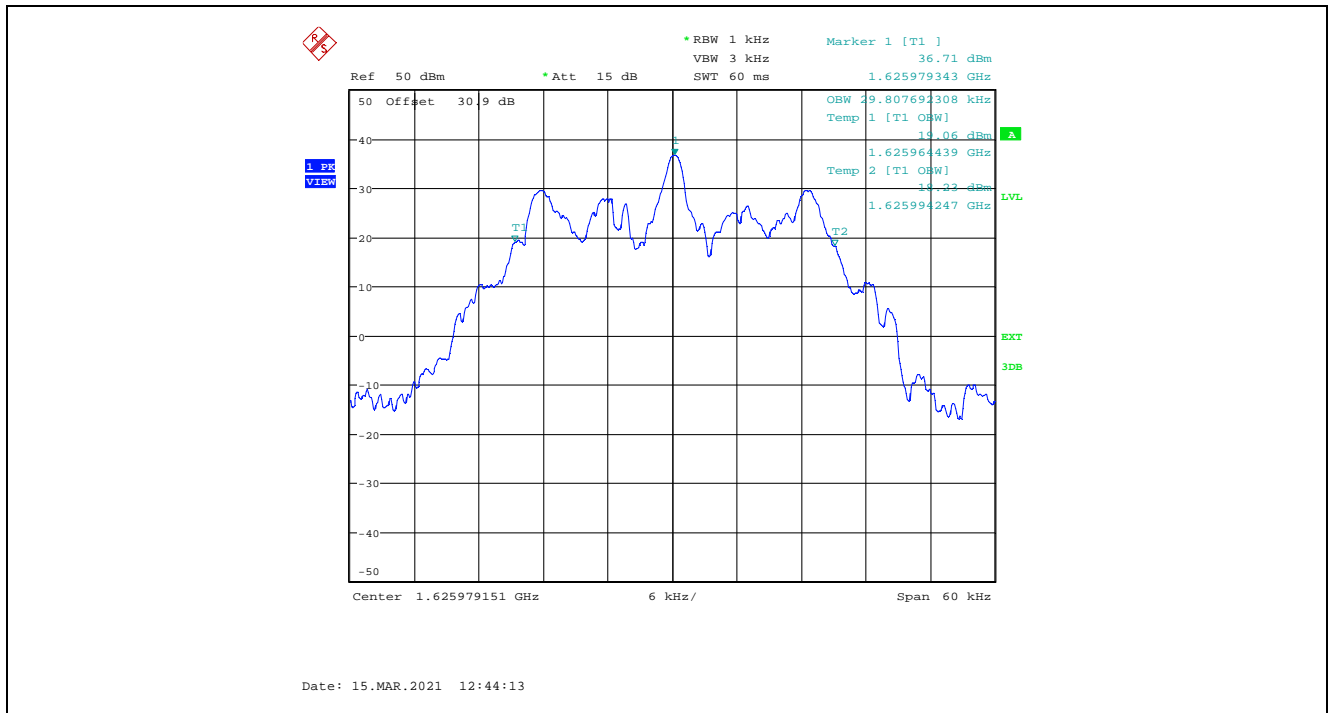

5.2.4.2. Emission Limitations

Plot 5.2.4.2.1. Emissions Limitation, Ch 1, 1616.020833 MHz (Input Signal)

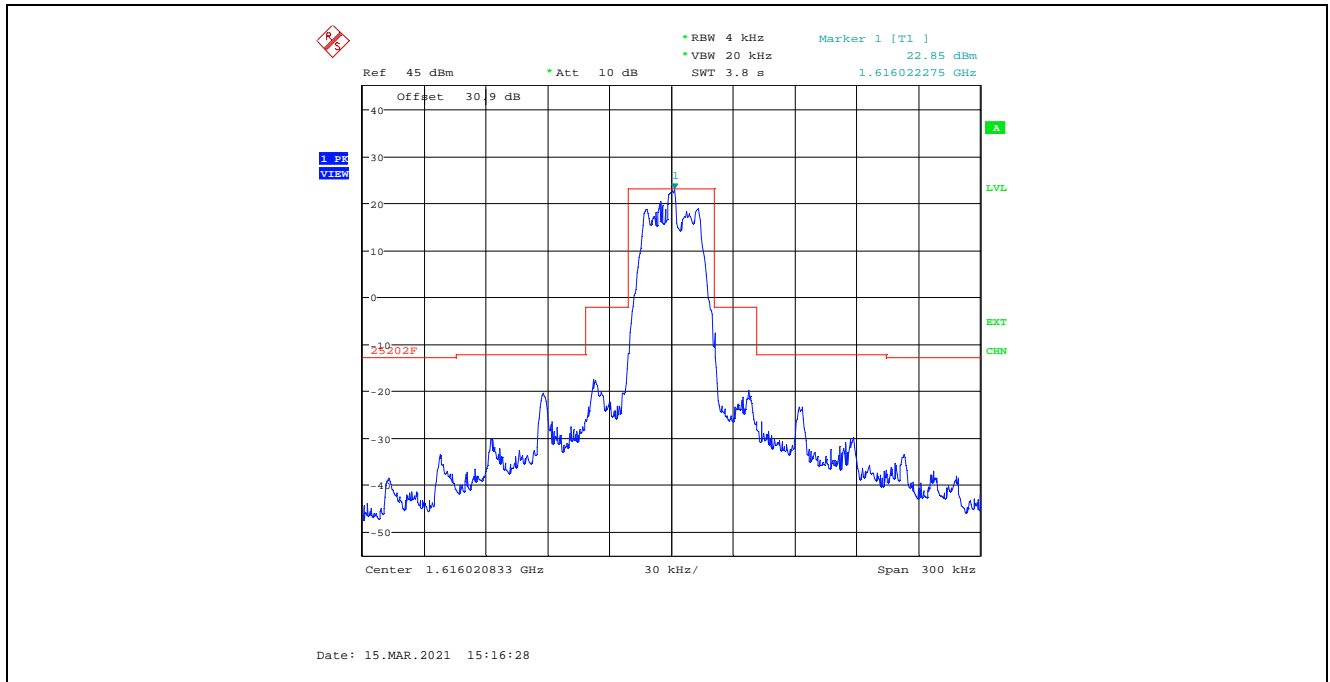

Plot 5.2.4.2.2. Emissions Limitation, Ch 1, 1616.020833 MHz (Output Signal)

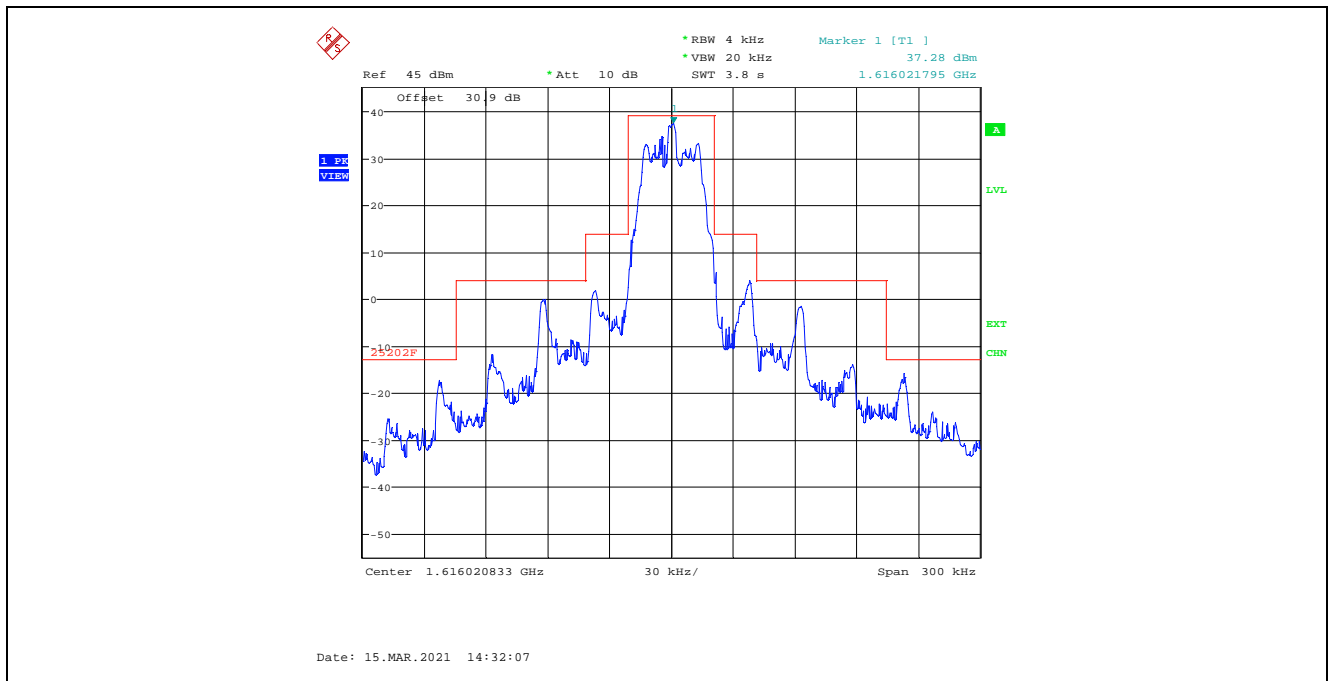

Plot 5.2.4.2.3. Emissions Limitation, Ch 121, 1621.020825 MHz, (Input Signal)

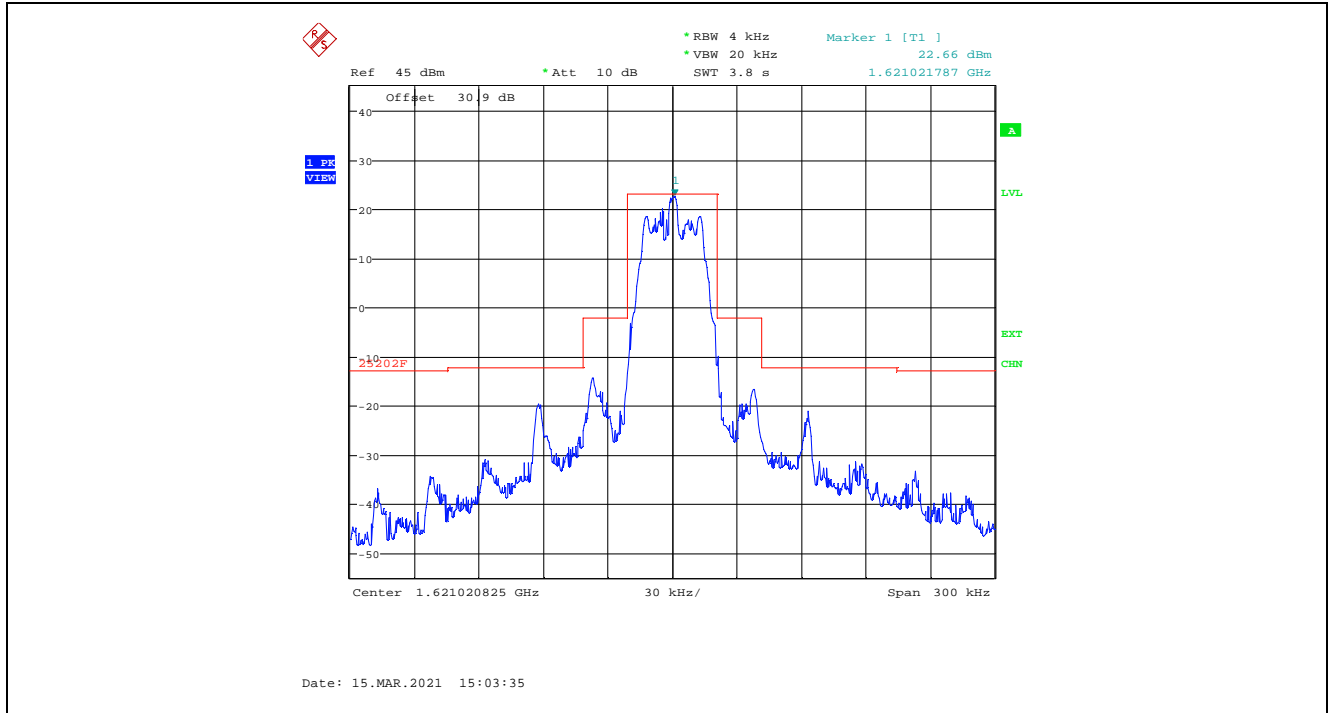

Plot 5.2.4.2.4. Emissions Limitation, Ch 121, 1621.020825 MHz, (Output Signal)

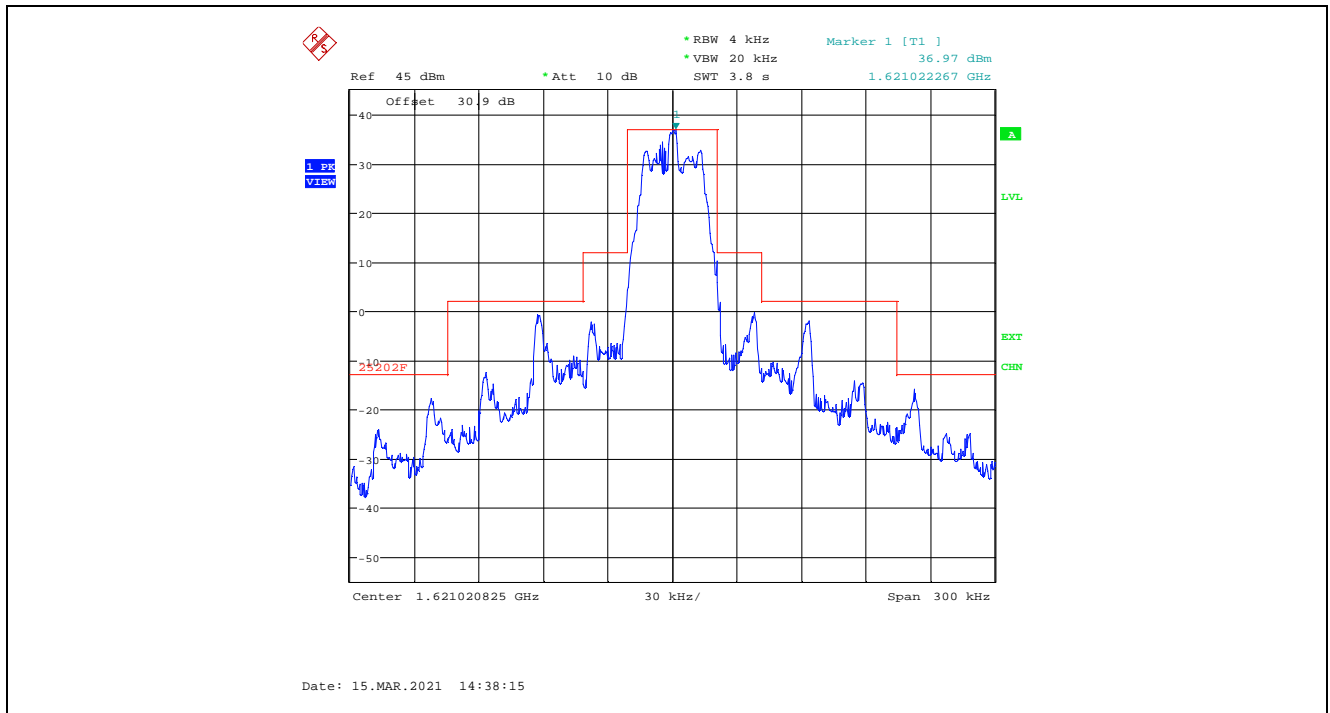

Plot 5.2.4.2.5. Emissions Limitation, Ch 240, 1625.979151 MHz (Input Signal)

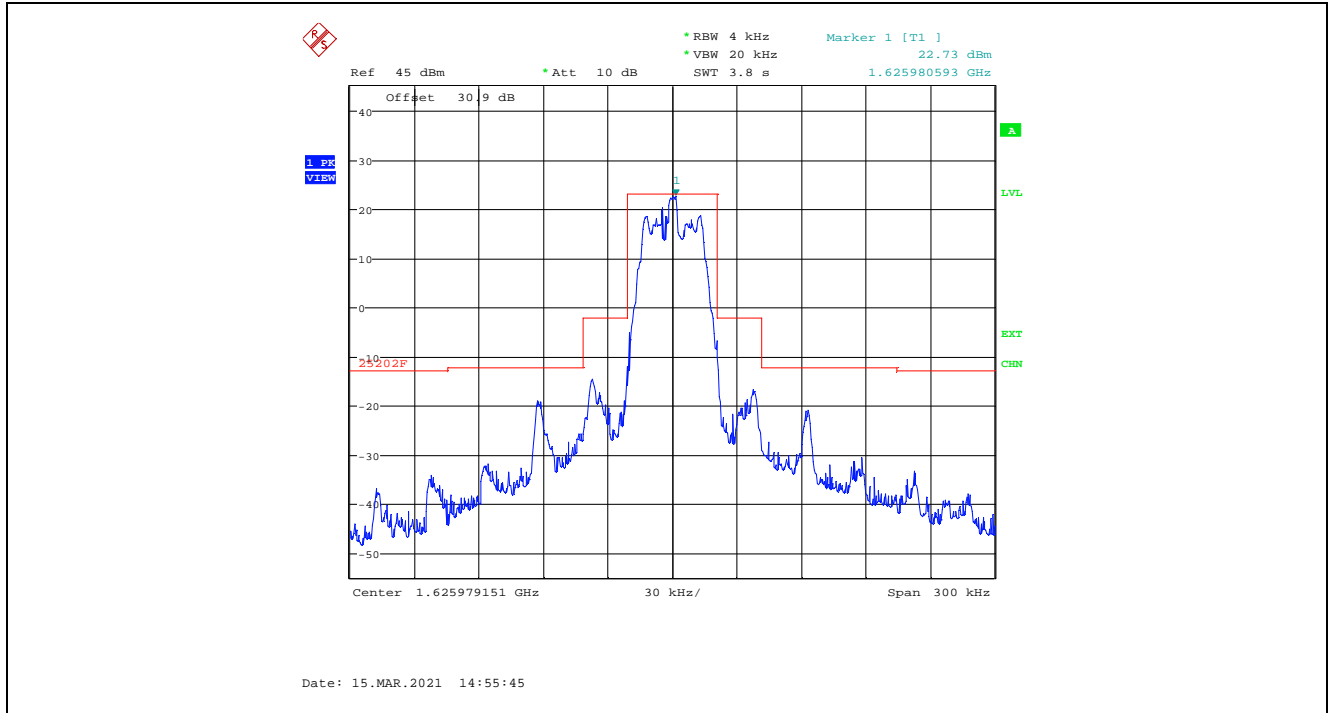

Plot 5.2.4.2.6. Emissions Limitation, Ch 240, 1625.979151 MHz (Output Signal)

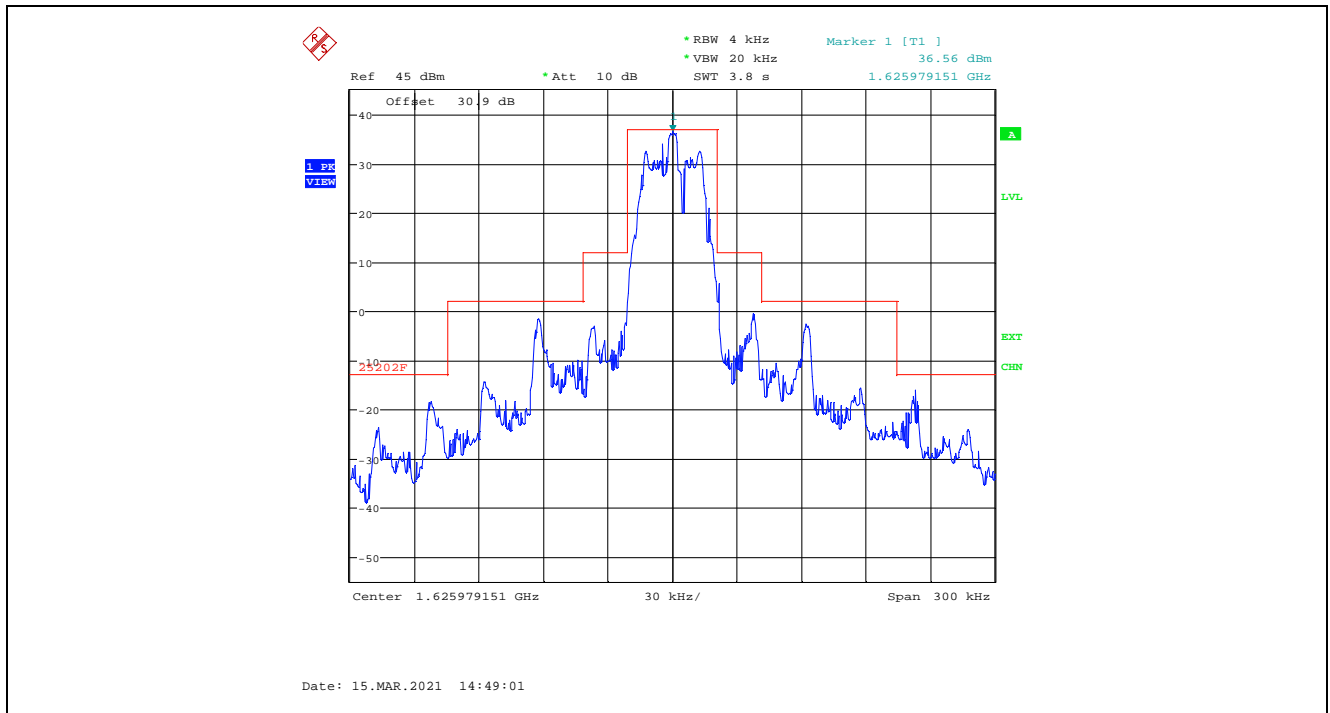

5.3. TRANSMITTER SPURIOUS EMISSIONS AT ANTENNA TERMINALS [§§ 2.1053, 25.202 & 25.216]

5.3.1. Limits

§25.202 (f)(3) In any 4 kHz band, the center frequency of which is removed from the assigned frequency by more than 250 percent of the authorized bandwidth: An amount equal to 43 dB plus 10 times the logarithm (to the base 10) of the transmitter power in watts.

§25.216(c) The e.i.r.p. density of emissions from mobile earth stations placed in service after July 21, 2002 with assigned uplink frequencies between 1610 MHz and 1660.5 MHz shall not exceed -70 dBW/MHz, averaged over any 2 millisecond active transmission interval, in the band 1559-1605 MHz. The e.i.r.p. of discrete emissions of less than 700 Hz bandwidth from such stations shall not exceed -80 dBW, averaged over any 2 millisecond active transmission interval, in the 1559-1605 MHz band.

§25.216(f) Mobile earth stations placed in service after July 21, 2002 with assigned uplink frequencies in the 1610-1660.5 MHz band shall suppress the power density of emissions in the 1605-1610 MHz band to an extent determined by linear interpolation from -70 dBW/MHz at 1605 MHz to -10 dBW/MHz at 1610 MHz.

§25.216(g) Mobile earth stations manufactured more than six months after FEDERAL REGISTER publication of the rule changes adopted in FCC 03-283 with assigned uplink frequencies in the 1610-1626.5 MHz band shall suppress the power density of emissions in the 1605-1610 MHz band-segment to an extent determined by linear interpolation from -70 dBW/MHz at 1605 MHz to -10 dBW/MHz at 1610 MHz averaged over any 2 millisecond active transmission interval. The e.i.r.p of discrete emissions of less than 700 Hz bandwidth from such stations shall not exceed a level determined by linear interpolation from -80 dBW at 1605 MHz to -20 dBW at 1610 MHz, averaged over any 2 millisecond active transmission interval.

Summary of §25.216 (c), (f) & (g) Limits				
Frequency (MHz)	Limit (dBW/MHz)	Limit (dBW) discrete emissions	Limit (dBm/MHz)	Limit (dBm) discrete emissions
1559-1605	-70	-80	-40	-50
1605-1610	-70 to -10		-40 to 20	
1605-1610	-70 to -10	-80 to -20	-40 to 20	-50 to 10

5.3.2. Method of Measurements

ANSI C63.26 Section 5.7.

5.3.3. Test Arrangement

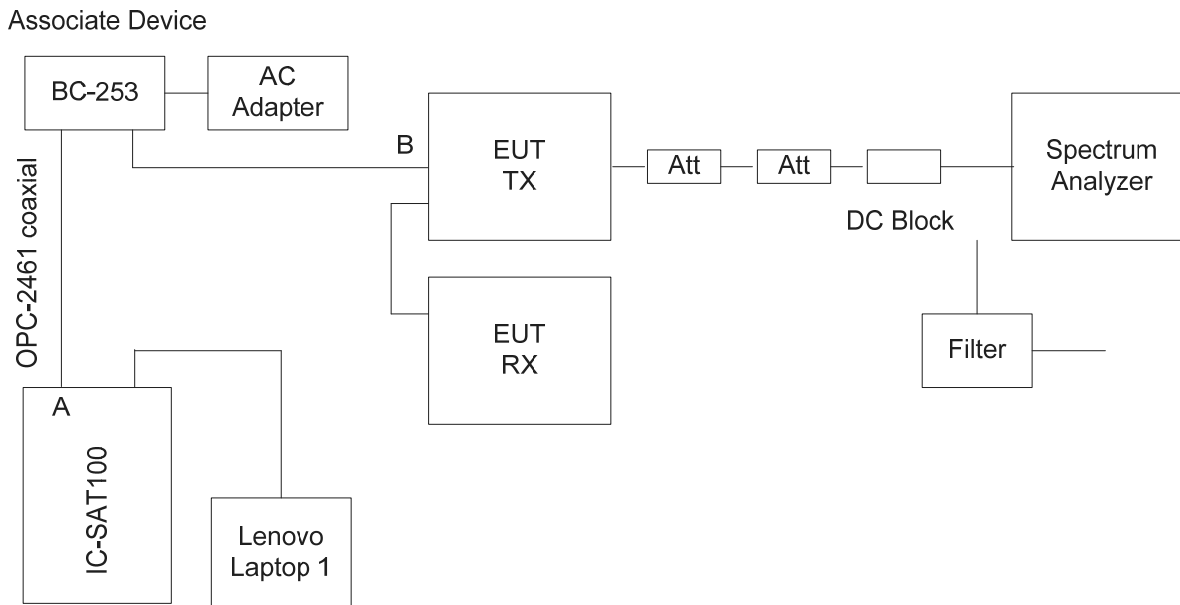

Associate Device

Output of SAT100 is around 36.23dBm (at A)

Cable assembly loss included BC-253 box is 12.81dB (from A to B)

5.3.4. Test Data

Remark: No discrete emissions detected in 1559 -1610 MHz band.

Plot 5.3.4.1. Transmitter Spurious Emissions at Antenna Terminal, Ch 1, 1616.020833 MHz
30 MHz – 1.559 GHz

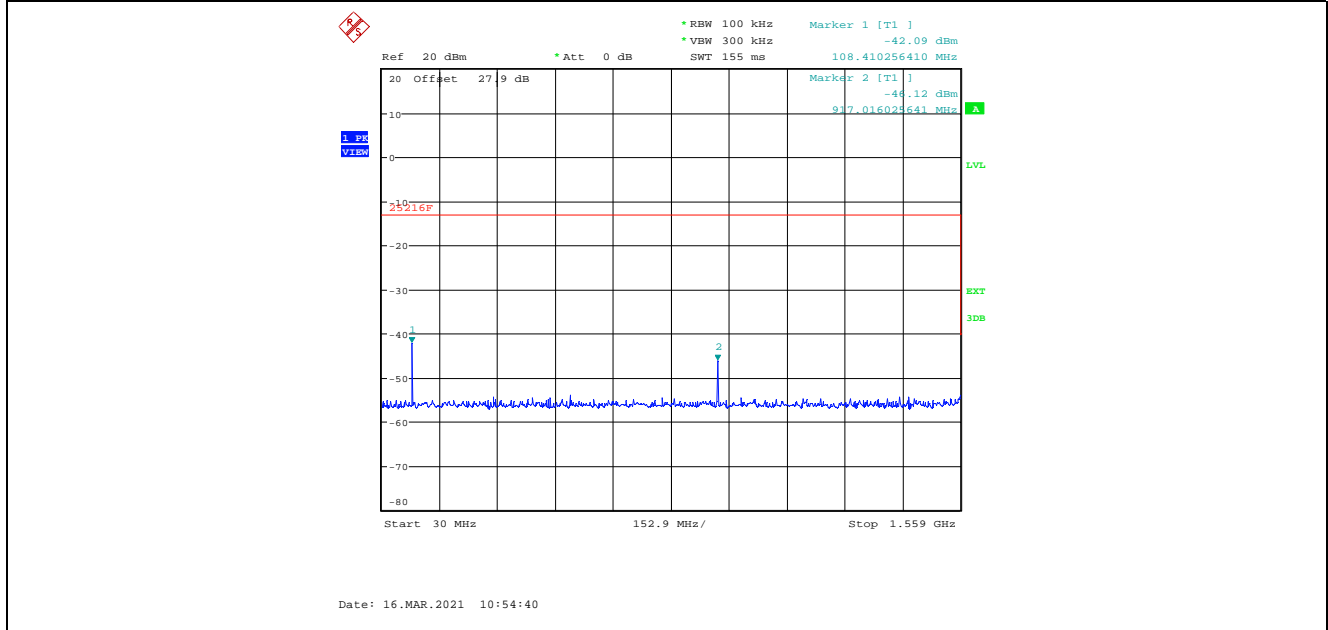

Plot 5.3.4.2. Transmitter Spurious Emissions at Antenna Terminal, Ch 1, 1616.020833 MHz
1.559 GHz – 1.605 GHz

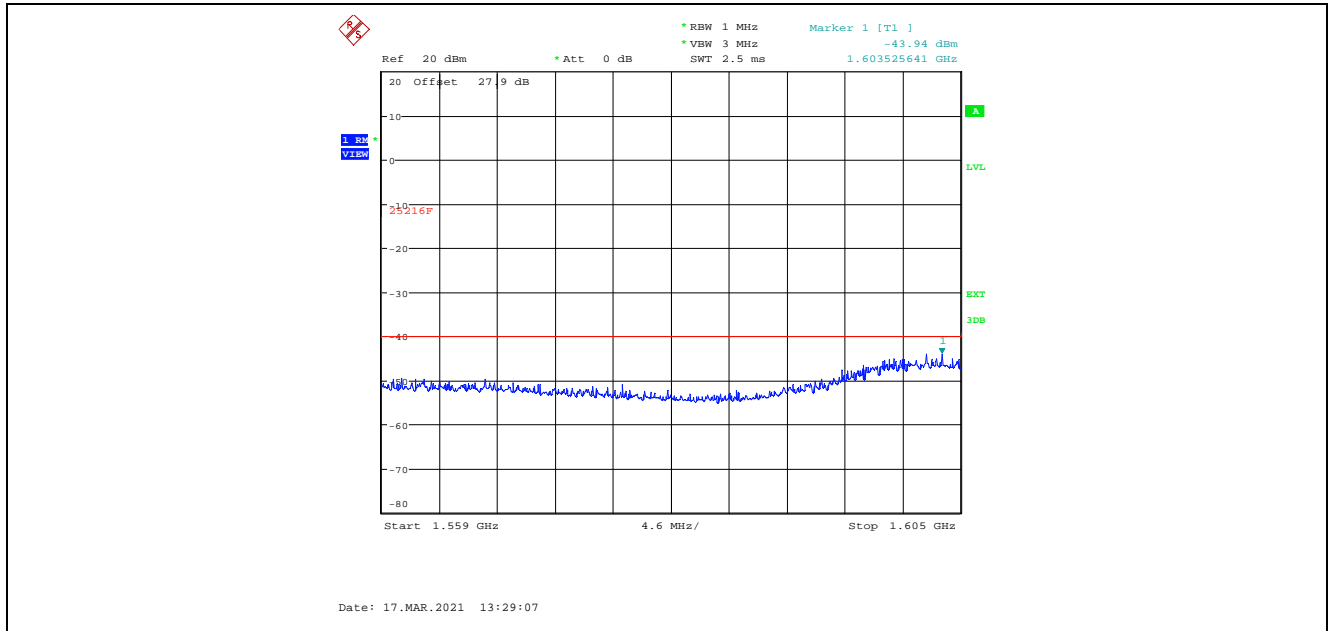

Plot 5.3.4.3. Transmitter Spurious Emissions at Antenna Terminal, Ch 1, 1616.020833 MHz
1.605 GHz – 1.61 GHz

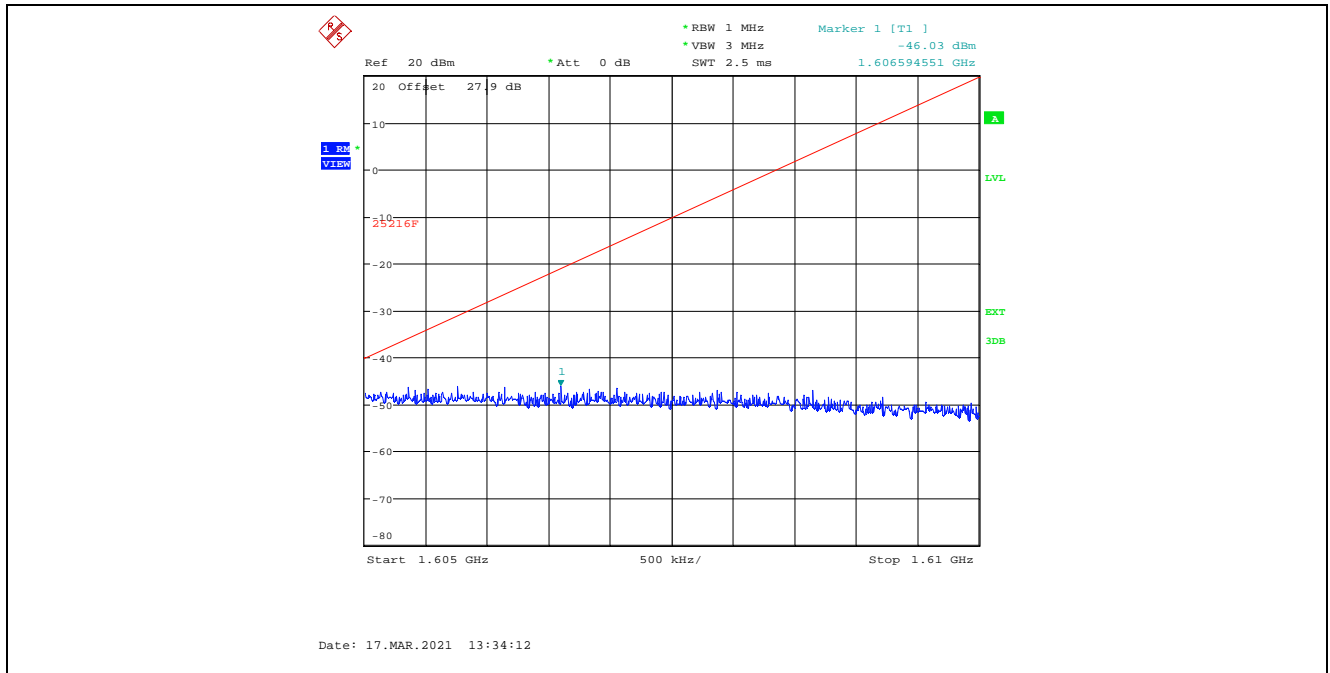

Plot 5.3.4.4. Transmitter Spurious Emissions at Antenna Terminal, Ch 1, 1616.020833 MHz
1.6255 GHz – 16.3 GHz

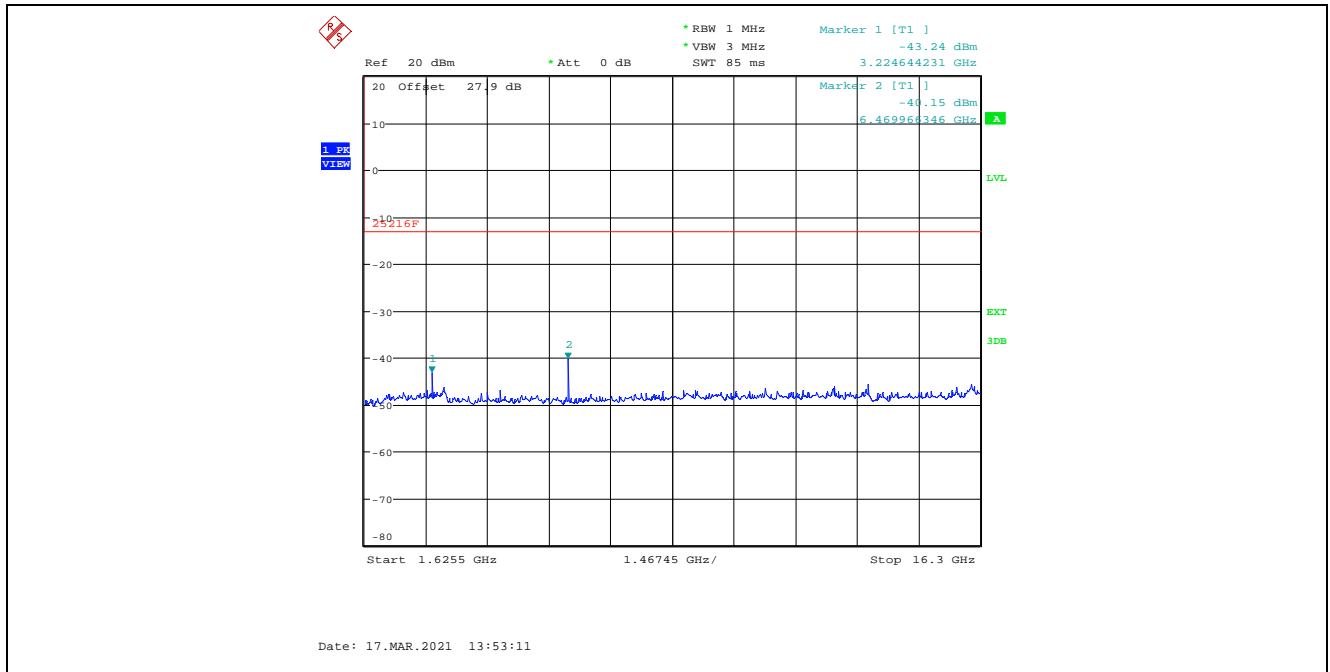

Plot 5.3.4.5. Transmitter Spurious Emissions at Antenna Terminal, Ch 121 1621.020825 MHz
30 MHz – 1.559 GHz

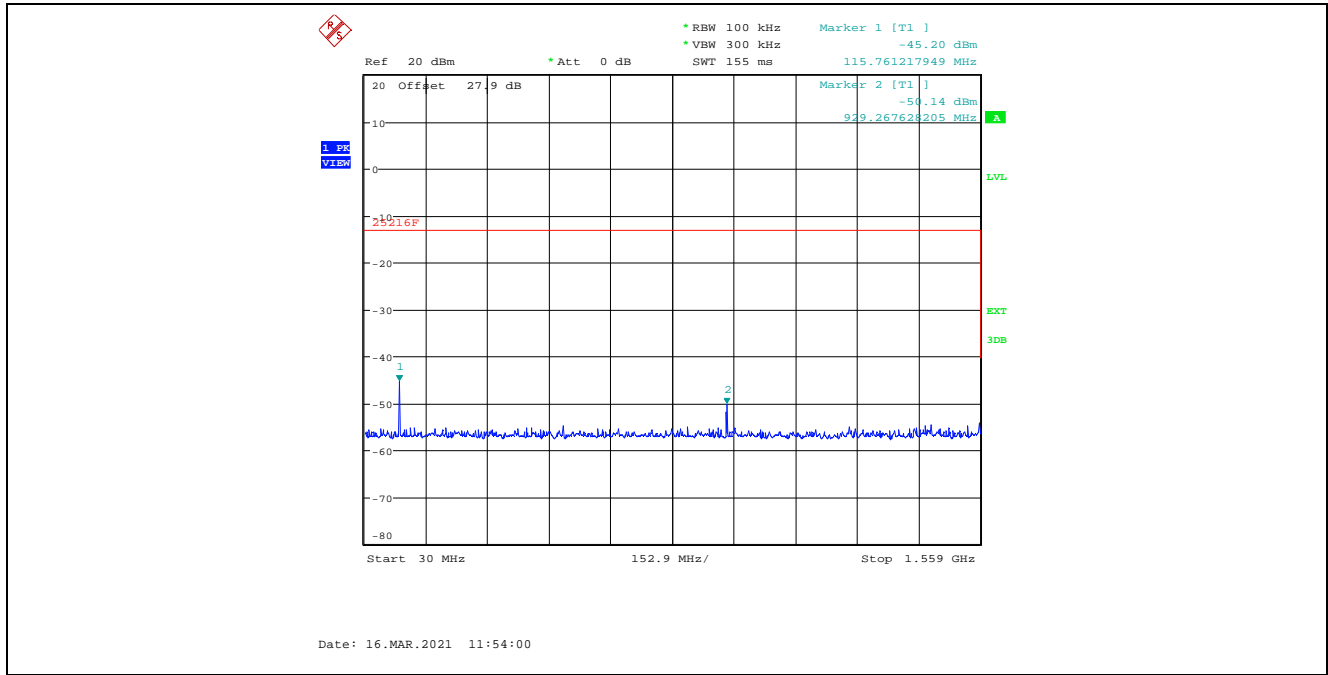

Plot 5.3.4.6. Transmitter Spurious Emissions at Antenna Terminal, Ch 121 1621.020825 MHz
1.559 GHz – 1.605 GHz

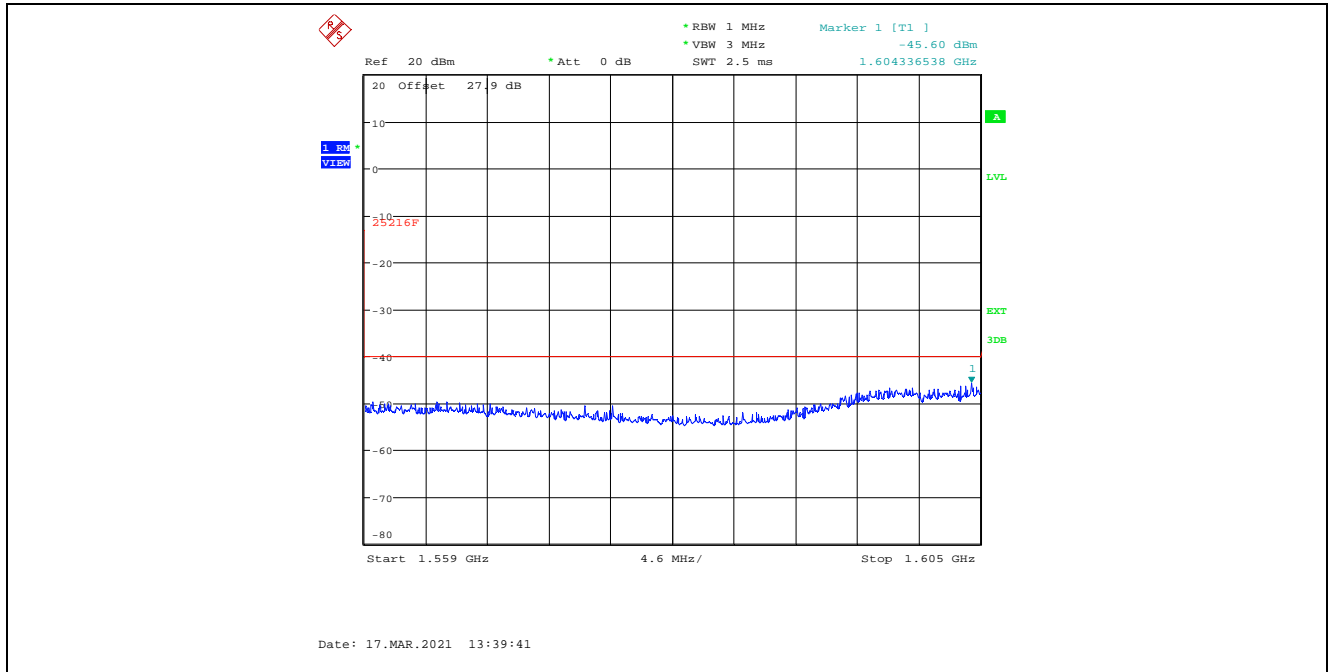

Plot 5.3.4.7. Transmitter Spurious Emissions at Antenna Terminal, Ch 121 1621.020825 MHz
1.605 GHz – 1.61 GHz

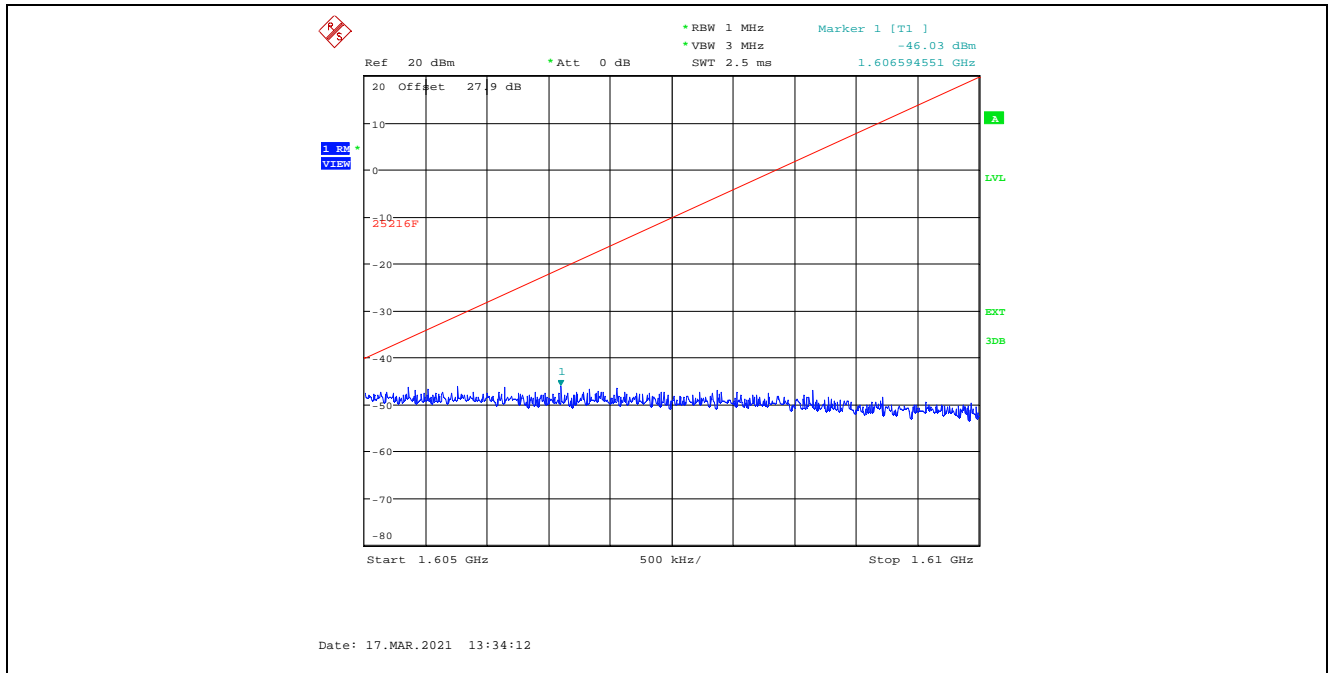

Plot 5.3.4.8. Transmitter Spurious Emissions at Antenna Terminal, Ch 121 1621.020825 MHz
1.6255 GHz – 16.3 GHz

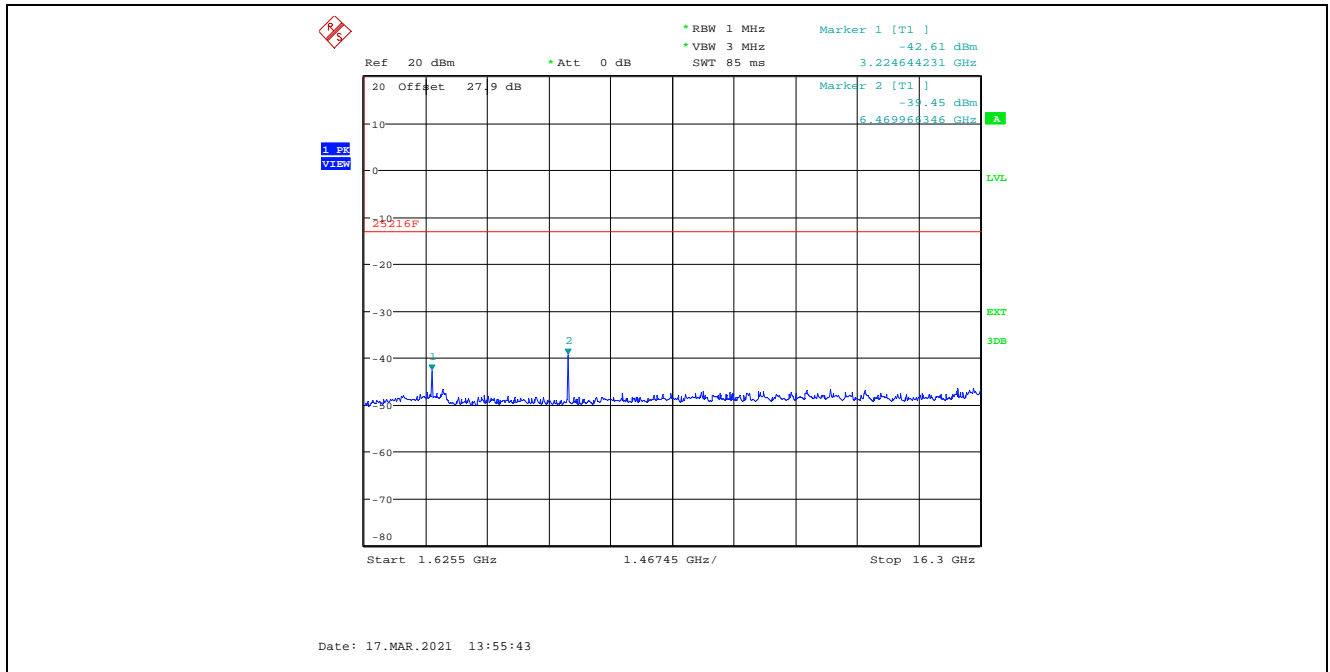

Plot 5.3.4.9. Transmitter Spurious Emissions at Antenna Terminal, Ch 240 1625.979151 MHz
30 MHz – 1.559 GHz

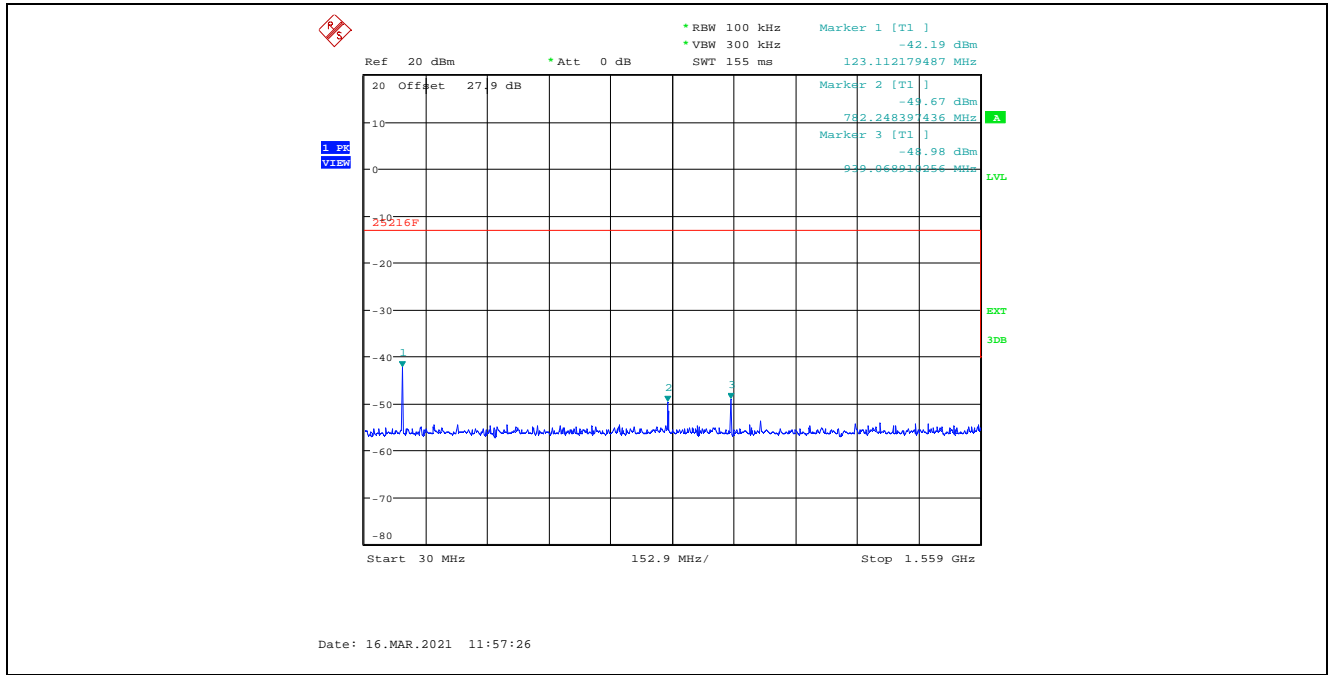

Plot 5.3.4.10. Transmitter Spurious Emissions at Antenna Terminal, Ch 240 1625.979151 MHz
1.559 GHz – 1.605 GHz

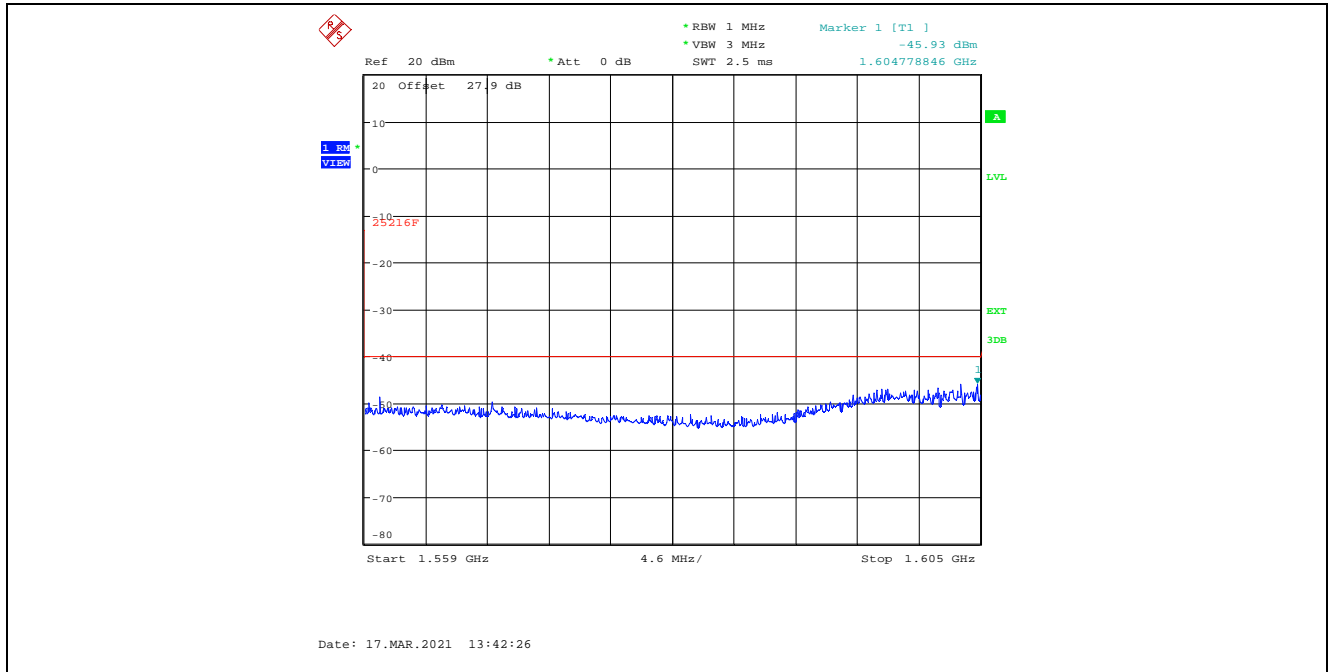

Plot 5.3.4.11. Transmitter Spurious Emissions at Antenna Terminal, Ch 240 1625.979151 MHz
1.605 GHz – 1.61 GHz

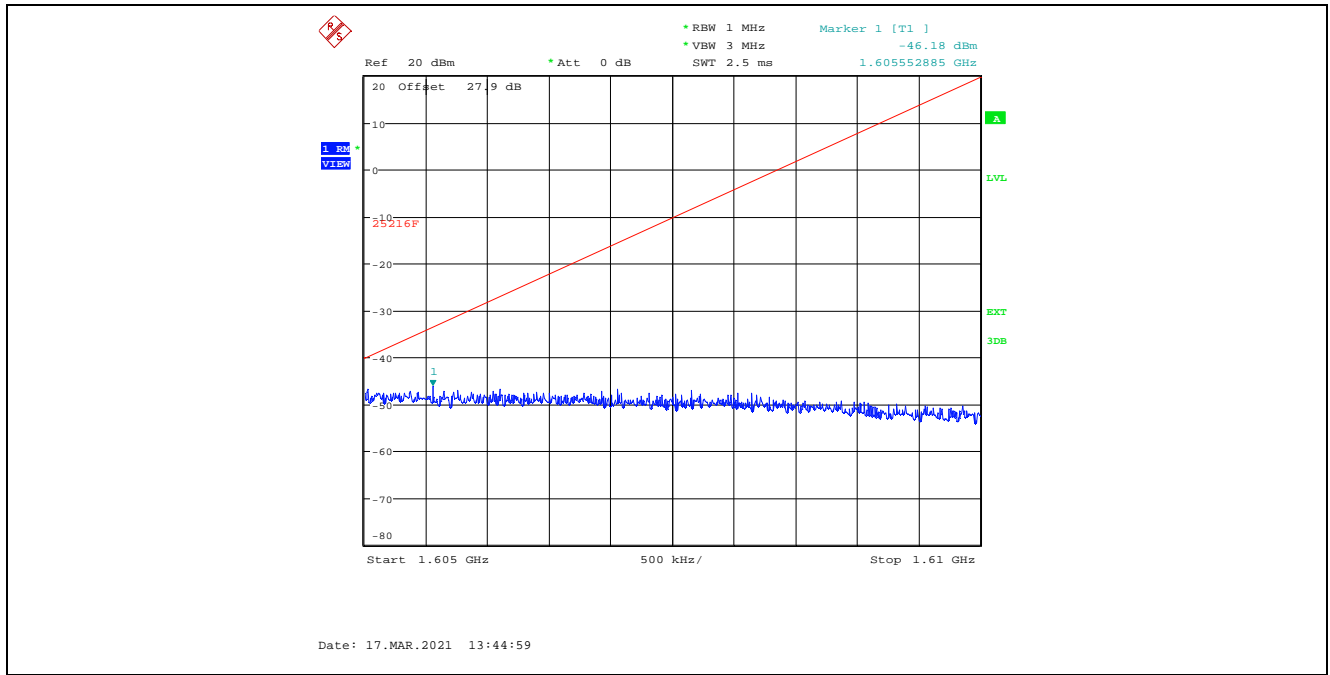

Plot 5.3.4.12. Transmitter Spurious Emissions at Antenna Terminal, Ch 240 1625.979151 MHz
1.6255 GHz – 16.3 GHz

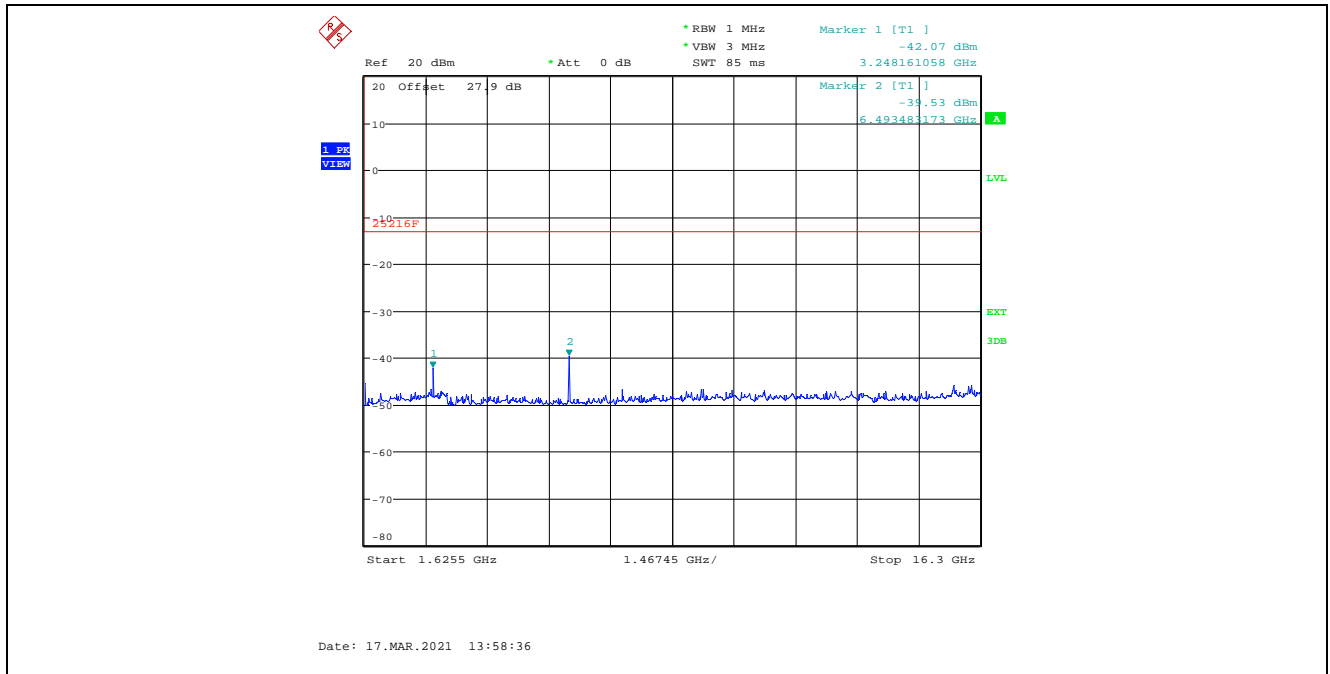

5.4. TRANSMITTER SPURIOUS/HARMONIC RADIATED EMISSIONS [§§ 2.1053 25.202 & 25.216]

5.4.1. Limits

§25.202 (f)(3) In any 4 kHz band, the center frequency of which is removed from the assigned frequency by more than 250 percent of the authorized bandwidth: An amount equal to 43 dB plus 10 times the logarithm (to the base 10) of the transmitter power in watts.

§25.216(c) The e.i.r.p. density of emissions from mobile earth stations placed in service after July 21, 2002 with assigned uplink frequencies between 1610 MHz and 1660.5 MHz shall not exceed -70 dBW/MHz, averaged over any 2 millisecond active transmission interval, in the band 1559-1605 MHz. The e.i.r.p. of discrete emissions of less than 700 Hz bandwidth from such stations shall not exceed -80 dBW, averaged over any 2 millisecond active transmission interval, in the 1559-1605 MHz band.

§25.216(f) Mobile earth stations placed in service after July 21, 2002 with assigned uplink frequencies in the 1610-1660.5 MHz band shall suppress the power density of emissions in the 1605-1610 MHz band to an extent determined by linear interpolation from -70 dBW/MHz at 1605 MHz to -10 dBW/MHz at 1610 MHz.

§25.216(g) Mobile earth stations manufactured more than six months after FEDERAL REGISTER publication of the rule changes adopted in FCC 03-283 with assigned uplink frequencies in the 1610-1626.5 MHz band shall suppress the power density of emissions in the 1605-1610 MHz band-segment to an extent determined by linear interpolation from -70 dBW/MHz at 1605 MHz to -10 dBW/MHz at 1610 MHz averaged over any 2 millisecond active transmission interval. The e.i.r.p of discrete emissions of less than 700 Hz bandwidth from such stations shall not exceed a level determined by linear interpolation from -80 dBW at 1605 MHz to -20 dBW at 1610 MHz, averaged over any 2 millisecond active transmission interval.

Summary of §25.216 (c), (f) & (g) Limits				
Frequency (MHz)	Limit (dBW/MHz)	Limit (dBW) discrete emissions	Limit (dBm/MHz)	Limit (dBm) discrete emissions
1559-1605	-70	-80	-40	-50
1605-1610	-70 to -10		-40 to 20	
1605-1610	-70 to -10	-80 to -20	-40 to 20	-50 to 10

5.4.2. Method of Measurements

ANSI C63.26 Section 5.5.

5.4.3. Test Arrangement

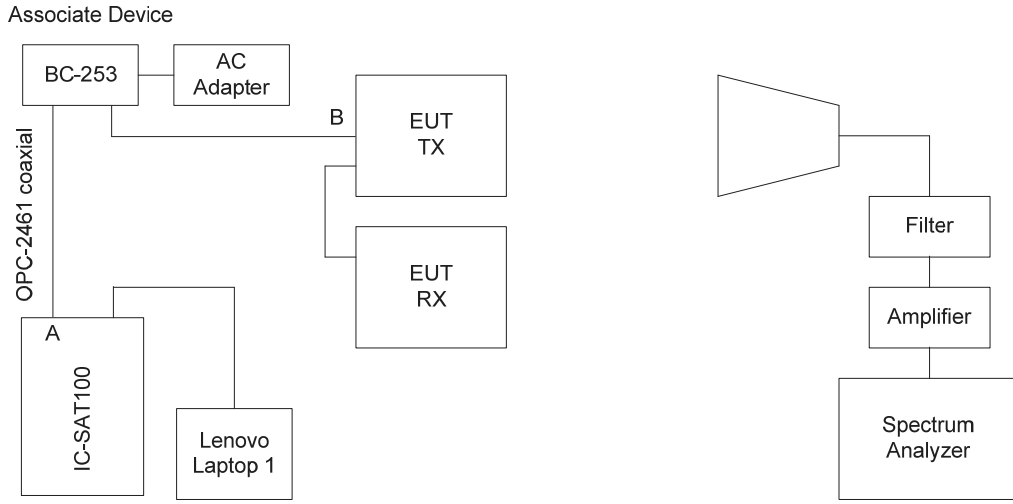

Associate Device

Output of SAT100 is around 36.23dBm (at A)
 Cable assembly loss included BC-253 box is 12.81dB (from A to B)

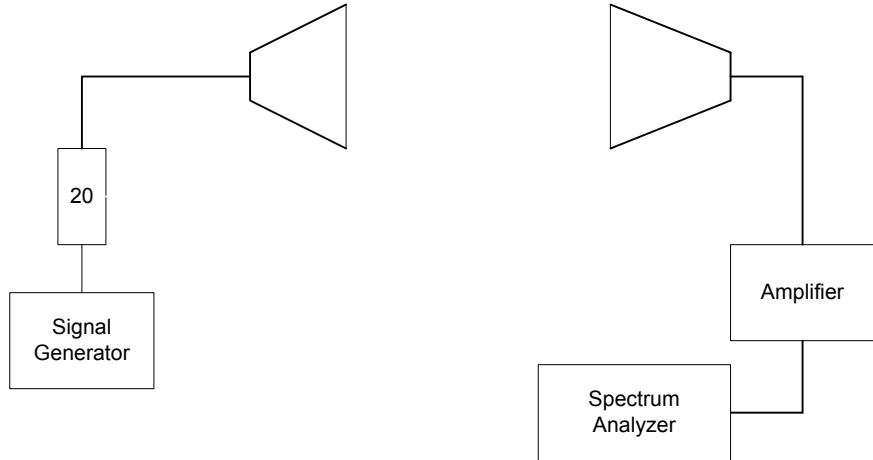

5.4.4. Test Data

Remark(s):

- No discrete emissions detected in 1559 -1610 MHz band.
- The emissions were scanned from 30 MHz to 16.3 GHz; all spurious emissions that are in excess of 20dB below the specified limit shall be recorded.

Carrier Frequency:		1616.020833 MHz						
Limit:		-13 dBm						
Frequency (MHz)	E-Field (dBµV/m)	EMI Detector (Peak/QP/Avg)	Antenna Polarization (V/H)	Power from Signal Gen. (dBm)	Subs. Horn Ant. Gain (dBi)	EIRP (dBm)	Limit (dBm)	Margin (dB)
3232.041666	78.26	Peak	V	-28.64	7.3	-21.34	-13	-8.34
4848.062499	68.57	Peak	H	-40.20	8.7	-31.50	-13	-18.50
6464.083332	73.11	Peak	V	-37.35	9.4	-27.95	-13	-14.95
6464.083332	70.85	Peak	H	-38.97	9.4	-29.57	-13	-16.57
8080.104165	70.07	Peak	V	-40.21	9.0	-31.21	-13	-18.21

Carrier Frequency:		1621.020825 MHz						
Limit:		-13 dBm						
Frequency (MHz)	E-Field (dBµV/m)	EMI Detector (Peak/QP/Avg)	Antenna Polarization (V/H)	Power from Signal Gen. (dBm)	Subs. Horn Ant. Gain (dBi)	EIRP (dBm)	Limit (dBm)	Margin (dB)
3242.041650	75.88	Peak	V	-31.02	7.3	-23.72	-13	-10.72
4863.062475	68.08	Peak	H	-40.69	8.7	-31.99	-13	-18.99
6484.083300	72.91	Peak	V	-37.55	9.4	-28.15	-13	-15.15
6484.083300	71.07	Peak	H	-38.75	9.4	-29.35	-13	-16.35
8105.104125	69.02	Peak	V	-41.26	9.0	-32.26	-13	-19.26

Carrier Frequency:		1625.979151 MHz						
Limit:		-13 dBm						
Frequency (MHz)	E-Field (dBµV/m)	EMI Detector (Peak/QP/Avg)	Antenna Polarization (V/H)	Power from Signal Gen. (dBm)	Subs. Horn Ant. Gain (dBi)	EIRP (dBm)	Limit (dBm)	Margin (dB)
3251.958302	74.64	Peak	V	-32.26	7.3	-24.96	-13	-11.96
4877.937453	69.74	Peak	V	-39.86	8.7	-31.16	-13	-18.16
4877.937453	71.39	Peak	H	-37.38	8.7	-28.68	-13	-15.68
6503.916604	73.85	Peak	V	-36.61	9.4	-27.21	-13	-14.21
6503.916604	75.55	Peak	H	-34.27	9.4	-24.87	-13	-11.87
8129.895755	70.67	Peak	V	-39.61	9.0	-30.61	-13	-17.61
8129.895755	69.02	Peak	H	-40.30	9.0	-31.30	-13	-18.30
9755.874906	71.99	Peak	H	-41.12	9.5	-31.62	-13	-18.62
11381.854057	69.23	Peak	H	-41.46	10.3	-31.16	-13	-18.16

ULTRATECH GROUP OF LABS

3000 Bristol Circle, Oakville, Ontario, Canada L6H 6G4
 Tel. #: 905-829-1570, Fax. #: 905-829-8050, Email: vic@ultratech-labs.com, Website: <http://www.ultratech-labs.com>

File #: 211COM534_FCC25
 March 26, 2021

All test results contained in this engineering test report are traceable to National Institute of Standards and Technology (NIST)

5.5. EXPOSURE OF HUMANS TO RF FIELD [[§§ 1.1310 & 2.1091]

§ 1.1310: The criteria listed in the following table shall be used to evaluate the environmental impact of human exposure to radio-frequency (RF) radiation as specified in 1.1307(b).

Limits for Maximum Permissible Exposure (MPE)

Frequency range (MHz)	Electric field strength (V/m)	Magnetic field strength (A/m)	Power density (mW/cm ²)	Averaging time (minutes)
(A) Limits for Occupational/Controlled Exposures				
0.3-3.0	614	1.63	*(100)	6
3.0-30	1842/f	4.89/f	*(900/f ²)	6
30-300	61.4	0.163	1.0	6
300-1500			f/300	6
1500-100,000			5	6
(B) Limits for General Population/Uncontrolled Exposure				
0.3-1.34	614	1.63	*(100)	30
1.34-30	824/f	2.19/f	*(180/f ²)	30
30-300	27.5	0.073	0.2	30
300-1500			f/1500	30
1500-100,000			1.0	30

f = frequency in MHz

* = Plane-wave equivalent power density

Note 1: Occupational/controlled limits apply in situations in which persons are exposed as a consequence of their employment provided those persons are fully aware of the potential for exposure and can exercise control over their exposure. Limits for occupational/controlled exposure also apply in situations when an individual is transient through a location where occupational/controlled limits apply provided he or she is made aware of the potential for exposure.

Note 2: General population/uncontrolled exposures apply in situations in which the general public may be exposed, or in which persons that are exposed as a consequence of their employment may not be fully aware of the potential for exposure or can not exercise control over their exposure.

5.5.1. Method of Measurements

Calculation Method of Power Density/RF Safety Distance:

$$S = \frac{PG}{4\pi \cdot r^2} = \frac{EIRP}{4\pi \cdot r^2} \text{ or } r = \sqrt{\frac{P \cdot G}{4 \cdot \pi \cdot S}} = \sqrt{\frac{EIRP}{4 \cdot \pi \cdot S}}$$

Where,
P: power input to the antenna in mW
EIRP: Equivalent (effective) isotropic radiated power.
S: power density mW/cm²
G: numeric gain of antenna relative to isotropic radiator
r: distance to centre of radiation in cm

5.5.2. RF Evaluation

Frequency (MHz)	Max. Conducted Power (dBm)	Max. Antenna Gain (dBi)	EIRP (dBm)	EIRP (mW)	Evaluation Distance, r (cm)	Power Density, S (mW/cm ²)	MPE Limit (mW/cm ²)
1616.0	37.81	-3	34.81	3026.91	20	0.60	5

EXHIBIT 6. TEST EQUIPMENT LIST

Test Instruments	Manufacturer	Model No.	Serial No.	Frequency Range	Cal. Due Date
Peak Power Analyzer	Hewlett Packard	8991A	3342A00657	0.5 - 40 GHz	12 Sep 2021
Peak Power Sensor	Hewlett Packard	84814A	3205A00175	0.5 - 40 GHz	12 Sep 2021
Attenuator 1	Weinschel Corp	24-20-34	BH0740	DC - 8.5 GHz	See Note 1
Attenuator 2	Weinschel Corp	24-10-34	BJ8386	DC – 8.5 GHz	See Note 1
Switch-Mode Power Supply	Jet Icom Inc.	BC-228 6A-601DA15	---	100-240VAC to 15VDC 4A	See Note 1
DC Block	Hewlett Packard	11742A	12460	0.045 – 26.5 GHz	See Note 1
Laptop EMC1	Lenovo	ThinkPad Edge 0578	IS057882ULRBXKBG	---	See Note 1
Spectrum Analyzer	Rohde & Schwarz	FSU26	200946	20Hz–26.5 GHz	25 Jan 2022
High Pass Filter	K & L	11SH10- 3000/T18000	4	Cut off 1.6 GHz	See Note 1
Tunable Notch Filter	K & L	3TNF- 1000/2000	34	1 – 2 GHz	See Note 1
EMI Receiver	Rohde & Schwarz	ESU40	100037	20Hz–40 GHz	18 Sep 2021
RF Amplifier	Com-Power	PAM-0118A	551052	0.5 – 18 GHz	29 Jul 2021
RF Amplifier	Hewlett Packard	84498	3008A00769	1 – 26.5 GHz	4 Jan 2022
Biconilog Antenna	EMCO	3142C	34792	26-2000 MHz	16 May 2022
Horn Antenna	EMCO	3155	6570	1 – 18 GHz	11 Apr 2021
Horn Antenna	EMCO	3155	5955	1 – 18 GHz	12 Oct 2022
Attenuator	Pasternack	7024-20	6	DC–26.5 GHz	See Note 1
Signal Generator	Anritsu	68369B	970313	10MHz-40GHz	28 Sep 2021
Note 1: Internal Verification/Calibration check					

EXHIBIT 7. MEASUREMENT UNCERTAINTY

The measurement uncertainties stated were calculated in accordance with the requirements of CISPR 16-4-2 @ IEC:2003 and JCGM 100:2008 (GUM 1995) – Guide to the Expression of Uncertainty in Measurement.

Test Description	Expanded Uncertainty, K=2 for 95% Confidence Level
Conducted Power	± 0.62 dB
Occupied Bandwidth and Emission Limitation	± 0.20 Hz / ± 0.63 dB
Transmitter Spurious Conducted Emissions	± 0.72 dB
Transmitter Spurious Radiated Emissions	± 4.20 dB (30 MHz – 1 GHz)
	± 2.70 dB (1 – 18 GHz)