

# RF Exposure Lab

802 N. Twin Oaks Valley Road, Suite 105 • San Marcos, CA 92069 • U.S.A.

TEL (760) 471-2100 • FAX (760) 471-2121

<http://www.rfexposurelab.com>

## CERTIFICATE OF COMPLIANCE SAR EVALUATION

ICOM, Inc.  
1-1-32 Kamiminami Hirano-ku  
Osaka 547-0003  
Japan

Dates of Test: December 2-11, 2020  
Test Report Number: SAR.20201208  
Revision B

FCC ID:	AFJ417900
IC Certificate:	202D-417900
Model(s):	IP730D
HVIN:	417900-01
Test Sample:	Engineering Unit Same as Production
Serial No.:	Eng 1
Equipment Type:	Push-To-Talk Handheld Radio for Occupational Population Use
Classification:	Portable Transmitter Next to Face and Body
TX Frequency Range:	136 – 174 MHz, 699 – 716 MHz; 824 – 849 MHz; 1710 – 1755 MHz; 1850 – 1910 MHz; 2402 – 2480 MHz
Frequency Tolerance:	± 2.5 ppm
Maximum RF Output:	150 MHz (FM) – 36.99 dBm, 750 MHz (LTE) – 25.7 dBm, 835 MHz (WCDMA) – 25.0 dBm, 1750 MHz (LTE) – 25.7 dBm, 1900 MHz (WCDMA) – 25.0 dBm, 1900 MHz (LTE) -24.0 dBm, 2450 MHz (BT) – 4.0 dBm Conducted
Signal Modulation:	FM, QPSK, 16QAM, DSSS, GFSK
Body Worn:	MB-133, MB-136, MB-96F, MB-96FL, MB-96N, MB57L, LC-195
Audio Accessories:	HM-163MC, HM-184, HM-184H, HM-222, HM-222H, HM-236, HM-238MC, HM-245T, SP16-BW, SP-26, SP-27, SP-28, SP-29, SP-40, HS-94, HS-95, HS-97, VS-3, VS-4MC, VS-5MC, AD-135 FA-SC25V, FA-SC26VS, FA-SC27VS, FA-SC28V, FA-SC29V, FA-SC55V, FA-SC56VS, FA-SC57VS, FA-SC61VC and Internal Antenna For Cellular/BT
Antenna Type:	BP-302, BP-303, BP-305
Battery:	Certification
Application Type:	Part 2, 15, 22, 24, 27, 90
FCC Rule Parts:	KDB 447498 D01 v06, KDB 643646 D01 v01r03, KDB 941225 D05 v02r05, KDB 865664 D01 v01r04, KDB 865664 D02 v01r02
KDB Test Methodology:	RSS-102 Issue 5, Safety Code 6
Industry Canada:	0.43 W/kg for Face; 0.20 for Body Reported
Max. Stand Alone SAR Value:	0.39 W/kg Reported; 0.12 For Ratio Limit
Max. Simultaneous SAR Value:	25 mm for Face; 0 mm for Body
Separation Distance:	

This wireless mobile and/or portable device has been shown to be compliant for localized specific absorption rate (SAR) for controlled environment/occupational and uncontrolled environment/general population exposure limits specified in ANSI/IEEE Std. C95.1-1992 and had been tested in accordance with the measurement procedures specified in IEEE 1528-2013 and IEC 62209-2:2010 (See test report).

I attest to the accuracy of the data. All measurements were performed by myself or were made under my supervision and are correct to the best of my knowledge and belief. I assume full responsibility for the completeness of these measurements and vouch for the qualifications of all persons taking them.

RF Exposure Lab, LLC certifies that no party to this application has been denied FCC benefits pursuant to Section 5301 of the Anti-Drug Abuse Act of 1988, 21 U.S.C. 853(a).



Jay M. Moulton  
Vice President



Testing Cert. # 2387.01

## Table of Contents

1.	Introduction .....	4
	SAR Definition [5].....	5
2.	SAR Measurement Setup.....	6
	Robotic System.....	6
	System Hardware.....	6
	System Electronics.....	7
	Probe Measurement System.....	7
3.	Probe and Dipole Calibration.....	15
4.	Phantom & Simulating Tissue Specifications.....	16
	Head & Body Simulating Mixture Characterization .....	16
5.	ANSI/IEEE C95.1 – 1999 RF Exposure Limits [2].....	17
	Uncontrolled Environment .....	17
	Controlled Environment.....	17
6.	Measurement Uncertainty .....	18
7.	System Validation.....	19
	Tissue Verification.....	19
	Test System Verification.....	19
8.	LTE Document Checklist.....	20
9.	SAR Test Data Summary .....	23
	Procedures Used To Establish Test Signal .....	23
	Device Test Condition .....	23
10.	3G Measurement Procedures.....	37
	10.1 Procedures Used to Establish RF Signal for SAR.....	37
	10.2 SAR Measurement Conditions for WCDMA/HSDPA/HSUPA.....	37
	10.3 SAR Measurement Conditions for LTE Bands .....	40
	SAR Data Summary – VHF Face SAR Measurements.....	60
	SAR Data Summary – VHF Body SAR Measurements .....	61
	SAR Data Summary – 750 MHz LTE Band 12 .....	62
	SAR Data Summary – 835 MHz Band 5 - WCDMA.....	63
	SAR Data Summary – 1750 MHz LTE Band 4 .....	64
	SAR Data Summary – 1900 MHz Band 2 - WCDMA.....	65
	SAR Data Summary – 1900 MHz LTE Band 2 .....	66
	SAR Data Summary – Simultaneous Evaluation .....	67
	SAR Data Summary – Simultaneous Evaluation .....	67
11.	Test Equipment List.....	68
12.	Conclusion .....	69
13.	References.....	70
	Appendix A – System Validation Plots and Data .....	71
	Appendix B – SAR Test Data Plots .....	84
	Appendix C – SAR Test Setup Photos .....	97
	Appendix D – Probe Calibration Data Sheets.....	102
	Appendix E – Dipole Calibration Data Sheets .....	112
	Appendix F – Phantom Calibration Data Sheets .....	151
	Appendix G – Validation Summary.....	153

Comment/Revision	Date
Original Release	December 17, 2020
Revision A – Correct Accessories List	January 19, 2021
Revision B – Add three additional audio accessories	January 20, 2021

**Note: The latest version supersedes all previous versions listed in the above table. The latest version shall be used.**

## 1. Introduction

This measurement report shows compliance of the ICOM, Inc. Model IP730D FCC ID: AFJ417900 with FCC Part 2, 1093, ET Docket 93-62 Rules for mobile and portable devices and IC Certificate: 202D-417900 with RSS102 Issue 5 & Safety Code 6. The FCC has adopted the guidelines for evaluating the environmental effects of radio frequency radiation in ET Docket 93-62 on August 6, 1996 to protect the public and workers from the potential hazards of RF emissions due to FCC regulated portable devices. [1], [6]

The test results recorded herein are based on a single type test of ICOM, Inc. Model IP730D and therefore apply only to the tested sample.

The test procedures and limits, as described in ANSI C95.1 – 1999 Standard for Safety Levels with Respect to Human Exposure to Radio Frequency Electromagnetic Fields, 3 kHz to 300 GHz [2], ANSI C95.3 – 2002 Recommended Practice for the Measurement of Potentially Hazardous Electromagnetic Fields [3], IEEE Std.1528 – 2003 Recommended Practice [4], and Industry Canada Safety Code 6 Limits of Human Exposure to Radiofrequency Electromagnetic Fields in the Frequency Range from 3kHz to 300 GHz were employed.

The following table indicates all the wireless technologies operating in the IP730D Push-To-Talk Handheld Radio for Occupational Use. The table also shows the tolerance for the power level for each mode.

Band	Technology	Rel.	Class	3GPP Nominal Power dBm	Setpoint Nominal Power dBm	Tolerance dBm	Lower Tolerance dBm	Upper Tolerance dBm
Band 2	LTE	8	3	23.0	23.0	±2.7	20.3	25.70
Band 4	LTE	8	3	23.0	23.0	±2.7	20.3	25.70
Band 12	LTE	8	3	23.0	23.0	±2.7	20.3	25.70
Band 2	WCDMA	8	3	24.0	24.0	+1.0/-3.0	21.0	25.00
Band 5	WCDMA	8	3	24.0	24.0	+1.0/-3.0	21.0	25.00
VHF Band	FM	N/A	N/A	N/A	N/A	N/A	N/A	36.99
Bluetooth	Bluetooth	N/A	N/A	N/A	N/A	N/A	N/A	4.0

**SAR Definition [5]**

Specific Absorption Rate is defined as the time derivative (rate) of the incremental energy ( $dW$ ) absorbed by (dissipated in) an incremental mass ( $dm$ ) contained in a volume element ( $dV$ ) of a given density ( $\rho$ ).

$$SAR = \frac{d}{dt} \left( \frac{dW}{dm} \right) = \frac{d}{dt} \left( \frac{dW}{\rho dV} \right)$$

SAR is expressed in units of watts per kilogram (W/kg). SAR can be related to the electric field at a point by

$$SAR = \frac{\sigma |E|^2}{\rho}$$

where:

$\sigma$  = conductivity of the tissue (S/m)

$\rho$  = mass density of the tissue (kg/m<sup>3</sup>)

$E$  = rms electric field strength (V/m)

## 2. SAR Measurement Setup

### Robotic System

These measurements are performed using the DASY52 automated dosimetric assessment system. The DASY52 is made by Schmid & Partner Engineering AG (SPEAG) in Zurich, Switzerland and consists of high precision robotics system (Staubli), robot controller, Intel Core2 computer, near-field probe, probe alignment sensor, and the generic twin phantom containing the brain equivalent material. The robot is a six-axis industrial robot performing precise movements to position the probe to the location (points) of maximum electromagnetic field (EMF) (see Fig. 2.1).

### System Hardware

A cell controller system contains the power supply, robot controller teach pendant (Joystick), and a remote control used to drive the robot motors. The PC consists of the HP Intel Core2 computer with Windows XP system and SAR Measurement Software DASY52, A/D interface card, monitor, mouse, and keyboard. The Staubli Robot is connected to the cell controller to allow software manipulation of the robot. A data acquisition electronic (DAE) circuit that performs the signal amplification, signal multiplexing, AD-conversion, offset measurements, mechanical surface detection, collision detection, etc. is connected to the Electro-optical coupler (EOC). The EOC performs the conversion from the optical into digital electric signal of the DAE and transfers data to the PC plug-in card.

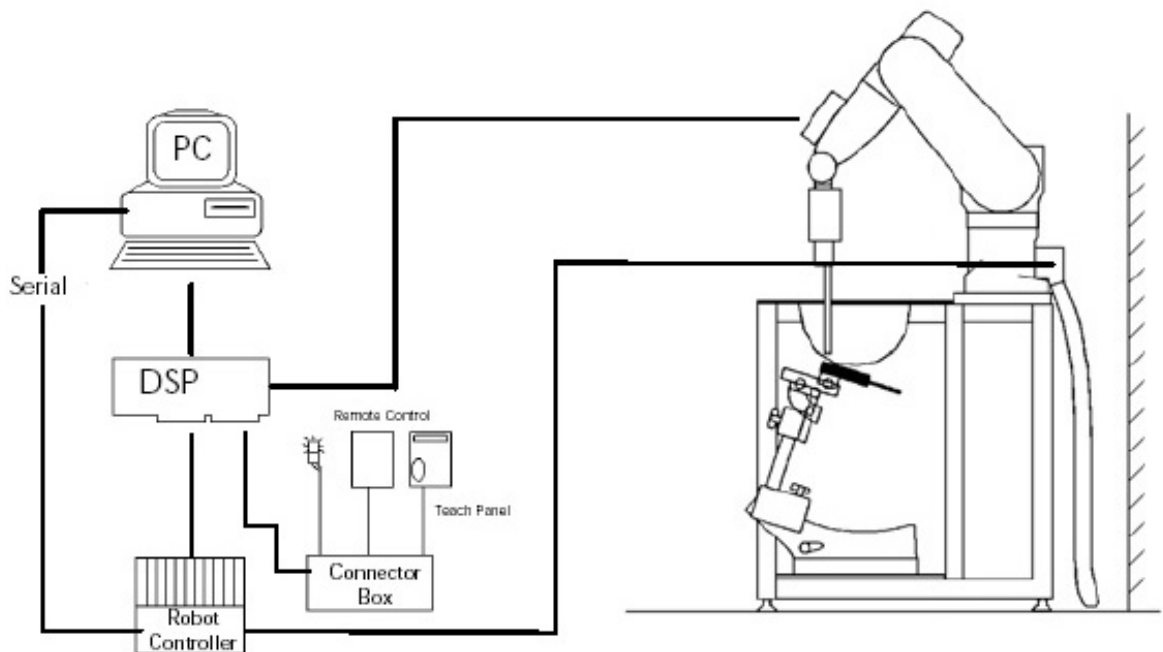

**Figure 2.1 SAR Measurement System Setup**

## System Electronics

The DAE4 consists of a highly sensitive electrometer-grade preamplifier with auto-zeroing, a channel and gain-switching multiplexer, a fast 16 bit AD-converter and a command decoder and control logic unit. Transmission to the PC-card is accomplished through an optical downlink for data and status information and an optical uplink for commands and clock lines. The mechanical probe mounting device includes two different sensor systems for frontal and sidewise probe contacts. They are also used for mechanical surface detection and probe collision detection. The robot uses its own controller with a built in VME-bus computer. The system is described in detail in.

## Probe Measurement System

The SAR measurements were conducted with the dosimetric probe EX3DV4, designed in the classical triangular configuration (see Fig. 2.2) and optimized for dosimetric evaluation. The probe is constructed using the thick film technique; with printed resistive lines on ceramic substrates. The probe is equipped with an optical multi fiber line ending at the front of the probe tip. (see Fig. 2.3) It is connected to the EOC box on the robot arm and provides an automatic detection of the phantom surface. Half of the fibers are connected to a pulsed infrared transmitter, the other half to a synchronized receiver. As the probe approaches the surface, the reflection from the surface produces a coupling from the transmitting to the receiving fibers. This reflection increases first during the approach, reaches maximum and then decreases. If the probe is flatly touching the surface, the coupling is zero. The distance of the coupling maximum to the surface is independent of the surface reflectivity and largely independent of the surface to probe angle. The DASY52 software reads the reflection during a software approach and looks for the maximum using a 2nd order fitting. The approach is stopped at reaching the maximum.



**DAE System**

**Probe Specifications**

**Calibration:** In air from 10 MHz to 6.0 GHz  
In brain and muscle simulating tissue at Frequencies of 450 MHz, 835 MHz, 1750 MHz, 1900 MHz, 2450 MHz, 2600 MHz, 3500 MHz, 5200 MHz, 5300 MHz, 5600 MHz, 5800 MHz

**Frequency:** 10 MHz to 6 GHz

**Linearity:**  $\pm 0.2$ dB (30 MHz to 6 GHz)

**Dynamic:** 10 mW/kg to 100 W/kg

**Range:** Linearity:  $\pm 0.2$ dB

**Dimensions:** Overall length: 330 mm

**Tip length:** 20 mm

**Body diameter:** 12 mm

**Tip diameter:** 2.5 mm

**Distance from probe tip to sensor center:** 1 mm

**Application:** SAR Dosimetry Testing  
Compliance tests of wireless device

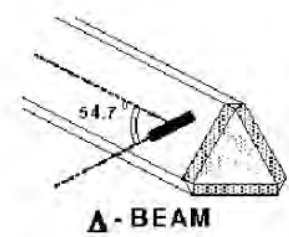

Figure 2.2 Triangular Probe Configurations



Figure 2.3 Probe Thick-Film Technique



## Probe Calibration Process

### Dosimetric Assessment Procedure

Each probe is calibrated according to a dosimetric assessment procedure described in with accuracy better than +/- 10%. The spherical isotropy was evaluated with the procedure described in and found to be better than +/-0.25dB. The sensitivity parameters (Norm X, Norm Y, Norm Z), the diode compression parameter (DCP) and the conversion factor (Conv F) of the probe is tested.

### Free Space Assessment

The free space E-field from amplified probe outputs is determined in a test chamber. This is performed in a TEM cell for frequencies below 1 GHz, and in a waveguide above 1GHz for free space. For the free space calibration, the probe is placed in the volumetric center of the cavity at the proper orientation with the field. The probe is then rotated 360 degrees until the three channels show the maximum reading. The power density readings equates to 1 mW/cm<sup>2</sup>.

### Temperature Assessment \*

E-field temperature correlation calibration is performed in a flat phantom filled with the appropriate simulated brain tissue. The measured free space E-field in the medium, correlates to temperature rise in a dielectric medium. For temperature correlation calibration a RF transparent thermistor based temperature probe is used in conjunction with the E-field probe

$$SAR = C \frac{\Delta T}{\Delta t}$$

$$SAR = \frac{|E|^2 \cdot \sigma}{\rho}$$

where:

where:

$\Delta t$  = exposure time (30 seconds),

$\sigma$  = simulated tissue conductivity,

C = heat capacity of tissue (brain or muscle),

$\rho$  = Tissue density (1.25 g/cm<sup>3</sup> for brain tissue)

$\Delta T$  = temperature increase due to RF exposure.

SAR is proportional to  $\Delta T / \Delta t$ , the initial rate of tissue heating, before thermal diffusion takes place.

Now it's possible to quantify the electric field in the simulated tissue by equating the thermally derived SAR to the E- field;

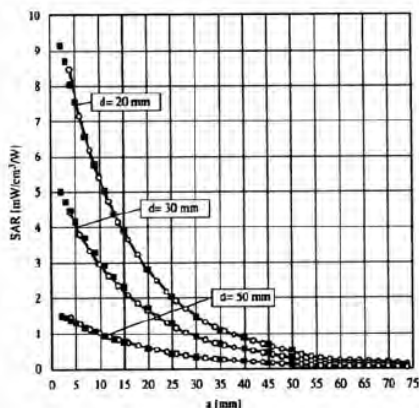

**Figure 2.4 E-Field and Temperature Measurements at 900MHz**

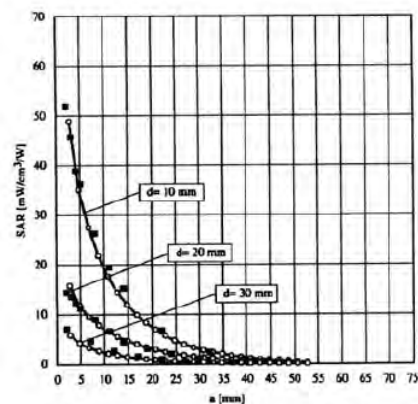

**Figure 2.5 E-Field and Temperature Measurements at 1800MHz**

## Data Extrapolation

The DASY52 software automatically executes the following procedures to calculate the field units from the microvolt readings at the probe connector. The first step of the evaluation is a linearization of the filtered input signal to account for the compression characteristics of the detector diode. The compensation depends on the input signal, the diode type and the DC-transmission factor from the diode to the evaluation electronics. If the exciting field is pulsed, the crest factor of the signal must be known to correctly compensate for peak power. The formula for each channel can be given like below;

$$V_i = U_i + U_i^2 \cdot \frac{cf}{dcp_i}$$

with  $V_i$  = compensated signal of channel i (i=x,y,z)  
 $U_i$  = input signal of channel i (i=x,y,z)  
 $cf$  = crest factor of exciting field (DASY parameter)  
 $dcp_i$  = diode compression point (DASY parameter)

From the compensated input signals the primary field data for each channel can be evaluated:

E-field probes:

$$E_i = \sqrt{\frac{V_i}{Norm_i \cdot ConvF}}$$

with  $V_i$  = compensated signal of channel i (i = x,y,z)  
 $Norm_i$  = sensor sensitivity of channel i (i = x,y,z)  
 $\mu V/(V/m)^2$  for E-field probes  
 $ConvF$  = sensitivity of enhancement in solution  
 $E_i$  = electric field strength of channel i in V/m

The RSS value of the field components gives the total field strength (Hermetian magnitude):

$$E_{tot} = \sqrt{E_x^2 + E_y^2 + E_z^2}$$

The primary field data are used to calculate the derived field units.

$$SAR = E_{tot}^2 \cdot \frac{\sigma}{\rho \cdot 1000}$$

with SAR = local specific absorption rate in W/g  
 $E_{tot}$  = total field strength in V/m  
 $\sigma$  = conductivity in [mho/m] or [Siemens/m]  
 $\rho$  = equivalent tissue density in  $g/cm^3$

The power flow density is calculated assuming the excitation field to be a free space field.

$$P_{free} = \frac{E_{tot}^2}{3770}$$

with  $P_{pwc}$  = equivalent power density of a plane wave in  $W/cm^2$   
 $E_{tot}$  = total electric field strength in V/m

## Scanning procedure

- The DASY installation includes predefined files with recommended procedures for measurements and system check. They are read-only document files and destined as fully defined but unmeasured masks. All test positions (head or body-worn) are tested with the same configuration of test steps differing only in the grid definition for the different test positions.
- The „reference“ and „drift“ measurements are located at the beginning and end of the batch process. They measure the field drift at one single point in the liquid over the complete procedure. The indicated drift is mainly the variation of the DUT’s output power and should vary max. +/- 5 %.
- The highest integrated SAR value is the main concern in compliance test applications. These values can mostly be found at the inner surface of the phantom and cannot be measured directly due to the sensor offset in the probe. To extrapolate the surface values, the measurement distances to the surface must be known accurately. A distance error of 0.5mm could produce SAR errors of 6% at 1800 MHz. Using predefined locations for measurements is not accurate enough. Any shift of the phantom (e.g., slight deformations after filling it with liquid) would produce high uncertainties. For an automatic and accurate detection of the phantom surface, the DASY5 system uses the mechanical surface detection. The detection is always at touch, but the probe will move backward from the surface the indicated distance before starting the measurement.
- The „area scan“ measures the SAR above the DUT or verification dipole on a parallel plane to the surface. It is used to locate the approximate location of the peak SAR with 2D spline interpolation. The robot performs a stepped movement along one grid axis while the local electrical field strength is measured by the probe. The probe is touching the surface of the SAM during acquisition of measurement values. The scan uses different grid spacings for different frequency measurements. Standard grid spacing for head measurements in frequency ranges  $\leq 2$ GHz is 15 mm in x - and y- dimension. For higher frequencies a finer resolution is needed, thus for the grid spacing is reduced according the following table:

Area scan grid spacing for different frequency ranges	
Frequency range	Grid spacing
$\leq 2$ GHz	$\leq 15$ mm
2 – 4 GHz	$\leq 12$ mm
4 – 6 GHz	$\leq 10$ mm

Grid spacing and orientation have no influence on the SAR result. For special applications where the standard scan method does not find the peak SAR within the grid, e.g. mobile phones with flip cover, the grid can be adapted in orientation. Results of this coarse scan are shown in annex B.

- A „zoom scan” measures the field in a volume around the 2D peak SAR value acquired in the previous „coarse” scan. It uses a fine meshed grid where the robot moves the probe in steps along all the 3 axis (x,y and z-axis) starting at the bottom of the Phantom. The grid spacing for the cube measurement is varied according to the measured frequency range, the dimensions are given in the following table:

<b>Zoom scan grid spacing and volume for different frequency ranges</b>			
Frequency range	Grid spacing for x, y axis	Grid spacing for z axis	Minimum zoom scan volume
≤ 2 GHz	≤ 8 mm	≤ 5 mm	≥ 30 mm
2 – 3 GHz	≤ 5 mm	≤ 5 mm	≥ 28 mm
3 – 4 GHz	≤ 5 mm	≤ 4 mm	≥ 28 mm
4 – 5 GHz	≤ 4 mm	≤ 3 mm	≥ 25 mm
5 – 6 GHz	≤ 4 mm	≤ 2 mm	≥ 22 mm

DASY is also able to perform repeated zoom scans if more than 1 peak is found during area scan. In this document, the evaluated peak 1g and 10g averaged SAR values are shown in the 2D-graphics in annex B. Test results relevant for the specified standard (see section 3) are shown in table form in section 7.

## Spatial Peak SAR Evaluation

The spatial peak SAR - value for 1 and 10 g is evaluated after the Cube measurements have been done. The basis of the evaluation are the SAR values measured at the points of the fine cube grid consisting of all points in the three directions x, y and z. The algorithm that finds the maximal averaged volume is separated into three different stages.

- The data between the dipole center of the probe and the surface of the phantom are extrapolated. This data cannot be measured since the center of the dipole is 1 to 2.7 mm away from the tip of the probe and the distance between the surface and the lowest measuring point is about 1 mm (see probe calibration sheet). The extrapolated data from a cube measurement can be visualized by selecting 'Graph Evaluated'.
- The maximum interpolated value is searched with a straight-forward algorithm. Around this maximum the SAR - values averaged over the spatial volumes (1g or 10 g) are computed using the 3d-spline interpolation algorithm. If the volume cannot be evaluated (i.e., if a part of the grid was cut off by the boundary of the measurement area) the evaluation will be started on the corners of the bottom plane of the cube.
- All neighbouring volumes are evaluated until no neighbouring volume with a higher average value is found.

## Extrapolation

The extrapolation is based on a least square algorithm [W. Gander, Computermathematik, p.168-180]. Through the points in the first 3 cm along the z-axis, polynomials of order four are calculated. These polynomials are then used to evaluate the points between the surface and the probe tip. The points, calculated from the surface, have a distance of 1 mm from each other.

## Interpolation

The interpolation of the points is done with a 3d-Spline. The 3d-Spline is composed of three one-dimensional splines with the "Not a knot"-condition [W. Gander, Computermathematik, p.141-150] (x, y and z -direction) [Numerical Recipes in C, Second Edition, p.123ff ].

## Volume Averaging

At First the size of the cube is calculated. Then the volume is integrated with the trapezoidal algorithm. 8000 points (20x20x20) are interpolated to calculate the average.

## Advanced Extrapolation

DASY uses the advanced extrapolation option which is able to compensate boundary effects on E-field probes.

**SAM PHANTOM**

The SAM Twin Phantom V4.0 is constructed of a fiberglass shell integrated in a wooden table. The shape of the shell is based on data from an anatomical study designed to determine the maximum exposure in at least 90% of all users. It enables the dosimetric evaluation of left and right hand phone usage as well as body mounted usage at the flat phantom region. A cover prevents the evaporation of the liquid. Reference markings on the Phantom allow the complete setup of all predefined phantom positions and measurement grids by manually teaching three points in the robot. (see Fig. 2.6)

**Phantom Specification**

**Phantom:** SAM Twin Phantom (V4.0)  
**Shell Material:** Vivac Composite  
**Thickness:**  $2.0 \pm 0.2$  mm

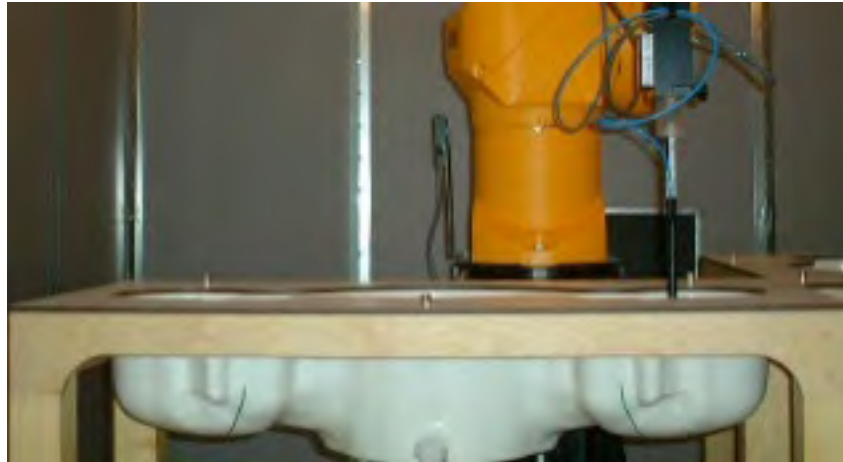

**Figure 2.6 SAM Twin Phantom**

**Device Holder for Transmitters**

In combination with the SAM Twin Phantom V4.0 the Mounting Device (see Fig. 2.7), enables the rotation of the mounted transmitter in spherical coordinates whereby the rotation point is the ear opening. The devices can be easily, accurately, and repeatedly positioned according to the FCC, CENELEC, IEC and IEEE specifications. The device holder can be locked at different phantom locations (left head, right head, flat phantom).



**Figure 2.7 Mounting Device**

Note: A simulating human hand is not used due to the complex anatomical and geometrical structure of the hand that may produce infinite number of configurations. To produce the worst-case condition (the hand absorbs antenna output power), the hand is omitted during the tests.

### **3. Probe and Dipole Calibration**

**See Appendix D and E.**

## 4. Phantom & Simulating Tissue Specifications

### Head & Body Simulating Mixture Characterization

The head and body mixtures consist of the material based on the table listed below. The mixture is calibrated to obtain proper dielectric constant (permittivity) and conductivity of the desired tissue. Body tissue parameters that have not been specified in IEEE1528-2013 are derived from the issue dielectric parameters computed from the 4-Cole-Cole equations.

**Table 4.1 Typical Composition of Ingredients for Tissue**

Ingredients		Simulating Tissue				
		150 MHz Head	750 MHz Head	835 MHz Head	1750 MHz Head	1900 MHz Head
Mixing Percentage						
Water		Proprietary Purchased From Speag	Proprietary Purchased From Speag	Proprietary Purchased From Speag	Proprietary Purchased From Speag	Proprietary Purchased From Speag
Sugar						
Salt						
HEC						
Bactericide						
DGBE						
Dielectric Constant	Target	52.30	41.94	41.52	40.08	40.00
Conductivity (S/m)	Target	0.76	0.89	0.91	1.37	1.40



## 5. ANSI/IEEE C95.1 – 1999 RF Exposure Limits [2]

### Uncontrolled Environment

Uncontrolled Environments are defined as locations where there is the exposure of individuals who have no knowledge or control of their exposure. The general population/uncontrolled exposure limits are applicable to situations in which the general public may be exposed or in which persons who are exposed as a consequence of their employment may not be made fully aware of the potential for exposure or cannot exercise control over their exposure. Members of the general public would come under this category when exposure is not employment-related; for example, in the case of a wireless transmitter that exposes persons in its vicinity.

### Controlled Environment

Controlled Environments are defined as locations where there is exposure that may be incurred by persons who are aware of the potential for exposure, (i.e. as a result of employment or occupation). In general, occupational/controlled exposure limits are applicable to situations in which persons are exposed as a consequence of their employment, who have been made fully aware of the potential for exposure and can exercise control over their exposure. This exposure category is also applicable when the exposure is of a transient nature due to incidental passage through a location where the exposure levels may be higher than the general population/uncontrolled limits, but the exposed person is fully aware of the potential for exposure and can exercise control over his or her exposure by leaving the area or by some other appropriate means.

**Table 5.1 Human Exposure Limits**

	UNCONTROLLED ENVIRONMENT General Population (W/kg) or (mW/g)	CONTROLLED ENVIRONMENT Professional Population (W/kg) or (mW/g)
SPATIAL PEAK SAR <sup>1</sup> Brain	1.60	8.00
SPATIAL AVERAGE SAR <sup>2</sup> Whole Body	0.08	0.40
SPATIAL PEAK SAR <sup>3</sup> Hands, Feet, Ankles, Wrists	4.00	20.00

<sup>1</sup> The Spatial Peak value of the SAR averaged over any 1 gram of tissue (defined as a tissue volume in the shape of a cube) and over the appropriate averaging time.

<sup>2</sup> The Spatial Average value of the SAR averaged over the whole body.

<sup>3</sup> The Spatial Peak value of the SAR averaged over any 10 grams of tissue (defined as a tissue volume in the shape of a cube) and over the appropriate averaging time.

## 6. Measurement Uncertainty

Measurement uncertainty table is not required per KDB 865664 D01 v01r04 section 2.8.2 page 12. SAR measurement uncertainty analysis is required in the SAR report only when the highest measured SAR in a frequency band is  $\geq 1.5$  W/kg for 1-g SAR. The equivalent ratio (1.5/1.6) should be applied to extremity and occupational exposure conditions. The highest reported value is less than 1.5 W/kg. Therefore, the measurement uncertainty table is not required.

## 7. System Validation

### Tissue Verification

**Table 7.1 Measured Tissue Parameters**

		150 MHz Head		750 MHz Head		835 MHz Head	
Date(s)		Dec. 2, 2020		Dec. 11, 2020		Dec. 10, 2020	
Liquid Temperature (°C)	20.0	Target	Measured	Target	Measured	Target	Measured
Dielectric Constant: $\epsilon$		52.30	52.32	41.94	41.55	41.52	41.24
Conductivity: $\sigma$		0.76	0.78	0.89	0.91	0.91	0.95
		1750 MHz Head		1900 MHz Head			
Date(s)		Dec. 9, 2020		Dec. 8, 2020			
Liquid Temperature (°C)	20.0	Target	Measured	Target	Measured		
Dielectric Constant: $\epsilon$		40.08	39.63	40.00	39.46		
Conductivity: $\sigma$		1.37	1.42	1.40	1.46		

See Appendix A for data printout.

### Test System Verification

Prior to assessment, the system is verified to the  $\pm 10\%$  of the specifications at the test frequency by using the system kit. Power is extrapolated to 1 watt. (Graphic Plots Attached)

**Table 7.2 System Dipole Validation Target & Measured**

	Test Frequency	Targeted SAR <sub>1g</sub> (W/kg)	Measure SAR <sub>1g</sub> (W/kg)	Tissue Used for Verification	Deviation (%)	Plot Number
02-Dec-2020	150 MHz	3.87	3.88	Head	+ 0.26	1
11-Dec-2020	750 MHz	8.23	8.26	Head	+ 0.36	2
10-Dec-2020	835 MHz	9.44	9.49	Head	+ 0.53	3
09-Dec-2020	1750 MHz	36.10	36.70	Head	+ 1.66	4
08-Dec-2020	1900 MHz	40.60	40.90	Head	+ 0.74	5

See Appendix A for data plots.

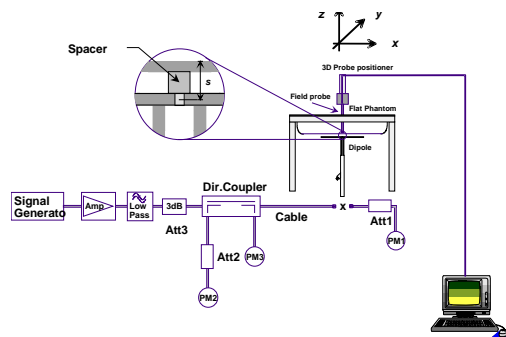

**Figure 7.1 Dipole Validation Test Setup**

## 8. LTE Document Checklist

- 1) Identify the operating frequency range of each LTE transmission band used by the device

LTE Operating Band	Uplink (transmit)	Downlink (Receive)	Duplex mode (FDD/TDD)
	Low - high	Low - high	
2	1850-1910	1930-1990	FDD
4	1710-1755	2110-2155	FDD
12	699-716	729-746	FDD

- 2) Identify the channel bandwidths used in each frequency band; 1.4, 3, 5, 10, 15, 20 MHz etc

LTE Band Class	Bandwidth (MHz)	Frequency or Freq. Band (MHz)
2	1.4, 3, 5, 10, 15, 20	1850-1910 MHz
4	1.4, 3, 5, 10, 15, 20	1710-1755 MHz
12	1.4, 3, 5, 10	699-716 MHz

- 3) Identify the high, middle and low (H, M, L) channel numbers and frequencies in each LTE frequency band

LTE Band Class	Bandwidth (MHz)	Frequency (MHz)/Channel #					
		Low		Mid		High	
2	1.4	1850.7	18607	1880.0	18900	1909.3	19193
2	3	1851.5	18615	1880.0	18900	1908.5	19185
2	5	1852.5	18625	1880.0	18900	1907.5	19175
2	10	1855.0	18650	1880.0	18900	1905.0	19150
2	15	1857.5	18675	1880.0	18900	1902.5	19125
2	20	1860.0	18700	1880.0	18900	1900.0	19100
4	1.4	1710.7	19957	1732.5	20175	1754.3	20393
4	3	1711.5	19965	1732.5	20175	1753.5	20385
4	5	1712.5	19975	1732.5	20175	1752.5	20375
4	10	1715.0	20000	1732.5	20175	1750.0	20350
4	15	1717.5	20025	1732.5	20175	1747.5	20325
4	20	1720.0	20050	1732.5	20175	1745.0	20300
12	1.4	699.7	23017	707.5	23095	715.3	23173
12	3	700.5	23025	707.5	23095	714.5	23165
12	5	701.5	23035	707.5	23095	713.5	23155
12	10	704.0	23060	707.5	23095	711.0	23130

- 4) Specify the UE category and uplink modulations used:

- UE Category: 3
- Uplink modulations: QPSK and 16QAM

- 5) Include descriptions of the LTE transmitter and antenna implementation; and also identify whether it is a standalone transmitter operating independently of other wireless transmitters in the device or sharing hardware components and/or antenna(s) with other transmitters etc

The device has 3 antennas:

- WWAN Main (Transmit and Receive) Antenna
- VHF Antenna
- BT Main Antenna

Transmission relationship

- All LTE/WCDMA transmission (TX) is limited to the WWAN antenna only
- Simultaneous evaluation is conducted for the WWAN & BT and VHF & BT

- 6) Identify the LTE voice/data requirements in each operating mode and exposure condition with respect to head and body test configurations, antenna locations, handset flip-cover or slide positions, antenna diversity conditions etc

The device is a voice/data device. Voice mode was tested in each operating mode and exposure condition in the head and body configuration. See test setup photos to see all configurations tested.

- 7) Identify if Maximum Power Reduction (MPR) is optional or mandatory, i.e. built-in by design:
- a) Only mandatory MPR may be considered during SAR testing, when the maximum output power is permanently limited by the MPR implemented within the UE; and only for the applicable RB (resource block) configurations specified in LTE standards

MPR is mandatory, built-in by design on all production units. It was enabled during testing.

Modulation	Channel Bandwidth/transmission Bandwidth Configuration (RB)						MPR (dB)
	1.4 MHz	3.0 MHz	5 MHz	10 MHz	15 MHz	20 MHz	
QPSK	> 5	> 4	> 8	> 12	> 16	> 18	≤ 1
16QAM	≤ 5	≤ 4	≤ 8	≤ 12	≤ 16	≤ 18	≤ 1
16QAM	> 5	> 4	> 8	> 12	> 16	> 18	≤ 2

- b) A-MPR (additional MPR) must be disabled
- c) A-MPR was disabled during testing.

- 8) Include the maximum average conducted output power measured on the required test channels for each channel bandwidth and UL modulation used in each frequency band:

The maximum average conducted output power measured for the testing is listed on pages 42-57 of this report. The below table shows the factory set point with the allowable tolerance.

Band	Technology	Rel.	Class	3GPP Nominal Power dBm	Setpoint Nominal Power dBm	Tolerance dBm	Lower Tolerance dBm	Upper Tolerance dBm
Band 2	LTE	8	3	23.0	23.0	±2.7	20.3	25.70
Band 4	LTE	8	3	23.0	23.0	±2.7	20.3	25.70
Band 12	LTE	8	3	23.0	23.0	±2.7	20.3	25.70

- 9) Identify all other U.S. wireless operating modes (3G, Wi-Fi, WiMax, Bluetooth etc), device/exposure configurations (head and body, antenna and handset flip-cover or slide positions, antenna diversity conditions etc.) and frequency bands used for these modes

Other wireless modes:

The device contains a WiFi, BT and ISM transmitter as well. Simultaneous Tx is evaluated below.

Band	Technology	Rel.	Class	3GPP Nominal Power dBm	Setpoint Nominal Power dBm	Tolerance dBm	Lower Tolerance dBm	Upper Tolerance dBm
Band 2	WCDMA	8	3	24.0	24.0	+1.0/-3.0	21.0	25.00
Band 5	WCDMA	8	3	24.0	24.0	+1.0/-3.0	21.0	25.00
VHF Band	FM	N/A	N/A	N/A	N/A	N/A	N/A	36.99
Bluetooth	Bluetooth	N/A	N/A	N/A	N/A	N/A	N/A	4.0

- 10) Include the maximum average conducted output power measured for the other wireless modes and frequency bands.

The maximum average conducted output power measured for the testing is listed on pages 36 & 39 of this report. The below table shows the factory set point with the allowable tolerance.

- 11) Identify the simultaneous transmission conditions for the voice and data configurations supported by all wireless modes, device configurations and frequency bands, for the head and body exposure conditions and device operating configurations (handset flip or cover positions, antenna diversity conditions etc.)

The device is able to transmit simultaneously with the WWAN & BT and VHF & BT.

- 12) When power reduction is applied to certain wireless modes to satisfy SAR compliance for simultaneous transmission conditions, other equipment certification or operating requirements, include the maximum average conducted output power measured in each power reduction mode applicable to the simultaneous voice/data transmission configurations for such wireless configurations and frequency bands; and also include details of the power reduction implementation and measurement setup

Power reduction is not required to satisfy SAR compliance.

- 13) Include descriptions of the test equipment, test software, built-in test firmware etc. required to support testing the device when power reduction is applied to one or more transmitters/antennas for simultaneous voice/data transmission

Power reduction is not required to satisfy SAR compliance.

- 14) When appropriate, include a SAR test plan proposal with respect to the above

Power reduction is not required to satisfy SAR compliance.

- 15) If applicable, include preliminary SAR test data and/or supporting information in laboratory testing inquiries to address specific issues and concerns or for requesting further test reduction considerations appropriate for the device; for example, simultaneous transmission configurations.

Not applicable.

## 9. SAR Test Data Summary

### See Measurement Result Data Pages

See Appendix B for SAR Test Data Plots.  
See Appendix C for SAR Test Setup Photos.

### Procedures Used To Establish Test Signal

The device was placed into simulated transmit mode using the manufacturer's test codes. Such test signals offer a consistent means for testing SAR and are recommended for evaluating SAR. When test modes are not available or inappropriate for testing a device, the actual transmission is activated through a base station simulator or similar equipment. See data pages for actual procedure used in measurement.

### Device Test Condition

In order to verify that the device was tested at full power, conducted output power measurements were performed before and after each SAR measurement to confirm the output power unless otherwise noted. If a conducted power deviation of more than 5% occurred, the test was repeated. The power drift of each test is measured at the start of the test and again at the end of the test. The drift percentage is calculated by the formula  $((\text{end}/\text{start})-1)*100$  and rounded to three decimal places. The drift percentage is calculated into the resultant SAR value on the data sheet for each test.

The IP730D was tested in the face position with the front of the device 25 mm away from the flat phantom. The IP730D was then tested in the body position with the body accessory (MB-133) in contact with the flat phantom. The audio accessory (HM-236) was used for all body measurements. All other audio accessories have been excluded per KDB 643646 D01 v01r03 section A2. All the audio accessories are 50 ohm connections to the radio and the standard audio accessory was used for all measurements next to the body per KDB 643646 D01 v01r03 section A2. For each of the tests conducted, the device was set to continuously transmit at a maximum output power on the channel specified in the test data. The SAR was scaled to 50% duty cycle per KDB 643646 D01 v01r03. All test reductions were reduced based on the reductions in KDB 643646 D01 v01r03. See pages 25-35 for a table of test reductions.

The LTE/WCDMA bands were all tested in the same configuration as the VHF band. The SAR limit used for the cellular bands was the general population. All test reductions are per KDB 447498 v06 and KDB941225 D01 v03r01 and D05 v02r05. See page 40 for a table of test reductions for WCDMA and pages 58-60 for LTE.

The BT transmitter is excluded from SAR testing. The BT antenna has a minimum separation distance of 5 mm. The calculations are listed below.

For the FCC, the formula to use is listed in KDB447498 D01 v06 section 4.3.1 a).

$$[(\text{max. power, mW})/(\text{min. distance, mm})]^2 \cdot \sqrt{f_{\text{(GHz)}}} \leq 3.0$$

For BT,  $(2.5/5) \cdot \sqrt{2.48} = 0.8$  which is less than 3.0

For ISED, the limit is based on Table 1 in RSS-102 Issue 5 section 2.5.1. Therefore, the maximum power for the BT is 4.0 mW to be excluded. The maximum power for the BT is 2.5 mW which is below the 4.0 limit.

Simultaneous evaluation is shown on page 68.

The device was on a minimum of 10 cm of Styrofoam during each test.

**Optional Accessories**

Accessory	Description	Part Number
Battery A	Li-Ion, 3350 mAh	BP-303
Battery B	Li-Ion, 2010 mAh	BP-302
Battery C	5 AA Battery Case	BP-305
Antenna A	136 – 150 MHz	FA-SC25V
Antenna B	136 – 144 MHz	FA-SC-26VS
Antenna C	142 – 150 MHz	FA-SC27VS
Antenna D	148 – 162 MHz	FA-SC28V
Antenna E	160 – 174 MHz	FA-SC29V
Antenna F	150 – 174 MHz	FA-SC55V
Antenna G	150 – 162 MHz	FA-SC56VS
Antenna H	160 – 174 MHz	FA-SC57VS
Antenna I	136 – 174 MHz	FA-SC61VC
Audio Accessory A	Tie Clip Microphone	HM-163MC
Audio Accessory B	Speaker Microphone	HM-184
Audio Accessory C	Speaker Microphone	HM-222H
Audio Accessory D	Speaker Microphone	HM-236
Audio Accessory E	Tie Clip Microphone with Sub PTT Button	HM-238MC
Audio Accessory F	Speaker Microphone	HM-222
Audio Accessory G	Earphone Adapter	AD-135
Audio Accessory H	Earphone	SP-16BW
Audio Accessory I	Tube Earphone	SP-26
Audio Accessory J	Tube Earphone	SP-27
Audio Accessory K	Earhook Earphone	SP-28
Audio Accessory L	Earhook Earphone	SP-29
Audio Accessory M	Earphone	SP-40
Audio Accessory N	Earhook Type Headset	HS-94
Audio Accessory O	Neck Arm Type Headset	HS-95
Audio Accessory P	Headset with Throat Microphone	HS-97
Audio Accessory Q	Bluetooth Headset	VS-3
Audio Accessory R	PTT Switch Cable	VS-5MC
Audio Accessory S	PTT Switch Cable	VS-4MC
Audio Accessory T	External Speaker Microphone	HM-184H
Audio Accessory U	Earphone Adapter	AD-135
Audio Accessory V	External Speaker Microphone	HM-245T
Body Worn Accessory A	Belt Clip	MB-133
Body Worn Accessory B	Belt Clip	MB-136
Body Worn Accessory C	Belt Hanger	MB-96F
Body Worn Accessory D	Belt Hanger	MB-96FL
Body Worn Accessory E	Belt Hanger	MB-96N
Body Worn Accessory F	Shoulder Strap	MB-57L
Body Worn Accessory G	Carrying Case	LC-195

Audio Accessory D was chosen for the testing body worn radio configuration. Audio Accessory A-C and E-V are excluded per KDB 643646 D01 v01r01 page 10 1) A). The following tables shows all combinations with the tested combination marked yes.



**Radio Face Test**

<b>Antenna A</b>	<b>Antenna B</b>	<b>Antenna C</b>	<b>Antenna D</b>	<b>Antenna E</b>	<b>Antenna F</b>
Battery A	Battery A	Battery A	Battery A	Battery A	Battery A
No	No	No	No	No	No
<b>Antenna G</b>	<b>Antenna H</b>	<b>Antenna I</b>			
Battery A	Battery A	Battery A			
No	No	Yes			

All other antennas are excluded as they are fully within the same frequency of Antenna I per KDB643646 D01 v01r01.

### Radio Body Test

Audio Accessory	Antenna A					
	Audio Acc'y A	Audio Acc'y B	Audio Acc'y C	Audio Acc'y D	Audio Acc'y E	Audio Acc'y F
	Battery A	Battery A	Battery A	Battery A	Battery A	Battery A
Body Worn A	No	No	No	No	No	No
Body Worn B	No	No	No	No	No	No
Body Worn C	No	No	No	No	No	No
Body Worn D	No	No	No	No	No	No
Body Worn E	No	No	No	No	No	No
Body Worn F	No	No	No	No	No	No
Body Worn G	No	No	No	No	No	No

### Radio Body Test

Audio Accessory	Antenna A					
	Audio Acc'y G	Audio Acc'y H	Audio Acc'y I	Audio Acc'y J	Audio Acc'y K	Audio Acc'y L
	Battery A	Battery A	Battery A	Battery A	Battery A	Battery A
Body Worn A	No	No	No	No	No	No
Body Worn B	No	No	No	No	No	No
Body Worn C	No	No	No	No	No	No
Body Worn D	No	No	No	No	No	No
Body Worn E	No	No	No	No	No	No
Body Worn F	No	No	No	No	No	No
Body Worn G	No	No	No	No	No	No

### Radio Body Test

Audio Accessory	Antenna A					
	Audio Acc'y M	Audio Acc'y N	Audio Acc'y O	Audio Acc'y P	Audio Acc'y Q	Audio Acc'y R
	Battery A	Battery A	Battery A	Battery A	Battery A	Battery A
Body Worn A	No	No	No	No	No	No
Body Worn B	No	No	No	No	No	No
Body Worn C	No	No	No	No	No	No
Body Worn D	No	No	No	No	No	No
Body Worn E	No	No	No	No	No	No
Body Worn F	No	No	No	No	No	No
Body Worn G	No	No	No	No	No	No

### Radio Body Test

Audio Accessory	Antenna A			
	Audio Acc'y S	Audio Acc'y T	Audio Acc'y U	Audio Acc'y V
	Battery A	Battery A	Battery A	Battery A
Body Worn A	No	No	No	No
Body Worn B	No	No	No	No
Body Worn C	No	No	No	No
Body Worn D	No	No	No	No
Body Worn E	No	No	No	No
Body Worn F	No	No	No	No
Body Worn G	No	No	No	No

### Radio Body Test

Audio Accessory	Antenna B					
	Audio Acc'y A	Audio Acc'y B	Audio Acc'y C	Audio Acc'y D	Audio Acc'y E	Audio Acc'y F
	Battery A	Battery A	Battery A	Battery A	Battery A	Battery A
Body Worn A	No	No	No	No	No	No
Body Worn B	No	No	No	No	No	No
Body Worn C	No	No	No	No	No	No
Body Worn D	No	No	No	No	No	No
Body Worn E	No	No	No	No	No	No
Body Worn F	No	No	No	No	No	No
Body Worn G	No	No	No	No	No	No

### Radio Body Test

Audio Accessory	Antenna B					
	Audio Acc'y G	Audio Acc'y H	Audio Acc'y I	Audio Acc'y J	Audio Acc'y K	Audio Acc'y L
	Battery A	Battery A	Battery A	Battery A	Battery A	Battery A
Body Worn A	No	No	No	No	No	No
Body Worn B	No	No	No	No	No	No
Body Worn C	No	No	No	No	No	No
Body Worn D	No	No	No	No	No	No
Body Worn E	No	No	No	No	No	No
Body Worn F	No	No	No	No	No	No
Body Worn G	No	No	No	No	No	No

### Radio Body Test

Audio Accessory	Antenna B					
	Audio Acc'y M	Audio Acc'y N	Audio Acc'y O	Audio Acc'y P	Audio Acc'y Q	Audio Acc'y R
	Battery A	Battery A	Battery A	Battery A	Battery A	Battery A
Body Worn A	No	No	No	No	No	No
Body Worn B	No	No	No	No	No	No
Body Worn C	No	No	No	No	No	No
Body Worn D	No	No	No	No	No	No
Body Worn E	No	No	No	No	No	No
Body Worn F	No	No	No	No	No	No
Body Worn G	No	No	No	No	No	No

### Radio Body Test

Audio Accessory	Antenna B			
	Audio Acc'y S	Audio Acc'y T	Audio Acc'y U	Audio Acc'y V
	Battery A	Battery A	Battery A	Battery A
Body Worn A	No	No	No	No
Body Worn B	No	No	No	No
Body Worn C	No	No	No	No
Body Worn D	No	No	No	No
Body Worn E	No	No	No	No
Body Worn F	No	No	No	No
Body Worn G	No	No	No	No

### Radio Body Test

Audio Accessory	Antenna C					
	Audio Acc'y A	Audio Acc'y B	Audio Acc'y C	Audio Acc'y D	Audio Acc'y E	Audio Acc'y F
	Battery A	Battery A	Battery A	Battery A	Battery A	Battery A
Body Worn A	No	No	No	No	No	No
Body Worn B	No	No	No	No	No	No
Body Worn C	No	No	No	No	No	No
Body Worn D	No	No	No	No	No	No
Body Worn E	No	No	No	No	No	No
Body Worn F	No	No	No	No	No	No
Body Worn G	No	No	No	No	No	No

### Radio Body Test

Audio Accessory	Antenna C					
	Audio Acc'y G	Audio Acc'y H	Audio Acc'y I	Audio Acc'y J	Audio Acc'y K	Audio Acc'y L
	Battery A	Battery A	Battery A	Battery A	Battery A	Battery A
Body Worn A	No	No	No	No	No	No
Body Worn B	No	No	No	No	No	No
Body Worn C	No	No	No	No	No	No
Body Worn D	No	No	No	No	No	No
Body Worn E	No	No	No	No	No	No
Body Worn F	No	No	No	No	No	No
Body Worn G	No	No	No	No	No	No

### Radio Body Test

Audio Accessory	Antenna C					
	Audio Acc'y M	Audio Acc'y N	Audio Acc'y O	Audio Acc'y P	Audio Acc'y Q	Audio Acc'y R
	Battery A	Battery A	Battery A	Battery A	Battery A	Battery A
Body Worn A	No	No	No	No	No	No
Body Worn B	No	No	No	No	No	No
Body Worn C	No	No	No	No	No	No
Body Worn D	No	No	No	No	No	No
Body Worn E	No	No	No	No	No	No
Body Worn F	No	No	No	No	No	No
Body Worn G	No	No	No	No	No	No

### Radio Body Test

Audio Accessory	Antenna C			
	Audio Acc'y S	Audio Acc'y T	Audio Acc'y U	Audio Acc'y V
	Battery A	Battery A	Battery A	Battery A
Body Worn A	No	No	No	No
Body Worn B	No	No	No	No
Body Worn C	No	No	No	No
Body Worn D	No	No	No	No
Body Worn E	No	No	No	No
Body Worn F	No	No	No	No
Body Worn G	No	No	No	No

### Radio Body Test

Audio Accessory	Antenna D					
	Audio Acc'y A	Audio Acc'y B	Audio Acc'y C	Audio Acc'y D	Audio Acc'y E	Audio Acc'y F
	Battery A	Battery A	Battery A	Battery A	Battery A	Battery A
Body Worn A	No	No	No	No	No	No
Body Worn B	No	No	No	No	No	No
Body Worn C	No	No	No	No	No	No
Body Worn D	No	No	No	No	No	No
Body Worn E	No	No	No	No	No	No
Body Worn F	No	No	No	No	No	No
Body Worn G	No	No	No	No	No	No

### Radio Body Test

Audio Accessory	Antenna D					
	Audio Acc'y G	Audio Acc'y H	Audio Acc'y I	Audio Acc'y J	Audio Acc'y K	Audio Acc'y L
	Battery A	Battery A	Battery A	Battery A	Battery A	Battery A
Body Worn A	No	No	No	No	No	No
Body Worn B	No	No	No	No	No	No
Body Worn C	No	No	No	No	No	No
Body Worn D	No	No	No	No	No	No
Body Worn E	No	No	No	No	No	No
Body Worn F	No	No	No	No	No	No
Body Worn G	No	No	No	No	No	No

### Radio Body Test

Audio Accessory	Antenna D					
	Audio Acc'y M	Audio Acc'y N	Audio Acc'y O	Audio Acc'y P	Audio Acc'y Q	Audio Acc'y R
	Battery A	Battery A	Battery A	Battery A	Battery A	Battery A
Body Worn A	No	No	No	No	No	No
Body Worn B	No	No	No	No	No	No
Body Worn C	No	No	No	No	No	No
Body Worn D	No	No	No	No	No	No
Body Worn E	No	No	No	No	No	No
Body Worn F	No	No	No	No	No	No
Body Worn G	No	No	No	No	No	No

### Radio Body Test

Audio Accessory	Antenna D			
	Audio Acc'y S	Audio Acc'y T	Audio Acc'y U	Audio Acc'y V
	Battery A	Battery A	Battery A	Battery A
Body Worn A	No	No	No	No
Body Worn B	No	No	No	No
Body Worn C	No	No	No	No
Body Worn D	No	No	No	No
Body Worn E	No	No	No	No
Body Worn F	No	No	No	No
Body Worn G	No	No	No	No

### Radio Body Test

Audio Accessory	Antenna E					
	Audio Acc'y A	Audio Acc'y B	Audio Acc'y C	Audio Acc'y D	Audio Acc'y E	Audio Acc'y F
	Battery A	Battery A	Battery A	Battery A	Battery A	Battery A
Body Worn A	No	No	No	No	No	No
Body Worn B	No	No	No	No	No	No
Body Worn C	No	No	No	No	No	No
Body Worn D	No	No	No	No	No	No
Body Worn E	No	No	No	No	No	No
Body Worn F	No	No	No	No	No	No
Body Worn G	No	No	No	No	No	No

### Radio Body Test

Audio Accessory	Antenna E					
	Audio Acc'y G	Audio Acc'y H	Audio Acc'y I	Audio Acc'y J	Audio Acc'y K	Audio Acc'y L
	Battery A	Battery A	Battery A	Battery A	Battery A	Battery A
Body Worn A	No	No	No	No	No	No
Body Worn B	No	No	No	No	No	No
Body Worn C	No	No	No	No	No	No
Body Worn D	No	No	No	No	No	No
Body Worn E	No	No	No	No	No	No
Body Worn F	No	No	No	No	No	No
Body Worn G	No	No	No	No	No	No

### Radio Body Test

Audio Accessory	Antenna E					
	Audio Acc'y M	Audio Acc'y N	Audio Acc'y O	Audio Acc'y P	Audio Acc'y Q	Audio Acc'y R
	Battery A	Battery A	Battery A	Battery A	Battery A	Battery A
Body Worn A	No	No	No	No	No	No
Body Worn B	No	No	No	No	No	No
Body Worn C	No	No	No	No	No	No
Body Worn D	No	No	No	No	No	No
Body Worn E	No	No	No	No	No	No
Body Worn F	No	No	No	No	No	No
Body Worn G	No	No	No	No	No	No

### Radio Body Test

Audio Accessory	Antenna E			
	Audio Acc'y S	Audio Acc'y T	Audio Acc'y U	Audio Acc'y V
	Battery A	Battery A	Battery A	Battery A
Body Worn A	No	No	No	No
Body Worn B	No	No	No	No
Body Worn C	No	No	No	No
Body Worn D	No	No	No	No
Body Worn E	No	No	No	No
Body Worn F	No	No	No	No
Body Worn G	No	No	No	No

### Radio Body Test

Audio Accessory	Antenna F					
	Audio Acc'y A	Audio Acc'y B	Audio Acc'y C	Audio Acc'y D	Audio Acc'y E	Audio Acc'y F
	Battery A	Battery A	Battery A	Battery A	Battery A	Battery A
Body Worn A	No	No	No	No	No	No
Body Worn B	No	No	No	No	No	No
Body Worn C	No	No	No	No	No	No
Body Worn D	No	No	No	No	No	No
Body Worn E	No	No	No	No	No	No
Body Worn F	No	No	No	No	No	No
Body Worn G	No	No	No	No	No	No

### Radio Body Test

Audio Accessory	Antenna F					
	Audio Acc'y G	Audio Acc'y H	Audio Acc'y I	Audio Acc'y J	Audio Acc'y K	Audio Acc'y L
	Battery A	Battery A	Battery A	Battery A	Battery A	Battery A
Body Worn A	No	No	No	No	No	No
Body Worn B	No	No	No	No	No	No
Body Worn C	No	No	No	No	No	No
Body Worn D	No	No	No	No	No	No
Body Worn E	No	No	No	No	No	No
Body Worn F	No	No	No	No	No	No
Body Worn G	No	No	No	No	No	No

### Radio Body Test

Audio Accessory	Antenna F					
	Audio Acc'y M	Audio Acc'y N	Audio Acc'y O	Audio Acc'y P	Audio Acc'y Q	Audio Acc'y R
	Battery A	Battery A	Battery A	Battery A	Battery A	Battery A
Body Worn A	No	No	No	No	No	No
Body Worn B	No	No	No	No	No	No
Body Worn C	No	No	No	No	No	No
Body Worn D	No	No	No	No	No	No
Body Worn E	No	No	No	No	No	No
Body Worn F	No	No	No	No	No	No
Body Worn G	No	No	No	No	No	No

### Radio Body Test

Audio Accessory	Antenna F			
	Audio Acc'y S	Audio Acc'y T	Audio Acc'y U	Audio Acc'y V
	Battery A	Battery A	Battery A	Battery A
Body Worn A	No	No	No	No
Body Worn B	No	No	No	No
Body Worn C	No	No	No	No
Body Worn D	No	No	No	No
Body Worn E	No	No	No	No
Body Worn F	No	No	No	No
Body Worn G	No	No	No	No

### Radio Body Test

Audio Accessory	Antenna G					
	Audio Acc'y A	Audio Acc'y B	Audio Acc'y C	Audio Acc'y D	Audio Acc'y E	Audio Acc'y F
	Battery A	Battery A	Battery A	Battery A	Battery A	Battery A
Body Worn A	No	No	No	No	No	No
Body Worn B	No	No	No	No	No	No
Body Worn C	No	No	No	No	No	No
Body Worn D	No	No	No	No	No	No
Body Worn E	No	No	No	No	No	No
Body Worn F	No	No	No	No	No	No
Body Worn G	No	No	No	No	No	No

### Radio Body Test

Audio Accessory	Antenna G					
	Audio Acc'y G	Audio Acc'y H	Audio Acc'y I	Audio Acc'y J	Audio Acc'y K	Audio Acc'y L
	Battery A	Battery A	Battery A	Battery A	Battery A	Battery A
Body Worn A	No	No	No	No	No	No
Body Worn B	No	No	No	No	No	No
Body Worn C	No	No	No	No	No	No
Body Worn D	No	No	No	No	No	No
Body Worn E	No	No	No	No	No	No
Body Worn F	No	No	No	No	No	No
Body Worn G	No	No	No	No	No	No

### Radio Body Test

Audio Accessory	Antenna G					
	Audio Acc'y M	Audio Acc'y N	Audio Acc'y O	Audio Acc'y P	Audio Acc'y Q	Audio Acc'y R
	Battery A	Battery A	Battery A	Battery A	Battery A	Battery A
Body Worn A	No	No	No	No	No	No
Body Worn B	No	No	No	No	No	No
Body Worn C	No	No	No	No	No	No
Body Worn D	No	No	No	No	No	No
Body Worn E	No	No	No	No	No	No
Body Worn F	No	No	No	No	No	No
Body Worn G	No	No	No	No	No	No

### Radio Body Test

Audio Accessory	Antenna G			
	Audio Acc'y S	Audio Acc'y T	Audio Acc'y U	Audio Acc'y V
	Battery A	Battery A	Battery A	Battery A
Body Worn A	No	No	No	No
Body Worn B	No	No	No	No
Body Worn C	No	No	No	No
Body Worn D	No	No	No	No
Body Worn E	No	No	No	No
Body Worn F	No	No	No	No
Body Worn G	No	No	No	No



### Radio Body Test

Audio Accessory	Antenna H					
	Audio Acc'y A	Audio Acc'y B	Audio Acc'y C	Audio Acc'y D	Audio Acc'y E	Audio Acc'y F
	Battery A	Battery A	Battery A	Battery A	Battery A	Battery A
Body Worn A	No	No	No	No	No	No
Body Worn B	No	No	No	No	No	No
Body Worn C	No	No	No	No	No	No
Body Worn D	No	No	No	No	No	No
Body Worn E	No	No	No	No	No	No
Body Worn F	No	No	No	No	No	No
Body Worn G	No	No	No	No	No	No

### Radio Body Test

Audio Accessory	Antenna H					
	Audio Acc'y G	Audio Acc'y H	Audio Acc'y I	Audio Acc'y J	Audio Acc'y K	Audio Acc'y L
	Battery A	Battery A	Battery A	Battery A	Battery A	Battery A
Body Worn A	No	No	No	No	No	No
Body Worn B	No	No	No	No	No	No
Body Worn C	No	No	No	No	No	No
Body Worn D	No	No	No	No	No	No
Body Worn E	No	No	No	No	No	No
Body Worn F	No	No	No	No	No	No
Body Worn G	No	No	No	No	No	No

### Radio Body Test

Audio Accessory	Antenna H					
	Audio Acc'y M	Audio Acc'y N	Audio Acc'y O	Audio Acc'y P	Audio Acc'y Q	Audio Acc'y R
	Battery A	Battery A	Battery A	Battery A	Battery A	Battery A
Body Worn A	No	No	No	No	No	No
Body Worn B	No	No	No	No	No	No
Body Worn C	No	No	No	No	No	No
Body Worn D	No	No	No	No	No	No
Body Worn E	No	No	No	No	No	No
Body Worn F	No	No	No	No	No	No
Body Worn G	No	No	No	No	No	No

### Radio Body Test

Audio Accessory	Antenna H			
	Audio Acc'y S	Audio Acc'y T	Audio Acc'y U	Audio Acc'y V
	Battery A	Battery A	Battery A	Battery A
Body Worn A	No	No	No	No
Body Worn B	No	No	No	No
Body Worn C	No	No	No	No
Body Worn D	No	No	No	No
Body Worn E	No	No	No	No
Body Worn F	No	No	No	No
Body Worn G	No	No	No	No

### Radio Body Test

Audio Accessory	Antenna I					
	Audio Acc'y A	Audio Acc'y B	Audio Acc'y C	Audio Acc'y D	Audio Acc'y E	Audio Acc'y F
	Battery A	Battery A	Battery A	Battery A	Battery A	Battery A
Body Worn A	No	No	No	Yes	No	No
Body Worn B	No	No	No	No	No	No
Body Worn C	No	No	No	No	No	No
Body Worn D	No	No	No	No	No	No
Body Worn E	No	No	No	No	No	No
Body Worn F	No	No	No	No	No	No
Body Worn G	No	No	No	No	No	No

### Radio Body Test

Audio Accessory	Antenna I					
	Audio Acc'y G	Audio Acc'y H	Audio Acc'y I	Audio Acc'y J	Audio Acc'y K	Audio Acc'y L
	Battery A	Battery A	Battery A	Battery A	Battery A	Battery A
Body Worn A	No	No	No	No	No	No
Body Worn B	No	No	No	No	No	No
Body Worn C	No	No	No	No	No	No
Body Worn D	No	No	No	No	No	No
Body Worn E	No	No	No	No	No	No
Body Worn F	No	No	No	No	No	No
Body Worn G	No	No	No	No	No	No

### Radio Body Test

Audio Accessory	Antenna I					
	Audio Acc'y M	Audio Acc'y N	Audio Acc'y O	Audio Acc'y P	Audio Acc'y Q	Audio Acc'y R
	Battery A	Battery A	Battery A	Battery A	Battery A	Battery A
Body Worn A	No	No	No	No	No	No
Body Worn B	No	No	No	No	No	No
Body Worn C	No	No	No	No	No	No
Body Worn D	No	No	No	No	No	No
Body Worn E	No	No	No	No	No	No
Body Worn F	No	No	No	No	No	No
Body Worn G	No	No	No	No	No	No

### Radio Body Test

Audio Accessory	Antenna I			
	Audio Acc'y S	Audio Acc'y T	Audio Acc'y U	Audio Acc'y V
	Battery A	Battery A	Battery A	Battery A
Body Worn A	No	No	No	No
Body Worn B	No	No	No	No
Body Worn C	No	No	No	No
Body Worn D	No	No	No	No
Body Worn E	No	No	No	No
Body Worn F	No	No	No	No
Body Worn G	No	No	No	No

VHF		
Freq	Channel	Power (dB)
136	1	35.59
145	2	35.63
155	3	35.66
164	4	35.70
174	5	35.72

Per KDB 447498 D01 v05r01 page 7 section 6) pages 7-8, the number of channels required to be tested is as follows:

$F_{\text{high}} = 174$  MHz

$F_c = 155$  MHz

$F_{\text{low}} = 136$  MHz

$$N_c = \text{Round} \{ [100(f_{\text{high}} - f_{\text{low}})/f_c]^{0.5} \times (f_c/100)^{0.2} \} = \text{Round} \{ [100(174-136)/155]^{0.5} \times (155/100)^{0.2} \} = 5$$

Therefore, for the frequency band from 136 MHz to 174 MHz, 5 channels are required for testing.

Head SAR – In Front of Face (Handset)			
Antenna	Channel Freq. (MHz)	Battery A <sup>1</sup>	
		Measured Power (dBm)	Reported SAR (W/kg)
I <sup>1</sup>	136	35.59	0.30
	145	35.63	0.34
	155	35.66	0.43
	164	35.70	0.32
	174	35.72	0.35

<sup>1</sup>See Accessory table on page 21 of this report.

<sup>2</sup>Measurement was reduced per KDB 643646 D01 v01r01 page 2 section 1) A) I) a).

Body SAR (Handset)			
Antenna (MHz)	Channel Freq. (MHz)	Battery A <sup>1</sup>	
		Audio Accessory D <sup>1</sup>	
		Body Worn A <sup>1</sup>	
		Measured Power (W)	Reported SAR (W/kg)
I <sup>1</sup>	136	35.59	<sup>2</sup>
	145	35.63	<sup>2</sup>
	155	35.66	0.19
	164	35.70	<sup>2</sup>
	174	35.72	<sup>2</sup>

<sup>1</sup>See Accessory table on page 21 of this report.

<sup>2</sup>Measurement was reduced per KDB 643646 D01 v01r01 page 5 section 1) A) I) a).

<sup>1</sup>See Accessory table on page 21 of this report.

<sup>2</sup>Measurement was reduced per KDB 643646 D01 v01r01 page 5 section 1) A) I) a).

## 10. 3G Measurement Procedures

Power measurements were performed using a base station simulator under average power.

### 10.1 Procedures Used to Establish RF Signal for SAR

The device was placed into a simulated call using a base station simulator in a screen room. Such test signals offer a consistent means for testing SAR and recommended for evaluating SAR. The SAR measurement software calculates a reference point at the start and end of the test to check for power drifts. If conducted power deviations of more than 5% occurred, the tests were repeated.

### 10.2 SAR Measurement Conditions for WCDMA/HSDPA/HSUPA

Configure the call box 8960 to support all WCDMA tests in respect to the 3GPP 34.121 (listed in Table below). Measure the power at Ch4132, 4182 and 4233 for US cell; Ch9262, 9400 and 9538 for US PCS band.

For Rel99

- Set a Test Mode 1 loop back with a 12.2kbps Reference Measurement Channel (RMC).
- Set and send continuously Up power control commands to the device
- Measure the power at the device antenna connector using the power meter with average detector.

For HSDPA Rel 6

- Establish a Test Mode 1 loop back with both 1 12.2kbps RMC channel and a H-Set1 Fixed Reference Channel (FRC). With the 8960 this is accomplished by setting the signal Channel Coding to "Fixed Reference Channel" and configuring for HSET-1 QKSP.
- Set beta values and HSDPA settings for HSDPA Subtest1 according to Table below.
- Send continuously Up power control commands to the device
- Measure the power at the device antenna connector using the power meter with modulated average detector.
- Repeat the measurement for the HSDPA Subtest2, 3 and 4 as given in Table below.

For HSUPA Rel 6

- Use UL RMC 12.2kbps and FRC H-Set1 QPSK, Test Mode 1 loop back. With the 8960 this is accomplished by setting the signal Channel Coding to "E-DCH Test Channel" and configuring the equipment category to Cat5\_10ms.
- Set the Absolute Grant for HSUPA Subtest1 according to Table below.
- Set the device power to be at least 5dB lower than the Maximum output power
- Send power control bits to give one TPC\_cmd = +1 command to the device. If device doesn't send any E-DPCH data with decreased E-TFCl within 500ms, then repeat this process until the decreased E-TFCl is reported.
- Confirm that the E-TFCl transmitted by the device is equal to the target E-TFCl in Table below. If the E-TFCl transmitted by the device is not equal to the target E-TFCl, then send power control bits to give one TPC\_cmd = -1 command to the UE. If UE sends any E-DPCH data with decreased E-TFCl within 500 ms, send new power control bits to give one TPC\_cmd = -1 command to the UE. Then confirm that the E-TFCl transmitted by the UE is equal to the target E-TFCl in Table below.
- Measure the power using the power meter with modulated average detector.
- Repeat the measurement for the HSUPA Subtest2, 3, 4 and 5 as given in Table below.

3GPP Release Version	Mode	835 MHz Band [dBm]			Sub-Test (See Table Below)	MPR
		4132	4183	4233		
99	WCDMA	23.69	23.94	23.64	-	-
6	HSDPA	23.66	23.79	23.90	1	0
6		23.62	23.97	23.88	2	0
6		23.16	23.26	23.18	3	0.5
6		23.29	23.13	23.50	4	0.5
6	HSUPA	23.68	23.80	23.89	1	0
6		21.51	21.76	21.83	2	2
6		22.90	22.64	22.72	3	1
6		21.59	21.81	21.94	4	2
6		23.85	23.71	23.81	5	0

3GPP Release Version	Mode	1900 MHz Band [dBm]			Sub-Test (See Table Below)	MPR
		9262	9400	9538		
99	WCDMA	23.82	23.87	23.85	-	-
6	HSDPA	23.54	23.88	23.51	1	0
6		23.66	23.93	23.56	2	0
6		23.17	23.48	23.41	3	0.5
6		23.09	23.12	23.21	4	0.5
6	HSUPA	24.00	23.78	23.85	1	0
6		21.52	21.51	21.54	2	2
6		22.78	22.50	22.68	3	1
6		21.59	21.67	21.59	4	2
6		23.67	23.70	23.99	5	0

### Sub-Test Setup for Release 6 HSDPA

Sub-Test	$\beta_c$	$\beta_d$	$B_c / \beta_d$	$\beta_{hs}$
1	2/15	15/15	2/15	4/15
2	12/15	15/15	15/15	24/15
3	15/15	8/15	15/8	30/15
4	15/15	4/15	15/4	30/15

$\Delta_{ack}, \Delta_{nack}$  and  $\Delta_{cqi} = 8$

### Sub-Test Setup for Release 6 HSUPA

Sub-Test	$\beta_c$	$\beta_d$	$B_c / \beta_d$	$\beta_{hs}$	$B_{ec}$	$B_{ed}$	MPR	AG Index	E-TFCI
1	11/15	15/15	11/15	22/15	209/225	1039/225	0.0	20	75
2	6/15	15/15	6/15	12/15	12/15	94/75	2.0	12	67
3	15/15	9/15	15/9	30/15	30/15	47/15	1.0	15	92
4	2/15	15/15	2/15	4/15	2/15	56/15	2.0	17	71
5	15/15	15/15	15/15	30/15	24/15	134/15	0.0	21	81

$\Delta_{ack}, \Delta_{nack}$  and  $\Delta_{cqi} = 8$

**Figure 10.1 Test Reduction Table – WCDMA**

Band/ Frequency (MHz)	Technology	Side	Required Channel	Tested/ Reduced	
Band 2 1850-1910 MHz	WCDMA	Face	9262	Tested	
			9400	Tested	
			9538	Tested	
		Body	9262	Reduced <sup>1</sup>	
			9400	Tested	
			9538	Reduced <sup>1</sup>	
Band 5 824-849 MHz		WCDMA	Face	4132	Reduced <sup>1</sup>
				4183	Tested
				4233	Reduced <sup>1</sup>
			Body	4132	Tested
				4183	Tested
				4233	Tested

Reduced<sup>1</sup> – When the mid channel is 3 dB below the limit, the remaining channels are not required KDB447498 D01 v06.

## 10.3 SAR Measurement Conditions for LTE Bands

### 10.3.1 LTE Functionality

The follow table identifies all the channel bandwidths in each frequency band supported by this device.

LTE Band Class	Bandwidth (MHz)	Frequency or Freq. Band (MHz)
2	1.4, 3, 5, 10, 15, 20	1850-1910 MHz
4	1.4, 3, 5, 10, 15, 20	1710-1755 MHz
12	1.4, 3, 5, 10	699-716 MHz

### 10.3.2 Test Conditions

All SAR measurements for LTE were performed using the Anritsu MT8820C. A closed loop power control setting allowed the UE to transmit at the maximum output power during the SAR measurements. The Figure 11.1 table indicates all the test reduction utilized for this report.

MPR was enabled for this device. A-MPR was disabled for all SAR test measurements.



Table 10.3.2.1 LTE Power Measurements

Band	Modulation	Bandwidth	RB Size	RB Offset	Channel	Frequency	Power	
2	QPSK	1.4 MHz	1	0	18607	1850.7	23.3	
					18900	1880.0	23.8	
					19193	1909.3	23.8	
				3	18607	1850.7	23.6	
					18900	1880.0	23.9	
					19193	1909.3	23.9	
				5	18607	1850.7	23.6	
					18900	1880.0	23.4	
					19193	1909.3	23.6	
			3	0	18607	1850.7	23.7	
					18900	1880.0	24.0	
					19193	1909.3	23.6	
				1	18607	1850.7	23.6	
					18900	1880.0	23.7	
					19193	1909.3	23.7	
				3	18607	1850.7	23.4	
					18900	1880.0	24.0	
					19193	1909.3	23.4	
			6	0	18607	1850.7	22.8	
					18900	1880.0	22.4	
					19193	1909.3	22.3	
			3 MHz	1	0	18615	1851.5	23.7
						18900	1880.0	23.9
						19185	1908.5	23.8
		7			18615	1851.5	24.0	
					18900	1880.0	23.5	
					19185	1908.5	23.6	
		14			18615	1851.5	23.4	
					18900	1880.0	23.5	
					19185	1908.5	23.5	
		8			0	18615	1851.5	22.5
						18900	1880.0	22.6
						19185	1908.5	22.4
				3	18615	1851.5	22.9	
					18900	1880.0	22.9	
					19185	1908.5	22.7	
				7	18615	1851.5	22.7	
					18900	1880.0	22.6	
					19185	1908.5	22.4	
				15	0	18615	1851.5	22.7
						18900	1880.0	22.8
						19185	1908.5	22.4

Band	Modulation	Bandwidth	RB Size	RB Offset	Channel	Frequency	Power
2	QPSK	5 MHz	1	0	18625	1852.5	23.8
					18900	1880.0	23.4
					19175	1907.5	23.5
				12	18625	1852.5	23.4
					18900	1880.0	23.7
					19175	1907.5	23.6
			24	18625	1852.5	23.4	
				18900	1880.0	23.3	
				19175	1907.5	23.6	
			12	0	18625	1852.5	22.9
					18900	1880.0	22.8
					19175	1907.5	22.4
				6	18625	1852.5	22.7
					18900	1880.0	22.9
					19175	1907.5	22.9
				13	18625	1852.5	22.7
					18900	1880.0	22.8
					19175	1907.5	22.6
		25	0	18625	1852.5	22.4	
				18900	1880.0	22.5	
				19175	1907.5	22.4	
		10 MHz	1	0	18650	1855.0	23.8
					18900	1880.0	23.8
					19150	1905.0	23.6
				24	18650	1855.0	23.5
					18900	1880.0	23.4
					19150	1905.0	23.7
			49	18650	1855.0	23.7	
				18900	1880.0	24.0	
				19150	1905.0	23.6	
			25	0	18650	1855.0	22.6
					18900	1880.0	23.0
					19150	1905.0	22.7
				13	18650	1855.0	22.5
					18900	1880.0	22.8
					19150	1905.0	22.8
				25	18650	1855.0	22.6
					18900	1880.0	22.8
					19150	1905.0	22.9
		50	0	18650	1855.0	23.0	
				18900	1880.0	22.7	
				19150	1905.0	22.6	

Band	Modulation	Bandwidth	RB Size	RB Offset	Channel	Frequency	Power
2	QPSK	15 MHz	1	0	18675	1857.5	23.5
					18900	1880.0	23.3
					19125	1902.5	23.7
				37	18675	1857.5	23.4
					18900	1880.0	23.4
					19125	1902.5	23.5
				74	18675	1857.5	23.8
					18900	1880.0	23.8
					19125	1902.5	23.9
			36	0	18675	1857.5	22.7
					18900	1880.0	22.5
					19125	1902.5	22.7
				19	18675	1857.5	22.3
					18900	1880.0	22.8
					19125	1902.5	22.4
				39	18675	1857.5	22.7
					18900	1880.0	22.8
					19125	1902.5	22.5
		75	0	18675	1857.5	22.6	
				18900	1880.0	22.4	
				19125	1902.5	22.8	
		20 MHz	1	0	18700	1860.0	23.5
					18900	1880.0	23.8
					19100	1900.0	23.3
				49	18700	1860.0	23.9
					18900	1880.0	23.7
					19100	1900.0	23.5
				99	18700	1860.0	23.4
					18900	1880.0	23.9
					19100	1900.0	23.9
			50	0	18700	1860.0	22.8
					18900	1880.0	22.4
					19100	1900.0	22.7
				24	18700	1860.0	22.7
					18900	1880.0	22.9
					19100	1900.0	22.4
				50	18700	1860.0	22.8
					18900	1880.0	22.5
					19100	1900.0	22.6
			100	0	18700	1860.0	22.9
					18900	1880.0	22.7
					19100	1900.0	22.5

Band	Modulation	Bandwidth	RB Size	RB Offset	Channel	Frequency	Power
2	16QAM	1.4 MHz	1	0	18607	1850.7	22.6
					18900	1880.0	22.6
					19193	1909.3	22.6
				3	18607	1850.7	22.9
					18900	1880.0	22.9
					19193	1909.3	22.6
				5	18607	1850.7	22.9
					18900	1880.0	22.3
					19193	1909.3	22.5
			3	0	18607	1850.7	22.4
					18900	1880.0	23.0
					19193	1909.3	22.4
				1	18607	1850.7	22.3
					18900	1880.0	22.4
					19193	1909.3	22.4
				3	18607	1850.7	22.9
					18900	1880.0	23.0
					19193	1909.3	22.3
		6	0	18607	1850.7	21.5	
				18900	1880.0	22.0	
				19193	1909.3	21.3	
		3 MHz	1	0	18615	1851.5	22.7
					18900	1880.0	22.5
					19185	1908.5	22.3
				7	18615	1851.5	22.6
					18900	1880.0	23.0
					19185	1908.5	22.8
				14	18615	1851.5	22.3
					18900	1880.0	23.0
					19185	1908.5	22.8
			8	0	18615	1851.5	21.4
					18900	1880.0	21.4
					19185	1908.5	21.7
				3	18615	1851.5	21.4
					18900	1880.0	21.9
					19185	1908.5	21.7
				7	18615	1851.5	21.8
					18900	1880.0	21.9
					19185	1908.5	21.8
		15	0	18615	1851.5	21.8	
				18900	1880.0	21.8	
				19185	1908.5	21.6	

Band	Modulation	Bandwidth	RB Size	RB Offset	Channel	Frequency	Power
2	16QAM	5 MHz	1	0	18625	1852.5	22.5
					18900	1880.0	22.5
					19175	1907.5	22.9
				12	18625	1852.5	23.0
					18900	1880.0	22.5
					19175	1907.5	22.7
			24	18625	1852.5	22.4	
				18900	1880.0	22.9	
				19175	1907.5	22.6	
			12	0	18625	1852.5	21.8
					18900	1880.0	21.4
					19175	1907.5	21.8
				6	18625	1852.5	22.0
					18900	1880.0	21.5
					19175	1907.5	21.3
				13	18625	1852.5	21.8
					18900	1880.0	21.5
					19175	1907.5	21.3
		25	0	18625	1852.5	21.9	
				18900	1880.0	21.8	
				19175	1907.5	21.7	
		10 MHz	1	0	18650	1855.0	22.9
					18900	1880.0	22.8
					19150	1905.0	22.5
				24	18650	1855.0	22.5
					18900	1880.0	22.5
					19150	1905.0	22.4
				49	18650	1855.0	22.6
					18900	1880.0	22.9
					19150	1905.0	22.7
			25	0	18650	1855.0	22.0
					18900	1880.0	21.4
					19150	1905.0	21.8
				13	18650	1855.0	21.5
					18900	1880.0	22.0
					19150	1905.0	21.5
				25	18650	1855.0	21.7
					18900	1880.0	22.0
					19150	1905.0	21.8
			50	0	18650	1855.0	21.4
					18900	1880.0	21.6
					19150	1905.0	21.7

Band	Modulation	Bandwidth	RB Size	RB Offset	Channel	Frequency	Power
2	16QAM	15 MHz	1	0	18675	1857.5	23.0
					18900	1880.0	22.7
					19125	1902.5	22.6
				37	18675	1857.5	22.7
					18900	1880.0	22.9
					19125	1902.5	22.7
				74	18675	1857.5	22.7
					18900	1880.0	22.6
					19125	1902.5	23.0
			36	0	18675	1857.5	21.9
					18900	1880.0	21.8
					19125	1902.5	21.4
				19	18675	1857.5	21.6
					18900	1880.0	21.9
					19125	1902.5	21.8
				39	18675	1857.5	21.9
					18900	1880.0	21.5
					19125	1902.5	21.8
		75	0	18675	1857.5	21.3	
				18900	1880.0	21.5	
				19125	1902.5	21.4	
		20 MHz	1	0	18700	1860.0	22.6
					18900	1880.0	22.7
					19100	1900.0	22.5
				49	18700	1860.0	22.4
					18900	1880.0	22.7
					19100	1900.0	23.0
				99	18700	1860.0	22.3
					18900	1880.0	23.0
					19100	1900.0	22.5
			50	0	18700	1860.0	22.0
					18900	1880.0	21.8
					19100	1900.0	21.5
				24	18700	1860.0	21.6
					18900	1880.0	21.7
					19100	1900.0	21.7
				50	18700	1860.0	21.3
					18900	1880.0	21.4
					19100	1900.0	21.6
			100	0	18700	1860.0	21.3
					18900	1880.0	21.4
					19100	1900.0	21.7

Band	Modulation	Bandwidth	RB Size	RB Offset	Channel	Frequency	Power		
4	QPSK	1.4 MHz	1	0	19957	1710.7	23.5		
					20175	1732.5	24.0		
					20393	1754.3	23.7		
				3	3	19957	1710.7	23.4	
						20175	1732.5	23.4	
						20393	1754.3	23.4	
					5	5	19957	1710.7	23.3
							20175	1732.5	23.4
							20393	1754.3	23.4
			3	0	19957	1710.7	23.9		
					20175	1732.5	23.9		
					20393	1754.3	23.7		
				1	1	19957	1710.7	23.7	
						20175	1732.5	23.7	
						20393	1754.3	23.9	
					3	3	19957	1710.7	24.0
							20175	1732.5	23.3
							20393	1754.3	23.8
			6	0	19957	1710.7	22.5		
					20175	1732.5	22.6		
					20393	1754.3	22.9		
			3 MHz	1	0	19965	1711.5	24.0	
						20175	1732.5	23.7	
						20385	1753.5	23.4	
		7				19965	1711.5	23.4	
						20175	1732.5	23.7	
						20385	1753.5	23.5	
		14			19965	1711.5	23.9		
					20175	1732.5	23.6		
					20385	1753.5	23.9		
					8	0	19965	1711.5	22.7
							20175	1732.5	22.7
							20385	1753.5	22.6
		3		19965		1711.5	22.9		
				20175		1732.5	22.3		
				20385		1753.5	22.6		
		7		19965	1711.5	22.6			
				20175	1732.5	22.9			
				20385	1753.5	22.4			
				15	0	19965	1711.5	22.5	
						20175	1732.5	22.9	
						20385	1753.5	22.7	

Band	Modulation	Bandwidth	RB Size	RB Offset	Channel	Frequency	Power	
4	QPSK	5 MHz	1	0	19975	1712.5	23.4	
					20175	1732.5	23.6	
					20375	1752.5	23.9	
				12	19975	1712.5	23.7	
					20175	1732.5	23.4	
					20375	1752.5	23.8	
			24	19975	1712.5	23.9		
				20175	1732.5	23.7		
				20375	1752.5	23.7		
			12	0	19975	1712.5	22.8	
					20175	1732.5	23.0	
					20375	1752.5	22.6	
				6	19975	1712.5	22.3	
					20175	1732.5	22.6	
					20375	1752.5	22.8	
				13	19975	1712.5	22.5	
					20175	1732.5	22.5	
					20375	1752.5	22.4	
			25	0	19975	1712.5	22.5	
					20175	1732.5	22.6	
					20375	1752.5	22.9	
			10 MHz	1	0	20000	1715.0	23.9
						20175	1732.5	23.5
						20350	1750.0	23.5
		24			20000	1715.0	23.5	
					20175	1732.5	23.9	
					20350	1750.0	23.4	
		49		20000	1715.0	23.9		
				20175	1732.5	23.8		
				20350	1750.0	23.6		
		25		0	20000	1715.0	23.0	
					20175	1732.5	22.4	
					20350	1750.0	22.4	
				13	20000	1715.0	22.7	
					20175	1732.5	22.4	
					20350	1750.0	22.5	
				25	20000	1715.0	22.8	
					20175	1732.5	22.6	
					20350	1750.0	22.9	
		50		0	20000	1715.0	22.8	
					20175	1732.5	22.4	
					20350	1750.0	22.8	



Band	Modulation	Bandwidth	RB Size	RB Offset	Channel	Frequency	Power	
4	QPSK	15 MHz	1	0	20025	1717.5	23.9	
					20175	1732.5	23.6	
					20325	1747.5	23.8	
				37	20025	1717.5	23.9	
					20175	1732.5	23.6	
					20325	1747.5	23.6	
				74	20025	1717.5	23.4	
					20175	1732.5	23.3	
					20325	1747.5	23.4	
			36	0	20025	1717.5	22.7	
					20175	1732.5	22.5	
					20325	1747.5	22.7	
				19	20025	1717.5	22.4	
					20175	1732.5	23.0	
					20325	1747.5	22.5	
				39	20025	1717.5	22.7	
					20175	1732.5	22.9	
					20325	1747.5	22.5	
			75	0	20025	1717.5	22.7	
					20175	1732.5	22.8	
					20325	1747.5	22.7	
			20 MHz	1	0	20050	1720.0	23.6
						20175	1732.5	23.3
						20300	1745.0	23.5
		49			20050	1720.0	23.4	
					20175	1732.5	23.8	
					20300	1745.0	23.6	
		99			20050	1720.0	23.9	
					20175	1732.5	23.4	
					20300	1745.0	23.5	
		50		0	20050	1720.0	22.9	
					20175	1732.5	22.6	
					20300	1745.0	22.3	
				24	20050	1720.0	22.4	
					20175	1732.5	22.5	
					20300	1745.0	22.8	
				50	20050	1720.0	22.7	
					20175	1732.5	22.9	
					20300	1745.0	22.6	
		100		0	20050	1720.0	22.9	
					20175	1732.5	22.7	
					20300	1745.0	22.5	

Band	Modulation	Bandwidth	RB Size	RB Offset	Channel	Frequency	Power
4	16QAM	1.4 MHz	1	0	19957	1710.7	22.3
					20175	1732.5	22.6
					20393	1754.3	22.6
				3	19957	1710.7	22.9
					20175	1732.5	22.6
					20393	1754.3	22.6
				5	19957	1710.7	22.7
					20175	1732.5	22.8
					20393	1754.3	22.9
			3	0	19957	1710.7	22.6
					20175	1732.5	22.7
					20393	1754.3	22.7
				1	19957	1710.7	22.9
					20175	1732.5	22.8
					20393	1754.3	22.4
				3	19957	1710.7	22.3
					20175	1732.5	22.8
					20393	1754.3	22.4
		6	0	19957	1710.7	21.5	
				20175	1732.5	21.5	
				20393	1754.3	21.7	
		3 MHz	1	0	19965	1711.5	23.0
					20175	1732.5	22.6
					20385	1753.5	22.6
				7	19965	1711.5	23.0
					20175	1732.5	22.6
					20385	1753.5	22.4
				14	19965	1711.5	22.9
					20175	1732.5	22.7
					20385	1753.5	22.5
			8	0	19965	1711.5	21.9
					20175	1732.5	22.0
					20385	1753.5	21.8
				3	19965	1711.5	21.5
					20175	1732.5	21.7
					20385	1753.5	21.5
7	19965			1711.5	21.6		
	20175			1732.5	21.3		
	20385			1753.5	21.4		
15	0	19965	1711.5	21.7			
		20175	1732.5	21.9			
		20385	1753.5	21.7			

Band	Modulation	Bandwidth	RB Size	RB Offset	Channel	Frequency	Power
4	16QAM	5 MHz	1	0	19975	1712.5	23.0
					20175	1732.5	22.6
					20375	1752.5	22.5
				12	19975	1712.5	22.7
					20175	1732.5	22.4
					20375	1752.5	22.9
			24	19975	1712.5	22.5	
				20175	1732.5	22.9	
				20375	1752.5	22.5	
			12	0	19975	1712.5	21.5
					20175	1732.5	21.9
					20375	1752.5	22.0
				6	19975	1712.5	21.8
					20175	1732.5	21.5
					20375	1752.5	22.0
				13	19975	1712.5	21.4
					20175	1732.5	21.5
					20375	1752.5	21.8
		25	0	19975	1712.5	21.5	
				20175	1732.5	21.4	
				20375	1752.5	21.6	
		10 MHz	1	0	20000	1715.0	22.8
					20175	1732.5	23.0
					20350	1750.0	22.9
				24	20000	1715.0	22.9
					20175	1732.5	22.9
					20350	1750.0	22.8
				49	20000	1715.0	22.5
					20175	1732.5	22.6
					20350	1750.0	22.5
			25	0	20000	1715.0	22.0
					20175	1732.5	21.8
					20350	1750.0	21.6
				13	20000	1715.0	21.3
					20175	1732.5	21.9
					20350	1750.0	21.7
				25	20000	1715.0	21.4
					20175	1732.5	21.4
					20350	1750.0	21.9
			50	0	20000	1715.0	21.6
					20175	1732.5	21.6
					20350	1750.0	21.3

Band	Modulation	Bandwidth	RB Size	RB Offset	Channel	Frequency	Power
4	16QAM	15 MHz	1	0	20025	1717.5	22.9
					20175	1732.5	22.4
					20325	1747.5	22.5
				37	20025	1717.5	22.6
					20175	1732.5	22.3
					20325	1747.5	22.3
				74	20025	1717.5	22.6
					20175	1732.5	22.5
					20325	1747.5	22.6
			36	0	20025	1717.5	21.8
					20175	1732.5	21.6
					20325	1747.5	21.5
				19	20025	1717.5	21.5
					20175	1732.5	21.6
					20325	1747.5	21.7
				39	20025	1717.5	21.4
					20175	1732.5	22.0
					20325	1747.5	22.0
		75	0	20025	1717.5	21.8	
				20175	1732.5	21.3	
				20325	1747.5	21.4	
		20 MHz	1	0	20050	1720.0	22.5
					20175	1732.5	22.9
					20300	1745.0	22.8
				49	20050	1720.0	22.3
					20175	1732.5	22.8
					20300	1745.0	23.0
				99	20050	1720.0	22.7
					20175	1732.5	22.9
					20300	1745.0	22.8
			50	0	20050	1720.0	21.6
					20175	1732.5	22.0
					20300	1745.0	21.7
				24	20050	1720.0	21.4
					20175	1732.5	21.9
					20300	1745.0	21.8
50	20050			1720.0	21.8		
	20175			1732.5	22.0		
	20300			1745.0	21.5		
100	0	20050	1720.0	21.4			
		20175	1732.5	21.9			
		20300	1745.0	21.9			

Band	Modulation	Bandwidth	RB Size	RB Offset	Channel	Frequency	Power	
12	QPSK	1.4 MHz	1	0	23017	699.7	23.9	
					23095	707.5	23.9	
					23173	715.3	23.4	
				3	23017	699.7	23.5	
					23095	707.5	23.5	
					23173	715.3	23.9	
				5	23017	699.7	23.9	
					23095	707.5	23.9	
					23173	715.3	24.0	
			3	0	23017	699.7	23.8	
					23095	707.5	23.3	
					23173	715.3	23.7	
				1	23017	699.7	23.8	
					23095	707.5	23.8	
					23173	715.3	23.9	
				3	23017	699.7	24.0	
					23095	707.5	23.5	
					23173	715.3	23.3	
			6	0	23017	699.7	22.5	
					23095	707.5	23.0	
					23173	715.3	22.6	
			3 MHz	1	0	23025	700.5	23.4
						23095	707.5	23.7
						23165	714.5	23.3
		7			23025	700.5	23.5	
					23095	707.5	23.5	
					23165	714.5	23.3	
		14			23025	700.5	23.5	
					23095	707.5	23.5	
					23165	714.5	23.4	
		8		0	23025	700.5	22.4	
					23095	707.5	22.6	
					23165	714.5	22.5	
				3	23025	700.5	22.5	
					23095	707.5	22.9	
					23165	714.5	22.6	
				7	23025	700.5	22.9	
					23095	707.5	22.6	
					23165	714.5	22.4	
		15		0	23025	700.5	22.9	
					23095	707.5	22.6	
					23165	714.5	22.8	

Band	Modulation	Bandwidth	RB Size	RB Offset	Channel	Frequency	Power	
12	QPSK	5 MHz	1	0	23035	701.5	23.9	
					23095	707.5	23.5	
					23155	713.5	23.6	
				12	23035	701.5	23.4	
					23095	707.5	23.8	
					23155	713.5	23.7	
				24	23035	701.5	23.7	
					23095	707.5	23.5	
					23155	713.5	23.9	
			12	0	23035	701.5	22.9	
					23095	707.5	22.5	
					23155	713.5	22.8	
				6	23035	701.5	22.9	
					23095	707.5	22.6	
					23155	713.5	22.7	
				13	23035	701.5	22.3	
					23095	707.5	23.0	
					23155	713.5	23.0	
			25	0	23035	701.5	22.3	
					23095	707.5	23.0	
					23155	713.5	22.6	
			10 MHz	1	0	23060	704.0	23.5
						23095	707.5	23.3
						23130	711.0	23.6
		24			23060	704.0	23.5	
					23095	707.5	23.9	
					23130	711.0	23.5	
		49			23060	704.0	24.0	
					23095	707.5	23.8	
					23130	711.0	23.6	
		25		0	23060	704.0	22.5	
					23095	707.5	22.9	
					23130	711.0	22.7	
				13	23060	704.0	22.6	
					23095	707.5	22.3	
					23130	711.0	22.9	
				25	23060	704.0	22.6	
					23095	707.5	22.6	
					23130	711.0	22.7	
		50		0	23060	704.0	22.7	
					23095	707.5	22.9	
					23130	711.0	22.8	

Band	Modulation	Bandwidth	RB Size	RB Offset	Channel	Frequency	Power
12	16QAM	1.4 MHz	1	0	23017	699.7	22.5
					23095	707.5	22.4
					23173	715.3	22.3
				3	23017	699.7	22.8
					23095	707.5	22.9
					23173	715.3	22.5
			5	23017	699.7	22.4	
				23095	707.5	22.7	
				23173	715.3	22.6	
			3	0	23017	699.7	22.5
					23095	707.5	22.7
					23173	715.3	22.6
				1	23017	699.7	22.5
					23095	707.5	22.9
					23173	715.3	22.4
				3	23017	699.7	22.8
					23095	707.5	22.4
					23173	715.3	23.0
		6	0	23017	699.7	21.9	
				23095	707.5	21.7	
				23173	715.3	21.5	
		3 MHz	1	0	23025	700.5	22.7
					23095	707.5	22.9
					23165	714.5	22.6
				7	23025	700.5	22.7
					23095	707.5	22.6
					23165	714.5	22.5
			14	23025	700.5	22.5	
				23095	707.5	23.0	
				23165	714.5	22.7	
			8	0	23025	700.5	21.4
					23095	707.5	21.4
					23165	714.5	21.4
				3	23025	700.5	21.9
					23095	707.5	21.8
					23165	714.5	21.8
				7	23025	700.5	21.4
					23095	707.5	22.0
					23165	714.5	21.6
		15	0	23025	700.5	22.0	
				23095	707.5	21.4	
				23165	714.5	21.3	

Band	Modulation	Bandwidth	RB Size	RB Offset	Channel	Frequency	Power
12	16QAM	5 MHz	1	0	23035	701.5	22.5
					23095	707.5	22.7
					23155	713.5	22.7
				12	23035	701.5	23.0
					23095	707.5	23.0
					23155	713.5	22.7
			24	23035	701.5	22.5	
				23095	707.5	22.7	
				23155	713.5	22.4	
			12	0	23035	701.5	21.4
					23095	707.5	21.8
					23155	713.5	21.7
				6	23035	701.5	21.9
					23095	707.5	21.9
					23155	713.5	21.9
				13	23035	701.5	21.5
					23095	707.5	21.4
					23155	713.5	21.6
		25	0	23035	701.5	21.7	
				23095	707.5	21.6	
				23155	713.5	21.7	
		10 MHz	1	0	23060	704.0	22.5
					23095	707.5	22.9
					23130	711.0	22.5
				24	23060	704.0	22.9
					23095	707.5	22.5
					23130	711.0	22.8
			49	23060	704.0	23.0	
				23095	707.5	22.3	
				23130	711.0	23.0	
			25	0	23060	704.0	21.9
					23095	707.5	21.7
					23130	711.0	21.4
				13	23060	704.0	21.3
					23095	707.5	21.7
					23130	711.0	21.4
				25	23060	704.0	21.8
					23095	707.5	21.7
					23130	711.0	21.4
		50	0	23060	704.0	21.7	
				23095	707.5	21.7	
				23130	711.0	21.4	



**Table 10.3.2.2 Test Reduction Table – LTE**

Band/ Frequency (MHz)	Pos.	Required Test Channel	Bandwidth	Modulation	RB Allocation	RB Offset	Tested/ Reduced	
Band 2 1850-1910 MHz	Face	18700	20 MHz	QPSK	50	24	Reduced <sup>6</sup>	
		18900					Tested	
		19100					Reduced <sup>6</sup>	
		18700			100	0	Reduced <sup>1</sup>	
		18900					Reduced <sup>1</sup>	
		19100					Reduced <sup>1</sup>	
		18700			1	0	Reduced <sup>2</sup>	
		18900					Reduced <sup>2</sup>	
		19100					Reduced <sup>2</sup>	
		18700		49	0	Tested		
		18900				Tested		
		19100				Tested		
		18700		16QAM	50	24	Reduced <sup>3</sup>	
		18900					Reduced <sup>3</sup>	
		19100					Reduced <sup>3</sup>	
		18700			100	0	Reduced <sup>1</sup>	
		18900					Reduced <sup>1</sup>	
		19100					Reduced <sup>1</sup>	
		18700			1	0	Reduced <sup>4</sup>	
		18900					Reduced <sup>4</sup>	
		19100					Reduced <sup>4</sup>	
	18700	49	0	Reduced <sup>4</sup>				
	18900			Reduced <sup>4</sup>				
	19100			Reduced <sup>4</sup>				
	All lower bandwidths (15 MHz, 10 MHz, 5 MHz, 3 MHz, 1.4 MHz)							Reduced <sup>5</sup>
	Back	Back	18700	20 MHz	QPSK	50	24	Reduced <sup>6</sup>
			18900					Tested
			19100					Reduced <sup>6</sup>
			18700			100	0	Reduced <sup>1</sup>
			18900					Reduced <sup>1</sup>
			19100					Reduced <sup>1</sup>
			18700			1	0	Reduced <sup>2</sup>
			18900					Reduced <sup>2</sup>
			19100					Reduced <sup>2</sup>
			18700		49	0	Reduced <sup>6</sup>	
			18900				Tested	
			19100				Reduced <sup>6</sup>	
			18700		16QAM	50	24	Reduced <sup>3</sup>
			18900					Reduced <sup>3</sup>
			19100					Reduced <sup>3</sup>
			18700			100	0	Reduced <sup>1</sup>
			18900					Reduced <sup>1</sup>
19100			Reduced <sup>1</sup>					
18700			1			0	Reduced <sup>4</sup>	
18900							Reduced <sup>4</sup>	
19100							Reduced <sup>4</sup>	
18700	49	0	Reduced <sup>4</sup>					
18900			Reduced <sup>4</sup>					
19100			Reduced <sup>4</sup>					
All lower bandwidths (15 MHz, 10 MHz, 5 MHz, 3 MHz, 1.4 MHz)							Reduced <sup>7</sup>	

Reduced<sup>1</sup> – If the SAR value in the 50% RB testing is less than 1.45 W/kg, the 100% RB testing is reduced per KDB941225 D05 v02r05.

Reduced<sup>2</sup> - If the SAR value in the 1 RB testing is less than 1.45 W/kg, the remaining channels are reduced per KDB941225 D05 v02r05.

Reduced<sup>3</sup> - If the SAR value in the 50% RB testing is less than 1.45 W/kg, the remaining channels are reduced per KDB941225 D05 v02r05.

Reduced<sup>4</sup>- If the SAR value in the 1 RB testing is less than 1.45 W/kg, the remaining channels are reduced per KDB941225 D05 v02r05.

Reduced<sup>5</sup>- If the conducted power is within ±0.5 dB, all testing where the SAR value is less than 1.45 W/kg is reduced per KDB941225 D05 v02r05.

Reduced<sup>6</sup>- If the SAR value measured on the middle channel is less than 0.8 W/kg and the conducted power is within ±0.5 dB, the remaining channels are reduced per KDB941225 D05 v02r05.

Reduced<sup>7</sup> - The remaining sides are not used next to the body.

Band/ Frequency (MHz)	Pos.	Required Test Channel	Bandwidth	Modulation	RB Allocation	RB Offset	Tested/ Reduced		
Band 4 1710-1755 MHz	Face	20050	20 MHz	QPSK	50	24	Reduced <sup>6</sup>		
		20175					Tested		
		20300					Reduced <sup>6</sup>		
		20050			100	0	Reduced <sup>1</sup>		
		20175					Reduced <sup>1</sup>		
		20300					Reduced <sup>1</sup>		
		20050			1	0	Reduced <sup>2</sup>		
		20175					Reduced <sup>2</sup>		
		20300					Reduced <sup>2</sup>		
		20050			1	49	Tested		
		20175					Tested		
		20300					Tested		
		20050			50	24	16QAM	Reduced <sup>3</sup>	
		20175						Reduced <sup>3</sup>	
		20300		Reduced <sup>3</sup>					
		20050		100	0	Reduced <sup>1</sup>			
		20175				Reduced <sup>1</sup>			
		20300				Reduced <sup>1</sup>			
		20050		1	0	Reduced <sup>4</sup>			
		20175				Reduced <sup>4</sup>			
		20300				Reduced <sup>4</sup>			
	20050	1	49	Reduced <sup>4</sup>					
	20175			Reduced <sup>4</sup>					
	20300			Reduced <sup>4</sup>					
	All lower bandwidths (15 MHz, 10 MHz, 5 MHz, 3 MHz, 1.4 MHz)							Reduced <sup>5</sup>	
	Back	Back	20050	20 MHz	QPSK	50	24	Reduced <sup>6</sup>	
			20175					Tested	
			20300					Reduced <sup>6</sup>	
			20050			100	0	Reduced <sup>1</sup>	
			20175					Reduced <sup>1</sup>	
			20300					Reduced <sup>1</sup>	
			20050			1	0	Reduced <sup>2</sup>	
			20175					Reduced <sup>2</sup>	
			20300					Reduced <sup>2</sup>	
			20050			1	49	Reduced <sup>6</sup>	
			20175					Tested	
			20300					Reduced <sup>6</sup>	
			20050			50	24	16QAM	Reduced <sup>3</sup>
			20175						Reduced <sup>3</sup>
			20300		Reduced <sup>3</sup>				
			20050		100	0	Reduced <sup>1</sup>		
			20175				Reduced <sup>1</sup>		
20300			Reduced <sup>1</sup>						
20050			1		0	Reduced <sup>4</sup>			
20175						Reduced <sup>4</sup>			
20300						Reduced <sup>4</sup>			
20050	1	49	Reduced <sup>4</sup>						
20175			Reduced <sup>4</sup>						
20300			Reduced <sup>4</sup>						
All lower bandwidths (15 MHz, 10 MHz, 5 MHz, 3 MHz, 1.4 MHz)							Reduced <sup>7</sup>		

Reduced<sup>1</sup> – If the SAR value in the 50% RB testing is less than 1.45 W/kg, the 100% RB testing is reduced per KDB941225 D05 v02r05.

Reduced<sup>2</sup> - If the SAR value in the 1 RB testing is less than 1.45 W/kg, the remaining channels are reduced per KDB941225 D05 v02r05.

Reduced<sup>3</sup> - If the SAR value in the 50% RB testing is less than 1.45 W/kg, the remaining channels are reduced per KDB941225 D05 v02r05.

Reduced<sup>4</sup>- If the SAR value in the 1 RB testing is less than 1.45 W/kg, the remaining channels are reduced per KDB941225 D05 v02r05.

Reduced<sup>5</sup>- If the conducted power is within ±0.5 dB, all testing where the SAR value is less than 1.45 W/kg is reduced per KDB941225 D05 v02r05.

Reduced<sup>6</sup>- If the SAR value measured on the middle channel is less than 0.8 W/kg and the conducted power is within ±0.5 dB, the remaining channels are reduced per KDB941225 D05 v02r05.

Reduced<sup>7</sup> - The remaining sides are not used next to the body.

Band/ Frequency (MHz)	Pos.	Required Test Channel	Bandwidth	Modulation	RB Allocation	RB Offset	Tested/ Reduced	
Band 12 699-716 MHz	Face	23060	10 MHz	QPSK	50	24	Reduced <sup>6</sup>	
		23095					Tested	
		23129					Reduced <sup>6</sup>	
		23060					Reduced <sup>1</sup>	
		23095					Reduced <sup>1</sup>	
		23129			Reduced <sup>1</sup>			
		23060			100	0	Reduced <sup>2</sup>	
		23095					Reduced <sup>2</sup>	
		23129					Reduced <sup>2</sup>	
		23060					Reduced <sup>2</sup>	
		23095		Tested				
		23129		1	0	Reduced <sup>2</sup>		
		23060				Reduced <sup>2</sup>		
		23095				Tested		
		23129				Reduced <sup>2</sup>		
		23060				Reduced <sup>3</sup>		
		23095		50	24	Reduced <sup>3</sup>		
		23129				Reduced <sup>3</sup>		
		23060				Reduced <sup>1</sup>		
		23095				Reduced <sup>1</sup>		
	23129	Reduced <sup>1</sup>						
	23060	100	0	Reduced <sup>4</sup>				
	23095			Reduced <sup>4</sup>				
	23129			Reduced <sup>4</sup>				
	23060			Reduced <sup>4</sup>				
	23095			Reduced <sup>4</sup>				
	23129	1	0	Reduced <sup>4</sup>				
	23060			Reduced <sup>4</sup>				
	23095			Reduced <sup>4</sup>				
	23129			Reduced <sup>4</sup>				
	23060			Reduced <sup>4</sup>				
	All lower bandwidths (15 MHz, 10 MHz, 5 MHz, 3 MHz, 1.4 MHz)							Reduced <sup>5</sup>
	Back	QPSK	23060	10 MHz	50	24	Reduced <sup>6</sup>	
			23095				Tested	
			23129				Reduced <sup>6</sup>	
			23060				Reduced <sup>1</sup>	
			23095				Reduced <sup>1</sup>	
			23129		Reduced <sup>1</sup>			
			23060		100	0	Reduced <sup>2</sup>	
			23095				Reduced <sup>2</sup>	
			23129				Reduced <sup>2</sup>	
			23060				Tested	
		23095	Tested					
		23129	1		0	Reduced <sup>3</sup>		
23060		Reduced <sup>3</sup>						
23095		Reduced <sup>3</sup>						
23129		Reduced <sup>1</sup>						
23060		Reduced <sup>1</sup>						
23095		100	0		Reduced <sup>4</sup>			
23129					Reduced <sup>4</sup>			
23060					Reduced <sup>4</sup>			
23095					Reduced <sup>4</sup>			
23129	Reduced <sup>4</sup>							
23060	1	0	Reduced <sup>4</sup>					
23095			Reduced <sup>4</sup>					
23129			Reduced <sup>4</sup>					
23060			Reduced <sup>4</sup>					
23095			Reduced <sup>4</sup>					
23129	Reduced <sup>4</sup>							
All lower bandwidths (15 MHz, 10 MHz, 5 MHz, 3 MHz, 1.4 MHz)							Reduced <sup>7</sup>	

Reduced<sup>1</sup> - If the SAR value in the 50% RB testing is less than 1.45 W/kg, the 100% RB testing is reduced per KDB941225 D05 v02r05.  
 Reduced<sup>2</sup> - If the SAR value in the 1 RB testing is less than 1.45 W/kg, the remaining channels are reduced per KDB941225 D05 v02r05.  
 Reduced<sup>3</sup> - If the SAR value in the 50% RB testing is less than 1.45 W/kg, the remaining channels are reduced per KDB941225 D05 v02r05.  
 Reduced<sup>4</sup> - If the SAR value in the 1 RB testing is less than 1.45 W/kg, the remaining channels are reduced per KDB941225 D05 v02r05.  
 Reduced<sup>5</sup> - If the conducted power is within ±0.5 dB, all testing where the SAR value is less than 1.45 W/kg is reduced per KDB941225 D05 v02r05.  
 Reduced<sup>6</sup> - If the SAR value measured on the middle channel is less than 0.8 W/kg and the conducted power is within ±0.5 dB, the remaining channels are reduced per KDB941225 D05 v02r05.  
 Reduced<sup>7</sup> - The remaining sides are not used next to the body.

**SAR Data Summary – VHF Face SAR Measurements**

**MEASUREMENT RESULTS**

Gap	Plot	Conf.	Battery	Frequency		Mod.	Ant.	End Power (dBm)	Drift (dB)	Measured SAR (W/kg)	Adjusted SAR (W/kg)	SAR (W/kg) 50% Duty Cycle
				MHz	Ch.							
25 mm	-----	Radio	A	136	1	FM	I	35.59	-0.29	0.411	0.61	0.30
	-----			145	2	FM		35.63	-0.33	0.456	0.67	0.34
	1			155	3	FM		35.66	-0.46	0.570	0.86	0.43
	-----			164	4	FM		35.70	-0.37	0.442	0.65	0.32
	-----			174	5	FM		35.72	-0.31	0.481	0.69	0.35

**Head**  
**8.0 W/kg (mW/g)**  
 averaged over 1 gram

1. Battery is fully charged for all tests.  
 Power Measured  Conducted  ERP  EIRP
2. SAR Measurement  
 Phantom Configuration  Left Head  Eli4  Right Head  
 SAR Configuration  Head  Body
3. Test Signal Call Mode  Test Code  Base Station Simulator
4. Test Configuration  With Belt Clip  Without Belt Clip  N/A
5. Tissue Depth is at least 15.0 cm

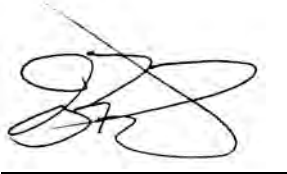

Jay M. Moulton  
 Vice President

The adjusted SAR value was calculated by first scaling the SAR value up by the drift. This value was then scaled up based on the difference of the upper end of the tolerance (36.99 dB) and the measured conducted power. The resultant value is then multiplied by 0.5 to give the SAR value at 50% duty cycle.

**SAR Data Summary – VHF Body SAR Measurements**

**MEASUREMENT RESULTS**

Gap	Plot	Body Worn Acc.	Battery	Frequency		Mod.	Ant.	End Power (dBm)	Drift (dB)	Measured SAR (W/kg)	Adjusted SAR (W/kg)	SAR (W/kg) 50% Duty Cycle
				MHz	Ch.							
0 mm	2	A	A	155	3	FM	I	35.66	-0.59	0.249	0.39	0.19

**Body**  
**8.0 W/kg (mW/g)**  
 averaged over 1 gram

1. Battery is fully charged for all tests.  
 Power Measured  Conducted  ERP  EIRP
2. SAR Measurement  
 Phantom Configuration  Left Head  Eli4  Right Head  
 SAR Configuration  Head  Body
3. Test Signal Call Mode  Test Code  Base Station Simulator
4. Test Configuration  With Belt Clip  Without Belt Clip  N/A
5. Tissue Depth is at least 15.0 cm



Jay M. Moulton  
 Vice President

The adjusted SAR value was calculated by first scaling the SAR value up by the drift. This value was then scaled up based on the difference of the upper end of the tolerance (36.99 dB) and the measured conducted power. The resultant value is then multiplied by 0.5 to give the SAR value at 50% duty cycle.

**SAR Data Summary – 750 MHz LTE Band 12**
**MEASUREMENT RESULTS**

Gap	Plot	Position	Frequency		BW/ Modulation	RB Size	RB Offset	MPR Target	End Power (dBm)	Measured SAR (W/kg)	Reported SAR (W/kg)
			MHz	Ch.							
25 mm	3	Face	707.5	23095	10 MHz/QPSK	1	24	0	23.9	0.115	0.17
	-----		707.5	23095	10 MHz/QPSK	25	13	1	22.3	0.084	0.15
0 mm	-----	Body	704.0	23060	10 MHz/QPSK	1	24	0	23.5	0.109	0.18
	4		707.5	23095	10 MHz/QPSK	1	24	0	23.9	0.125	0.19
	-----		711.0	23129	10 MHz/QPSK	1	24	0	23.5	0.113	0.19
	-----		707.5	23095	10 MHz/QPSK	25	13	1	22.3	0.0956	0.17

**Head & Body**  
**1.6 W/kg (mW/g)**  
 averaged over 1 gram

1. SAR Measurement
  - Phantom Configuration
    - Left Head
    - Head
    - Eli4
    - Right Head
    - Body
  - 2. Test Signal Call Mode
    - Test Code
    - Base Station Simulator
  - 3. Test Configuration
    - With Belt Clip
    - Without Belt Clip
    - N/A
  - 4. Tissue Depth is at least 15.0 cm



Jay M. Moulton  
 Vice President

**SAR Data Summary – 835 MHz Band 5 - WCDMA**

**MEASUREMENT RESULTS**

Gap	Plot	Frequency		Modulation	Position	End Power (dBm)	RMC	Test Set Up	Measured SAR (W/kg)	Reported SAR (W/kg)
		MHz	Ch.							
25 mm	5	836.6	4183	WCDMA	Face	23.94	12.2 kbps	Test Loop 1	0.0876	0.11
0 mm	----	826.4	4132	WCDMA	Body	23.69	12.2 kbps	Test Loop 1	0.101	0.14
	6	836.6	4183	WCDMA		23.94	12.2 kbps	Test Loop 1	0.119	0.15
	----	846.6	4233	WCDMA		23.64	12.2 kbps	Test Loop 1	0.108	0.15

**Head & Body**  
**1.6 W/kg (mW/g)**  
 averaged over 1 gram

- SAR Measurement  
 Phantom Configuration  Left Head  Eli4  Right Head  
 SAR Configuration  Head  Body
- Test Signal Call Mode  Test Code  Base Station Simulator
- Test Configuration  With Belt Clip  Without Belt Clip  N/A
- Tissue Depth is at least 15.0 cm



Jay M. Moulton  
 Vice President

**SAR Data Summary – 1750 MHz LTE Band 4**

**MEASUREMENT RESULTS**

Gap	Plot	Position	Frequency		BW/ Modulation	RB Size	RB Offset	MPR Target	End Power (dBm)	Measured SAR (W/kg)	Reported SAR (W/kg)
			MHz	Ch.							
25 mm	-----	Face	1720.0	20050	20 MHz/QPSK	1	49	0	23.4	0.148	0.25
	7		1732.5	20175	20 MHz/QPSK	1	49	0	23.8	0.167	0.26
	-----		1745.0	20300	20 MHz/QPSK	1	49	0	23.6	0.152	0.25
	-----		1732.5	20175	20 MHz/QPSK	50	24	1	22.5	0.127	0.21
0 mm	8	Body	1732.5	20175	20 MHz/QPSK	1	49	0	23.8	0.0685	0.11
	-----		1732.5	20175	20 MHz/QPSK	50	24	1	22.5	0.0532	0.09

**Head & Body**  
**1.6 W/kg (mW/g)**  
averaged over 1 gram

1. SAR Measurement  
 Phantom Configuration  Left Head  Eli4  Right Head  
 SAR Configuration  Head  Body
2. Test Signal Call Mode  Test Code  Base Station Simulator
3. Test Configuration  With Belt Clip  Without Belt Clip  N/A
4. Tissue Depth is at least 15.0 cm

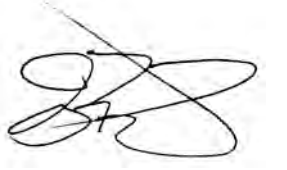

Jay M. Moulton  
Vice President



**SAR Data Summary – 1900 MHz Band 2 - WCDMA**

MEASUREMENT RESULTS										
Gap	Plot	Frequency		Modulation	Position	End Power (dBm)	RMC	Test Set Up	Measured SAR (W/kg)	Reported SAR (W/kg)
		MHz	Ch.							
25 mm	----	1852.4	9262	WCDMA	Face	23.82	12.2 kbps	Test Loop 1	0.113	0.15
	9	1880.0	9400	WCDMA		23.87	12.2 kbps	Test Loop 1	0.152	0.20
	----	1907.6	9538	WCDMA		23.85	12.2 kbps	Test Loop 1	0.136	0.18
0 mm	10	1880.0	9400	WCDMA	Body	23.87	12.2 kbps	Test Loop 1	0.0488	0.06

**Head & Body**  
**1.6 W/kg (mW/g)**  
averaged over 1 gram

1. SAR Measurement
  - Phantom Configuration  Left Head  Eli4  Right Head
  - SAR Configuration  Head  Body
2. Test Signal Call Mode  Test Code  Base Station Simulator
3. Test Configuration  With Belt Clip  Without Belt Clip  N/A
4. Tissue Depth is at least 15.0 cm

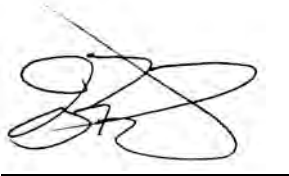

Jay M. Moulton  
 Vice President

**SAR Data Summary – 1900 MHz LTE Band 2**

**MEASUREMENT RESULTS**

Gap	Plot	Position	Frequency		BW/ Modulation	RB Size	RB Offset	MPR Target	End Power (dBm)	Measured SAR (W/kg)	Reported SAR (W/kg)
			MHz	Ch.							
25 mm	-----	Face	1860.0	18700	20 MHz/QPSK	1	49	0	23.9	0.160	0.24
	11		1880.0	18900	20 MHz/QPSK	1	49	0	23.7	0.177	0.28
	-----		1900.0	19100	20 MHz/QPSK	1	49	0	23.5	0.152	0.25
	-----		1880.0	18900	20 MHz/QPSK	50	24	1	22.9	0.126	0.19
0 mm	12	Body	1880.0	18900	20 MHz/QPSK	1	49	0	23.7	0.128	0.20
	-----		1880.0	18900	20 MHz/QPSK	50	24	1	22.9	0.094	0.14

**Head & Body**  
**1.6 W/kg (mW/g)**  
 averaged over 1 gram

- 1. SAR Measurement
  - Phantom Configuration  Left Head  Eli4  Right Head
  - SAR Configuration  Head  Body
- 2. Test Signal Call Mode  Test Code  Base Station Simulator
- 3. Test Configuration  With Belt Clip  Without Belt Clip  N/A
- 4. Tissue Depth is at least 15.0 cm

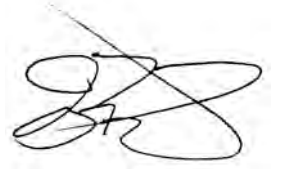

\_\_\_\_\_  
 Jay M. Moulton  
 Vice President

## SAR Data Summary – Simultaneous Evaluation

MEASUREMENT RESULTS – WWAN & BT									
Frequency		Modulation	Conf.	Frequency		Modulation	SAR <sub>1</sub>	SAR <sub>2</sub>	SAR Total
MHz	Ch.			MHz	Ch.				
1880	18900	QPSK	Body	2441	39	DSSS	0.28	0.11	0.39
<b>Head &amp; Body</b> <b>1.6 W/kg (mW/g)</b> averaged over 1 gram									

The BT transmitter is excluded from SAR testing. Therefore, the SAR value is calculated based on the equation in KDB447498 v06 section 4.3.2 b) 1).

$[\text{Max power including tune up, mW/min distance, mm}] \cdot [\sqrt{f_{(\text{GHz})}}/x]$ , where x is 7.5 for 1 gram SAR

$$[2.5/5] \cdot [\sqrt{2.48/7.5}] = 0.11 \text{ W/kg}$$

The sum of the two transmitters is less than the limit; therefore, the simultaneous transmission meets the requirements of KDB447498 D01 v06 section 4.3.2 page 13.

## SAR Data Summary – Simultaneous Evaluation

The VHF and BT transmitters use two different limit requirements. Therefore, the simultaneous transmission is evaluated based on a ratio to the each limit.

The BT transmitter is excluded from SAR testing. Therefore, the SAR value is calculated based on the equation in KDB447498 v06 section 4.3.2 b) 1).

$[\text{Max power including tune up, mW/min distance, mm}] \cdot [\sqrt{f_{(\text{GHz})}}/x]$ , where x is 7.5 for 1 gram SAR

$$[2.5/5] \cdot [\sqrt{2.48/7.5}] = 0.11 \text{ W/kg}$$

The highest value for the VHF band is 0.43 W/kg. The limit for the VHF band is 8.0 W/kg. The ratio is the measured value divided by the limit.

$$0.43/8.0 = 0.054$$

The highest value for the BT band is 0.11. The limit for the BT band is 1.6 W/kg. The ratio is the calculated value divided by the limit.

$$0.11/1.6 = 0.069$$

The sum of the two transmitter's ratio is less than 1; therefore, the simultaneous transmission meets the requirements of KDB447498 D01 v06 section 4.3.2 page 13.

## 11. Test Equipment List

**Table 11.1 Equipment Specifications**

Type	Calibration Due Date	Calibration Done Date	Serial Number
Staubli Robot TX60L	N/A	N/A	F07/55M6A1/A/01
Measurement Controller CS8c	N/A	N/A	1012
ELI5 Flat Phantom	N/A	N/A	2037
Device Holder	N/A	N/A	N/A
Data Acquisition Electronics 4	04/21/2021	04/21/2020	1416
SPEAG E-Field Probe EX3DV4	07/14/2021	07/14/2020	7531
Speag Validation CLA150	11/15/2021	11/15/2019	4002
Speag Validation Dipole D750V3	07/13/2021	07/13/2018	1016
Speag Validation Dipole D835V3	07/13/2021	07/13/2018	4d089
Speag Validation Dipole D1750V2	07/20/2021	07/20/2018	1018
Speag Validation Dipole D1900V2	07/13/2021	07/13/2018	5d116
Agilent N1911A Power Meter	04/27/2021	04/27/2020	GB45100254
Agilent N1922A Power Sensor	04/27/2021	04/27/2020	MY45240464
Advantest R3261A Spectrum Analyzer	03/16/2021	03/16/2020	31720068
Agilent (HP) 8350B Signal Generator	03/16/2021	03/16/2020	2749A10226
Agilent (HP) 83525A RF Plug-In	03/16/2021	03/16/2020	2647A01172
Agilent (HP) 8753C Vector Network Analyzer	03/16/2021	03/16/2020	3135A01724
Agilent (HP) 85047A S-Parameter Test Set	03/17/2021	03/17/2020	2904A00595
Agilent (HP) 8960 Base Station Sim.	05/31/2021	05/31/2020	MY48360364
Anritsu MT8820C			6201176199
MiniCircuits BW-N20W5+ Fixed 20 dB Attenuator	N/A	N/A	N/A
MiniCircuits SPL-10.7+ Low Pass Filter	N/A	N/A	R8979513746
Apriel Dielectric Probe Assembly	N/A	N/A	0011
Head Equivalent Matter (150 MHz)	N/A	N/A	N/A
Head Equivalent Matter (750 MHz)	N/A	N/A	N/A
Head Equivalent Matter (835 MHz)	N/A	N/A	N/A
Head Equivalent Matter (1750 MHz)	N/A	N/A	N/A
Head Equivalent Matter (1900 MHz)	N/A	N/A	N/A

## 12. Conclusion

The SAR measurement indicates that the EUT complies with the RF radiation exposure limits of the FCC/IC. These measurements are taken to simulate the RF effects exposure under worst-case conditions. Precise laboratory measures were taken to assure repeatability of the tests. The tested device complies with the requirements in respect to all parameters subject to the test. The test results and statements relate only to the item(s) tested.

Please note that the absorption and distribution of electromagnetic energy in the body is a very complex phenomena that depends on the mass, shape, and size of the body; the orientation of the body with respect to the field vectors; and, the electrical properties of both the body and the environment. Other variables that may play a substantial role in possible biological effects are those that characterize the environment (e.g. ambient temperature, air velocity, relative humidity, and body insulation) and those that characterize the individual (e.g. age, gender, activity level, debilitation, or disease). Because innumerable factors may interact to determine the specific biological outcome of an exposure to electromagnetic fields, any protection guide shall consider maximal amplification of biological effects as a result of field-body interactions, environmental conditions, and physiological variables. [3]

## 13. References

- [1] Federal Communications Commission, ET Docket 93-62, Guidelines for Evaluating the Environmental Effects of Radio Frequency Radiation, August 1996
- [2] ANSI/IEEE C95.1 – 1992, American National Standard Safety Levels with respect to Human Exposure to Radio Frequency Electromagnetic Fields, 300kHz to 100GHz, New York: IEEE, 1992.
- [3] ANSI/IEEE C95.3 – 1992, IEEE Recommended Practice for the Measurement of Potentially Hazardous Electromagnetic Fields – RF and Microwave, New York: IEEE, 1992.
- [4] International Electrotechnical Commission, IEC 62209-2 (Edition 1.0), Human Exposure to radio frequency fields from hand-held and body mounted wireless communication devices – Human models, instrumentation, and procedures – Part 2: Procedure to determine the specific absorption rate (SAR) for wireless communication devices used in close proximity to the human body (frequency range of 30 MHz to 6 GHz), March 2010.
- [5] IEEE Standard 1528 – 2013, IEEE Recommended Practice for Determining the Peak-Spatial Average Specific Absorption Rate (SAR) in the Human Head from Wireless Communication Devices: Measurement Techniques, June 2013.
- [6] Industry Canada, RSS – 102 Issue 5 Draft, Radio Frequency Exposure Compliance of Radiocommunication Apparatus (All Frequency Bands), March 2014.
- [7] Health Canada, Safety Code 6, Limits of Human Exposure to Radiofrequency Electromagnetic Fields in the Frequency Range from 3kHz to 300 GHz, 2009.

## Appendix A – System Validation Plots and Data

```
*****  
Test Result for UIM Dielectric Parameter  
Wed 02/Dec/2020  
Freq Frequency(GHz)  
FCC_eH Limits for Head Epsilon  
FCC_sH Limits for Head Sigma  
Test_e Epsilon of UIM  
Test_s Sigma of UIM  
*****  
Freq FCC_eH FCC_sH Test_e Test_s  
0.1300 53.23 0.75 53.12 0.76  
0.1360 52.954 0.75 52.886 0.766*  
0.1400 52.77 0.75 52.73 0.77  
0.1450 52.535 0.755 52.525 0.775*  
0.1500 52.30 0.76 52.32 0.78  
0.1550 52.065 0.765 52.105 0.785*  
0.1600 51.83 0.77 51.89 0.79  
0.1640 51.646 0.77 51.726 0.79*  
0.1700 51.37 0.77 51.48 0.79  
0.1740 51.182 0.774 51.308 0.794*  
0.1800 50.90 0.78 51.05 0.80  
0.1900 50.43 0.79 50.64 0.81
```

\* value interpolated

```
*****  
Test Result for UIM Dielectric Parameter  
Fri 11/Dec/2020  
Freq Frequency(GHz)  
FCC_eH Limits for Head Epsilon  
FCC_sH Limits for Head Sigma  
Test_e Epsilon of UIM  
Test_s Sigma of UIM  
*****  
Freq FCC_eH FCC_sH Test_e Test_s  
0.7000 42.20 0.89 41.85 0.89  
0.7040 42.18 0.89 41.822 0.894*  
0.7075 42.163 0.89 41.798 0.898*  
0.7100 42.15 0.89 41.78 0.90  
0.7110 42.145 0.89 41.775 0.901*  
0.7200 42.10 0.89 41.73 0.91  
0.7300 42.05 0.89 41.66 0.91  
0.7400 41.99 0.89 41.60 0.91  
0.7500 41.94 0.89 41.55 0.91  
0.7600 41.89 0.89 41.49 0.92  
0.7700 41.84 0.89 41.43 0.92  
0.7800 41.79 0.90 41.37 0.92  
0.7900 41.73 0.90 41.31 0.93  
0.8000 41.68 0.90 41.27 0.93
```

\* value interpolated

\*\*\*\*\*

Test Result for UIM Dielectric Parameter

Thu 10/Dec/2020

Freq Frequency(GHz)

eH Limits for Head Epsilon

sH Limits for Head Sigma

Test\_e Epsilon of UIM

Test\_s Sigma of UIM

\*\*\*\*\*

Freq	eH	sH	Test_e	Test_s
0.8000	41.68	0.90	41.31	0.92
0.8100	41.63	0.90	41.26	0.93
0.8200	41.58	0.90	41.2	0.94
0.8290	41.535	0.90	41.245	0.94*
0.8300	41.53	0.90	41.25	0.94
0.8350	41.515	0.905	41.235	0.945*
0.8366	41.511	0.907	41.231	0.947*
0.8400	41.50	0.91	41.22	0.95
0.8420	41.50	0.912	41.216	0.952*
0.8440	41.50	0.914	41.212	0.954*
0.8470	41.50	0.917	41.206	0.957*
0.8500	41.50	0.92	41.20	0.96
0.8520	41.50	0.922	41.196	0.962*
0.8600	41.50	0.93	41.18	0.97
0.8700	41.50	0.94	41.17	0.98

\* value interpolated

\*\*\*\*\*

Test Result for UIM Dielectric Parameter

Wed 09/Dec/2020

Freq Frequency(GHz)

eH Limits for Head Epsilon

sH Limits for Head Sigma

Test\_e Epsilon of UIM

Test\_s Sigma of UIM

\*\*\*\*\*

Freq	eH	sH	Test_e	Test_s
1.7000	40.16	1.34	39.73	1.38
1.7100	40.14	1.35	39.71	1.39
1.7200	40.13	1.35	39.69	1.40
1.7300	40.11	1.36	39.67	1.40
1.7325	40.105	1.363	39.665	1.403*
1.7400	40.09	1.37	39.65	1.41
1.7450	40.085	1.37	39.64	1.415*
1.7475	40.083	1.37	39.635	1.418*
1.7500	40.08	1.37	39.63	1.42
1.7600	40.06	1.38	39.61	1.43
1.7700	40.05	1.38	39.59	1.44
1.7750	40.04	1.385	39.58	1.44*
1.7800	40.03	1.39	39.57	1.44
1.7900	40.02	1.39	39.55	1.45

\* value interpolated



\*\*\*\*\*

Test Result for UIM Dielectric Parameter

Tue 08/Dec/2020

Freq Frequency(GHz)

FCC\_eH Limits for Head Epsilon

FCC\_sH Limits for Head Sigma

Test\_e Epsilon of UIM

Test\_s Sigma of UIM

\*\*\*\*\*

Freq	FCC_eH	FCC_sH	Test_e	Test_s
1.8500	40.00	1.40	39.52	1.41
1.8524	40.00	1.40	39.515	1.412*
1.8600	40.00	1.40	39.50	1.42
1.8700	40.00	1.40	39.48	1.43
1.8800	40.00	1.40	39.47	1.44
1.8900	40.00	1.40	39.46	1.44
1.9000	40.00	1.40	39.46	1.46
1.9076	40.00	1.40	39.445	1.468*
1.9100	40.00	1.40	39.44	1.47
1.9200	40.00	1.40	39.43	1.47
1.9224	40.00	1.40	39.423	1.47*
1.9300	40.00	1.40	39.40	1.47
1.9400	40.00	1.40	39.38	1.48
1.9500	40.00	1.40	39.36	1.48
1.9600	40.00	1.40	39.34	1.49
1.9700	40.00	1.40	39.31	1.49
1.9776	40.00	1.40	39.295	1.49*
1.9800	40.00	1.40	39.29	1.49

\*value interpolated

# RF Exposure Lab

## Plot 1

**DUT: Loop 150 MHz CLA150; Type: CLA150; Serial: CLA150 - SN:4002**

Communication System: CW; Frequency: 150 MHz; Duty Cycle: 1:1  
Medium: HSL150; Medium parameters used:  $f = 150 \text{ MHz}$ ;  $\sigma = 0.78 \text{ S/m}$ ;  $\epsilon_r = 52.32$ ;  $\rho = 1000 \text{ kg/m}^3$   
Phantom section: Flat Section

Test Date: Date: 12/2/2020; Ambient Temp: 23 °C; Tissue Temp: 21 °C

Probe: EX3DV4 – SN7531; ConvF(12.88, 12.88, 12.88); Calibrated: 7/14/2020;  
Sensor-Surface: 2mm (Mechanical Surface Detection)  
Electronics: DAE4 Sn1416; Calibrated: 4/21/2020  
Phantom: ELI v5.0; Type: QDOVA002AA; Serial: 2037  
Measurement SW: DASYS2, Version 52.10 (0); SEMCAD X Version 14.6.10 (7417)

### Procedure Notes:

**150 MHz Head/Verification/Area Scan (9x9x1):** Measurement grid:  $dx=15\text{mm}$ ,  $dy=15\text{mm}$   
Maximum value of SAR (measured) = 1.96 W/kg

**150 MHz Head/Verification/Zoom Scan (5x5x7)/Cube 0:** Measurement grid:  $dx=8\text{mm}$ ,  $dy=8\text{mm}$ ,  $dz=5\text{mm}$   
Reference Value = 50.784 V/m; Power Drift = 0.00 dB  
Peak SAR (extrapolated) = 3.04 W/kg  
**SAR(1 g) = 1.94 W/kg; SAR(10 g) = 1.29 W/kg**  
Maximum value of SAR (measured) = 2.02 W/kg

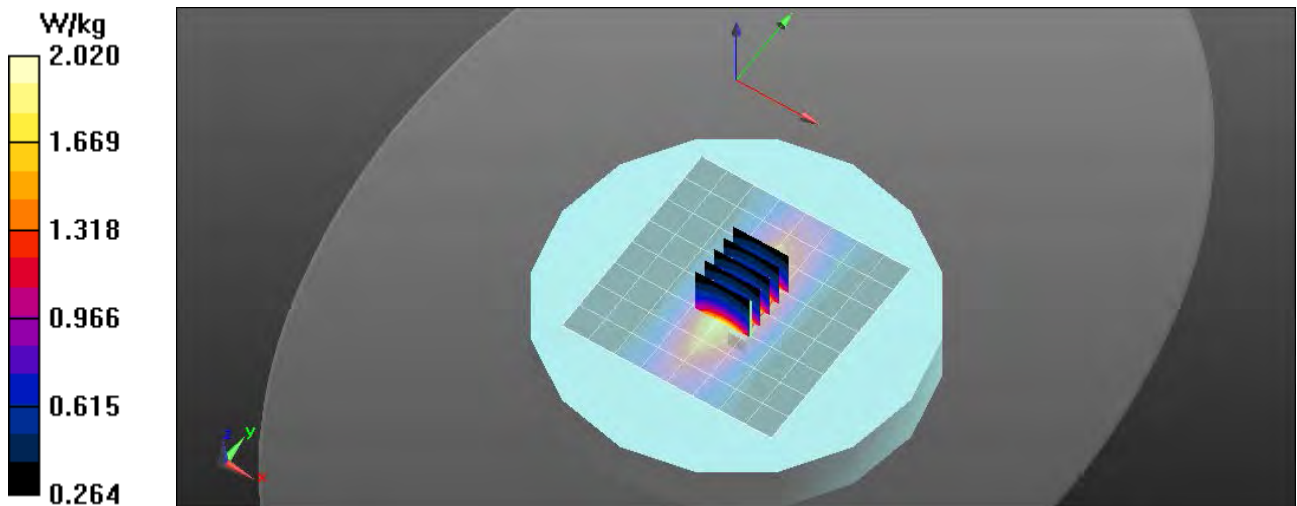

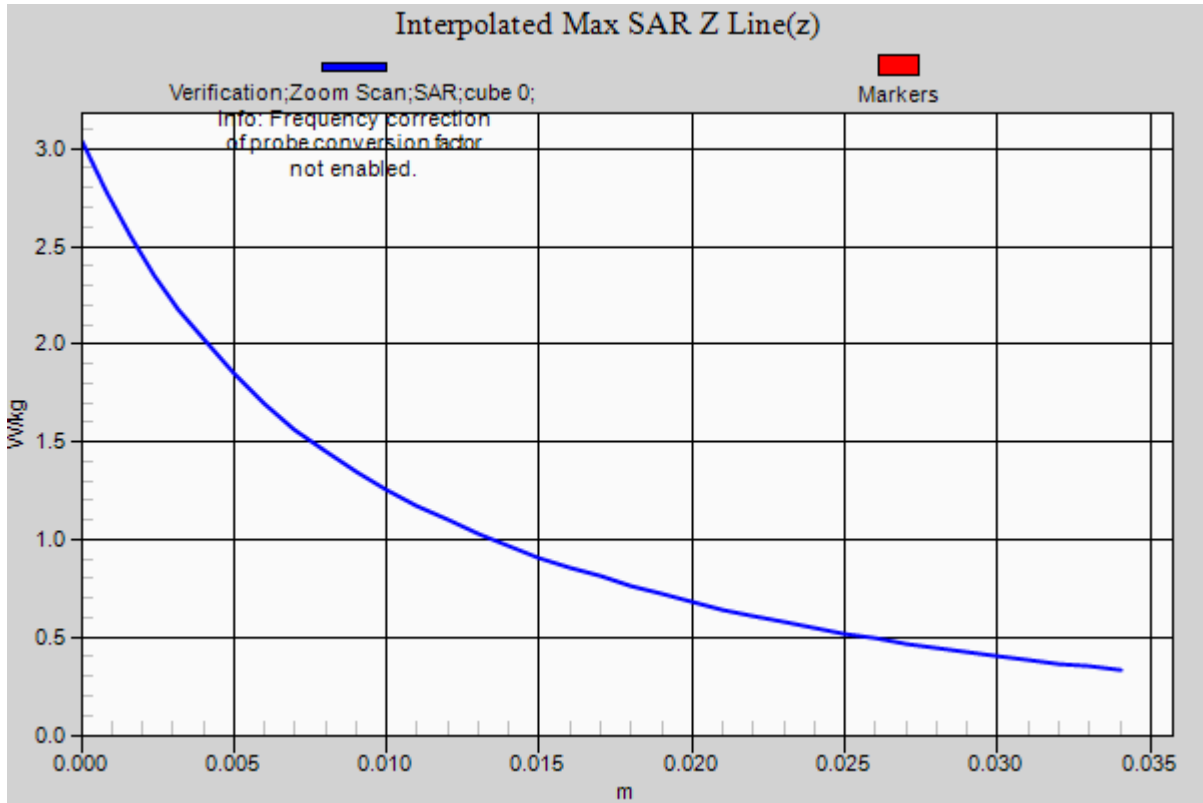

# RF Exposure Lab

## Plot 2

**DUT: Dipole 750 MHz D750V3; Type: D750V3; Serial: D750V3 - SN 1016**

Communication System: CW; Frequency: 750 MHz; Duty Cycle: 1:1  
 Medium: HSL750; Medium parameters used (interpolated):  $f = 750$  MHz;  $\sigma = 0.91$  S/m;  $\epsilon_r = 41.55$ ;  $\rho = 1000$  kg/m<sup>3</sup>  
 Phantom section: Flat Section

Test Date: Date: 12/11/2020; Ambient Temp: 23 °C; Tissue Temp: 21 °C

Probe: EX3DV4 – SN7531; ConvF(10.64, 10.64, 10.64); Calibrated: 7/14/2020;  
 Sensor-Surface: 2mm (Mechanical Surface Detection)  
 Electronics: DAE4 Sn1416; Calibrated: 4/21/2020  
 Phantom: ELI v5.0; Type: QDOVA002AA; Serial: 2037  
 Measurement SW: DASY52, Version 52.10 (0); SEMCAD X Version 14.6.10 (7417)

### Procedure Notes:

**750 MHz Head/Verification/Area Scan (41x121x1):** Interpolated grid:  $dx=1.500$  mm,  $dy=1.500$  mm  
 Maximum value of SAR (interpolated) = 0.752 W/kg

**750 MHz Head/Verification /Zoom Scan (5x5x7)/Cube 0:** Measurement grid:  $dx=8$ mm,  $dy=8$ mm,  $dz=5$ mm  
 Reference Value = 35.839 V/m; Power Drift = -0.02 dB  
 Peak SAR (extrapolated) = 1.693 mW/g  
 $P_{in} = 100$  mW  
**SAR(1 g) = 0.826 mW/g; SAR(10 g) = 0.535 mW/g**  
 Maximum value of SAR (measured) = 0.883 W/kg

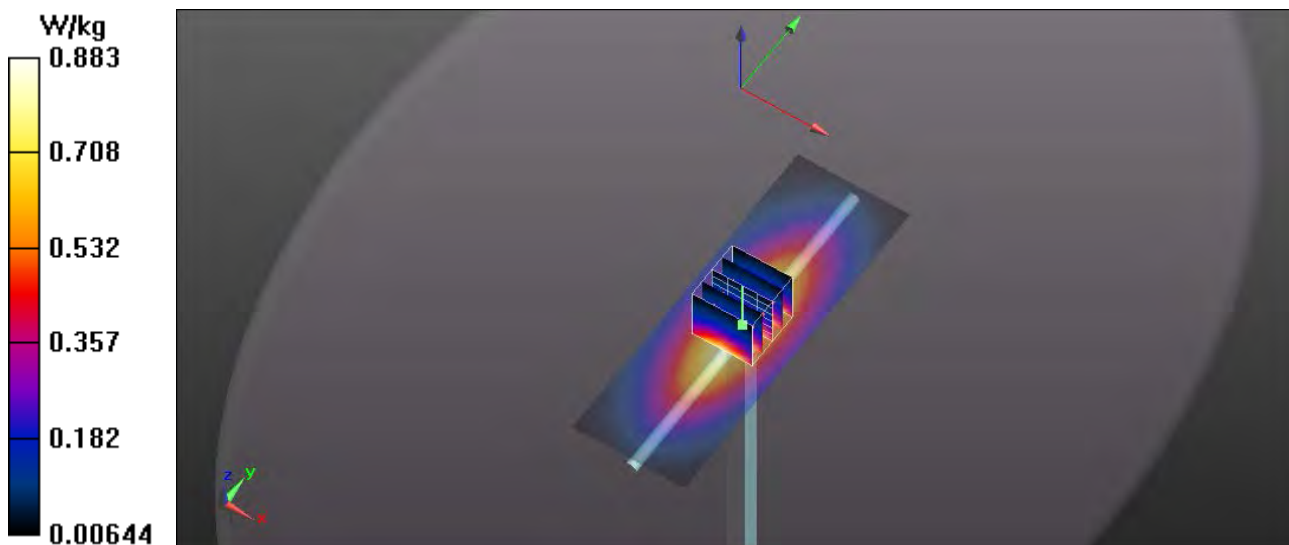

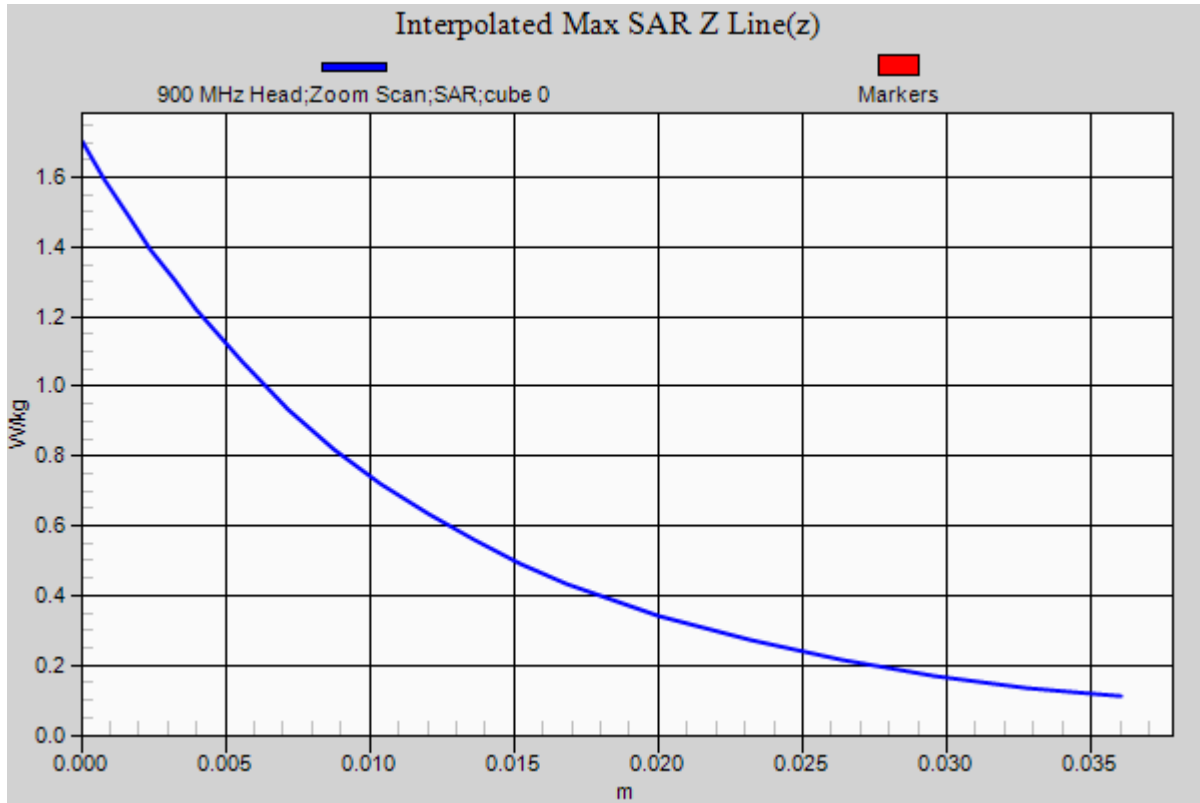

# RF Exposure Lab

## Plot 3

**DUT: Dipole 835 MHz D835V2; Type: D835V2; Serial: D835V2 - SN:4d089**

Communication System: CW; Frequency: 835 MHz; Duty Cycle: 1:1  
 Medium: HSL835; Medium parameters used (interpolated):  $f = 835 \text{ MHz}$ ;  $\sigma = 0.945 \text{ S/m}$ ;  $\epsilon_r = 41.235$ ;  $\rho = 1000 \text{ kg/m}^3$   
 Phantom section: Flat Section

Test Date: Date: 12/10/2020; Ambient Temp: 23 °C; Tissue Temp: 21 °C  
 Probe: EX3DV4 – SN7531; ConvF(10.26, 10.26, 10.26); Calibrated: 7/14/2020;  
 Sensor-Surface: 2mm (Mechanical Surface Detection)  
 Electronics: DAE4 Sn1416; Calibrated: 4/21/2020  
 Phantom: ELI v5.0; Type: QDOVA002AA; Serial: 2037  
 Measurement SW: DASY52, Version 52.10 (0); SEMCAD X Version 14.6.10 (7417)

### Procedure Notes:

**835 MHz/Verification/Area Scan (5x11x1):** Measurement grid: dx=15mm, dy=15mm

[Info: Interpolated medium parameters used for SAR evaluation.](#)

Maximum value of SAR (measured) = 1.13 W/kg

**835 MHz/Verification/Zoom Scan (5x5x7)/Cube 0:** Measurement grid: dx=8mm, dy=8mm, dz=5mm

Reference Value = 33.125 V/m; Power Drift = -0.01 dB

Peak SAR (extrapolated) = 1.46 W/kg

Pin=100 mW

**SAR(1 g) = 0.949 W/kg; SAR(10 g) = 0.614 W/kg**

[Info: Interpolated medium parameters used for SAR evaluation.](#)

Maximum value of SAR (measured) = 1.21 W/kg

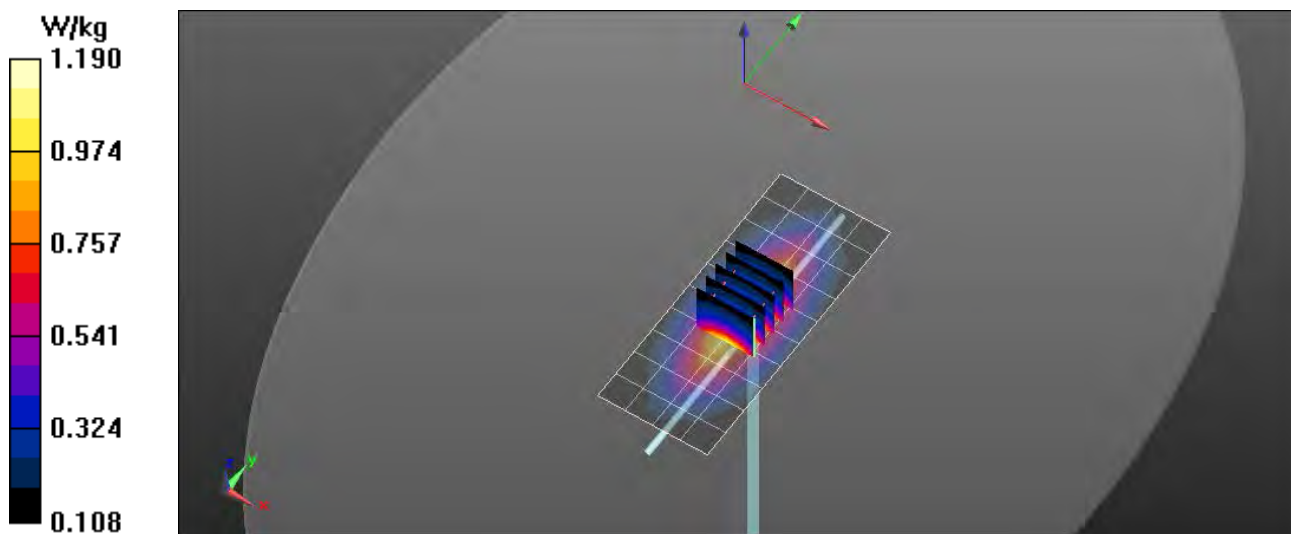

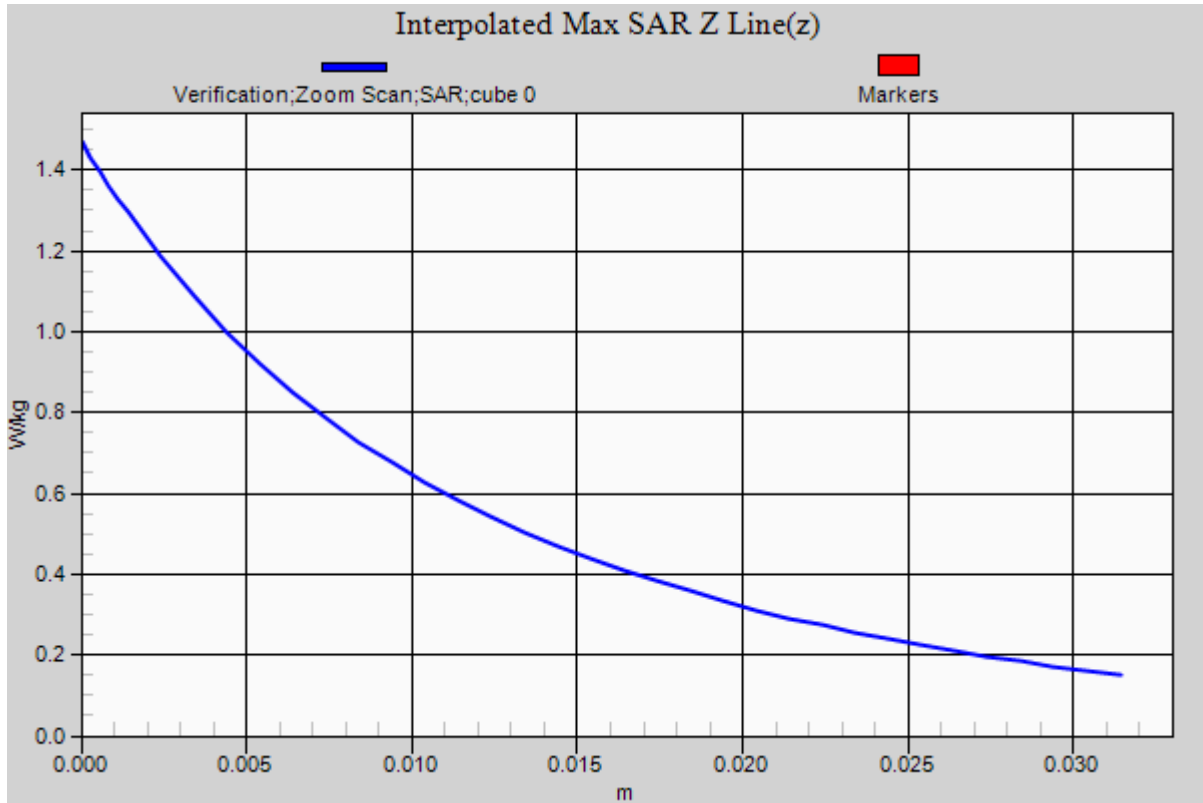

# RF Exposure Lab

## Plot 4

**DUT: Dipole 1750 MHz D1750V2; Type: D1750V2; Serial: D1750V2 - SN: 1018**

Communication System: CW; Frequency: 1750 MHz; Duty Cycle: 1:1  
 Medium: HSL1750; Medium parameters used:  $f = 1750$  MHz;  $\sigma = 1.42$  S/m;  $\epsilon_r = 39.63$ ;  $\rho = 1000$  kg/m<sup>3</sup>  
 Phantom section: Flat Section

Test Date: Date: 12/9/2020; Ambient Temp: 23 °C; Tissue Temp: 21 °C

Probe: EX3DV4 – SN7531; ConvF(8.55, 8.55, 8.55); Calibrated: 7/14/2020;  
 Sensor-Surface: 2mm (Mechanical Surface Detection)  
 Electronics: DAE4 Sn1416; Calibrated: 4/21/2020  
 Phantom: ELI v5.0; Type: QDOVA002AA; Serial: 2037  
 Measurement SW: DASY52, Version 52.10 (0); SEMCAD X Version 14.6.10 (7417)

### Procedure Notes:

**1750 MHz/Verification/Area Scan (5x7x1):** Measurement grid: dx=15mm, dy=15mm  
 Maximum value of SAR (measured) = 5.22 W/kg

**1750 MHz/Verification/Zoom Scan (5x5x7)/Cube 0:** Measurement grid: dx=8mm, dy=8mm, dz=5mm  
 Reference Value = 35.426 V/m; Power Drift = -0.01 dB  
 Peak SAR (extrapolated) = 6.88 W/kg  
 Pin=100 mW  
**SAR(1 g) = 3.67 W/kg; SAR(10 g) = 1.91 W/kg**  
 Maximum value of SAR (measured) = 5.49 W/kg

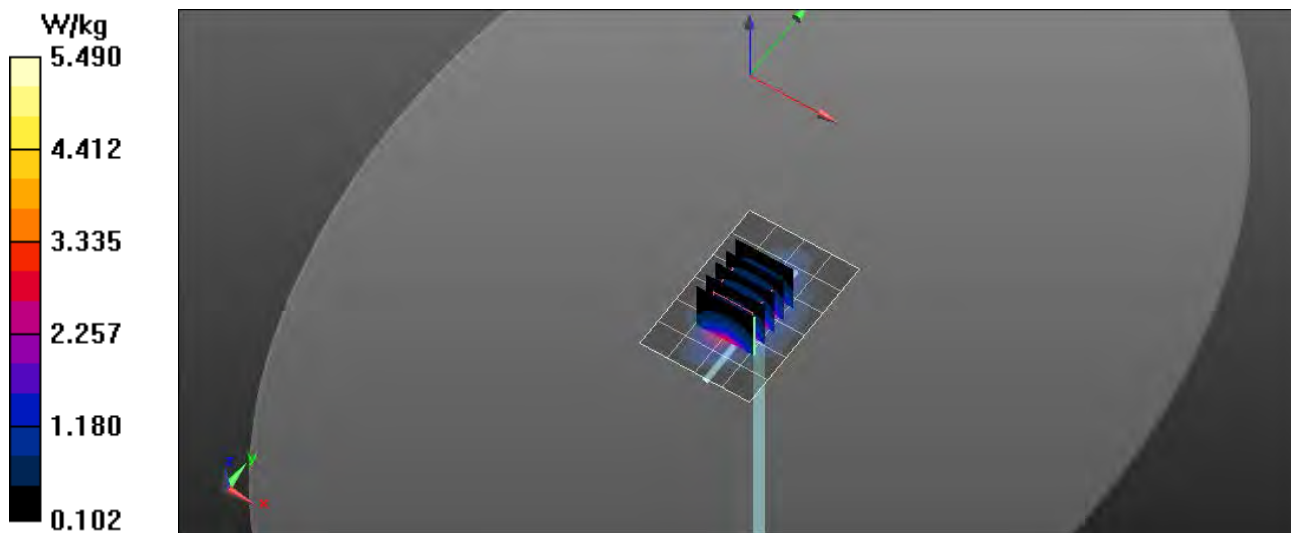



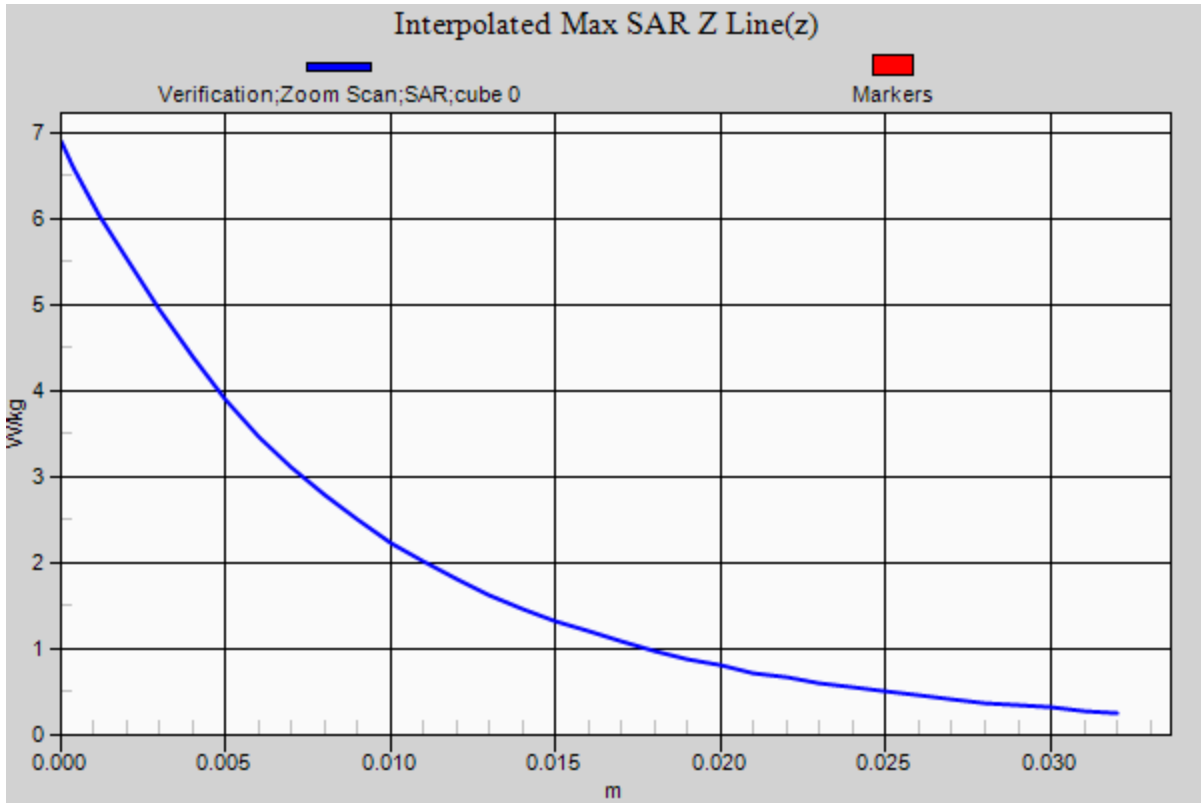

# RF Exposure Lab

## Plot 5

**DUT: Dipole 1900 MHz D1900V2; Type: D1900V2; Serial: D1900V2 - SN: 5d116**

Communication System: CW; Frequency: 1900 MHz; Duty Cycle: 1:1  
 Medium: HSL1900; Medium parameters used:  $f = 1900$  MHz;  $\sigma = 1.46$  S/m;  $\epsilon_r = 39.46$ ;  $\rho = 1000$  kg/m<sup>3</sup>  
 Phantom section: Flat Section

Test Date: Date: 12/8/2020; Ambient Temp: 23 °C; Tissue Temp: 21 °C

Probe: EX3DV4 – SN7531; ConvF(8.22, 8.22, 8.22); Calibrated: 7/14/2020;  
 Sensor-Surface: 2mm (Mechanical Surface Detection)  
 Electronics: DAE4 Sn1416; Calibrated: 4/21/2020  
 Phantom: ELI v5.0; Type: QDOVA002AA; Serial: 2037  
 Measurement SW: DASY52, Version 52.10 (0); SEMCAD X Version 14.6.10 (7417)

### Procedure Notes:

**1900 MHz/Verification/Area Scan (5x7x1):** Measurement grid: dx=15mm, dy=15mm  
 Maximum value of SAR (measured) = 5.41 W/kg

**1900 MHz/Verification/Zoom Scan (5x5x7)/Cube 0:** Measurement grid: dx=8mm, dy=8mm, dz=5mm  
 Reference Value = 33.114 V/m; Power Drift = -0.03 dB  
 Peak SAR (extrapolated) = 7.18 W/kg  
 Pin=100 mW  
**SAR(1 g) = 4.09 W/kg; SAR(10 g) = 2.13 W/kg**  
 Maximum value of SAR (measured) = 5.76 W/kg

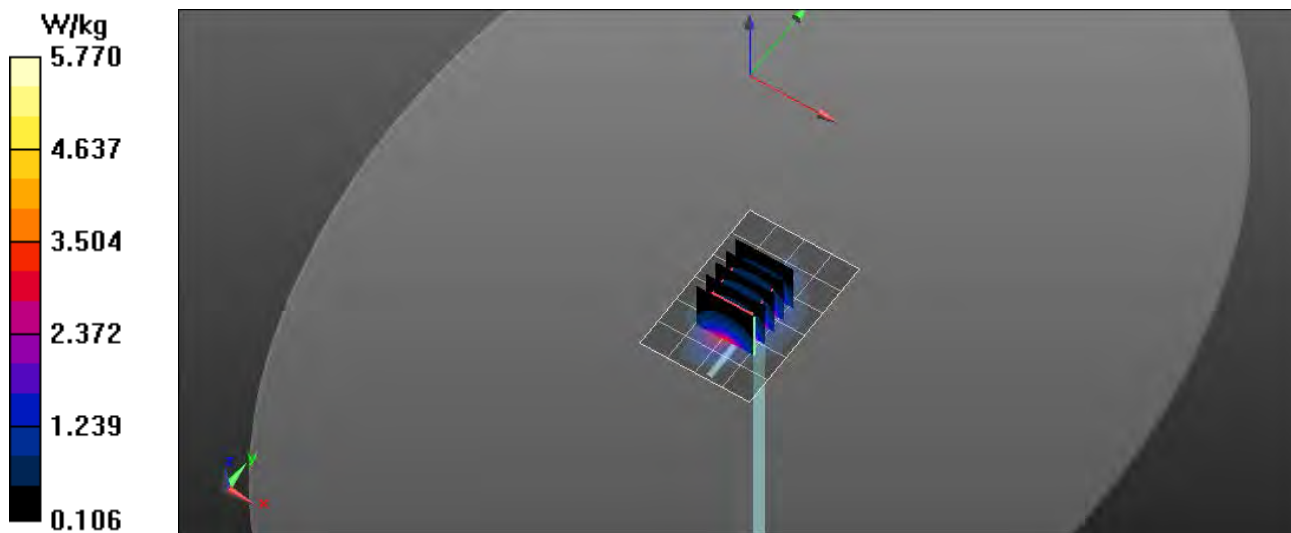

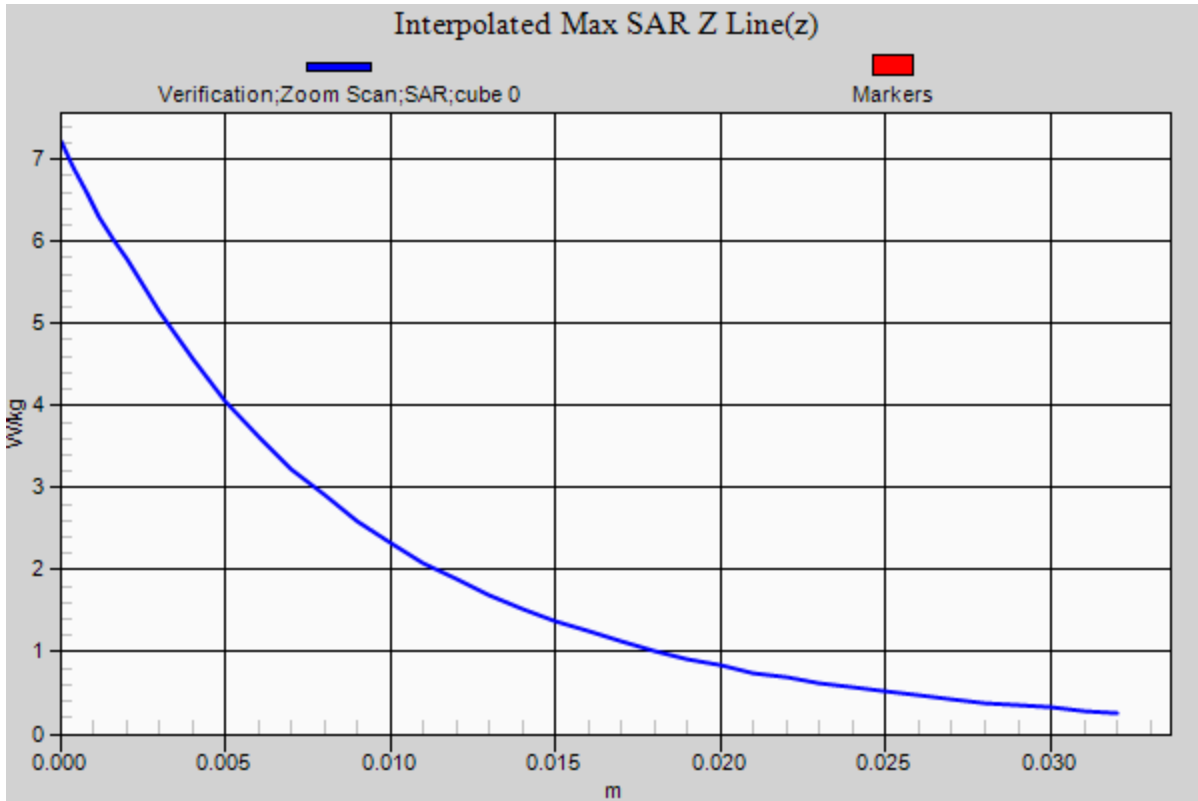

## Appendix B – SAR Test Data Plots

# RF Exposure Lab

## Plot 1

**DUT: IP730D; Type: PTT; Serial: Eng 1**

Communication System: FM; Frequency: 155 MHz; Duty Cycle: 1:1  
Medium: HSL150; Medium parameters used (interpolated):  $f = 155 \text{ MHz}$ ;  $\sigma = 0.785 \text{ S/m}$ ;  $\epsilon_r = 52.105$ ;  $\rho = 1000 \text{ kg/m}^3$   
Phantom section: Flat Section

Test Date: Date: 12/2/2020; Ambient Temp: 23 °C; Tissue Temp: 21 °C

Probe: EX3DV4 - SN7531; ConvF(12.88, 12.88, 12.88); Calibrated: 7/14/2020  
Sensor-Surface: 2mm (Mechanical Surface Detection)  
Electronics: DAE4 Sn1416; Calibrated: 4/21/2020  
Phantom: ELI v5.0; Type: QDOVA002AA; Serial: 2037  
Measurement SW: DASY52, Version 52.10 (0); SEMCAD X Version 14.6.10 (7417)

### Procedure Notes:

**VHF Ant FA-SC61VC/Face Std Bat 155/Area Scan (7x23x1):** Measurement grid: dx=15mm, dy=15mm

[Info: Interpolated medium parameters used for SAR evaluation.](#)

Maximum value of SAR (measured) = 0.697 W/kg

**VHF Ant FA-SC61VC/Face Std Bat 155/Zoom Scan (5x5x7)/Cube 0:** Measurement grid: dx=8mm, dy=8mm, dz=5mm

Reference Value = 26.97 V/m; Power Drift = -0.46 dB

Peak SAR (extrapolated) = 0.777 W/kg

**SAR(1 g) = 0.570 W/kg; SAR(10 g) = 0.445 W/kg**

[Info: Interpolated medium parameters used for SAR evaluation.](#)

Maximum value of SAR (measured) = 0.670 W/kg

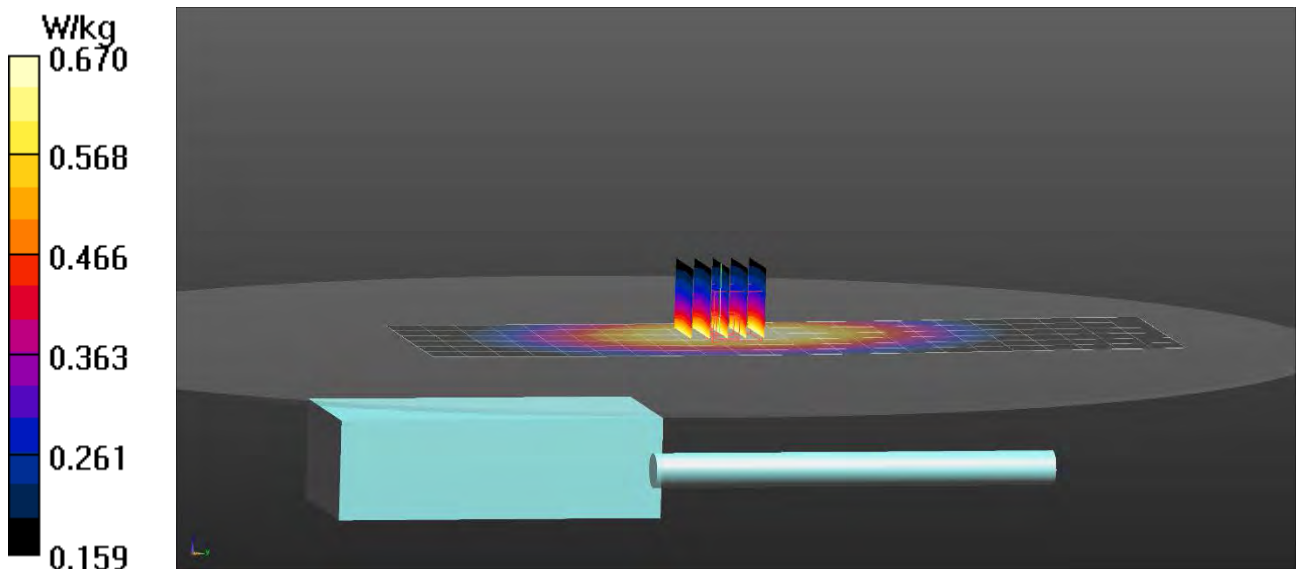

# RF Exposure Lab

## Plot 2

**DUT: IP730D; Type: PTT; Serial: Eng 1**

Communication System: FM; Frequency: 155 MHz; Duty Cycle: 1:1  
Medium: HSL150; Medium parameters used (interpolated):  $f = 155$  MHz;  $\sigma = 0.785$  S/m;  $\epsilon_r = 52.105$ ;  $\rho = 1000$  kg/m<sup>3</sup>  
Phantom section: Flat Section

Test Date: Date: 12/2/2020; Ambient Temp: 23 °C; Tissue Temp: 21 °C

Probe: EX3DV4 - SN7531; ConvF(12.88, 12.88, 12.88); Calibrated: 7/14/2020  
Sensor-Surface: 2mm (Mechanical Surface Detection)  
Electronics: DAE4 Sn1416; Calibrated: 4/21/2020  
Phantom: ELI v5.0; Type: QDOVA002AA; Serial: 2037  
Measurement SW: DASY52, Version 52.10 (0); SEMCAD X Version 14.6.10 (7417)

### Procedure Notes:

**VHF Ant FA-SC61VC/Body Belt Clip Std Bat 155/Area Scan (7x23x1):** Measurement grid: dx=15mm, dy=15mm

[Info: Interpolated medium parameters used for SAR evaluation.](#)

Maximum value of SAR (measured) = 0.301 W/kg

**VHF Ant FA-SC61VC/Body Belt Clip Std Bat 155/Zoom Scan (5x5x7)/Cube 0:** Measurement grid: dx=8mm, dy=8mm, dz=5mm

Reference Value = 17.18 V/m; Power Drift = -0.59 dB

Peak SAR (extrapolated) = 0.348 W/kg

**SAR(1 g) = 0.249 W/kg; SAR(10 g) = 0.189 W/kg**

[Info: Interpolated medium parameters used for SAR evaluation.](#)

Maximum value of SAR (measured) = 0.298 W/kg

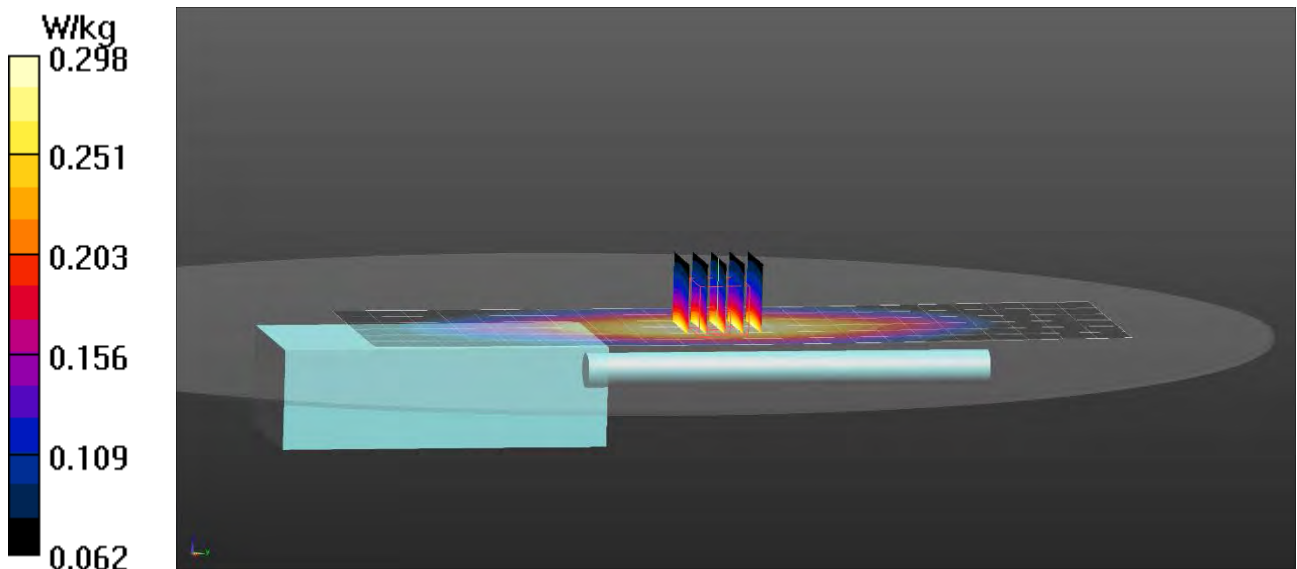

# RF Exposure Lab

## Plot 3

**DUT: IP730D; Type: PTT; Serial: Eng 1**

Communication System: LTE (SC-FDMA, 1 RB, 10 MHz, QPSK); Frequency: 707.5 MHz; Duty Cycle: 1:1  
 Medium: HSL750; Medium parameters used (interpolated):  $f = 707.5$  MHz;  $\sigma = 0.898$  S/m;  $\epsilon_r = 41.798$ ;  $\rho = 1000$  kg/m<sup>3</sup>  
 Phantom section: Flat Section

Test Date: Date: 12/11/2020; Ambient Temp: 23 °C; Tissue Temp: 21 °C

Probe: EX3DV4 - SN7531; ConvF(10.64, 10.64, 10.64); Calibrated: 7/14/2020  
 Sensor-Surface: 2mm (Mechanical Surface Detection)  
 Electronics: DAE4 Sn1416; Calibrated: 4/21/2020  
 Phantom: ELI v5.0; Type: QDOVA002AA; Serial: 2037  
 Measurement SW: DASY52, Version 52.10 (0); SEMCAD X Version 14.6.10 (7417)

### Procedure Notes:

**Band 12/Face Std Bat LTE 1 RB 24 Offset Mid/Area Scan (7x13x1):** Measurement grid: dx=15mm, dy=15mm

[Info: Interpolated medium parameters used for SAR evaluation.](#)

Maximum value of SAR (measured) = 0.136 W/kg

**Band 12/Face Std Bat LTE 1 RB 24 Offset Mid/Zoom Scan (5x5x7)/Cube 0:** Measurement grid: dx=8mm, dy=8mm, dz=5mm

Reference Value = 5.566 V/m; Power Drift = 0.04 dB

Peak SAR (extrapolated) = 0.149 W/kg

**SAR(1 g) = 0.115 W/kg; SAR(10 g) = 0.085 W/kg**

[Info: Interpolated medium parameters used for SAR evaluation.](#)

Maximum value of SAR (measured) = 0.133 W/kg

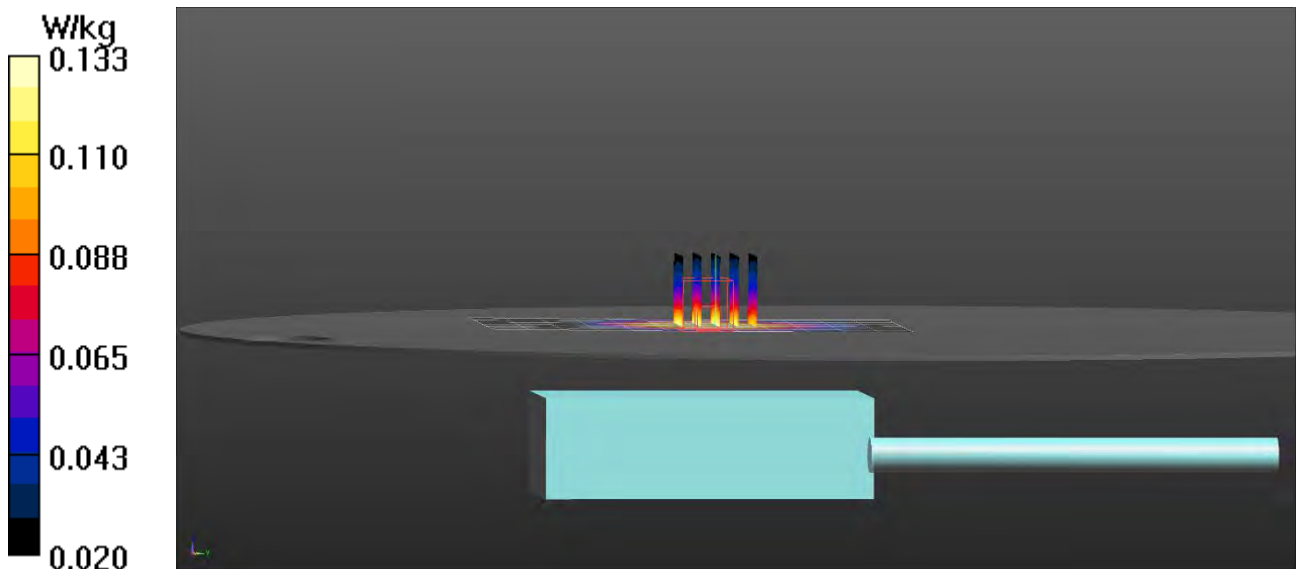

# RF Exposure Lab

## Plot 4

**DUT: IP730D; Type: PTT; Serial: Eng 1**

Communication System: LTE (SC-FDMA, 1 RB, 10 MHz, QPSK); Frequency: 707.5 MHz; Duty Cycle: 1:1  
 Medium: HSL750; Medium parameters used (interpolated):  $f = 707.5$  MHz;  $\sigma = 0.898$  S/m;  $\epsilon_r = 41.798$ ;  $\rho = 1000$  kg/m<sup>3</sup>  
 Phantom section: Flat Section

Test Date: Date: 12/11/2020; Ambient Temp: 23 °C; Tissue Temp: 21 °C

Probe: EX3DV4 - SN7531; ConvF(10.64, 10.64, 10.64); Calibrated: 7/14/2020  
 Sensor-Surface: 2mm (Mechanical Surface Detection)  
 Electronics: DAE4 Sn1416; Calibrated: 4/21/2020  
 Phantom: ELI v5.0; Type: QDOVA002AA; Serial: 2037  
 Measurement SW: DASY52, Version 52.10 (0); SEMCAD X Version 14.6.10 (7417)

### Procedure Notes:

**Band 12/Body Belt Clip Std Bat LTE 1 RB 24 Offset Mid/Area Scan (7x13x1):** Measurement grid: dx=15mm, dy=15mm

[Info: Interpolated medium parameters used for SAR evaluation.](#)  
 Maximum value of SAR (measured) = 0.144 W/kg

**Band 12/Body Belt Clip Std Bat LTE 1 RB 24 Offset Mid/Zoom Scan (5x5x7)/Cube 0:** Measurement grid: dx=8mm, dy=8mm, dz=5mm  
 Reference Value = 5.619 V/m; Power Drift = 0.01 dB  
 Peak SAR (extrapolated) = 0.169 W/kg  
**SAR(1 g) = 0.125 W/kg; SAR(10 g) = 0.090 W/kg**

[Info: Interpolated medium parameters used for SAR evaluation.](#)  
 Maximum value of SAR (measured) = 0.149 W/kg

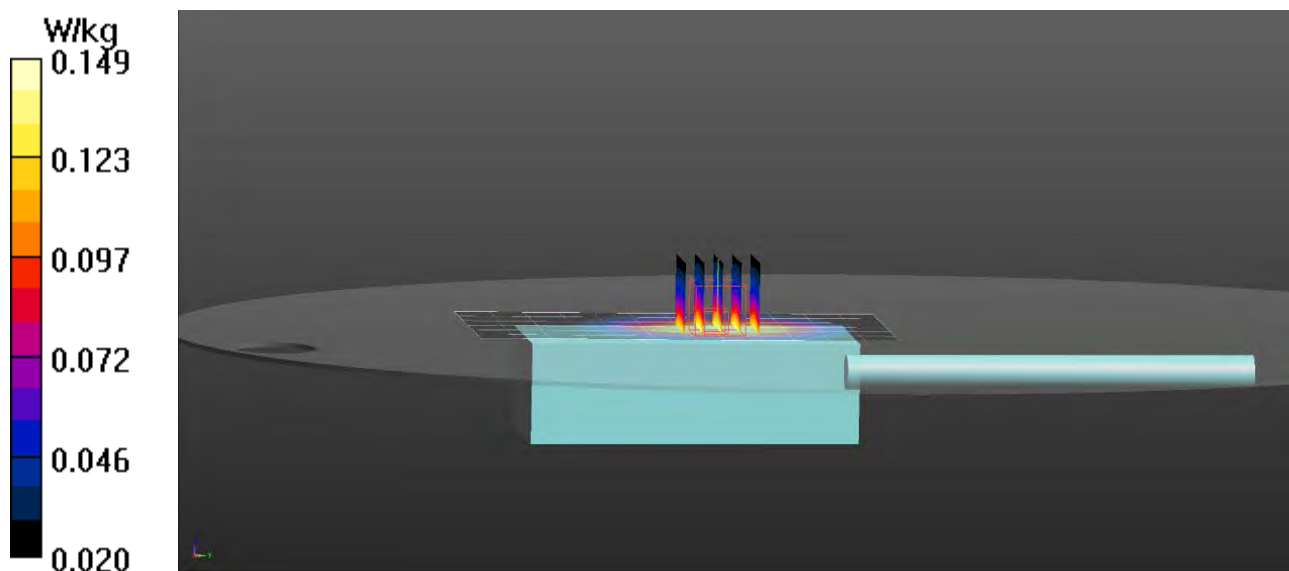



# RF Exposure Lab

## Plot 5

**DUT: IP730D; Type: PTT; Serial: Eng 1**

Communication System: UMTS (WCDMA); Frequency: 836.6 MHz; Duty Cycle: 1:1  
 Medium: HSL835; Medium parameters used (interpolated):  $f = 836.6$  MHz;  $\sigma = 0.947$  S/m;  $\epsilon_r = 41.231$ ;  $\rho = 1000$  kg/m<sup>3</sup>  
 Phantom section: Flat Section

Test Date: Date: 12/10/2020; Ambient Temp: 23 °C; Tissue Temp: 21 °C

Probe: EX3DV4 - SN7531; ConvF(10.26, 10.26, 10.26); Calibrated: 7/14/2020  
 Sensor-Surface: 2mm (Mechanical Surface Detection)  
 Electronics: DAE4 Sn1416; Calibrated: 4/21/2020  
 Phantom: ELI v5.0; Type: QDOVA002AA; Serial: 2037  
 Measurement SW: DASY52, Version 52.10 (0); SEMCAD X Version 14.6.10 (7417)

### Procedure Notes:

**Band 5/Face Std Bat WCDMA Mid/Area Scan (7x13x1):** Measurement grid: dx=15mm, dy=15mm

[Info: Interpolated medium parameters used for SAR evaluation.](#)

Maximum value of SAR (measured) = 0.140 W/kg

**Band 5/Face Std Bat WCDMA Mid/Zoom Scan (5x5x7)/Cube 0:** Measurement grid: dx=8mm, dy=8mm, dz=5mm

Reference Value = 8.066 V/m; Power Drift = 0.03 dB

Peak SAR (extrapolated) = 0.296 W/kg

**SAR(1 g) = 0.158 W/kg; SAR(10 g) = 0.088 W/kg**

[Info: Interpolated medium parameters used for SAR evaluation.](#)

Maximum value of SAR (measured) = 0.143 W/kg

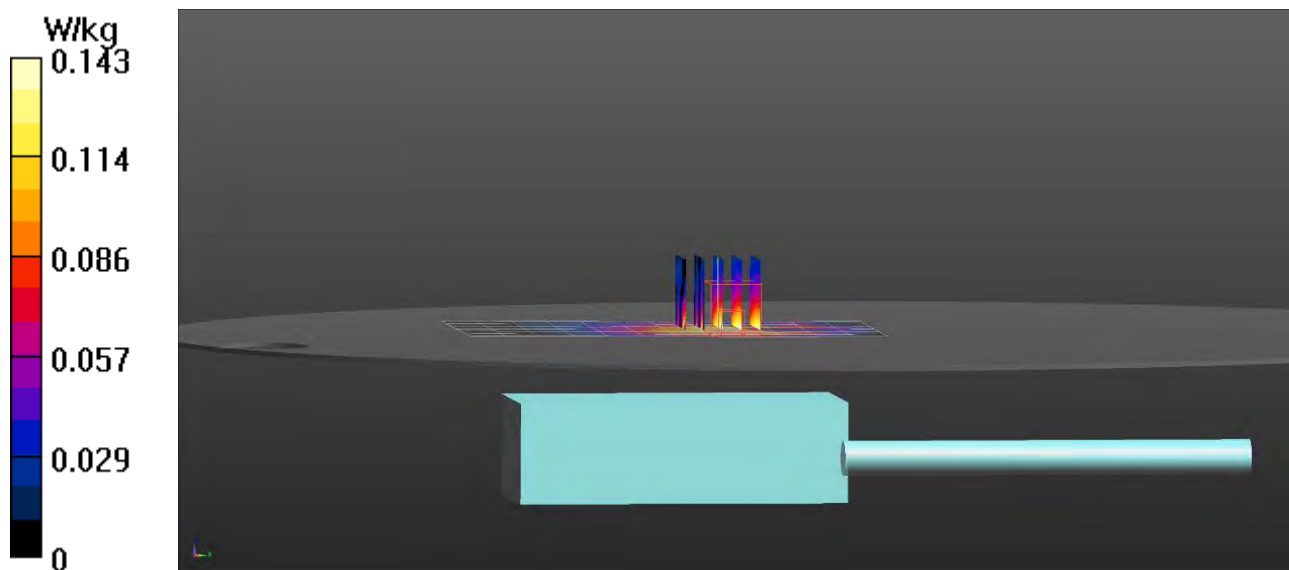

# RF Exposure Lab

## Plot 6

**DUT: IP730D; Type: PTT; Serial: Eng 1**

Communication System: UMTS (WCDMA); Frequency: 836.6 MHz; Duty Cycle: 1:1  
 Medium: HSL835; Medium parameters used (interpolated):  $f = 836.6$  MHz;  $\sigma = 0.947$  S/m;  $\epsilon_r = 41.231$ ;  $\rho = 1000$  kg/m<sup>3</sup>  
 Phantom section: Flat Section

Test Date: Date: 12/10/2020; Ambient Temp: 23 °C; Tissue Temp: 21 °C

Probe: EX3DV4 - SN7531; ConvF(10.26, 10.26, 10.26); Calibrated: 7/14/2020  
 Sensor-Surface: 2mm (Mechanical Surface Detection)  
 Electronics: DAE4 Sn1416; Calibrated: 4/21/2020  
 Phantom: ELI v5.0; Type: QDOVA002AA; Serial: 2037  
 Measurement SW: DASY52, Version 52.10 (0); SEMCAD X Version 14.6.10 (7417)

### Procedure Notes:

**Band 5/Body Belt Clip Std Bat WCDMA Mid/Area Scan (7x13x1):** Measurement grid: dx=15mm, dy=15mm

[Info: Interpolated medium parameters used for SAR evaluation.](#)

Maximum value of SAR (measured) = 0.233 W/kg

**Band 5/Body Belt Clip Std Bat WCDMA Mid/Zoom Scan (5x5x7)/Cube 0:** Measurement grid: dx=8mm, dy=8mm, dz=5mm

Reference Value = 7.501 V/m; Power Drift = 0.01 dB

Peak SAR (extrapolated) = 0.366 W/kg

**SAR(1 g) = 0.232 W/kg; SAR(10 g) = 0.119 W/kg**

[Info: Interpolated medium parameters used for SAR evaluation.](#)

Maximum value of SAR (measured) = 0.232 W/kg

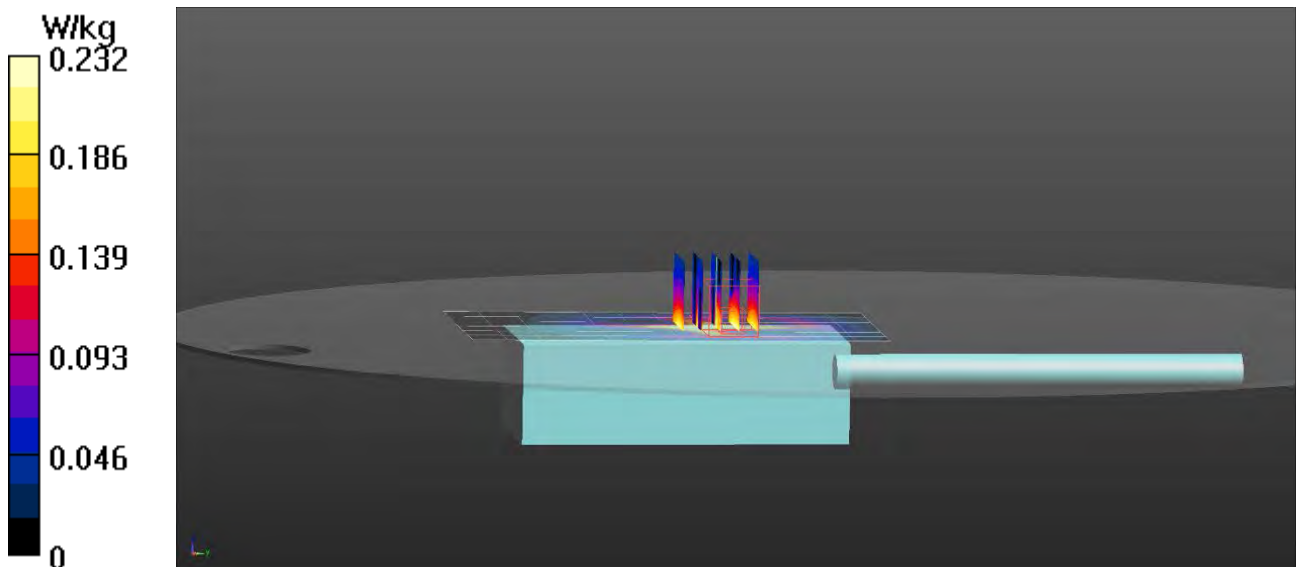

# RF Exposure Lab

## Plot 7

**DUT: IP730D; Type: PTT; Serial: Eng 1**

Communication System: LTE (SC-FDMA, 1 RB, 20 MHz, QPSK); Frequency: 1732.5 MHz; Duty Cycle: 1:1  
 Medium: HSL1750; Medium parameters used (interpolated):  $f = 1732.5$  MHz;  $\sigma = 1.403$  S/m;  $\epsilon_r = 39.665$ ;  $\rho = 1000$  kg/m<sup>3</sup>  
 Phantom section: Flat Section

Test Date: Date: 12/9/2020; Ambient Temp: 23 °C; Tissue Temp: 21 °C

Probe: EX3DV4 - SN7531; ConvF(8.55, 8.55, 8.55); Calibrated: 7/14/2020  
 Sensor-Surface: 2mm (Mechanical Surface Detection)  
 Electronics: DAE4 Sn1416; Calibrated: 4/21/2020  
 Phantom: ELI v5.0; Type: QDOVA002AA; Serial: 2037  
 Measurement SW: DASY52, Version 52.10 (0); SEMCAD X Version 14.6.10 (7417)

### Procedure Notes:

**Band 4/Face Std Bat LTE 1 RB 49 Offset Mid/Area Scan (7x13x1):** Measurement grid: dx=15mm, dy=15mm

[Info: Interpolated medium parameters used for SAR evaluation.](#)

Maximum value of SAR (measured) = 0.209 W/kg

**Band 4/Face Std Bat LTE 1 RB 49 Offset Mid/Zoom Scan (5x5x7)/Cube 0:** Measurement grid: dx=8mm, dy=8mm, dz=5mm

Reference Value = 7.049 V/m; Power Drift = -0.03 dB

Peak SAR (extrapolated) = 0.257 W/kg

**SAR(1 g) = 0.167 W/kg; SAR(10 g) = 0.107 W/kg**

[Info: Interpolated medium parameters used for SAR evaluation.](#)

Maximum value of SAR (measured) = 0.212 W/kg

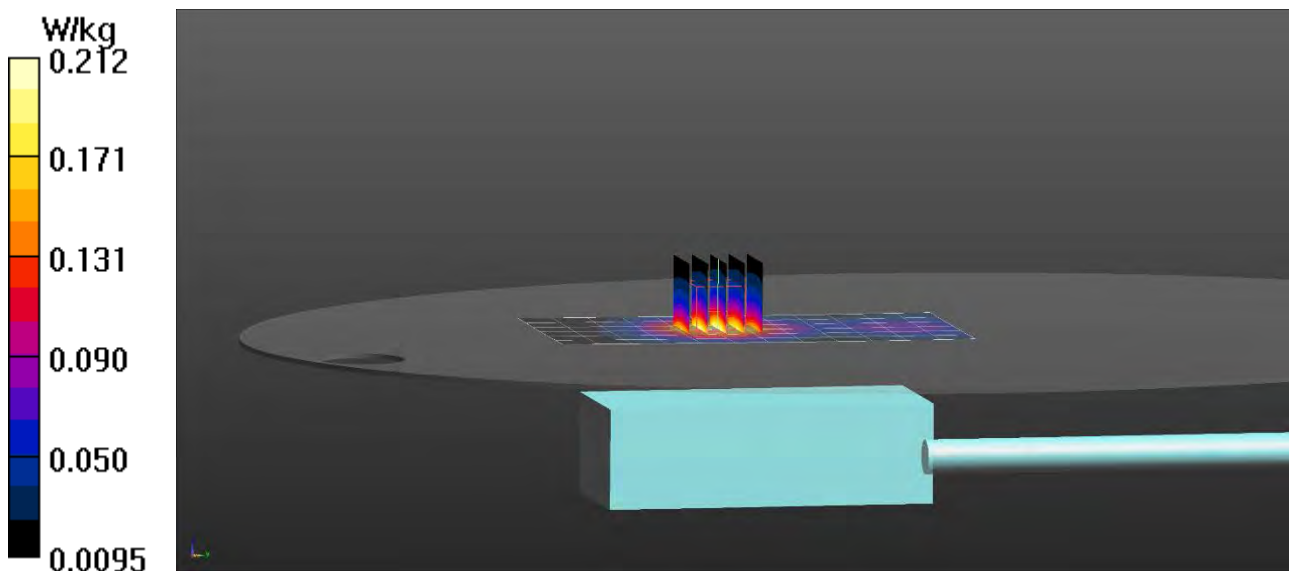

# RF Exposure Lab

## Plot 8

**DUT: IP730D; Type: PTT; Serial: Eng 1**

Communication System: LTE (SC-FDMA, 1 RB, 20 MHz, QPSK); Frequency: 1732.5 MHz; Duty Cycle: 1:1  
 Medium: HSL1750; Medium parameters used (interpolated):  $f = 1732.5$  MHz;  $\sigma = 1.403$  S/m;  $\epsilon_r = 39.665$ ;  $\rho = 1000$  kg/m<sup>3</sup>  
 Phantom section: Flat Section

Test Date: Date: 12/9/2020; Ambient Temp: 23 °C; Tissue Temp: 21 °C

Probe: EX3DV4 - SN7531; ConvF(8.55, 8.55, 8.55); Calibrated: 7/14/2020  
 Sensor-Surface: 2mm (Mechanical Surface Detection)  
 Electronics: DAE4 Sn1416; Calibrated: 4/21/2020  
 Phantom: ELI v5.0; Type: QDOVA002AA; Serial: 2037  
 Measurement SW: DASY52, Version 52.10 (0); SEMCAD X Version 14.6.10 (7417)

### Procedure Notes:

**Band 4/Body Belt Clip Std Bat LTE 1 RB 49 Offset Mid/Area Scan (7x13x1):** Measurement grid: dx=15mm, dy=15mm

[Info: Interpolated medium parameters used for SAR evaluation.](#)  
 Maximum value of SAR (measured) = 0.0868 W/kg

**Band 4/Body Belt Clip Std Bat LTE 1 RB 49 Offset Mid/Zoom Scan (5x5x7)/Cube 0:** Measurement grid: dx=8mm, dy=8mm, dz=5mm

Reference Value = 4.869 V/m; Power Drift = 0.02 dB  
 Peak SAR (extrapolated) = 0.106 W/kg  
**SAR(1 g) = 0.069 W/kg; SAR(10 g) = 0.044 W/kg**

[Info: Interpolated medium parameters used for SAR evaluation.](#)  
 Maximum value of SAR (measured) = 0.0866 W/kg

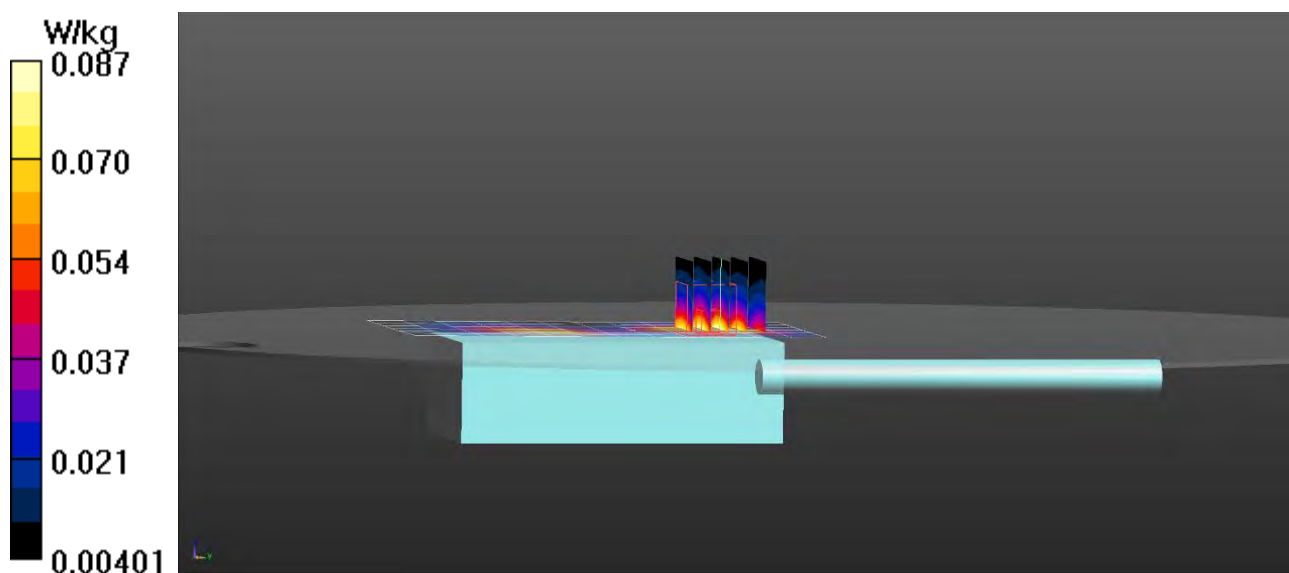

# RF Exposure Lab

## Plot 9

DUT: IP730D; Type: PTT; Serial: Eng 1

Communication System: UMTS (WCDMA); Frequency: 1880 MHz; Duty Cycle: 1:1  
Medium: HSL1900; Medium parameters used:  $f = 1880$  MHz;  $\sigma = 1.44$  S/m;  $\epsilon_r = 39.47$ ;  $\rho = 1000$  kg/m<sup>3</sup>  
Phantom section: Flat Section

Test Date: Date: 12/8/2020; Ambient Temp: 23 °C; Tissue Temp: 21 °C

Probe: EX3DV4 - SN7531; ConvF(8.22, 8.22, 8.22); Calibrated: 7/14/2020  
Sensor-Surface: 2mm (Mechanical Surface Detection)  
Electronics: DAE4 Sn1416; Calibrated: 4/21/2020  
Phantom: ELI v5.0; Type: QDOVA002AA; Serial: 2037  
Measurement SW: DASY52, Version 52.10 (0); SEMCAD X Version 14.6.10 (7417)

### Procedure Notes:

**Band 2/Face Std Bat WCDMA Mid/Area Scan (7x13x1):** Measurement grid: dx=15mm, dy=15mm  
Maximum value of SAR (measured) = 0.180 W/kg

**Band 2/Face Std Bat WCDMA Mid/Zoom Scan (5x5x7)/Cube 0:** Measurement grid: dx=8mm, dy=8mm, dz=5mm  
Reference Value = 6.608 V/m; Power Drift = -0.02 dB  
Peak SAR (extrapolated) = 0.246 W/kg  
**SAR(1 g) = 0.152 W/kg; SAR(10 g) = 0.089 W/kg**  
Maximum value of SAR (measured) = 0.185 W/kg

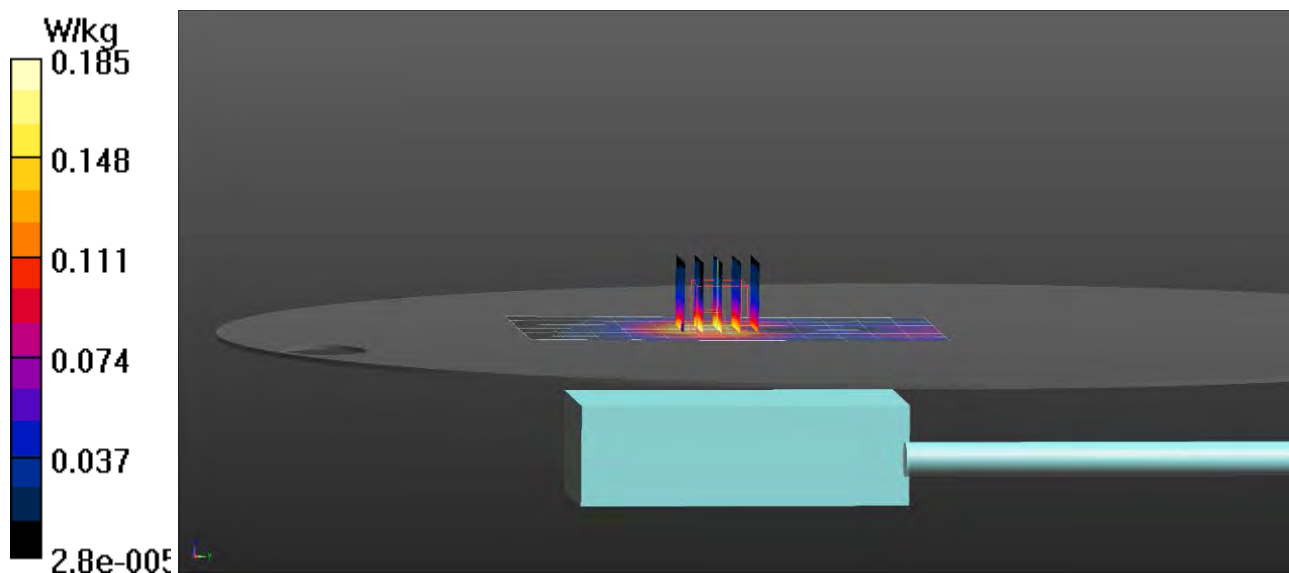

# RF Exposure Lab

## Plot 10

**DUT: IP730D; Type: PTT; Serial: Eng 1**

Communication System: UMTS (WCDMA); Frequency: 1880 MHz; Duty Cycle: 1:1  
Medium: HSL1900; Medium parameters used:  $f = 1880 \text{ MHz}$ ;  $\sigma = 1.44 \text{ S/m}$ ;  $\epsilon_r = 39.47$ ;  $\rho = 1000 \text{ kg/m}^3$   
Phantom section: Flat Section

Test Date: Date: 12/8/2020; Ambient Temp: 23 °C; Tissue Temp: 21 °C

Probe: EX3DV4 - SN7531; ConvF(8.22, 8.22, 8.22); Calibrated: 7/14/2020  
Sensor-Surface: 2mm (Mechanical Surface Detection)  
Electronics: DAE4 Sn1416; Calibrated: 4/21/2020  
Phantom: ELI v5.0; Type: QDOVA002AA; Serial: 2037  
Measurement SW: DASY52, Version 52.10 (0); SEMCAD X Version 14.6.10 (7417)

### Procedure Notes:

**Band 2/Body Belt Clip Std Bat WCDMA Mid/Area Scan (7x13x1):** Measurement grid: dx=15mm, dy=15mm  
Maximum value of SAR (measured) = 0.146 W/kg

**Band 2/Body Belt Clip Std Bat WCDMA Mid/Zoom Scan (5x5x7)/Cube 0:** Measurement grid: dx=8mm, dy=8mm, dz=5mm  
Reference Value = 3.400 V/m; Power Drift = 2.30 dB  
Peak SAR (extrapolated) = 0.224 W/kg  
**SAR(1 g) = 0.092 W/kg; SAR(10 g) = 0.049 W/kg**  
Maximum value of SAR (measured) = 0.138 W/kg

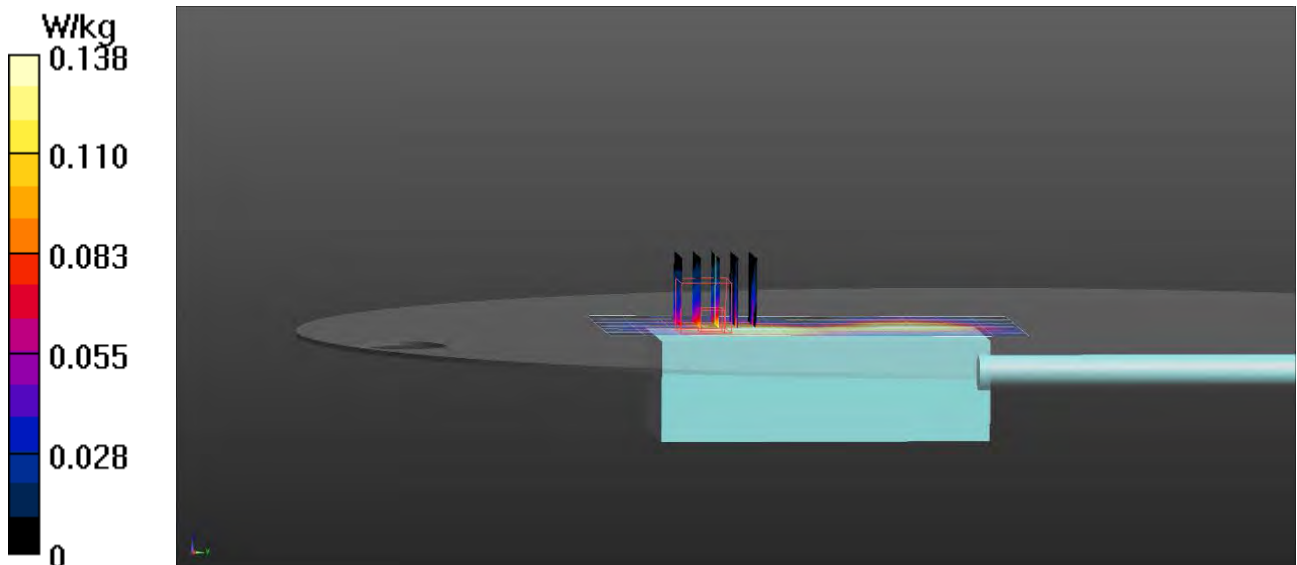

# RF Exposure Lab

## Plot 11

**DUT: IP730D; Type: PTT; Serial: Eng 1**

Communication System: LTE (SC-FDMA, 1 RB, 20 MHz, QPSK); Frequency: 1880 MHz; Duty Cycle: 1:1  
 Medium: HSL1900; Medium parameters used:  $f = 1880 \text{ MHz}$ ;  $\sigma = 1.44 \text{ S/m}$ ;  $\epsilon_r = 39.47$ ;  $\rho = 1000 \text{ kg/m}^3$   
 Phantom section: Flat Section

Test Date: Date: 12/8/2020; Ambient Temp: 23 °C; Tissue Temp: 21 °C

Probe: EX3DV4 - SN7531; ConvF(8.22, 8.22, 8.22); Calibrated: 7/14/2020  
 Sensor-Surface: 2mm (Mechanical Surface Detection)  
 Electronics: DAE4 Sn1416; Calibrated: 4/21/2020  
 Phantom: ELI v5.0; Type: QDOVA002AA; Serial: 2037  
 Measurement SW: DASY52, Version 52.10 (0); SEMCAD X Version 14.6.10 (7417)

### Procedure Notes:

**Band 2/Face Std Bat LTE 1 RB 49 Offset Mid/Area Scan (7x13x1):** Measurement grid: dx=15mm, dy=15mm  
 Maximum value of SAR (measured) = 0.216 W/kg

**Band 2/Face Std Bat LTE 1 RB 49 Offset Mid/Zoom Scan (5x5x7)/Cube 0:** Measurement grid: dx=8mm, dy=8mm, dz=5mm  
 Reference Value = 7.380 V/m; Power Drift = 0.01 dB  
 Peak SAR (extrapolated) = 0.279 W/kg  
**SAR(1 g) = 0.177 W/kg; SAR(10 g) = 0.112 W/kg**  
 Maximum value of SAR (measured) = 0.230 W/kg

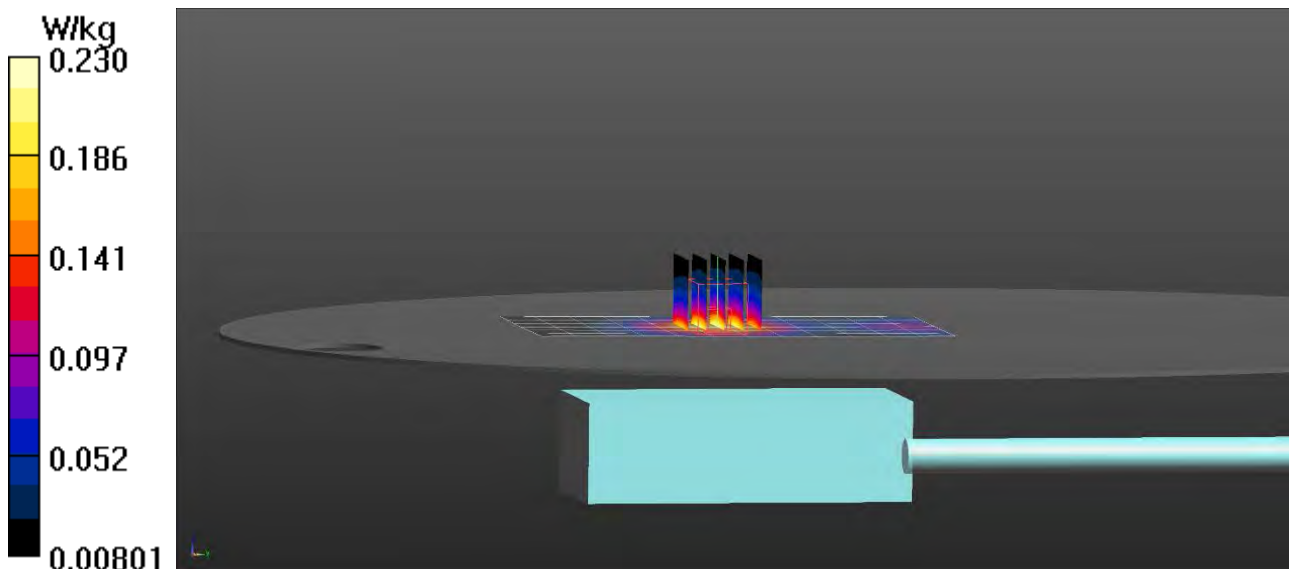

# RF Exposure Lab

## Plot 12

**DUT: IP730D; Type: PTT; Serial: Eng 1**

Communication System: LTE (SC-FDMA, 1 RB, 20 MHz, QPSK); Frequency: 1880 MHz; Duty Cycle: 1:1  
Medium: HSL1900; Medium parameters used:  $f = 1880$  MHz;  $\sigma = 1.44$  S/m;  $\epsilon_r = 39.47$ ;  $\rho = 1000$  kg/m<sup>3</sup>  
Phantom section: Flat Section

Test Date: Date: 12/9/2020; Ambient Temp: 23 °C; Tissue Temp: 21 °C

Probe: EX3DV4 - SN7531; ConvF(8.22, 8.22, 8.22); Calibrated: 7/14/2020  
Sensor-Surface: 2mm (Mechanical Surface Detection)  
Electronics: DAE4 Sn1416; Calibrated: 4/21/2020  
Phantom: ELI v5.0; Type: QDOVA002AA; Serial: 2037  
Measurement SW: DASY52, Version 52.10 (0); SEMCAD X Version 14.6.10 (7417)

### Procedure Notes:

**Band 2/Body Belt Clip Std Bat LTE 1 RB 49 Offset Mid/Area Scan (7x13x1):** Measurement grid: dx=15mm, dy=15mm  
Maximum value of SAR (measured) = 0.156 W/kg

**Band 2/Body Belt Clip Std Bat LTE 1 RB 49 Offset Mid/Zoom Scan (5x5x7)/Cube 0:** Measurement grid: dx=8mm, dy=8mm, dz=5mm  
Reference Value = 5.825 V/m; Power Drift = 0.01 dB  
Peak SAR (extrapolated) = 0.197 W/kg  
**SAR(1 g) = 0.128 W/kg; SAR(10 g) = 0.082 W/kg**  
Maximum value of SAR (measured) = 0.161 W/kg

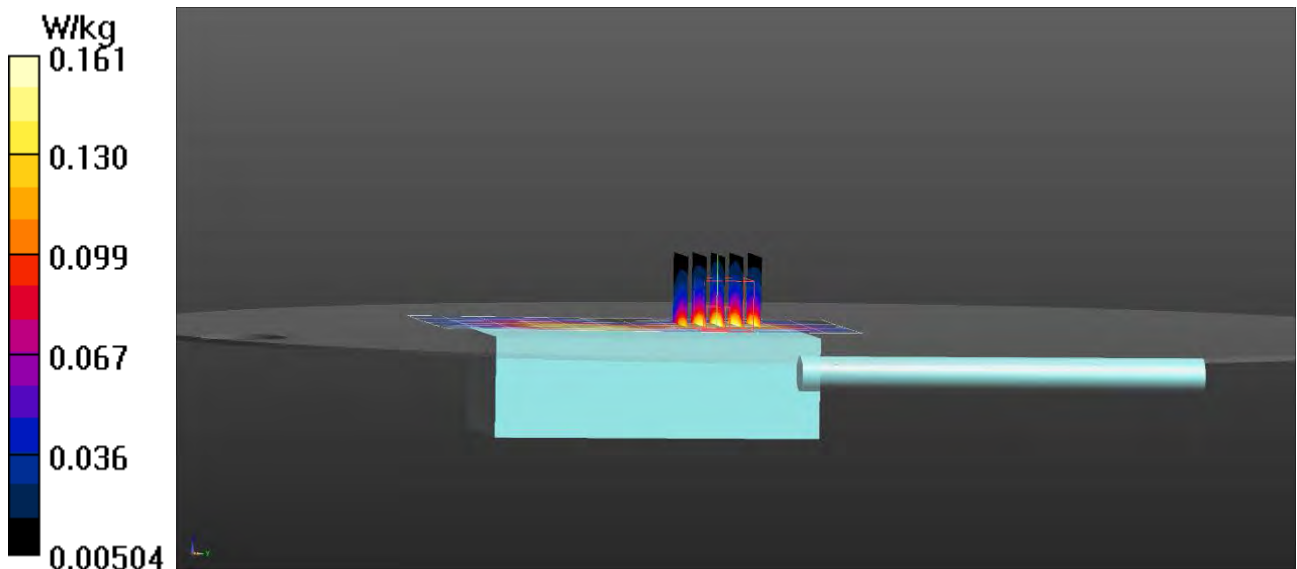



## Appendix C – SAR Test Setup Photos



**Test Position Face 25 mm Gap**



**Test Position Body 0 mm Gap**



**Front of Device with Antenna**



**Back of Device**



**Audio and Body Worn Accessory**

## Appendix D – Probe Calibration Data Sheets

**Calibration Laboratory of  
Schmid & Partner  
Engineering AG**  
Zeughausstrasse 43, 8004 Zurich, Switzerland



**S** Schweizerischer Kalibrierdienst  
**C** Service suisse d'étalonnage  
**S** Servizio svizzero di taratura  
Swiss Calibration Service

Accredited by the Swiss Accreditation Service (SAS)  
The Swiss Accreditation Service is one of the signatories to the EA  
Multilateral Agreement for the recognition of calibration certificates

Accreditation No.: **SCS 0108**

Client **RF Exposure Lab**

Certificate No: **EX3-7531\_Jul20/2**

**CALIBRATION CERTIFICATE (Replacement of No: EX3-7531\_Jul20)**

Object **EX3DV4 - SN:7531**

Calibration procedure(s) **QA CAL-01.v9, QA CAL-12.v9, QA CAL-14.v6, QA CAL-23.v5,  
QA CAL-25.v7  
Calibration procedure for dosimetric E-field probes**

Calibration date: **July 14, 2020**

This calibration certificate documents the traceability to national standards, which realize the physical units of measurements (SI).  
The measurements and the uncertainties with confidence probability are given on the following pages and are part of the certificate.

All calibrations have been conducted in the closed laboratory facility: environment temperature (22 ± 3)°C and humidity < 70%.

Calibration Equipment used (M&TE critical for calibration)

Primary Standards	ID	Cal Date (Certificate No.)	Scheduled Calibration
Power meter NRP	SN: 104778	01-Apr-20 (No. 217-03100/03101)	Apr-21
Power sensor NRP-Z91	SN: 103244	01-Apr-20 (No. 217-03100)	Apr-21
Power sensor NRP-Z91	SN: 103245	01-Apr-20 (No. 217-03101)	Apr-21
Reference 20 dB Attenuator	SN: CC2552 (20x)	31-Mar-20 (No. 217-03106)	Apr-21
DAE4	SN: 660	27-Dec-19 (No. DAE4-660_Dec19)	Dec-20
Reference Probe ES3DV2	SN: 3013	31-Dec-19 (No. ES3-3013_Dec19)	Dec-20
Secondary Standards	ID	Check Date (in house)	Scheduled Check
Power meter E4419B	SN: GB41293874	06-Apr-16 (in house check Jun-20)	In house check: Jun-22
Power sensor E4412A	SN: MY41498087	06-Apr-16 (in house check Jun-20)	In house check: Jun-22
Power sensor E4412A	SN: 000110210	06-Apr-16 (in house check Jun-20)	In house check: Jun-22
RF generator HP 8648C	SN: US3642U01700	04-Aug-99 (in house check Jun-20)	In house check: Jun-22
Network Analyzer E8358A	SN: US41080477	31-Mar-14 (in house check Oct-19)	In house check: Oct-20

Calibrated by: **Jeton Kastrati** (Name) / **Laboratory Technician** (Function) / *[Signature]* (Signature)

Approved by: **Katja Pokovic** (Name) / **Technical Manager** (Function) / *[Signature]* (Signature)

Issued: July 22, 2020

This calibration certificate shall not be reproduced except in full without written approval of the laboratory.



Accredited by the Swiss Accreditation Service (SAS)

Accreditation No.: **SCS 0108**

The Swiss Accreditation Service is one of the signatories to the EA  
Multilateral Agreement for the recognition of calibration certificates

**Glossary:**

TSL	tissue simulating liquid
NORM <sub>x,y,z</sub>	sensitivity in free space
ConvF	sensitivity in TSL / NORM <sub>x,y,z</sub>
DCP	diode compression point
CF	crest factor (1/duty_cycle) of the RF signal
A, B, C, D	modulation dependent linearization parameters
Polarization $\varphi$	$\varphi$ rotation around probe axis
Polarization $\vartheta$	$\vartheta$ rotation around an axis that is in the plane normal to probe axis (at measurement center), i.e., $\vartheta = 0$ is normal to probe axis
Connector Angle	information used in DASY system to align probe sensor X to the robot coordinate system

**Calibration is Performed According to the Following Standards:**

- a) IEEE Std 1528-2013, "IEEE Recommended Practice for Determining the Peak Spatial-Averaged Specific Absorption Rate (SAR) in the Human Head from Wireless Communications Devices: Measurement Techniques", June 2013
- b) IEC 62209-1, "Measurement procedure for the assessment of Specific Absorption Rate (SAR) from hand-held and body-mounted devices used next to the ear (frequency range of 300 MHz to 6 GHz)", July 2016
- c) IEC 62209-2, "Procedure to determine the Specific Absorption Rate (SAR) for wireless communication devices used in close proximity to the human body (frequency range of 30 MHz to 6 GHz)", March 2010
- d) KDB 865664, "SAR Measurement Requirements for 100 MHz to 6 GHz"

**Methods Applied and Interpretation of Parameters:**

- *NORM<sub>x,y,z</sub>*: Assessed for E-field polarization  $\vartheta = 0$  ( $f \leq 900$  MHz in TEM-cell;  $f > 1800$  MHz: R22 waveguide). *NORM<sub>x,y,z</sub>* are only intermediate values, i.e., the uncertainties of *NORM<sub>x,y,z</sub>* does not affect the  $E^2$ -field uncertainty inside TSL (see below *ConvF*).
- *NORM(f)<sub>x,y,z</sub> = NORM<sub>x,y,z</sub> \* frequency\_response* (see Frequency Response Chart). This linearization is implemented in DASY4 software versions later than 4.2. The uncertainty of the frequency response is included in the stated uncertainty of *ConvF*.
- *DCP<sub>x,y,z</sub>*: DCP are numerical linearization parameters assessed based on the data of power sweep with CW signal (no uncertainty required). DCP does not depend on frequency nor media.
- *PAR*: PAR is the Peak to Average Ratio that is not calibrated but determined based on the signal characteristics
- *A<sub>x,y,z</sub>; B<sub>x,y,z</sub>; C<sub>x,y,z</sub>; D<sub>x,y,z</sub>; VR<sub>x,y,z</sub>*: A, B, C, D are numerical linearization parameters assessed based on the data of power sweep for specific modulation signal. The parameters do not depend on frequency nor media. VR is the maximum calibration range expressed in RMS voltage across the diode.
- *ConvF and Boundary Effect Parameters*: Assessed in flat phantom using E-field (or Temperature Transfer Standard for  $f \leq 800$  MHz) and inside waveguide using analytical field distributions based on power measurements for  $f > 800$  MHz. The same setups are used for assessment of the parameters applied for boundary compensation (alpha, depth) of which typical uncertainty values are given. These parameters are used in DASY4 software to improve probe accuracy close to the boundary. The sensitivity in TSL corresponds to *NORM<sub>x,y,z</sub> \* ConvF* whereby the uncertainty corresponds to that given for *ConvF*. A frequency dependent *ConvF* is used in DASY version 4.4 and higher which allows extending the validity from  $\pm 50$  MHz to  $\pm 100$  MHz.
- *Spherical isotropy (3D deviation from isotropy)*: in a field of low gradients realized using a flat phantom exposed by a patch antenna.
- *Sensor Offset*: The sensor offset corresponds to the offset of virtual measurement center from the probe tip (on probe axis). No tolerance required.
- *Connector Angle*: The angle is assessed using the information gained by determining the *NORM<sub>x</sub>* (no uncertainty required).



## DASY/EASY - Parameters of Probe: EX3DV4 - SN:7531

### Basic Calibration Parameters

	Sensor X	Sensor Y	Sensor Z	Unc (k=2)
Norm ( $\mu\text{V}/(\text{V}/\text{m})^2$ ) <sup>A</sup>	0.39	0.47	0.39	$\pm 10.1 \%$
DCP (mV) <sup>B</sup>	98.5	98.5	103.6	

### Calibration Results for Modulation Response

UID	Communication System Name		A dB	B dB $\sqrt{\mu\text{V}}$	C	D dB	VR mV	Max dev.	Unc <sup>E</sup> (k=2)
0	CW	X	0.0	0.0	1.0	0.00	142.3	$\pm 3.0 \%$	$\pm 4.7 \%$
		Y	0.0	0.0	1.0		136.0		
		Z	0.0	0.0	1.0		138.4		

The reported uncertainty of measurement is stated as the standard uncertainty of measurement multiplied by the coverage factor  $k=2$ , which for a normal distribution corresponds to a coverage probability of approximately 95%.

<sup>A</sup> The uncertainties of Norm X,Y,Z do not affect the  $E^2$ -field uncertainty inside TSL (see Page 5).

<sup>B</sup> Numerical linearization parameter: uncertainty not required.

<sup>E</sup> Uncertainty is determined using the max. deviation from linear response applying rectangular distribution and is expressed for the square of the field value.

## DASY/EASY - Parameters of Probe: EX3DV4 - SN:7531

### Other Probe Parameters

Sensor Arrangement	Triangular
Connector Angle (°)	-173.3
Mechanical Surface Detection Mode	enabled
Optical Surface Detection Mode	disabled
Probe Overall Length	337 mm
Probe Body Diameter	10 mm
Tip Length	9 mm
Tip Diameter	2.5 mm
Probe Tip to Sensor X Calibration Point	1 mm
Probe Tip to Sensor Y Calibration Point	1 mm
Probe Tip to Sensor Z Calibration Point	1 mm
Recommended Measurement Distance from Surface	1.4 mm

**Note:** Measurement distance from surface can be increased to 3-4 mm for an *Area Scan* job.

## DASY/EASY - Parameters of Probe: EX3DV4 - SN:7531

### Calibration Parameter Determined in Head Tissue Simulating Media

f (MHz) <sup>C</sup>	Relative Permittivity <sup>F</sup>	Conductivity (S/m) <sup>F</sup>	ConvF X	ConvF Y	ConvF Z	Alpha <sup>G</sup>	Depth <sup>G</sup> (mm)	Unc (k=2)
150	52.3	0.76	12.88	12.88	12.88	0.00	1.00	± 13.3 %
220	49.0	0.81	12.66	12.66	12.66	0.00	1.00	± 13.3 %
300	45.3	0.87	12.13	12.13	12.13	0.03	1.30	± 13.3 %
450	43.5	0.87	11.31	11.31	11.31	0.13	1.30	± 13.3 %
600	42.7	0.88	10.87	10.87	10.87	0.08	1.30	± 13.3 %
750	41.9	0.89	10.64	10.64	10.64	0.29	1.14	± 12.0 %
900	41.5	0.97	10.26	10.26	10.26	0.46	0.82	± 12.0 %
1750	40.1	1.37	8.55	8.55	8.55	0.34	0.86	± 12.0 %
1900	40.0	1.40	8.22	8.22	8.22	0.30	0.86	± 12.0 %
2300	39.5	1.67	7.96	7.96	7.96	0.31	0.90	± 12.0 %
2450	39.2	1.80	7.61	7.61	7.61	0.29	0.90	± 12.0 %
2600	39.0	1.96	7.48	7.48	7.48	0.38	0.90	± 12.0 %
3500	37.9	2.91	6.73	6.73	6.73	0.40	1.35	± 13.1 %
3700	37.7	3.12	6.42	6.42	6.42	0.40	1.35	± 13.1 %
5250	35.9	4.71	5.20	5.20	5.20	0.40	1.80	± 13.1 %
5600	35.5	5.07	4.66	4.66	4.66	0.40	1.80	± 13.1 %
5750	35.4	5.22	4.80	4.80	4.80	0.40	1.80	± 13.1 %

<sup>C</sup> Frequency validity above 300 MHz of ± 100 MHz only applies for DASY v4.4 and higher (see Page 2), else it is restricted to ± 50 MHz. The uncertainty is the RSS of the ConvF uncertainty at calibration frequency and the uncertainty for the indicated frequency band. Frequency validity below 300 MHz is ± 10, 25, 40, 50 and 70 MHz for ConvF assessments at 30, 64, 128, 150 and 220 MHz respectively. Validity of ConvF assessed at 6 MHz is 4-9 MHz, and ConvF assessed at 13 MHz is 9-19 MHz. Above 5 GHz frequency validity can be extended to ± 110 MHz.

<sup>F</sup> At frequencies below 3 GHz, the validity of tissue parameters ( $\epsilon$  and  $\sigma$ ) can be relaxed to ± 10% if liquid compensation formula is applied to measured SAR values. At frequencies above 3 GHz, the validity of tissue parameters ( $\epsilon$  and  $\sigma$ ) is restricted to ± 5%. The uncertainty is the RSS of the ConvF uncertainty for indicated target tissue parameters.

<sup>G</sup> Alpha/Depth are determined during calibration. SPEAG warrants that the remaining deviation due to the boundary effect after compensation is always less than ± 1% for frequencies below 3 GHz and below ± 2% for frequencies between 3-6 GHz at any distance larger than half the probe tip diameter from the boundary.

### Frequency Response of E-Field (TEM-Cell:ifi110 EXX, Waveguide: R22)

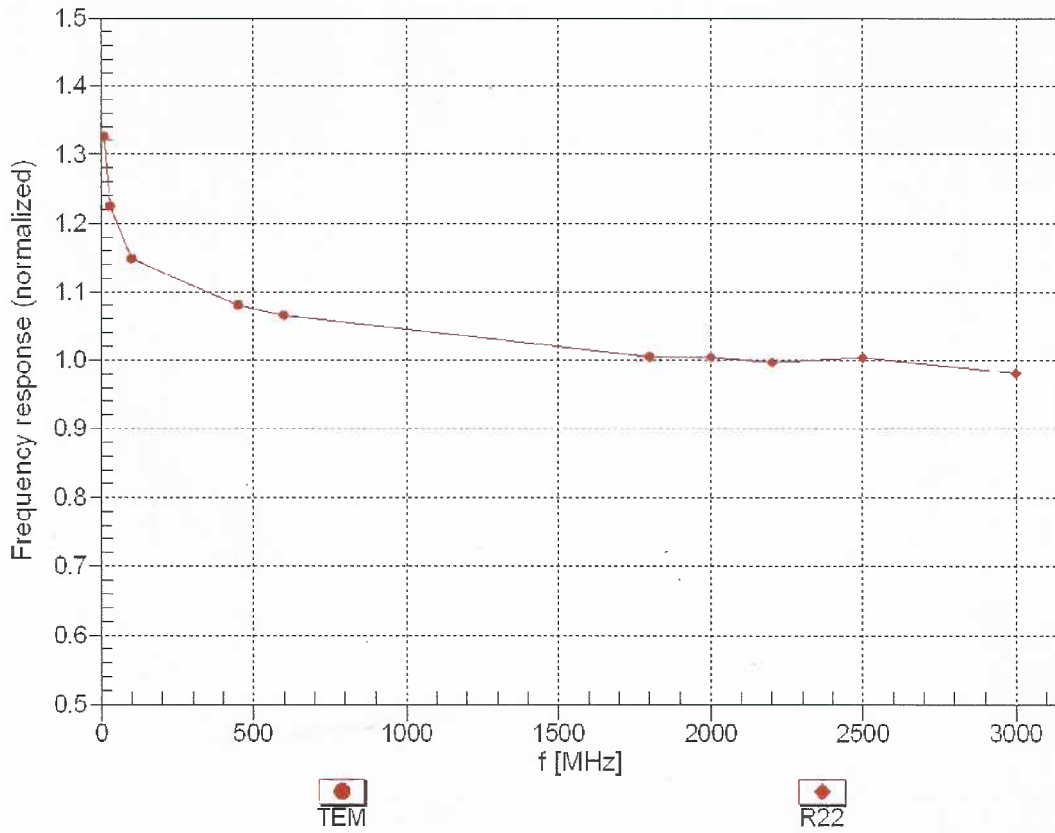

Uncertainty of Frequency Response of E-field:  $\pm 6.3\%$  (k=2)

### Receiving Pattern ( $\phi$ ), $\theta = 0^\circ$

f=600 MHz,TEM

f=1800 MHz,R22

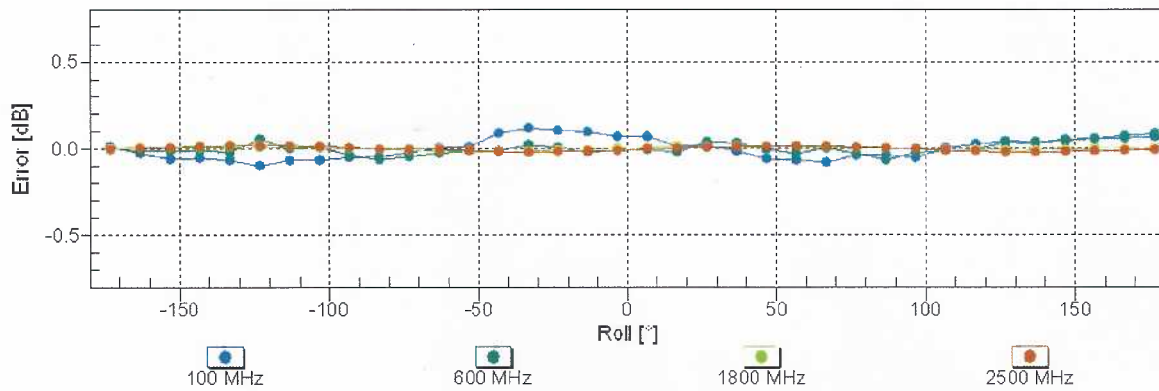
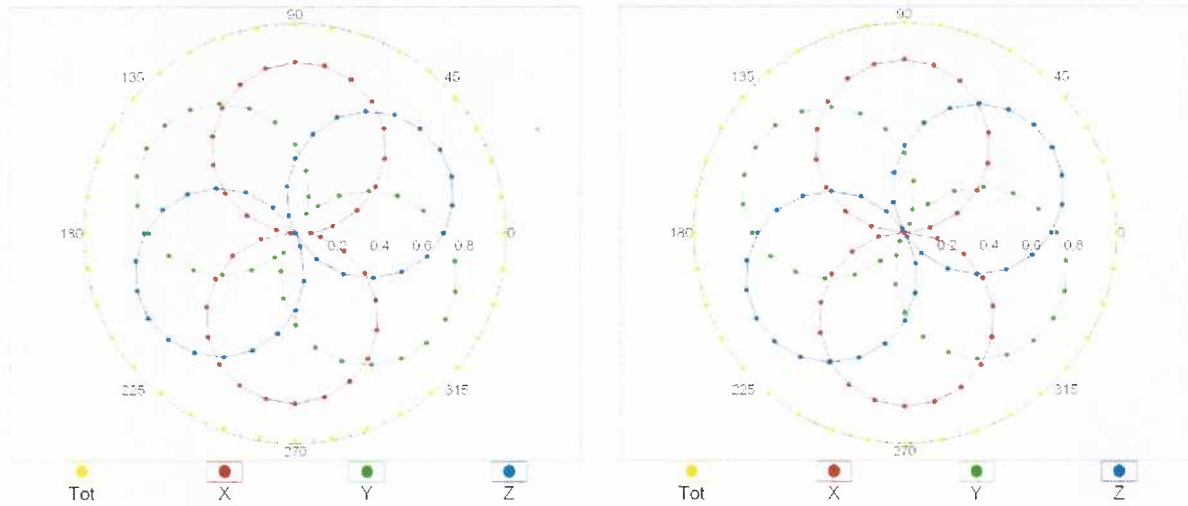

Uncertainty of Axial Isotropy Assessment:  $\pm 0.5\%$  (k=2)

## Dynamic Range $f(SAR_{head})$ (TEM cell , $f_{eval} = 1900$ MHz)

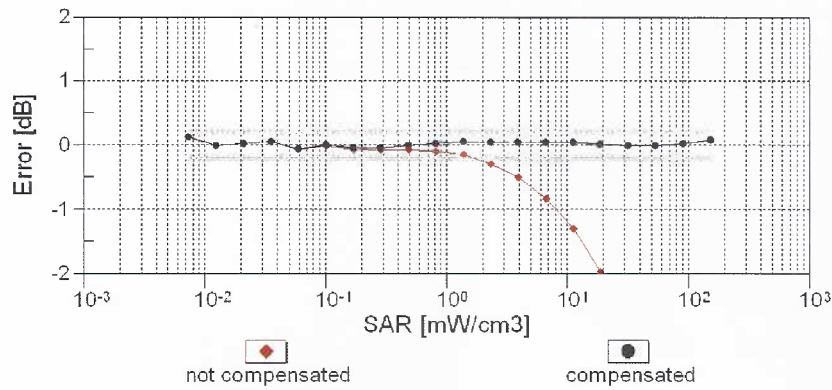
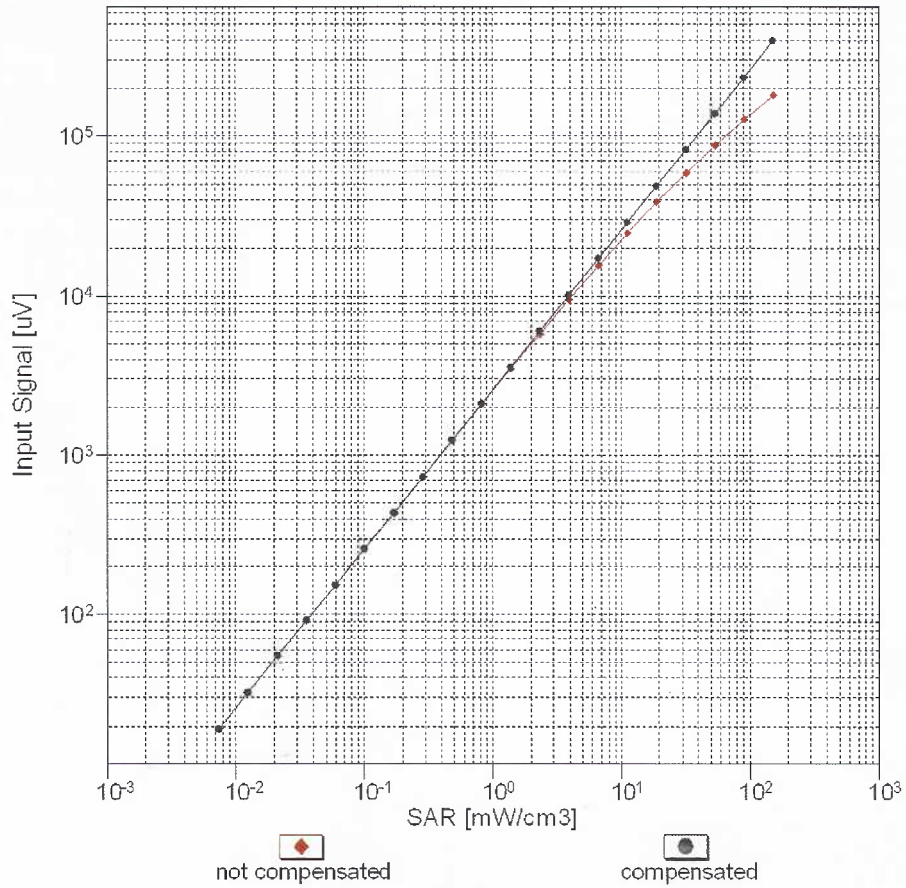

**Uncertainty of Linearity Assessment:  $\pm 0.6\%$  ( $k=2$ )**

# Conversion Factor Assessment

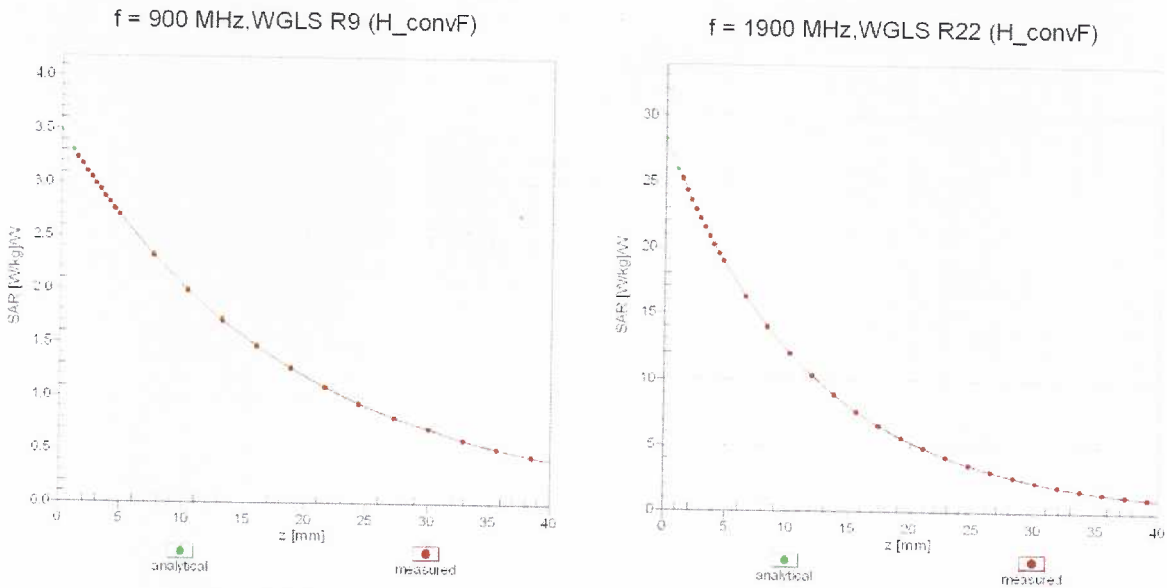

## Deviation from Isotropy in Liquid Error ( $\phi, \theta$ ), f = 900 MHz

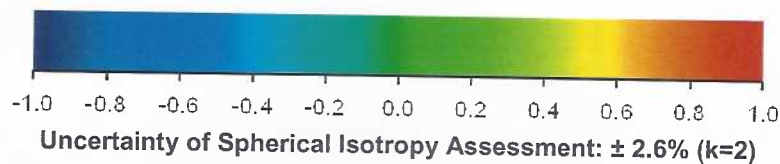
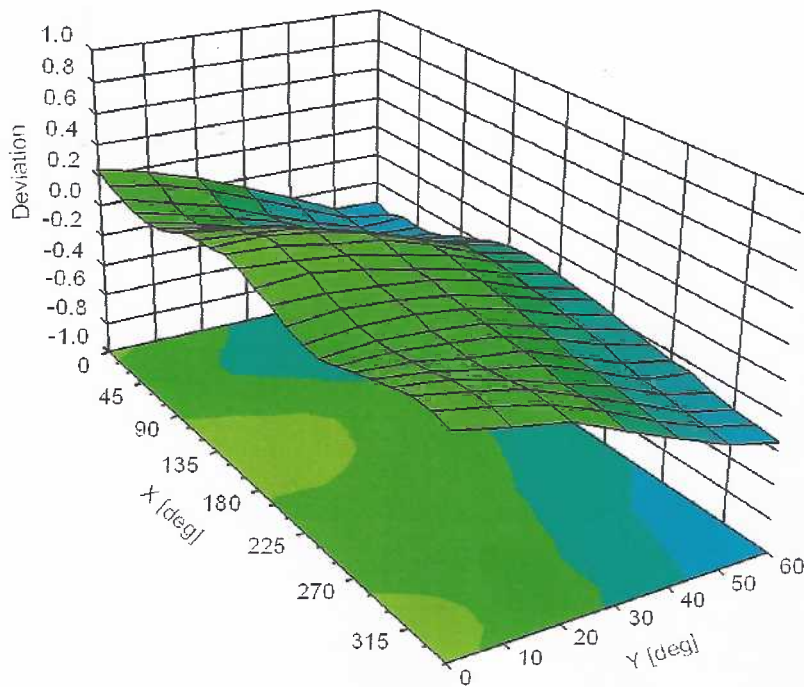

## Appendix E – Dipole Calibration Data Sheets



*Jm*

**Calibration Laboratory of  
Schmid & Partner  
Engineering AG**  
Zeughausstrasse 43, 8004 Zurich, Switzerland



**S** Schweizerischer Kalibrierdienst  
**C** Service suisse d'étalonnage  
**S** Servizio svizzero di taratura  
**S** Swiss Calibration Service

Accredited by the Swiss Accreditation Service (SAS)  
**The Swiss Accreditation Service is one of the signatories to the EA  
Multilateral Agreement for the recognition of calibration certificates**

Accreditation No.: **SCS 0108**

Client **RF Exposure Lab**

Certificate No: **CLA150-4002\_Nov19**

## CALIBRATION CERTIFICATE

Object **CLA150 - SN: 4002**

Calibration procedure(s) **QA CAL-15.v9  
Calibration Procedure for SAR Validation Sources below 700 MHz**

Calibration date: **November 15, 2019**

This calibration certificate documents the traceability to national standards, which realize the physical units of measurements (SI).  
The measurements and the uncertainties with confidence probability are given on the following pages and are part of the certificate.

All calibrations have been conducted in the closed laboratory facility: environment temperature ( $22 \pm 3$ )°C and humidity < 70%.

Calibration Equipment used (M&TE critical for calibration)

Primary Standards	ID #	Cal Date (Certificate No.)	Scheduled Calibration
Power meter NRP	SN: 104778	03-Apr-19 (No. 217-02892/02893)	Apr-20
Power sensor NRP-Z91	SN: 103244	03-Apr-19 (No. 217-02892)	Apr-20
Power sensor NRP-Z91	SN: 103245	03-Apr-19 (No. 217-02893)	Apr-20
Reference 20 dB Attenuator	SN: 5277 (20x)	04-Apr-19 (No. 217-02894)	Apr-20
Type-N mismatch combination	SN: 5047.2 / 06327	04-Apr-19 (No. 217-02895)	Apr-20
Reference Probe EX3DV4	SN: 3877	31-Dec-18 (No. EX3-3877_Dec18)	Dec-19
DAE4	SN: 654	27-Jun-19 (No. DAE4-654_Jun19)	Jun-20

Secondary Standards	ID #	Check Date (in house)	Scheduled Check
Power meter E4419B	SN: GB41293874	06-Apr-16 (in house check Jun-18)	In house check: Jun-20
Power sensor E4412A	SN: MY41498087	06-Apr-16 (in house check Jun-18)	In house check: Jun-20
Power sensor E4412A	SN: 000110210	06-Apr-16 (in house check Jun-18)	In house check: Jun-20
RF generator HP 8648C	SN: US3642U01700	04-Aug-99 (in house check Jun-18)	In house check: Jun-20
Network Analyzer Agilent E8358A	SN: US41080477	31-Mar-14 (in house check Oct-19)	In house check: Oct-20

	Name	Function	Signature
Calibrated by:	<b>Jeton Kastrati</b>	<b>Laboratory Technician</b>	

	Name	Function	Signature
Approved by:	<b>Katja Pokovic</b>	<b>Technical Manager</b>	

Issued: November 21, 2019

This calibration certificate shall not be reproduced except in full without written approval of the laboratory.



Accredited by the Swiss Accreditation Service (SAS)

The Swiss Accreditation Service is one of the signatories to the EA  
Multilateral Agreement for the recognition of calibration certificates

Accreditation No.: **SCS 0108**

### Glossary:

TSL	tissue simulating liquid
ConvF	sensitivity in TSL / NORM x,y,z
N/A	not applicable or not measured

### Calibration is Performed According to the Following Standards:

- IEEE Std 1528-2013, "IEEE Recommended Practice for Determining the Peak Spatial-Averaged Specific Absorption Rate (SAR) in the Human Head from Wireless Communications Devices: Measurement Techniques", June 2013
- IEC 62209-1, "Measurement procedure for the assessment of Specific Absorption Rate (SAR) from hand-held and body-mounted devices used next to the ear (frequency range of 300 MHz to 6 GHz)", July 2016
- IEC 62209-2, "Procedure to determine the Specific Absorption Rate (SAR) for wireless communication devices used in close proximity to the human body (frequency range of 30 MHz to 6 GHz)", March 2010
- KDB 865664, "SAR Measurement Requirements for 100 MHz to 6 GHz"

### Additional Documentation:

- DASY4/5 System Handbook

### Methods Applied and Interpretation of Parameters:

- Measurement Conditions:** Further details are available from the Validation Report at the end of the certificate. All figures stated in the certificate are valid at the frequency indicated.
- Antenna Parameters with TSL:** The source is mounted in a touch configuration below the center marking of the flat phantom.
- Return Loss:** This parameter is measured with the source positioned under the liquid filled phantom (as described in the measurement condition clause). The Return Loss ensures low reflected power. No uncertainty required.
- SAR measured:** SAR measured at the stated antenna input power.
- SAR normalized:** SAR as measured, normalized to an input power of 1 W at the antenna connector.
- SAR for nominal TSL parameters:** The measured TSL parameters are used to calculate the nominal SAR result.

The reported uncertainty of measurement is stated as the standard uncertainty of measurement multiplied by the coverage factor  $k=2$ , which for a normal distribution corresponds to a coverage probability of approximately 95%.

## Measurement Conditions

DASY system configuration, as far as not given on page 1.

<b>DASY Version</b>	DASY5	V52.10.3
<b>Extrapolation</b>	Advanced Extrapolation	
<b>Phantom</b>	ELI4 Flat Phantom	Shell thickness: $2 \pm 0.2$ mm
<b>EUT Positioning</b>	Touch Position	
<b>Zoom Scan Resolution</b>	$dx, dy = 4.0$ mm, $dz = 1.4$ mm	Graded Ratio = 1.4 (Z direction)
<b>Frequency</b>	$150$ MHz $\pm 1$ MHz	

## Head TSL parameters

The following parameters and calculations were applied.

	Temperature	Permittivity	Conductivity
<b>Nominal Head TSL parameters</b>	22.0 °C	52.3	0.76 mho/m
<b>Measured Head TSL parameters</b>	$(22.0 \pm 0.2)$ °C	$51.1 \pm 6$ %	$0.76$ mho/m $\pm 6$ %
<b>Head TSL temperature change during test</b>	$< 0.5$ °C	----	----

## SAR result with Head TSL

<b>SAR averaged over 1 cm<sup>3</sup> (1 g) of Head TSL</b>	Condition	
SAR measured	1 W input power	3.89 W/kg
SAR for nominal Head TSL parameters	normalized to 1W	<b>3.87 W/kg <math>\pm 18.4</math> % (k=2)</b>

<b>SAR averaged over 10 cm<sup>3</sup> (10 g) of Head TSL</b>	condition	
SAR measured	1 W input power	2.58 W/kg
SAR for nominal Head TSL parameters	normalized to 1W	<b>2.57 W/kg <math>\pm 18.0</math> % (k=2)</b>

## Appendix (Additional assessments outside the scope of SCS 0108)

### Antenna Parameters with Head TSL

Impedance, transformed to feed point	45.8 $\Omega$ - 8.3 j $\Omega$
Return Loss	- 20.3 dB

### Additional EUT Data

Manufactured by	SPEAG
-----------------	-------

#### Extended Calibration

Usage of SAR dipoles calibrated less than 3 years ago but more than 1 year ago were confirmed in maintaining return loss (<-20 dB, within 20% of prior calibration) and impedance (within 5 ohm from prior calibration) requirements per extended calibrations in KDB Publication 865664 D01 v01r04.

CLA150 SN: 4002 - Head						
Date of Measurement	Return Loss (dB)	$\Delta\%$	Impedance Real ( $\Omega$ )	$\Delta\Omega$	Impedance Imaginary (j $\Omega$ )	$\Delta\Omega$
11/15/2019	-20.3		45.8		-8.3	
11/15/2020	-21.5	5.9	44.1	-1.7	-7.9	0.4

# DASY5 Validation Report for Head TSL

Date: 15.11.2019

Test Laboratory: SPEAG, Zurich, Switzerland

**DUT: CLA150; Type: CLA150; Serial: CLA150 - SN: 4002**

Communication System: UID 0 - CW; Frequency: 150 MHz

Medium parameters used:  $f = 150$  MHz;  $\sigma = 0.76$  S/m;  $\epsilon_r = 51.1$ ;  $\rho = 1000$  kg/m<sup>3</sup>

Phantom section: Flat Section

Measurement Standard: DASY5 (IEEE/IEC/ANSI C63.19-2011)

DASY52 Configuration:

- Probe: EX3DV4 - SN3877; ConvF(12.4, 12.4, 12.4) @ 150 MHz; Calibrated: 31.12.2018
- Sensor-Surface: 1.4mm (Mechanical Surface Detection)
- Electronics: DAE4 Sn654; Calibrated: 27.06.2019
- Phantom: ELI v4.0; Type: QDOVA001BB; Serial: TP:1003
- DASY52 52.10.3(1513); SEMCAD X 14.6.13(7474)

**CLA Calibration for HSL-LF Tissue/CLA150, touch configuration, Pin=1W/Area Scan (81x81x1):** Interpolated grid: dx=1.500 mm, dy=1.500 mm  
Maximum value of SAR (interpolated) = 5.48 W/kg

**CLA Calibration for HSL-LF Tissue/CLA150, touch configuration, Pin=1W/Zoom Scan, dist=1.4mm (8x10x7)/Cube 0:** Measurement grid: dx=4mm, dy=4mm, dz=1.4mm  
Reference Value = 83.39 V/m; Power Drift = 0.04 dB  
Peak SAR (extrapolated) = 7.10 W/kg  
**SAR(1 g) = 3.89 W/kg; SAR(10 g) = 2.58 W/kg**  
Ratio of SAR at M2 to SAR at M1 = 82.4%  
Maximum value of SAR (measured) = 5.38 W/kg

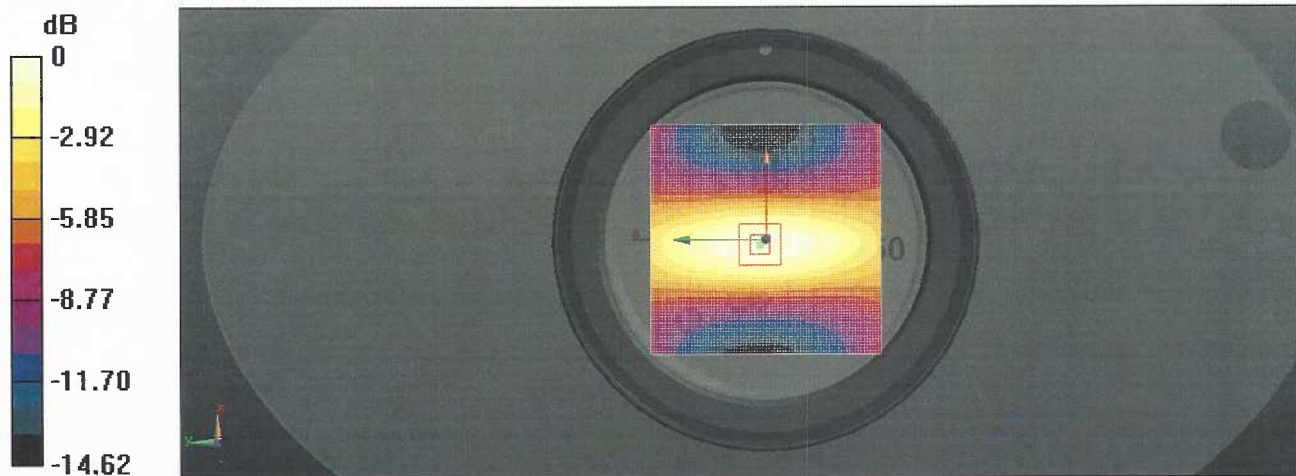

0 dB = 5.48 W/kg = 7.39 dBW/kg

# Impedance Measurement Plot for Head TSL

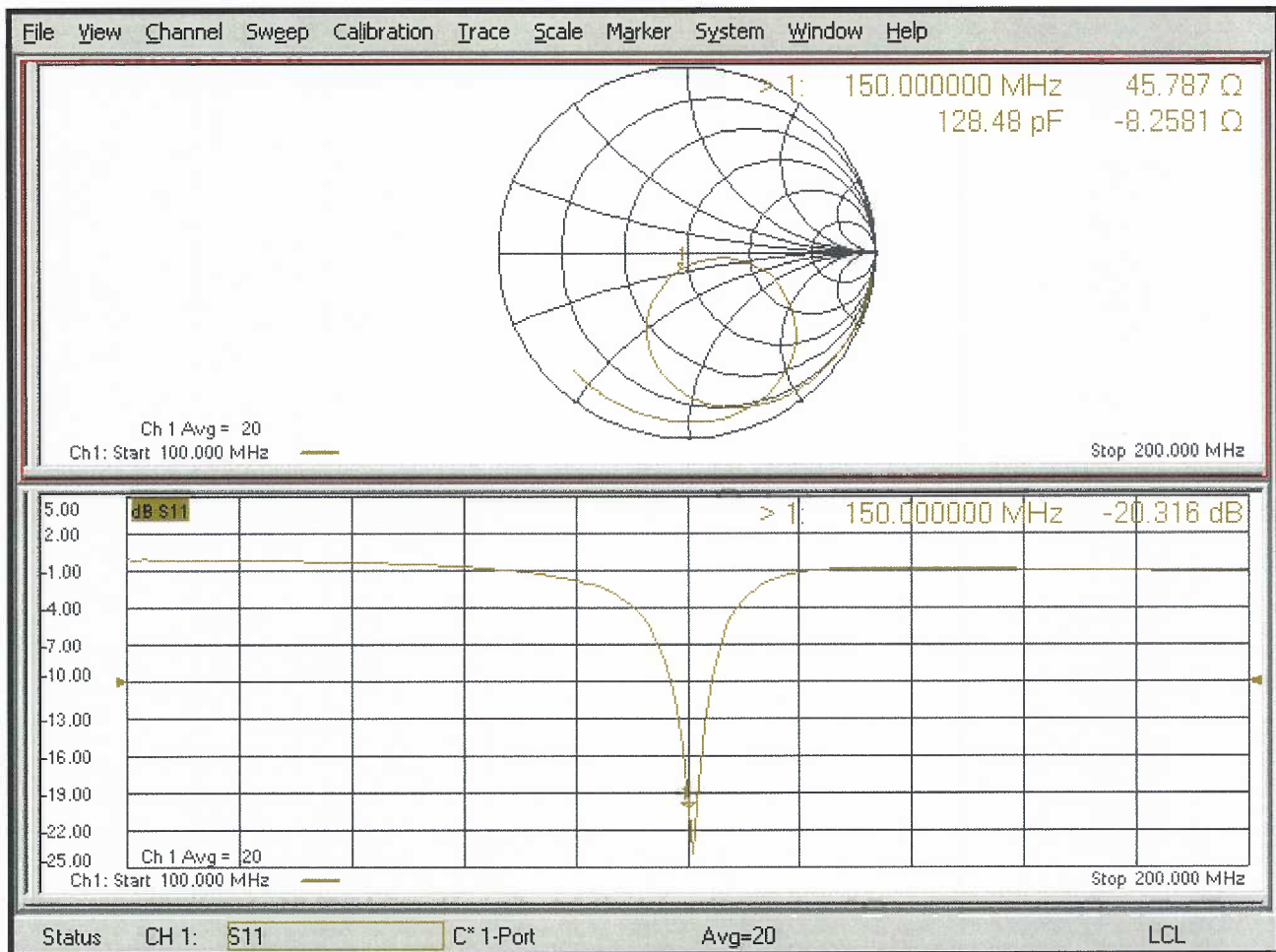



Accredited by the Swiss Accreditation Service (SAS)  
The Swiss Accreditation Service is one of the signatories to the EA  
Multilateral Agreement for the recognition of calibration certificates

Accreditation No.: **SCS 0108**

Client **RF Exposure Lab**

Certificate No: **D750V3-1016\_Jul18**

## CALIBRATION CERTIFICATE

Object **D750V3 - SN:1016**

Calibration procedure(s) **QA CAL-05.v10  
Calibration procedure for dipole validation kits above 700 MHz**

Calibration date: **July 13, 2018**

This calibration certificate documents the traceability to national standards, which realize the physical units of measurements (SI).  
The measurements and the uncertainties with confidence probability are given on the following pages and are part of the certificate.

All calibrations have been conducted in the closed laboratory facility: environment temperature (22 ± 3)°C and humidity < 70%.

Calibration Equipment used (M&TE critical for calibration)

Primary Standards	ID #	Cal Date (Certificate No.)	Scheduled Calibration
Power meter NRP	SN: 104778	04-Apr-18 (No. 217-02672/02673)	Apr-19
Power sensor NRP-Z91	SN: 103244	04-Apr-18 (No. 217-02672)	Apr-19
Power sensor NRP-Z91	SN: 103245	04-Apr-18 (No. 217-02673)	Apr-19
Reference 20 dB Attenuator	SN: 5058 (20k)	04-Apr-18 (No. 217-02682)	Apr-19
Type-N mismatch combination	SN: 5047.2 / 06327	04-Apr-18 (No. 217-02683)	Apr-19
Reference Probe EX3DV4	SN: 7349	30-Dec-17 (No. EX3-7349_Dec17)	Dec-18
DAE4	SN: 601	26-Oct-17 (No. DAE4-601_Oct17)	Oct-18
Secondary Standards	ID #	Check Date (in house)	Scheduled Check
Power meter EPM-442A	SN: GB37480704	07-Oct-15 (in house check Oct-16)	In house check: Oct-18
Power sensor HP 8481A	SN: US37292783	07-Oct-15 (in house check Oct-16)	In house check: Oct-18
Power sensor HP 8481A	SN: MY41092317	07-Oct-15 (in house check Oct-16)	In house check: Oct-18
RF generator R&S SMT-06	SN: 100972	15-Jun-15 (in house check Oct-16)	In house check: Oct-18
Network Analyzer Agilent E8358A	SN: US41080477	31-Mar-14 (in house check Oct-17)	In house check: Oct-18

Calibrated by: **Manu Seitz**      Name: **Manu Seitz**      Function: **Laboratory Technician**

Approved by: **Katja Pokovic**      Name: **Katja Pokovic**      Technical Manager

Signature

Issued: July 16, 2018

This calibration certificate shall not be reproduced except in full without written approval of the laboratory.



Accredited by the Swiss Accreditation Service (SAS)

The Swiss Accreditation Service is one of the signatories to the EA  
Multilateral Agreement for the recognition of calibration certificates

Accreditation No.: **SCS 0108**

### Glossary:

TSL	tissue simulating liquid
ConvF	sensitivity in TSL / NORM x,y,z
N/A	not applicable or not measured

### Calibration is Performed According to the Following Standards:

- IEEE Std 1528-2013, "IEEE Recommended Practice for Determining the Peak Spatial-Averaged Specific Absorption Rate (SAR) in the Human Head from Wireless Communications Devices: Measurement Techniques", June 2013
- IEC 62209-1, "Measurement procedure for the assessment of Specific Absorption Rate (SAR) from hand-held and body-mounted devices used next to the ear (frequency range of 300 MHz to 6 GHz)", July 2016
- IEC 62209-2, "Procedure to determine the Specific Absorption Rate (SAR) for wireless communication devices used in close proximity to the human body (frequency range of 30 MHz to 6 GHz)", March 2010
- KDB 865664, "SAR Measurement Requirements for 100 MHz to 6 GHz"

### Additional Documentation:

- DASY4/5 System Handbook

### Methods Applied and Interpretation of Parameters:

- Measurement Conditions:** Further details are available from the Validation Report at the end of the certificate. All figures stated in the certificate are valid at the frequency indicated.
- Antenna Parameters with TSL:** The dipole is mounted with the spacer to position its feed point exactly below the center marking of the flat phantom section, with the arms oriented parallel to the body axis.
- Feed Point Impedance and Return Loss:** These parameters are measured with the dipole positioned under the liquid filled phantom. The impedance stated is transformed from the measurement at the SMA connector to the feed point. The Return Loss ensures low reflected power. No uncertainty required.
- Electrical Delay:** One-way delay between the SMA connector and the antenna feed point. No uncertainty required.
- SAR measured:** SAR measured at the stated antenna input power.
- SAR normalized:** SAR as measured, normalized to an input power of 1 W at the antenna connector.
- SAR for nominal TSL parameters:** The measured TSL parameters are used to calculate the nominal SAR result.

The reported uncertainty of measurement is stated as the standard uncertainty of measurement multiplied by the coverage factor  $k=2$ , which for a normal distribution corresponds to a coverage probability of approximately 95%.



## Measurement Conditions

DASY system configuration, as far as not given on page 1.

<b>DASY Version</b>	DASY5	V52.10.1
<b>Extrapolation</b>	Advanced Extrapolation	
<b>Phantom</b>	Modular Flat Phantom	
<b>Distance Dipole Center - TSL</b>	15 mm	with Spacer
<b>Zoom Scan Resolution</b>	dx, dy, dz = 5 mm	
<b>Frequency</b>	750 MHz $\pm$ 1 MHz	

## Head TSL parameters

The following parameters and calculations were applied.

	Temperature	Permittivity	Conductivity
<b>Nominal Head TSL parameters</b>	22.0 °C	41.9	0.89 mho/m
<b>Measured Head TSL parameters</b>	(22.0 $\pm$ 0.2) °C	40.9 $\pm$ 6 %	0.89 mho/m $\pm$ 6 %
<b>Head TSL temperature change during test</b>	< 0.5 °C	----	----

## SAR result with Head TSL

<b>SAR averaged over 1 cm<sup>3</sup> (1 g) of Head TSL</b>	Condition	
SAR measured	250 mW input power	2.07 W/kg
SAR for nominal Head TSL parameters	normalized to 1W	<b>8.23 W/kg <math>\pm</math> 17.0 % (k=2)</b>

<b>SAR averaged over 10 cm<sup>3</sup> (10 g) of Head TSL</b>	condition	
SAR measured	250 mW input power	1.35 W/kg
SAR for nominal Head TSL parameters	normalized to 1W	<b>5.38 W/kg <math>\pm</math> 16.5 % (k=2)</b>

## Body TSL parameters

The following parameters and calculations were applied.

	Temperature	Permittivity	Conductivity
<b>Nominal Body TSL parameters</b>	22.0 °C	55.5	0.96 mho/m
<b>Measured Body TSL parameters</b>	(22.0 $\pm$ 0.2) °C	55.3 $\pm$ 6 %	0.96 mho/m $\pm$ 6 %
<b>Body TSL temperature change during test</b>	< 0.5 °C	----	----

## SAR result with Body TSL

<b>SAR averaged over 1 cm<sup>3</sup> (1 g) of Body TSL</b>	Condition	
SAR measured	250 mW input power	2.14 W/kg
SAR for nominal Body TSL parameters	normalized to 1W	<b>8.55 W/kg <math>\pm</math> 17.0 % (k=2)</b>

<b>SAR averaged over 10 cm<sup>3</sup> (10 g) of Body TSL</b>	condition	
SAR measured	250 mW input power	1.41 W/kg
SAR for nominal Body TSL parameters	normalized to 1W	<b>5.64 W/kg <math>\pm</math> 16.5 % (k=2)</b>

## Appendix (Additional assessments outside the scope of SCS 0108)

### Antenna Parameters with Head TSL

Impedance, transformed to feed point	53.4 $\Omega$ + 0.0 $j\Omega$
Return Loss	- 29.6 dB

### Antenna Parameters with Body TSL

Impedance, transformed to feed point	48.8 $\Omega$ - 2.6 $j\Omega$
Return Loss	- 30.7 dB

### General Antenna Parameters and Design

Electrical Delay (one direction)	1.038 ns
----------------------------------	----------

After long term use with 100W radiated power, only a slight warming of the dipole near the feedpoint can be measured.

The dipole is made of standard semirigid coaxial cable. The center conductor of the feeding line is directly connected to the second arm of the dipole. The antenna is therefore short-circuited for DC-signals. On some of the dipoles, small end caps are added to the dipole arms in order to improve matching when loaded according to the position as explained in the "Measurement Conditions" paragraph. The SAR data are not affected by this change. The overall dipole length is still according to the Standard.

No excessive force must be applied to the dipole arms, because they might bend or the soldered connections near the feedpoint may be damaged.

### Additional EUT Data

Manufactured by	SPEAG
Manufactured on	March 22, 2010

#### Extended Calibration

Usage of SAR dipoles calibrated less than 3 years ago but more than 1 year ago were confirmed in maintaining return loss (<-20 dB, within 20% of prior calibration) and impedance (within 5 ohm from prior calibration) requirements per extended calibrations in KDB Publication 865664 D01 v01r04.

D750V3 SN: 1016 - Head						
Date of Measurement	Return Loss (dB)	$\Delta\%$	Impedance Real ( $\Omega$ )	$\Delta\Omega$	Impedance Imaginary ( $j\Omega$ )	$\Delta\Omega$
7/13/2018	-29.6		53.4		0.0	
7/13/2019	-28.2	-4.7	54.9	1.5	-0.2	-0.2
7/13/2020	-30.1	1.7	52.8	-0.6	0.1	0.1
D750V3 SN: 1016 - Body						
Date of Measurement	Return Loss (dB)	$\Delta\%$	Impedance Real ( $\Omega$ )	$\Delta\Omega$	Impedance Imaginary ( $j\Omega$ )	$\Delta\Omega$
7/13/2018	-30.7		48.8		-2.6	
7/13/2019	-29.8	-2.9	49.2	0.4	-2.7	-0.1
7/13/2020	-31.1	1.1	47.6	-1.2	-2.5	0.1

## DASY5 Validation Report for Head TSL

Date: 13.07.2018

Test Laboratory: SPEAG, Zurich, Switzerland

**DUT: Dipole 750 MHz; Type: D750V3; Serial: D750V3 - SN:1016**

Communication System: UID 0 - CW; Frequency: 750 MHz

Medium parameters used:  $f = 750$  MHz;  $\sigma = 0.89$  S/m;  $\epsilon_r = 40.9$ ;  $\rho = 1000$  kg/m<sup>3</sup>

Phantom section: Flat Section

Measurement Standard: DASY5 (IEEE/IEC/ANSI C63.19-2011)

DASY52 Configuration:

- Probe: EX3DV4 - SN7349; ConvF(10.22, 10.22, 10.22) @ 750 MHz; Calibrated: 30.12.2017
- Sensor-Surface: 1.4mm (Mechanical Surface Detection)
- Electronics: DAE4 Sn601; Calibrated: 26.10.2017
- Phantom: Flat Phantom 4.9 (front); Type: QD 00L P49 AA; Serial: 1001
- DASY52 52.10.1(1476); SEMCAD X 14.6.11(7439)

### Dipole Calibration for Head Tissue/Pin=250 mW, d=15mm/Zoom Scan (7x7x7)/Cube 0:

Measurement grid: dx=5mm, dy=5mm, dz=5mm

Reference Value = 59.03 V/m; Power Drift = -0.03 dB

Peak SAR (extrapolated) = 3.10 W/kg

**SAR(1 g) = 2.07 W/kg; SAR(10 g) = 1.35 W/kg**

Maximum value of SAR (measured) = 2.76 W/kg

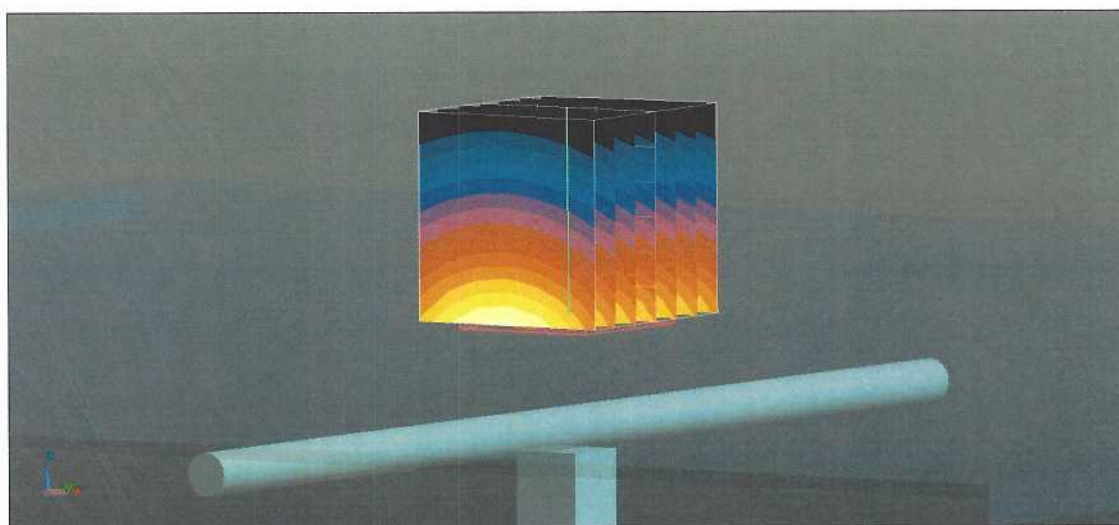
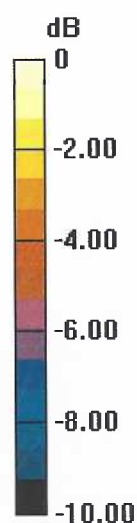

0 dB = 2.76 W/kg = 4.41 dBW/kg

# Impedance Measurement Plot for Head TSL

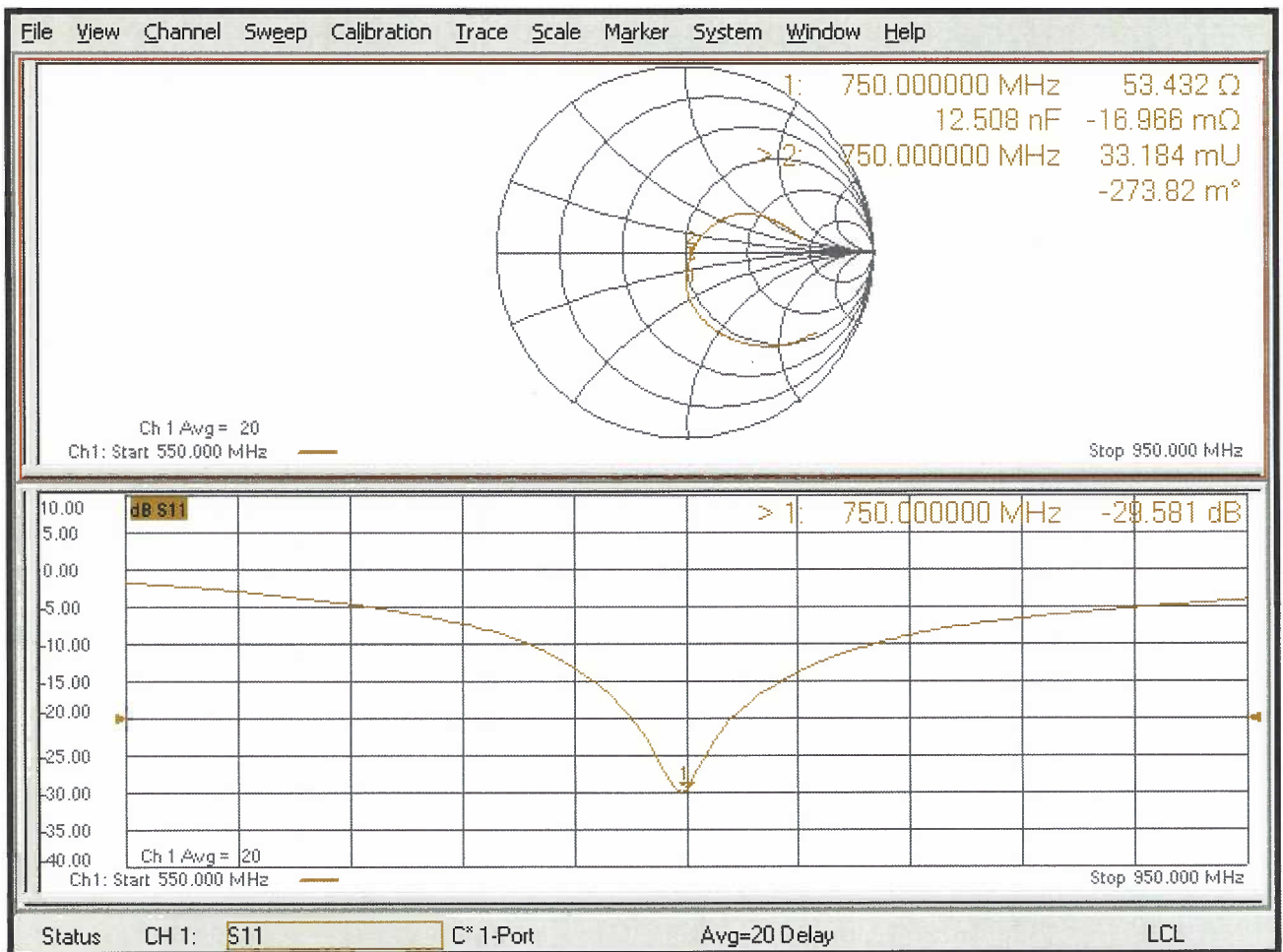

## DASY5 Validation Report for Body TSL

Date: 13.07.2018

Test Laboratory: SPEAG, Zurich, Switzerland

**DUT: Dipole 750 MHz; Type: D750V3; Serial: D750V3 - SN:1016**

Communication System: UID 0 - CW; Frequency: 750 MHz

Medium parameters used:  $f = 750$  MHz;  $\sigma = 0.96$  S/m;  $\epsilon_r = 55.3$ ;  $\rho = 1000$  kg/m<sup>3</sup>

Phantom section: Flat Section

Measurement Standard: DASY5 (IEEE/IEC/ANSI C63.19-2011)

DASY52 Configuration:

- Probe: EX3DV4 - SN7349; ConvF(10.19, 10.19, 10.19) @ 750 MHz; Calibrated: 30.12.2017
- Sensor-Surface: 1.4mm (Mechanical Surface Detection)
- Electronics: DAE4 Sn601; Calibrated: 26.10.2017
- Phantom: Flat Phantom 4.9 (Back); Type: QD 00R P49 AA; Serial: 1005
- DASY52 52.10.1(1476); SEMCAD X 14.6.11(7439)

**Dipole Calibration for Body Tissue/Pin=250 mW, d=15mm/Zoom Scan (7x7x7)/Cube 0:**

Measurement grid: dx=5mm, dy=5mm, dz=5mm

Reference Value = 57.68 V/m; Power Drift = -0.03 dB

Peak SAR (extrapolated) = 3.18 W/kg

**SAR(1 g) = 2.14 W/kg; SAR(10 g) = 1.41 W/kg**

Maximum value of SAR (measured) = 2.84 W/kg

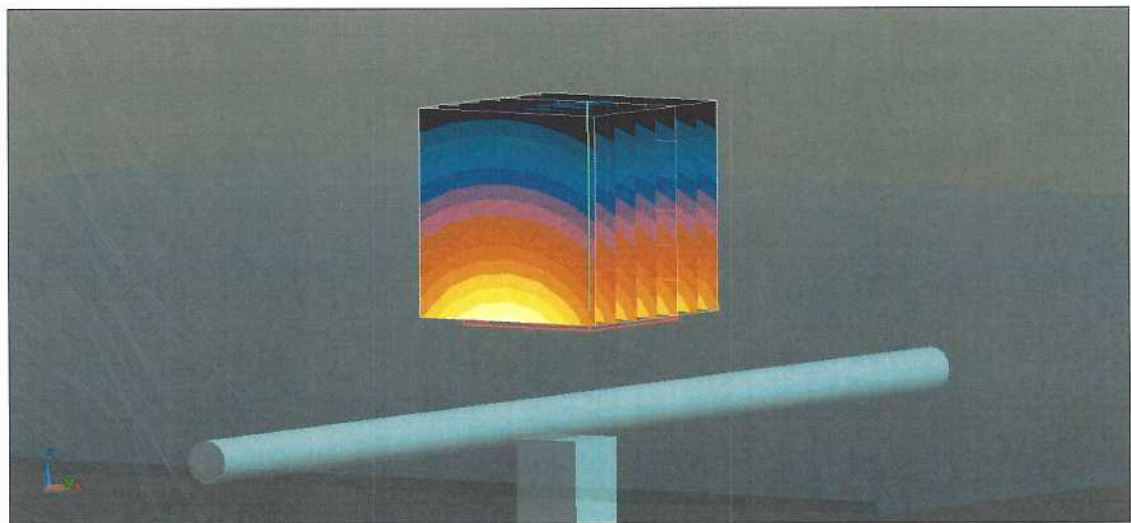
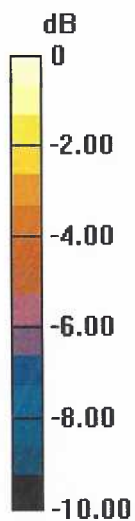

0 dB = 2.84 W/kg = 4.53 dBW/kg

# Impedance Measurement Plot for Body TSL

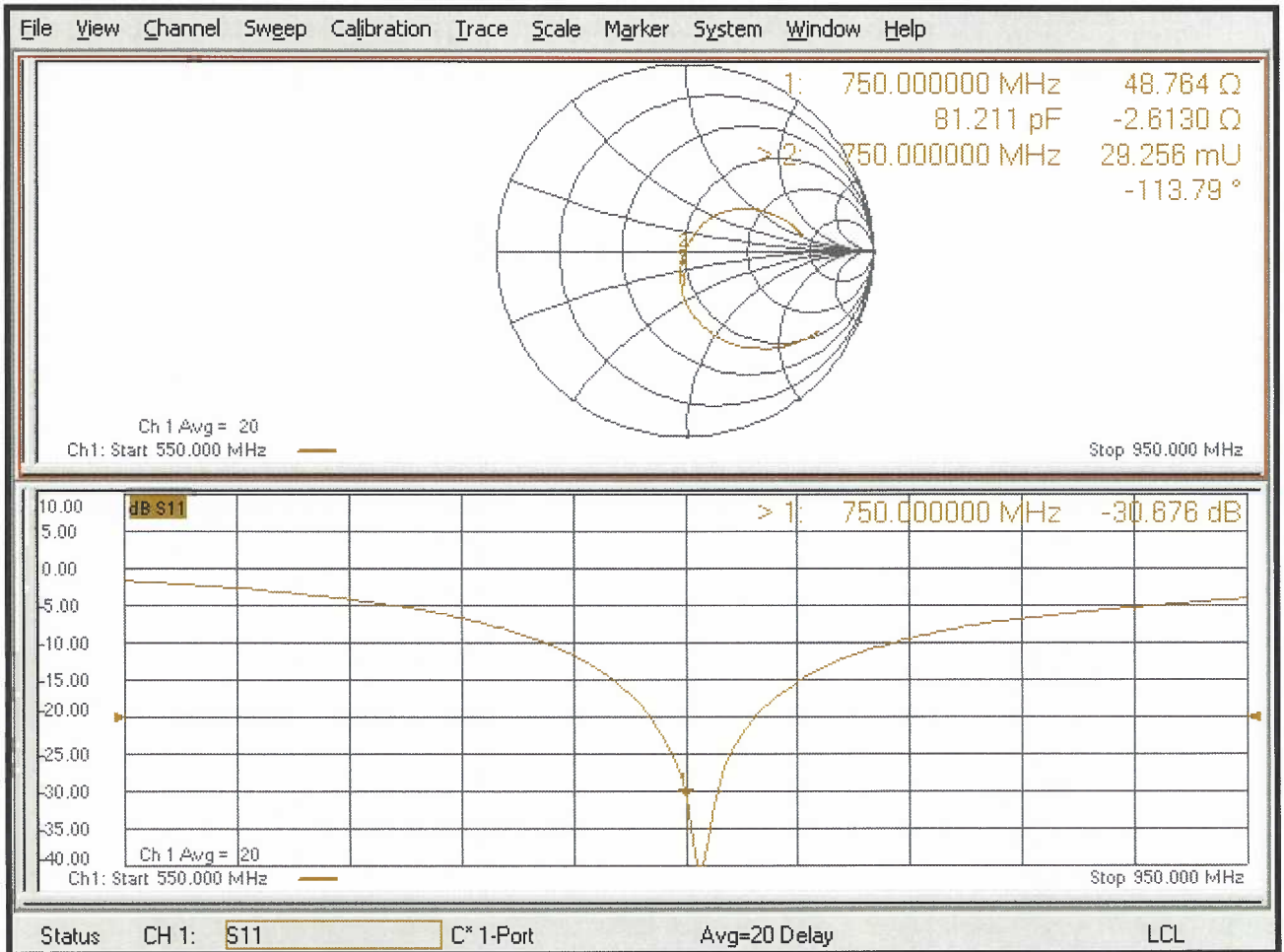



Accredited by the Swiss Accreditation Service (SAS)

Accreditation No.: **SCS 0108**

The Swiss Accreditation Service is one of the signatories to the EA  
Multilateral Agreement for the recognition of calibration certificates

Client **RF Exposure Lab**

Certificate No: **D835V2-4d089\_Jul18**

## CALIBRATION CERTIFICATE

Object **D835V2 - SN:4d089**

Calibration procedure(s) **QA CAL-05.v10  
Calibration procedure for dipole validation kits above 700 MHz**

Calibration date: **July 13, 2018**

This calibration certificate documents the traceability to national standards, which realize the physical units of measurements (SI).  
The measurements and the uncertainties with confidence probability are given on the following pages and are part of the certificate.

All calibrations have been conducted in the closed laboratory facility: environment temperature ( $22 \pm 3$ )°C and humidity < 70%.

Calibration Equipment used (M&TE critical for calibration)

Primary Standards	ID #	Cal Date (Certificate No.)	Scheduled Calibration
Power meter NRP	SN: 104778	04-Apr-18 (No. 217-02672/02673)	Apr-19
Power sensor NRP-Z91	SN: 103244	04-Apr-18 (No. 217-02672)	Apr-19
Power sensor NRP-Z91	SN: 103245	04-Apr-18 (No. 217-02673)	Apr-19
Reference 20 dB Attenuator	SN: 5058 (20k)	04-Apr-18 (No. 217-02682)	Apr-19
Type-N mismatch combination	SN: 5047.2 / 06327	04-Apr-18 (No. 217-02683)	Apr-19
Reference Probe EX3DV4	SN: 7349	30-Dec-17 (No. EX3-7349_Dec17)	Dec-18
DAE4	SN: 601	26-Oct-17 (No. DAE4-601_Oct17)	Oct-18

Secondary Standards	ID #	Check Date (in house)	Scheduled Check
Power meter EPM-442A	SN: GB37480704	07-Oct-15 (in house check Oct-16)	In house check: Oct-18
Power sensor HP 8481A	SN: US37292783	07-Oct-15 (in house check Oct-16)	In house check: Oct-18
Power sensor HP 8481A	SN: MY41092317	07-Oct-15 (in house check Oct-16)	In house check: Oct-18
RF generator R&S SMT-06	SN: 100972	15-Jun-15 (in house check Oct-16)	In house check: Oct-18
Network Analyzer Agilent E8358A	SN: US41080477	31-Mar-14 (in house check Oct-17)	In house check: Oct-18

	Name	Function	Signature
Calibrated by:	<b>Manu Seitz</b>	<b>Laboratory Technician</b>	
Approved by:	<b>Katja Pokovic</b>	<b>Technical Manager</b>	

Issued: July 17, 2018

This calibration certificate shall not be reproduced except in full without written approval of the laboratory.



Accredited by the Swiss Accreditation Service (SAS)  
The Swiss Accreditation Service is one of the signatories to the EA  
Multilateral Agreement for the recognition of calibration certificates

Accreditation No.: **SCS 0108**

**Glossary:**

TSL	tissue simulating liquid
ConvF	sensitivity in TSL / NORM x,y,z
N/A	not applicable or not measured

**Calibration is Performed According to the Following Standards:**

- a) IEEE Std 1528-2013, "IEEE Recommended Practice for Determining the Peak Spatial-Averaged Specific Absorption Rate (SAR) in the Human Head from Wireless Communications Devices: Measurement Techniques", June 2013
- b) IEC 62209-1, "Measurement procedure for the assessment of Specific Absorption Rate (SAR) from hand-held and body-mounted devices used next to the ear (frequency range of 300 MHz to 6 GHz)", July 2016
- c) IEC 62209-2, "Procedure to determine the Specific Absorption Rate (SAR) for wireless communication devices used in close proximity to the human body (frequency range of 30 MHz to 6 GHz)", March 2010
- d) KDB 865664, "SAR Measurement Requirements for 100 MHz to 6 GHz"

**Additional Documentation:**

- e) DASY4/5 System Handbook

**Methods Applied and Interpretation of Parameters:**

- *Measurement Conditions:* Further details are available from the Validation Report at the end of the certificate. All figures stated in the certificate are valid at the frequency indicated.
- *Antenna Parameters with TSL:* The dipole is mounted with the spacer to position its feed point exactly below the center marking of the flat phantom section, with the arms oriented parallel to the body axis.
- *Feed Point Impedance and Return Loss:* These parameters are measured with the dipole positioned under the liquid filled phantom. The impedance stated is transformed from the measurement at the SMA connector to the feed point. The Return Loss ensures low reflected power. No uncertainty required.
- *Electrical Delay:* One-way delay between the SMA connector and the antenna feed point. No uncertainty required.
- *SAR measured:* SAR measured at the stated antenna input power.
- *SAR normalized:* SAR as measured, normalized to an input power of 1 W at the antenna connector.
- *SAR for nominal TSL parameters:* The measured TSL parameters are used to calculate the nominal SAR result.

The reported uncertainty of measurement is stated as the standard uncertainty of measurement multiplied by the coverage factor  $k=2$ , which for a normal distribution corresponds to a coverage probability of approximately 95%.



## Measurement Conditions

DASY system configuration, as far as not given on page 1.

<b>DASY Version</b>	DASY5	V52.10.1
<b>Extrapolation</b>	Advanced Extrapolation	
<b>Phantom</b>	Modular Flat Phantom	
<b>Distance Dipole Center - TSL</b>	15 mm	with Spacer
<b>Zoom Scan Resolution</b>	dx, dy, dz = 5 mm	
<b>Frequency</b>	835 MHz ± 1 MHz	

## Head TSL parameters

The following parameters and calculations were applied.

	Temperature	Permittivity	Conductivity
<b>Nominal Head TSL parameters</b>	22.0 °C	41.5	0.90 mho/m
<b>Measured Head TSL parameters</b>	(22.0 ± 0.2) °C	40.7 ± 6 %	0.92 mho/m ± 6 %
<b>Head TSL temperature change during test</b>	< 0.5 °C	----	----

## SAR result with Head TSL

<b>SAR averaged over 1 cm<sup>3</sup> (1 g) of Head TSL</b>	Condition	
SAR measured	250 mW input power	2.41 W/kg
SAR for nominal Head TSL parameters	normalized to 1W	<b>9.44 W/kg ± 17.0 % (k=2)</b>

<b>SAR averaged over 10 cm<sup>3</sup> (10 g) of Head TSL</b>	condition	
SAR measured	250 mW input power	1.55 W/kg
SAR for nominal Head TSL parameters	normalized to 1W	<b>6.10 W/kg ± 16.5 % (k=2)</b>

## Body TSL parameters

The following parameters and calculations were applied.

	Temperature	Permittivity	Conductivity
<b>Nominal Body TSL parameters</b>	22.0 °C	55.2	0.97 mho/m
<b>Measured Body TSL parameters</b>	(22.0 ± 0.2) °C	55.2 ± 6 %	0.99 mho/m ± 6 %
<b>Body TSL temperature change during test</b>	< 0.5 °C	----	----

## SAR result with Body TSL

<b>SAR averaged over 1 cm<sup>3</sup> (1 g) of Body TSL</b>	Condition	
SAR measured	250 mW input power	2.43 W/kg
SAR for nominal Body TSL parameters	normalized to 1W	<b>9.57 W/kg ± 17.0 % (k=2)</b>

<b>SAR averaged over 10 cm<sup>3</sup> (10 g) of Body TSL</b>	condition	
SAR measured	250 mW input power	1.58 W/kg
SAR for nominal Body TSL parameters	normalized to 1W	<b>6.24 W/kg ± 16.5 % (k=2)</b>

## Appendix (Additional assessments outside the scope of SCS 0108)

### Antenna Parameters with Head TSL

Impedance, transformed to feed point	51.6 $\Omega$ - 3.3 j $\Omega$
Return Loss	- 28.9 dB

### Antenna Parameters with Body TSL

Impedance, transformed to feed point	47.3 $\Omega$ - 5.3 j $\Omega$
Return Loss	- 24.3 dB

### General Antenna Parameters and Design

Electrical Delay (one direction)	1.391 ns
----------------------------------	----------

After long term use with 100W radiated power, only a slight warming of the dipole near the feedpoint can be measured.

The dipole is made of standard semirigid coaxial cable. The center conductor of the feeding line is directly connected to the second arm of the dipole. The antenna is therefore short-circuited for DC-signals. On some of the dipoles, small end caps are added to the dipole arms in order to improve matching when loaded according to the position as explained in the "Measurement Conditions" paragraph. The SAR data are not affected by this change. The overall dipole length is still according to the Standard.

No excessive force must be applied to the dipole arms, because they might bend or the soldered connections near the feedpoint may be damaged.

### Additional EUT Data

Manufactured by	SPEAG
Manufactured on	October 17, 2008

#### Extended Calibration

Usage of SAR dipoles calibrated less than 3 years ago but more than 1 year ago were confirmed in maintaining return loss (<-20 dB, within 20% of prior calibration) and impedance (within 5 ohm from prior calibration) requirements per extended calibrations in KDB Publication 865664 D01 v01r04.

D835V2 SN: 4d089 - Head						
Date of Measurement	Return Loss (dB)	$\Delta\%$	Impedance Real ( $\Omega$ )	$\Delta\Omega$	Impedance Imaginary (j $\Omega$ )	$\Delta\Omega$
7/13/2018	-28.9		51.6		-3.3	
7/13/2019	-30.2	4.5	52.5	0.9	-2.9	0.4
7/13/2020	-29.4	1.7	50.9	-0.7	-3.7	-0.4
D835V2 SN: 4d089 - Body						
Date of Measurement	Return Loss (dB)	$\Delta\%$	Impedance Real ( $\Omega$ )	$\Delta\Omega$	Impedance Imaginary (j $\Omega$ )	$\Delta\Omega$
7/13/2018	-24.3		47.3		-5.3	
7/13/2019	-25.6	5.3	48.3	1.0	-5.2	0.1
7/13/2020	-23.7	-2.5	46.9	-0.4	-5.6	-0.3

# DASY5 Validation Report for Head TSL

Date: 13.07.2018

Test Laboratory: SPEAG, Zurich, Switzerland

**DUT: Dipole 835 MHz; Type: D835V2; Serial: D835V2 - SN:4d089**

Communication System: UID 0 - CW; Frequency: 835 MHz

Medium parameters used:  $f = 835 \text{ MHz}$ ;  $\sigma = 0.92 \text{ S/m}$ ;  $\epsilon_r = 40.7$ ;  $\rho = 1000 \text{ kg/m}^3$

Phantom section: Flat Section

Measurement Standard: DASY5 (IEEE/IEC/ANSI C63.19-2011)

DASY52 Configuration:

- Probe: EX3DV4 - SN7349; ConvF(9.9, 9.9, 9.9) @ 835 MHz; Calibrated: 30.12.2017
- Sensor-Surface: 1.4mm (Mechanical Surface Detection)
- Electronics: DAE4 Sn601; Calibrated: 26.10.2017
- Phantom: Flat Phantom 4.9 (front); Type: QD 00L P49 AA; Serial: 1001
- DASY52 52.10.1(1476); SEMCAD X 14.6.11(7439)

## Dipole Calibration for Head Tissue/Pin=250 mW, d=15mm/Zoom Scan (7x7x7)/Cube 0:

Measurement grid:  $dx=5\text{mm}$ ,  $dy=5\text{mm}$ ,  $dz=5\text{mm}$

Reference Value = 62.80 V/m; Power Drift = -0.03 dB

Peak SAR (extrapolated) = 3.70 W/kg

**SAR(1 g) = 2.41 W/kg; SAR(10 g) = 1.55 W/kg**

Maximum value of SAR (measured) = 3.26 W/kg

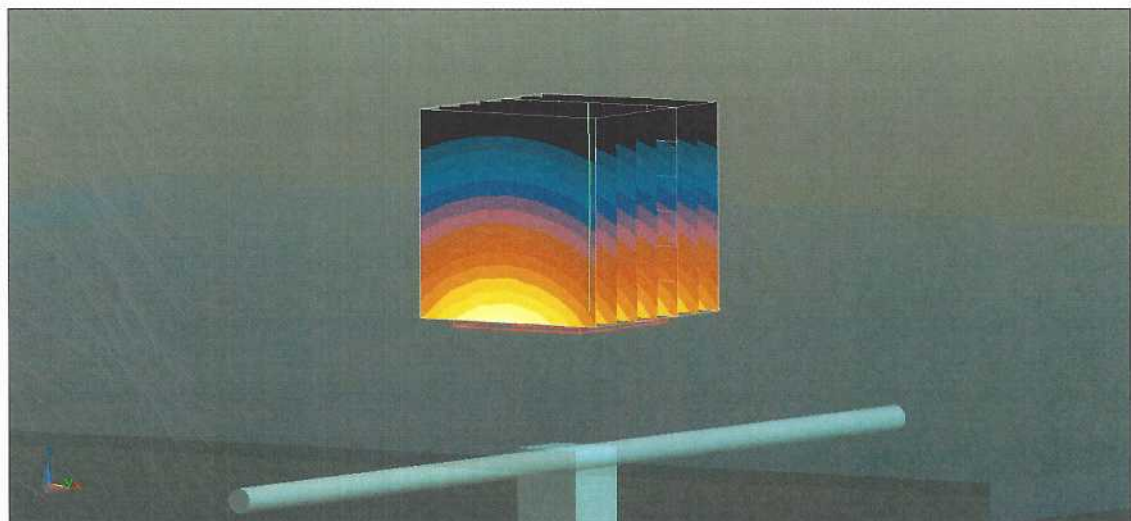
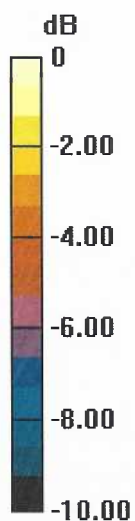

0 dB = 3.26 W/kg = 5.13 dBW/kg

# Impedance Measurement Plot for Head TSL

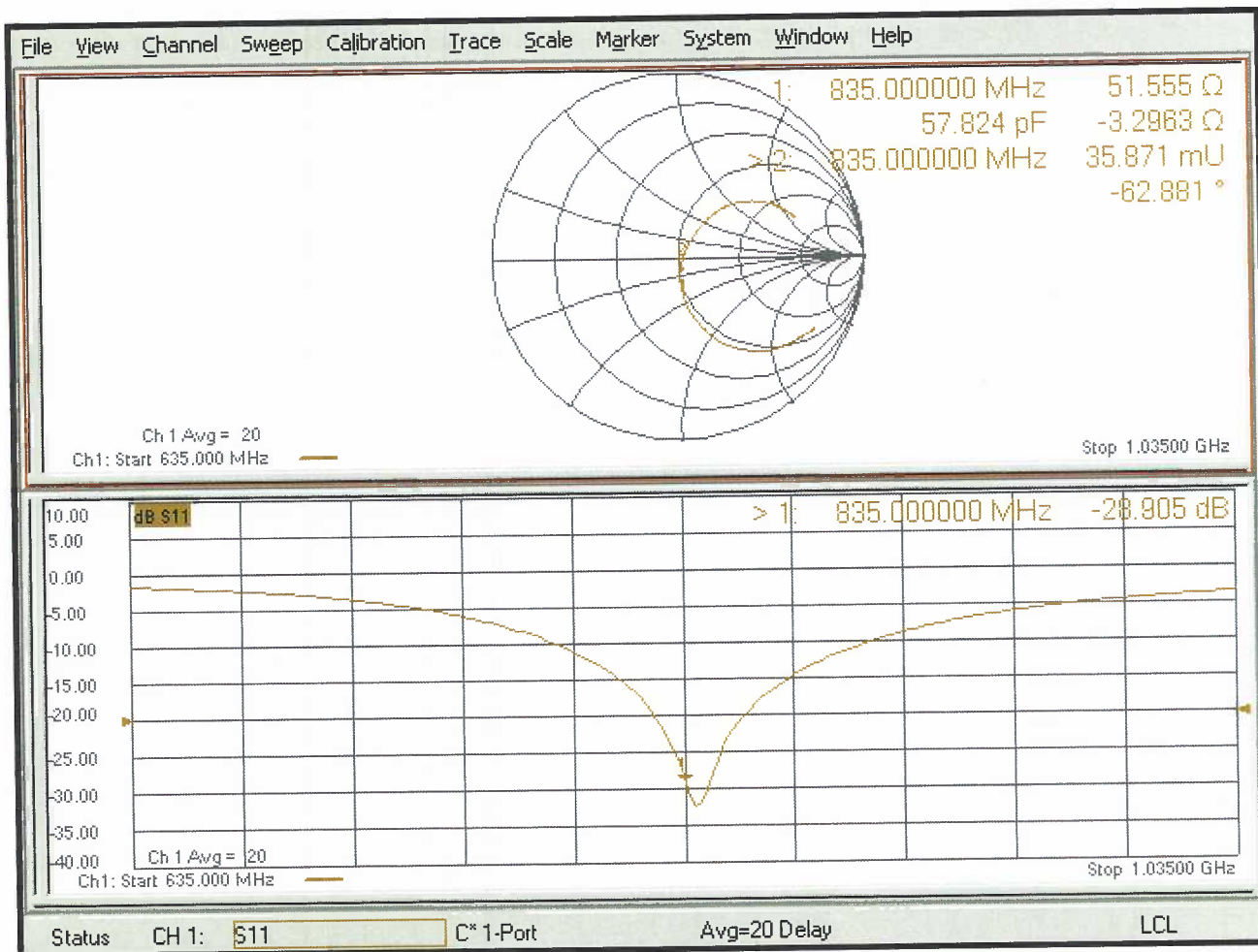

# DASY5 Validation Report for Body TSL

Date: 13.07.2018

Test Laboratory: SPEAG, Zurich, Switzerland

**DUT: Dipole 835 MHz; Type: D835V2; Serial: D835V2 - SN:4d089**

Communication System: UID 0 - CW; Frequency: 835 MHz

Medium parameters used:  $f = 835 \text{ MHz}$ ;  $\sigma = 0.99 \text{ S/m}$ ;  $\epsilon_r = 55.2$ ;  $\rho = 1000 \text{ kg/m}^3$

Phantom section: Flat Section

Measurement Standard: DASY5 (IEEE/IEC/ANSI C63.19-2011)

DASY52 Configuration:

- Probe: EX3DV4 - SN7349; ConvF(10.05, 10.05, 10.05) @ 835 MHz; Calibrated: 30.12.2017
- Sensor-Surface: 1.4mm (Mechanical Surface Detection)
- Electronics: DAE4 Sn601; Calibrated: 26.10.2017
- Phantom: Flat Phantom 4.9 (Back); Type: QD 00R P49 AA; Serial: 1005
- DASY52 52.10.1(1476); SEMCAD X 14.6.11(7439)

## Dipole Calibration for Body Tissue/Pin=250 mW, d=15mm/Zoom Scan (7x7x7)/Cube 0:

Measurement grid:  $dx=5\text{mm}$ ,  $dy=5\text{mm}$ ,  $dz=5\text{mm}$

Reference Value = 60.59 V/m; Power Drift = -0.03 dB

Peak SAR (extrapolated) = 3.60 W/kg

**SAR(1 g) = 2.43 W/kg; SAR(10 g) = 1.58 W/kg**

Maximum value of SAR (measured) = 3.22 W/kg

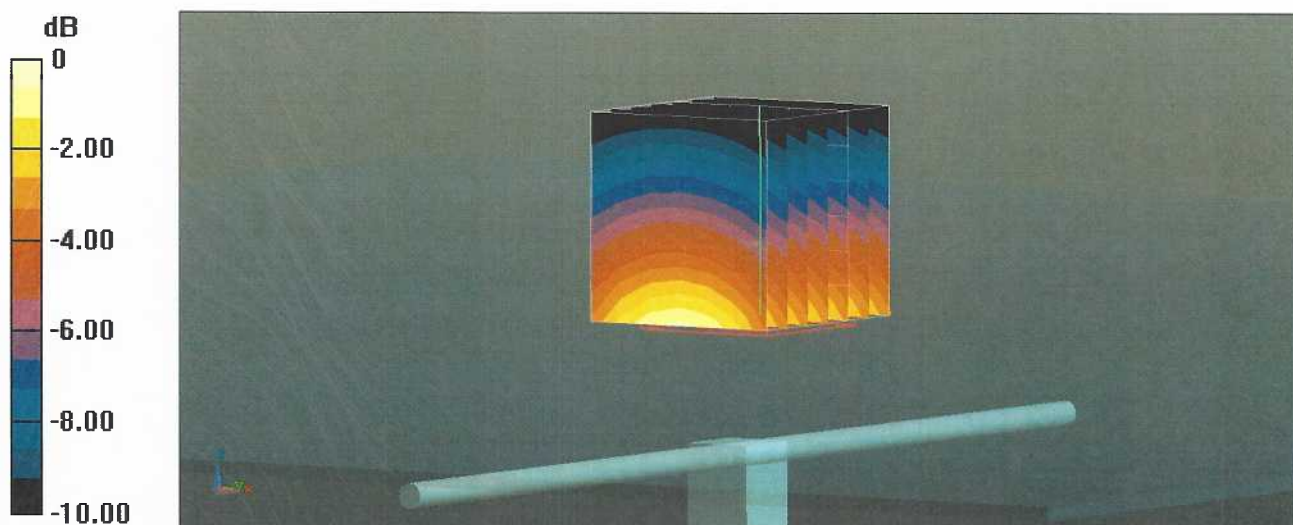

0 dB = 3.22 W/kg = 5.08 dBW/kg

# Impedance Measurement Plot for Body TSL

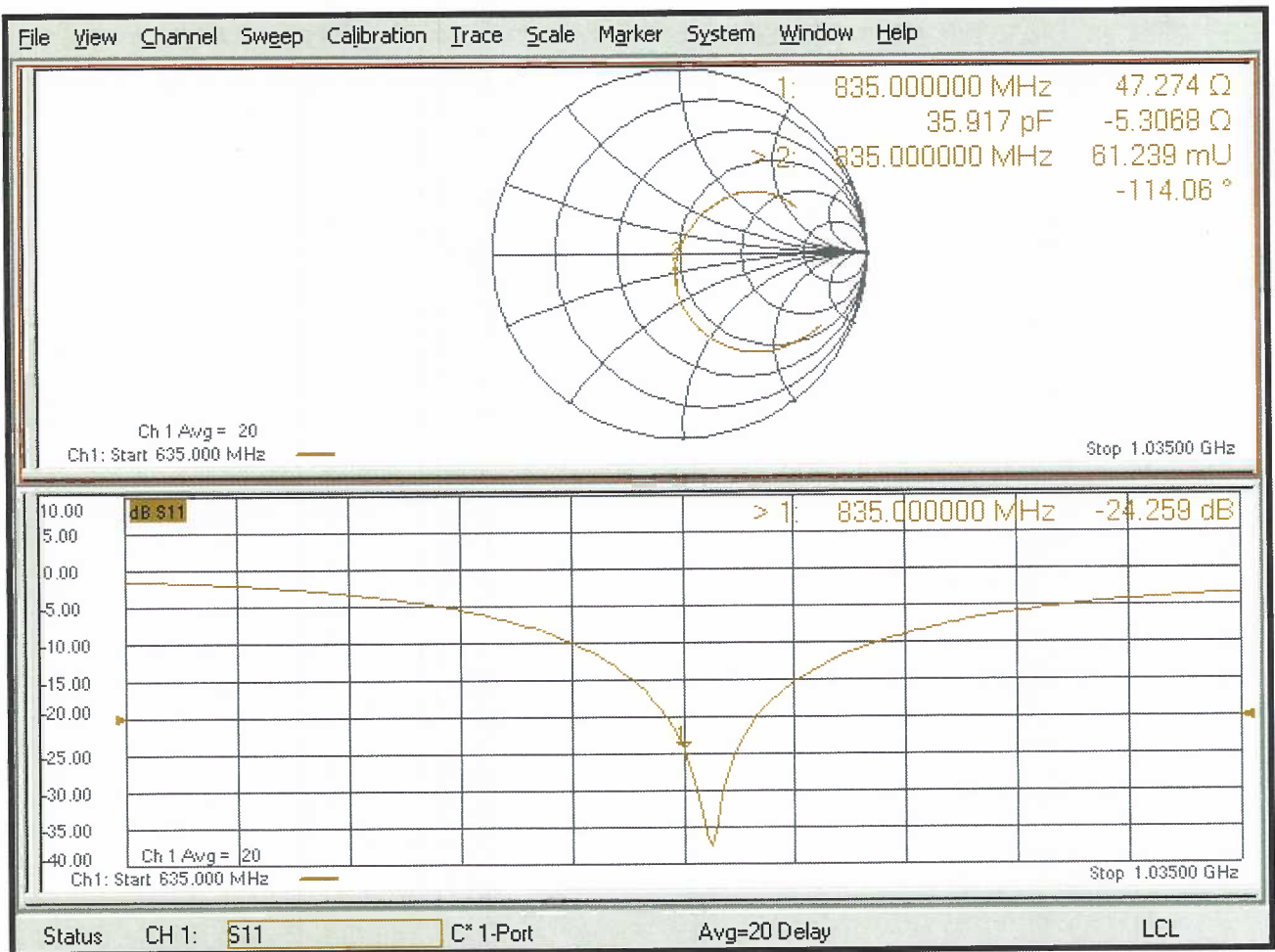



Accredited by the Swiss Accreditation Service (SAS)  
The Swiss Accreditation Service is one of the signatories to the EA  
Multilateral Agreement for the recognition of calibration certificates

Accreditation No.: **SCS 0108**

Client **RF Exposure Lab**

Certificate No: **D1750V2-1018\_Jul18**

## CALIBRATION CERTIFICATE

Object **D1750V2 - SN:1018**

Calibration procedure(s) **QA CAL-05.v10  
Calibration procedure for dipole validation kits above 700 MHz**

Calibration date: **July 20, 2018**

This calibration certificate documents the traceability to national standards, which realize the physical units of measurements (SI).  
The measurements and the uncertainties with confidence probability are given on the following pages and are part of the certificate.

All calibrations have been conducted in the closed laboratory facility: environment temperature ( $22 \pm 3$ )°C and humidity < 70%.

Calibration Equipment used (M&TE critical for calibration)

Primary Standards	ID #	Cal Date (Certificate No.)	Scheduled Calibration
Power meter NRP	SN: 104778	04-Apr-18 (No. 217-02672/02673)	Apr-19
Power sensor NRP-Z91	SN: 103244	04-Apr-18 (No. 217-02672)	Apr-19
Power sensor NRP-Z91	SN: 103245	04-Apr-18 (No. 217-02673)	Apr-19
Reference 20 dB Attenuator	SN: 5058 (20k)	04-Apr-18 (No. 217-02682)	Apr-19
Type-N mismatch combination	SN: 5047.2 / 06327	04-Apr-18 (No. 217-02683)	Apr-19
Reference Probe EX3DV4	SN: 7349	30-Dec-17 (No. EX3-7349_Dec17)	Dec-18
DAE4	SN: 601	26-Oct-17 (No. DAE4-601_Oct17)	Oct-18

Secondary Standards	ID #	Check Date (in house)	Scheduled Check
Power meter EPM-442A	SN: GB37480704	07-Oct-15 (in house check Oct-16)	In house check: Oct-18
Power sensor HP 8481A	SN: US37292783	07-Oct-15 (in house check Oct-16)	In house check: Oct-18
Power sensor HP 8481A	SN: MY41092317	07-Oct-15 (in house check Oct-16)	In house check: Oct-18
RF generator R&S SMT-06	SN: 100972	15-Jun-15 (in house check Oct-16)	In house check: Oct-18
Network Analyzer Agilent E8358A	SN: US41080477	31-Mar-14 (in house check Oct-17)	In house check: Oct-18

Calibrated by: **Manu Seitz**      Name: **Manu Seitz**      Function: **Laboratory Technician**

Approved by: **Katja Pokovic**      Name: **Katja Pokovic**      Function: **Technical Manager**

Signature

Issued: July 20, 2018

This calibration certificate shall not be reproduced except in full without written approval of the laboratory.



Accredited by the Swiss Accreditation Service (SAS)  
The Swiss Accreditation Service is one of the signatories to the EA  
Multilateral Agreement for the recognition of calibration certificates

Accreditation No.: **SCS 0108**

**Glossary:**

TSL	tissue simulating liquid
ConvF	sensitivity in TSL / NORM x,y,z
N/A	not applicable or not measured

**Calibration is Performed According to the Following Standards:**

- IEEE Std 1528-2013, "IEEE Recommended Practice for Determining the Peak Spatial-Averaged Specific Absorption Rate (SAR) in the Human Head from Wireless Communications Devices: Measurement Techniques", June 2013
- IEC 62209-1, "Measurement procedure for the assessment of Specific Absorption Rate (SAR) from hand-held and body-mounted devices used next to the ear (frequency range of 300 MHz to 6 GHz)", July 2016
- IEC 62209-2, "Procedure to determine the Specific Absorption Rate (SAR) for wireless communication devices used in close proximity to the human body (frequency range of 30 MHz to 6 GHz)", March 2010
- KDB 865664, "SAR Measurement Requirements for 100 MHz to 6 GHz"

**Additional Documentation:**

- DASY4/5 System Handbook

**Methods Applied and Interpretation of Parameters:**

- Measurement Conditions:* Further details are available from the Validation Report at the end of the certificate. All figures stated in the certificate are valid at the frequency indicated.
- Antenna Parameters with TSL:* The dipole is mounted with the spacer to position its feed point exactly below the center marking of the flat phantom section, with the arms oriented parallel to the body axis.
- Feed Point Impedance and Return Loss:* These parameters are measured with the dipole positioned under the liquid filled phantom. The impedance stated is transformed from the measurement at the SMA connector to the feed point. The Return Loss ensures low reflected power. No uncertainty required.
- Electrical Delay:* One-way delay between the SMA connector and the antenna feed point. No uncertainty required.
- SAR measured:* SAR measured at the stated antenna input power.
- SAR normalized:* SAR as measured, normalized to an input power of 1 W at the antenna connector.
- SAR for nominal TSL parameters:* The measured TSL parameters are used to calculate the nominal SAR result.

The reported uncertainty of measurement is stated as the standard uncertainty of measurement multiplied by the coverage factor  $k=2$ , which for a normal distribution corresponds to a coverage probability of approximately 95%.



## Measurement Conditions

DASY system configuration, as far as not given on page 1.

<b>DASY Version</b>	DASY5	V52.10.1
<b>Extrapolation</b>	Advanced Extrapolation	
<b>Phantom</b>	Modular Flat Phantom	
<b>Distance Dipole Center - TSL</b>	10 mm	with Spacer
<b>Zoom Scan Resolution</b>	dx, dy, dz = 5 mm	
<b>Frequency</b>	1750 MHz ± 1 MHz	

## Head TSL parameters

The following parameters and calculations were applied.

	Temperature	Permittivity	Conductivity
<b>Nominal Head TSL parameters</b>	22.0 °C	40.1	1.37 mho/m
<b>Measured Head TSL parameters</b>	(22.0 ± 0.2) °C	39.0 ± 6 %	1.34 mho/m ± 6 %
<b>Head TSL temperature change during test</b>	< 0.5 °C	----	----

## SAR result with Head TSL

<b>SAR averaged over 1 cm<sup>3</sup> (1 g) of Head TSL</b>	Condition	
SAR measured	250 mW input power	8.95 W/kg
SAR for nominal Head TSL parameters	normalized to 1W	<b>36.1 W/kg ± 17.0 % (k=2)</b>

<b>SAR averaged over 10 cm<sup>3</sup> (10 g) of Head TSL</b>	condition	
SAR measured	250 mW input power	4.73 W/kg
SAR for nominal Head TSL parameters	normalized to 1W	<b>19.0 W/kg ± 16.5 % (k=2)</b>

## Body TSL parameters

The following parameters and calculations were applied.

	Temperature	Permittivity	Conductivity
<b>Nominal Body TSL parameters</b>	22.0 °C	53.4	1.49 mho/m
<b>Measured Body TSL parameters</b>	(22.0 ± 0.2) °C	53.7 ± 6 %	1.46 mho/m ± 6 %
<b>Body TSL temperature change during test</b>	< 0.5 °C	----	----

## SAR result with Body TSL

<b>SAR averaged over 1 cm<sup>3</sup> (1 g) of Body TSL</b>	Condition	
SAR measured	250 mW input power	9.00 W/kg
SAR for nominal Body TSL parameters	normalized to 1W	<b>36.5 W/kg ± 17.0 % (k=2)</b>

<b>SAR averaged over 10 cm<sup>3</sup> (10 g) of Body TSL</b>	condition	
SAR measured	250 mW input power	4.80 W/kg
SAR for nominal Body TSL parameters	normalized to 1W	<b>19.4 W/kg ± 16.5 % (k=2)</b>

## Appendix (Additional assessments outside the scope of SCS 0108)

### Antenna Parameters with Head TSL

Impedance, transformed to feed point	49.4 $\Omega$ - 1.3 j $\Omega$
Return Loss	- 36.8 dB

### Antenna Parameters with Body TSL

Impedance, transformed to feed point	45.2 $\Omega$ - 0.1 j $\Omega$
Return Loss	- 25.9 dB

### General Antenna Parameters and Design

Electrical Delay (one direction)	1.221 ns
----------------------------------	----------

After long term use with 100W radiated power, only a slight warming of the dipole near the feedpoint can be measured.

The dipole is made of standard semirigid coaxial cable. The center conductor of the feeding line is directly connected to the second arm of the dipole. The antenna is therefore short-circuited for DC-signals. On some of the dipoles, small end caps are added to the dipole arms in order to improve matching when loaded according to the position as explained in the "Measurement Conditions" paragraph. The SAR data are not affected by this change. The overall dipole length is still according to the Standard.

No excessive force must be applied to the dipole arms, because they might bend or the soldered connections near the feedpoint may be damaged.

### Additional EUT Data

Manufactured by	SPEAG
Manufactured on	February 11, 2009

#### Extended Calibration

Usage of SAR dipoles calibrated less than 3 years ago but more than 1 year ago were confirmed in maintaining return loss (<-20 dB, within 20% of prior calibration) and impedance (within 5 ohm from prior calibration) requirements per extended calibrations in KDB Publication 865664 D01 v01r04.

D1750V2 SN: 1018 - Head						
Date of Measurement	Return Loss (dB)	$\Delta\%$	Impedance Real ( $\Omega$ )	$\Delta\Omega$	Impedance Imaginary (j $\Omega$ )	$\Delta\Omega$
7/20/2018	-36.8		49.4		-1.3	
7/13/2019	-37.2	1.1	48.9	-0.5	-1.6	-0.3
7/20/2020	-36.1	-1.9	48.4	-1.0	-1.4	-0.1
D1750V2 SN: 1018 - Body						
Date of Measurement	Return Loss (dB)	$\Delta\%$	Impedance Real ( $\Omega$ )	$\Delta\Omega$	Impedance Imaginary (j $\Omega$ )	$\Delta\Omega$
7/20/2018	-25.9		45.2		-0.1	
7/13/2019	-26.5	2.3	45.8	0.6	-0.2	-0.1
7/20/2020	-26.1	0.8	44.9	-0.3	-0.1	0.0

## DASY5 Validation Report for Head TSL

Date: 20.07.2018

Test Laboratory: SPEAG, Zurich, Switzerland

**DUT: Dipole 1750 MHz; Type: D1750V2; Serial: D1750V2 - SN:1018**

Communication System: UID 0 - CW; Frequency: 1750 MHz

Medium parameters used:  $f = 1750$  MHz;  $\sigma = 1.34$  S/m;  $\epsilon_r = 39$ ;  $\rho = 1000$  kg/m<sup>3</sup>

Phantom section: Flat Section

Measurement Standard: DASY5 (IEEE/IEC/ANSI C63.19-2011)

DASY52 Configuration:

- Probe: EX3DV4 - SN7349; ConvF(8.5, 8.5, 8.5) @ 1750 MHz; Calibrated: 30.12.2017
- Sensor-Surface: 1.4mm (Mechanical Surface Detection)
- Electronics: DAE4 Sn601; Calibrated: 26.10.2017
- Phantom: Flat Phantom 5.0 (front); Type: QD 000 P50 AA; Serial: 1001
- DASY52 52.10.1(1476); SEMCAD X 14.6.11(7439)

### Dipole Calibration for Head Tissue/Pin=250 mW, d=10mm/Zoom Scan (7x7x7)/Cube 0:

Measurement grid: dx=5mm, dy=5mm, dz=5mm

Reference Value = 106.7 V/m; Power Drift = -0.04 dB

Peak SAR (extrapolated) = 16.4 W/kg

**SAR(1 g) = 8.95 W/kg; SAR(10 g) = 4.73 W/kg**

Maximum value of SAR (measured) = 13.9 W/kg

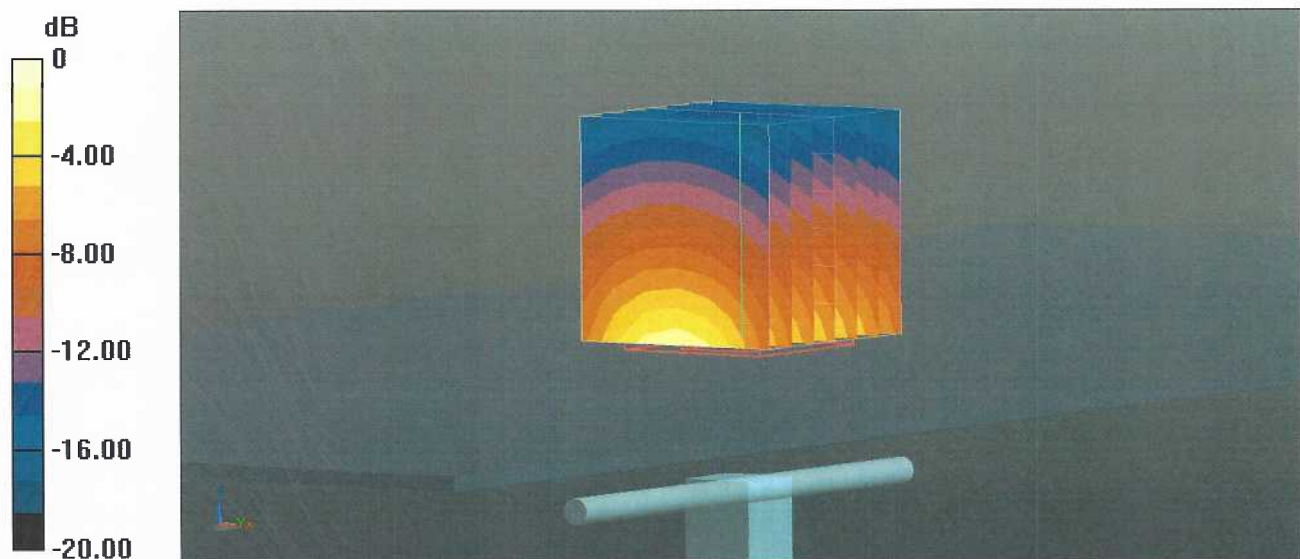

# Impedance Measurement Plot for Head TSL

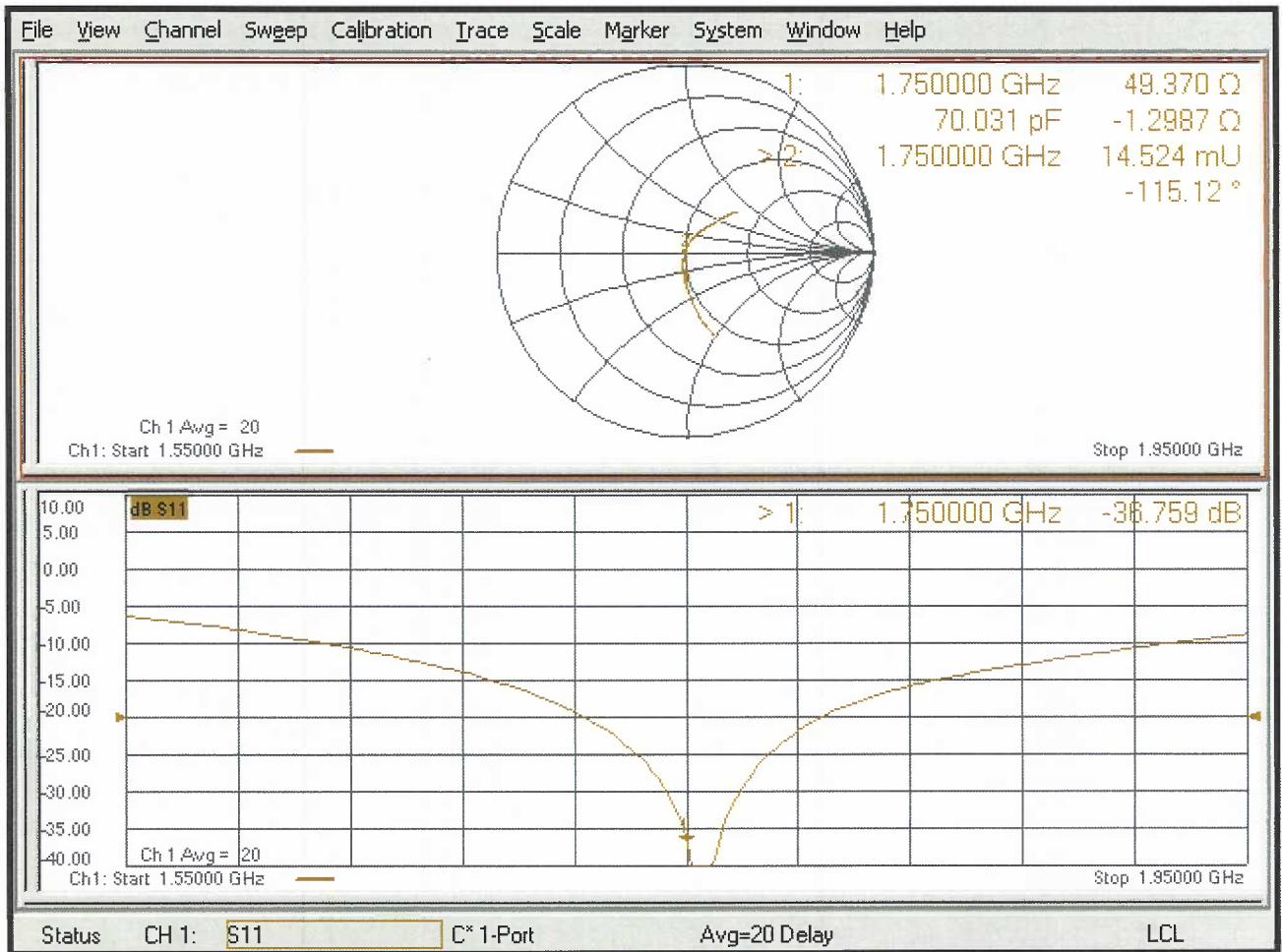

## DASY5 Validation Report for Body TSL

Date: 20.07.2018

Test Laboratory: SPEAG, Zurich, Switzerland

**DUT: Dipole 1750 MHz; Type: D1750V2; Serial: D1750V2 - SN:1018**

Communication System: UID 0 - CW; Frequency: 1750 MHz

Medium parameters used:  $f = 1750$  MHz;  $\sigma = 1.46$  S/m;  $\epsilon_r = 53.7$ ;  $\rho = 1000$  kg/m<sup>3</sup>

Phantom section: Flat Section

Measurement Standard: DASY5 (IEEE/IEC/ANSI C63.19-2011)

DASY52 Configuration:

- Probe: EX3DV4 - SN7349; ConvF(8.35, 8.35, 8.35) @ 1750 MHz; Calibrated: 30.12.2017
- Sensor-Surface: 1.4mm (Mechanical Surface Detection)
- Electronics: DAE4 Sn601; Calibrated: 26.10.2017
- Phantom: Flat Phantom 5.0 (back); Type: QD 000 P50 AA; Serial: 1002
- DASY52 52.10.1(1476); SEMCAD X 14.6.11(7439)

**Dipole Calibration for Body Tissue/Pin=250 mW, d=10mm/Zoom Scan (7x7x7)/Cube 0:**

Measurement grid: dx=5mm, dy=5mm, dz=5mm

Reference Value = 101.9 V/m; Power Drift = -0.09 dB

Peak SAR (extrapolated) = 15.8 W/kg

**SAR(1 g) = 9 W/kg; SAR(10 g) = 4.8 W/kg**

Maximum value of SAR (measured) = 13.4 W/kg

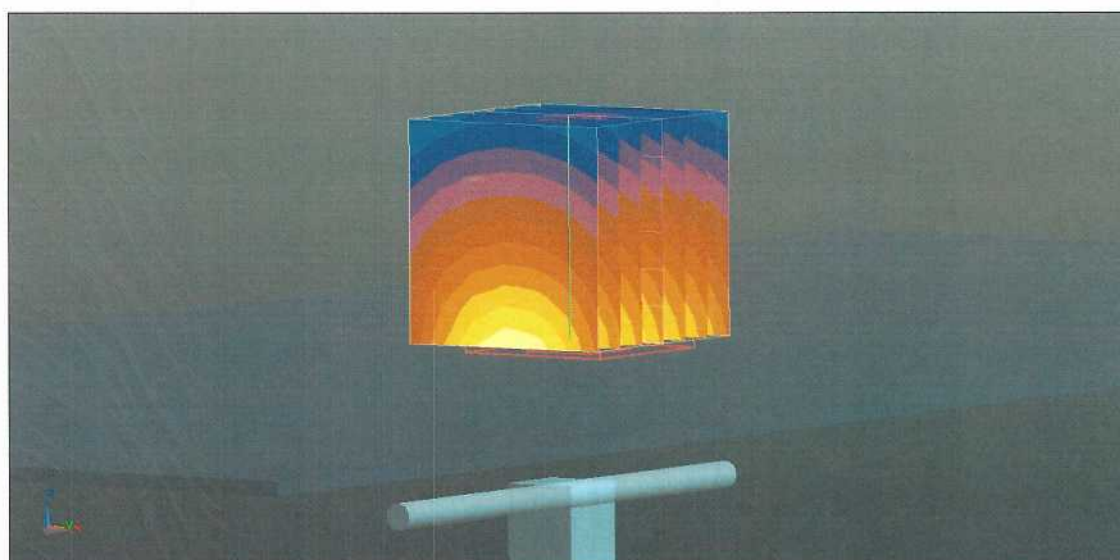
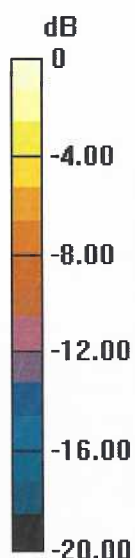

0 dB = 13.4 W/kg = 11.27 dBW/kg

# Impedance Measurement Plot for Body TSL

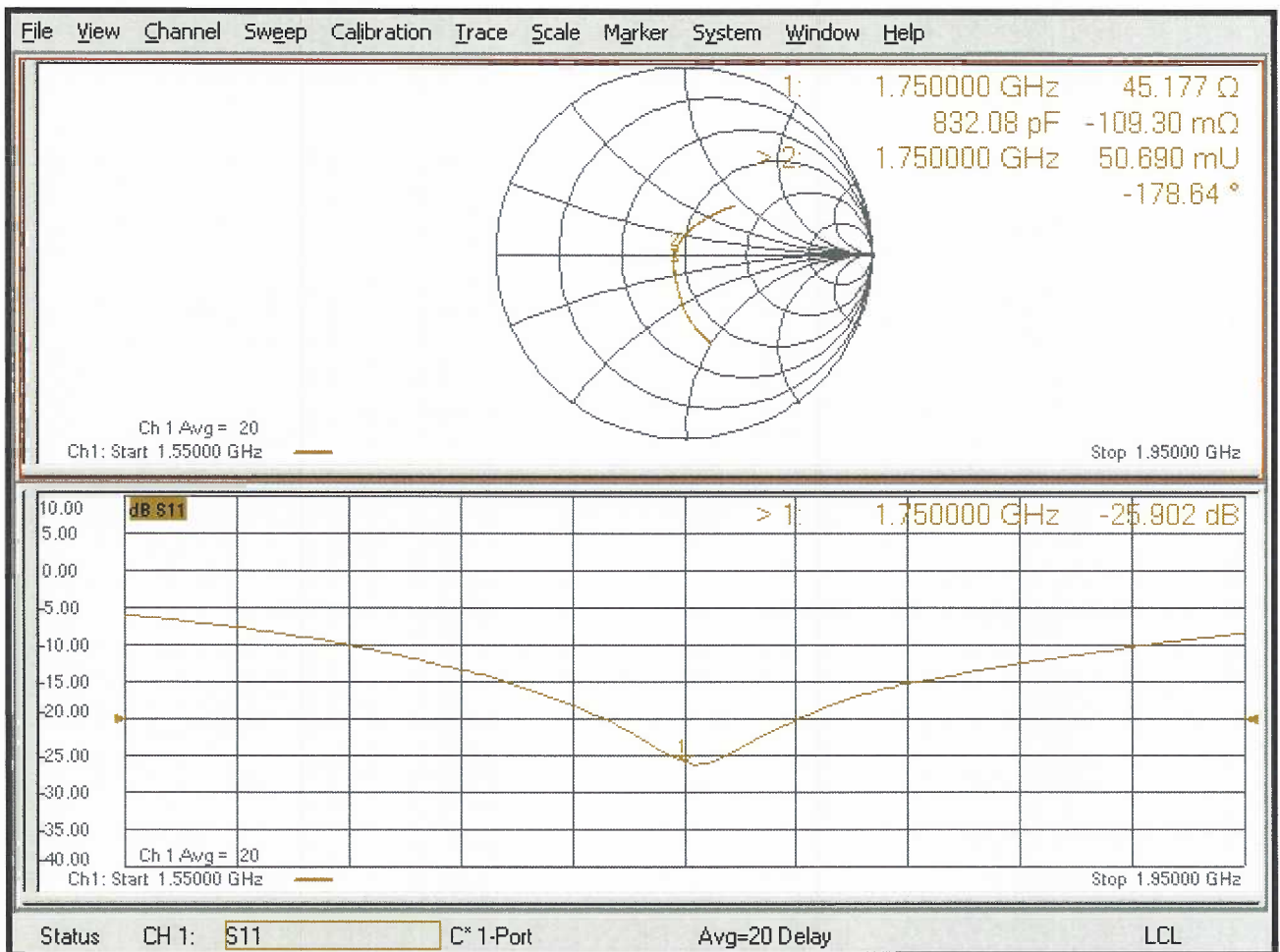



Accredited by the Swiss Accreditation Service (SAS)  
The Swiss Accreditation Service is one of the signatories to the EA  
Multilateral Agreement for the recognition of calibration certificates

Accreditation No.: **SCS 0108**

Client **RF Exposure Lab**

Certificate No: **D1900V2-5d116\_Jul18**

## CALIBRATION CERTIFICATE

Object **D1900V2 - SN:5d116**

Calibration procedure(s) **QA CAL-05.v10  
Calibration procedure for dipole validation kits above 700 MHz**

Calibration date: **July 13, 2018**

This calibration certificate documents the traceability to national standards, which realize the physical units of measurements (SI).  
The measurements and the uncertainties with confidence probability are given on the following pages and are part of the certificate.

All calibrations have been conducted in the closed laboratory facility: environment temperature ( $22 \pm 3$ )°C and humidity < 70%.

Calibration Equipment used (M&TE critical for calibration)

Primary Standards	ID #	Cal Date (Certificate No.)	Scheduled Calibration
Power meter NRP	SN: 104778	04-Apr-18 (No. 217-02672/02673)	Apr-19
Power sensor NRP-Z91	SN: 103244	04-Apr-18 (No. 217-02672)	Apr-19
Power sensor NRP-Z91	SN: 103245	04-Apr-18 (No. 217-02673)	Apr-19
Reference 20 dB Attenuator	SN: 5058 (20k)	04-Apr-18 (No. 217-02682)	Apr-19
Type-N mismatch combination	SN: 5047.2 / 06327	04-Apr-18 (No. 217-02683)	Apr-19
Reference Probe EX3DV4	SN: 7349	30-Dec-17 (No. EX3-7349_Dec17)	Dec-18
DAE4	SN: 601	26-Oct-17 (No. DAE4-601_Oct17)	Oct-18
Secondary Standards	ID #	Check Date (in house)	Scheduled Check
Power meter EPM-442A	SN: GB37480704	07-Oct-15 (in house check Oct-16)	In house check: Oct-18
Power sensor HP 8481A	SN: US37292783	07-Oct-15 (in house check Oct-16)	In house check: Oct-18
Power sensor HP 8481A	SN: MY41092317	07-Oct-15 (in house check Oct-16)	In house check: Oct-18
RF generator R&S SMT-06	SN: 100972	15-Jun-15 (in house check Oct-16)	In house check: Oct-18
Network Analyzer Agilent E8358A	SN: US41080477	31-Mar-14 (in house check Oct-17)	In house check: Oct-18

Calibrated by: **Manu Seitz**      Name: **Manu Seitz**      Function: **Laboratory Technician**

Approved by: **Katja Pokovic**      Name: **Katja Pokovic**      Function: **Technical Manager**

Signature

Issued: July 16, 2018

This calibration certificate shall not be reproduced except in full without written approval of the laboratory.



Accredited by the Swiss Accreditation Service (SAS)  
The Swiss Accreditation Service is one of the signatories to the EA  
Multilateral Agreement for the recognition of calibration certificates

Accreditation No.: **SCS 0108**

**Glossary:**

TSL	tissue simulating liquid
ConvF	sensitivity in TSL / NORM x,y,z
N/A	not applicable or not measured

**Calibration is Performed According to the Following Standards:**

- a) IEEE Std 1528-2013, "IEEE Recommended Practice for Determining the Peak Spatial-Averaged Specific Absorption Rate (SAR) in the Human Head from Wireless Communications Devices: Measurement Techniques", June 2013
- b) IEC 62209-1, "Measurement procedure for the assessment of Specific Absorption Rate (SAR) from hand-held and body-mounted devices used next to the ear (frequency range of 300 MHz to 6 GHz)", July 2016
- c) IEC 62209-2, "Procedure to determine the Specific Absorption Rate (SAR) for wireless communication devices used in close proximity to the human body (frequency range of 30 MHz to 6 GHz)", March 2010
- d) KDB 865664, "SAR Measurement Requirements for 100 MHz to 6 GHz"

**Additional Documentation:**

- e) DASY4/5 System Handbook

**Methods Applied and Interpretation of Parameters:**

- *Measurement Conditions:* Further details are available from the Validation Report at the end of the certificate. All figures stated in the certificate are valid at the frequency indicated.
- *Antenna Parameters with TSL:* The dipole is mounted with the spacer to position its feed point exactly below the center marking of the flat phantom section, with the arms oriented parallel to the body axis.
- *Feed Point Impedance and Return Loss:* These parameters are measured with the dipole positioned under the liquid filled phantom. The impedance stated is transformed from the measurement at the SMA connector to the feed point. The Return Loss ensures low reflected power. No uncertainty required.
- *Electrical Delay:* One-way delay between the SMA connector and the antenna feed point. No uncertainty required.
- *SAR measured:* SAR measured at the stated antenna input power.
- *SAR normalized:* SAR as measured, normalized to an input power of 1 W at the antenna connector.
- *SAR for nominal TSL parameters:* The measured TSL parameters are used to calculate the nominal SAR result.

The reported uncertainty of measurement is stated as the standard uncertainty of measurement multiplied by the coverage factor  $k=2$ , which for a normal distribution corresponds to a coverage probability of approximately 95%.



## Measurement Conditions

DASY system configuration, as far as not given on page 1.

<b>DASY Version</b>	DASY5	V52.10.1
<b>Extrapolation</b>	Advanced Extrapolation	
<b>Phantom</b>	Modular Flat Phantom	
<b>Distance Dipole Center - TSL</b>	10 mm	with Spacer
<b>Zoom Scan Resolution</b>	dx, dy, dz = 5 mm	
<b>Frequency</b>	1900 MHz ± 1 MHz	

## Head TSL parameters

The following parameters and calculations were applied.

	Temperature	Permittivity	Conductivity
<b>Nominal Head TSL parameters</b>	22.0 °C	40.0	1.40 mho/m
<b>Measured Head TSL parameters</b>	(22.0 ± 0.2) °C	39.9 ± 6 %	1.34 mho/m ± 6 %
<b>Head TSL temperature change during test</b>	< 0.5 °C	----	----

## SAR result with Head TSL

<b>SAR averaged over 1 cm<sup>3</sup> (1 g) of Head TSL</b>	Condition	
SAR measured	250 mW input power	9.90 W/kg
SAR for nominal Head TSL parameters	normalized to 1W	<b>40.6 W/kg ± 17.0 % (k=2)</b>

<b>SAR averaged over 10 cm<sup>3</sup> (10 g) of Head TSL</b>	condition	
SAR measured	250 mW input power	5.27 W/kg
SAR for nominal Head TSL parameters	normalized to 1W	<b>21.4 W/kg ± 16.5 % (k=2)</b>

## Body TSL parameters

The following parameters and calculations were applied.

	Temperature	Permittivity	Conductivity
<b>Nominal Body TSL parameters</b>	22.0 °C	53.3	1.52 mho/m
<b>Measured Body TSL parameters</b>	(22.0 ± 0.2) °C	54.3 ± 6 %	1.46 mho/m ± 6 %
<b>Body TSL temperature change during test</b>	< 0.5 °C	----	----

## SAR result with Body TSL

<b>SAR averaged over 1 cm<sup>3</sup> (1 g) of Body TSL</b>	Condition	
SAR measured	250 mW input power	9.70 W/kg
SAR for nominal Body TSL parameters	normalized to 1W	<b>39.9 W/kg ± 17.0 % (k=2)</b>

<b>SAR averaged over 10 cm<sup>3</sup> (10 g) of Body TSL</b>	condition	
SAR measured	250 mW input power	5.23 W/kg
SAR for nominal Body TSL parameters	normalized to 1W	<b>21.3 W/kg ± 16.5 % (k=2)</b>

## Appendix (Additional assessments outside the scope of SCS 0108)

### Antenna Parameters with Head TSL

Impedance, transformed to feed point	54.5 $\Omega$ + 5.0 j $\Omega$
Return Loss	- 23.9 dB

### Antenna Parameters with Body TSL

Impedance, transformed to feed point	50.2 $\Omega$ + 8.3 j $\Omega$
Return Loss	- 21.7 dB

### General Antenna Parameters and Design

Electrical Delay (one direction)	1.202 ns
----------------------------------	----------

After long term use with 100W radiated power, only a slight warming of the dipole near the feedpoint can be measured.

The dipole is made of standard semirigid coaxial cable. The center conductor of the feeding line is directly connected to the second arm of the dipole. The antenna is therefore short-circuited for DC-signals. On some of the dipoles, small end caps are added to the dipole arms in order to improve matching when loaded according to the position as explained in the "Measurement Conditions" paragraph. The SAR data are not affected by this change. The overall dipole length is still according to the Standard.

No excessive force must be applied to the dipole arms, because they might bend or the soldered connections near the feedpoint may be damaged.

### Additional EUT Data

Manufactured by	SPEAG
Manufactured on	August 21, 2009

#### Extended Calibration

Usage of SAR dipoles calibrated less than 3 years ago but more than 1 year ago were confirmed in maintaining return loss (<-20 dB, within 20% of prior calibration) and impedance (within 5 ohm from prior calibration) requirements per extended calibrations in KDB Publication 865664 D01 v01r04.

D1900V2 SN: 5d116 - Head						
Date of Measurement	Return Loss (dB)	$\Delta\%$	Impedance Real ( $\Omega$ )	$\Delta\Omega$	Impedance Imaginary (j $\Omega$ )	$\Delta\Omega$
7/13/2018	-23.9		54.5		5.0	
7/13/2019	-24.2	1.3	54.6	0.1	5.2	0.2
7/13/2020	-24.5	2.5	53.8	-0.7	4.8	-0.2
D1900V2 SN: 5d116 - Body						
Date of Measurement	Return Loss (dB)	$\Delta\%$	Impedance Real ( $\Omega$ )	$\Delta\Omega$	Impedance Imaginary (j $\Omega$ )	$\Delta\Omega$
7/13/2018	-21.7		50.2		8.3	
7/13/2019	-22.3	2.8	49.6	-0.6	8.1	-0.2
7/13/2020	-21.9	0.9	51.4	1.2	8.6	0.3

# DASY5 Validation Report for Head TSL

Date: 13.07.2018

Test Laboratory: SPEAG, Zurich, Switzerland

**DUT: Dipole 1900 MHz; Type: D1900V2; Serial: D1900V2 - SN:5d116**

Communication System: UID 0 - CW; Frequency: 1900 MHz

Medium parameters used:  $f = 1900$  MHz;  $\sigma = 1.34$  S/m;  $\epsilon_r = 39.9$ ;  $\rho = 1000$  kg/m<sup>3</sup>

Phantom section: Flat Section

Measurement Standard: DASY5 (IEEE/IEC/ANSI C63.19-2011)

DASY52 Configuration:

- Probe: EX3DV4 - SN7349; ConvF(8.18, 8.18, 8.18) @ 1900 MHz; Calibrated: 30.12.2017
- Sensor-Surface: 1.4mm (Mechanical Surface Detection)
- Electronics: DAE4 Sn601; Calibrated: 26.10.2017
- Phantom: Flat Phantom 5.0 (front); Type: QD 000 P50 AA; Serial: 1001
- DASY52 52.10.1(1476); SEMCAD X 14.6.11(7439)

## Dipole Calibration for Head Tissue/Pin=250 mW, d=10mm/Zoom Scan (7x7x7)/Cube 0:

Measurement grid: dx=5mm, dy=5mm, dz=5mm

Reference Value = 111.3 V/m; Power Drift = -0.07 dB

Peak SAR (extrapolated) = 18.0 W/kg

**SAR(1 g) = 9.9 W/kg; SAR(10 g) = 5.27 W/kg**

Maximum value of SAR (measured) = 15.3 W/kg

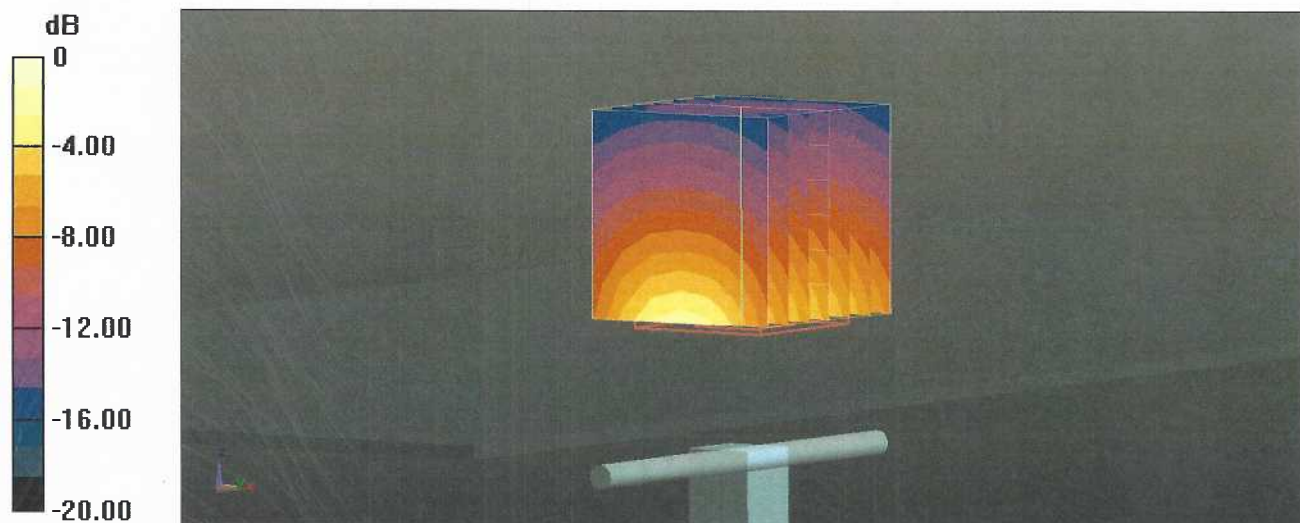

# Impedance Measurement Plot for Head TSL

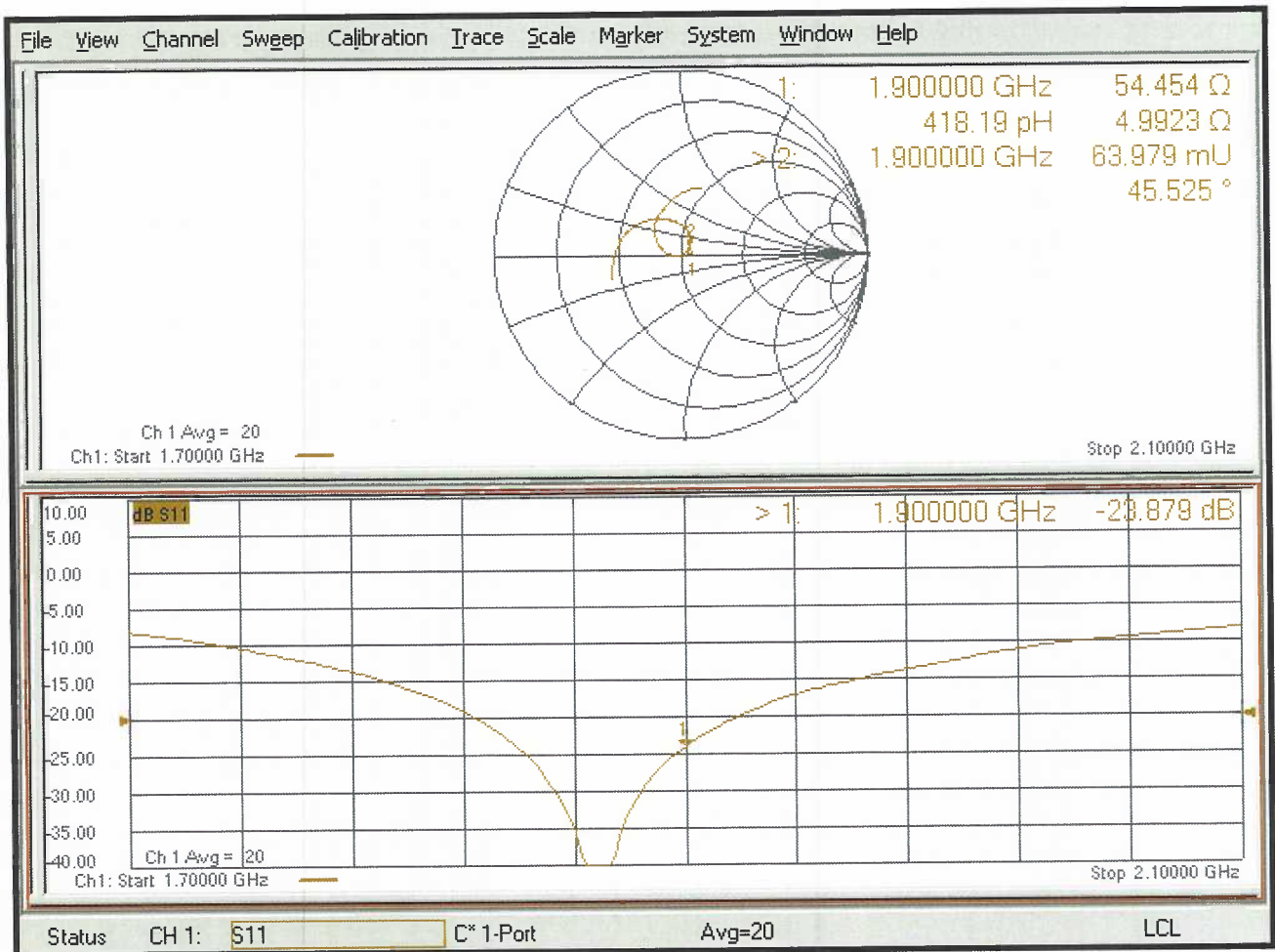

## DASY5 Validation Report for Body TSL

Date: 13.07.2018

Test Laboratory: SPEAG, Zurich, Switzerland

**DUT: Dipole 1900 MHz; Type: D1900V2; Serial: D1900V2 - SN:5d116**

Communication System: UID 0 - CW; Frequency: 1900 MHz

Medium parameters used:  $f = 1900$  MHz;  $\sigma = 1.46$  S/m;  $\epsilon_r = 54.3$ ;  $\rho = 1000$  kg/m<sup>3</sup>

Phantom section: Flat Section

Measurement Standard: DASY5 (IEEE/IEC/ANSI C63.19-2011)

DASY52 Configuration:

- Probe: EX3DV4 - SN7349; ConvF(8.15, 8.15, 8.15) @ 1900 MHz; Calibrated: 30.12.2017
- Sensor-Surface: 1.4mm (Mechanical Surface Detection)
- Electronics: DAE4 Sn601; Calibrated: 26.10.2017
- Phantom: Flat Phantom 5.0 (back); Type: QD 000 P50 AA; Serial: 1002
- DASY52 52.10.1(1476); SEMCAD X 14.6.11(7439)

### Dipole Calibration for Body Tissue/Pin=250 mW, d=10mm/Zoom Scan (7x7x7)/Cube 0:

Measurement grid: dx=5mm, dy=5mm, dz=5mm

Reference Value = 104.5 V/m; Power Drift = -0.08 dB

Peak SAR (extrapolated) = 16.8 W/kg

**SAR(1 g) = 9.7 W/kg; SAR(10 g) = 5.23 W/kg**

Maximum value of SAR (measured) = 14.4 W/kg

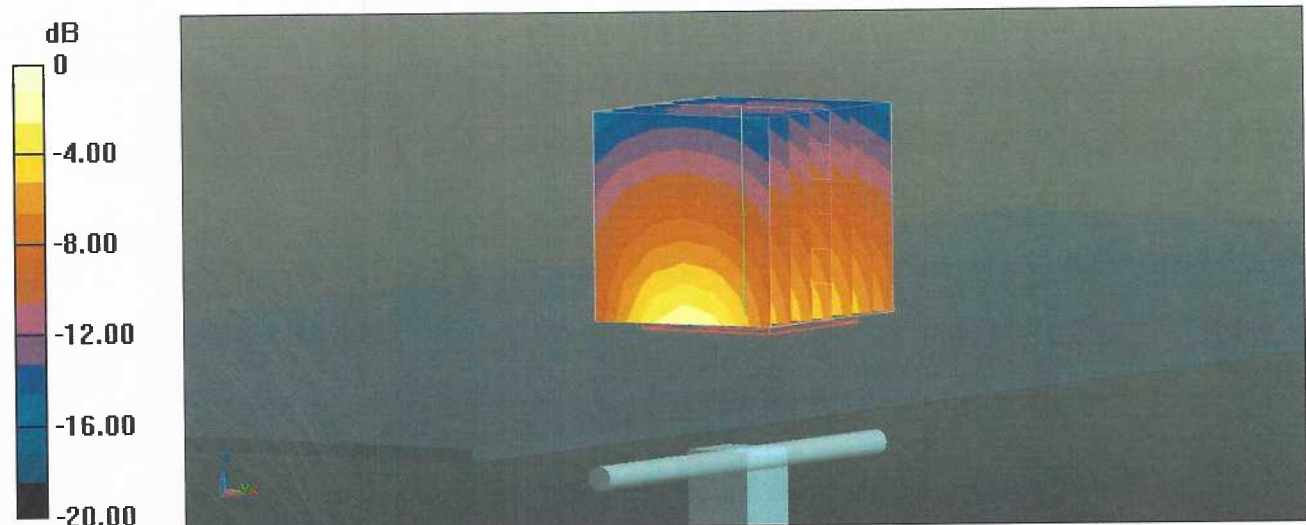

0 dB = 14.4 W/kg = 11.58 dBW/kg

# Impedance Measurement Plot for Body TSL

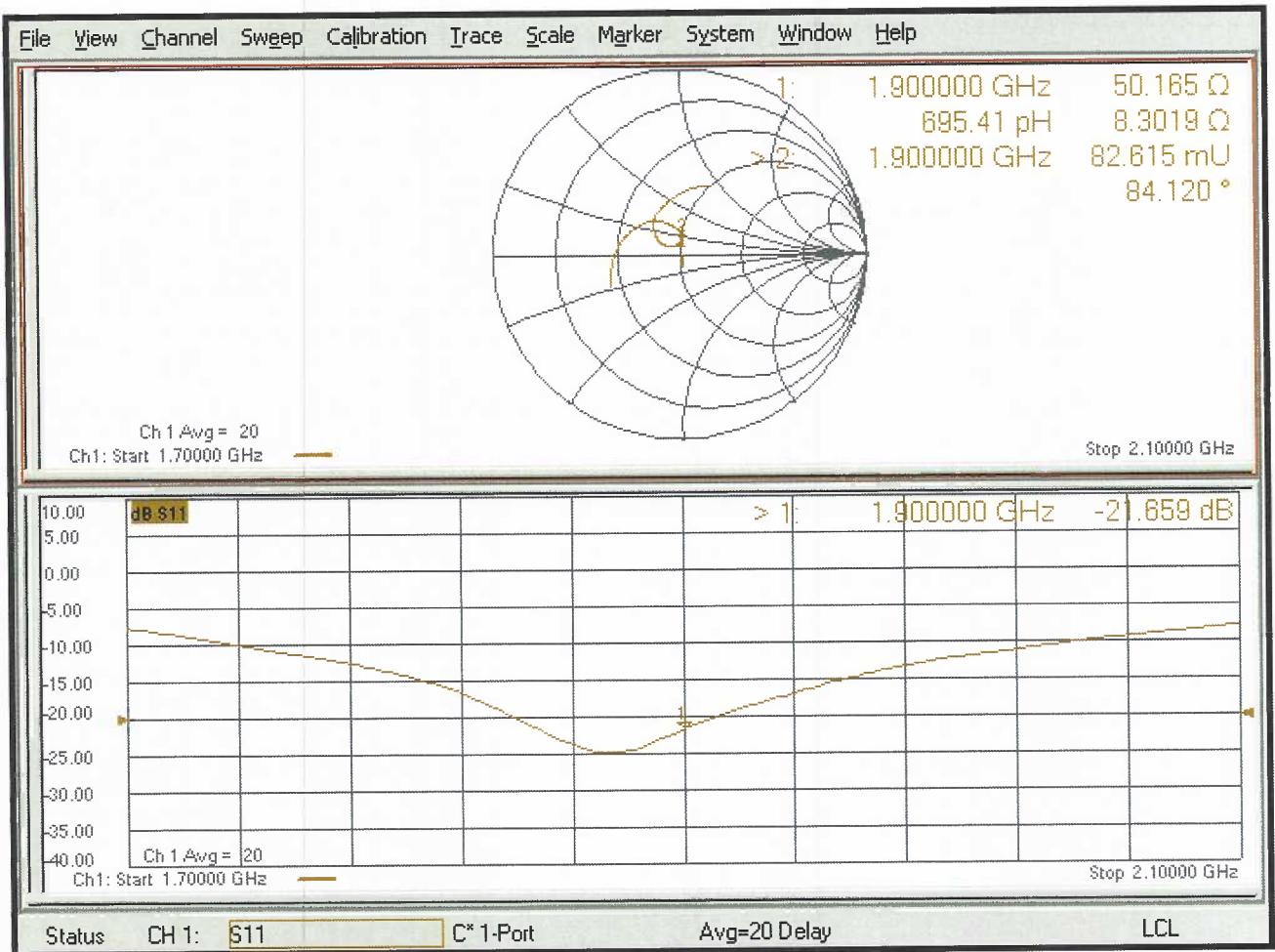

## Appendix F – Phantom Calibration Data Sheets

**Certificate of Conformity / First Article Inspection**

Item	Oval Flat Phantom ELI 4.0
Type No	QD OVA 001 B
Series No	1003 and higher
Manufacturer	Untersee Composites Knebelstrasse 8 CH-8268 Mannenbach, Switzerland

**Tests**

Complete tests were made on the prototype units QD OVA 001 AA 1001, QD OVA 001 AB 1002, pre-series units QD OVA 001 BA 1003-1005 as well as on the series units QD OVA 001 BB, 1006 ff.

Test	Requirement	Details	Units tested
Material thickness	Compliant with the standard requirements	Bottom plate: 2.0mm +/- 0.2mm	all
Material parameters	Dielectric parameters for required frequencies	< 6 GHz: Rel. permittivity = 4 +/-1, Loss tangent ≤ 0.05	Material sample
Material resistivity	The material has been tested to be compatible with the liquids defined in the standards if handled and cleaned according to the instructions.	DGBE based simulating liquids. Observe Technical Note for material compatibility.	Equivalent phantoms, Material sample
Shape	Thickness of bottom material, Internal dimensions, Sagging compatible with standards from minimum frequency	Bottom elliptical 600 x 400 mm Depth 190 mm, Shape is within tolerance for filling height up to 155 mm, Eventual sagging is reduced or eliminated by support via DUT	Prototypes, Sample testing

**Standards**

- [1] CENELEC EN 50361-2001, « Basic standard for the measurement of the Specific Absorption Rate related to human exposure to electromagnetic fields from mobile phones (300 MHz – 3 GHz) », July 2001
- [2] IEEE 1528-2003, "Recommended Practice for Determining the Peak Spatial-Average Specific Absorption Rate (SAR) in the Human Head from Wireless Communications Devices: Measurement Techniques, December 2003
- [3] IEC 62209 – 1, "Specific Absorption Rate (SAR) in the frequency range of 300 MHz to 3 GHz – Measurement Procedure, Part 1: Hand-held mobile wireless communication devices", February 2005
- [4] IEC 62209 – 2, Draft, "Human Exposure to Radio Frequency Fields from Handheld and Body-Mounted Wireless Communication Devices – Human models, Instrumentation and Procedures – Part 2: Procedure to determine the Specific Absorption Rate (SAR) in the head and body for 30 MHz to 6 GHz Handheld and Body-Mounted Devices used in close proximity to the Body.", February 2005
- [5] OET Bulletin 65, Supplement C, "Evaluating Compliance with FCC Guidelines for Human Exposure to Radiofrequency Electromagnetic Fields", Edition January 2001

Based on the tests above, we certify that this item is in compliance with the standards [1] to [5] if operated according to the specific requirements and considering the thickness. The dimensions are fully compliant with [4] from 30 MHz to 6 GHz. For the other standards, the minimum lower frequency limit is limited due to the dimensional requirements ([1]: 450 MHz, [2]: 300 MHz, [3]: 800 MHz, [5]: 375 MHz) and possibly further by the dimensions of the DUT.

Date 28.4.2008 Signature / Stamp

**s p e a g**  
Schmid & Partner Engineering AG  
Zeughausstrasse 43, 8004 Zurich, Switzerland  
Phone +41 44 245 9700, Fax +41 44 245 9779  
info@speag.com; http://www.speag.com



## Appendix G – Validation Summary

Per FCC KDB 865664 D02 v01r02, SAR system validation status should be documented to confirm measurement accuracy. The SAR systems (including SAR probes, system components and software versions) used for this device were validated against its performance specifications prior to the SAR measurements. Reference dipoles were used with the required tissue equivalent media for system validation according to the procedures outlined in FCC KDB 865664 D01 v01r04 and IEEE 1528-2013. Since SAR probe calibrations are frequency dependent, each probe calibration point was validated at a frequency within the valid frequency range of the probe calibration point using the system that normally operates with the probe for routine SAR measurements and according to the required tissue equivalent media.

A tabulated summary of the system validation status including the validation date(s), measurement frequencies, SAR probes and tissue dielectric parameters has been included.

**Table G-1  
SAR System Validation Summary**

SAR System #	Freq. (MHz)	Date	Probe S/N	Probe Type	Probe Cal. Point	Cond. ( $\sigma$ )	Perm. ( $\epsilon_r$ )	CW Validation			Modulation Validation			
								Sens-itivity	Probe Linearity	Probe Isotropy	Modulation Type	Duty Factor	PAR	
3	150	7/30/2020	7531	EX3DV4	150	Head	0.77	52.45	Pass	Pass	Pass	FM	Pass	Pass
3	750	7/25/2020	7531	EX3DV4	750	Head	0.91	41.55	Pass	Pass	Pass	QPSK	Pass	Pass
3	835	7/24/2020	7531	EX3DV4	835	Head	0.95	41.24	Pass	Pass	Pass	WCDMA	Pass	Pass
3	1750	7/24/2020	7531	EX3DV4	1750	Head	1.42	39.63	Pass	Pass	Pass	QPSK	Pass	Pass
3	1900	7/24/2020	7531	EX3DV4	1900	Head	1.46	39.46	Pass	Pass	Pass	WCDMA	Pass	Pass
3	1900	7/24/2020	7531	EX3DV4	1900	Head	1.46	39.46	Pass	Pass	Pass	QPSK	Pass	Pass