

ENGINEERING TEST REPORT

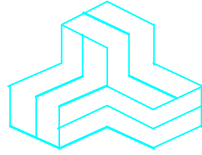

UHF TRANSCEIVER
Model No.: IC-F2100D/DT/DS
FCC ID: AFJ400401

Applicant:

ICOM Incorporated
1-1-32, Kamiminami, Hirano-ku
Osaka, Japan, 547-0003

Tested in Accordance With

Federal Communications Commission (FCC)
47 CFR, Parts 2, 22, 74, 80 and 90 (Subpart I)

UltraTech's File No.: 18ICOM488_FCC90

This Test report is Issued under the Authority of
Tri M. Luu, BAsC,
Vice President of Engineering
UltraTech Group of Labs

Date: July 4, 2018

Report Prepared by: Santhosh Fernandez

Tested by: Nimisha Desai

Issued Date: July 4, 2018

Test Dates: June 4-June 26, 2018

- *The results in this Test Report apply only to the sample(s) tested, and the sample tested is randomly selected.*
- *This report must not be used by the client to claim product endorsement by any agency of the US Government.*
- *This test report shall not be reproduced, except in full, without a written approval from UltraTech.*

UltraTech

3000 Bristol Circle, Oakville, Ontario, Canada, L6H 6G4
Tel.: (905) 829-1570 Fax.: (905) 829-8050
Website: www.ultratech-labs.com, Email: vic@ultratech-labs.com, Email: tri@ultratech-labs.com



TABLE OF CONTENTS

EXHIBIT 1. INTRODUCTION	1
1.1. SCOPE.....	1
1.2. RELATED SUBMITTAL(S)/GRANT(S).....	1
1.3. NORMATIVE REFERENCES.....	1
EXHIBIT 2. PERFORMANCE ASSESSMENT.....	2
2.1. CLIENT INFORMATION	2
2.2. EQUIPMENT UNDER TEST (EUT) INFORMATION.....	2
2.3. EUT'S TECHNICAL SPECIFICATIONS	3
2.4. LIST OF EUT'S PORTS.....	4
2.5. ANCILLARY EQUIPMENT	4
EXHIBIT 3. EUT OPERATING CONDITIONS AND CONFIGURATIONS DURING TESTS.....	5
3.1. CLIMATE TEST CONDITIONS	5
3.2. OPERATIONAL TEST CONDITIONS & ARRANGEMENT FOR TEST SIGNALS.....	5
EXHIBIT 4. SUMMARY OF TEST RESULTS	6
4.1. LOCATION OF TESTS	6
4.2. APPLICABILITY & SUMMARY OF EMISSION TEST RESULTS.....	6
4.3. MODIFICATIONS INCORPORATED IN THE EUT FOR COMPLIANCE PURPOSES	6
EXHIBIT 5. MEASUREMENTS, EXAMINATIONS & TEST DATA FOR EMC EMISSIONS	7
5.1. TEST PROCEDURES	7
5.2. MEASUREMENT UNCERTAINTIES.....	7
5.3. MEASUREMENT EQUIPMENT USED	7
5.4. ESSENTIAL/PRIMARY FUNCTIONS AS DECLARED BY THE MANUFACTURER	7
5.5. RF POWER OUTPUT [§§ 2.1046, 22.565, 74.461, 80.215 & 90.205]	8
5.6. AUDIO FREQUENCY RESPONSE [§ 2.1047(A), 80.213(E) & 90.242(B)(8)].....	9
5.7. MODULATION LIMITING [§§ 2.1047 (B), 74.463, 80.213 & 90.210].....	14
5.8. OCCUPIED BANDWIDTH & EMISSION MASK [§§ 2.1049, 74.462, 80.211(F), 90.209 & 90.210].....	19
5.9. TRANSMITTER ANTENNA POWER SPURIOUS/HARMONIC CONDUCTED EMISSIONS	39
5.10. TRANSMITTER SPURIOUS/HARMONIC RADIATED EMISSIONS	52
5.11. FREQUENCY STABILITY [§§ 2.1055, 22.355, 74.464, 80.209 & 90.213]	55
REFER TO SECTION 8.3 OF THIS REPORT FOR MEASUREMENT DETAILS	56
5.12. TRANSIENT FREQUENCY BEHAVIOR [§ 90.214 & 74.462(C)].....	57
EXHIBIT 6. TEST EQUIPMENT LIST.....	65
EXHIBIT 7. MEASUREMENT UNCERTAINTY	66
7.1. RADIATED EMISSION MEASUREMENT UNCERTAINTY	66
EXHIBIT 8. MEASUREMENT METHODS	67
8.1. CONDUCTED POWER MEASUREMENTS.....	67
8.2. RADIATED POWER MEASUREMENTS (ERP & EIRP) USING SUBSTITUTION METHOD	68
8.3. FREQUENCY STABILITY	71
8.4. EMISSION MASK	72
8.5. SPURIOUS EMISSIONS (CONDUCTED)	72
8.6. TRANSIENT FREQUENCY BEHAVIOR	73

EXHIBIT 1. INTRODUCTION

1.1. SCOPE

Reference:	FCC Parts 2, 22, 74, 80 and 90 (Subpart I)
Title:	Code of Federal Regulations (CFR), Title 47 Telecommunication – Parts 2, 22, 74, 80 and 90 (Subpart I)
Purpose of Test:	To obtain FCC Certification Authorization for Radio operating in the Frequency Band 400-406 & 406.1-470 MHz (25 kHz, 12.5 kHz Channel Spacing).
Test Procedures:	Both conducted and radiated emissions measurements were conducted in accordance with TIA/EIA Standard TIA/EIA-603-E – Land Mobile FM or PM Communications Equipment Measurement and performance Standards.

1.2. RELATED SUBMITTAL(S)/GRANT(S)

None

1.3. NORMATIVE REFERENCES

Publication	Year	Title
FCC CFR Parts 0-19, 80-End	2017	Code of Federal Regulations – Telecommunication
ANSI C63.4	2014	American National Standard for Methods of Measurement of Radio-Noise Emissions from Low-Voltage Electrical and Electronic Equipment in the Range of 9 kHz to 40 GHz
TIA/EIA 603, Edition E	2016	Land Mobile FM or PM Communications Equipment Measurement and Performance Standards
ANSI C63.26	2015	American National Standard for Compliance Testing of Transmitters used in Licensed Radio Services
CISPR 22	2008-09 Ed 6	Information Technology Equipment - Radio Disturbance Characteristics - Limits and Methods of Measurement
CISPR 16-1-1 +A1 +A2	2006 2006 2007	Specification for radio disturbance and immunity measuring apparatus and methods. Part 1-1: Measuring Apparatus
CISPR 16-1-2 +A1 +A2	2003 2004 2006	Specification for radio disturbance and immunity measuring apparatus and methods. Part 1-2: Conducted disturbances

ULTRATECH GROUP OF LABS

3000 Bristol Circle, Oakville, Ontario, Canada L6H 6G4
Tel. #: 905-829-1570, Fax. #: 905-829-8050, Email: vic@ultratech-labs.com, Website: <http://www.ultratech-labs.com>

File #: 18ICOM488_FCC90

July 4, 2018

All test results contained in this engineering test report are traceable to National Institute of Standards and Technology (NIST)

EXHIBIT 2. PERFORMANCE ASSESSMENT

2.1. CLIENT INFORMATION

APPLICANT	
Name:	Icom Incorporated
Address:	1-1-32, Kamiminami Hirano-ku, Osaka Japan, 547-0003
Contact Person:	Mr. Atsushi Tomiyama Phone #: +81 6 6793 5302 Fax #: +81 6 6793 0013 Email Address: world_support@icom.co.jp

MANUFACTURER	
Name:	Icom Incorporated
Address:	1-1-32, Kamiminami Hirano-ku, Osaka Japan, 547-0003
Contact Person:	Mr. Atsushi Tomiyama Phone #: +81 6 6793 5302 Fax #: +81 6 6793 0013 Email Address: world_support@icom.co.jp

2.2. EQUIPMENT UNDER TEST (EUT) INFORMATION

The applicant has supplied the following information (with the exception of the Date of Receipt).

Brand Name:	ICOM Incorporated
Product Name:	UHF TRANSCEIVER
Model Name or Number:	IC-F2100DT
Serial Number:	31000213-1
Type of Equipment:	Licensed Non-Broadcast Station Transmitter
Power Supply Requirement:	7.5 VDC nominal
Transmitting/Receiving Antenna Type:	Non-integral
Primary User Functions of EUT:	2-Way Wireless Voice & Data Communication

2.3. EUT'S TECHNICAL SPECIFICATIONS

TRANSMITTER	
Equipment Type:	Portable
Intended Operating Environment:	Restricted to Occupational Use only
Power Supply Requirement:	7.5 VDC nominal
RF Output Power Rating:	4 Watt (High) / 1 Watt (Low)
Operating Frequency Range:	400-406 & 406.1-470 MHz
RF Output Impedance:	50 Ω
Channel Spacing:	25 kHz, 12.5 kHz, 6.25kHz
Occupied Bandwidth (99%):	15.24 kHz (for 25 kHz Analog) 10.26 kHz (for 12.5 kHz Analog) 3.96 kHz (for 6.25 kHz Digital)
Emission Designation*:	Analog: 16K0F3E**, 11K0F3E, Digital: 4K00F1E, 4K00F1D
<p>* For an average case of commercial telephony, the Necessary Bandwidth is calculated as follows:</p> <p>For FM Voice Modulation: Channel Spacing = 25 KHz, D = 5 KHz max, K = 1, M = 3 KHz $B_n = 2M + 2DK = 2(3) + 2(5)(1) = \mathbf{16\ KHz}$ Emission designation: 16K0F3E</p> <p>Channel Spacing = 12.5 KHz, D = 2.5 KHz max, K = 1, M = 3 KHz $B_n = 2M + 2DK = 2(3) + 2(2.5)(1) = \mathbf{11\ KHz}$ Emission designation: 11K0F3E</p> <p>**Note: The emission designation 16K0F3E with 25 KHz Channel bandwidth is only applied to the device operated in FCC Rules Part 22, 74 & 80 frequencies. The operation of 16K0F3E emission will be disabled in the firmware by the manufacturer for device that operates in FCC Rules Part 90 frequencies (Private Land Mobile) as declared by the applicant.</p>	

2.4. LIST OF EUT'S PORTS

Port Number	EUT's Port Description	Number of Identical Ports	Connector Type	Terminated with
1	Speaker-Microphone Connector	1	Speaker Microphone Jack	Speaker-Microphone
2	Antenna Connector	1	Special type	50 Ohm Load

2.5. ANCILLARY EQUIPMENT

The EUT was tested while connected to the following representative configuration of ancillary equipment necessary to exercise the ports during tests:

Ancillary Equipment # 1	
Description:	GPS Speaker Microphone
Brand Name:	Icom Inc.
Model Name or Number:	HM-171GPW

EXHIBIT 3. EUT OPERATING CONDITIONS AND CONFIGURATIONS DURING TESTS

3.1. CLIMATE TEST CONDITIONS

The climate conditions of the test environment are as follows:

Temperature:	21°C - 24°C
Humidity:	45% to 58%
Pressure:	102 kPa
Power Input Source:	7.5 VDC Nominal

3.2. OPERATIONAL TEST CONDITIONS & ARRANGEMENT FOR TEST SIGNALS

Operating Modes:	The transmitter was operated in a continuous transmission mode with the carrier modulated as specified in the Test Data.
Special Test Software:	N/A
Special Hardware Used:	N/A
Transmitter Test Antenna:	The EUT is tested with the antenna port terminated to a 50 Ohm RF Load.

Transmitter Test Signals	
Frequency Band(s):	400-406 & 406.1- 470 MHz
Test Frequencies: (Near lowest, near middle & near highest frequencies in the frequency range of operation.)	406.2 MHz, 450.1 MHz, 469.975 MHz
Transmitter Wanted Output Test Signals:	
Transmitter Power (measured maximum output power):	4.16 W High and 1.07 W Low
Normal Test Modulation:	FM Voice/Digital
Modulating signal source:	External

EXHIBIT 4. SUMMARY OF TEST RESULTS

4.1. LOCATION OF TESTS

All of the measurements described in this report were performed at Ultratech Group of Labs located in the city of Oakville, Province of Ontario, Canada.

Radiated Emissions were performed at the Ultratech's 3-10 TDK Semi-Anechoic Chamber situated in the Town of Oakville, province of Ontario. This test site been calibrated in accordance with ANSI C63.4, and found to be in compliance with the requirements of Sec. 2.948 of the FCC Rules. The descriptions and site measurement data of the Oakville 3-10 TDK Semi-Anechoic Chamber has been filed with ANAB File No.: AT-1945.

4.2. APPLICABILITY & SUMMARY OF EMISSION TEST RESULTS

FCC Section(s)	Test Requirements	Applicability (Yes/No)
1.1307, 1.1310, 2.1091 & 2.1093	RF Exposure Limit	Yes, Refer to SAR Report
2.1046, 22.565, 74.461, 80.215 & 90.205	RF Power Output	Yes
2.1047(a), 80.213(e) & 90.242(b)(8)	Audio Frequency Response	Not applicable to new standard. However, tests are conducted under FCC's recommendation.
2.1047(b), 74.463, 80.213 & 90.210	Modulation Limiting	Yes
2.1049, 74.462, 80.211(f), 90.209 & 90.210	Emission Limitation & Emission Mask	Yes
2.1051, 2.1057, 80.211(f)(3), & 90.210	Emission Limits - Spurious Emissions at Antenna Terminal	Yes
2.1053, 2.1057, 22.359, 80.211(f)(3), & 90.210	Emission Limits - Field Strength of Spurious Emissions	Yes
2.1055, 22.355, 74.464 80.209 & 90.213	Frequency Stability	Yes
74.462(c) & 90.214	Transient Frequency Behavior	Yes
UHF TRANSCEIVER, Model No.: IC-F2100D/DT/DS, by ICOM Incorporated has also been tested and found to comply with FCC Part 15, Subpart B - Radio Receivers and Class B Digital Devices. The engineering test report has been documented and kept on file and is available upon request.		

4.3. MODIFICATIONS INCORPORATED IN THE EUT FOR COMPLIANCE PURPOSES

None

4.3.1. DEVIATION OF STANDARD TEST PROCEDURES

None

ULTRATECH GROUP OF LABS

3000 Bristol Circle, Oakville, Ontario, Canada L6H 6G4
 Tel. #: 905-829-1570, Fax. #: 905-829-8050, Email: vic@ultratech-labs.com, Website: <http://www.ultratech-labs.com>

File #: 18ICOM488_FCC90
 July 4, 2018

All test results contained in this engineering test report are traceable to National Institute of Standards and Technology (NIST)

EXHIBIT 5. MEASUREMENTS, EXAMINATIONS & TEST DATA FOR EMC EMISSIONS

5.1. TEST PROCEDURES

This section contains test results only. Details of test methods and procedures can be found in EXHIBIT 8 of this report.

5.2. MEASUREMENT UNCERTAINTIES

The measurement uncertainties stated were calculated in accordance with the requirements of CISPR 16-4-2 @ IEC:2003 and JCGM 100:2008 (GUM 1995) – Guide to the Expression of Uncertainty in Measurement. Refer to Exhibit 7 for Measurement Uncertainties.

5.3. MEASUREMENT EQUIPMENT USED

The measurement equipment used complied with the requirements of the Standards referenced in the Methods & Procedures ANSI C63.4 and CISPR 16-1-1.

5.4. ESSENTIAL/PRIMARY FUNCTIONS AS DECLARED BY THE MANUFACTURER

The essential function of the EUT is to communicate to and from radios over RF link.

5.5. RF POWER OUTPUT [§§ 2.1046, 22.565, 74.461, 80.215 & 90.205]

5.5.1. Limits

Please refer to FCC 47 CFR 90.205, 74.461, 80.215 & 22.565 for specification details.

5.5.2. Method of Measurements

Refer to Section 8.1 (Conducted) and 8.2 (Radiated) of this report for measurement details

5.5.3. Test Arrangement

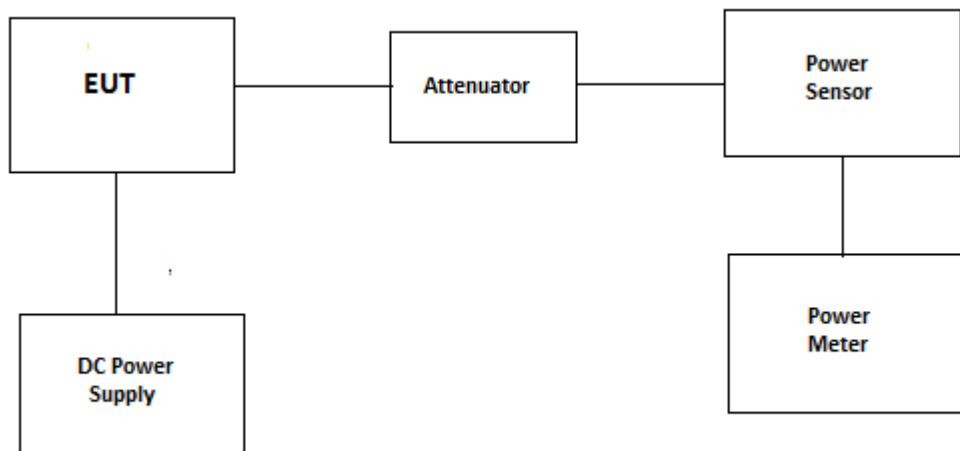

5.5.4. Test Data

Frequencies MHz	Power Rating Watts	Power Rating dBm	Measured Power dBm	Measured Power Watts
406.200	4.0	36.02	36.15	4.12
450.100	4.0	36.02	36.19	4.16
469.975	4.0	36.02	36.14	4.11
406.200	1.0	30.00	30.34	1.08
450.100	1.0	30.00	30.45	1.11
469.975	1.0	30.00	30.30	1.07
406.200	2.0	33.01	33.18	2.08
450.100	2.0	33.01	33.27	2.12
469.975	2.0	33.01	33.21	2.09

5.6. AUDIO FREQUENCY RESPONSE [§ 2.1047(a), 80.213(e) & 90.242(b)(8)]

5.6.1. Limits

§ 2.1047(a): Voice modulated communication equipment. A curve or equivalent data showing the frequency response of the audio modulating circuit over a range of 100 to 5000 Hz shall be submitted. For equipment required to have an audio low-pass filter, a curve showing the frequency response of the filter or of all circuitry installed between the modulation limiter and the modulated stage shall be submitted.

§ 90.242(b)(8): Recommended audio filter attenuation characteristics are given below:

Audio band	Minimum Attenuation Rel. to 1 kHz Attenuation
3 –20 KHz	$60 \log_{10}(f/3)$ dB where f is in kHz
20 – 30 KHz	50dB

5.6.2. Method of Measurements

The rated audio input signal was applied to the input of the audio low-pass filter (or of all modulation stages) using an audio oscillator, this input signal level and its corresponding output signal were then measured and recorded using the FFT Digital Spectrum Analyzer. Tests were repeated at different audio signal frequencies from 0 to 50 KHz.

5.6.3. Test Arrangement

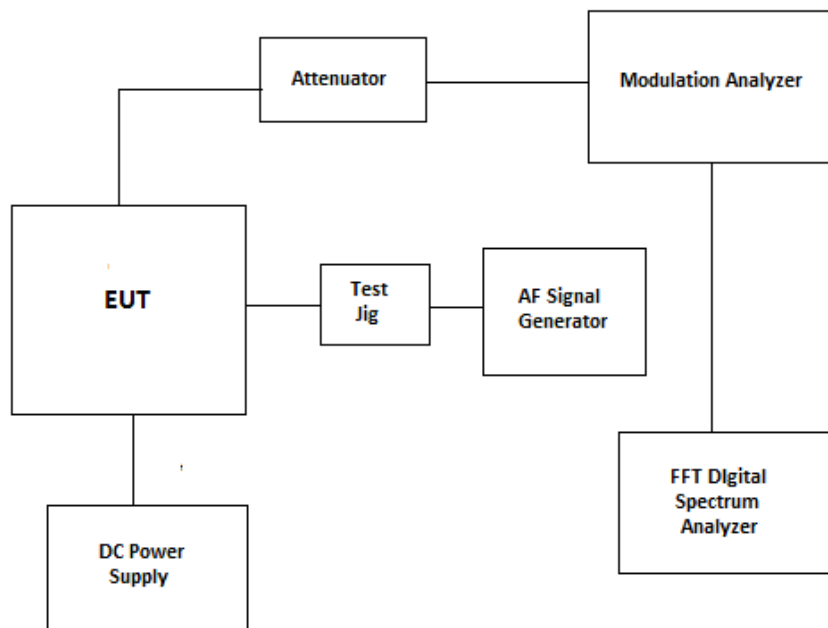

5.6.4. Test Data

5.6.4.1. 12.5 KHz Channel Spacing, F3E

Remark: Due to the difficulty of measuring the Frequency Response of the internal low-pass filter, the Frequency Response of All Modulation States is performed to show the roll-off at 3 kHz in comparison with the recommended audio filter attenuation.

Frequency (KHz)	Audio In (dBV)	Audio Out (dBV)	Attenuation (Out - In) (dB)	Attenuation Rel. to 1 KHz (dB)	Recommended Attenuation (dB)
0.1	-37.20	-43.40	-6.2	-41.9	--
0.3	-37.20	-16.59	20.6	-15.1	--
0.4	-37.20	-11.72	25.5	-10.2	--
0.6	-37.20	-6.50	30.7	-5.0	--
0.8	-37.20	-3.42	33.8	-1.9	--
1.0	-37.20	-1.52	35.7	0.0	--
1.5	-37.20	2.19	39.4	3.7	--
2.0	-37.20	3.10	40.3	4.6	--
2.5	-37.20	1.79	39.0	3.3	--
3.0	-37.20	-2.09	35.1	-0.6	0
3.5	-37.20	-9.83	27.4	-8.3	-4
4.0	-37.20	-30.20	7.0	-28.7	-7
4.5	-37.20	-47.80	-10.6	-46.3	-11
5.0	-37.20	-70.00	-32.8	-68.5	-13
6.0	-37.20	-70.00	-32.8	-68.5	-18
7.0	-37.20	-70.00	-32.8	-68.5	-22
8.0	-37.20	-70.00	-32.8	-68.5	-26
9.0	-37.20	-70.00	-32.8	-68.5	-29
10.0	-37.20	-70.00	-32.8	-68.5	-31
12.0	-37.20	-70.00	-32.8	-68.5	-36
14.0	-37.20	-70.00	-32.8	-68.5	-40
16.0	-37.20	-70.00	-32.8	-68.5	-44
18.0	-37.20	-70.00	-32.8	-68.5	-47
20.0	-37.20	-70.00	-32.8	-68.5	-50
25.0	-37.20	-70.00	-32.8	-68.5	-50
30.0	-37.20	-70.00	-32.8	-68.5	-50
35.0	-37.20	-70.00	-32.8	-68.5	-50
40.0	-37.20	-70.00	-32.8	-68.5	-50
45.0	-37.20	-70.00	-32.8	-68.5	-50
50.0	-37.20	-70.00	-32.8	-68.5	-50

ULTRATECH GROUP OF LABS

3000 Bristol Circle, Oakville, Ontario, Canada L6H 6G4
 Tel. #: 905-829-1570, Fax. #: 905-829-8050, Email: vic@ultratech-labs.com, Website: <http://www.ultratech-labs.com>

File #: 18ICOM488_FCC90

July 4, 2018

All test results contained in this engineering test report are traceable to National Institute of Standards and Technology (NIST)

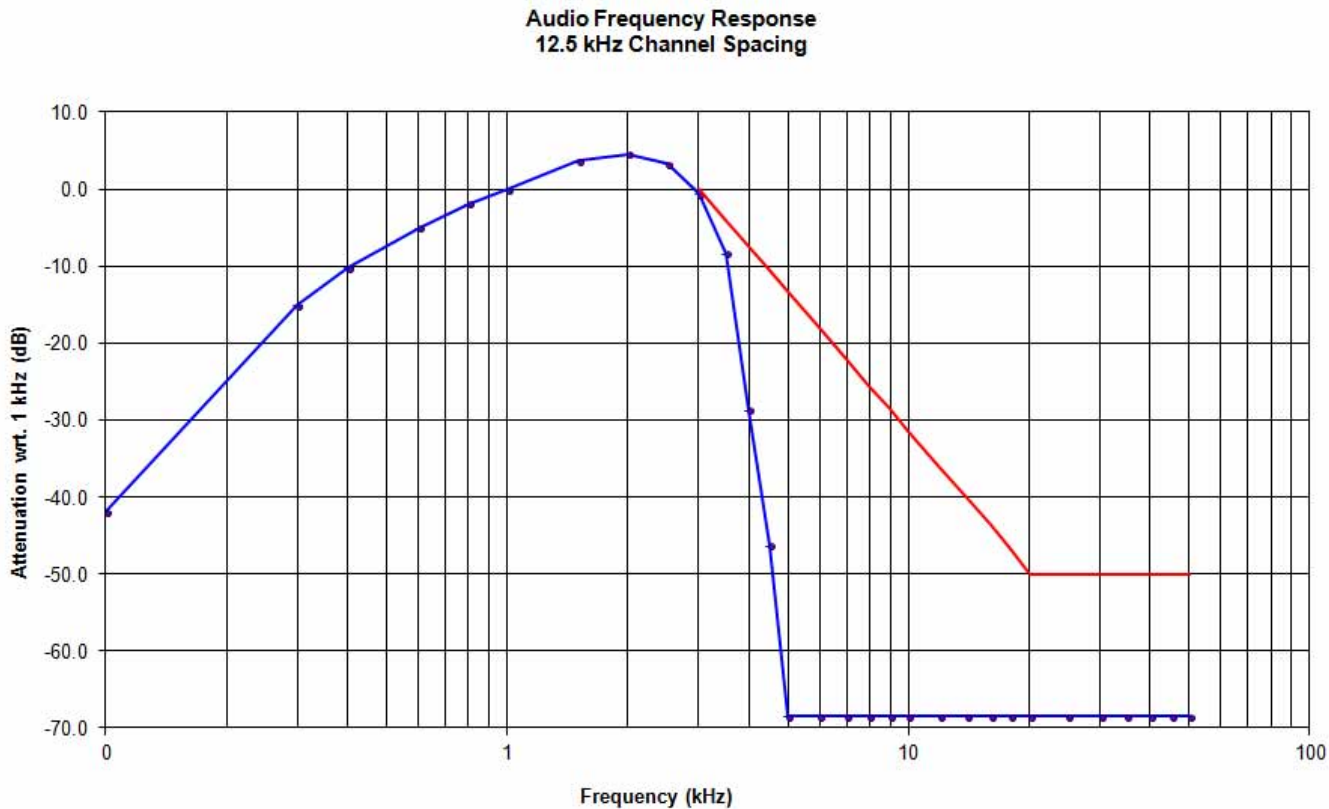

5.6.4.2. 25 KHz Channel Spacing, F3E

Note: Due to the difficulty of measuring the Frequency Response of the internal low-pass filter, the Frequency Response of All Modulation States is performed to show the roll-off at 3 KHz in comparison with the recommended audio filter attenuation.

Frequency (KHz)	Audio In (dBV)	Audio Out (dBV)	Attenuation (Out - In) (dB)	Attenuation Rel. to 1 KHz (dB)	Recommended Attenuation (dB)
0.1	-36.59	-36.77	-0.2	-41.7	--
0.3	-36.59	-10.14	26.5	-15.1	--
0.4	-36.59	-5.38	31.2	-10.3	--
0.6	-36.59	-0.26	36.3	-5.2	--
0.8	-36.59	2.80	39.4	-2.1	--
1.0	-36.59	4.93	41.5	0.0	--
1.5	-36.59	8.36	44.9	3.4	--
2.0	-36.59	9.12	45.7	4.2	--
2.5	-36.59	8.38	45.0	3.5	--
3.0	-36.59	5.36	42.0	0.4	0
3.5	-36.59	-0.92	35.7	-5.8	-4
4.0	-36.59	-18.09	18.5	-23.0	-7
4.5	-36.59	-40.07	-3.5	-45.0	-11
5.0	-36.59	-70.00	-33.4	-74.9	-13
6.0	-36.59	-70.00	-33.4	-74.9	-18
7.0	-36.59	-70.00	-33.4	-74.9	-22
8.0	-36.59	-70.00	-33.4	-74.9	-26
9.0	-36.59	-70.00	-33.4	-74.9	-29
10.0	-36.59	-70.00	-33.4	-74.9	-31
12.0	-36.59	-70.00	-33.4	-74.9	-36
14.0	-36.59	-70.00	-33.4	-74.9	-40
16.0	-36.59	-70.00	-33.4	-74.9	-44
18.0	-36.59	-70.00	-33.4	-74.9	-47
20.0	-36.59	-70.00	-33.4	-74.9	-50
25.0	-36.59	-70.00	-33.4	-74.9	-50
30.0	-36.59	-70.00	-33.4	-74.9	-50
35.0	-36.59	-70.00	-33.4	-74.9	-50
40.0	-36.59	-70.00	-33.4	-74.9	-50
45.0	-36.59	-70.00	-33.4	-74.9	-50
50.0	-36.59	-70.00	-33.4	-74.9	-50

ULTRATECH GROUP OF LABS

3000 Bristol Circle, Oakville, Ontario, Canada L6H 6G4
 Tel. #: 905-829-1570, Fax. #: 905-829-8050, Email: vic@ultratech-labs.com, Website: <http://www.ultratech-labs.com>

File #: 18ICOM488_FCC90

July 4, 2018

All test results contained in this engineering test report are traceable to National Institute of Standards and Technology (NIST)



5.7. MODULATION LIMITING [§§ 2.1047 (b), 74.463, 80.213 & 90.210]

5.7.1. Limits

§ 2.1047(b): Equipment which employs modulation limiting. A curve or family of curves showing the percentage of modulation versus the modulation input voltage shall be supplied. The information submitted shall be sufficient to show modulation limiting capability throughout the range of modulating frequencies and input modulating signal levels employed.

Recommended frequency deviation characteristics are given below:

- 1.25 KHz for 6.25 kHz Channel Spacing System
- 2.5 KHz for 12.5 kHz Channel Spacing System

5.7.2. Method of Measurements

For Audio Transmitter: The carrier frequency deviation was measured with the tone input signal level varied from 0 Vp to audio input rating level plus 16 dB at frequencies 0.1, 0.5, 1.0, 3.0 and 5.0 kHz. The maximum deviation was recorded at each test condition.

For Data Transmitter with Maximum Frequency Deviation set by Factory: The EUT was set at maximum frequency deviation, and its peak frequency deviation was then measured using EUT's internal random data source.

5.7.3. Test Arrangement

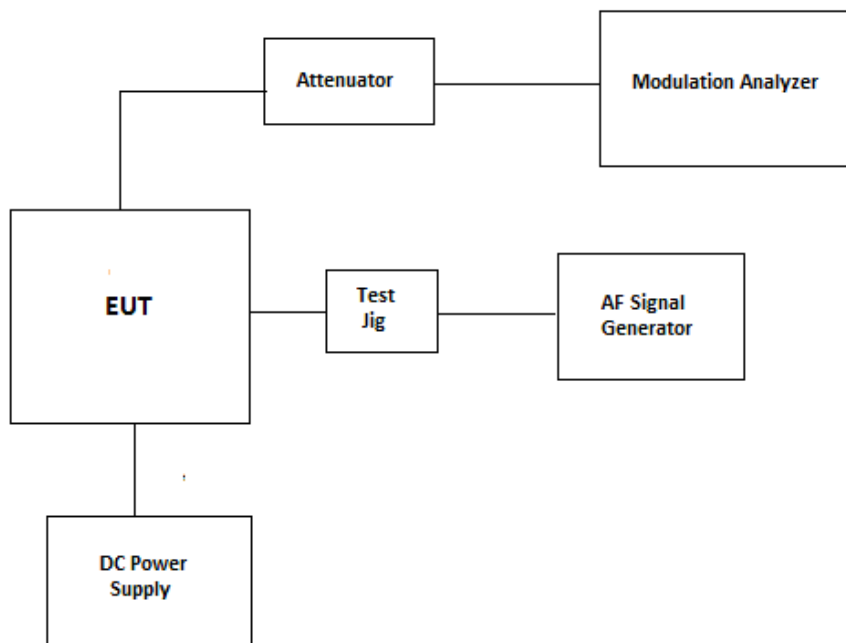

5.7.4. Test Data

5.7.4.1. Voice Modulation Limiting for 12.5 KHz Channel Spacing Operation

Modulating Signal Level (mVrms)	Peak Frequency Deviation (kHz) at the following modulating frequency:					Maximum Limit (kHz)
	0.1 kHz	0.5 kHz	1.0 kHz	3.0 kHz	5.0 kHz	
2	0.06	0.11	0.21	0.37	0.05	2.5
4	0.05	0.18	0.39	0.69	0.05	2.5
6	0.05	0.26	0.57	1.00	0.06	2.5
8	0.06	0.34	0.75	1.09	0.05	2.5
10	0.06	0.40	0.91	1.12	0.05	2.5
15	0.06	0.59	1.35	1.14	0.06	2.5
20	0.06	0.79	1.80	1.16	0.05	2.5
25	0.06	0.97	1.96	1.17	0.05	2.5
30	0.07	1.17	2.07	1.18	0.05	2.5
35	0.07	1.36	2.09	1.18	0.05	2.5
40	0.08	1.54	2.09	1.17	0.05	2.5
45	0.09	1.73	2.09	1.18	0.05	2.5
50	0.08	1.81	2.10	1.17	0.06	2.5
60	0.09	1.89	2.10	1.19	0.06	2.5
70	0.10	2.07	2.10	1.19	0.06	2.5
80	0.10	2.20	2.11	1.18	0.06	2.5
90	0.12	2.21	2.11	1.18	0.06	2.5
100	0.12	2.21	2.11	1.18	0.06	2.5

Voice Signal Input Level = STD MOD Level + 16 dB = 13.8mVrms + 16 dB = 38.80 dB(mVrms) = 87.07 mVrms		
Modulation Frequency (kHz)	Peak Deviation (kHz)	Maximum Limit (kHz)
0.1	0.11	2.5
0.2	0.55	2.5
0.4	1.92	2.5
0.6	2.19	2.5
0.8	2.20	2.5
1.0	2.11	2.5
1.2	2.16	2.5
1.4	2.15	2.5
1.6	2.15	2.5
1.8	2.16	2.5
2.0	2.18	2.5
2.5	1.87	2.5
3.0	1.20	2.5
3.5	0.52	2.5
4.0	0.09	2.5
4.5	0.06	2.5
5.0	0.05	2.5
6.0	0.05	2.5
7.0	0.05	2.5
8.0	0.05	2.5
9.0	0.05	2.5
10.0	0.05	2.5

ULTRATECH GROUP OF LABS

3000 Bristol Circle, Oakville, Ontario, Canada L6H 6G4
 Tel. #: 905-829-1570, Fax. #: 905-829-8050, Email: vic@ultratech-labs.com, Website: <http://www.ultratech-labs.com>

File #: 18ICOM488_FCC90

July 4, 2018

All test results contained in this engineering test report are traceable to National Institute of Standards and Technology (NIST)

5.7.4.2. Voice Modulation Limiting for 25 KHz Channel Spacing Operation

Modulating Signal Level (mVrms)	Peak Frequency Deviation (kHz) at the following modulating frequency:					Maximum Limit (kHz)
	0.1 kHz	0.5 kHz	1.0 kHz	3.0 kHz	5.0 kHz	
2	0.06	0.19	0.38	0.82	0.06	5.0
4	0.06	0.33	0.71	1.57	0.05	5.0
6	0.05	0.48	1.06	2.31	0.06	5.0
8	0.06	0.63	1.42	2.53	0.05	5.0
10	0.06	0.76	1.72	2.61	0.06	5.0
15	0.07	1.12	2.57	2.67	0.06	5.0
20	0.08	1.51	3.47	2.71	0.06	5.0
25	0.08	1.88	3.76	2.71	0.05	5.0
30	0.09	2.25	4.06	2.72	0.05	5.0
35	0.10	2.62	4.11	2.77	0.05	5.0
40	0.10	3.00	4.13	2.78	0.05	5.0
45	0.11	3.38	4.13	2.78	0.06	5.0
50	0.12	3.55	4.13	2.77	0.06	5.0
60	0.13	3.72	4.13	2.79	0.05	5.0
70	0.16	4.03	4.15	2.77	0.05	5.0
80	0.17	4.34	4.18	2.80	0.05	5.0
90	0.18	4.37	4.18	2.80	0.05	5.0
100	0.20	4.38	4.18	2.80	0.05	5.0

Voice Signal Input Level = STD MOD Level + 16 dB
 = 14.8 mV + 16 dB
 = 39.41 dB(mVrms)
 = 93.38 mVrms

Modulation Frequency (KHz)	Peak Deviation (KHz)	Maximum Limit (KHz)
0.1	0.18	5.0
0.2	1.07	5.0
0.4	3.75	5.0
0.6	4.34	5.0
0.8	4.37	5.0
1.0	4.18	5.0
1.2	4.12	5.0
1.4	4.11	5.0
1.6	4.17	5.0
1.8	4.26	5.0
2.0	3.90	5.0
2.5	2.80	5.0
3.0	1.37	5.0
3.5	0.22	5.0
4.0	0.07	5.0
4.5	0.05	5.0
5.0	0.05	5.0
6.0	0.05	5.0
7.0	0.05	5.0
8.0	0.05	5.0
9.0	0.05	5.0
10.0	0.05	5.0

5.7.4.3.

5.7.4.4. 6.25 KHz Digital Modulation

Deviation: +/- 1.53 kHz

5.8. OCCUPIED BANDWIDTH & EMISSION MASK [§§ 2.1049, 74.462, 80.211(f), 90.209 & 90.210]

5.8.1. Limits

Emissions shall be attenuated below the mean output power of the transmitter as follows:

Frequency Range (MHz)	Maximum Authorized BW (KHz)	Channel Spacing (KHz)	Recommended Frequency Deviation (KHz)	FCC Applicable Mask
156-174, 421-512	11.25	12.5	2.5	Mask D – Voice & Data
156-174, 421-512	20	25	5.0	Mask B – Voice & Data
150-174, 421-512	6	6.25	1.25	Mask E – Voice & Data

§80.211(f) Emission limitations

Emissions shall be attenuated below the mean output power of the transmitter as follows:

- (1) On any frequency removed from the assigned frequency by more than 50 percent up to and including 100 percent of the authorized bandwidth: At least 25 dB;
- (2) On any frequency removed from the assigned frequency by more than 100 percent up to and including 250 percent of the authorized bandwidth: At least 35 dB; and
- (3) On any frequency removed from the assigned frequency by more than 250 percent of the authorized bandwidth: At least 43 plus $10\log_{10}$ (mean power in watts) dB.

5.8.2. Method of Measurements

Refer to Section 8.4 of this report for measurement details.

5.8.3. Test Arrangement

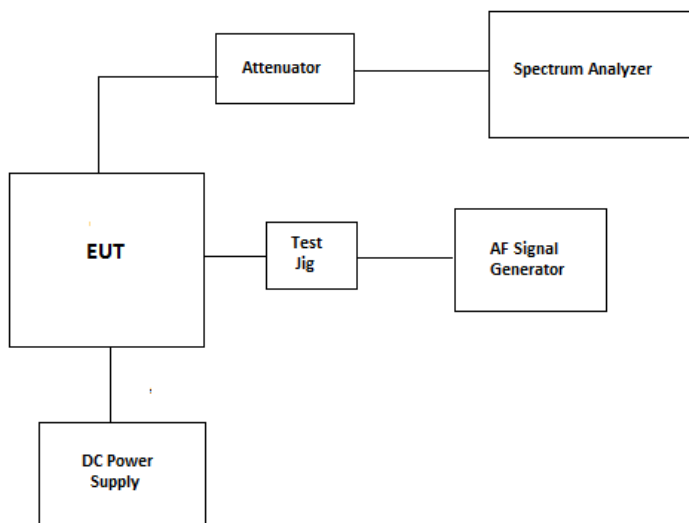

5.8.4. Test Data -99% Occupied Bandwidth

Frequency (MHz)	Channel Spacing (kHz)	Modulation	Measured 99% OBW at Maximum Freq. Deviation (kHz)	Maximum Authorized Bandwidth (kHz)
406.2	25.0	FM with 2.5 KHz sine wave signal	15.24	20.0
450.1	25.0	FM with 2.5 KHz sine wave signal	15.00	20.0
469.975	25.0	FM with 2.5 KHz sine wave signal	15.19	20.0
406.2	12.5	FM with 2.5 KHz sine wave signal	5.60	11.25
450.1	12.5	FM with 2.5 KHz sine wave signal	10.26	11.25
469.975	12.5	FM with 2.5 KHz sine wave signal	5.73	11.25
406.2	6.25	Digital Voice & Data	3.87	6.0
450.1	6.25	Digital Voice & Data	3.96	6.0
469.975	6.25	Digital Voice & Data	3.89	6.0

Note: 99% Occupied Bandwidth measurements were done using the built-in auto function of the analyzer.

Refer to the following test data plots for details.

5.8.4.1. Configuration: 99% OBW, 406.2MHz, 12.5 KHz, Analog, High power
OBW: 5.65 KHz

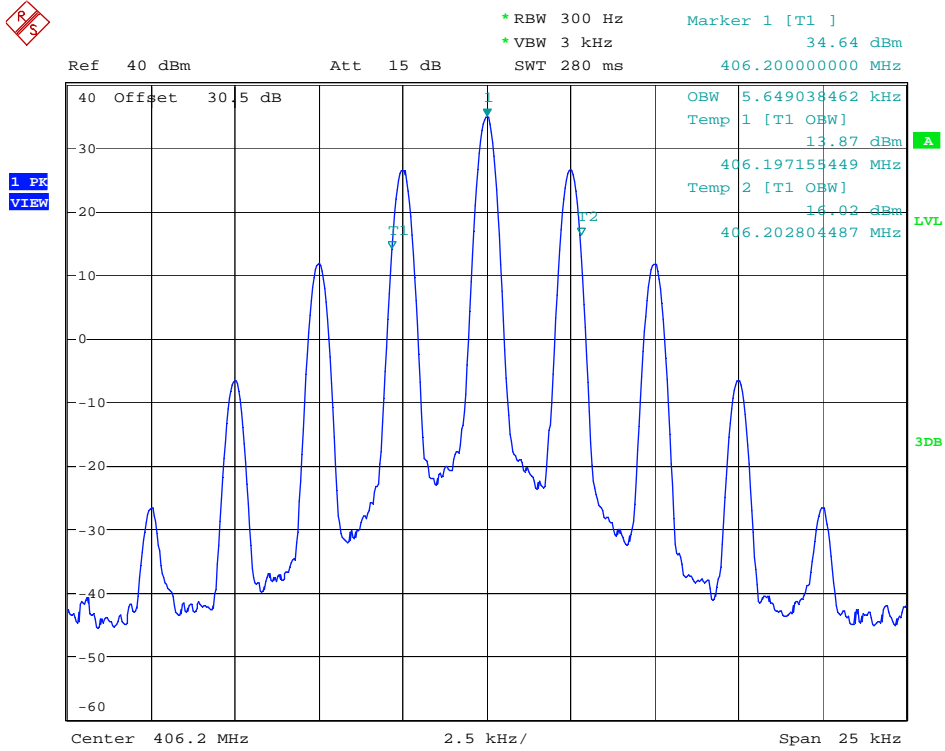

Date: 20.JUN.2018 13:49:39

5.8.4.2. Configuration: 99% OBW, 450.1MHz, 12.5 KHz, Analog, High power
 OBW: 10.26 KHz

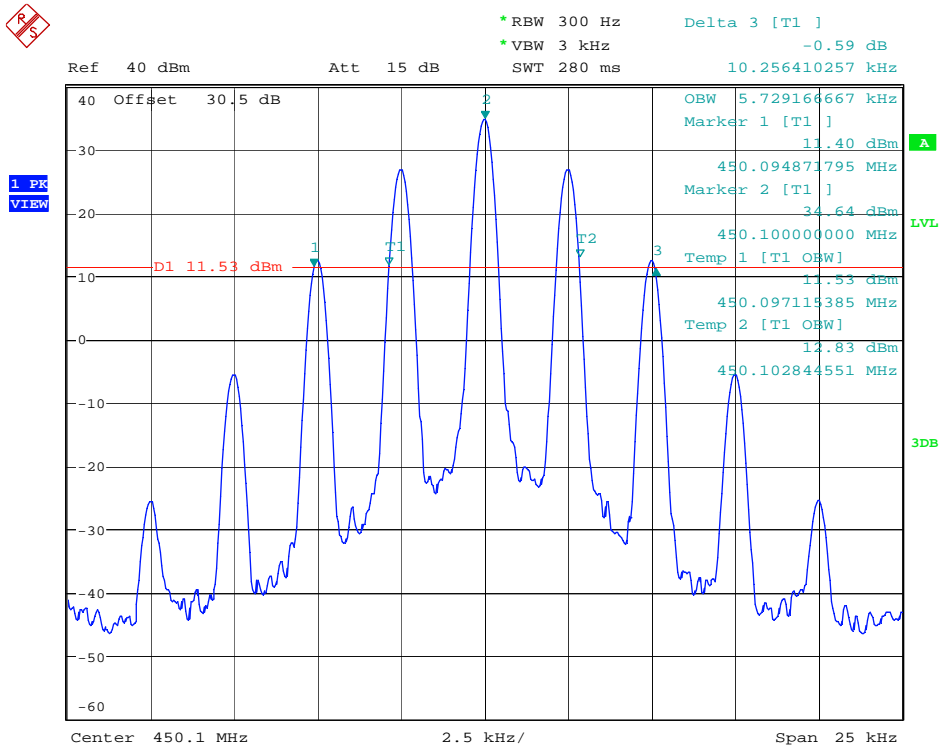

Date: 20.JUN.2018 13:53:36

5.8.4.3. Configuration: 99% OBW, 469.975MHz, 12.5 KHz, Analog, High power
OBW: 5.73 KHz

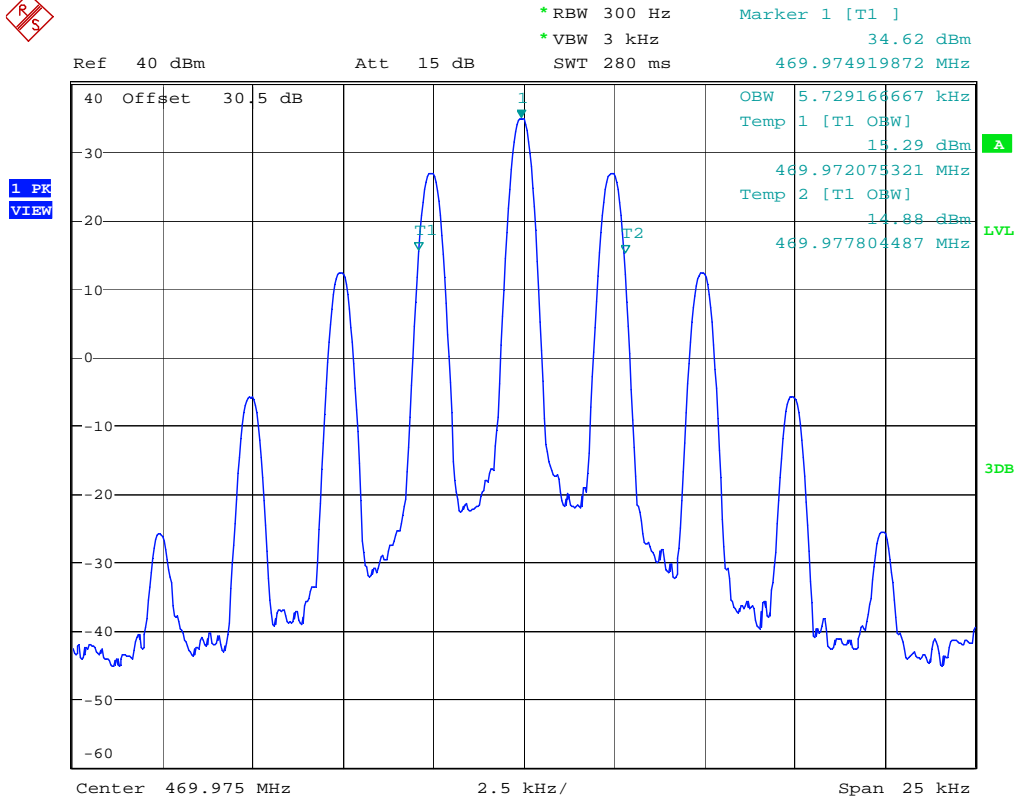

Date: 20.JUN.2018 14:02:26

ULTRATECH GROUP OF LABS

3000 Bristol Circle, Oakville, Ontario, Canada L6H 6G4
Tel. #: 905-829-1570, Fax. #: 905-829-8050, Email: vic@ultratech-labs.com, Website: <http://www.ultratech-labs.com>

File #: 18ICOM488_FCC90

July 4, 2018

All test results contained in this engineering test report are traceable to National Institute of Standards and Technology (NIST)

5.8.4.4. Configuration: 99% OBW, 406.2MHz, 25 KHz, Analog, High power
 OBW: 15.24 KHz

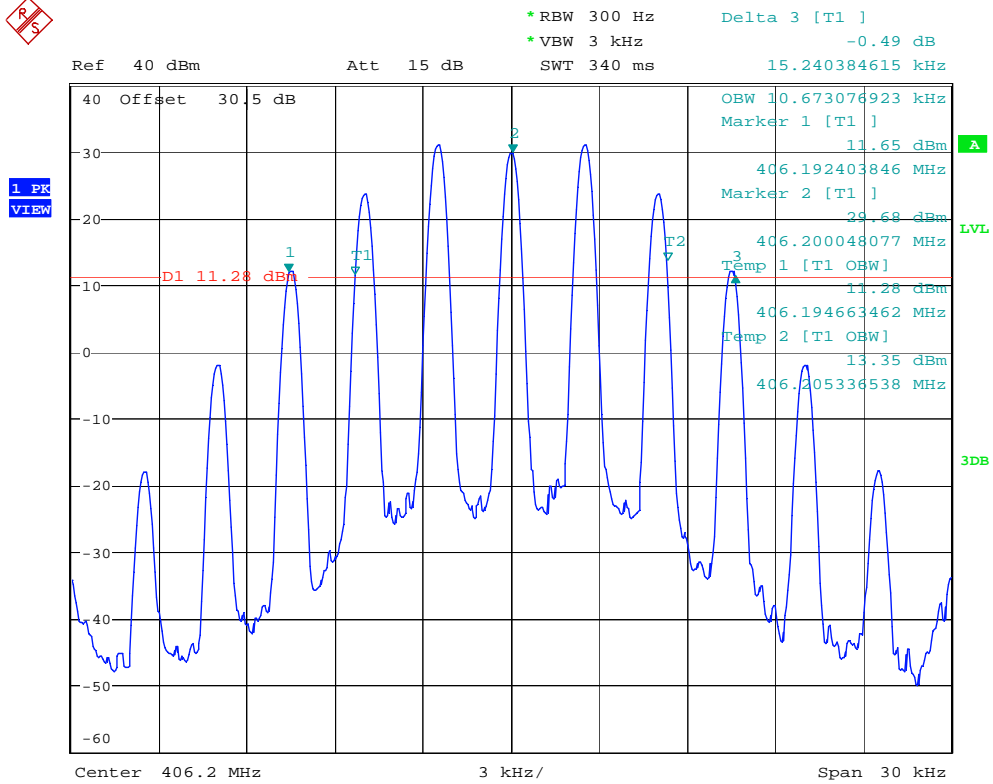

Date: 20.JUN.2018 15:01:05

5.8.4.5. Configuration: 99% OBW, 450.1MHz, 25 KHz, Analog, High power
 OBW: 15.00 KHz

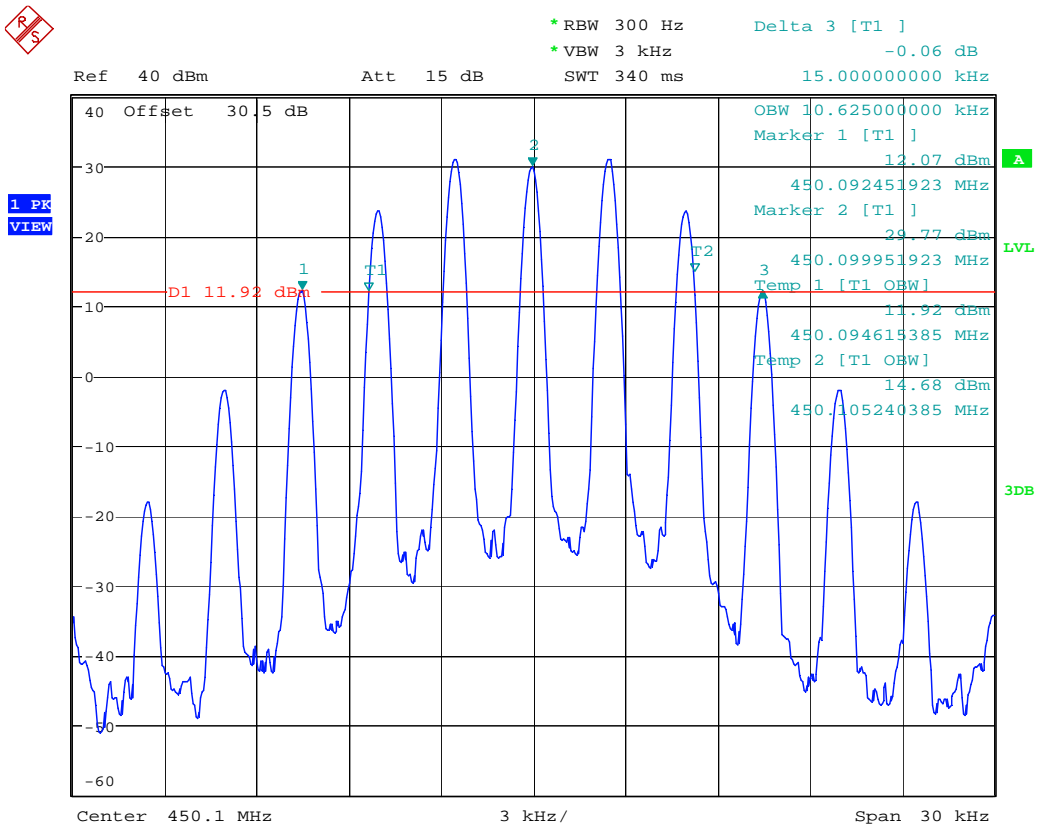

Date: 20.JUN.2018 15:04:39

5.8.4.6. Configuration: 99% OBW, 469.975MHz, 25 KHz, Analog, High power
 OBW: 15.2 KHz

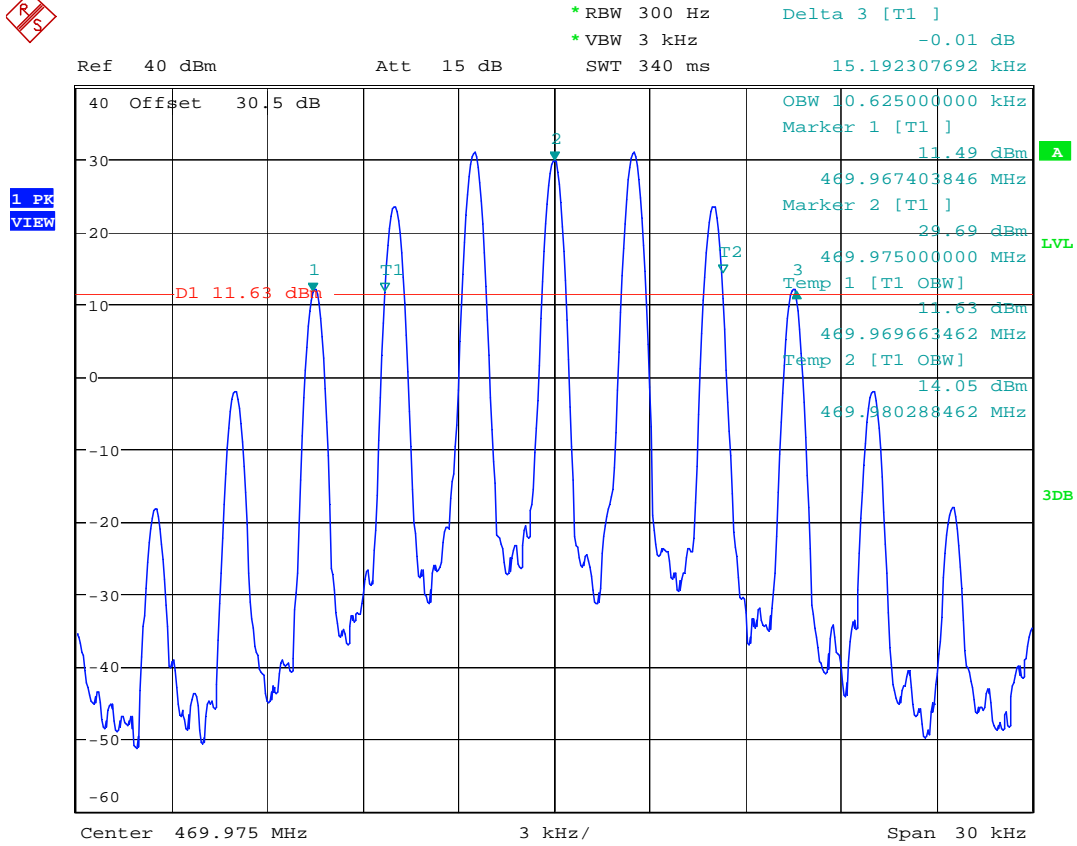

Date: 20.JUN.2018 15:08:54

5.8.4.7. Configuration: 99% OBW, 406.2MHz, 6.25 KHz, Digital, High power
 OBW: 3.87 KHz

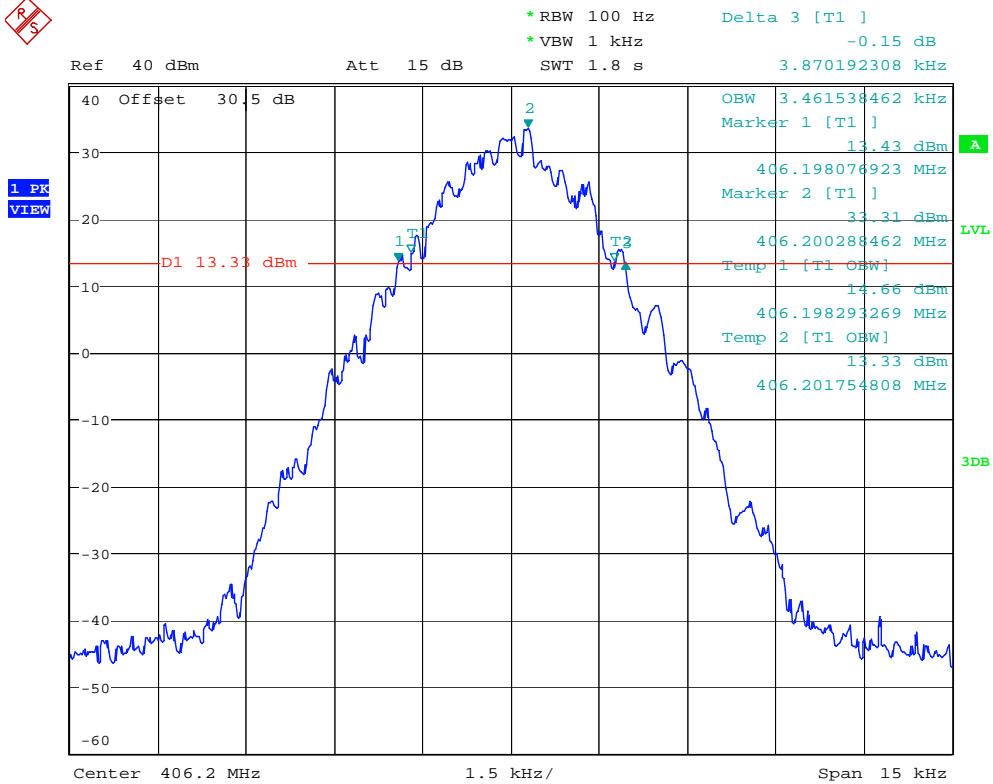

Date: 20.JUN.2018 15:45:53

5.8.4.8. Configuration: 99% OBW, 450.1MHz, 6.25 KHz, Digital, High power
 OBW: 3.96 KHz

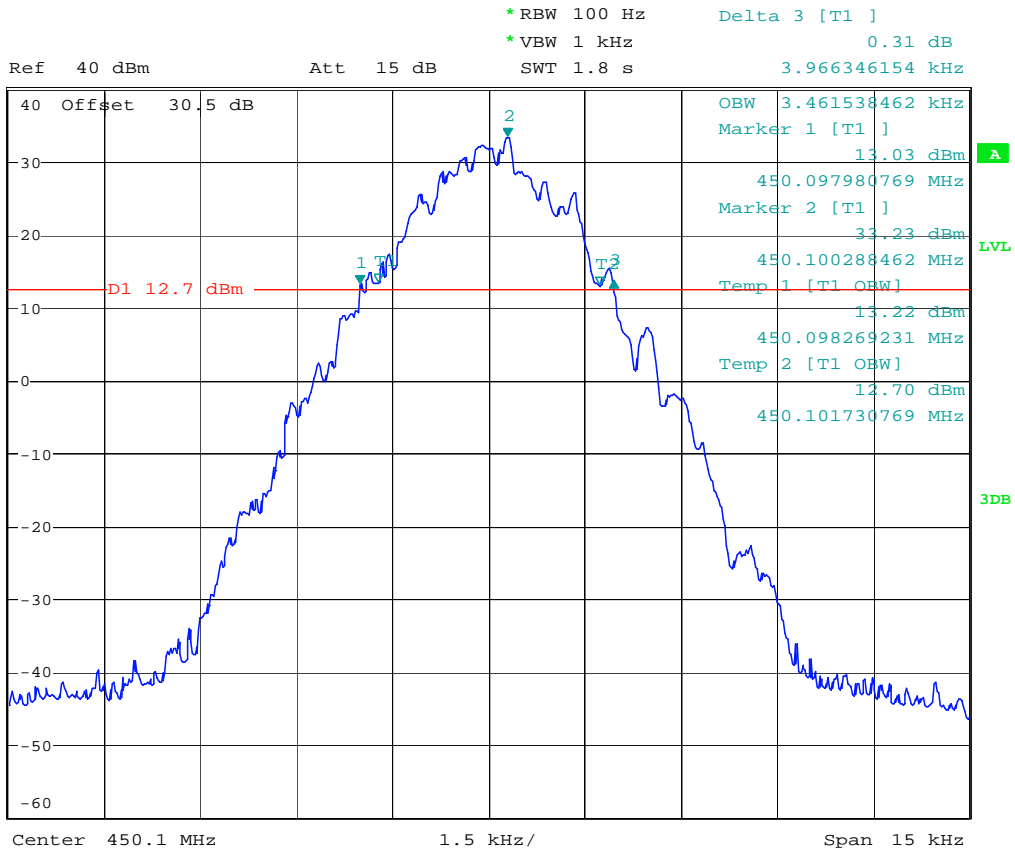

Date: 20.JUN.2018 15:40:56

5.8.4.9. Configuration: 99% OBW, 469.975MHz, 6.25 KHz, Digital, High power
 OBW: 3.89 KHz

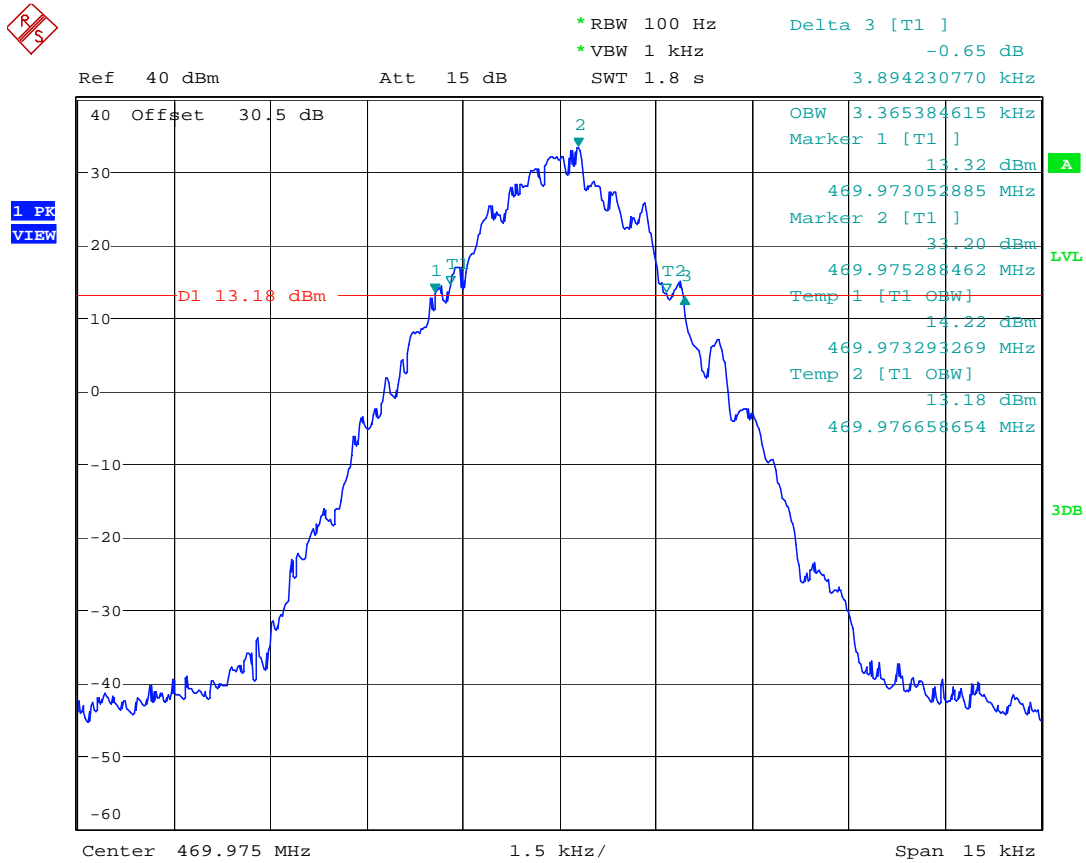

Date: 20.JUN.2018 15:34:42

5.8.5. Test Data- MASK B

5.8.5.1. Configuration: Mask B, 406.2MHz, 25 KHz, Analog, High power

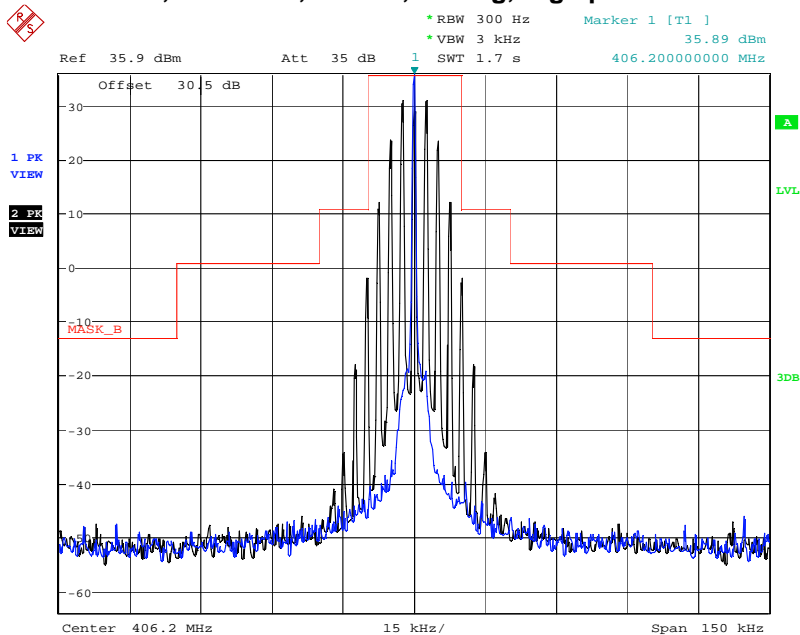

Date: 21.JUN.2018 09:13:44

5.8.5.2. Configuration: Mask B, 450.1MHz, 25 KHz, Analog, High power

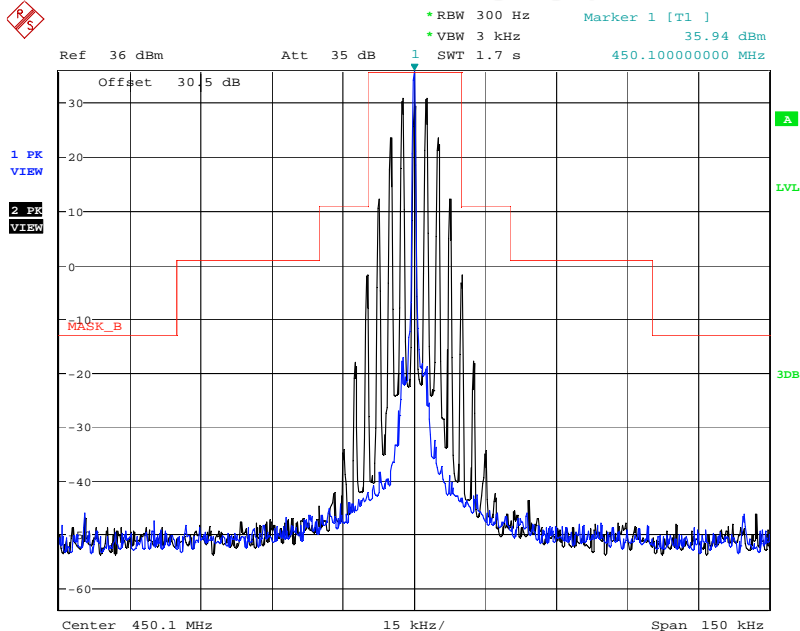

Date: 21.JUN.2018 09:16:48

5.8.5.3. Configuration: Mask B, 469.975MHz, 25 KHz, Analog, High power

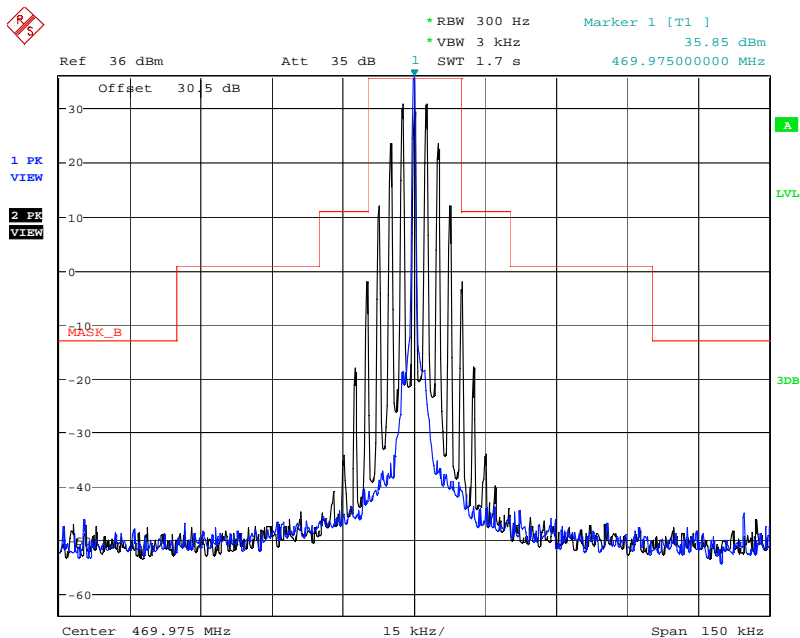

Date: 21.JUN.2018 09:20:02

5.8.5.4. Configuration: Mask B, 406.2MHz, 25 KHz, Analog, Low power

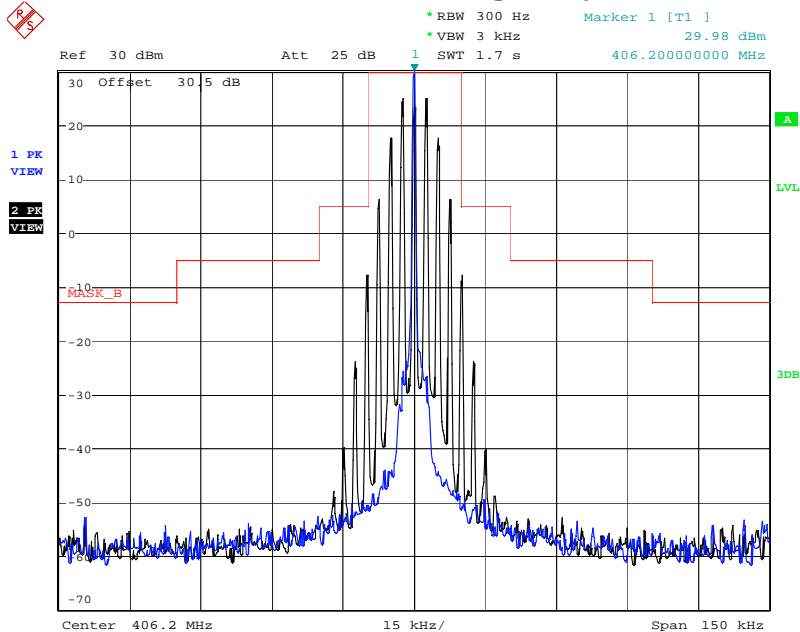

Date: 21.JUN.2018 09:35:18

5.8.5.5. Configuration: Mask B, 450.1MHz, 25 KHz, Analog, Low power

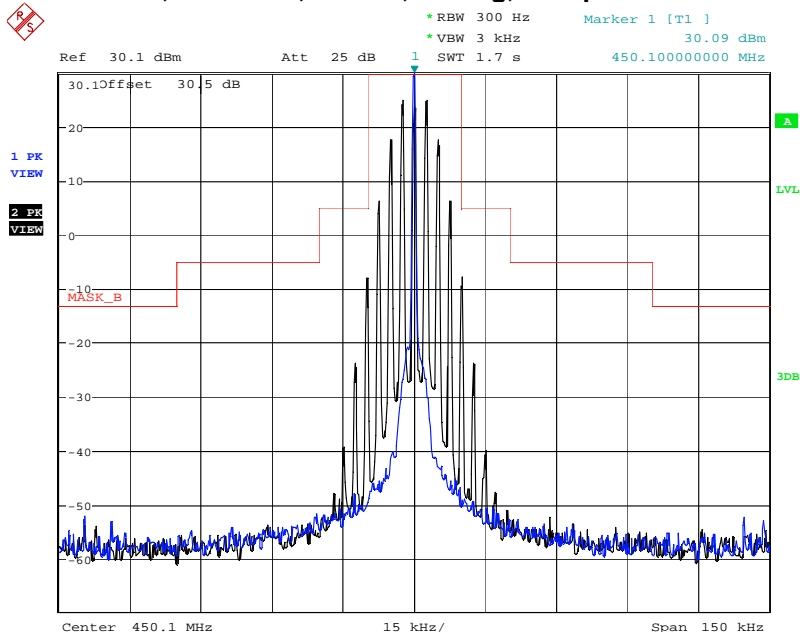

Date: 21.JUN.2018 09:38:37

5.8.5.6. Configuration: Mask B, 469.975MHz, 25 KHz, Analog, Low power

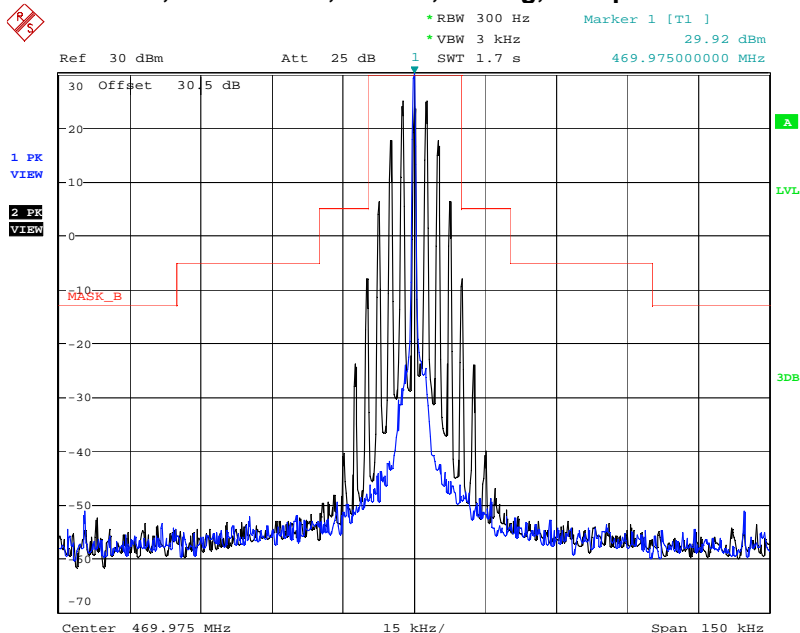

Date: 21.JUN.2018 09:41:21

ULTRATECH GROUP OF LABS

3000 Bristol Circle, Oakville, Ontario, Canada L6H 6G4
Tel. #: 905-829-1570, Fax. #: 905-829-8050, Email: vic@ultratech-labs.com, Website: <http://www.ultratech-labs.com>

File #: 18ICOM488_FCC90

July 4, 2018

All test results contained in this engineering test report are traceable to National Institute of Standards and Technology (NIST)

5.8.6. Test Data- Mask D

5.8.6.1. Configuration: Mask D, 406.2MHz, 12.5 KHz, Analog, High power

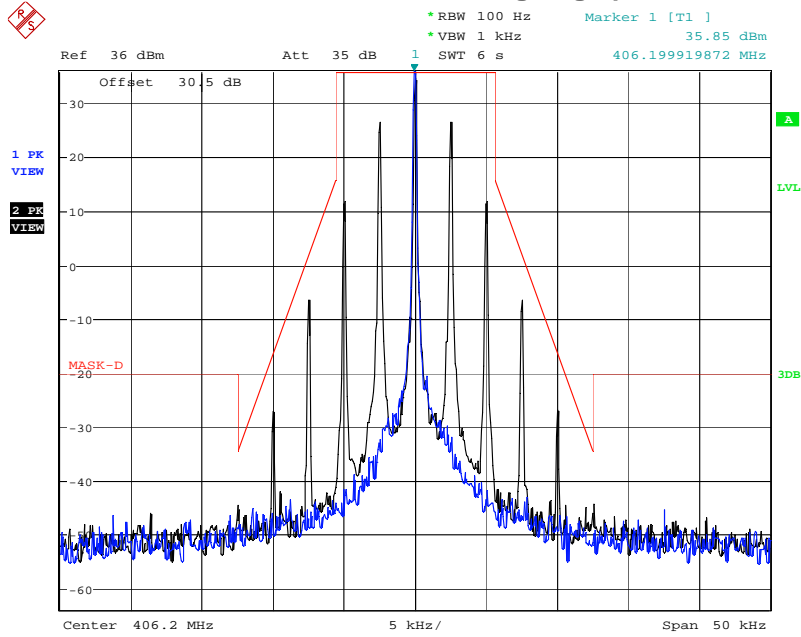

Date: 21.JUN.2018 09:46:32

5.8.6.2. Configuration: Mask D, 450.1MHz, 12.5 KHz, Analog, High power

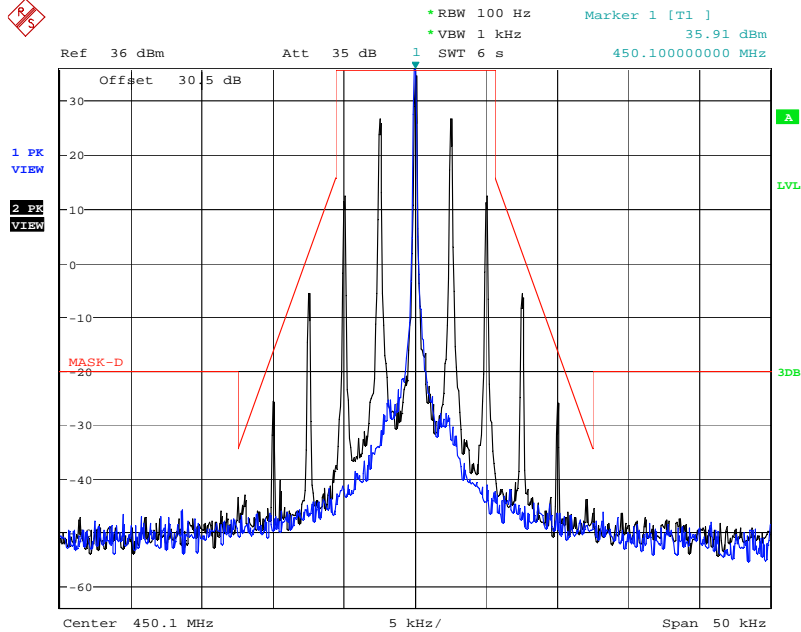

Date: 21.JUN.2018 09:49:51

5.8.6.3. Configuration: Mask D, 469.975MHz, 12.5 KHz, Analog, High power

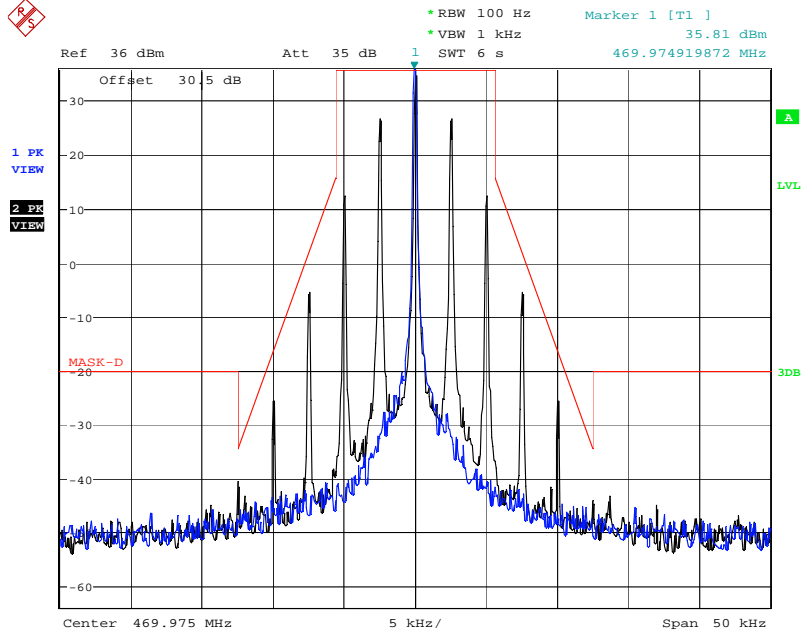

Date: 21.JUN.2018 09:53:08

5.8.6.4. Configuration: Mask D, 406.2MHz, 12.5 KHz, Analog, Low power

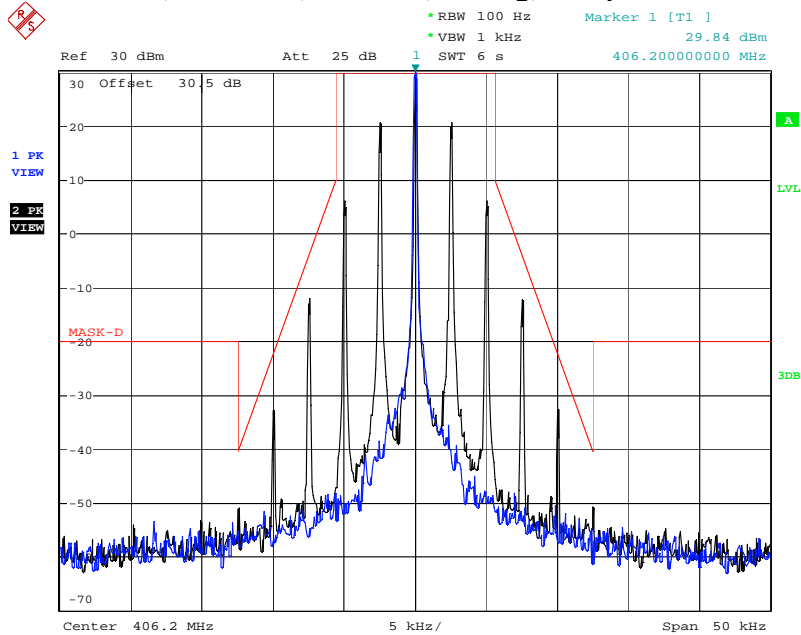

Date: 21.JUN.2018 09:56:30

ULTRATECH GROUP OF LABS

3000 Bristol Circle, Oakville, Ontario, Canada L6H 6G4
Tel. #: 905-829-1570, Fax. #: 905-829-8050, Email: vic@ultratech-labs.com, Website: <http://www.ultratech-labs.com>

File #: 18ICOM488_FCC90

July 4, 2018

All test results contained in this engineering test report are traceable to National Institute of Standards and Technology (NIST)

5.8.6.5. Configuration: Mask D, 450.1MHz, 12.5 KHz, Analog, Low power

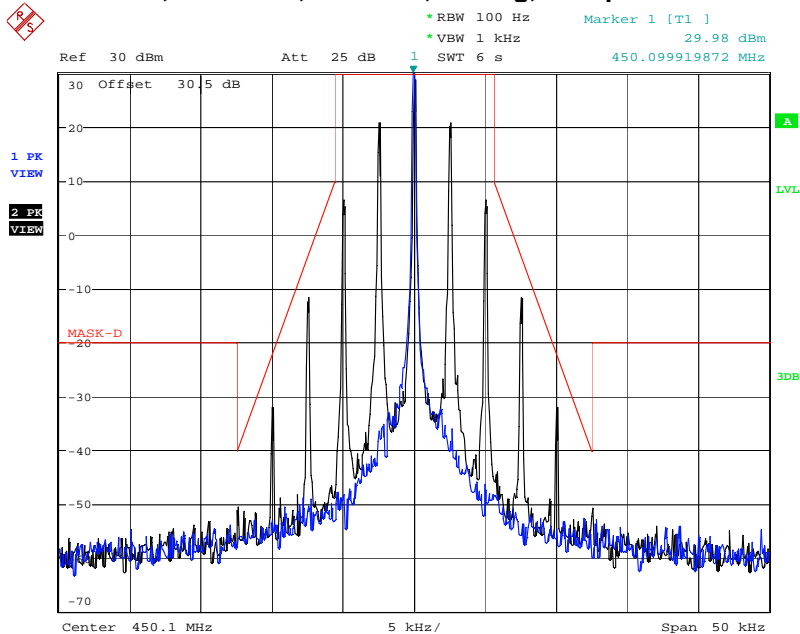

Date: 21.JUN.2018 09:59:10

5.8.6.6. Configuration: Mask D, 469.975MHz, 12.5 KHz, Analog, Low power

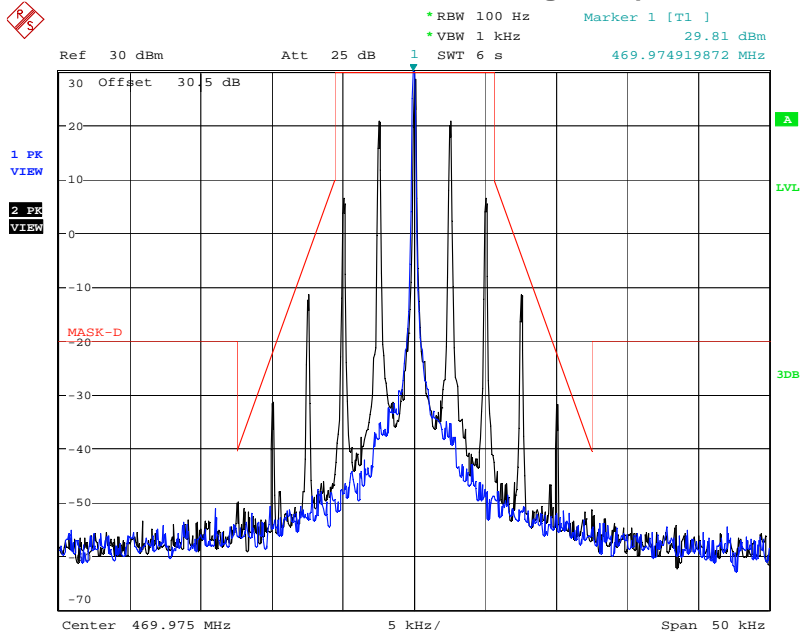

Date: 21.JUN.2018 10:02:04

ULTRATECH GROUP OF LABS

3000 Bristol Circle, Oakville, Ontario, Canada L6H 6G4
Tel. #: 905-829-1570, Fax. #: 905-829-8050, Email: vic@ultratech-labs.com, Website: <http://www.ultratech-labs.com>

File #: 18ICOM488_FCC90

July 4, 2018

All test results contained in this engineering test report are traceable to National Institute of Standards and Technology (NIST)

5.8.7. Test Data -MASK E

5.8.7.1. Configuration: Mask E, 406.2MHz, 6.25 KHz, Digital, High power

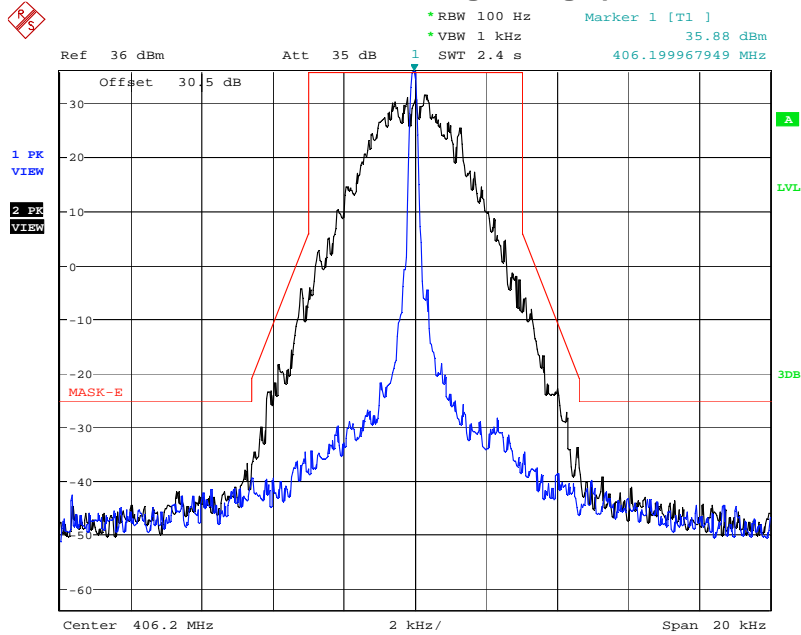

Date: 21.JUN.2018 10:36:30

5.8.7.2. Configuration: Mask E, 450.1MHz, 6.25 KHz, Digital, High power

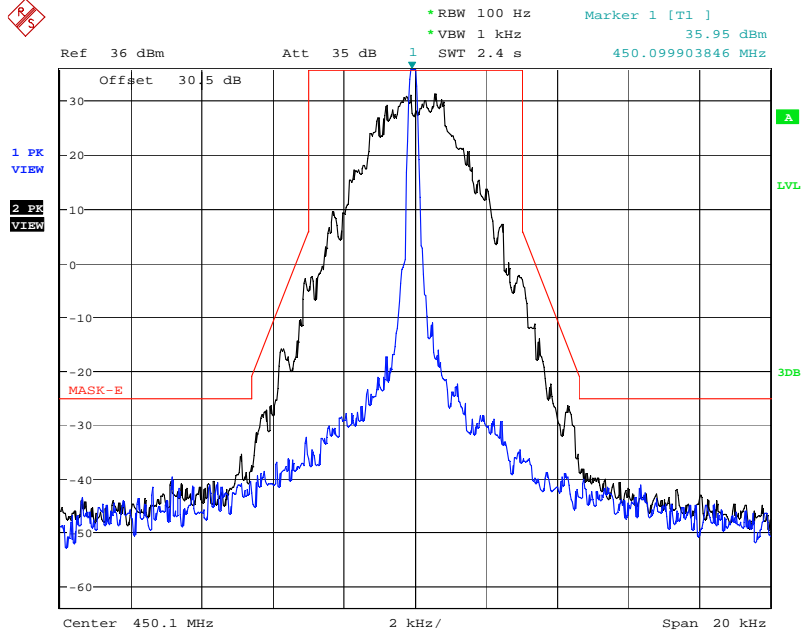

Date: 21.JUN.2018 10:39:59

5.8.7.3. Configuration: Mask E, 469.975MHz, 6.25 KHz, Digital, High power

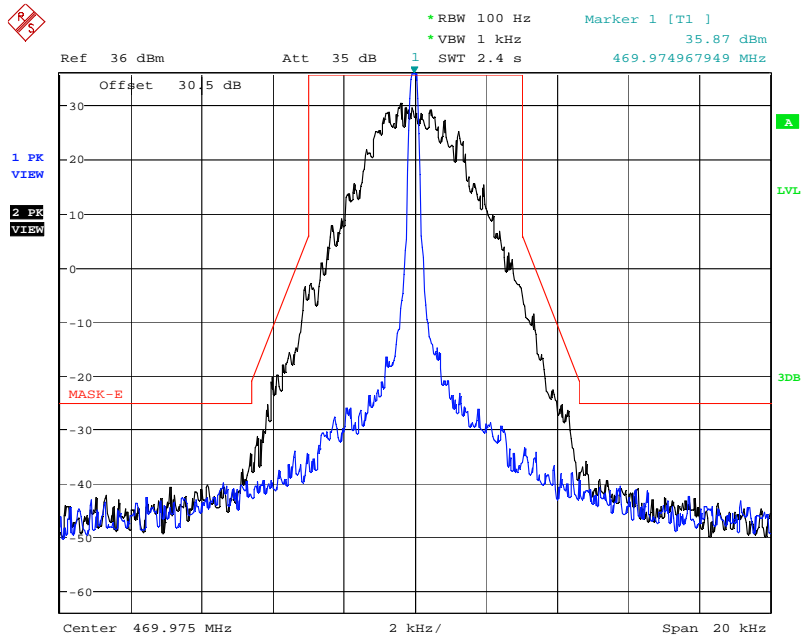

Date: 21.JUN.2018 10:42:34

5.8.7.4. Configuration: Mask E, 406.2MHz, 6.25 KHz, Digital, Low power

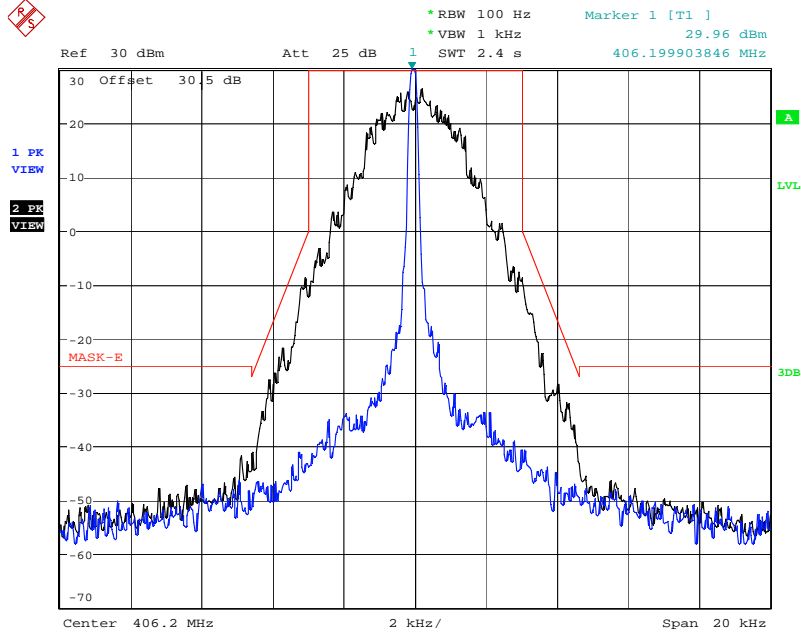

Date: 21.JUN.2018 10:57:24

ULTRATECH GROUP OF LABS

3000 Bristol Circle, Oakville, Ontario, Canada L6H 6G4
Tel. #: 905-829-1570, Fax. #: 905-829-8050, Email: vic@ultratech-labs.com, Website: <http://www.ultratech-labs.com>

File #: 18ICOM488_FCC90

July 4, 2018

All test results contained in this engineering test report are traceable to National Institute of Standards and Technology (NIST)

5.8.7.5. Configuration: Mask E, 450.1MHz, 6.25 KHz, Digital, Low power

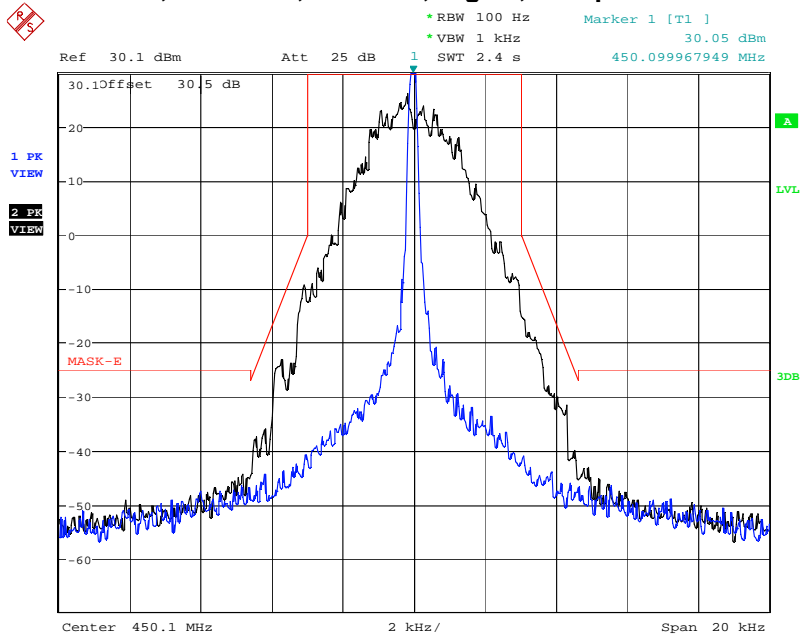

Date: 21.JUN.2018 11:00:53

5.8.7.6. Configuration: Mask E 469.975MHz, 6.25 KHz, Digital, Low power

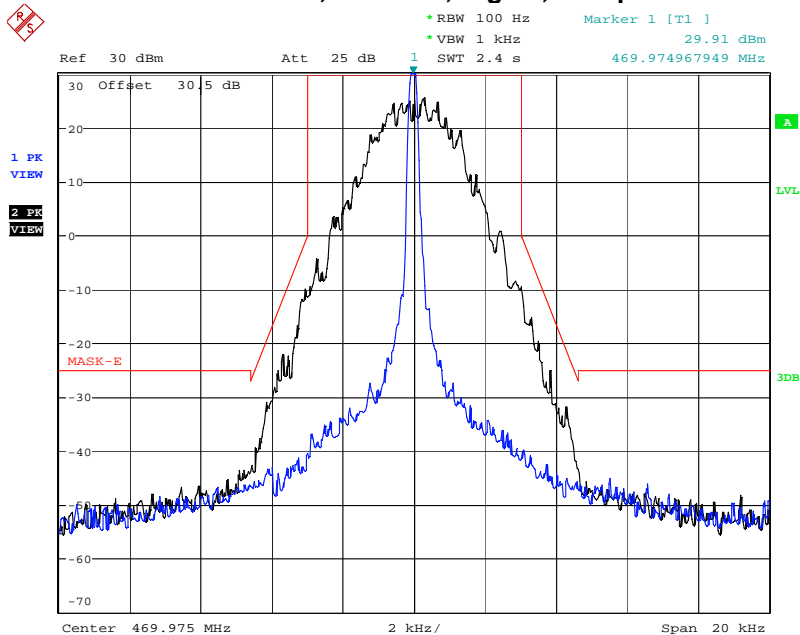

Date: 21.JUN.2018 11:04:26

ULTRATECH GROUP OF LABS

3000 Bristol Circle, Oakville, Ontario, Canada L6H 6G4
Tel. #: 905-829-1570, Fax. #: 905-829-8050, Email: vic@ultratech-labs.com, Website: <http://www.ultratech-labs.com>

File #: 18ICOM488_FCC90

July 4, 2018

All test results contained in this engineering test report are traceable to National Institute of Standards and Technology (NIST)

5.9. TRANSMITTER ANTENNA POWER SPURIOUS/HARMONIC CONDUCTED EMISSIONS [§ 2.1051, 2.1057, 22.359, 80.211(f)(3) & 90.210]

5.9.1. Limits

Emissions shall be attenuated below the mean output power of the transmitter as follows:

FCC Rules	Attenuation Limit (dBc)
§ 22.359	At least $43 + 10 \log (P)$ dB.
§ 80.211(f)(3),	At least $43 + 10 \log_{10}$ (mean power in watts) dB
§ 90.210(b)	At least $43 + 10 \log (P)$ dB
§ 90.210(d)	At least $50 + 10 \log (P)$ dB or 70 dB, whichever is the lesser attenuation.
§ 90.210(e)	At least $55 + 10 \log (P)$ or 65 dB, whichever is the lesser attenuation.

5.9.2. Method of Measurements

Refer to Section 8.5 of this report for measurement details

5.9.3. Test Arrangement

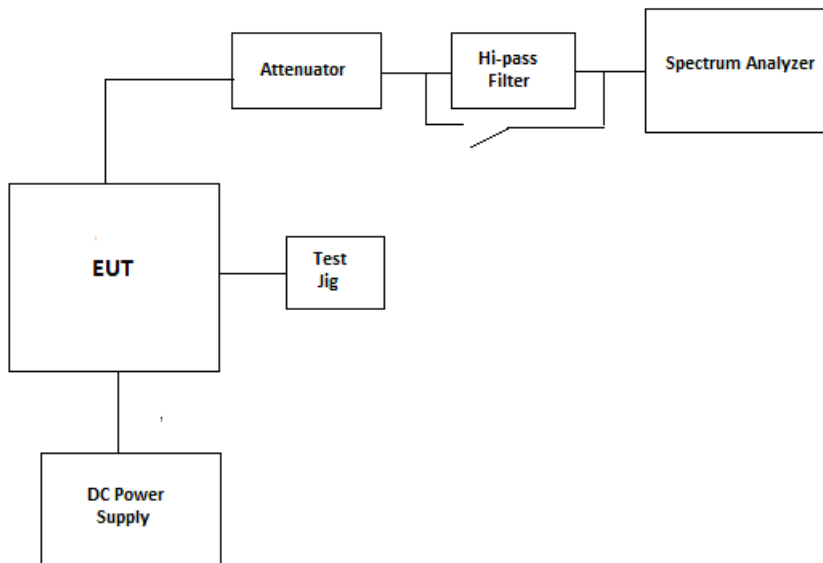

5.9.4. Test Data

Note: There was no difference in spurious/harmonic emissions on the pre-scans for different channel spacing and modulation types. Therefore, the RF spurious/harmonic emissions in this section would be performed for 6.25 KHz channel spacing digital modulation.

5.9.4.1. Configuration: Tx Conducted, 406.2MHz, 6.25 KHz, Digital, High power

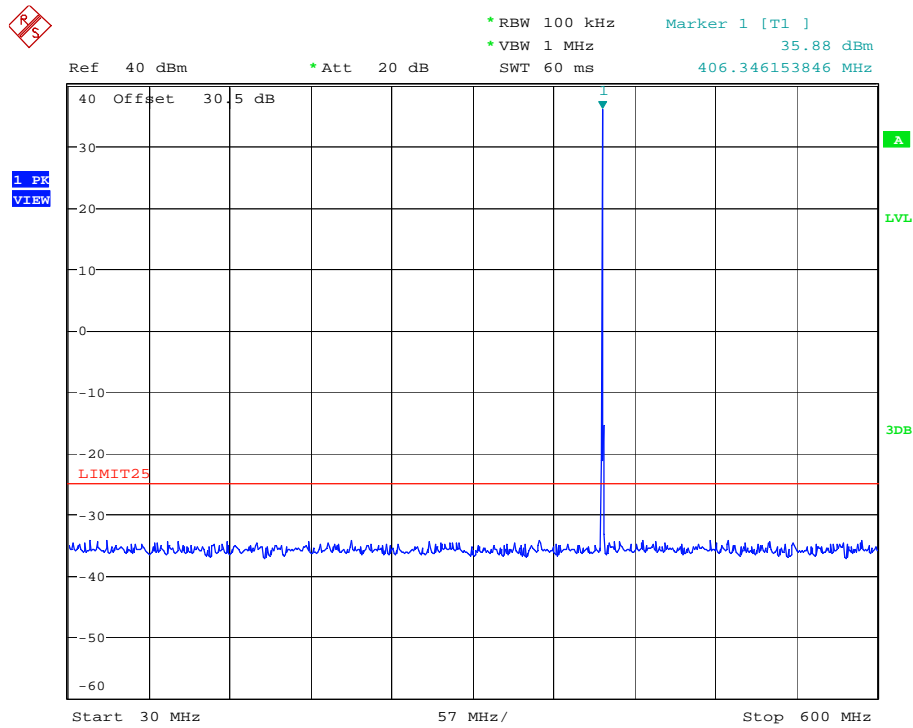

Date: 21.JUN.2018 13:44:24

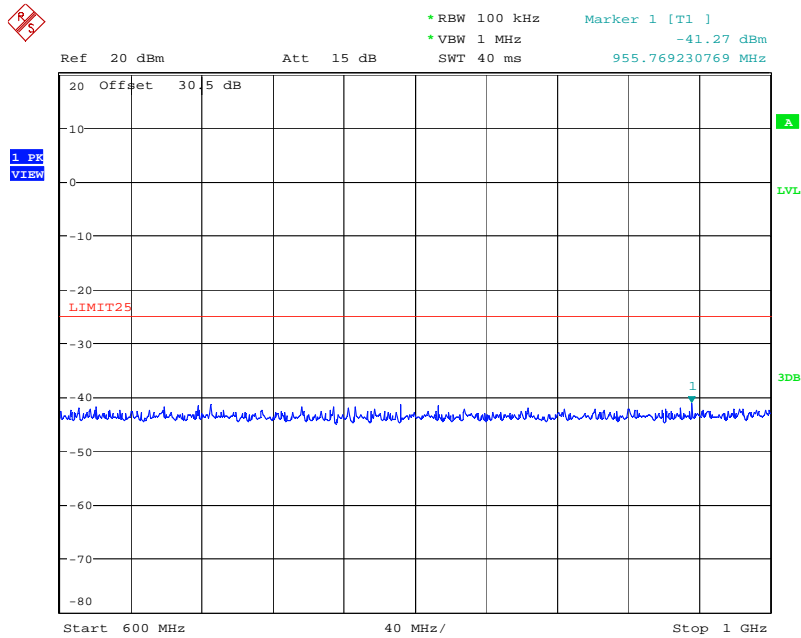

Date: 21.JUN.2018 14:25:49

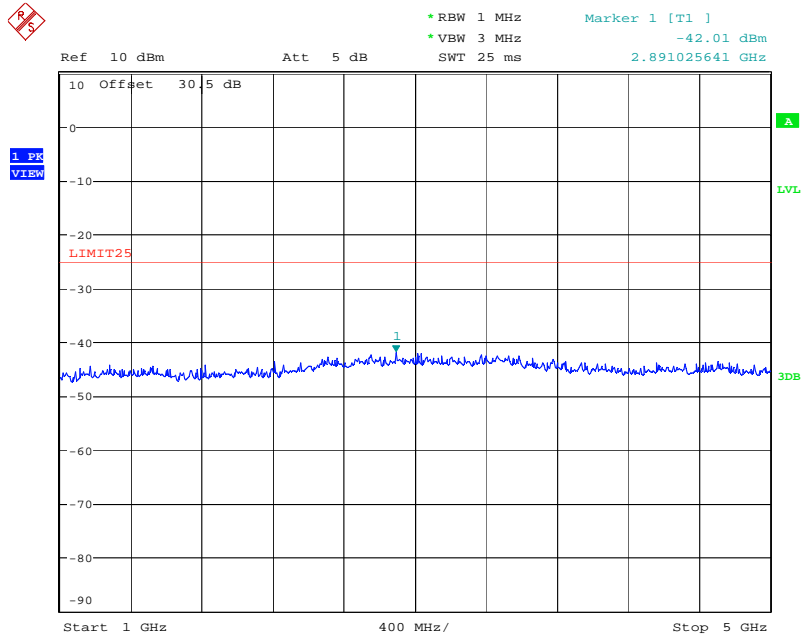

Date: 21.JUN.2018 14:34:24

ULTRATECH GROUP OF LABS

3000 Bristol Circle, Oakville, Ontario, Canada L6H 6G4
 Tel. #: 905-829-1570, Fax. #: 905-829-8050, Email: vic@ultratech-labs.com, Website: <http://www.ultratech-labs.com>

File #: 18ICOM488_FCC90

July 4, 2018

All test results contained in this engineering test report are traceable to National Institute of Standards and Technology (NIST)

5.9.4.2. Configuration: Tx Conducted, 450.1MHz, 6.25 KHz, Digital, High power

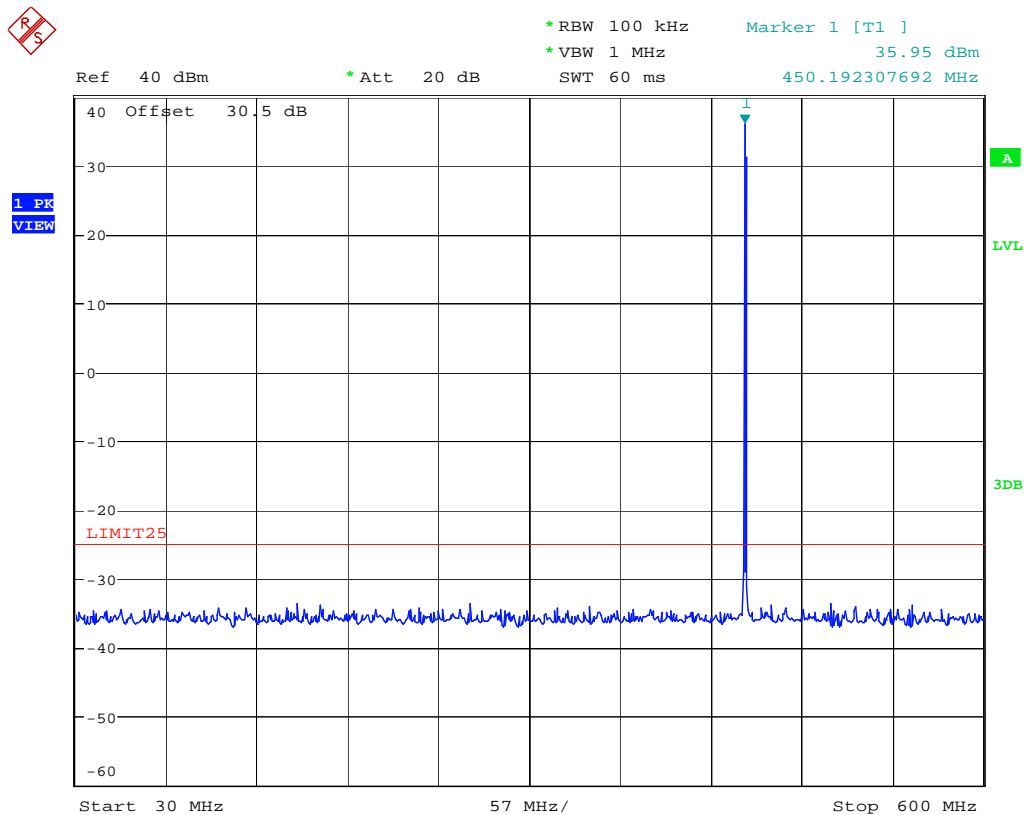

Date: 21.JUN.2018 13:45:23

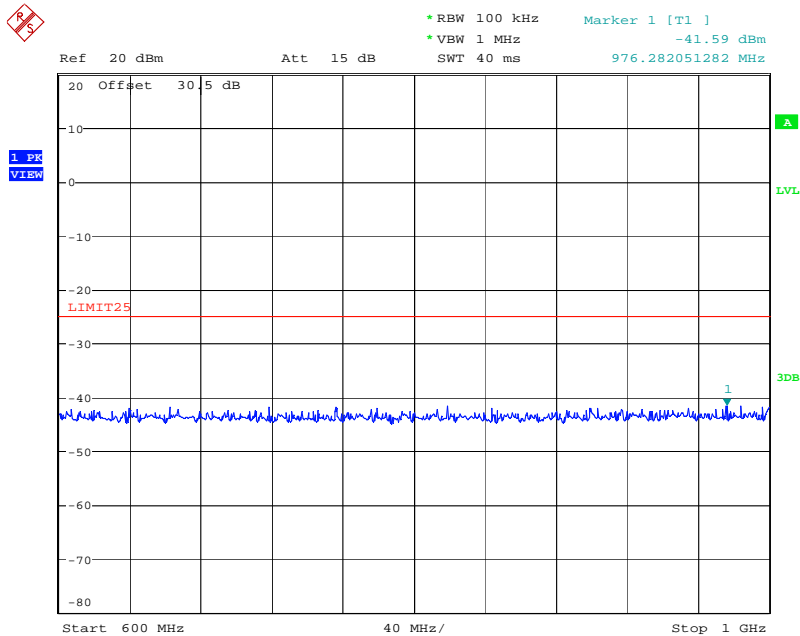

Date: 21.JUN.2018 14:27:03

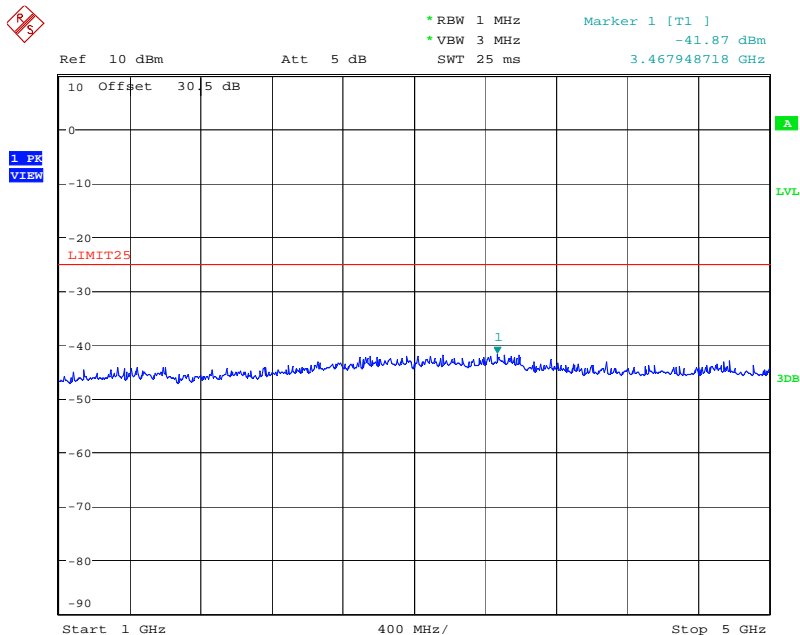

Date: 21.JUN.2018 14:36:30

ULTRATECH GROUP OF LABS

3000 Bristol Circle, Oakville, Ontario, Canada L6H 6G4
 Tel. #: 905-829-1570, Fax. #: 905-829-8050, Email: vic@ultratech-labs.com, Website: <http://www.ultratech-labs.com>

File #: 18ICOM488_FCC90

July 4, 2018

All test results contained in this engineering test report are traceable to National Institute of Standards and Technology (NIST)

5.9.4.3. Configuration: Tx Conducted, 469.975MHz, 6.25 KHz, Digital, High power

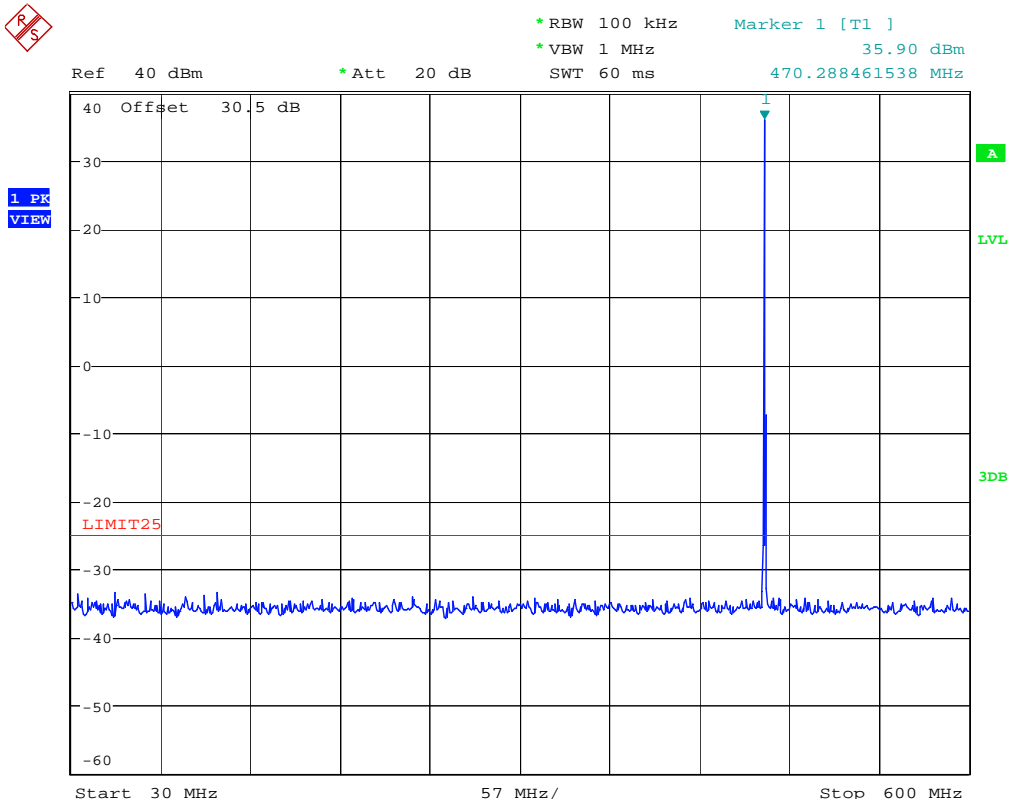

Date: 21.JUN.2018 13:46:17

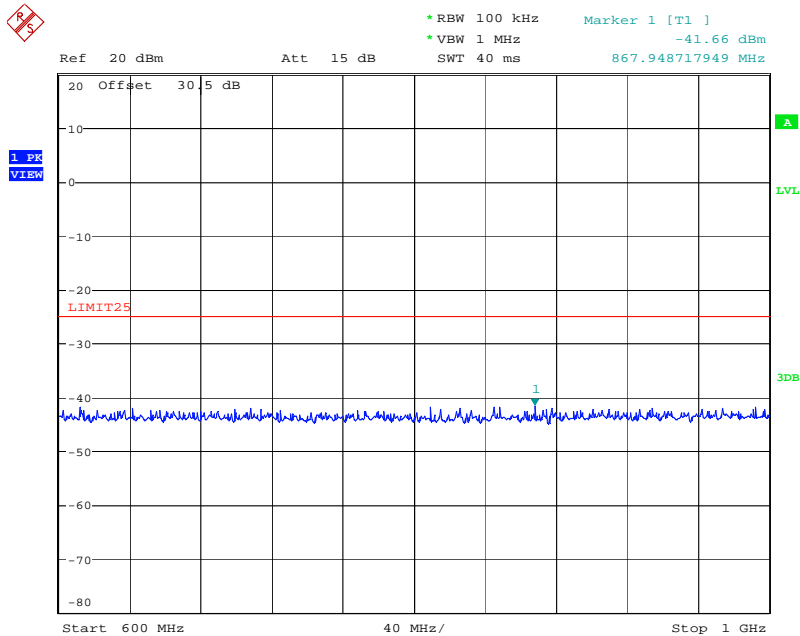

Date: 21.JUN.2018 14:28:03

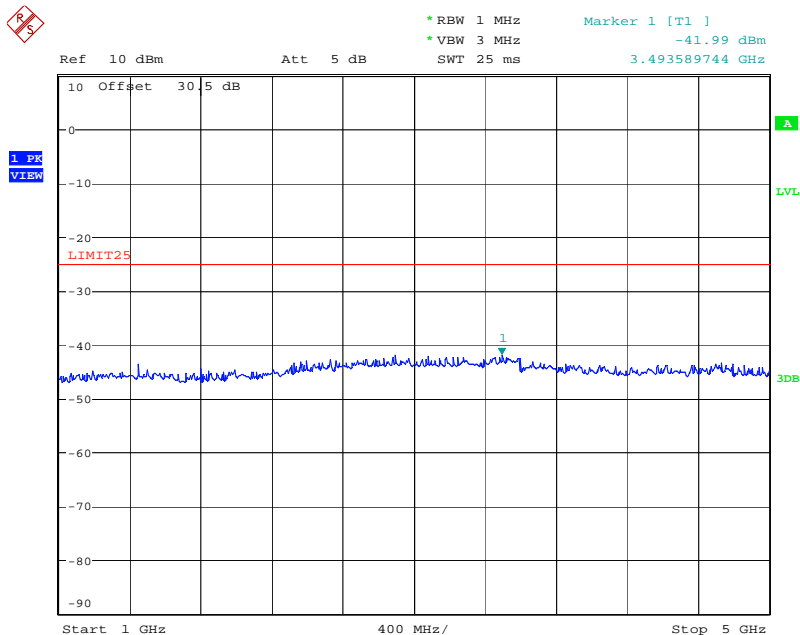

Date: 21.JUN.2018 14:39:02

ULTRATECH GROUP OF LABS

3000 Bristol Circle, Oakville, Ontario, Canada L6H 6G4
 Tel. #: 905-829-1570, Fax. #: 905-829-8050, Email: vic@ultratech-labs.com, Website: <http://www.ultratech-labs.com>

File #: 18ICOM488_FCC90

July 4, 2018

All test results contained in this engineering test report are traceable to National Institute of Standards and Technology (NIST)

5.9.4.4. Configuration: Tx Conducted, 406.2MHz, 6.25 KHz, Digital, Low power

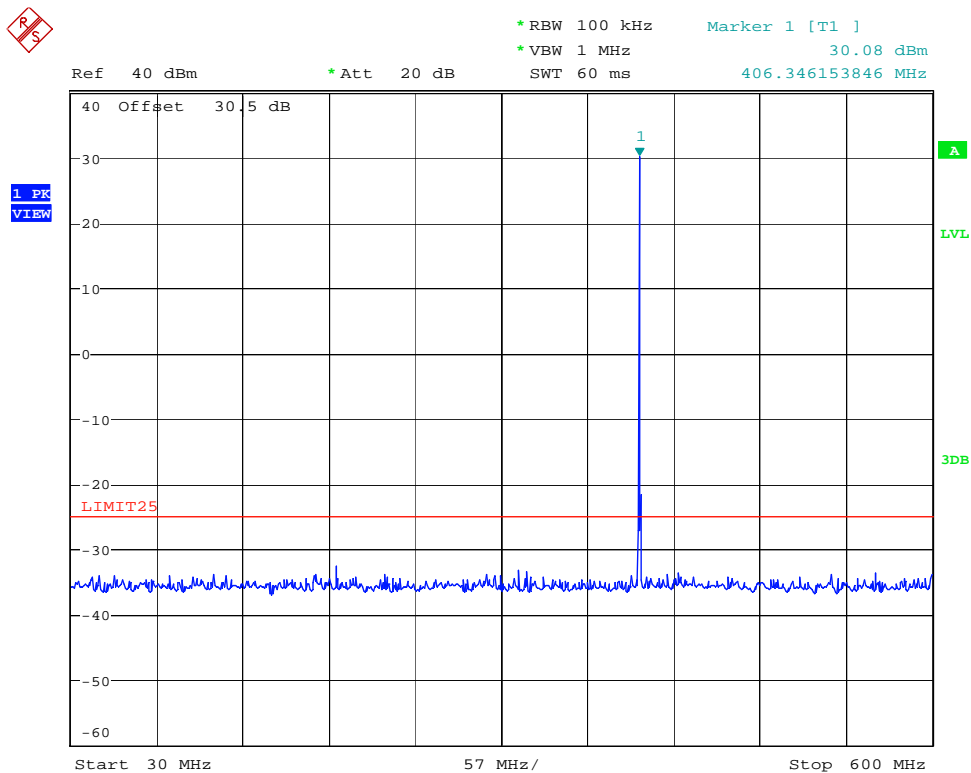

Date: 21.JUN.2018 13:47:28

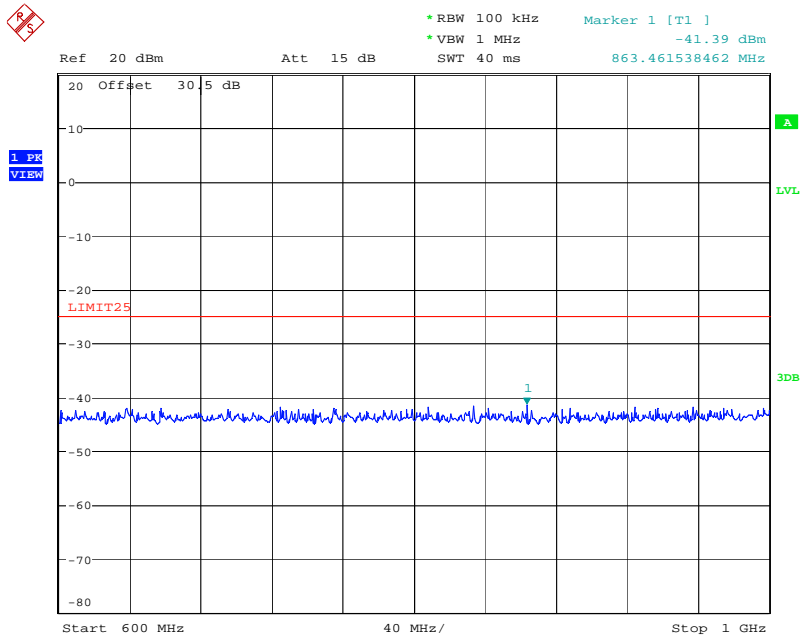

Date: 21.JUN.2018 14:29:14

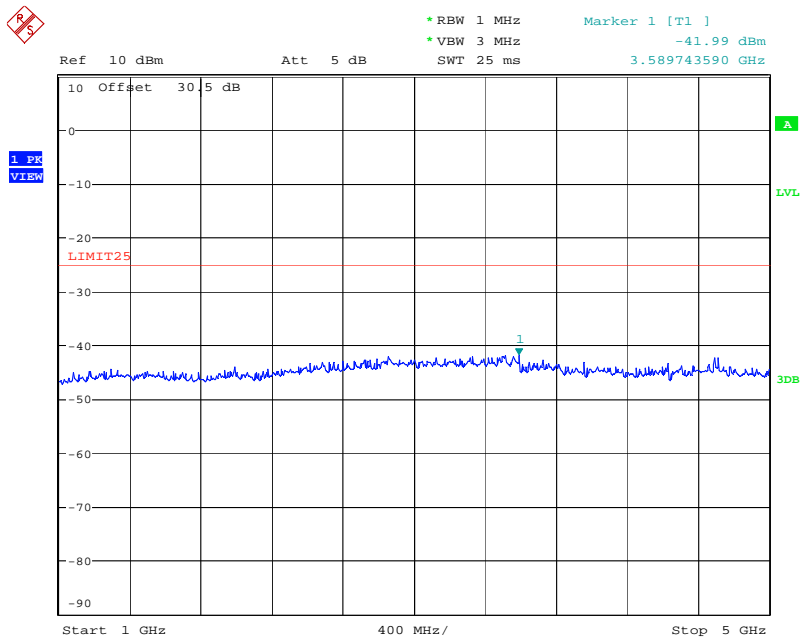

Date: 21.JUN.2018 14:35:29

ULTRATECH GROUP OF LABS

3000 Bristol Circle, Oakville, Ontario, Canada L6H 6G4
 Tel. #: 905-829-1570, Fax. #: 905-829-8050, Email: vic@ultratech-labs.com, Website: <http://www.ultratech-labs.com>

File #: 18ICOM488_FCC90

July 4, 2018

All test results contained in this engineering test report are traceable to National Institute of Standards and Technology (NIST)

5.9.4.5. Configuration: Tx Conducted, 450.1MHz, 6.25 KHz, Digital, Low power

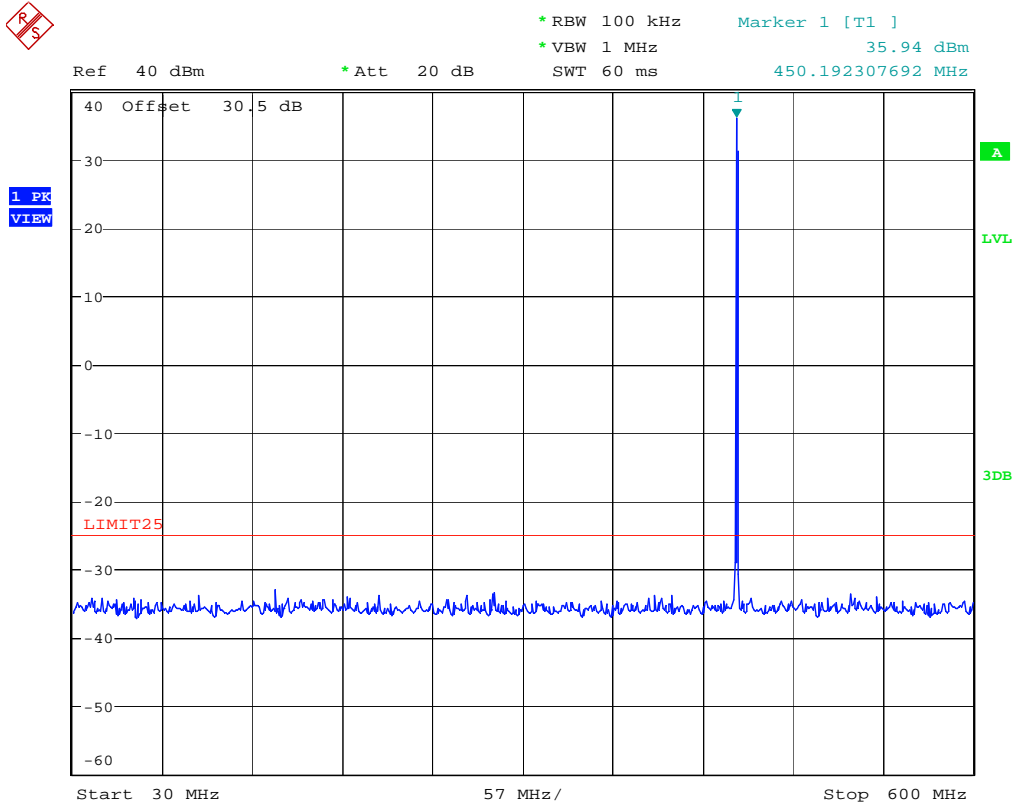

Date: 21.JUN.2018 13:48:17

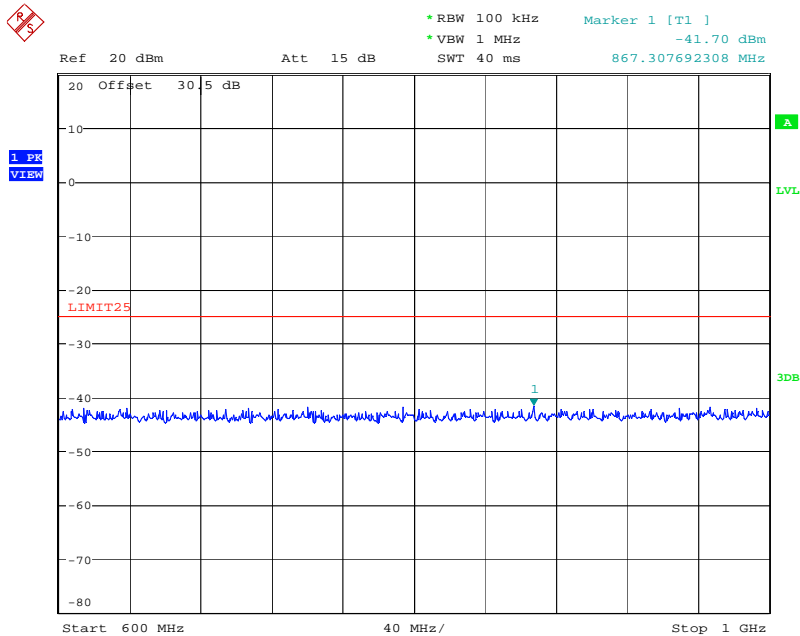

Date: 21.JUN.2018 14:31:29

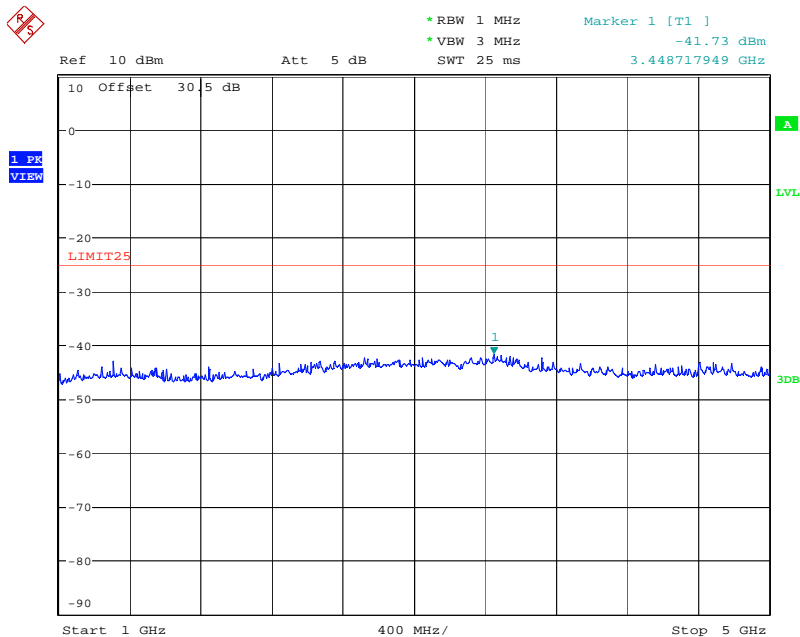

Date: 21.JUN.2018 14:37:41

5.9.4.6. Configuration: Tx Conducted, 469.975MHz, 6.25 KHz, Digital, Low power

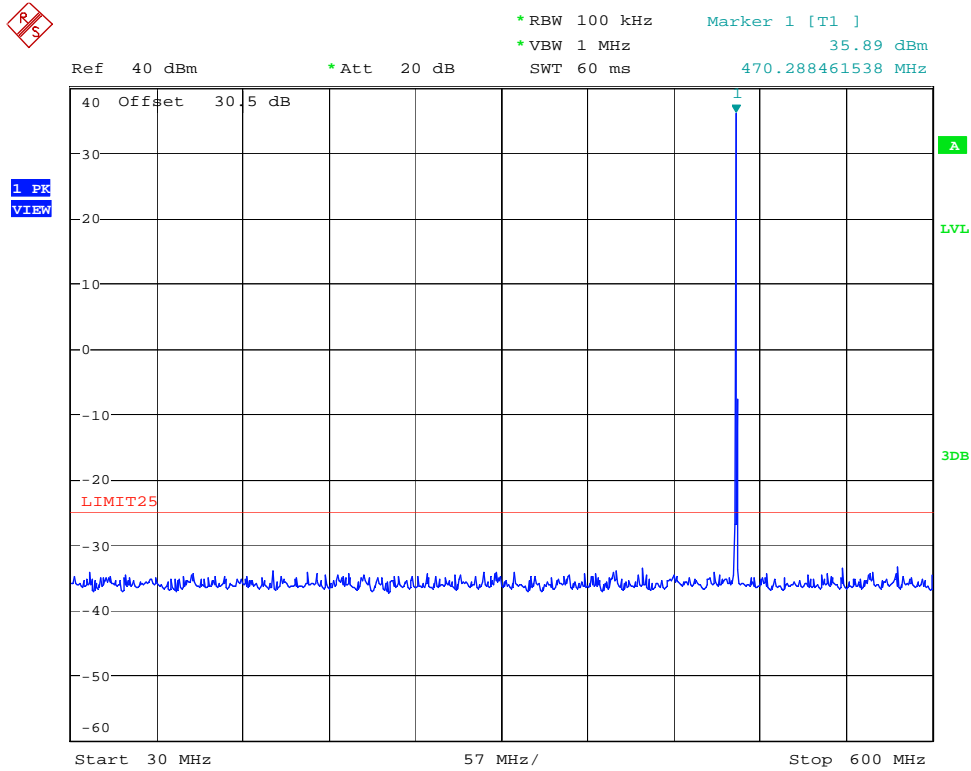

Date: 21.JUN.2018 13:50:12

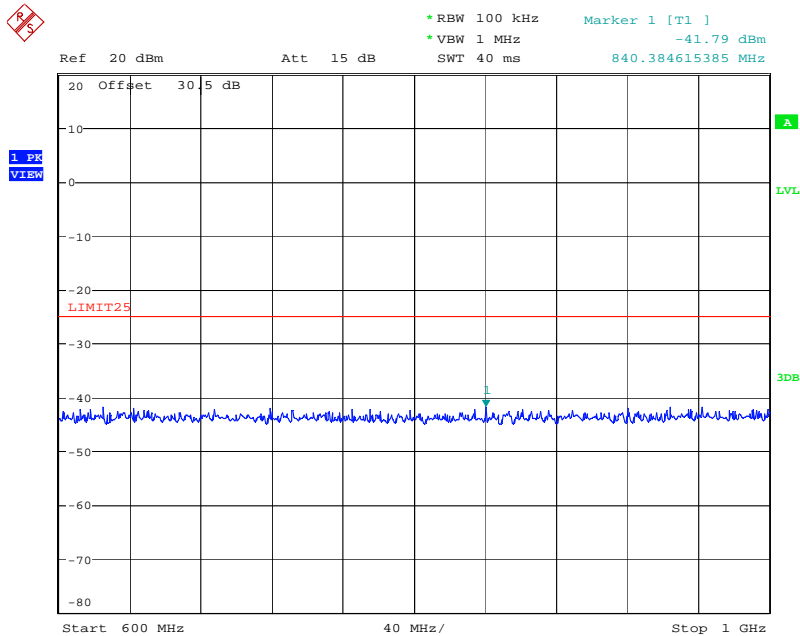

Date: 21.JUN.2018 14:32:21

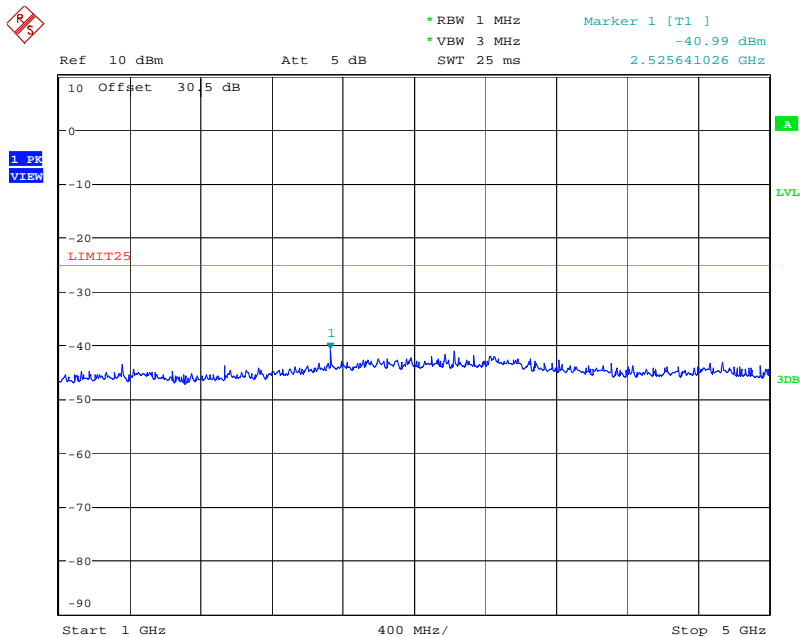

Date: 21.JUN.2018 14:40:34

ULTRATECH GROUP OF LABS

3000 Bristol Circle, Oakville, Ontario, Canada L6H 6G4
 Tel. #: 905-829-1570, Fax. #: 905-829-8050, Email: vic@ultratech-labs.com, Website: <http://www.ultratech-labs.com>

File #: 18ICOM488_FCC90

July 4, 2018

All test results contained in this engineering test report are traceable to National Institute of Standards and Technology (NIST)

5.10. TRANSMITTER SPURIOUS/HARMONIC RADIATED EMISSIONS [§§ 2.1053, 2.1057, 22.359, 80.211(f)(3) & 90.210]

5.10.1. Limits

Emissions shall be attenuated below the mean output power of the transmitter as follows:

FCC Rules	Attenuation Limit (dBc)
§ 22.359	At least 43 + 10 log (P) dB.
§ 80.211(f)(3),	At least 43 + 10log ₁₀ (mean power in watts) dB
§ 90.210(b)	At least 43 + 10 log (P) dB
§ 90.210(d)	At least 50 + 10 log (P) dB or 70 dB, whichever is the lesser attenuation.
§ 90.210(e)	At least 55 + 10 log (P) or 65 dB, whichever is the lesser attenuation.

5.10.2. Method of Measurements

The spurious/harmonic ERP measurements are using substitution method specified in Section 8.2 of this report.

5.10.3. Test Arrangement

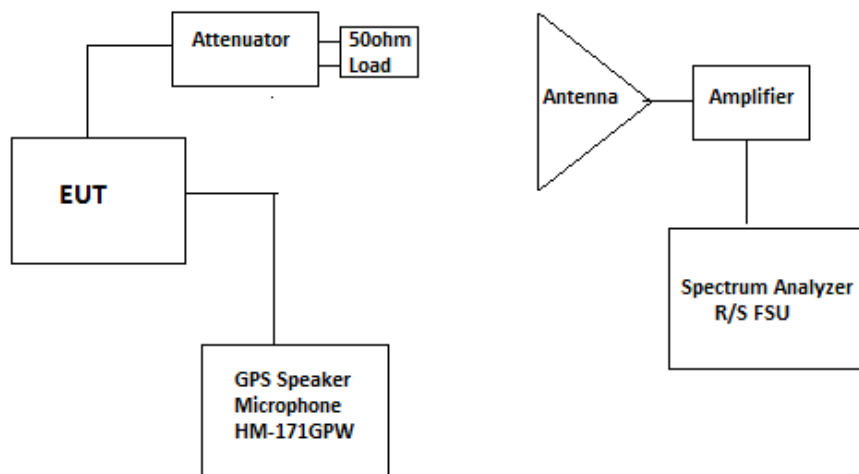

5.10.4. Test Data

Remarks:

- The RF spurious/harmonic emission characteristics for different channel spacing are indistinguishable. Therefore, the following radiated emissions were performed at 6.25 KHz channel spacing digital modulation, and the results were compared with the more stringent limit for the worst-case.
- The radiated emissions were performed with high power setting at 3 m distance to represents the worst-case test configuration.
- The emissions were scanned from 30 MHz to 10th harmonics; all spurious emissions that are in excess of 20dB below the specified limit shall be recorded.

5.10.4.1. Near Lowest Frequency (406.2 MHz)

Power_{conducted} (dBm):		36.15				
FREQ. RANGE SCANNED		30 MHz to 6 GHz				
Frequency (MHz)	E-Field (dB μ V/m)	EMI Detector (Peak/QP)	Antenna Polarization (H/V)	ERP Measured (dBm)	Limit (dBm)	Margin (dB)
1218.600	59.34	PEAK	V	-36.04	-25.00	-11.04
1218.600	55.22	PEAK	H	-38.65	-25.00	-13.65
1624.800	69.63	PEAK	V	-27.75	-25.00	-2.75
1624.800	56.07	PEAK	H	-40.96	-25.00	-15.96
2843.400	57.72	PEAK	V	-38.15	-25.00	-13.15
3655.800	55.86	PEAK	H	-42.15	-25.00	-17.15
4062.000	63.11	PEAK	H	-35.85	-25.00	-10.85
All other emissions are more than 20 dB below the limit line.						

5.10.4.2. Near Middle Frequency (450.1 MHz)

Power_{conducted} (dBm):		36.19				
FREQ. RANGE SCANNED		30 MHz to 6 GHz				
Frequency (MHz)	E-Field (dB μ V/m)	EMI Detector (Peak/QP)	Antenna Polarization (H/V)	ERP Measured (dBm)	Limit (dBm)	Margin (dB)
1350.300	61.32	PEAK	V	-34.05	-25.00	-9.05
1350.300	52.94	PEAK	H	-42.65	-25.00	-17.65
1800.400	56.23	PEAK	V	-41.68	-25.00	-16.68
1800.400	55.94	PEAK	H	-41.38	-25.00	-16.38
2250.500	57.61	PEAK	V	-40.95	-25.00	-15.95
2250.500	53.96	PEAK	H	-43.35	-25.00	-18.35
2700.600	59.3	PEAK	V	-37.65	-25.00	-12.65
2700.600	53.74	PEAK	H	-44.35	-25.00	-19.35
3600.800	53.00	PEAK	V	-44.75	-25.00	-19.75
3600.800	56.46	PEAK	H	-44.45	-25.00	-19.45
4050.900	59.36	PEAK	V	-38.15	-25.00	-13.15
4050.900	66.08	PEAK	H	-32.85	-25.00	-7.85
4501.000	65.71	PEAK	V	-32.65	-25.00	-7.65
4501.000	65.34	PEAK	H	-33.05	-25.00	-8.05
All other emissions are more than 20 dB below the limit line.						

ULTRATECH GROUP OF LABS

3000 Bristol Circle, Oakville, Ontario, Canada L6H 6G4
 Tel. #: 905-829-1570, Fax. #: 905-829-8050, Email: vic@ultratech-labs.com, Website: <http://www.ultratech-labs.com>

File #: 18ICOM488_FCC90

July 4, 2018

All test results contained in this engineering test report are traceable to National Institute of Standards and Technology (NIST)

5.10.4.3. Near Highest Frequency (469.975 MHz)

Power conducted (dBm):		36.14				
FREQ. RANGE SCANNED		30 MHz to 6 GHz				
Frequency (MHz)	E-Field (dBμV/m)	EMI Detector (Peak/QP)	Antenna Polarization (H/V)	ERP Measured (dBm)	Limit (dBm)	Margin (dB)
1409.925	61.53	PEAK	V	-34.39	-25.00	-9.39
1409.925	55.65	PEAK	H	-39.69	-25.00	-14.69
1879.900	53.45	PEAK	V	-46.73	-25.00	-21.73
2349.875	57.50	PEAK	V	-39.85	-25.00	-14.85
2349.875	57.86	PEAK	H	-40.75	-25.00	-15.75
2819.850	59.41	PEAK	V	-37.15	-25.00	-12.15
2819.850	54.90	PEAK	H	-42.95	-25.00	-17.95
3289.825	51.57	PEAK	V	-48.55	-25.00	-23.55
3289.825	53.44	PEAK	H	-45.05	-25.00	-20.05
3759.800	55.62	PEAK	V	-43.35	-25.00	-18.35
3759.800	59.92	PEAK	H	-40.25	-25.00	-15.25
4229.775	59.18	PEAK	V	-39.85	-25.00	-14.85
4229.775	65.94	PEAK	H	-34.25	-25.00	-9.25
4699.750	62.09	PEAK	V	-36.05	-25.00	-11.05
4699.750	64.89	PEAK	H	-33.75	-25.00	-8.75
All other emissions are more than 20 dB below the limit line.						

ULTRATECH GROUP OF LABS

3000 Bristol Circle, Oakville, Ontario, Canada L6H 6G4
 Tel. #: 905-829-1570, Fax. #: 905-829-8050, Email: vic@ultratech-labs.com, Website: <http://www.ultratech-labs.com>

File #: 18ICOM488_FCC90

July 4, 2018

All test results contained in this engineering test report are traceable to National Institute of Standards and Technology (NIST)

5.11. FREQUENCY STABILITY [§§ 2.1055, 22.355, 74.464, 80.209 & 90.213]

5.11.1. Limits

§ 90.213 Transmitters used must have minimum frequency stability as specified in the following table.

Frequency Range (MHz)	Channel Bandwidth (KHz)	Frequency Tolerance (ppm)		
		Fixed and Base Stations	Mobile Stations	
			> 2 W	≤ 2 W
150-174 MHz	6.25	1.0	2.0	2.0
	12.5	2.5	5.0	5.0
	25	5.0	5.0	50.0*
421-512 MHz	6.25	0.5	1.0	1.0
	12.5	1.5	2.5	2.5
	25	2.5	5.0	5.0

- Stations operating in the 154.45 to 154.49 MHz or the 173.2 to 173.4 MHz bands must have a frequency stability of 5 ppm.
- Paging transmitters operating on paging-only frequencies must operate with frequency stability of 5 ppm in the 150-174 MHz band and 2.5 ppm in the 421-512 MHz band.

§ 22.355 Transmitters used must have minimum frequency stability as specified in the following table.

TABLE C-1—FREQUENCY TOLERANCE FOR TRANSMITTERS IN THE PUBLIC MOBILE SERVICES

Frequency range (MHz)	Base, fixed (ppm)	Mobile ≤3 watts (ppm)	Mobile ≤3 watts (ppm)
25 to 50	20.0	20.0	50.0
50 to 450	5.0	5.0	50.0
450 to 512	2.5	5.0	5.0
821 to 896	1.5	2.5	2.5
928 to 929	5.0	n/a	n/a
929 to 960	1.5	n/a	n/a
2110 to 2220	10.0	n/a	n/a

§ 74.464 - For operations on frequencies above 25 MHz using authorized bandwidths up to 30 kHz, the licensee of a remote pickup broadcast station or system shall maintain the operating frequency of each station in compliance with the frequency tolerance requirements of §90.213 of this chapter. For all other operations, the licensee of a remote pickup broadcast station or system shall maintain the operating frequency of each station in accordance with the following:

Frequency range	Tolerance (percent)	
	Base station	Mobile station
25 to 30 MHz:		
3 W or less002	.005
Over 3 W002	.002
30 to 300 MHz:		
3 W or less0005	.005
Over 3 W0005	.0005
300 to 500 MHz, all powers00025	.0005

5.11.2. Method of Measurements

Refer to Section 8.3 of this report for measurement details

5.11.3. Test Arrangement

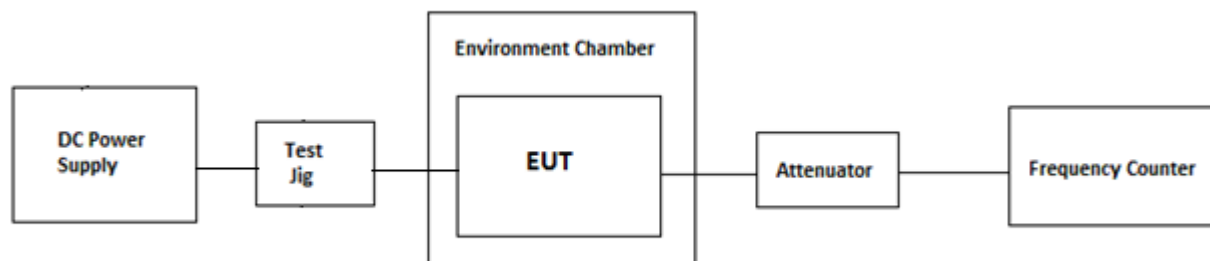

5.11.4. Test Data

Test Frequency:	406.2 MHz		
Full Power Level:	4.12 W		
Frequency Tolerance Limit:	± 1.0 ppm or ± 406 Hz		
Max. Frequency Tolerance Measured:	-185 Hz or - 0.46 ppm		
Input Voltage Rating:	7.5 VDC (nominal)		
Ambient Temperature (°C)	Frequency Drift (Hz)		
	Supply Voltage (Nominal) 7.5 VDC	Supply Voltage (Battery End Point) 5.6 VDC	Supply Voltage (Battery Fully Charged) 8.62 VDC
-30	-185	--	--
-20	-165	--	--
-10	-85	--	--
0	-42	--	--
10	-45	--	--
20	-27	-27	-45
30	39	--	--
40	40	--	--
50	78	--	--
60	116	--	--

5.12. TRANSIENT FREQUENCY BEHAVIOR [§ 90.214 & 74.462(c)]

5.12.1. Limits

Transient frequencies must be within the maximum frequency difference limits during the time intervals indicated:

Time intervals ^{1, 2}	Maximum frequency difference ³	All equipment	
		150 to 174 MHz	421 to 512MHz
Transient Frequency Behavior for Equipment Designed to Operate on 25 KHz Channels			
t ₁ ⁴	± 25.0 KHz	5.0 ms	10.0 ms
t ₂	± 12.5 KHz	20.0 ms	25.0 ms
t ₃ ⁴	± 25.0 KHz	5.0 ms	10.0 ms
Transient Frequency Behavior for Equipment Designed to Operate on 12.5 KHz Channels			
t ₁ ⁴	± 12.5 KHz	5.0 ms	10.0 ms
t ₂	± 6.25 KHz	20.0 ms	25.0 ms
t ₃ ⁴	± 12.5 KHz	5.0 ms	10.0 ms
Transient Frequency Behavior for Equipment Designed to Operate on 6.25 KHz Channels			
t ₁ ⁴	±6.25 KHz	5.0 ms	10.0 ms
t ₂	±3.125 KHz	20.0 ms	25.0 ms
t ₃ ⁴	±6.25 KHz	5.0 ms	10.0 ms

- t_{on} is the instant when a 1 kHz test signal is completely suppressed, including any capture time due to phasing.
 t₁ is the time period immediately following t_{on}.
 t₂ is the time period immediately following t₁.
 t₃ is the time period from the instant when the transmitter is turned off until t_{off}.
 t_{off} is the instant when the 1 kHz test signal starts to rise.
- During the time from the end of t₂ to the beginning of t₃, the frequency difference must not exceed the limits specified in § 90.213.
- Difference between the actual transmitter frequency and the assigned transmitter frequency.
- If the transmitter carrier output power rating is 6 Watts or less, the frequency difference during this time period may exceed the maximum frequency difference for this time period.

5.12.2. Method of Measurements

Refer to Section 8.6 of this test report and ANSI/TIA/EIA-603-E, Section 2.

5.12.3. Test Arrangement

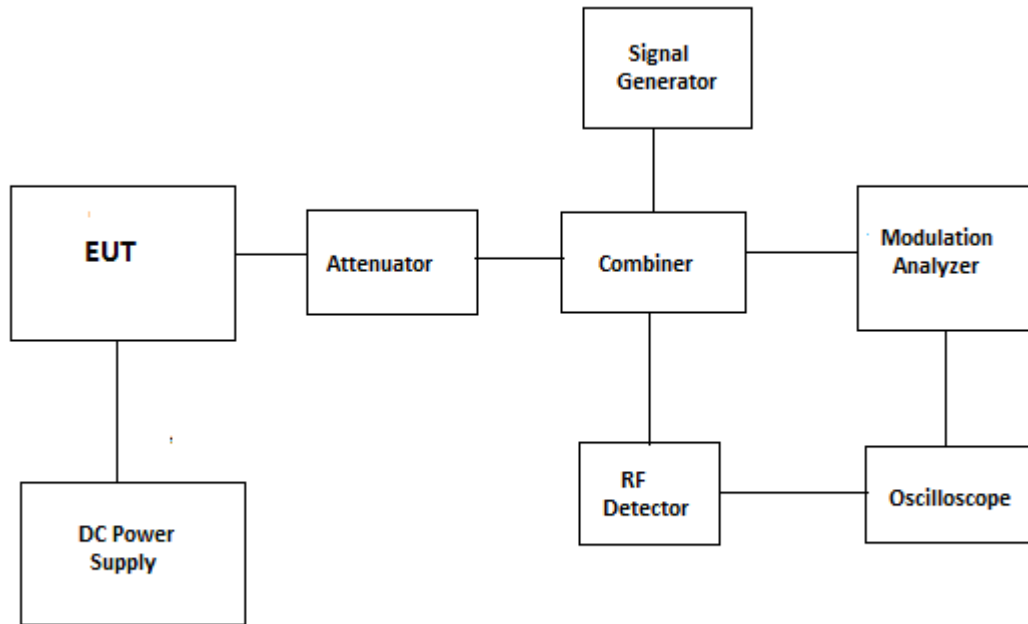

5.12.4. Test Data

Plot 5.12.4.1. Transient Frequency Behavior for 12.5 kHz Channel Spacing

Test Frequency:	406.2 MHz
Channel Spacing:	12.5 kHz
Power:	High
Test Conditions:	Switch on condition t_{on} , t_1 , and t_2

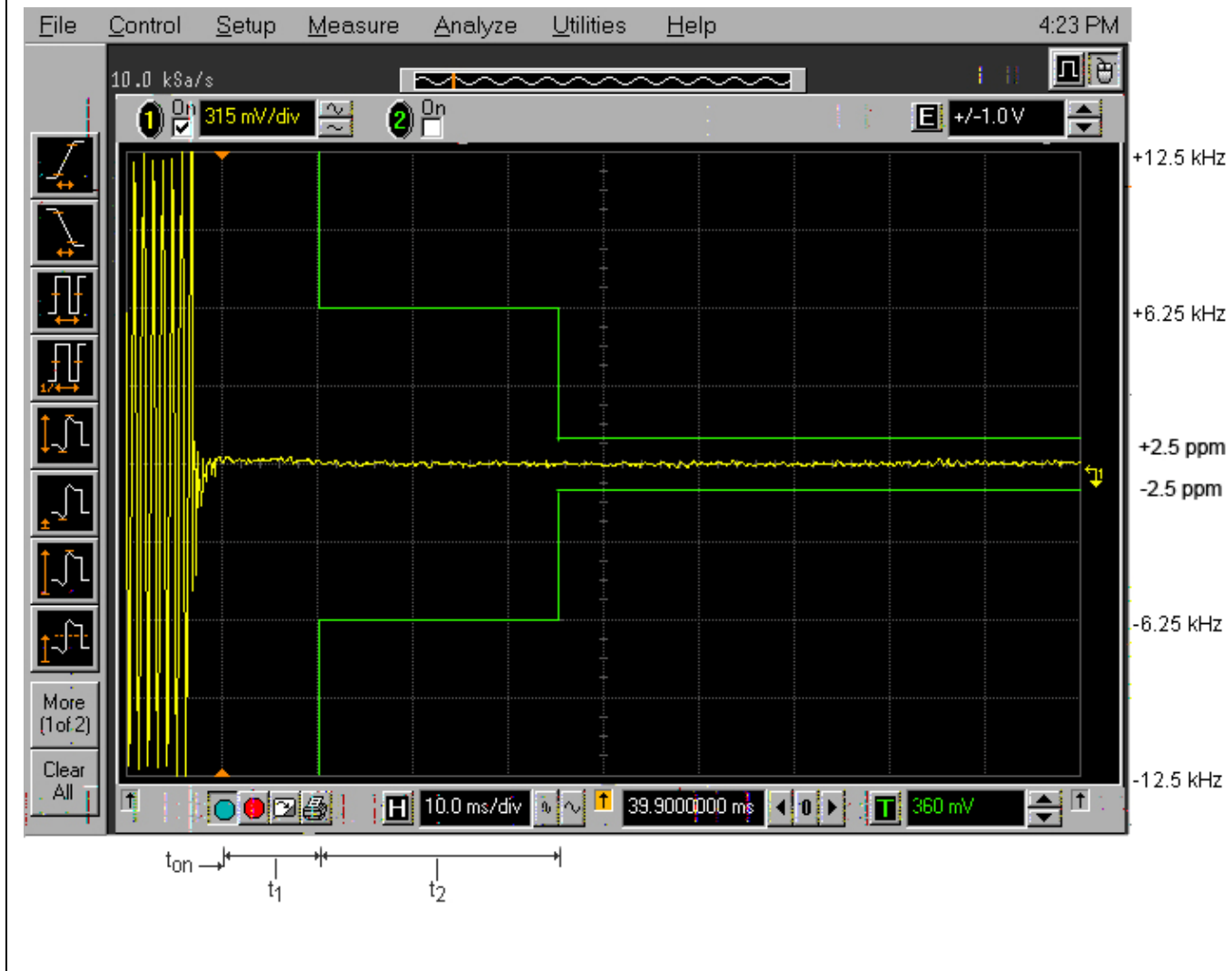

Plot 5.12.4.2. Transient Frequency Behavior for 12.5 kHz Channel Spacing

Test Frequency:	406.2 MHz
Channel Spacing:	12.5 kHz
Power:	High
Test Conditions:	Switch off condition t_3 , t_{off}

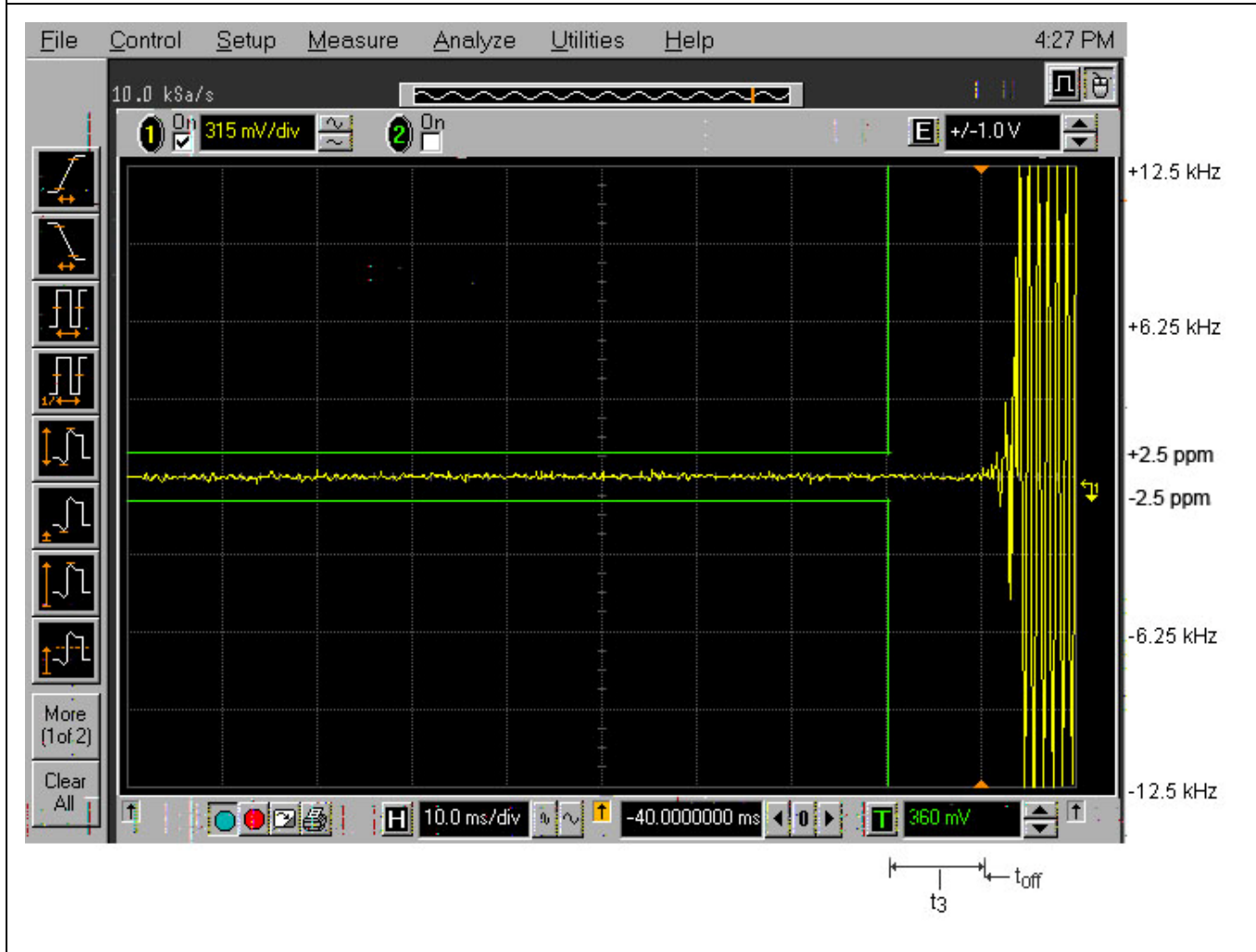

ULTRATECH GROUP OF LABS

3000 Bristol Circle, Oakville, Ontario, Canada L6H 6G4
 Tel. #: 905-829-1570, Fax. #: 905-829-8050, Email: vic@ultratech-labs.com, Website: <http://www.ultratech-labs.com>

File #: 18ICOM488_FCC90

July 4, 2018

All test results contained in this engineering test report are traceable to National Institute of Standards and Technology (NIST)

Plot 5.12.4.3. Transient Frequency Behavior for 25 kHz Channel Spacing

Test Frequency:	406.2 MHz
Channel Spacing:	25 kHz
Power:	High
Test Conditions:	Switch on condition t_{on} , t_1 , and t_2

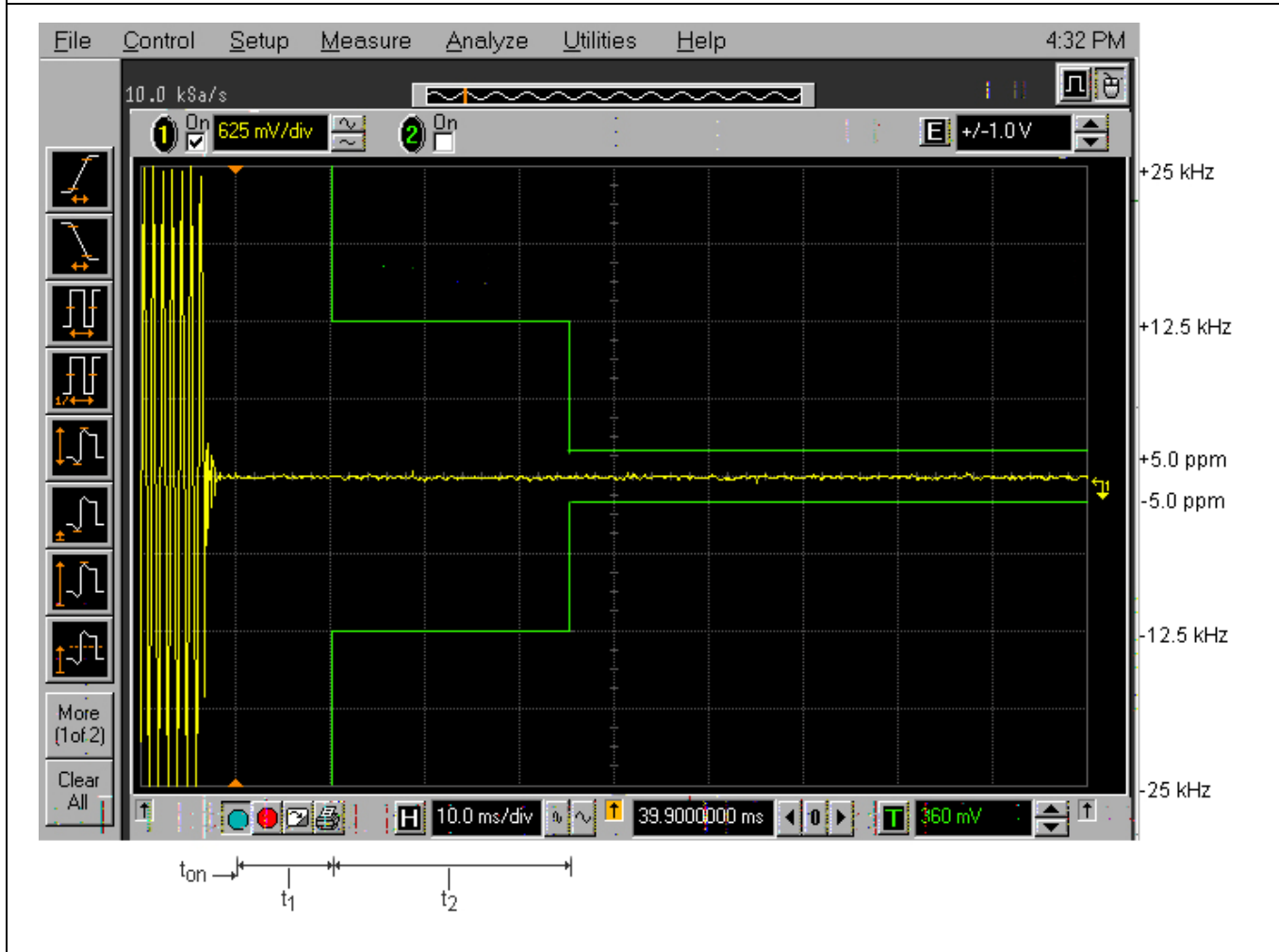

Plot 5.12.4.4. Transient Frequency Behavior for 25 kHz Channel Spacing

Test Frequency:	406.2 MHz
Channel Spacing:	25 kHz
Power:	High
Test Conditions:	Switch off condition t_3 , t_{off}

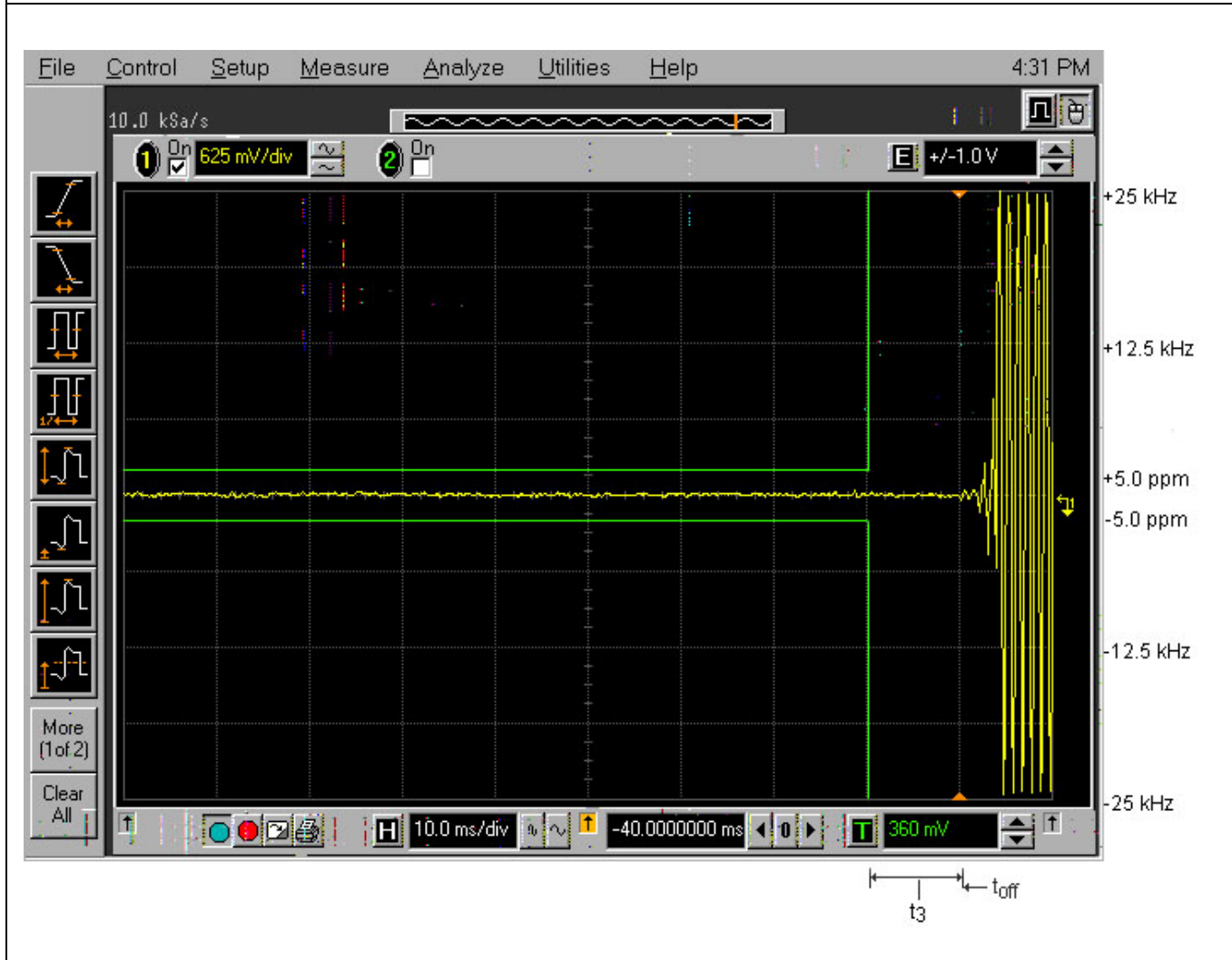

ULTRATECH GROUP OF LABS

3000 Bristol Circle, Oakville, Ontario, Canada L6H 6G4
 Tel. #: 905-829-1570, Fax. #: 905-829-8050, Email: vic@ultratech-labs.com, Website: <http://www.ultratech-labs.com>

File #: 18ICOM488_FCC90

July 4, 2018

All test results contained in this engineering test report are traceable to National Institute of Standards and Technology (NIST)

Plot 5.12.4.5. Transient Frequency Behavior for 6.25 kHz Channel Spacing

Test Frequency:	406.2 MHz
Channel Spacing:	6.25 kHz
Power:	High
Test Conditions:	Switch on condition t_{on} , t_1 , and t_2

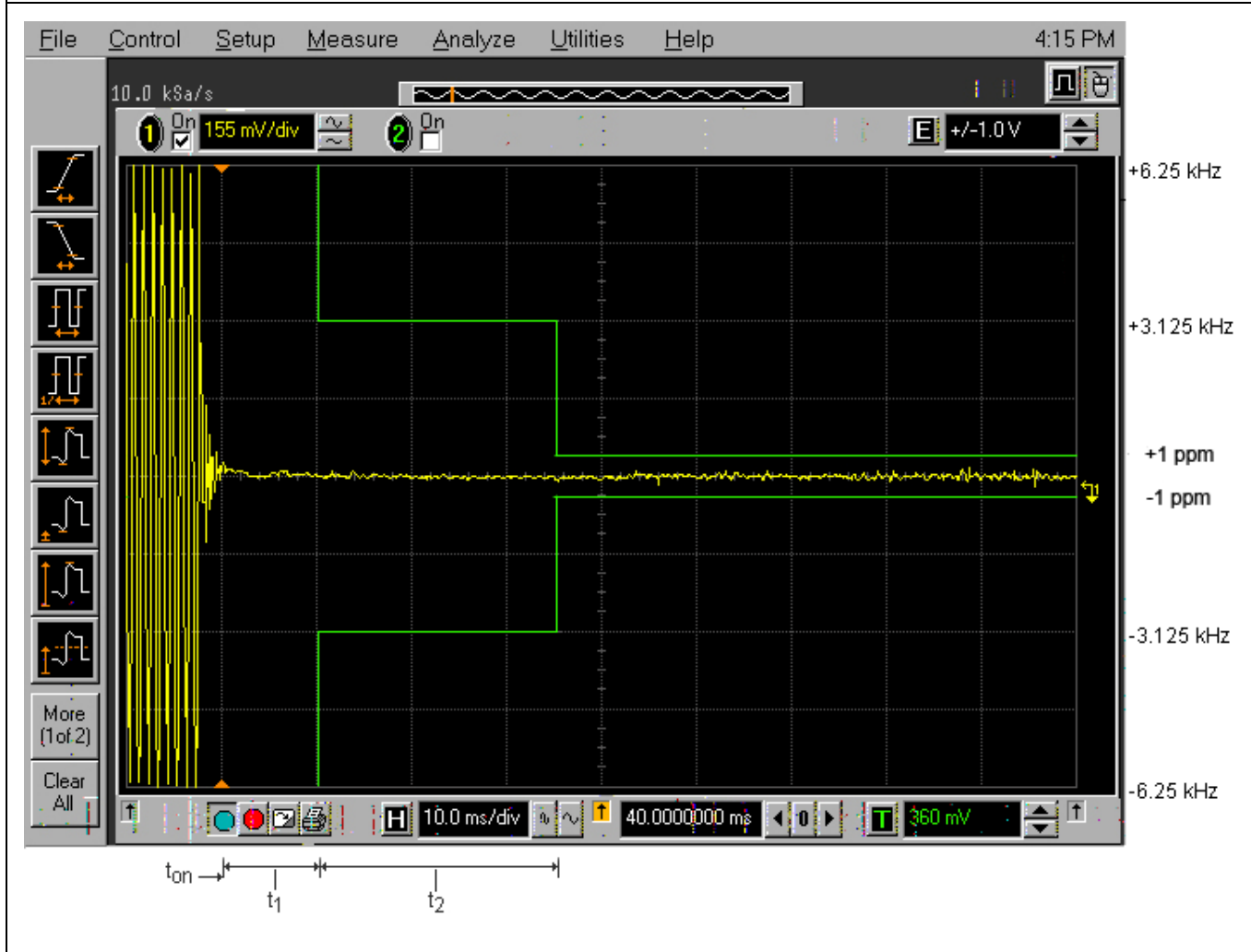

ULTRATECH GROUP OF LABS

3000 Bristol Circle, Oakville, Ontario, Canada L6H 6G4
 Tel. #: 905-829-1570, Fax. #: 905-829-8050, Email: vic@ultratech-labs.com, Website: <http://www.ultratech-labs.com>

File #: 18ICOM488_FCC90

July 4, 2018

All test results contained in this engineering test report are traceable to National Institute of Standards and Technology (NIST)

Plot 5.12.4.6. Transient Frequency Behavior for 6.25 kHz Channel Spacing

Test Frequency:	406.2 MHz
Channel Spacing:	6.25 kHz
Power:	High
Test Conditions:	Switch off condition t_3 , t_{off}

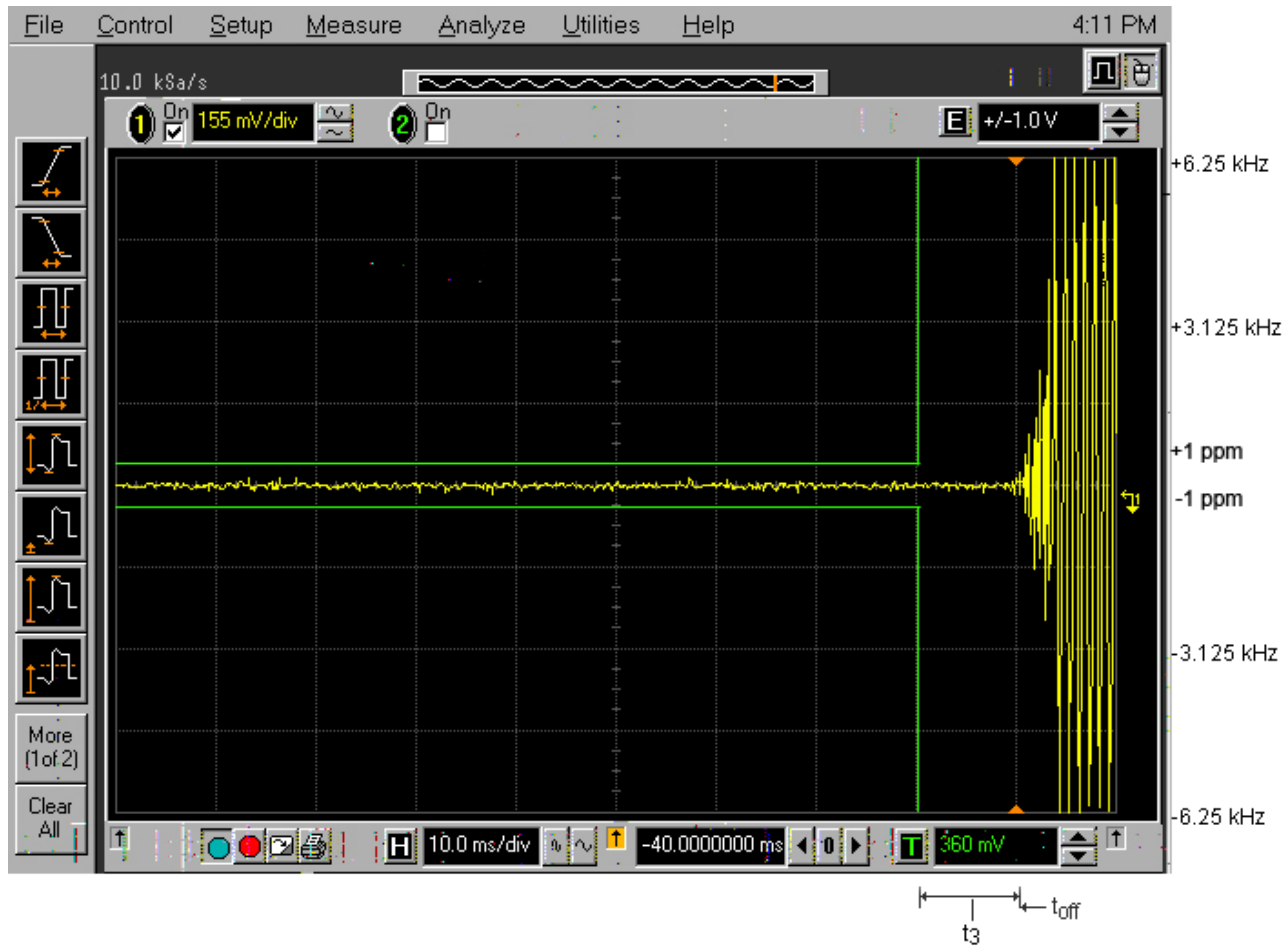

ULTRATECH GROUP OF LABS

3000 Bristol Circle, Oakville, Ontario, Canada L6H 6G4
 Tel. #: 905-829-1570, Fax. #: 905-829-8050, Email: vic@ultratech-labs.com, Website: <http://www.ultratech-labs.com>

File #: 18ICOM488_FCC90

July 4, 2018

All test results contained in this engineering test report are traceable to National Institute of Standards and Technology (NIST)

EXHIBIT 6. TEST EQUIPMENT LIST

Test Instrument	Manufacturer	Model No	Serial No	Frequency Range	Cal Due date
Power Meter	HP	436A	2709A27515	100KHz-sensor dependant	04 May 2019
Power Sensor	HP	8482A	MY41172054	10MHz-18GHz	26 Oct 2019
Attenuator(30dB)	Aeroflex\Weinschel	46-30-34	BR9127	DC-18GHz	Cal on use
Power Supply	Tenma	72-7295	490300297	1-40V, DC 5A	----
Modulation Analyzer	HP	HP-8901B	3226A04606	150KHz-1300MHz	23 Mar 2020
AF Signal Generator	HP	HP-8920B	US39064699	30MHz-1GHz	20 Mar 2020
Digital Voltmeter	HP	3456A	2015A04523		19 Dec 2019
FFT Digital Spectrum Analyzer	Advantest	R9211E	8202336	10MHz-100KHz	13 Sep 2018
Signal Generator	Rhode & Schwarz	SMIQ 06ATE	100086	300KHz-6.4GHz	22 Mar 2019
Combiner	Mini-Circuit	ZFSC-3-4	15542	1MHz-1GHz	Cal on use
RF Detector	Pasternack	PE8000-50	--	10MHz-1GHz	Cal on use
Attenuator(10dB)	Aeroflex\Weinschel	33-10-34	AW2970	DC-8GHz	Cal on use
Oscilloscope	HP	54801A	US38380192	DC-500MHz	06 Sep 2018
Spectrum Analyzer	Rohde & Schwarz	FSU	100398	20Hz-26.5GHz	06 Oct 2019
Hi-pass filter	Mini-Circuit	SHP-250	--	Cut off 230MHz	Cal on use
Hi-pass filter	Mini-Circuit	SHP-600	--	Cut off 560MHz	Cal on use
Hi-pass filter	Mini-Circuit	SHP-800	--	Cut off 800MHz	Cal on use
Combiner	Weinschel 93458	1515	PS119	DC-18GHz	Cal on use
Bicon Antenna	ETS	3110B	3379	30-200MHz	06 Feb 2020
Dipole	ETS-Lindgren	3121C-DB1	434	400-1000	20 Jul 2018
Log Periodic Antenna	ETS	3148	00023845	200-2000MHz	20 Jul 2018
Horn Antenna	ETS	3115	6570	1-18GHz	13 Oct 2018
Horn Antenna	ETS	3117	00119425	1-18GHz	29 Jun 2019
Preamplifier	Com-Power	PAM-118A	551016	500MHz-18GHz	09 Mar 2019
Preamplifier	Com-Power	PA-103	161040	1-1000MHz	16 May 2019
Signal Generator	Rohde&Schwarz	SMIQ 06L	10059	300KHz-6.4GHz	24 Jul 2019
Environmental Chamber	Envirotronics	SSH32C	11994847-S-11059	-60 to 177° C	15 Jun 2019
Frequency Counter	EIP	545A	2683	10MHz-1GHz	20 Jul 2018
Attenuator(20dB)	Aeroflex\Weinschel	34-20-34	BP6023	DC-18GHz	Cal on use
Attenuator(20dB)	Weinschel	WA 35-20-33	A164	DC-8.5GHz	Cal on use
Multimeter	Tenma	72-6202	02080027	---	14 Dec 2019
Multimeter	Fluke	8842A	5021295	---	23 Oct 2019

ULTRATECH GROUP OF LABS

3000 Bristol Circle, Oakville, Ontario, Canada L6H 6G4
 Tel. #: 905-829-1570, Fax. #: 905-829-8050, Email: vic@ultratech-labs.com, Website: <http://www.ultratech-labs.com>

File #: 18ICOM488_FCC90

July 4, 2018

All test results contained in this engineering test report are traceable to National Institute of Standards and Technology (NIST)

EXHIBIT 7. MEASUREMENT UNCERTAINTY

The measurement uncertainties stated were calculated in accordance with the requirements of CISPR 16-4-2 @ IEC:2003 and JCGM 100:2008 (GUM 1995) – Guide to the Expression of Uncertainty in Measurement.

7.1. RADIATED EMISSION MEASUREMENT UNCERTAINTY

	Radiated Emission Measurement Uncertainty @ 3m, Horizontal (30-1000 MHz):	Measured	Limit
u_c	Combined standard uncertainty: $u_c(y) = \sqrt{\sum_{i=1}^m u_i^2(y)}$	± 2.15	± 2.6
U	Expanded uncertainty U: $U = 2u_c(y)$	± 4.30	± 5.2

	Radiated Emission Measurement Uncertainty @ 3m, Vertical (30-1000 MHz):	Measured	Limit
u_c	Combined standard uncertainty: $u_c(y) = \sqrt{\sum_{i=1}^m u_i^2(y)}$	± 2.39	± 2.6
U	Expanded uncertainty U: $U = 2u_c(y)$	± 4.78	± 5.2

	Radiated Emission Measurement Uncertainty @ 3 m, Horizontal & Vertical (1 – 18 GHz):	Measured	Limit
u_c	Combined standard uncertainty: $u_c(y) = \sqrt{\sum_{i=1}^m u_i^2(y)}$	± 1.87	Under consideration
U	Expanded uncertainty U: $U = 2u_c(y)$	± 3.75	Under consideration

EXHIBIT 8. MEASUREMENT METHODS

8.1. CONDUCTED POWER MEASUREMENTS

- The following shall be applied to the combination(s) of the radio device and its intended antenna(e).
- If the RF level is user adjustable, all measurements shall be made with the highest power level available to the user for that combination.
- The following method of measurement shall apply to both conducted and radiated measurements.
- The radiated measurements are performed at the Ultratech Calibrated Open Field Test Site.
- The measurement shall be performed using normal operation of the equipment with modulation.

Test procedure shall be as follows:

Step 1: Duty Cycle measurements if the transmitter's transmission is transient

- Using a EMI Receiver with the frequency span set to 0 Hz and the sweep time set at a suitable value to capture the envelope peaks and the duty cycle of the transmitter output signal;
- The duty cycle of the transmitter, $x = \text{Tx on} / (\text{Tx on} + \text{Tx off})$ with $0 < x < 1$, is measure and recorded in the test report. For the purpose of testing, the equipment shall be operated with a duty cycle that is equal or more than 0.1.

Step 2: Calculation of Average EIRP. See Figure 1

- The average output power of the transmitter shall be determined using a wideband, calibrated RF average power meter with the power sensor with an integration period that exceeds the repetition period of the transmitter by a factor 5 or more. The observed value shall be recorded as "A" (in dBm);
- The e.i.r.p. shall be calculated from the above measured power output "A", the observed duty cycle x, and the applicable antenna assembly gain "G" in dBi, according to the formula:

$$\text{EIRP} = \text{A} + \text{G} + 10\log(1/x)$$

{X = 1 for continuous transmission => $10\log(1/x) = 0$ dB}

Figure 1.

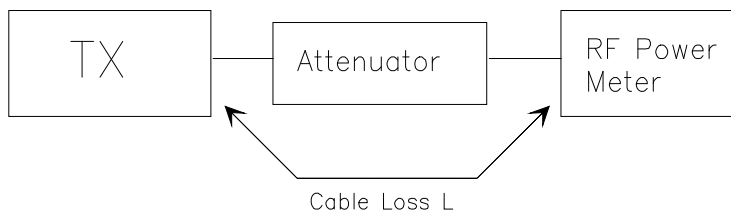

8.2. RADIATED POWER MEASUREMENTS (ERP & EIRP) USING SUBSTITUTION METHOD

8.2.1. MAXIMIZING RF EMISSION LEVEL (E-FIELD)

- (a) The measurements were performed with full rf output power and modulation.
- (b) Test was performed at listed 3m open area test site (listed with FCC, IC, ITI, NVLAP, ACA & VCCI).
- (c) The transmitter under test was placed at the specified height on a non-conducting turntable (80 cm height)
- (d) The BICONILOG antenna (20 MHz to 1 GHz) or HORN antenna (1 GHz to 18 GHz) was used for measuring.
- (e) Load an appropriate correction factors file in EMI Receiver for correcting the field strength reading level

Total Correction Factor recorded in the EMI Receiver = Cable Loss + Antenna Factor
 $E \text{ (dB}\mu\text{V/m)} = \text{Reading (dB}\mu\text{V)} + \text{Total Correction Factor (dB/m)}$

- (f) Set the EMI Receiver and #2 as follows:

Center Frequency: test frequency
Resolution BW: 100 KHz
Video BW: same
Detector Mode: positive
Average: off
Span: 3 x the signal bandwidth

- (g) The test antenna was lowered or raised from 1 to 4 meters until the maximum signal level was detected.
- (h) The transmitter was rotated through 360° about a vertical axis until a higher maximum signal was received.
- (i) The test antenna was lowered or raised again from 1 to 4 meters until a maximum was obtained. This level was recorded.
- (j) The recorded reading was corrected to the true field strength level by adding the antenna factor, cable loss and subtracting the pre-amplifier gain.
- (k) The above steps were repeated with both transmitters' antenna and test receiving antenna placed in vertical and horizontal polarization. Both readings with the antennas placed in vertical and horizontal polarization shall be recorded.
- (l) Repeat for all different test signal frequencies.

8.2.2. Measuring the EIRP of Spurious/Harmonic Emissions using Substitution Method

- (a) Set the EMI Receiver (for measuring E-Field) and Receiver #2 (for measuring EIRP) as follows:

Center Frequency: equal to the signal source
Resolution BW: 100 KHz
Video BW: VBW > RBW
Detector Mode: positive
Average: off
Span: 3 x the signal bandwidth

- (b) Load an appropriate correction factors file in EMI Receiver for correcting the field strength reading level

Total Correction Factor recorded in the EMI Receiver = Cable Loss + Antenna Factor
E (dBuV/m) = Reading (dBuV) + Total Correction Factor (dB/m)

- (c) Select the frequency and E-field levels obtained in the Section 8.2.1 for ERP/EIRP measurements.
(d) Substitute the EUT by a signal generator and one of the following transmitting antenna (substitution antenna):
♦ DIPOLE antenna for frequency from 30-1000 MHz or
♦ HORN antenna for frequency above 1 GHz }.
(e) Mount the transmitting antenna at 1.5 meter high from the ground plane.
(f) Use one of the following antenna as a receiving antenna:
♦ DIPOLE antenna for frequency from 30-1000 MHz or
♦ HORN antenna for frequency above 1 GHz }.
(g) If the DIPOLE antenna is used, tune it's elements to the frequency as specified in the calibration manual.
(h) Adjust both transmitting and receiving antenna in a VERTICAL polarization.
(i) Tune the EMI Receivers to the test frequency.
(j) Lower or raise the test antenna from 1 to 4 meters until the maximum signal level was detected.
(k) The transmitter was rotated through 360° about a vertical axis until a higher maximum signal was received.
(l) Lower or raise the test antenna from 1 to 4 meters until the maximum signal level was detected.
(m) Adjust input signal to the substitution antenna until an equal or a known related level to that detected from the transmitter was obtained in the test receiver.
(n) Record the power level read from the Average Power Meter and calculate the ERP/EIRP as follows:

$$P = P1 - L1 = (P2 + L2) - L1 = P3 + A + L2 - L1$$

$$EIRP = P + G1 = P3 + L2 - L1 + A + G1$$

$$ERP = EIRP - 2.15 \text{ dB}$$

$$\text{Total Correction factor in EMI Receiver \# 2} = L2 - L1 + G1$$

Where: P: Actual RF Power fed into the substitution antenna port after corrected.
P1: Power output from the signal generator
P2: Power measured at attenuator A input
P3: Power reading on the Average Power Meter
EIRP: EIRP after correction
ERP: ERP after correction

- (o) Adjust both transmitting and receiving antenna in a HORIZONTAL polarization, then repeat step (k) to (o)
(p) Repeat step (d) to (o) for different test frequency
(q) Repeat steps (c) to (j) with the substitution antenna oriented in horizontal polarization.
(r) Actual gain of the EUT's antenna is the difference of the measured EIRP and measured RF power at the RF port. Correct the antenna gain if necessary.

Figure 2

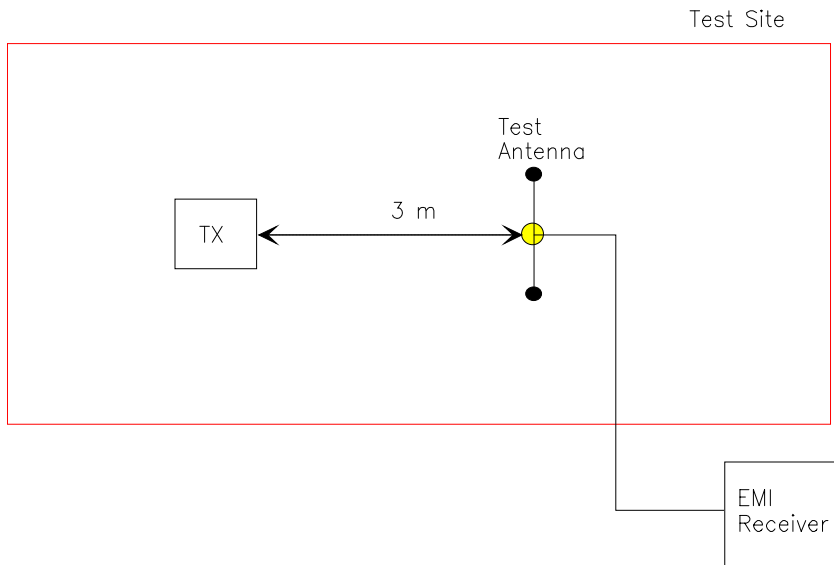
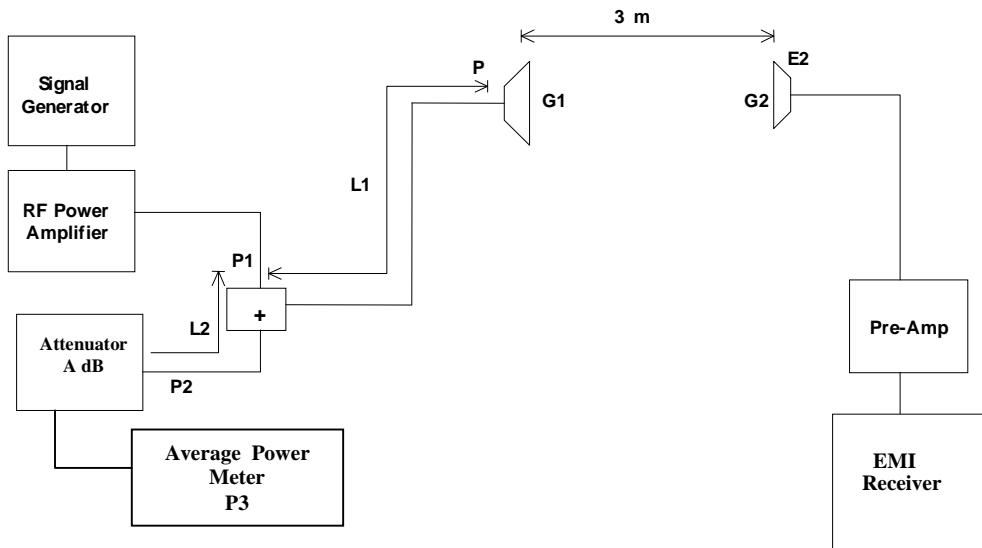

Figure 3



8.3. FREQUENCY STABILITY

Refer to FCC @ 2.1055.

- (a) The frequency stability shall be measured with variation of ambient temperature as follows: From -30 to +50 centigrade except that specified in subparagraph (2) & (3) of this paragraph.
- (b) Frequency measurements shall be made at extremes of the specified temperature range and at intervals of not more than 10 centigrade through the range. A period of time sufficient to stabilize all of the components of the oscillator circuit at each temperature level shall be allowed prior to frequency measurement. The short-term transient effects on the frequency of the transmitter due to keying (except for broadcast transmitters) and any heating element cycling normally occurring at each ambient temperature level also shall be shown. Only the portion or portions of the transmitter containing the frequency determining and stability circuitry need be subjected to the temperature variation test.
- (d) The frequency stability supply shall be measured with variation of primary supply voltage as follows:
 - (1) Vary primary supply voltage from 85 to 115 percent of the nominal value for other than hand carried battery equipment.
 - (2) For hand carried, battery powered equipment, reduce primary supply voltage to the battery operating end point which shall be specified by the manufacturer.
 - (3) The supply voltage shall be measured at the input to the cable normally provide with the equipment, or at the power supply terminals if cables are not normally provided. Effects on frequency of transmitter keying (except for broadcast transmitters) and any heating element cycling at the nominal supply voltage and at each extreme also shall be shown.
- (e) When deemed necessary, the Commission may require tests of frequency stability under conditions in addition to those specifically set out in paragraphs (a), (b), (c) and (d) of this section. (For example, measurements showing the effect of proximity to large metal objects, or of various types of antennas, may be required for portable equipment).

8.4. EMISSION MASK

Voice or Digital Modulation Through a Voice Input Port @ 2.1049(c)(i):- The transmitter was modulated by a 2.5 KHz tone signal at an input level 16 dB greater than that required to produce 50% modulation (e.g.: ± 2.5 KHz peak deviation at 1 KHz modulating frequency). The input level was established at the frequency of maximum response of the audio modulating circuit.

Digital Modulation Through a Data Input Port @ 2.1049(h):- Transmitters employing digital modulation techniques - when modulated by an input signal such that its amplitude and symbol rate represent the maximum rated conditions under which the equipment will be operated. The signal shall be applied through any filter networks, pseudo-random generators or other devices required in normal service. Additionally, the Emission Masks shall be shown for operation with any devices used for modifying the spectrum when such devices are operational at the discretion of the user.

The following EMI Receiver bandwidth shall be used for measurement of Emission Mask/Out-of-Band Emission Measurements:

- (1) For 25 KHz Channel Spacing: RBW = 300 Hz
- (2) For 12.5 KHz or 6.25 KHz Channel Spacings: RBW = 100 Hz

The all cases the Video Bandwidth shall be equal or greater than the measuring bandwidth.

8.5. SPURIOUS EMISSIONS (CONDUCTED)

With transmitter modulation characteristics described in Out-of-Band Emissions measurements @ 2.1049, the transmitter spurious and harmonic emissions were scanned. The spurious and harmonic emissions were measured with the EMI Receiver controls set as RBW = 30 KHz minimum, VBW \geq RBW and SWEEP TIME = AUTO). The transmitter was operated at a full rated power output, and modulated as follows:

FCC 47 CFR 2.1057 - Frequency spectrum to be investigated: The spectrum was investigated from the lowest radio generated in the equipment up to at least the 10th harmonic of the carrier frequency or to the highest frequency practicable in the present state of the art of measuring techniques, whichever is lower. Particular attention should be paid to harmonics and subharmonics of the carrier frequency. Radiation at the frequencies of multiplier stages should be checked. The amplitude of spurious emissions which are attenuated more than 20 dB below the permissible value need not be reported.

FCC 47 CFR 2.1051 - Spurious Emissions at Antenna Terminal: The radio frequency voltage or powers generated within the equipment and appearing on a spurious frequency shall be checked at the equipment output terminals when properly loaded with a suitable artificial antenna. Curves or equivalent data shall show the magnitude of the harmonic and other spurious emission that can be detected when the equipment is operated under the conditions specified in 2.1049 as appropriate. The magnitude of spurious emissions, which are attenuated more than 20 dB below the permissible value, need not be specified.

8.6. TRANSIENT FREQUENCY BEHAVIOR

1. Connect the transmitter under tests as shown in the above block diagram
2. Set the signal generator to the assigned frequency and modulate with a 1 KHz tone at ± 12.5 KHz deviation and its output level to be 50 dB below the transmitter rf output at the test receiver end.
3. Set the horizontal sweep rate on the storage scope to 10 milliseconds per division and adjust the display to continuously view the 1000 Hz tone from the Demodulator Output Port (DOP) of the Test Receiver. Adjust the vertical scale amplitude control of the scope to display the 1000 Hz at ± 4 divisions vertical Center at the display.
4. Adjust the scope so it will trigger on an increasing magnitude from the RF trigger signal of the transmitter under test when the transmitter was turned on. Set the controls to store the display.
5. The output at the DOP, due to the change in the ratio of the power between the signal generator input power and transmitter output power will, because of the capture effect of the test receiver, produce a change in display: For the first part of the sweep it will show the 1 KHz test signal. Then once the receiver's demodulator has been captured by the transmitter power, the display will show the frequency difference from the assigned frequency to the actual transmitter frequency versus time. The instant when the 1 KHz test signal is completely suppressed (including any capture time due to phasing) is considered to be t_{on} . The trace should be maintained within the allowed divisions during the period t_1 and t_2 .
6. During the time from the end of t_2 to the beginning of t_3 the frequency difference should not exceed the limits set by the FCC in Part 90.214 and the outlined in the Carrier Frequency Stability sections. The allowed limit is equal to FCC frequency tolerance limits specified in FCC 90.213.
7. Repeat the above steps when the transmitter was turned off for measuring t_3 .