

### ◇ Sending a Test call

You should avoid testing calls on the exclusive DSC distress channels and safety calling channels. When you cannot avoid testing on a distress or safety channel, you should indicate that these are test calls.

Normally the Test call would require no further communications between the two stations involved.

1. Push **OTHER DSC**.
  - The “Other DSC” screen is displayed.
  - ① You can also display the “Other DSC” screen by selecting the “Other DSC” item on the Menu screen.

2. Select “Test,” and then push [ENT].
  - The Test call is selected, and returns to the “OTHER DSC” screen.



3. Select “Address,” and then push [ENT].
  - The “ADDRESS” screen is displayed.

4. Select a station to send the Test call to.
  - ① You can also select “Manual Input” to manually enter the calling station.

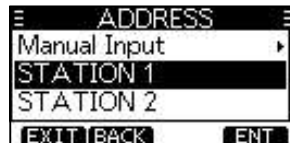

5. Push **CALL** to send the Test call.
  - “Transmitting Test Call” is displayed.
  - ① If Channel 70 is busy, the transceiver stands by until the channel becomes clear.

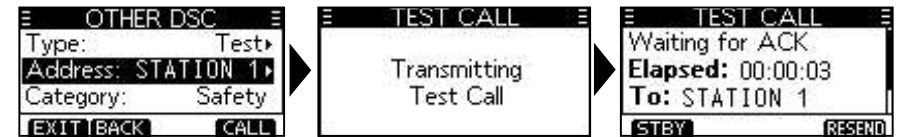

6. When you receive an Acknowledgement:
  - An alarm sounds.
  - The screen to the right is displayed.
7. Push **ALARM OFF** to turn OFF the alarm.
  - The Acknowledgement information is displayed.



8. Push **STBY**.
  - “Terminate the procedure. Are you sure?” is displayed.
9. Push **OK** to return to the operating screen.

## 7 DSC OPERATION

### ◇ Sending a Test Acknowledgement

By default, when you receive a Test call, the Auto ACK function automatically sends an Acknowledgement to the calling station (p. 42). If the function is set to “Manual,” do the following steps to send an Acknowledgement.

1. After a Test call is being received, push **ALARM OFF** to turn OFF the alarm.
2. Push **ACPT**.
  - The received call’s information is displayed.
3. Push **ACK**.
  - The “Test ACK” confirmation screen is displayed.



4. Push **CALL** to send the Acknowledgement.
  - “Transmitting Test ACK” is displayed.

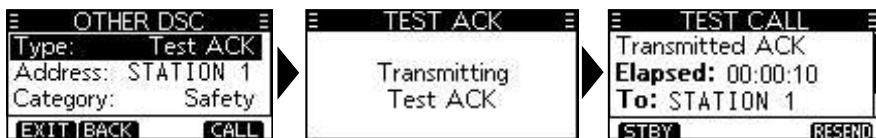

5. Push **STBY**.
  - A confirmation screen is displayed.
6. Push **OK** to return to the operating screen.

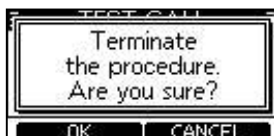

### ◇ Sending a Position Request call/Polling Request call (For only the USA version)

You can send a Position Request call or Polling request call to a station, depending on the presetting.  
(Example: Sending a Position Request call)

1. Push **OTHER DSC**.
  - The “OTHER DSC” screen is displayed.
  - ① You can also display the “OTHER DSC” screen by selecting the “Other DSC” item on the Menu screen.
2. Select “Type,” and then push [ENT].
  - The “MESSAGE TYPE” screen is displayed.
3. Select “Position,” and then push [ENT].
  - The message type is selected, and returns to the “OTHER DSC” screen.
  - ① When you send a Polling Request call, select “Polling.”
4. Select “Address,” and then push [ENT].
  - The “ADDRESS” screen is displayed.
5. Select a target to send a Position Request call to, and the push [ENT].
  - ① You can also select “Manual Input” to manually enter the target ID.

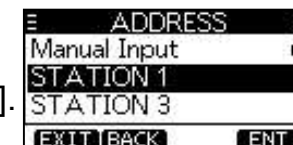

6. Push **CALL** to send the Position Request call.
  - “Transmitting Position Request” is displayed, and then the assigned channel is automatically selected.
  - ① If Channel 70 is busy, the transceiver stands by until the channel becomes clear.



7. When you receive a Position Reply:
  - An alarm sounds.
  - The screen to the right is displayed.
8. Push **ALARM OFF** to turn OFF the alarm.
9. Push **CLOSE**.
  - The received information is displayed.
10. Push [▲] or [▼] to scroll the screen then check the target’s position.
11. Push **STBY**, and then **OK** to return to the operating screen.



### ◇ Sending a Position Reply call

Send a Position Reply call when a Position Request call is received. If the Auto ACK function is set to “Auto,” the Acknowledgement is automatically sent to the calling station. (p. 42)

1. While a Position Request call is being received, push **ALARM OFF** to turn OFF the alarm.
2. Push **ACPT**.
  - The received call’s information is displayed.
3. Push **ABLE** to send an “Able to Comply” Acknowledgement, or push **UNABLE** to send an “Unable to Comply” Acknowledgement.
  - ① If no valid GPS position is received, you can manually enter the position and time in “Position” item on this screen. See “Entering the position and time” on page 20 for details.
4. Push **CALL** to send the Position Reply call.

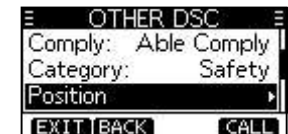

5. Push **STBY**, and then **OK** to return to the operating screen.

## ■ Receiving DSC calls (Distress)

The transceiver receives Distress calls, Distress Acknowledgement calls, and Distress Cancel calls.

① When you receive a call, an emergency alarm sounds.

**NOTE:** The screens that are displayed when a Distress call or an Acknowledgement call is received slightly differ from one another. The following steps are described using an example of receiving a Distress call.

### *When a Distress call is received:*

- The emergency alarm sounds until you turn it OFF.
- “RCVD DISTRESS” is displayed.

1. Push **ALARM OFF** to turn OFF the alarm.
2. Push the software key below the intended operation.



### **IGN** (Ignore):

- Returns to the operating screen.
- The call is saved in the DSC Log.
- “” blinks continuously until you display the call message.

### **PAUSE** (Pause):

- ① **PAUSE** is not displayed if the “CH Auto SW” item is set to “Manual.” (p. 42)
- Pauses the countdown until the assigned channel is automatically selected.
- Select **RESUME** to resume the countdown.
- The call is saved in the DSC Log.

### **ACPT** (Accept):

- Accepts the call.
- Channel 16 is automatically selected.
- Monitor Channel 16 as a coast station may require assistance.
- After Channel 16 is selected, you can select your next operation by pushing the software key below the following options.

**EXIT**: Returns to the operating screen.

**HIST**: Displays the “DISTRESS HISTORY” screen.

**INFO**: Displays the information of the received Distress call.

## ■ Receiving DSC calls (other)

The transceiver receives the following types of DSC calls.

- Individual call (p. 33)
  - Individual Acknowledgement call (p. 26)
  - Group call (p. 34)
  - All Ships call (p. 35)
  - Position Request call (p. 36)
  - Test call (p. 37)
  - Test Acknowledgement call (p. 38)
- ① The receivable call types may differ, depending on the version or presetting.

### ◇ Receiving an Individual call

**When an Individual call is received:**

- The alarm sounds.
  - “RCVD INDIVIDUAL” is displayed.
1. Push **ALARM OFF** to turn OFF the alarm.
  2. Push the software key below the next operation.



#### **IGN** (Ignore)

- Ignores the call and returns to the operating screen.
- The call is saved in the DSC Log.
- “✉” blinks continuously until you display the call message.

#### **ABLE** (Able to comply)

- Sends an Individual Acknowledgement call right away.
- The assigned channel is automatically selected.
- After sending, [RESEND] to resend.
- The call is saved in the DSC Log.

#### **ACPT** (Accept)

- Accepts the call.
- The assigned channel is automatically selected.
- The call is saved in the DSC Log.
- The received call’s information is displayed.
- Push the software key to select the Acknowledgement option.



**ABLE (Able to Comply):** Sends an Acknowledgement call without any changes.

**UNABLE (Unable to Comply):** Sends an Acknowledgement but you cannot communicate.

**NEWCH (Propose New CH):** Sends an Acknowledgement call but on another channel. Assign the channel by pushing [▲] or [▼].

**NOTE:** If the Auto ACK function is set to “Auto (Unable)” the Acknowledgement “Unable to Comply” is automatically sent to the calling station when the call is received. (p. 42)  
 ① For the USA version, this function is set to “Auto (Able)” by default.

## 7 DSC OPERATION

### ◇ Receiving a Group call

#### *When a Group call is received:*

- The alarm sounds for 2 minutes.
- “RCVD GROUP CALL” is displayed.

1. Push **ALARM OFF** to turn OFF the alarm.
  - ① The channel that is assigned by the caller is automatically selected after 10 seconds by default.
2. Push the software key below your next operation.

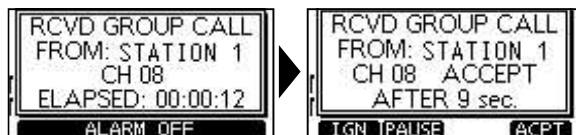

#### **IGN** (Ignore):

- Ignores the call and returns to the operating screen.
- The call is saved in the DSC Log.
- “” blinks continuously until you display the call message.

#### **PAUSE** (Pause):

- ① **PAUSE** is not displayed if the “CH Auto SW” item is set to “Manual.” (p. 42)
- Pauses the countdown until the assigned channel is automatically selected.
- Select **RESUME** to resume the countdown.
- The call is saved in the DSC Log.

#### **ACPT** (Accept):

- Accepts the call.
- The assigned channel is selected.
- The call is saved in the DSC Log.

**STBY**: Closes the Group call, and then returns to the operating screen.

**INFO**: The received call's information is displayed.

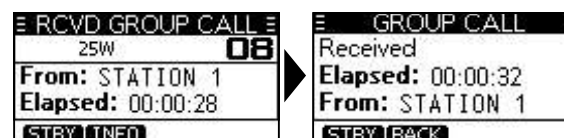

### ◇ Receiving an All Ships call

#### When an All Ships call is received:

- The alarm sounds.
  - “RCVD ALL SHIPS” is displayed.
1. Push **ALARM OFF** to turn OFF the alarm.
    - ① The traffic channel that is assigned by the caller is automatically selected after 10 seconds by default.
  2. Push the software key below your next operation.



#### **IGN** (Ignore)

- Ignores the call and returns to the operating screen.
- The call is saved in the DSC Log.
- “” blinks continuously until you display the call message.

#### **PAUSE** (Pause)

- ① **PAUSE** is not displayed if the “CH Auto SW” item is set to “Manual.” (p. 42)
- Pauses the countdown until the assigned channel is automatically selected.
- Select **RESUME** to resume the countdown.
- The call is saved in the DSC Log.

#### **ACPT** (Accept)

- Accepts the call.
- The assigned channel is selected.
- The call is saved in the DSC Log.

**STBY**: Closes the All Ships call, and then returns to the operating screen.

**INFO**: The received call’s information is displayed.

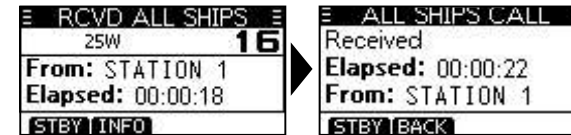

## 7 DSC OPERATION

### ◇ Receiving a Position Request call

(For only the USA version, depending on the presetting)

#### When a Position Request call is received:

- The alarm sounds for 2 minutes.
  - “RCVD POS Request” is displayed.
1. Push **ALARM OFF** to turn OFF the alarm.
  2. Push the software key below the intended operation.



#### **IGN** (Ignore)

- Ignores the call and returns to the operating screen.
- The call is saved in the DSC Log.
- “” blinks continuously until you display the call message.

#### **ABLE** (Able to Comply)

- Sends the Acknowledgement “Able to Comply.”
- The call is saved in the DSC Log.

#### **UNABLE** (Unable to Comply)

- Sends the Acknowledgement “Unable to Comply.”
- Displays the Acknowledgement information, and then returns to the operating screen by pushing **EXIT**.
- The call is saved in the DSC Log.

#### **ACPT** (Accept)

- Accepts the call.
- Displays the received call’s information.
- The call is saved in the DSC Log.
- Push **ABLE** or **UNABLE**, then push **CALL** to send the Position Reply call. (p. 31)



#### NOTE:

- If the Auto ACK function is set to “Auto,” the Position Reply is automatically sent to the calling station. (p. 42)
- However, even if the Auto ACK function is set to “Manual,” after receiving a Distress Acknowledgement, or while in the Distress Cancel call procedure, the Position Reply is automatically sent to the calling station.



## ◇ Receiving a Test call

**TIP:** By default, the Auto ACK function automatically sends an Acknowledgement to the calling station (p. 42). If the function is set to “Manual,” the following screens are displayed.

### When a Test call is received:

- The alarm sounds for 2 minutes.
  - “RCVD TEST CALL” is displayed.
1. Push **ALARM OFF** to turn OFF the alarm.
  2. Push the software key below your next operation.



### **IGN** (Ignore)

- Ignores the call and returns to the operating screen.
- The call is saved in the DSC Log.
- “✉” blinks continuously until you display the call message.

### **ABLE** (Able to Comply)

- Sends the Acknowledgement “Able to Comply.”
- The call is saved in the DSC Log.

### **ACPT** (Accept)

- Accepts the call.
- Displays the received call’s information.
- The call is saved in the DSC Log.
- Push **ACK**, and then push **CALL** to send a Test Acknowledgement call. (p. 30)
- Push **RESEND** to resend.

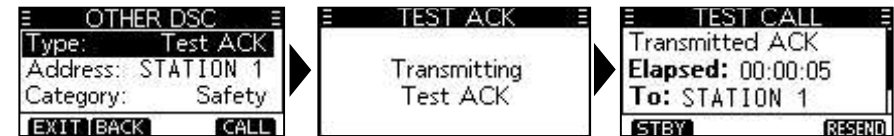

**NOTE:** If the Auto ACK function is set to “Auto,” the Test Acknowledgement call is automatically sent to the calling station when the call is received. (p. 42)

## ◇ Receiving a Test Acknowledgement call

After sending a Test call, the called station will send you a Test Acknowledgement call.

### *When a Test Acknowledgement call is received:*

- The alarm sounds for 2 minutes.
- “RCVD TEST ACK” is displayed.



1. Push **ALARM OFF** to turn OFF the alarm.
2. Push **CLOSE**.
  - The received call's information is displayed.



- The call is saved in the DSC Log.
3. Push **STBY** to return to the operating screen.

## ■ DSC Log

### ◇ Received DSC Log

The transceiver saves up to 30 received Distress call messages and 50 received “Others” call messages in your DSC Log.

On the operating screen, “” is displayed when there is an unread call message. The icon blinks when there is a new received call message.

1. Display the “DSC Log” screen.

Menu > **DSC Log**

2. Push [▲] or [▼] to select “Received Call Log,” and then push [ENT].
  - The “RCVD CALL LOG” screen is displayed.
3. Push [▲] or [▼] to select “Distress” or “Others,” and then push [ENT].
  - ① “Distress” displays the received Distress call log, and “Others” displays the received DSC call log.

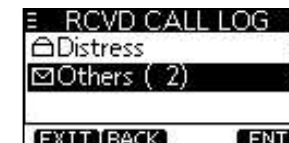

**TIP:** You can also display the “Received” screen by pushing **LOG** on the operating screen.

4. Push [▲] or [▼] to scroll through the log.
5. Push [ENT] to display the received call's information.

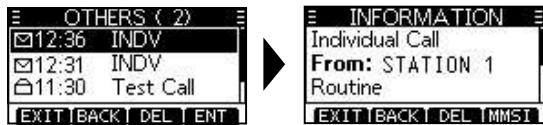

- EXIT**: Returns to the operating screen.
- BACK**: Returns to the previous screen.
- DEL**: Deletes the selected call log.
  - ① The confirmation screen is displayed before deleting.
- MMSI**: Saves the MMSI as an Individual ID.

### ◇ Transmitted DSC Log

The transceiver saves up to 30 DSC transmitted calls in your DSC Log.

1. Display the “DSC Log” screen.

Menu > **DSC Log**

2. Push [▲] or [▼] to select “Transmitted Call Log,” and then push [ENT].
  - The “TX CALL LOG” screen is displayed.
3. Push [▲] or [▼] to scroll through the log.
4. Push [ENT] to display the sent call's information.

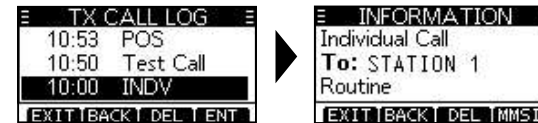

- EXIT**: Returns to the operating screen.
- BACK**: Returns to the previous screen.
- DEL**: Deletes the selected call log.
  - ① Confirmation screen is displayed before deleting.
- MMSI**: Saves the MMSI as an Individual ID or a Group ID.

## ■ Multiple-task mode

(For only the USA version, depending on the presetting.)

If the Multiple-task function is enabled, the transceiver can hold up to 7 tasks. Therefore, you can handle more than 2 DSC tasks simultaneously by switching between the DSC tasks.

To use the Multiple-task mode, select “Multiple” in the “Procedure” on the Menu screen. (p.44)

Menu > DSC Settings > **Procedure**

When the Multiple-task mode is activated, **TASK** is displayed on the operating screen.

**NOTE:** The Task mode has a Time-out Timer (TOT) function. After a certain period of time has passed without any operation on a task, the transceiver automatically exits the Task mode and returns to the operating screen. When a Time-out Timer activates, an alarm sounds and a count down message is displayed for 10 seconds.

## ◇ Holding a DSC task

In the Multiple-task mode, you can hold or activate the DSC task as follows.

**Example: When a Group call is received:**

1. Push **ALARM OFF** to turn OFF the alarm.
  - The received call's information is displayed.
2. Push **HOLD**.
  - The received Group call task is held into the task list and returns to the operating screen.



◇ **Activating the held DSC task**

1. Push **TASK** to display the task list.
  - The task list is displayed.
2. Push [**▲**] or [**▼**] to select the task that you want to activate.
3. Push **ACTIVE** to activate the task.
  - The activated task information is displayed.

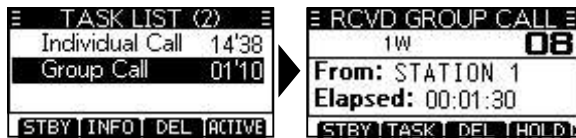

4. Push [PTT] to communicate.
5. After finishing the communication, push **DEL** to delete the task.

◇ **Task list**

When one or more tasks are held, you can display the task list screen by pushing **TASK**.  
The number of tasks is displayed at the top of the screen.

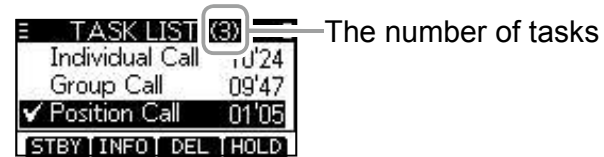

On the “TASK LIST” screen, the following software keys are displayed.

- STBY:** Holds the task and returns to the operating screen.
- INFO:** Displays the task information.
- DEL:** Finishes the selected task.
- HOLD:** Holds the selected task.
- ACTIVE:** Activates the selected task.

### ■ DSC Settings

On the “DSC Settings” screen, you can make settings on the DSC call related items.

#### **Position Input**

---

See “*Entering the position and time*” on page 20 for details.

#### **Individual ID**

---

See “*Entering an Individual ID*” on page 18 for details.

#### **Group ID**

---

See “*Entering a Group ID*” on page 19 for details.

#### **Auto ACK**

---

The Auto ACK function automatically sends an Acknowledgement call when an appropriate Request is received.

- **Individual ACK** (Default: Differs depending on the version or presetting)

Auto (Able): Automatically sends “Able to comply.”  
Auto (Unable): Automatically sends “Unable to comply.”  
Manual: Manually sends an Acknowledgement call.

- **Position ACK** (Default: Auto (Able))

Auto (Able): Automatically sends “Able to comply.”  
Manual: Manually sends an Acknowledgement call.

- **Polling ACK** (Default: Auto)

Auto: Automatically sends an Acknowledgement call.  
Manual: Manually sends an Acknowledgement call.

- **Test ACK** (Default: Auto)

Auto: Automatically sends an Acknowledgement call.  
Manual: Manually sends an Acknowledgement call.

- **CH Auto SW** (Default: Accept)
- 

Select whether or not to automatically switch to channel 16 or the specified channel, or select whether to switch or ignore the call.

Accept: After receiving a DSC call, the transceiver remains on the operating channel for 10 seconds. After that, the transceiver automatically switches to the channel that is specified on the DSC call.

Ignore: After receiving a DSC call, if you do not push the software key below [ACPT] in 10 seconds, the transceiver ignores the call, and then remains on the current operating channel.

Manual: After receiving a DSC call, you can select whether or not to accept the received DSC call.

**Data Output** (Default: Off)

When receiving a DSC call from the station that is selected in this setting, the transceiver outputs the DSC data to the NMEA output port.

① You can send Distress calls despite of this setting.

All Stations: From any station.

Stations List: From the stations that are entered Individual ID or Group ID on the Menu screen.

OFF: Does not output any DSC data from the NMEA 0183 Output port.

**Alarm Status**

Set the alarm ON or OFF for each DSC related item.

• **Safety** (Default: On)  
An alarm sounds when a Safety DSC call is received.

• **Routine** (Default: On)  
An alarm sounds when a Routine DSC call is received.

• **Warning** (Default: On)

An alarm sounds when:

- No MMSI code is entered.
- The position data has not been received for 2 minutes after turning ON the transceiver.
- The received position data has not been updated for 10 minutes.
- The received position data has not been updated for 4 hours.
- The manually entered position data has not been updated for 23.5 hours.

• **Self-Terminate** (Default: On)  
An alarm sounds when duplicate DSC calls are received.

• **Self-Terminate** (Default: On)  
An alarm sounds when duplicate Distress calls are received.

• **Discrete** (Default: On)  
An alarm sounds when a lower priority call is received while receiving a high priority call.

**CH 70 SQL Level** (Default: 3)

Adjust the Squelch level for Channel 70 to between 1 and 10, or Open.

---

## 7 DSC OPERATION

### ■ DSC Settings (Continued)

#### **Self-Test**

---

The Self-Test sends DSC signals to the receiving AF circuit to compare the sending and receiving signals at the AF level.

Push [ENT] to start the Self-Test.

- ① When the sending and receiving DSC signals match, "OK" is displayed.

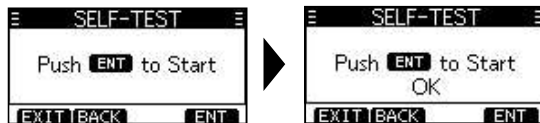

#### **Procedure** (Default: Single)

---

(For only the USA version)

You can select the type of task for the transceiver, depending on the presetting.

- Single: Handles only 1 task at the same time.  
Multiple: Handles up to 7 tasks at the same time.



## ■ Making an Individual call using an AIS transponder

When the optional MA-500TR/MA-510TR\* CLASS B AIS TRANSPONDER is connected to your transceiver, you can transmit an Individual DSC call to a selected AIS target, without entering the target's MMSI code. In this case, the call type is automatically set to Routine.

See page 54 for connecting instructions.

\* Unreleased as of August 2020.

### NOTE:

- To ensure correct operation of the DSC function, make sure you correctly set the CH70 SQL Level. (p.43)
- This instruction is for the MA-500TR. See the MA-510TR Instruction manual for the MA-510TR's step.

1. Select an AIS target on the plotter, target list or danger list display.
  - You can also go to the next step whenever the detail screen of the AIS target is displayed.
  - Confirm the transceiver is in the normal operating mode. Otherwise, you cannot make an Individual DSC call using the transponder.
2. Push [DSC] to display the Voice channel selection screen, and then push [▲]/[▼] to select a Voice channel.\*
  - Voice channels are already preset into the transponder in the recommended order.
  - \* When a coast station is selected in step 1, a Voice channel will be specified by the coast station, therefore you cannot change the channel. The transponder will display "Voice Channel is specified by the Base station," in this case.

3. Push [DSC] to transmit an Individual DSC call to the AIS target.

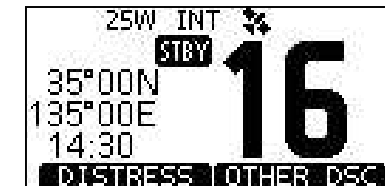

- If Channel 70 is busy, the transceiver stands by until the channel becomes clear.
- If the transceiver cannot make the call, the transponder will display "DSC Transmission FAILED."

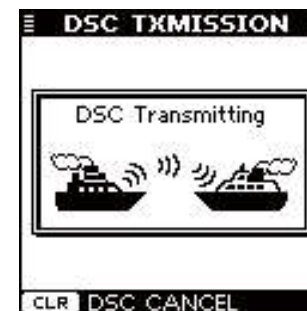

## 7 DSC OPERATION

1. After sending the Individual DSC call, the transponder will display "DSC Transmission COMPLETED."
  - Push [CLEAR] to return to the screen displayed before you entered the Voice channel selection screen in step 2.
  - The transceiver stands by on Channel 70 until an Acknowledgement is received.

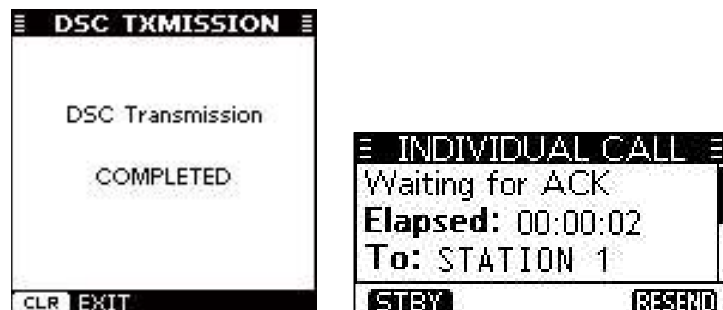

2. When the Acknowledgement is received, alarm sounds.
  - If the Acknowledgement 'Able to comply' is received, push **ALARM OFF** to turn OFF the alarm, and then select the Intership channel specified in step 2.
  - A different Intership channel will be selected if the station you called cannot use the channel.
  - To reply, push [PTT] and speak at a normal voice level.
  - If entered, you can check the MMSI code or the name of the AIS target on the display.
  - If the Acknowledgement 'Unable to comply' is received, push **ALARM OFF** to turn OFF the alarm, then "INDIVIDUAL CALL FAILED" is displayed.

3. After the communication is finished, push **STBY** to return to the normal operating mode.

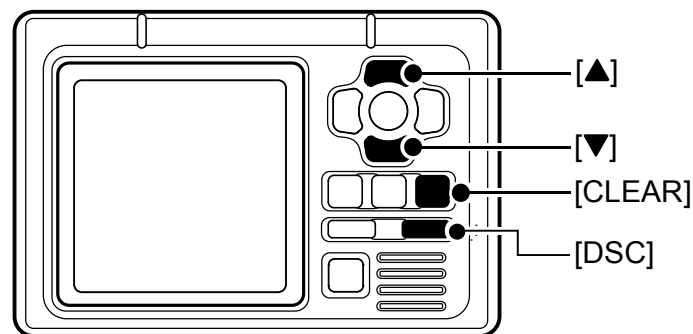

TRANSPONDER

## ■ Using the Menu screen

The Menu screen is used to set items, select options, and so on for the transceiver's functions.

### ◇ Using the Menu screen

**Example:** Setting the key beep to "Off."

1. Push [MENU].
  - The Menu screen is displayed.



2. Push [▲], [▼], or rotate [DIAL] to select "Configuration," and then push [ENT].
  - The "CONFIGURATION" screen is displayed.
  - ① Holding down [▲] or [▼] sequentially scrolls up or down through the Menu screen.



3. Push [▲], [▼], or rotate [DIAL] to select "Key Beep," then push [ENT].
  - The "KEY BEEP" screen is displayed.

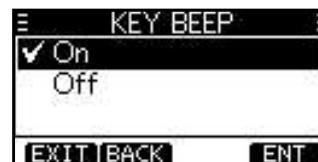

4. Push [▲], [▼], or rotate [DIAL] to select "Off," then push [ENT].
  - ① "Off" is set and the transceiver returns to the previous screen.

#### TIP:

- ① To exit the Menu screen, push **EXIT** or [MENU].
- ① To return to the previous screen, push **BACK** or [CLR].

# 8 MENU SCREEN

## ◇ Menu screen items

The Menu screen contains the following items.

See the referred pages for each items.

- ① The displayed menu items may differ, depending on the version or presetting.

### Distress

Item	Reference	Item	Reference
Nature	p. 21	Position	p. 20

### Other DSC

Item	Reference	Item	Reference
Type	p. 24	Mode	p. 24
Address	p. 24	Channel	p. 24
Category	p. 24	—	—

### GPS (p. 49)

### Configuration

Item	Reference	Item	Reference
Backlight	p. 12	UTC Offset	p. 49
Display Contrast	p. 12	Inactivity Timer	p. 49
Key Beep	p. 49	GPS	p. 50
Key Assignment	p. 49	—	—

### DSC Log

Item	Reference	Item	Reference
Received Call Log	p. 38	Transmitted Call Log	p. 39

### Radio Settings

Item	Reference	Item	Reference
Scan Type	p. 50	WX Alert	p. 51
Scan Timer	p. 50	FAV Settings	p. 51
Dual/Tri-watch	p. 50	FAV On MIC	p. 51
Channel Group	p. 51	CH Display	p. 52
Call Channel	p. 51	CH Close-up	p. 52

### DSC Settings

Item	Reference	Item	Reference
Position Input	p. 42	Data Output	p. 43
Individual ID	p. 42	Alarm Status	p. 43
Group ID	p. 42	CH 70 SQL Level	p. 43
Auto ACK	p. 42	Self-Test	p. 44
CH Auto SW	p. 42	Procedure	p. 44

### Radio Info (p. 52)

## ■ Menu items description

### ◇ GPS

Displays the position information.

### ◇ Configuration

#### Backlight (Default: 7)

You can adjust the backlight brightness between 1 and 7, or OFF.

#### Display Contrast (Default: 5)

You can adjust the display contrast level between 1 (lowest) and 8 (highest).

#### Key Beep (Default: On)

You can select whether or not to sound a beep when a key is pushed.

On: Sounds a beep when a key is pushed.

Off: No beep sounds, for silent operation.

#### Key Assignment

##### • **Softkey 1~16**

You can change which software key functions to display, and their order. You can assign up to 16 software keys at a time.

① The usable software key functions and their order may differ, depending on the transceiver version or presetting.

##### • **Set Default**

Sets the software key function order as default.

① The default setting may differ, depending on the transceiver version or presetting.

#### UTC Offset (Default: 00:00)

Set the offset time between Universal Time Coordinated (UTC) and your local time to between -14:00 and +14:00 (in 1 minute steps).

#### Inactivity Timer

The transceiver automatically returns to the operation screen if you push no key for the set period of time for each mode.

##### • **Not DSC** (Default: 10 min)

Setting for when a screen that is not related to DSC is displayed.

##### • **DSC** (Default: 15 min)

Setting for when a screen that is related to DSC is displayed.

##### • **Distress** (Default: Off)

Setting for when a screen that is related to a Distress call is displayed.

##### • **RT** (Default: 30 sec)

Setting for when the transceiver is in the Radio Telephone mode.

### GPS

---

Selects a satellite to be used for GPS (Global Positioning System) to pinpoint the geographic location of your transceiver anywhere in the world.

This setting may not be usable, depending on the transceiver version or presetting.

- **GPS** (Always On)  
The GPS (Global Positioning System) is permanently set to ON.
- **GLONASS** (Default: On)  
Selects whether or not to use the data from the GLONASS (GLObal'naya NAVigatsionnaya Sputnikovaya Sistema) satellites.
- **SBAS** (Default: Off)  
Turns the SBAS (Satellite Based Augmentation System) function ON or OFF.  
When turning ON this function, the GPS position accuracy can be improved.

### ◇ Radio Settings

#### Scan Type (Default: —)

---

Selects the scan type. The default setting differs, depending on the transceiver version.

① See page 15 for details.

Normal Scan: Scans all Favorite channels in the selected channel group.

Priority Scan: Sequentially scans all Favorite channels, while monitoring Channel 16.

#### Scan Timer (Default: Off)

---

You can use the Scan Timer to pause, or to resume after 5 seconds, when a signal is detected.

On: When a signal is detected on a channel, the scan pauses for 5 seconds, and then resumes. If the signal disappears in less than 5 seconds, the scan immediately resumes.

Off: When a signal is detected on a channel, the scan pauses until the signal disappears, and then resumes.

#### Dual/Tri-watch (Default: Dualwatch)

---

Select Dualwatch or Tri-watch.

Dualwatch: Monitors Channel 16 while receiving on another channel.

Tri-watch: Monitors Channel 16 and the Call channel while receiving on another channel.

① See page 17 for details.

## Channel Group

Select the suitable channel group for your operating area. Select USA, INT, CAN, DSC, or ATIS depending on the transceiver version.

① See page 10 for details.

## Call Chancel

You can change your Call channel. The default setting differs, depending on the transceiver version.

① See page 12 for details.

## WX Alert (Default: Off)

For the USA and Australian versions, an NOAA broadcast station transmits a Weather Alert tone before any important weather information.

① “WX ” is displayed instead of “WX.”

① “WX ” blinks until you push a key after detecting an alert.

On with Scan: The preset Weather channels are sequentially checked while scanning.

On: The previously selected (last used) Weather channel is checked while scanning.

Off: The Weather Alert tone is not detected.

## FAV Settings

You can set all channels as Favorite channels, clear all settings, or reset to default. By default, some channels are preset. The Favorite channels differ, depending on the transceiver version.

Set All Channels: Sets all channels as Favorite channels.

Clear All Channels: Clears all Favorite channels.

Set Default: Resets Favorite channels to the default.

① See page 16 for details.

## FAV on MIC (Default: Off)

You can select the channel set when you push [▲] or [▼] on the supplied microphone.

On: Scrolls through only the Favorite channels.

Off: Scrolls through all the channels.

① See page 16 for details.

---

## 8 MENU SCREEN

### CH Display

---

You can select the number of digits to display the channel number.

3 Digits: The channel number is displayed in 3 digits such as "01A."

4 Digits: The channel number is displayed in 4 digits such as "1001."

① This setting may not be usable, depending on the transceiver version or presetting.

### CH Close-up

---

You can select whether or not to display the channel name when changing the operating channel.

On: The channel number and the channel name are briefly displayed when changing the channel.

Off: The channel name is not displayed on the screen.

### ◇ Radio Info

Displays your transceiver's MMSI, Software version, and GPS version if built-in.





## ■ Connections

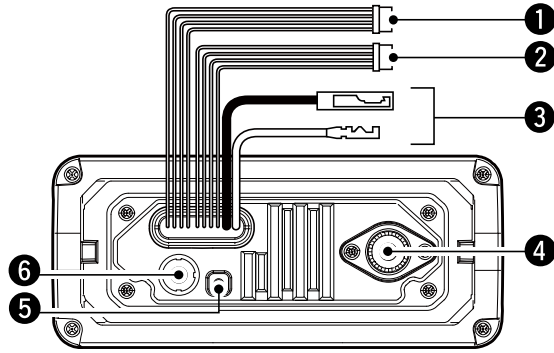

### 1 NMEA IN/OUT LEADS

Green: Listener B (Data-L), GPS In (-)

Yellow: Listener A (Data-H), GPS In (+)

Connect to the NMEA output lines of a GPS receiver for position data.

- NMEA 0183 (ver. 2.0 or later) sentence format RMC, GGA, GNS, or GLL and VTG compatible GPS receiver is required. Ask your dealer about suitable GPS receivers.
- The GPS sentences input from this connector are given priority to over the sentences input from the GPS antenna connector.

Brown: Talker B (Data-L), Data Out (-)

White: Talker A (Data-H), Data Out (+)

Connect to NMEA 0183 input lines of navigation equipment, to receive position data from other ships.

- An NMEA 0183 (ver. 2.0 or later) sentence format DSC or DSE compatible navigation equipment is required.
- The supplied GPS outputs RMC, GSA, and GSV format sentences.

### 2 AF OUT AND DATA LEADS

Blue: External Speaker (+)

Black: External Speaker (-)

Connects to an external speaker.

Orange: Data line

Gray: Data line

Used only for maintenance purpose.

**NOTE for NMEA In/Out and AF Out leads:**  
The connectors are attached to keep the leads together. Before connecting to a piece of equipment, cut the leads to remove the connector.

### 3 DC POWER CONNECTOR

Connects to a 13.8 V DC power source.

(+: Red, -: Black)

**CAUTION:** After connecting the DC power cable, NMEA leads or external speaker leads, cover the connector and leads with a vulcanizing tape, as shown below, to prevent water seeping into the connection.

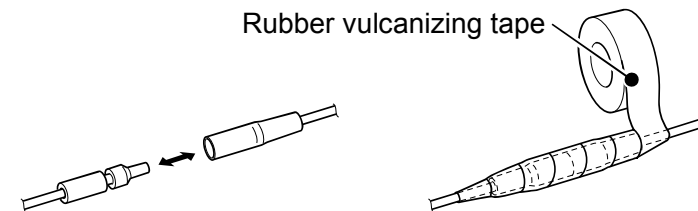

## 9 CONNECTIONS AND MAINTENANCE

### ■ Connections (Continued)

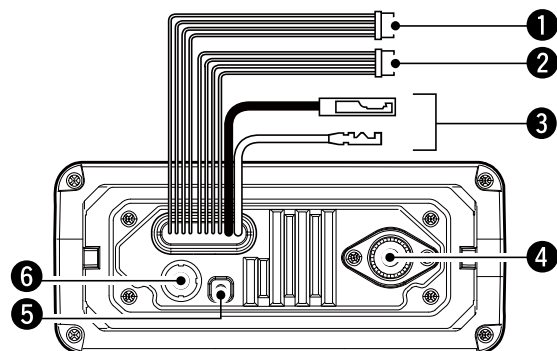

#### 4 ANTENNA CONNECTOR

Connects to a marine VHF antenna with a PL-259 connector.

**CAUTION:** DO NOT transmit without an antenna.

#### 5 GROUND TERMINAL

Connects to a vessel ground to prevent electrical shocks and interference from other equipment occurring. Use a PH M3 × 6 screw (user supplied).

#### 6 GPS ANTENNA CONNECTOR

Connects to the supplied GPS antenna. (For only the IC-M330G/IC-M330GE)

**NOTE:** Be sure the GPS antenna is positioned where the GPS antenna has a clear view to receive signal from satellites, and fixed using the supplied double-sided adhesive pad.

#### ◇ Connect to the MA-500TR/MA-510TR

An Individual DSC call can be made to the AIS target using the transponder without entering the target's MMSI code. See the transponder's instruction manual for connection details.

Connect each lead to the appropriate lead of the OPC-2014 as follows.

- Listener A (Data-H) (Yellow): To lead 3.
- Listener B (Data-L) (Green): To lead 2.
- Talker A (Data-H) (White): To lead 5.
- Talker B (Data-L) (Brown): To lead 4.

**NOTE:** This instruction is for the MA-500TR. See the MA-510TR Instruction manual for the MA-510TR's connecting instructions.

## ■ Antenna

A key element in the performance of any communication system is the antenna. Ask your dealer about antennas and the best place to mount them.

## ■ Fuse replacement

One fuse is installed in the supplied DC power cable. If the fuse blows or the transceiver stops functioning, track down the source of the problem, repair it, and replace the damaged fuse with a new one of the proper rating. Fuse rating: 10 A

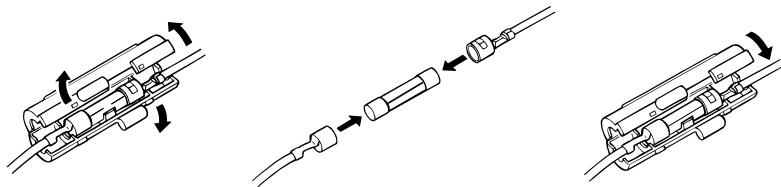

## ■ Cleaning

If the transceiver becomes dusty or dirty, wipe it clean with a soft, dry cloth.



**DO NOT** use harsh solvents such as Benzine or alcohol, as they will damage the transceiver's surfaces.

## ■ Supplied accessories

Mounting bracket

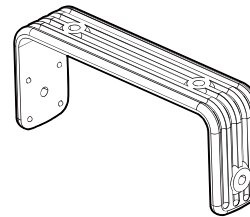

For mounting bracket

Knob bolts



Flat washers (M5)



Screws (5 × 20 mm)



Spring washers (M5)



Microphone hanger and screws (3 × 16 mm)



DC power cable

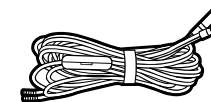

GPS antenna and double-sided adhesive pad (For only the IC-M330G/IC-M330GE)

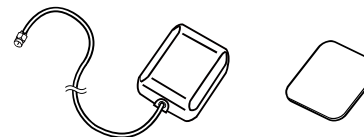

### ■ Mounting the transceiver

#### ◇ Using the supplied mounting bracket

You can mount the transceiver on dashboard using the universal mounting bracket supplied with your transceiver.

1. Mount the bracket securely to a surface which is more than 10 mm thick and can support more than 5 kg using the 2 supplied screws (5 × 20 mm).

**NOTE:** When mounting the transceiver on a board, fix the bracket to the board using the user supplied bolts and nuts as shown to the right.

2. Attach the transceiver to the bracket so that the face of the transceiver is at 90° to your line of sight when operating it.
  - ① Adjust the function display angle to be easy-to-read.

**CAUTION: KEEP** the transceiver and microphone at least 1 meter (3.3 ft) away from the vessel's magnetic navigation compass.

#### *Mounting Example*

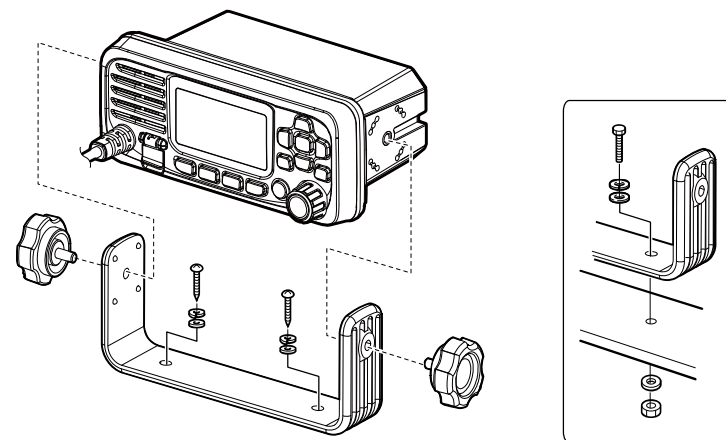

## ■ MBF-5 installation

An optional MBF-5 FLUSH MOUNT KIT is available for mounting the transceiver to a flat surface (less than 20 mm thick), such as an instrument panel.

**KEEP** the transceiver and microphone at least 1 meter away from your vessel's magnetic navigation compass.

1. Using the template on page 63, carefully cut a hole into the instrument panel, or wherever you plan to mount the transceiver. (Torque: 2 N•m)
2. Slide the transceiver through the hole, as shown below.

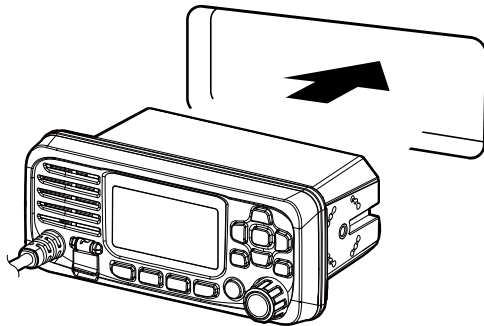

3. Attach the 2 bolts (5 × 8 mm) and spacer supplied with the MBF-5 on both sides of the transceiver.

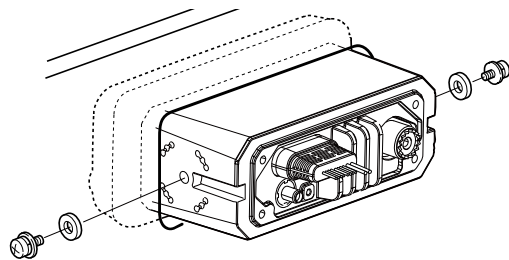

4. Attach the clamps on both sides of the transceiver.
  - ⓘ Make sure that the clamps align parallel to the transceiver body.

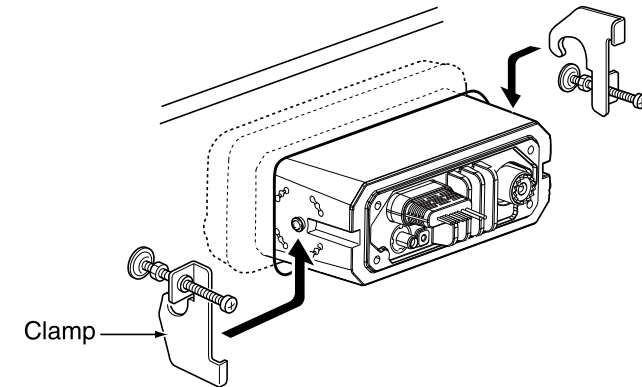

5. Tighten the end bolts on the clamps (rotate clockwise) so that the clamps press firmly against the inside of the instrument control panel.
6. Tighten the locking nuts (rotate counterclockwise) so that the transceiver is securely mounted in position, as shown below. (Torque: 2 N•m)
7. Connect the antenna and power cable, then return the instrument control panel to its original place.

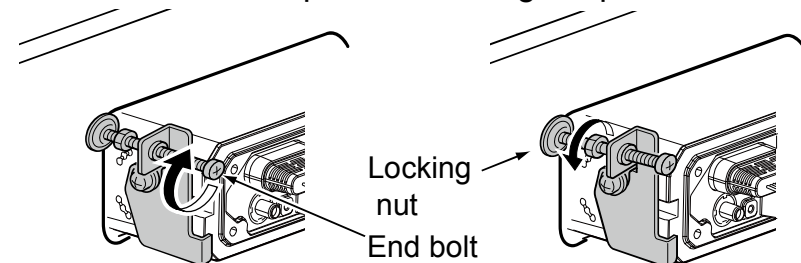

## ■ Specifications

### ◇ General

- Frequency coverage:
 

TX IC-M330/IC-M330G	156.025 ~ 161.600 MHz
IC-M330E/IC-M330GE	156.000 ~ 162.000 MHz
	(Depending on the version)
RX IC-M330/IC-M330G	156.050 ~ 163.275 MHz
IC-M330E/IC-M330GE	156.000 ~ 163.425 MHz
	(Depending on the version)
CH70	156.525 MHz
- Mode:
 

16K0G3E (FM)
16K0G2B (DSC)
- Channel spacing: 25 kHz
- Operating temperature range:  $-20^{\circ}\text{C} \sim +60^{\circ}\text{C}$ ,  
 $-4^{\circ}\text{F} \sim +140^{\circ}\text{F}$
- Current drain (at 13.8 V):
 

TX high (25 W)	5 A maximum
Maximum audio	1 A maximum
- Power supply requirement: Negative Ground
 

IC-M330/IC-M330G	13.8 V DC (11.7 ~ 15.9 V)
IC-M330E/IC-M330GE	13.8 V DC (10.8 ~ 15.6 V)
- Frequency tolerance (IC-M330/IC-M330G):  $\pm 5$  ppm
- Frequency error (IC-M330E/IC-M330GE): Less than  $\pm 0.75$  kHz
- Antenna impedance: 50  $\Omega$  nominal
- Dimensions (approximate, projections not included):
 

156.5 (W) $\times$ 66.5 (H) $\times$ 110.1 (D) mm,
6.2 (W) $\times$ 2.6 (H) $\times$ 4.3 (D) in
- Weight (approximate): 730 g, 1.6 lb

### ◇ Transmitter

- Output power: 25 W or 1 W
- Modulation system: Variable reactance frequency modulation
- Maximum frequency deviation:  $\pm 5$  kHz
- Spurious emissions:
 

IC-M330/IC-M330G	Less than $-70$ dBc (High power)
	Less than $-56$ dBc (Low power)
IC-M330E/IC-M330GE	Less than 0.25 $\mu\text{W}$

### ◇ Receiver

- Receive system: Double conversion superheterodyne
- Sensitivity:
 

FM IC-M330/IC-M330G	0.22 $\mu\text{V}$ (typical) at 12 dB SINAD
IC-M330E/IC-M330GE	$-5$ dB $\mu$ emf (typical) at 20 dB SINAD
DSC (CH70)	$-5$ dB $\mu$ emf (typical) (1% BER)
- Squelch sensitivity:
 

IC-M330/IC-M330G	Less than 0.32 $\mu\text{V}$
IC-M330E/IC-M330GE	Less than $-2$ dB $\mu$ emf
- Intermodulation rejection ratio:
 

FM IC-M330/IC-M330G	More than 70 dB
IC-M330E/IC-M330GE	More than 68 dB
DSC (CH70)	More than 68 dB $\mu$ emf (1% BER)
- Spurious response rejection ratio:
 

FM	More than 70 dB
DSC (CH70)	More than 73 dB $\mu$ emf (1% BER)
- Adjacent channel selectivity:
 

FM	More than 70 dB
DSC (CH70)	More than 73 dB $\mu$ emf (1% BER)
- Audio output power: (at 10% distortion into a 4  $\Omega$  load)
 

Internal	More than 2 W
External	More than 4.5 W

All stated specifications are subject to change without notice or obligation.

◇ **GPS Antenna**

- Frequency : 1575.42 MHz
- Channel: Acquisition, tracking: Maximum 24ch  
Calculation: Maximum 12ch
- Differential satellites: WAAS, EGNOS, MSAS, GAGAN
- GLONASS receiving frequency: 1602 MHz

◇ **Dimensions**

Unit: mm (inch)

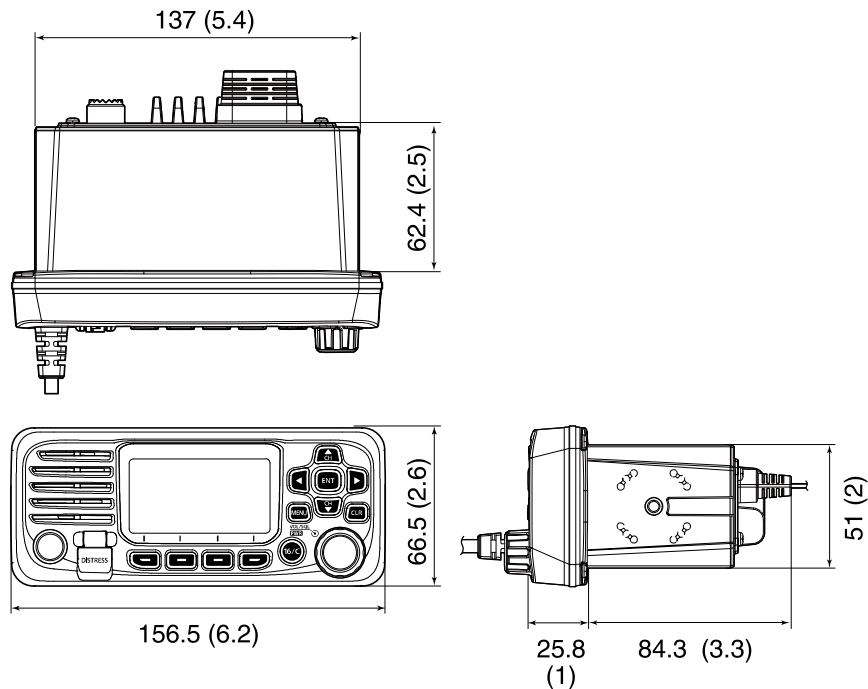

■ **Options**

- **MBF-5** FLUSH MOUNT KIT  
To mount the transceiver to a panel.
- **MA-500TR/MA-510TR\*** CLASS B AIS TRANSPONDER  
To transmit individual DSC calls to a selected AIS targets.  
\* Unreleased as of August 2020.

# 11 TROUBLESHOOTING

PROBLEM	POSSIBLE CAUSE	SOLUTION	REFERENCE
The transceiver does not turn ON.	<ul style="list-style-type: none"> <li>• Bad connection to the power supply.</li> <li>• The fuse is blown.</li> </ul>	<ul style="list-style-type: none"> <li>• Check the connection to the transceiver and power supply.</li> <li>• Repair the problem, and then replace the fuse.</li> </ul>	<p>p. 53</p> <p>p. 54</p>
Little or no sound comes from the speaker.	<ul style="list-style-type: none"> <li>• Squelch level is set too high.</li> <li>• Volume level is set too low.</li> </ul>	<ul style="list-style-type: none"> <li>• Set the squelch to the threshold point.</li> <li>• Set the volume to a suitable level.</li> </ul>	<p>p. 11</p> <p>p. 11</p>
You cannot transmit with high power.	<ul style="list-style-type: none"> <li>• Some channels are set for low power or receive only by regulations.</li> <li>• The output power is set to low.</li> </ul>	<ul style="list-style-type: none"> <li>• Change channels.</li> <li>• Push [HI/LO] to select high power.</li> </ul>	<p>pp. 9,10</p> <p>p. 6</p>
Scan does not start.	<ul style="list-style-type: none"> <li>• More than 2 favorite channels are not set.</li> </ul>	<ul style="list-style-type: none"> <li>• Set the Favorite channels.</li> </ul>	p. 16
No beep sounds.	<ul style="list-style-type: none"> <li>• The Key Beep function is OFF.</li> </ul>	<ul style="list-style-type: none"> <li>• Turn ON the Key Beep function.</li> </ul>	p. 47
Individual or Group ID cannot be set.	<ul style="list-style-type: none"> <li>• The entered ID code is incorrect. First digit must be set to between '1' and '9' for an Individual ID. First digit must be set to '0' for a Group ID.</li> </ul>	<ul style="list-style-type: none"> <li>• Enter a correct ID code.</li> </ul>	pp. 18, 19
"??" blinks instead of the position and time.	<ul style="list-style-type: none"> <li>• 23.5 hours have passed since you manually entered the position.</li> <li>• The GPS position is invalid.</li> </ul>	<ul style="list-style-type: none"> <li>• Enter the position and time.</li> </ul>	p. 20
"NO POSITION" and "NO TIME" are displayed instead of the position and time.	<ul style="list-style-type: none"> <li>• The GPS signal is not correctly received.</li> <li>• The position and time have not been manually entered.</li> </ul>	<ul style="list-style-type: none"> <li>• Check the GPS antenna connection and position.</li> <li>• Check the NMEA input connection.</li> <li>• Enter the position and time.</li> </ul>	<p>p. 54</p> <p>p. 53</p> <p>p. 20</p>



◇ For IC-M330/IC-M330G and USA channels for IC-M330E/IC-M330GE UK version

Channel number			Frequency (MHz)	
USA	INT	CAN	Transmit	Receive
	01	01	156.050	160.650
1001	1001		156.050	156.050
	02	02	156.100	160.700
	03	03	156.150	160.750
	04		156.200	160.800
		1004	156.200	156.200
	05		156.250	160.850
1005	1005	1005	156.250	156.250
06	06	06	156.300	156.300
	07		156.350	160.950
1007	1007	1007	156.350	156.350
08	08	08	156.400	156.400
09	09	09	156.450	156.450
10	10	10	156.500	156.500
11	11	11	156.550	156.550
12	12	12	156.600	156.600
13* <sup>1</sup>	13	13* <sup>2</sup>	156.650	156.650
14	14	14	156.700	156.700
15* <sup>3</sup>	15* <sup>2</sup>	15* <sup>2</sup>	156.750	156.750
16	16	16	156.800	156.800
17* <sup>2</sup>	17	17* <sup>2</sup>	156.850	156.850
	18		156.900	161.500
1018	1018	1018	156.900	156.900
	19		156.950	161.550
1019	1019	1019	156.950	156.950
	2019		Rx only	161.550
20	20	20* <sup>2</sup>	157.000	161.600
1020	1020		157.000	157.000

Channel number			Frequency (MHz)	
USA	INT	CAN	Transmit	Receive
	2020		Rx only	161.600
	21		157.050	161.650
1021	1021	1021	157.050	157.050
		2021	Rx only	161.650
	22		157.100	161.700
1022	1022	1022	157.100	157.100
	23	23	157.150	161.750
1023	1023		157.150	157.150
		2023	Rx only	161.750
24		24	157.200	161.800
25		25	157.250	161.850
		2025	Rx only	161.850
26		26	157.300	161.900
27	27	27	157.350	161.950
	1027		157.350	157.350
28	28	28	157.400	162.000
	1028		157.400	157.400
		2028	Rx only	162.000
1037* <sup>4</sup>			157.850	157.850
	60	60	156.025	160.625
	61		156.075	160.675
		1061	156.075	156.075
	62		156.125	160.725
		1062	156.125	156.125
	63		156.175	160.775
1063	1063	1063	156.175	156.175
	64	64	156.225	160.825
		1064	156.225	156.225

Channel number			Frequency (MHz)	
USA	INT	CAN	Transmit	Receive
	65		156.275	160.875
1065	1065	1065* <sup>2</sup>	156.275	156.275
	66		156.325	160.925
1066	1066	1066* <sup>2</sup>	156.325	156.325
67* <sup>1</sup>	67	67	156.375	156.375
68	68	68	156.425	156.425
69	69	69	156.475	156.475
71	71	71	156.575	156.575
72	72	72	156.625	156.625
73	73	73	156.675	156.675
74	74	74	156.725	156.725
	75* <sup>2</sup>	75* <sup>2</sup>	156.775	156.775
	76* <sup>2</sup>	76* <sup>2</sup>	156.825	156.825
77* <sup>1</sup>	77	77* <sup>2</sup>	156.875	156.875
	78		156.925	161.525
1078	1078	1078	156.925	156.925
	2078		Rx only	161.525
	79		156.975	161.575
1079	1079	1079	156.975	156.975
	2079		Rx only	161.575
	80		157.025	161.625
1080	1080	1080	157.025	157.025
	81		157.075	161.675
1081	1081	1081	157.075	157.075
	82		157.125	161.725
1082	1082	1082	157.125	157.125
	83		157.175	161.775
1083	1083	1083	157.175	157.175

Channel number			Frequency (MHz)	
USA	INT	CAN	Transmit	Receive
		2083	Rx only	161.775
84		84	157.225	161.825
85		85	157.275	161.875
86		86	157.325	161.925
87	87	87	157.375	157.375
88	88	88	157.425	157.425
P4* <sup>4</sup>			161.425	161.425

WX channel	Frequency (MHz)	
	Transmit	Receive
1	RX only	162.550
2	RX only	162.400
3	RX only	162.475
4	RX only	162.425
5	RX only	162.450
6	RX only	162.500
7	RX only	162.525
8	RX only	161.650
9	RX only	161.775
10	RX only	163.275

**NOTE:** When the “CH Display” setting in the Menu screen is set to “3 Digits,” the channel number is displayed in 3 digits. (For example: “1001” is displayed as “01A.”)

\*<sup>1</sup> Momentary high power. \*<sup>2</sup> Low power only. \*<sup>3</sup> Rx only.  
\*<sup>4</sup> UK Marina Channels: M1=1037, M2=P4 for only the UK version.

# 12 CHANNEL LIST

## ◇ For IC-M330E/IC-M330GE

### ● International channels

CH	Frequency (MHz)		CH	Frequency (MHz)		CH	Frequency (MHz)		CH	Frequency (MHz)		CH	Frequency (MHz)		CH	Frequency (MHz)	
	Transmit	Receive		Transmit	Receive		Transmit	Receive		Transmit	Receive		Transmit	Receive		Transmit	Receive
01	156.050	160.650	13	156.650	156.650	21	157.050	161.650	61	156.075	160.675	73	156.675	156.675	81	157.075	161.675
02	156.100	160.700	14	156.700	156.700	22	157.100	161.700	62	156.125	160.725	74	156.725	156.725	82	157.125	161.725
03	156.150	160.750	15* <sup>1</sup>	156.750	156.750	23	157.150	161.750	63	156.175	160.775	75* <sup>3</sup>	156.775	156.775	83	157.175	161.775
04	156.200	160.800	16	156.800	156.800	24	157.200	161.800	64	156.225	160.825	76* <sup>3</sup>	156.825	156.825	84	157.225	161.825
05	156.250	160.850	17* <sup>1</sup>	156.850	156.850	25	157.250	161.850	65	156.275	160.875	77	156.875	156.875	85	157.275	161.875
06	156.300	156.300	18	156.900	161.500	26	157.300	161.900	66	156.325	160.925	78	156.925	161.525	86	157.325	161.925
07	156.350	160.950	19	156.950	161.550	27	157.350	161.950	67	156.375	156.375	1078	156.925	156.925	87	157.375	157.375
08	156.400	156.400	1019	156.950	156.950	28	157.400	162.000	68	156.425	156.425	2078	Rx only	161.525	88	157.425	157.425
09	156.450	156.450	2019	Rx only	161.550	31* <sup>2</sup>	157.550	157.550	69	156.475	156.475	79	156.975	161.575	P4* <sup>4</sup>	161.425	161.425
10	156.500	156.500	20	157.000	161.600	1037* <sup>4</sup>	157.850	157.850	71	156.575	156.575	1079	156.975	156.975			
11	156.550	156.550	1020	157.000	157.000	60	156.025	160.625	72	156.625	156.625	2079	Rx only	161.575			
12	156.600	156.600	2020	Rx only	161.600							80	157.025	161.625			

\*<sup>1</sup> Channels 15 and 17 may also be used for on-board communications provided the effective radiated power does not exceed 1 W, and subject to the national regulations of the administration concerned when these channels are used in its territorial waters.

\*<sup>2</sup> Low power only, for only the Dutch version.

\*<sup>3</sup> The output power of channels 75 and 76 are limited to low power (1 W) only. The use of these channels should be restricted to navigation-related communications only and all precautions should be taken to avoid harmful interference to channel 16, for example by means geographical separation.

\*<sup>4</sup> UK Marina Channels: M1=1037 (157.850 MHz) for only the UK and Dutch versions, M2=P4 (161.425 MHz) for only the UK version.

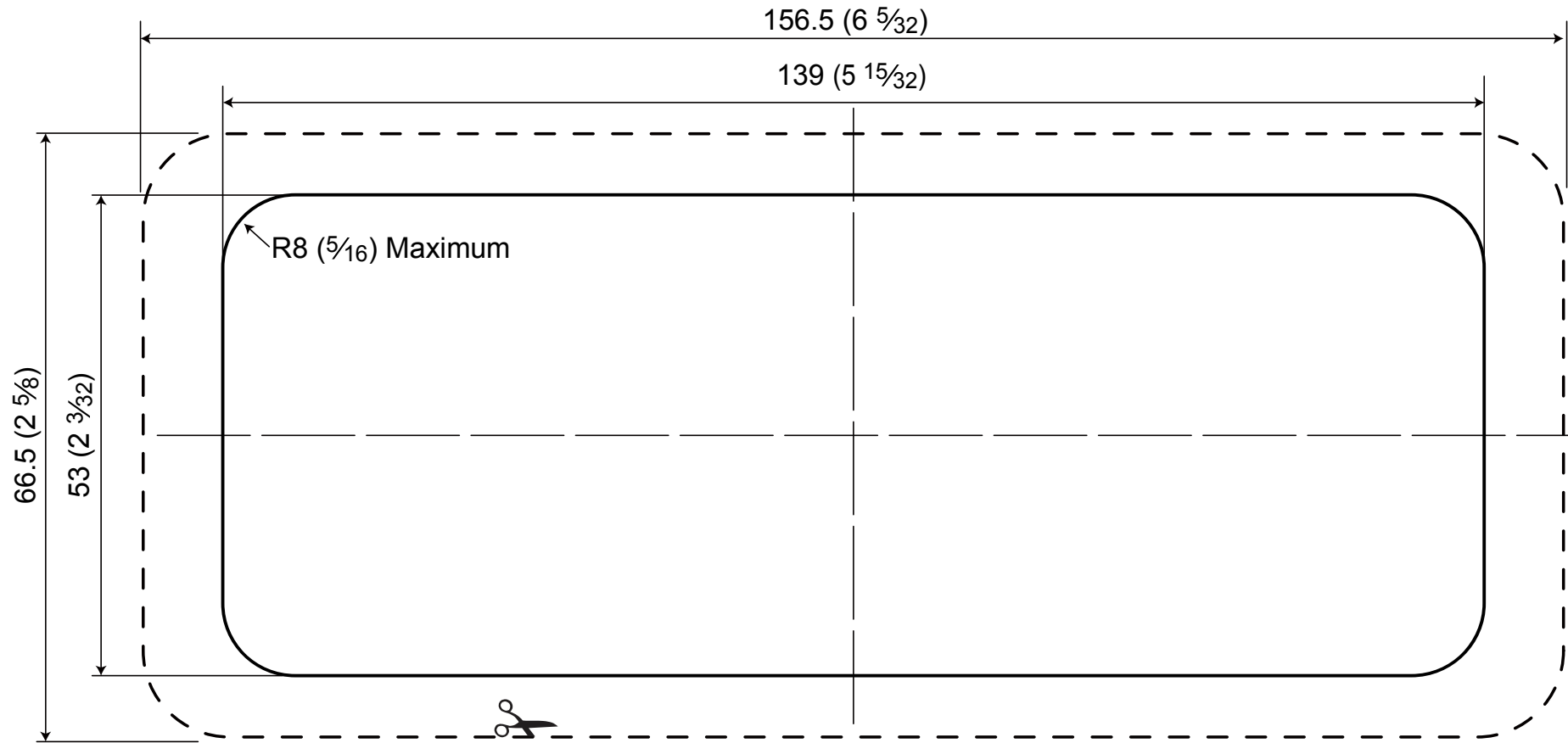

12  
13

Unit: mm (inch)



## ■ About CE and DOC

 Hereby, Icom Inc. declares that the versions of IC-M330E/IC-M330GE which have the “CE” symbol on the product, comply with the essential requirements of the Radio Equipment Directive, 2014/53/EU, and the restriction of the use of certain hazardous substances in electrical and electronic equipment Directive, 2011/65/EU. The full text of the EU declaration of conformity is available at the following internet address:  
<https://www.icomjapan.com/support/>

## ■ Disposal

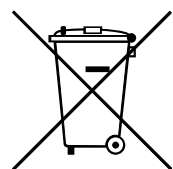
 The crossed-out wheeled-bin symbol on your product, literature, or packaging reminds you that in the European Union, all electrical and electronic products, batteries, and accumulators (rechargeable batteries) must be taken to designated collection locations at the end of their working life. Do not dispose of these products as unsorted municipal waste. Dispose of them according to the laws in your area.

# INDEX

<b>A</b>		Cleaning .....	55	<b>G</b>	
Alarm Status (DSC Settings).....	43	Connections.....	53	GPS, antenna.....	54
All Ships call		Contrast.....	12	Group call	
Receiving .....	35	<b>D</b>		Receiving .....	34
Sending.....	27	Dimensions.....	59	Sending.....	28
Antenna .....	55	Display Contrast, Configuration.....	49	Group ID	
AquaQuake.....	14	Distress call		Deleting.....	19
ATIS ID .....	8	Cancel call .....	23	DSC setting.....	42
Auto ACK (DSC Settings).....	42	Receiving .....	32	Entering.....	19
<b>B</b>		Regular call .....	22	<b>I</b>	
Backlight .....	12	Sending.....	21	ICONS .....	3
Backlight, Configuration.....	49	Simple call.....	21	Inactivity Timer, Configuration .....	49
<b>C</b>		DSC		Individual Acknowledgement	
Call channel		Address ID .....	18	Sending.....	25
Radio Settings.....	51	Log, Received .....	38	Individual call	
Selecting .....	9	Log, transmitted .....	39	Receiving .....	33
Setting.....	12	Settings .....	42	Sending.....	24
CH 70 SQL Level, DSC Settings ....	43	DSC data output.....	43	Individual ID	
Channel		Dual/Tri-watch, Radio Settings .....	50	Deleting.....	19
Group .....	10	Dualwatch.....	17	DSC Settings .....	42
Name, editing.....	14	<b>F</b>		Entering.....	18
Selecting .....	9	Favorite channels .....	16	<b>K</b>	
Channel 16.....	9	FAV Settings, Radio Settings.....	51	Key Assignment, Configuration .....	49
Channel list.....	61	Front panel .....	2	Key Beep, Configuration.....	49
CH Auto Switch, DSC Settings .....	42	Function display.....	3	<b>L</b>	
CH Close-up, Radio settings .....	52	Fuse replacement.....	55	Lock function .....	13
CH Display, Radio settings .....	52				

<b>M</b>		<b>S</b>		<b>U</b>	
MBF-5 installation.....	57	Scan		UTC Offset, Configuration .....	49
Menu screen		Normal .....	15	<b>V</b>	
Items .....	48	Priority .....	15	Volume level .....	11
Using .....	47	Starting.....	16	<b>W</b>	
Microphone.....	6	Types .....	15	Weather Alert.....	10
MMSI code, entering .....	7	Scan Timer, Radio Settings .....	50	Weather channels.....	10
Mounting the transceiver .....	56	Scan Type, Radio Settings .....	50	WX Alert, Radio Settings .....	51
Multiple-task .....	40	Self test (DSC Settings).....	44		
<b>O</b>		Simple call, Distress call.....	21		
Options .....	59	Software keys .....	4		
<b>P</b>		Specifications .....	58		
Panel description.....	2	Squelch level .....	11		
Position		Supplied accessories.....	55		
Entering.....	20	<b>T</b>			
Input (DSC Settings).....	42	Template .....	63		
Reply call, sending.....	31	Test Acknowledgement			
Request call, receiving .....	36	Receiving .....	38		
Request call, sending.....	30	Sending.....	30		
Precautions.....	vii	Test call			
Procedure (DSC Settings).....	44	Receiving .....	37		
<b>R</b>		Sending.....	29		
Radio Info .....	52	Time, entering.....	20		
Receiving.....	13	Transmitting .....	13		
		Tri-watch.....	17		
		Troubleshooting.....	60		

**Count on us!**

A7420D-1EX-5  
Printed in Japan  
© 2017–2020 Icom Inc. Aug. 2020

**Icom Inc.**  
1-1-32 Kamiminami, Hirano-ku, Osaka 547-0003, Japan