

# ENGINEERING TEST REPORT

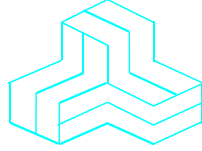

**VHF/UHF DUAL BAND Transceiver**  
**Model: ID-4100A**  
**FCC ID: AFJ386600**

*Applicant:*

**ICOM Incorporated**  
1-1-32, Kamiminami, Hirano-ku  
Osaka, Japan, 547-0003

**Tested in Accordance With**

**Federal Communications Commission (FCC)**  
**47 CFR, Part 15, Subpart B, Scanning Receivers**

**UltraTech's File No.: 17ICOM449\_FCC15B121**

This Test report is Issued under the Authority of  
Tri M. Luu  
Vice President of Engineering  
UltraTech Group of Labs

Date: March 30, 2017

Report Prepared by: Santhosh Fernandez

Tested by: Wei Wu

Issued Date: March 30, 2017

Test Date(s): March 10-27, 2017

- *The results in this Test Report apply only to the sample(s) tested, and the sample tested is randomly selected.*
- *This report must not be used by the client to claim product endorsement by any agency of the US Government.*

## UltraTech

3000 Bristol Circle, Oakville, Ontario, Canada, L6H 6G4  
Tel.: (905) 829-1570 Fax.: (905) 829-8050

Website: [www.ultratech-labs.com](http://www.ultratech-labs.com), Email: [vic@ultratech-labs.com](mailto:vic@ultratech-labs.com), Email: [tri@ultratech-labs.com](mailto:tri@ultratech-labs.com)



91038



1309



46390-2049



AT-1945



SL2-IN-E-  
1119R



Korea  
KCC-RRA

CA2049

**TABLE OF CONTENTS**

**EXHIBIT 1. INTRODUCTION ..... 1**

1.1. SCOPE..... 1

1.2. RELATED SUBMITTAL(S)/GRANT(S)..... 1

1.3. NORMATIVE REFERENCES ..... 1

**EXHIBIT 2. PERFORMANCE ASSESSMENT ..... 2**

2.1. CLIENT INFORMATION ..... 2

2.2. EQUIPMENT UNDER TEST (EUT) INFORMATION ..... 2

2.3. EUT’S TECHNICAL SPECIFICATIONS ..... 3

2.4. LIST OF EUT’S PORTS ..... 3

2.5. ANCILLARY EQUIPMENT ..... 3

**EXHIBIT 3. EUT OPERATING CONDITIONS AND CONFIGURATIONS DURING TESTS ..... 4**

3.1. CLIMATE TEST CONDITIONS ..... 4

3.2. OPERATIONAL TEST CONDITIONS & ARRANGEMENT FOR TEST SIGNALS ..... 4

**EXHIBIT 4. SUMMARY OF TEST RESULTS ..... 5**

4.1. LOCATION OF TESTS ..... 5

4.2. APPLICABILITY & SUMMARY OF EMC EMISSION TEST RESULTS ..... 5

4.3. MODIFICATIONS REQUIRED FOR COMPLIANCE ..... 5

**EXHIBIT 5. TEST DATA ..... 6**

5.1. POWER LINE CONDUCTED EMISSIONS [§ 15.107(A)]..... 6

5.2. RECEIVER ANTENNA POWER SPURIOUS/HARMONIC CONDUCTED EMISSIONS [§ 15.111(A)] ..... 9

5.3. SPURIOUS/HARMONIC RADIATED EMISSIONS FROM RECEIVER AND CLASS B UNINTENTIONAL RADIATORS (DIGITAL DEVICES) [§ 15.109(A)]..... 16

5.4. REQUIREMENTS FOR SCANNING RECEIVERS [§ 15.121]..... 20

5.5. SCANNING RECEIVERS CELLULAR BAND REJECTION [§ 15.121(B)] ..... 23

**EXHIBIT 6. TEST EQUIPMENTS LIST ..... 26**

**EXHIBIT 7. MEASUREMENT UNCERTAINTY..... 27**

7.1. LINE CONDUCTED EMISSION MEASUREMENT UNCERTAINTY ..... 27

7.2. RADIATED EMISSION MEASUREMENT UNCERTAINTY ..... 27

## EXHIBIT 1. INTRODUCTION

### 1.1. SCOPE

<b>Reference:</b>	FCC Part 15, Subpart B, Sections 15.107, 15.109, 15.111 & 15.121
<b>Title:</b>	Code of Federal Regulations (CFR), Title 47, Telecommunication, Part 15
<b>Purpose of Test:</b>	To gain FCC Certification Authorization for Scanning Receivers
<b>Test Procedures:</b>	Both conducted and radiated emissions measurements were conducted in accordance with American National Standards Institute ANSI C63.4 - American National Standard for Methods of Measurement of Radio-Noise Emissions from Low-Voltage Electrical and Electronic Equipment in the Range of 9 kHz to 40 GHz
<b>Environmental Classification:</b>	Residential, Commercial, Industrial or Business environment

### 1.2. RELATED SUBMITTAL(S)/GRANT(S)

None

### 1.3. NORMATIVE REFERENCES

Publication	Year	Title
FCC CFR Parts 0-19	2016	Code of Federal Regulations – Telecommunication
ANSI C63.4	2014	American National Standard for Methods of Measurement of Radio-Noise Emissions from Low-Voltage Electrical and Electronic Equipment in the Range of 9 kHz to 40 GHz
ANSI C63.10	2013	American National Standard for Testing Unlicensed Wireless Devices
TIA/EIA 603, Edition D	2010	Land Mobile FM or PM Communications Equipment Measurement and Performance Standards

---

**ULTRATECH GROUP OF LABS**

3000 Bristol Circle, Oakville, Ontario, Canada L6H 6G4  
Tel. #: 905-829-1570, Fax. #: 905-829-8050, Email: [vic@ultratech-labs.com](mailto:vic@ultratech-labs.com), Website: <http://www.ultratech-labs.com>

File #: 17ICOM449\_FCC15B121

March 30, 2017

All test results contained in this engineering test report are traceable to National Institute of Standards and Technology (NIST)

## EXHIBIT 2. PERFORMANCE ASSESSMENT

### 2.1. CLIENT INFORMATION

APPLICANT	
<b>Name:</b>	Icom Incorporated
<b>Address:</b>	1-1-32, Kamiminami, Hirano-ku, Osaka Japan 547-0003
<b>Contact Person:</b>	Mr. Hideji Fujishima Phone #: +81-66-793-8424 Fax #: +81-66-793-3336 Email Address: <a href="mailto:world_support@icom.co.jp">world_support@icom.co.jp</a>

MANUFACTURER	
<b>Name:</b>	Icom Incorporated
<b>Address:</b>	1-1-32, Kamiminami Hirano-ku, Osaka Japan 547-0003
<b>Contact Person:</b>	Mr. Hideji Fujishima Phone #: +81-66-793-8424 Fax #: +81-66-793-3336 Email Address: <a href="mailto:world_support@icom.co.jp">world_support@icom.co.jp</a>

### 2.2. EQUIPMENT UNDER TEST (EUT) INFORMATION

The following information (with the exception of the Date of Receipt) has been supplied by the applicant.

<b>Brand Name:</b>	ICOM Incorporated
<b>Product Name:</b>	VHF/UHF DUAL BAND Transceiver
<b>Model Name or Number:</b>	ID-4100A
<b>Serial Number:</b>	00000304
<b>Type of Equipment:</b>	Amateur Transmitter & Scanning Receiver
<b>Power Input Source:</b>	13.8 VDC

**2.3. EUT'S TECHNICAL SPECIFICATIONS**

Receiver	
Equipment Type:	Mobile
Power Supply Requirement:	13.8 VDC
Operating Frequency Range:	118-174 MHz, 230-550 MHz
RF Input Impedance:	50 Ω

**2.4. LIST OF EUT'S PORTS**

Port Number	EUT's Port Description	Number of Identical Ports	Connector Type	Cable Type (Shielded/Non-shielded)
1	Microphone	1	RJ-45	Non-Shielded
2	DC Power [DC 13.8V]	1	2 wires	Non-Shielded
3	Antenna Connector [ANT]	1	PL-259	Shielded
4	Controller	1	RJ11	Non-Shielded
5	External Speaker [EXT-SP]	1	3.5mm Mini Jack	Non-Shielded
6	Data Jack	1	2.5mm Mini Jack	Non-Shielded

**2.5. ANCILLARY EQUIPMENT**

The EUT was tested while connected to the following representative configuration of ancillary equipment necessary to exercise the ports during tests:

Ancillary Equipment # 1	
Description:	External Microphone
Brand name:	ICOM
Model Name or Number:	HM-207S

Ancillary Equipment # 2	
Description:	External Speakers
Brand name:	ICOM
Model Name or Number:	SP-35L

### EXHIBIT 3. EUT OPERATING CONDITIONS AND CONFIGURATIONS DURING TESTS

#### 3.1. CLIMATE TEST CONDITIONS

The climate conditions of the test environment are as follows:

Temperature:	21 - 24°C
Humidity:	25 - 45%
Pressure:	101 -102 kPa
Power input source:	13.8 VDC

#### 3.2. OPERATIONAL TEST CONDITIONS & ARRANGEMENT FOR TEST SIGNALS

<b>Operating Modes:</b>	The receiver was operated in the normal intended mode during testing
<b>Special Test Software:</b>	None
<b>Special Hardware Used:</b>	None
<b>Receiver Test Antenna:</b>	The EUT was tested with its antenna port terminated to 50Ω

Receiver Test Signals	
<b>Frequency Band(s):</b>	118-174 MHz 230 MHz- 550 MHz
<b>Test Frequency(ies):</b> (Near lowest, near middle & near highest frequencies in the frequency range of operation.)	118 MHz, 144 MHz and 174 MHz 230 MHz, 430 MHz and 550 MHz

## EXHIBIT 4. SUMMARY OF TEST RESULTS

### 4.1. LOCATION OF TESTS

All of the measurements described in this report were performed at Ultratech Group of Labs located in the city of Oakville, Province of Ontario, Canada.

- AC Power Line Conducted Emissions were performed in UltraTech's shielded room, 24'(L) by 16'(W) by 8'(H).

Radiated Emissions were performed at the Ultratech's 3-10 TDK Semi-Anechoic Chamber situated in the Town of Oakville, province of Ontario. This test site been calibrated in accordance with ANSI C63.4, and found to be in compliance with the requirements of Sec. 2.948 of the FCC Rules. The descriptions and site measurement data of the Oakville 3-10 TDK Semi-Anechoic Chamber has been filed with FCC office (FCC File No.: 91038) and Industry Canada office (Industry Canada File No.: 2049A-3, Expiry Date: 2020-03-27).

### 4.2. APPLICABILITY & SUMMARY OF EMC EMISSION TEST RESULTS

FCC Part 15, Subpart B	Test Requirements	Compliance (Yes/No)
15.107(a), Class B	Power Line Conducted Emissions Measurements	Yes
15.111(a)	Receiver Antenna Power Conducted Emissions for Non-Integral Antenna Port	Yes
15.109(a)	Radiated Emissions from Scanning Receivers & Class B Digital Device	Yes
15.121	Requirements for Scanning Receivers	Yes

### 4.3. MODIFICATIONS REQUIRED FOR COMPLIANCE

None.

**EXHIBIT 5. TEST DATA**

**5.1. POWER LINE CONDUCTED EMISSIONS [§ 15.107(a)]**

**5.1.1. Limits**

The equipment shall meet the limits of the following table:

Frequency of Emissions (MHz)	Class B Conducted Limit (dBμV)	
	Quasi-Peak	Average
0.15 to 0.5	66 to 56*	56 to 46*
0.5 to 5	56	46
5 to 30	60	50

\* Decreasing linearly with logarithm of frequency

**5.1.2. Method of Measurements**

Refer to Ultratech Test Procedures ULTR-P001-200 & ANSI C63.4 for method of measurements.

**5.1.3. Test Arrangement**

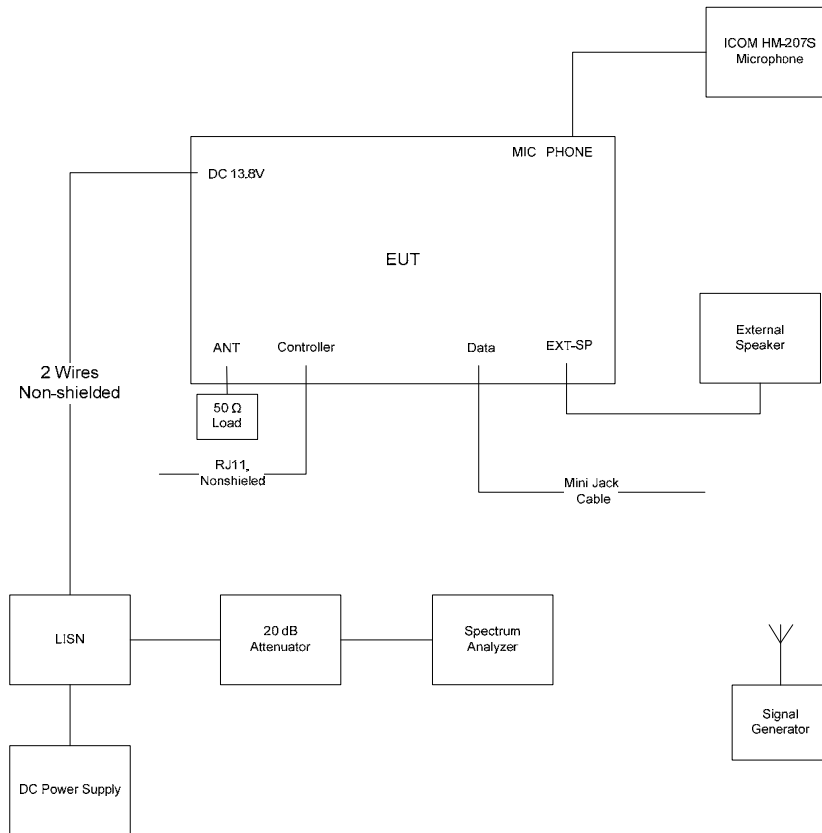



5.1.4. Test Data

Plot 5.1.4.1. Power Line Conducted Emissions; Line Voltage: 13.8 VDC; Line Tested: Positive

Description: DC 13.8V.  
 Setup Name: FCC 15 Class B  
 Customer Name: ICOM  
 Project Number: ICOM-449Q  
 Operator Name: wei  
 EUT Name: ID-4100

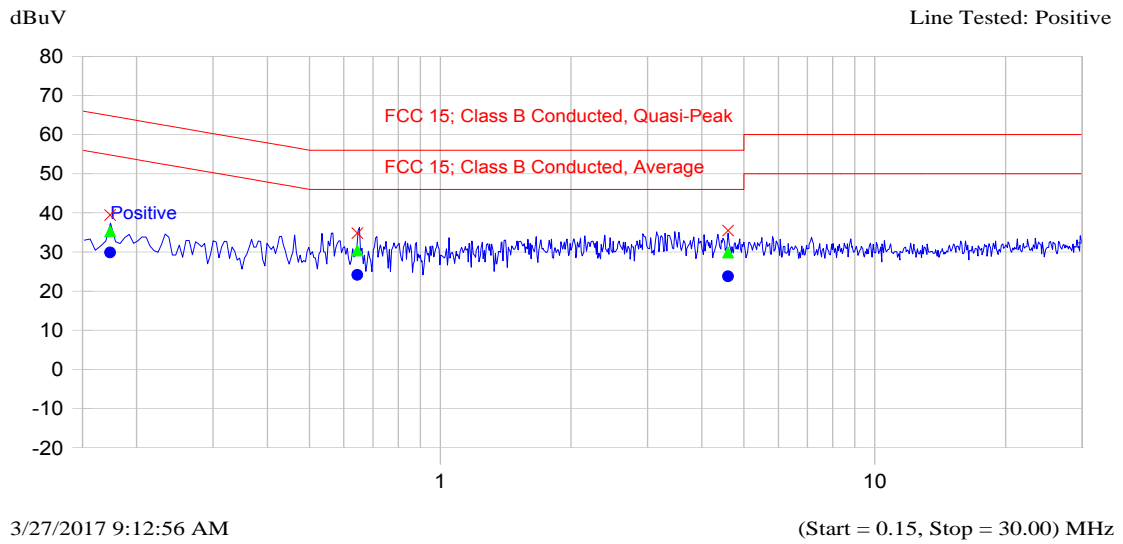

Frequency MHz	Peak dBuV	QP dBuV	QP-QP Limit dB	Avg dBuV	Avg-Avg Limit dB	Trace Name
0.174	39.4	35.3	-29.5	29.9	-24.9	Positive
0.645	34.8	30.4	-25.6	24.2	-21.8	Positive
4.597	35.5	29.9	-26.1	23.8	-22.2	Positive

Plot 5.1.4.2. Power Line Conducted Emissions; Line Voltage: 13.8 VDC; Line Tested: Negative

Description: DC 13.8V.  
 Setup Name: FCC 15 Class B  
 Customer Name: ICOM  
 Project Number: ICOM-449Q  
 Operator Name: wei  
 EUT Name: ID-4100

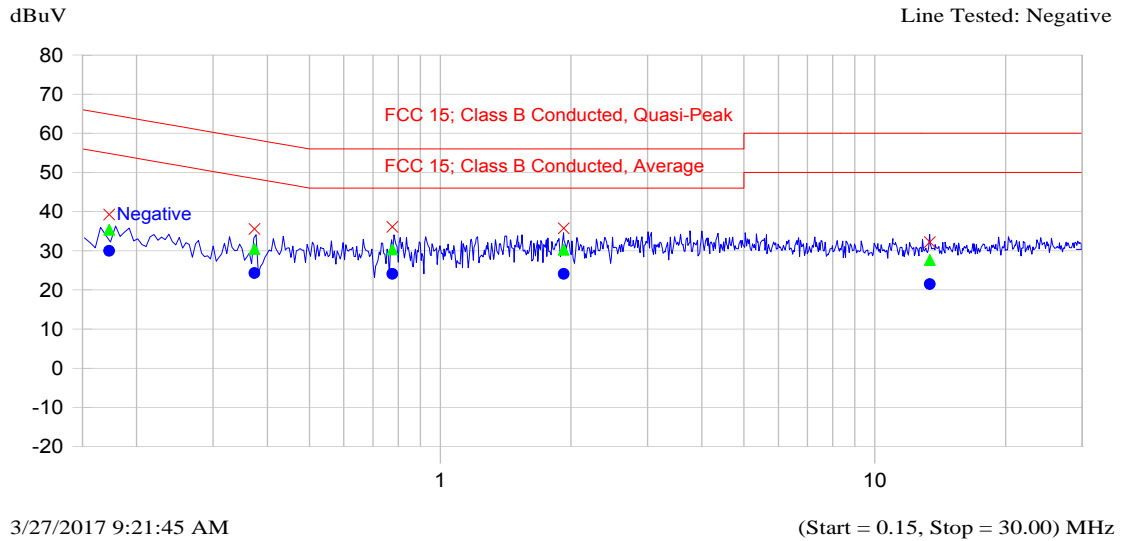

Frequency MHz	Peak dBuV	QP dBuV	QP-QP Limit dB	Avg dBuV	Avg-Avg Limit dB	Trace Name
0.173	39.3	35.3	-29.5	30.0	-24.9	Negative
0.374	35.6	30.5	-27.9	24.3	-24.1	Negative
0.776	36.1	30.3	-25.7	24.1	-21.9	Negative
1.923	35.7	30.3	-25.7	24.1	-21.9	Negative
13.383	32.2	27.6	-32.4	21.5	-28.5	Negative

## 5.2. RECEIVER ANTENNA POWER SPURIOUS/HARMONIC CONDUCTED EMISSIONS [§15.111(a)]

### 5.2.1. Limits

Receivers that operate (tune) in the frequency range 30 to 960 MHz and CB receivers that provides terminals for the connection of an external antenna may be tested to demonstrate compliance with the provisions of @ 15.109 with the antenna terminals shielded and terminated with a resistive termination equal to the impedance specified for the antenna, provided these receivers also comply with the following:- With the receiver antenna terminal connected to a resistive termination equal to the impedance specified or employed for the antenna, the power at the antenna terminal at frequency within the range from 30 MHz to 5<sup>th</sup> harmonic of the highest frequency shall not exceed 2.0 nanowatts (or -57 dBm @ 50 Ohm).

### 5.2.2. Method of Measurements

Refer to Ultratech Test Procedures ULTR-P001-200 & ANSI C63.4 for method of measurements.

The spectrum shall be investigated from the lowest radio frequency signal generated or used in the device, without going below the lowest frequency for which the emission limit is specified, up to 5<sup>th</sup> harmonic of the highest frequency

### 5.2.3. Test Arrangement

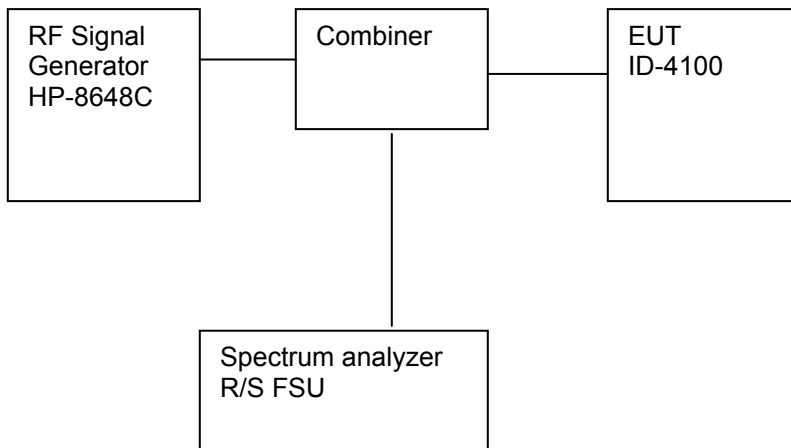

### 5.2.4. Test Data

The emissions were scanned from 30 MHz to 5<sup>th</sup> harmonic at the Receiver antenna port.

Plot 5.2.4.1. Receiver Antenna Power Conducted Emissions, 118 MHz

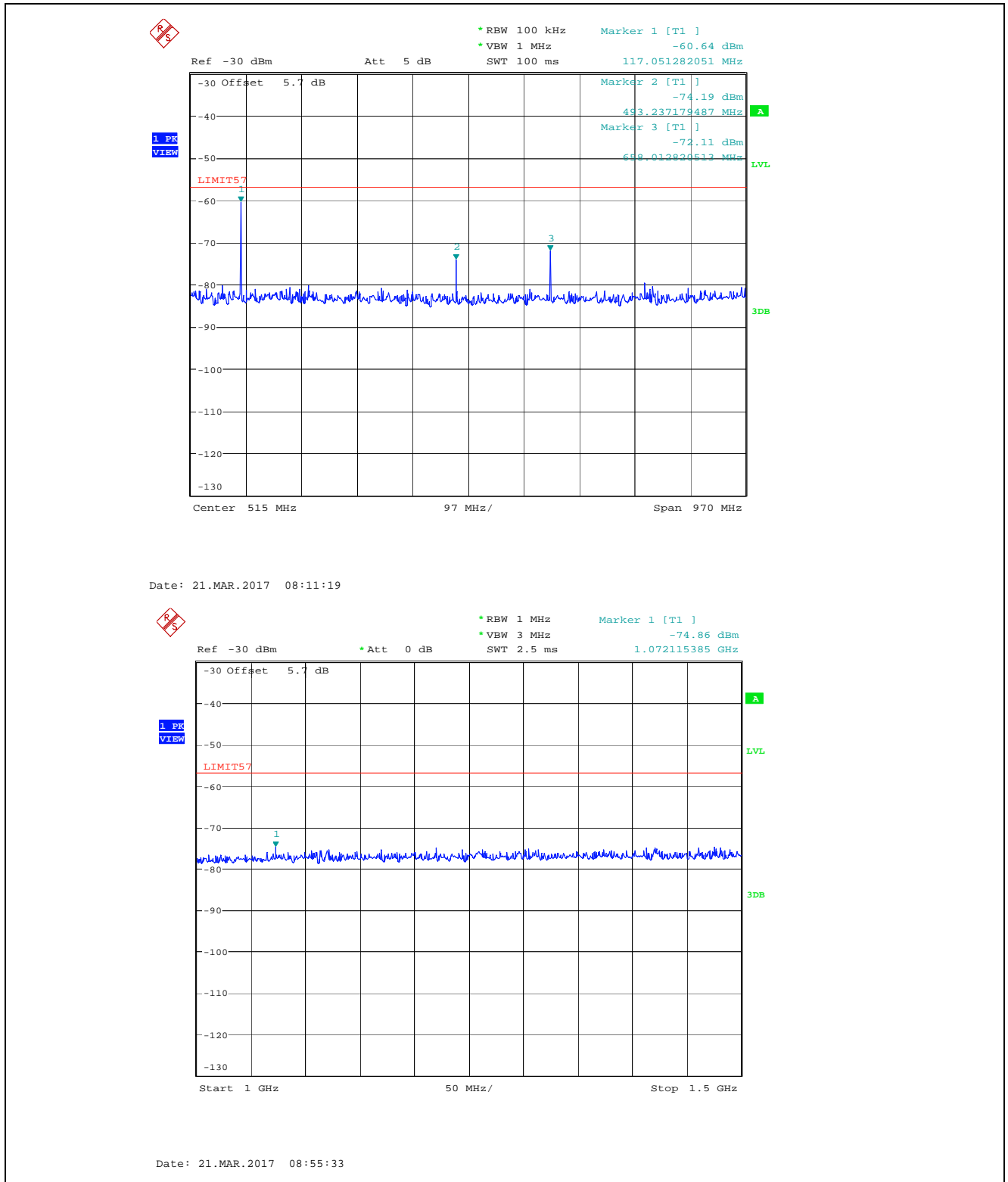

**ULTRATECH GROUP OF LABS**

3000 Bristol Circle, Oakville, Ontario, Canada L6H 6G4  
 Tel. #: 905-829-1570, Fax. #: 905-829-8050, Email: [vic@ultratech-labs.com](mailto:vic@ultratech-labs.com), Website: <http://www.ultratech-labs.com>

File #: 17ICOM449\_FCC15B121

March 30, 2017

All test results contained in this engineering test report are traceable to National Institute of Standards and Technology (NIST)

Plot 5.2.4.2. Receiver Antenna Power Conducted Emissions, 144 MHz

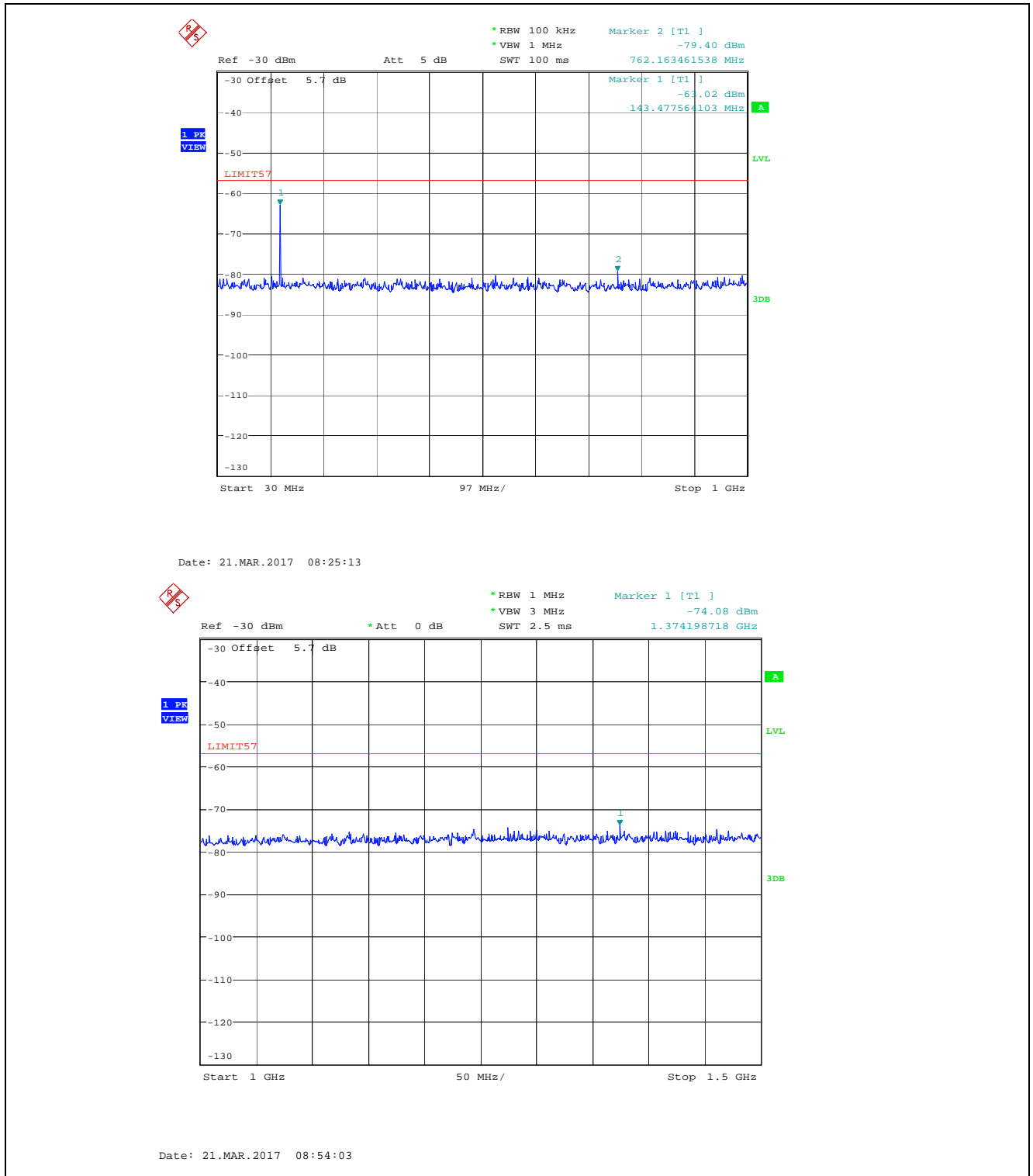

Plot 5.2.4.3. Receiver Antenna Power Conducted Emissions, 174 MHz

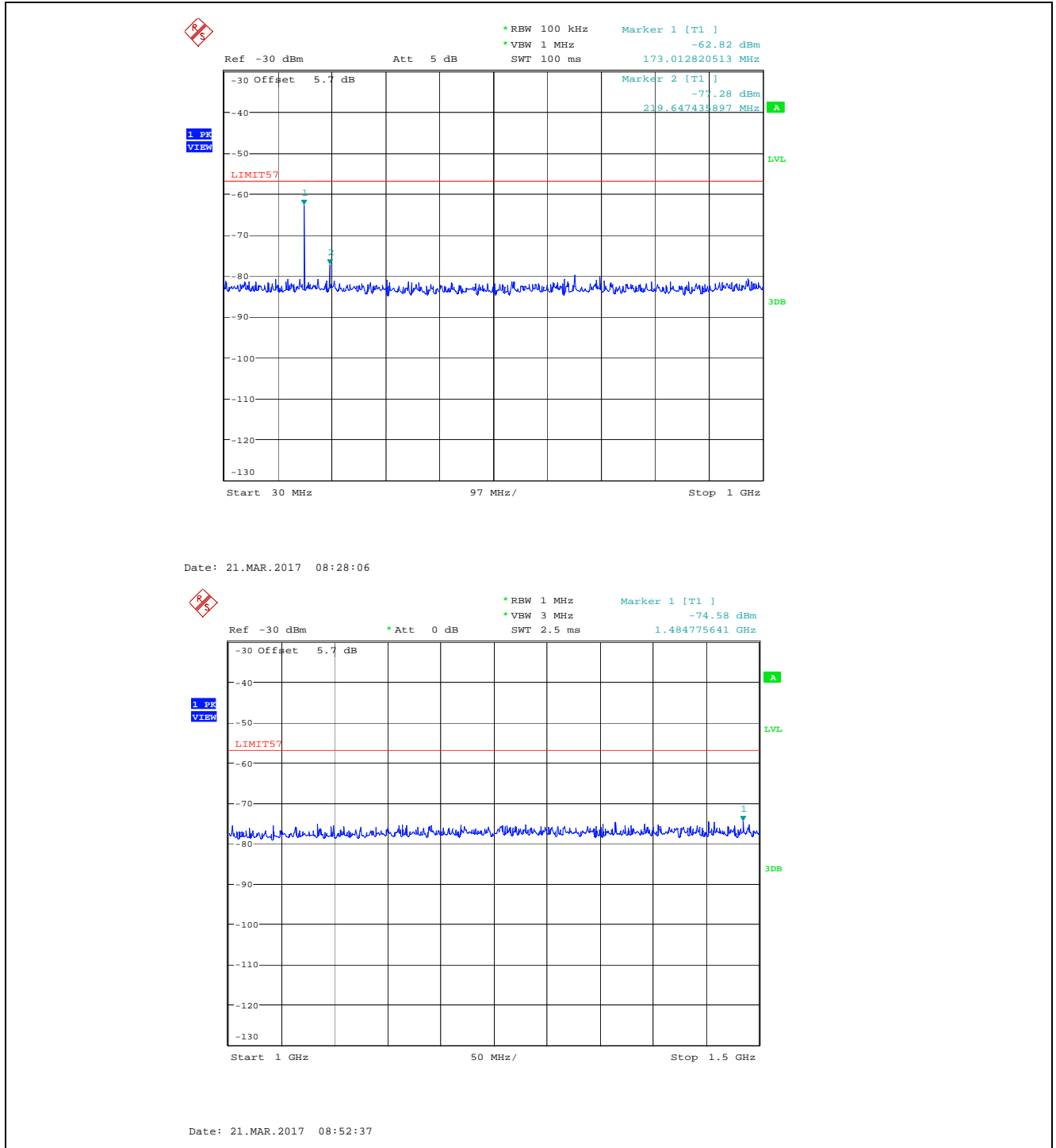

**ULTRATECH GROUP OF LABS**

3000 Bristol Circle, Oakville, Ontario, Canada L6H 6G4  
 Tel. #: 905-829-1570, Fax. #: 905-829-8050, Email: [vic@ultratech-labs.com](mailto:vic@ultratech-labs.com), Website: <http://www.ultratech-labs.com>

File #: 17ICOM449\_FCC15B121

March 30, 2017

All test results contained in this engineering test report are traceable to National Institute of Standards and Technology (NIST)

Plot 5.2.4.4. Receiver Antenna Power Conducted Emissions, 230 MHz

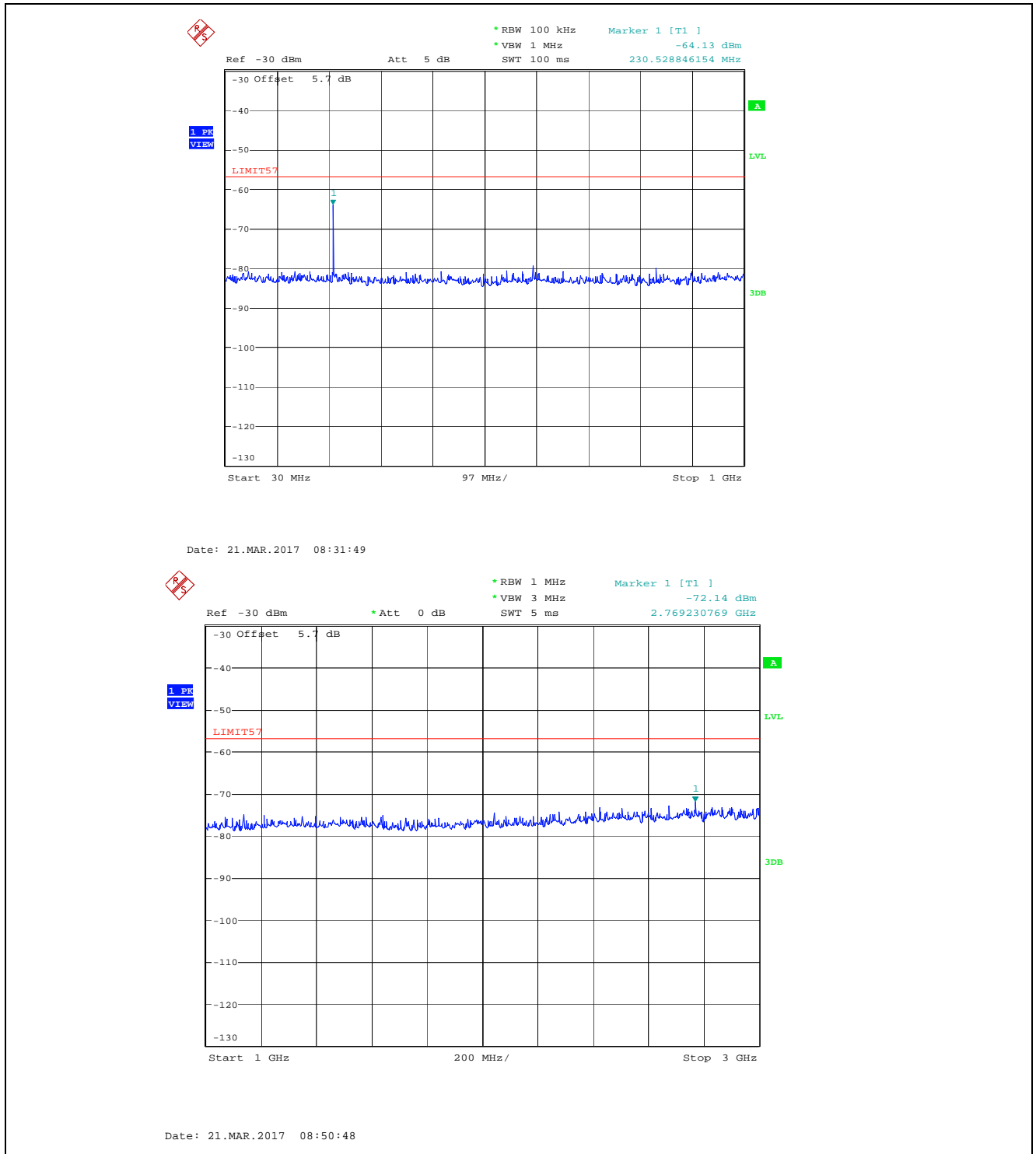

Plot 5.2.4.5. Receiver Antenna Power Conducted Emissions, 430 MHz

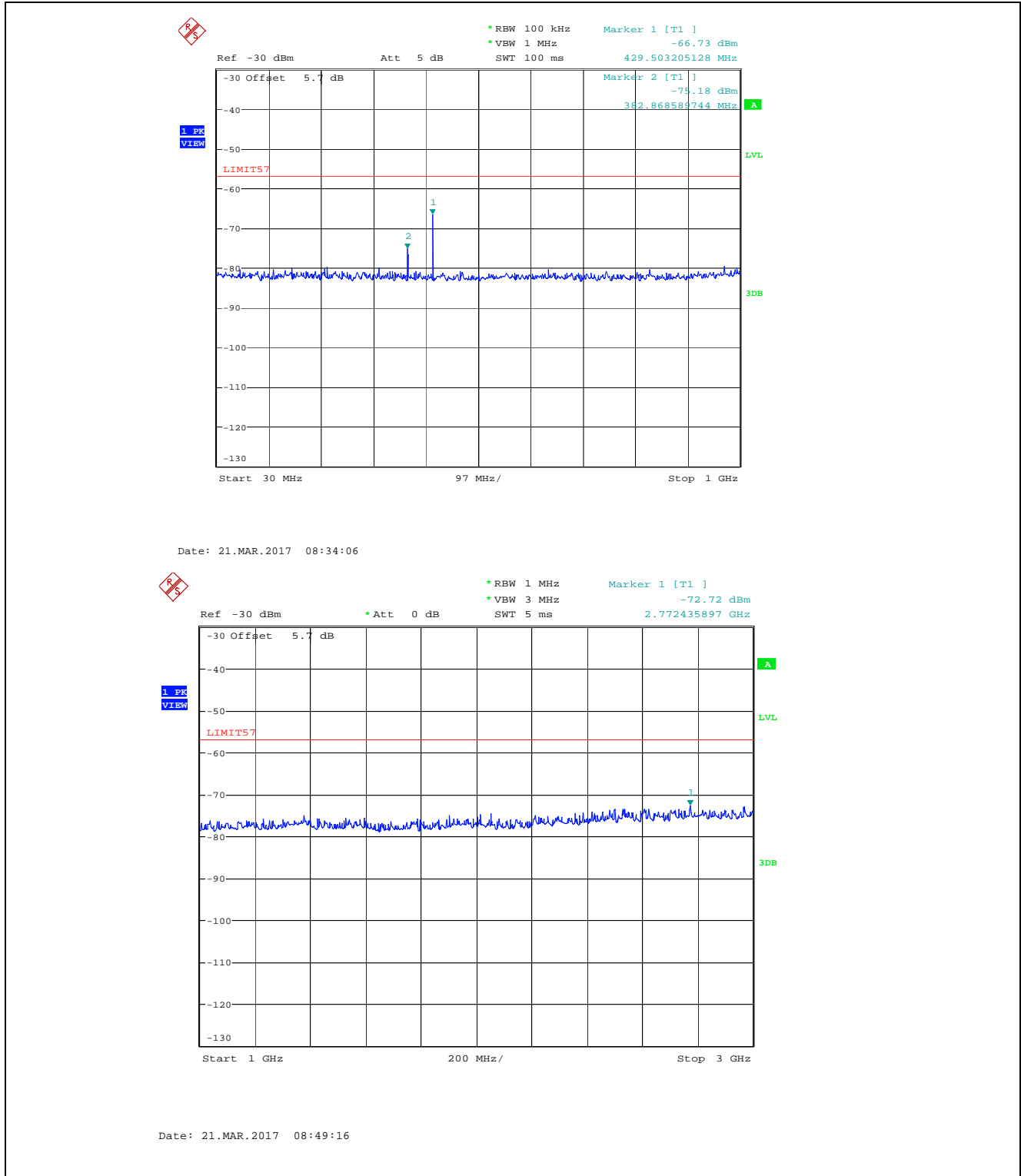



Plot 5.2.4.6. Receiver Antenna Power Conducted Emissions, 550 MHz

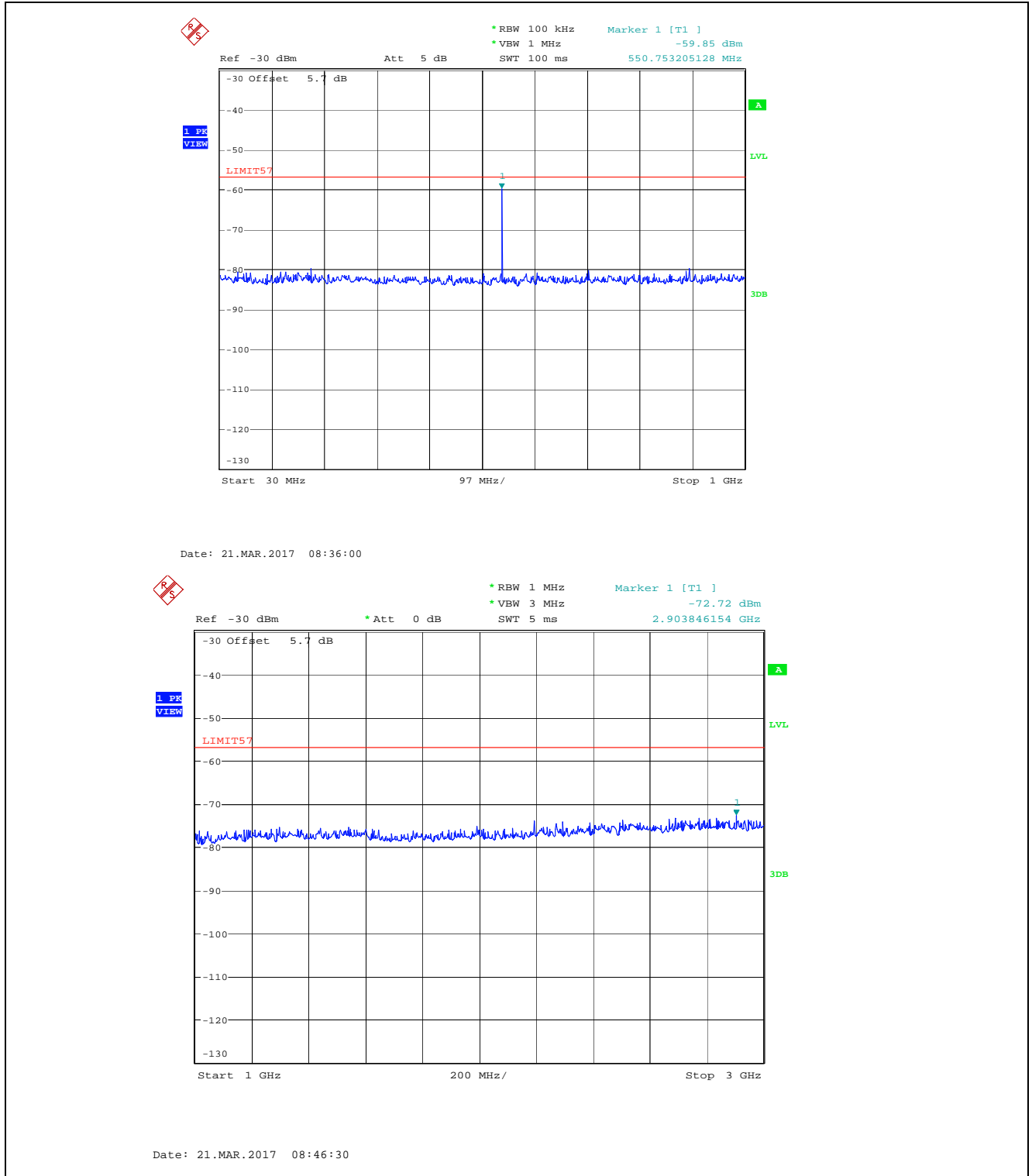

**ULTRATECH GROUP OF LABS**

3000 Bristol Circle, Oakville, Ontario, Canada L6H 6G4

Tel. #: 905-829-1570, Fax. #: 905-829-8050, Email: [vic@ultratech-labs.com](mailto:vic@ultratech-labs.com), Website: <http://www.ultratech-labs.com>

File #: 17ICOM449\_FCC15B121

March 30, 2017

All test results contained in this engineering test report are traceable to National Institute of Standards and Technology (NIST)

**5.3. SPURIOUS/HARMONIC RADIATED EMISSIONS FROM RECEIVER AND CLASS B UNINTENTIONAL RADIATORS (DIGITAL DEVICES) [§ 15.109(a)]**

**5.3.1. Limits**

The equipment shall meet the limits of the following table:

Test Frequency Range (MHz)	Class B Limits @ 3 m (dBµV/m)
30 – 88	40.0
88 – 216	43.5
216 – 960	46.0
Above 960	54.0

**5.3.2. Method of Measurements**

Refer to Ultratech Test Procedures ULTR-P001-200 & ANSI C63.4 for method of measurements.

The spectrum shall be investigated from the lowest radio frequency signal generated or used in the device, without going below the lowest frequency for which a radiated emission limit is specified, up to the frequency shown in the following table:

Highest frequency generated or used in the device or on which the device operates or tunes (MHz)	Upper frequency of measurement range (MHz)
Below 1.705	30
1.705 - 108	1000
108 – 500	2000
500 -1000	5000
Above 1000	5 <sup>th</sup> harmonic of the highest frequency or 40 GHz, whichever is lower

### 5.3.3. Test Arrangement

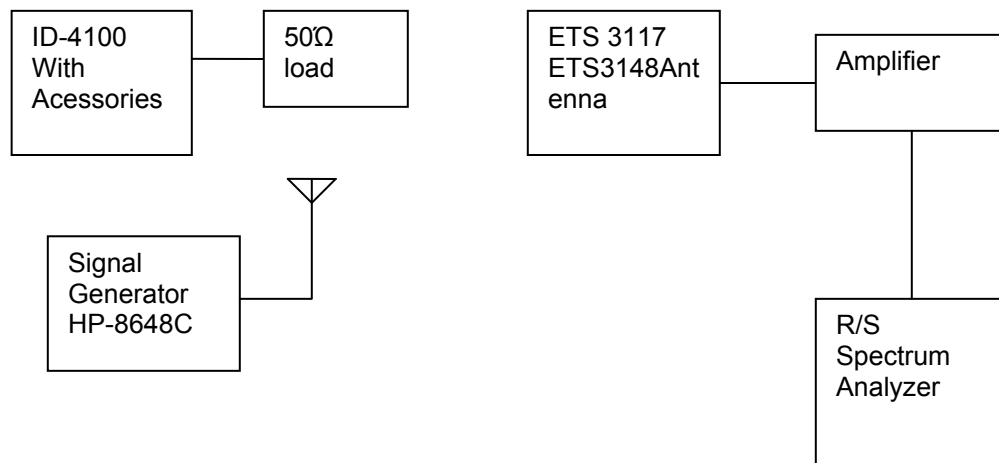

### 5.3.4. Test Data

Remarks:

- The measuring receiver shall be tuned over the frequency range 30 MHz to 6GHz @ 3m.
- All spurious emissions that are in excess of 20 dB below the specified limit shall be recorded.

**5.3.4.1. Lowest Frequency (118.0 MHz, IF=46.35 MHz)**

Frequency (MHz)	RF Level (dBµV/m)	Detector Used (Peak/QP/Avg)	Antenna Plane (H/V)	Limit (dBµV/m)	Margin (dB)	Pass/Fail
30 - 6000	*	Peak	V/H	*	*	Pass

\*All receiver spurious emissions are more than 20 dB below the limit.

**5.3.4.2. Near Middle Frequency (144.0 MHz, IF=46.35 MHz)**

Frequency (MHz)	RF Level (dBµV/m)	Detector Used (Peak/QP/Avg)	Antenna Plane (H/V)	Limit (dBµV/m)	Margin (dB)	Pass/Fail
30 - 6000	*	Peak	V/H	*	*	Pass

\*All receiver spurious emissions are more than 20 dB below the limit.

**5.3.4.3. Highest Frequency (174.0 MHz, IF=46.35 MHz)**

Frequency (MHz)	RF Level (dBµV/m)	Detector Used (Peak/QP/Avg)	Antenna Plane (H/V)	Limit (dBµV/m)	Margin (dB)	Pass/Fail
30 - 6000	*	Peak	V/H	*	*	Pass

\*All receiver spurious emissions are more than 20 dB below the limit.

**5.3.4.4. Highest Frequency (230.0 MHz, IF=46.35 MHz)**

Frequency (MHz)	RF Level (dBµV/m)	Detector Used (Peak/QP/Avg)	Antenna Plane (H/V)	Limit (dBµV/m)	Margin (dB)	Pass/Fail
30 - 6000	*	Peak	V/H	*	*	Pass

\*All receiver spurious emissions are more than 20 dB below the limit.

**5.3.4.5. Lowest Frequency (430.0 MHz, IF=46.35 MHz)**

Frequency (MHz)	RF Level (dBµV/m)	Detector Used (Peak/QP/Avg)	Antenna Plane (H/V)	Limit (dBµV/m)	Margin (dB)	Pass/Fail
30 - 6000	*	Peak	V/H	*	*	Pass

\*All receiver spurious emissions are more than 20 dB below the limit.

**5.3.4.6. Near Middle Frequency (550.0 MHz, IF=46.35 MHz)**

Frequency (MHz)	RF Level (dBµV/m)	Detector Used (Peak/QP/Avg)	Antenna Plane (H/V)	Limit (dBµV/m)	Margin (dB)	Pass/Fail
30 - 6000	*	Peak	V/H	*	*	Pass

\*All receiver spurious emissions are more than 20 dB below the limit.

### 5.3.4.7. Radiated Emissions from Class B Digital Devices

▪ **Remark:** The emissions were scanned from 30 MHz to 13 GHz at 3 m distance. Rx was set in scanning mode. All emissions that are in excess of 20 dB below the specified limit shall be recorded.

Frequency (MHz)	Measured Field Strength @ 3 m (dB $\mu$ V/m)	Detector Used (Peak/QP)	Antenna Plane (H/V)	Limit @ 3m (dB $\mu$ V/m)	Margin (dB)
79.86	23.76	Peak	V	40.0	-16.24
85.57	21.50	Peak	V	40.0	-18.5

## 5.4. REQUIREMENTS FOR SCANNING RECEIVERS [§ 15.121]

### 5.4.1. FCC Rules

- a. Except as provided in paragraph (c) of this section, scanning receivers and frequency converters designed or marketed for use with scanning receivers, shall:
  - (1) Be incapable of operating (tuning), or readily being altered by the user to operate, within the frequency bands allocated to the Cellular Radiotelephone Service in part 22 of this chapter (cellular telephone bands). Scanning receivers capable of "readily being altered by the user" include, but are not limited to, those for which the ability to receive transmissions in the cellular telephone bands can be added by clipping the leads of, or installing, a simple component such as a diode, resistor or jumper wire; replacing a plug-in semiconductor chip; or programming a semiconductor chip using special access codes or an external device, such as a personal computer. Scanning receivers, and frequency converters designed for use with scanning receivers, also shall be incapable of converting digital cellular communication transmissions to analog voice audio.
  - (2) Be designed so that the tuning, control and filtering circuitry is inaccessible. The design must be such that any attempts to modify the equipment to receive transmissions from the Cellular Radiotelephone Service likely will render the receiver inoperable.
- b. Except as provided in paragraph (c) of this section, scanning receivers shall reject any signals from the Cellular Radiotelephone Service frequency bands that are 38 dB or lower based upon a 12 dB SINAD measurement, which is considered the threshold where a signal can be clearly discerned from any interference that may be present.
- c. Scanning receivers and frequency converters designed or marketed for use with scanning receivers, are not subject to the requirements of paragraphs (a) and (b) of this section provided that they are manufactured exclusively for, and marketed exclusively to, entities described in 18 U.S.C. 2512(2), or are marketed exclusively as test equipment pursuant to Sec. 15.3(dd)
- d. Modification of a scanning receiver to receive transmissions from Cellular Radiotelephone Service frequency bands will be considered to constitute manufacture of such equipment. This includes any individual, individuals, entity or organization that modifies one or more scanners. Any modification to a scanning receiver to receive transmissions from the Cellular Radiotelephone Service frequency bands voids the certification of the scanning receiver, regardless of the date of manufacture of the original unit. In addition, the provisions of Sec. 15.23 shall not be interpreted as permitting modification of a scanning receiver to receiver cellular radiotelephone service transmissions.
- e. Scanning receivers and frequency converters designed for use with scanning receivers shall not be assembled from kits or marketed in kit form unless they comply with the requirements in paragraph (a) through (c) of this section.

- f. Scanning receivers shall have a label permanently affixed to the product, and this label shall be readily visible to the purchaser at the time of purchase. The label shall read as follows: WARNING: MODIFICATION OF THIS DEVICE TO RECEIVE CELLULAR RADIOTELEPHONE SERVICE SIGNALS IS PROHIBITED UNDER FCC RULES AND FEDERAL LAW.
- (1) ``Permanently affixed" means that the label is etched, engraved, stamped, silkscreened, indelible printed or otherwise permanently marked on a permanently attached part of the equipment or on a nameplate of metal, plastic or other material fastened to the equipment by welding, riveting, or permanent adhesive. The label shall be designed to last the expected lifetime of the equipment in the environment in which the equipment may be operated and must not be readily detachable. The label shall not be a stick-on, paper label.
  - (2) When the device is so small that it is not practicable to place the warning label on it, the information required by this paragraph shall be placed in a prominent location in the instruction manual or pamphlet supplied to the user and shall also be placed on the container in which the device is marketed. However, the FCC identifier must be displayed on the device.

#### 5.4.2. Declaration for Compliance with FCC §15.121

- Comply with FCC 121(a)(1) – This Scanning Receiver is incapable of operating (tuning), or readily being altered by the user to operate, within the frequency bands allocated to the Cellular Radiotelephone Service in Part 22 of this chapter (cellular telephone bands).

Please refer to ICOM attestation letter conforming compliance with this requirement.

- Comply with FCC 121(a)(2) – This Scanning Receiver is designed so that the tuning, control and filtering circuitry is inaccessible. The design is such that any attempts to modify the equipment to receive transmissions from the Cellular Radiotelephone Service likely will render the receiver inoperable.

Please refer to ICOM attestation letter conforming compliance with this requirement.

- Comply with FCC 121(b) – Please refer to the Section 5.5 of this Test Report for Scanning Receivers Cellular Band Rejection test.
- Comply with FCC 121(c) – Not applicable.
- Comply with FCC 121(d) – The Users Manual of this Scanning Receiver is provided with the Warning statement as below.

**CAUTION: Changes or modifications to this device, not expressly approved by ICOM Inc., could void your authority to operate this device under FCC regulations.**

- Comply with FCC 121(e) – This Scanning Receiver is not assembled from kits or marketed in kit form.
- Comply with FCC 121(f) – Scanning receivers shall have a label permanently affixed to the product, and this label shall be readily visible to the purchaser at the time of purchase. The label reads as follows: **WARNING: MODIFICATION OF THIS DEVICE TO RECEIVE CELLULAR RADIOTELEPHONE SERVICE SIGNALS IS PROHIBITED UNDER FCC RULES AND FEDERAL LAW.**



## 5.5. SCANNING RECEIVERS CELLULAR BAND REJECTION [§ 15.121(b)]

### 5.5.1. Limits

Except as provided in paragraph (c) of this section, scanning receivers shall reject any signals from the Cellular Radiotelephone Service frequency bands that are 38dB or lower based upon a 12dB SINAD measurement, which is considered the threshold where a signal can be clearly discerned from any interference that may be present.

### 5.5.2. Method of Measurements

- (1) Connected the EUT as shown in the following block diagram
- (2) Apply a standard RF signal to the receiver input port
- (3) Adjust the audio output signal of the receiver to it's rated value with the distortion less than 10%
- (4) Adjust the RF Signal Generator Output Power to produce 12 dB SINAD without the audio output power dropping by more than 3 dB
- (5) Repeat step (4) at lowest, middle and highest channel frequencies across all cellular base station band to establish a reference sensitivity level. The reference sensitivity taken was the lowest or worse-case sensitivity for all of the bands.
- (6) Adjust the RF Signal Generator output to a level of +60 dB above the reference sensitivity obtained in step (5)
- (7) Set the Receiver squelch threshold (the signal required to open the squelch) no greater than +20 dB above the reference sensitivity level.
- (8) Put the receiver in a scanning mode and allow it to scan across it's complete receive range
- (9) If the receiver unsquelched or stopped on any frequency, the display frequency is recorded. The signal generator output level was then adjusted until 12 dB SINAD from the receiver was produced. The signal generator level associated with this response was also noted.
- (10) Repeat this procedure for 3 frequencies in the cellular base station transmit band.
- (11) The difference between the signal generator output for any response recorded and reference sensitivity is the rejection ratio

### 5.5.3. Test Arrangement

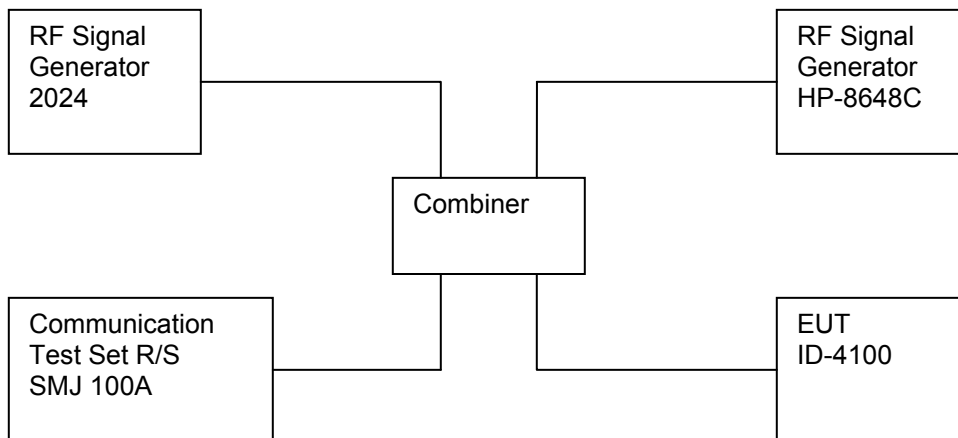

### Receiver Sensitivity Test

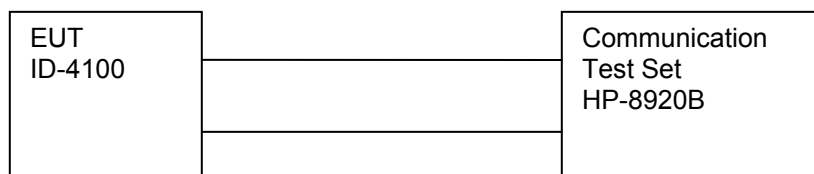

**5.5.4. Test Data**

Remark: Cellular Transmitter Test frequencies are 824.04, 836.4, 848.97, 869.04, 880.62 and 893.97 MHz.

**Input Level: -50 dBm, Test Modes: AM, DV, FM-N, AM-N**

EUT's Scanning Frequency Band (MHz)	Cellular Base Station Transmitter Band (MHz)	RF Signal Level for 12 dB SINAD (dBm)	Rejection Ratio (dB)	Maximum Rejection Ratio Limit (dB)
118-174 MHz, 230-550MHz	824.04, 836.4, 848.97 869.04, 880.62 & 893.97	- 92 to -116.9	<-40.0	-38.0
There is no spurious response detected within the above frequency bands with the Rejection Ratio of at least -40 dB.				

**EXHIBIT 6. TEST EQUIPMENTS LIST**

Test Instruments	Manufacturer	Model No.	Serial No.	Frequency Range	Cal. Due Date
Spectrum Analyzer	R/S	FSU	100398	20Hz-26.5GHz	14 Sep 2017
combiner	Mini Circuit	ZFSC-3-4	15542	1MHz - 1GHz	Cal. on use.
RFCommunication Test Set	HP	HP-8920B	US39064699	30M-1000MHz	8-Mar-18
RF Synthesized signal Generator	Marconi	2024	112255/164	9K--2400M Hz	27 Aug 2017
Signal Generator	HP	8648C	3443U00391	100KHz-3.2GHz	13-Mar-18
Horn antenna	ETS-LINDGREN	3117	119425	1-18GHz	17-Jun-17
Preamplifier	Hewlett Packard	8449B	3008A00769	1-26.5GHz	5-May-17
Antenna	ETS	3148	23845	200-2000 MHz	20-Jul-18
Antenna	EMCO	3142C	9601-1005	26-1000MHz	12-May-18
EMI Receiver	R/S	ESU 40	100037	20 Hz-40 GHz	8-May-17
Preamplifier	Com-Power	Pam-118A	551016	500MHz-18GHz	15-Mar-18
Preamplifier	Com-Power	Pam-118A	551052	500MHz-18GHz	13 Jul 2017
Spectrum Analyzer	Agilent	HP 8593EM	3412A00103	9 kHz – 26.5 GHz	9 Apr 2017
Attenuator	Pasternack	PE7010-20	09	DC – 2 GHz	13 Mar 2018
LISN	EMCO	3825/2R	1165	10 kHz – 30 MHz	7 Nov 2017
EMI Receiver	Rohde & Schwarz	ESU40	100037	20 Hz - 40 GHz	8 May 2017
Bi-Conilog antenna	EMCO	3142	9601-1005	26 - 1000 MHz	12 May 2018
Horn Antenna	EMCO	3115	9911-9555	1 - 18 GHz	21 April 2017

**ULTRATECH GROUP OF LABS**

3000 Bristol Circle, Oakville, Ontario, Canada L6H 6G4  
Tel. #: 905-829-1570, Fax. #: 905-829-8050, Email: [vic@ultratech-labs.com](mailto:vic@ultratech-labs.com), Website: <http://www.ultratech-labs.com>

File #: 17ICOM449\_FCC15B121

March 30, 2017

All test results contained in this engineering test report are traceable to National Institute of Standards and Technology (NIST)

## EXHIBIT 7. MEASUREMENT UNCERTAINTY

The measurement uncertainties stated were calculated in accordance with the requirements of CISPR 16-4-2 @ IEC:2003 and JCGM 100:2008 (GUM 1995) – Guide to the Expression of Uncertainty in Measurement.

### 7.1. LINE CONDUCTED EMISSION MEASUREMENT UNCERTAINTY

	Line Conducted Emission Measurement Uncertainty (9 kHz – 30 MHz):	Measured	Limit
$u_c$	Combined standard uncertainty: $u_c(y) = \sqrt{\sum_{i=1}^m u_i^2(y)}$	$\pm 1.44$	$\pm 1.8$
<b>U</b>	Expanded uncertainty U: $U = 2u_c(y)$	$\pm 2.89$	$\pm 3.6$

### 7.2. RADIATED EMISSION MEASUREMENT UNCERTAINTY

	Radiated Emission Measurement Uncertainty @ 3m, Horizontal (30-1000 MHz):	Measured (dB)	Limit (dB)
$u_c$	Combined standard uncertainty: $u_c(y) = \sqrt{\sum_{i=1}^m u_i^2(y)}$	$\pm 2.39$	$\pm 2.6$
<b>U</b>	Expanded uncertainty U: $U = 2u_c(y)$	$\pm 4.79$	$\pm 5.2$

	Radiated Emission Measurement Uncertainty @ 3m, Vertical (30-1000 MHz):	Measured (dB)	Limit (dB)
$u_c$	Combined standard uncertainty: $u_c(y) = \sqrt{\sum_{i=1}^m u_i^2(y)}$	$\pm 2.39$	$\pm 2.6$
<b>U</b>	Expanded uncertainty U: $U = 2u_c(y)$	$\pm 4.78$	$\pm 5.2$

	Radiated Emission Measurement Uncertainty @ 3 m, Horizontal & Vertical (1 – 18 GHz):	Measured (dB)	Limit (dB)
$u_c$	Combined standard uncertainty: $u_c(y) = \sqrt{\sum_{i=1}^m u_i^2(y)}$	$\pm 1.87$	Under consideration
<b>U</b>	Expanded uncertainty U: $U = 2u_c(y)$	$\pm 3.75$	Under consideration

## ULTRATECH GROUP OF LABS

3000 Bristol Circle, Oakville, Ontario, Canada L6H 6G4  
 Tel. #: 905-829-1570, Fax. #: 905-829-8050, Email: [vic@ultratech-labs.com](mailto:vic@ultratech-labs.com), Website: <http://www.ultratech-labs.com>

File #: 17ICOM449\_FCC15B121

March 30, 2017

All test results contained in this engineering test report are traceable to National Institute of Standards and Technology (NIST)