

# ENGINEERING TEST REPORT

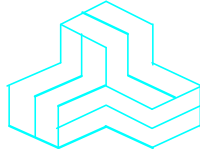

**UHF Digital Transceiver**  
**Model No.: IC-F6360D**  
**FCC ID: AFJ366501**

*Applicant:*

**ICOM Incorporated**  
1-1-32, Kamiminami, Hirano-ku  
Osaka, Japan, 547-0003

**Tested in Accordance With**

**Federal Communications Commission (FCC)**  
**47 CFR, Parts 2, 22, 74, 80 and 90 (Subpart I)**

**UltraTech's File No.: ICOM-364F90**

This Test report is Issued under the Authority of  
Tri M. Luu  
Vice President of Engineering  
UltraTech Group of Labs

Date: June 2, 2014

Report Prepared by: Dan Huynh

Tested by: Wei Wu

Issued Date: June 2, 2014

Test Dates: May 6, 20, 21 & 22, 2014

- *The results in this Test Report apply only to the sample(s) tested, and the sample tested is randomly selected.*
- *This report must not be used by the client to claim product endorsement by NVLAP or any agency of the US Government.*

## UltraTech

3000 Bristol Circle, Oakville, Ontario, Canada, L6H 6G4  
Tel.: (905) 829-1570 Fax.: (905) 829-8050  
Website: [www.ultratech-labs.com](http://www.ultratech-labs.com), Email: [vic@ultratech-labs.com](mailto:vic@ultratech-labs.com), Email: [tri@ultratech-labs.com](mailto:tri@ultratech-labs.com)



91038



1309



46390-2049



NVLAP LAB  
CODE 200093-0



SL2-IN-E-  
1119R



Korea  
KCC-RRA  
CA2049



TL363\_B



TPTDP  
DA1300

## TABLE OF CONTENTS

<b>EXHIBIT 1. INTRODUCTION.....</b>	<b>1</b>
1.1. SCOPE.....	1
1.2. RELATED SUBMITTAL(S)/GRANT(S).....	1
1.3. NORMATIVE REFERENCES .....	1
<b>EXHIBIT 2. PERFORMANCE ASSESSMENT.....</b>	<b>2</b>
2.1. CLIENT INFORMATION .....	2
2.2. EQUIPMENT UNDER TEST (EUT) INFORMATION.....	2
2.3. EUT'S TECHNICAL SPECIFICATIONS.....	3
2.4. LIST OF EUT'S PORTS .....	4
2.5. ANCILLARY EQUIPMENT .....	4
2.6. GENERAL TEST SETUP .....	5
<b>EXHIBIT 3. EUT OPERATING CONDITIONS AND CONFIGURATIONS DURING TESTS.....</b>	<b>6</b>
3.1. CLIMATE TEST CONDITIONS .....	6
3.2. OPERATIONAL TEST CONDITIONS & ARRANGEMENT FOR TEST SIGNALS .....	6
<b>EXHIBIT 4. SUMMARY OF TEST RESULTS .....</b>	<b>7</b>
4.1. LOCATION OF TESTS .....	7
4.2. APPLICABILITY & SUMMARY OF EMISSION TEST RESULTS .....	7
4.3. MODIFICATIONS INCORPORATED IN THE EUT FOR COMPLIANCE PURPOSES .....	7
<b>EXHIBIT 5. MEASUREMENTS DATA.....</b>	<b>8</b>
5.1. RF POWER OUTPUT [§§ 2.1046, 22.565, 74.461, 80.215 & 90.205] .....	8
5.2. AUDIO FREQUENCY RESPONSE [§ 2.1047(a) & 90.242(b)(8)] .....	9
5.3. MODULATION LIMITING [§§ 2.1047 (b), 74.463 & 80.213] .....	14
5.4. OCCUPIED BANDWIDTH & EMISSION MASK [§§ 2.1049, 74.462, 80.211(f), 90.209 & 90.210] .....	19
5.5. SPURIOUS EMISSIONS AT ANTENNA TERMINALS [§§ 2.1051, 2.1057, 22.359(a), 80.211(f)(3) & 90.210].....	40
5.6. FIELD STRENGTH OF SPURIOUS EMISSIONS [§§ 2.1053, 2.1057, 22.359(a), 80.211(f)(3) & 90.210] .....	50
5.7. FREQUENCY STABILITY [§§ 2.1055, 22.355, 74.464, 80.209 & 90.213] .....	52
5.8. TRANSIENT FREQUENCY BEHAVIOR [§§ 90.214 & 74.462(c)].....	55
5.9. RF EXPOSURE REQUIREMENTS [§§ 1.1310 & 2.1091].....	63
<b>EXHIBIT 6. TEST EQUIPMENT LIST .....</b>	<b>65</b>
<b>EXHIBIT 7. MEASUREMENT UNCERTAINTY.....</b>	<b>66</b>
7.1. RADIATED EMISSION MEASUREMENT UNCERTAINTY .....	66
<b>EXHIBIT 8. MEASUREMENT METHODS .....</b>	<b>67</b>
8.1. CONDUCTED POWER MEASUREMENTS.....	67
8.2. RADIATED POWER MEASUREMENTS (ERP & EIRP) USING SUBSTITUTION METHOD .....	68
8.3. FREQUENCY STABILITY.....	71
8.4. EMISSION MASK.....	72
8.5. SPURIOUS EMISSIONS (CONDUCTED) .....	72
8.6. TRANSIENT FREQUENCY BEHAVIOR.....	73

## EXHIBIT 1. INTRODUCTION

### 1.1. SCOPE

<b>Reference:</b>	FCC Parts 2, 22, 74, 80 and 90 (Subpart I)
<b>Title:</b>	Code of Federal Regulations (CFR), Title 47 Telecommunication – Parts 2, 22, 74, 80 and 90 (Subpart I)
<b>Purpose of Test:</b>	To obtain FCC Certification Authorization for Radio operating in the Frequency Band 400-406 & 406.1-470 MHz (25 kHz, 12.5 kHz and 6.25 kHz Channel Spacing).
<b>Test Procedures:</b>	Both conducted and radiated emissions measurements were conducted in accordance with TIA/EIA Standard TIA/EIA-603-D – Land Mobile FM or PM Communications Equipment Measurement and performance Standards.

### 1.2. RELATED SUBMITTAL(S)/GRANT(S)

None

### 1.3. NORMATIVE REFERENCES

Publication	Year	Title
FCC CFR Parts 0-19, 80-End	2013	Code of Federal Regulations – Telecommunication
ANSI C63.4	2009	American National Standard for Methods of Measurement of Radio-Noise Emissions from Low-Voltage Electrical and Electronic Equipment in the Range of 9 kHz to 40 GHz
TIA/EIA 603, Edition D	2010	Land Mobile FM or PM Communications Equipment Measurement and Performance Standards

## EXHIBIT 2. PERFORMANCE ASSESSMENT

### 2.1. CLIENT INFORMATION

APPLICANT	
<b>Name:</b>	Icom Incorporated
<b>Address:</b>	1-1-32, Kamiminami Hirano-ku, Osaka Japan, 547-0003
<b>Contact Person:</b>	Mr. Hideji Fujishima Phone #: +81-6 6793-8424 Fax #: +81-6 6793-3336 Email Address: world_support@icom.co.jp

MANUFACTURER	
<b>Name:</b>	Icom Incorporated
<b>Address:</b>	1-1-32, Kamiminami Hirano-ku, Osaka Japan, 547-0003
<b>Contact Person:</b>	Mr. Hideji Fujishima Phone #: +81-6 6793-8424 Fax #: +81-6 6793-3336 Email Address: world_support@icom.co.jp

### 2.2. EQUIPMENT UNDER TEST (EUT) INFORMATION

The applicant has supplied the following information (with the exception of the Date of Receipt).

<b>Brand Name:</b>	ICOM Incorporated
<b>Product Name:</b>	UHF Digital Transceiver
<b>Model Name or Number:</b>	IC-F6360D
<b>Serial Number:</b>	Test Sample
<b>Type of Equipment:</b>	Licensed Non-Broadcast Station Transmitter
<b>Power Supply Requirement:</b>	13.6 VDC nominal
<b>Transmitting/Receiving Antenna Type:</b>	Non-integral
<b>Primary User Functions of EUT:</b>	UHF Digital Transceiver for Occupation Use Only

#### ULTRATECH GROUP OF LABS

3000 Bristol Circle, Oakville, Ontario, Canada L6H 6G4  
Tel. #: 905-829-1570, Fax. #: 905-829-8050, Email: [vic@ultratech-labs.com](mailto:vic@ultratech-labs.com), Website: <http://www.ultratech-labs.com>

File #: ICOM-364F90  
June 2, 2014

All test results contained in this engineering test report are traceable to National Institute of Standards and Technology (NIST)

### 2.3. EUT'S TECHNICAL SPECIFICATIONS

<b>Transmitter</b>	
<b>Equipment Type:</b>	Mobile
<b>Intended Operating Environment:</b>	Commercial, Restricted to Occupational Use only
<b>Power Supply Requirement:</b>	13.6 VDC nominal
<b>RF Output Power Rating:</b>	45 W (High) / 5 W (Low)
<b>Operating Frequency Range:</b>	400-406 & 406.1-470 MHz
<b>RF Output Impedance:</b>	50 Ω
<b>Channel Spacing:</b>	25 kHz, 12.5 kHz, 6.25 kHz
<b>Occupied Bandwidth (99%):</b>	15.36 kHz (for 25 kHz Channel Spacing, Analog)** 10.27 kHz (for 12.5 kHz Channel Spacing, Analog) 7.62 kHz (for 12.5 kHz Channel Spacing, Digital) 3.55 kHz (for 6.25 kHz Channel Spacing, Digital)
<b>Emission Designation*:</b>	16K0F3E**, 11K0F3E, 8K50F3E, 8K30F1E, 8K30F1D 4K00F1E, 4K00F1D
<b>Antenna Connector Type:</b>	J

\* For an average case of commercial telephony, the Necessary Bandwidth is calculated as follows:

For FM Voice Modulation:

Channel Spacing = 25 kHz, D = 5 kHz max, K = 1, M = 3 kHz

$$B_n = 2M + 2DK = 2(3) + 2(5)(1) = \mathbf{16 \text{ kHz}}$$

Emission designation: 16K0F3E

Channel Spacing = 12.5 kHz, D = 2.5 kHz max, K = 1, M = 3 kHz

$$B_n = 2M + 2DK = 2(3) + 2(2.5)(1) = \mathbf{11 \text{ kHz}}$$

Emission designation: 11K0F3E

\*\*The emission designation 16K0F3E with 25 kHz Channel bandwidth is only applied to the device operated in FCC Rules Part 22, 74 & 80 frequencies. The operation of 16K0F3E emission will be disabled in the firmware by the manufacturer for device that operates in FCC Rules Part 90 frequencies (Private Land Mobile).

**2.4. LIST OF EUT'S PORTS**

Port Number	EUT's Port Description	Number of Identical Ports	Connector Type	Cable Type (Shielded/Non-shielded)
1	Antenna Connector	1	J type	Terminated to 50Ω Load
2	External Speaker Jack	1	Mini Jack	Non-shielded
3	D-Sub 15-pin	1	DB 15	Shielded
4	GPS Antenna Connector	1	SMA	Terminated to 50Ω Load
5	DC Power Receptacle	1	Plug-In Jack	Non-shielded
6	Ignition Lead	1	Pin	Non-shielded
7	Microphone	1	RJ45	Non-shielded

**2.5. ANCILLARY EQUIPMENT**

The EUT was tested while connected to the following representative configuration of ancillary equipment necessary to exercise the ports during tests:

<b>Ancillary Equipment # 1</b>	
Description:	Microphone
Brand name:	ICOM
Model Name or Number:	HM-161
Connected to EUT's Port:	Microphone Port

## 2.6. GENERAL TEST SETUP

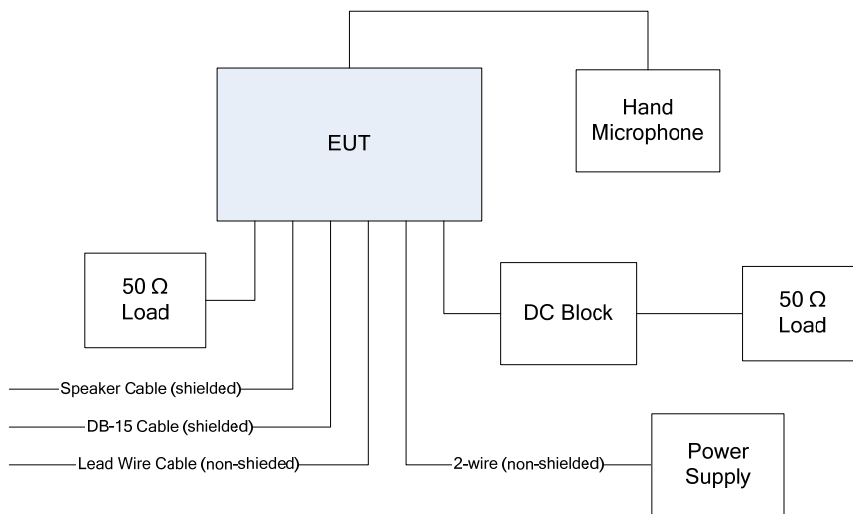

### EXHIBIT 3. EUT OPERATING CONDITIONS AND CONFIGURATIONS DURING TESTS

#### 3.1. CLIMATE TEST CONDITIONS

The climate conditions of the test environment are as follows:

<b>Temperature:</b>	21°C - 24°C
<b>Humidity:</b>	45% to 58%
<b>Pressure:</b>	102 kPa
<b>Power Input Source:</b>	13.6 VDC nominal

#### 3.2. OPERATIONAL TEST CONDITIONS & ARRANGEMENT FOR TEST SIGNALS

<b>Operating Modes:</b>	The transmitter was operated in a continuous transmission mode with the carrier modulated as specified in the Test Data.
<b>Special Test Software:</b>	N/A
<b>Special Hardware Used:</b>	N/A
<b>Transmitter Test Antenna:</b>	The EUT is tested with the antenna port terminated to a 50 Ohm RF Load.

<b>Transmitter Test Signals</b>	
<b>Frequency Band(s):</b>	400-406 & 406.1-470 MHz
<b>Test Frequencies:</b> (Near lowest, near middle & near highest frequencies in the frequency range of operation.)	406.2 MHz, 450.1 MHz, 469.9 MHz
<b>Transmitter Wanted Output Test Signals:</b>	
Transmitter Power (measured maximum output power):	41.50 W High and 4.51 W Low
Normal Test Modulation:	FM Voice/Digital
Modulating signal source:	External



## EXHIBIT 4. SUMMARY OF TEST RESULTS

### 4.1. LOCATION OF TESTS

All of the measurements described in this report were performed at Ultratech Group of Labs located in the city of Oakville, Province of Ontario, Canada.

Radiated Emissions were performed at the Ultratech's 3-10 TDK Semi-Anechoic Chamber situated in the Town of Oakville, province of Ontario. This test site been calibrated in accordance with ANSI C63.4, and found to be in compliance with the requirements of Sec. 2.948 of the FCC Rules. The descriptions and site measurement data of the Oakville 3-10 TDK Semi-Anechoic Chamber has been filed with FCC office (FCC File No.: 91038) and Industry Canada office (Industry Canada File No.: 2049A-3). Expiry Date: 2017-04-02.

### 4.2. APPLICABILITY & SUMMARY OF EMISSION TEST RESULTS

FCC Section(s)	Test Requirements	Applicability (Yes/No)
2.1046, 22.565, 74.461, 80.215 & 90.205	RF Power Output	Yes
2.1047(a) & 90.242(b)(8)	Audio Frequency Response	Tests are conducted under FCC's recommendation.
2.1047(b), 74.463 & 80.213	Modulation Limiting	Yes
2.1049, 74.462, 80.211(f), 90.209 & 90.210	Occupied Bandwidth, Emission Limitation & Emission Mask	Yes
2.1051, 2.1057, 22.359(a), 80.211(f)(3), & 90.210	Spurious Emissions at Antenna Terminals	Yes
2.1053, 2.1057, 22.359(a), 80.211(f)(3), & 90.210	Field Strength of Spurious Emissions	Yes
2.1055, 22.355, 74.464 80.209 & 90.213	Frequency Stability	Yes
74.462(c) & 90.214	Transient Frequency Behavior	Yes
1.1307, 1.1310 & 2.1091	RF Exposure Limit	Yes

### 4.3. MODIFICATIONS INCORPORATED IN THE EUT FOR COMPLIANCE PURPOSES

None.

#### 4.3.1. DEVIATION OF STANDARD TEST PROCEDURES

None.

---

## ULTRATECH GROUP OF LABS

3000 Bristol Circle, Oakville, Ontario, Canada L6H 6G4  
Tel. #: 905-829-1570, Fax. #: 905-829-8050, Email: [vic@ultratech-labs.com](mailto:vic@ultratech-labs.com), Website: <http://www.ultratech-labs.com>

File #: ICOM-364F90  
June 2, 2014

All test results contained in this engineering test report are traceable to National Institute of Standards and Technology (NIST)

**EXHIBIT 5. MEASUREMENTS DATA**

**5.1. RF POWER OUTPUT [§§ 2.1046, 22.565, 74.461, 80.215 & 90.205]**

**5.1.1. Limits**

Refer to FCC 47 CFR 22.565, 74.461, 80.215 and 90.205 for specification details.

**5.1.2. Method of Measurements**

Refer to Section 8.1 (Conducted) and 8.2 (Radiated) of this report for measurement details

**5.1.3. Test Arrangement**

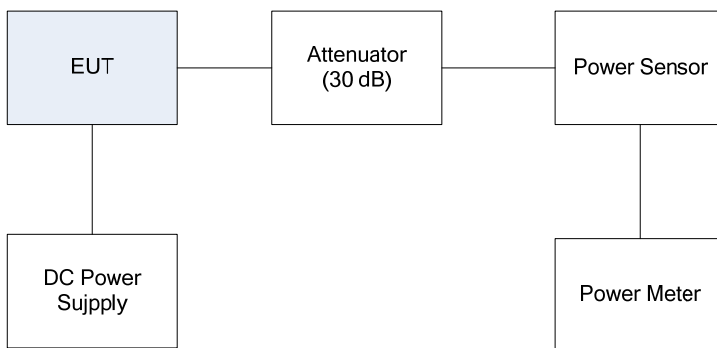

**5.1.4. Test Data**

Fundamental Frequency (MHz)	Measured (Average) Power (W)	Power Rating (W)
High Power Level, 45 W		
406.2	41.50	45.0
450.1	38.46	45.0
469.9	35.81	45.0
Low Power Level, 5 W		
406.2	4.51	5.0
450.1	4.42	5.0
469.9	4.34	5.0

## 5.2. AUDIO FREQUENCY RESPONSE [§ 2.1047(a) & 90.242(b)(8)]

### 5.2.1. Limits

§ 2.1047(a): Voice modulated communication equipment. A curve or equivalent data showing the frequency response of the audio modulating circuit over a range of 100 to 5000 Hz shall be submitted. For equipment required to have an audio low-pass filter, a curve showing the frequency response of the filter or of all circuitry installed between the modulation limiter and the modulated stage shall be submitted.

§ 90.242(b)(8): Recommended audio filter attenuation characteristics are given below:

Audio band	Minimum Attenuation Rel. to 1 kHz Attenuation
3 –20 KHz	$60 \log_{10}(f/3)$ dB where "f" is the audio frequency in kHz
20 – 30 KHz	50dB

### 5.2.2. Method of Measurements

The rated audio input signal was applied to the input of the audio low-pass filter (or of all modulation stages) using an audio oscillator, this input signal level and its corresponding output signal were then measured and recorded using the FFT Digital Spectrum Analyzer. Tests were repeated at different audio signal frequencies from 0 to 50 KHz.

### 5.2.3. Test Arrangement

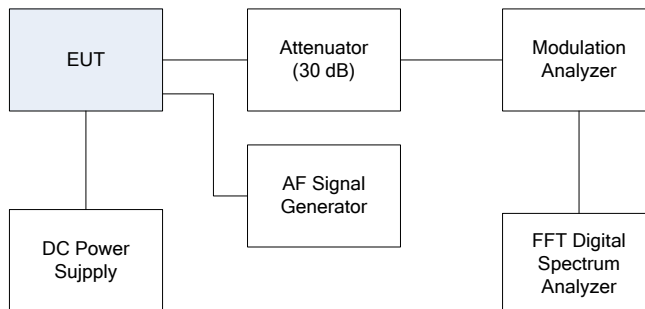

5.2.4. Test Data

5.2.4.1. 12.5 kHz Channel Spacing, F3E, Frequency of All Modulation States

**Remark:** Due to the difficulty of measuring the Frequency Response of the internal low-pass filter, the Frequency Response of All Modulation States is performed to show the roll-off at 3 kHz in comparison with the recommended audio filter attenuation.

Frequency (KHz)	Audio In (dBV)	Audio Out (dBV)	Attenuation (Out - In) (dB)	Attenuation Rel. to 1 KHz (dB)	Recommended Attenuation (dB)
0.1	-45.68	-70.00	-24.3	-70.2	--
0.2	-45.68	-58.91	-13.2	-59.1	--
0.4	-45.68	-8.33	37.4	-8.5	--
0.6	-45.68	-4.19	41.5	-4.4	--
0.8	-45.68	-1.72	44.0	-1.9	--
1.0	-45.68	0.21	45.9	0.0	--
1.5	-45.68	3.41	49.1	3.2	--
2.0	-45.68	3.54	49.2	3.3	--
2.5	-45.68	3.32	49.0	3.1	--
3.0	-45.68	2.02	47.7	1.8	0
3.5	-45.68	-5.32	40.4	-5.5	-4
4.0	-45.68	-32.54	13.1	-32.8	-7
4.5	-45.68	-61.78	-16.1	-62.0	-11
5.0	-45.68	-70.00	-24.3	-70.2	-13
6.0	-45.68	-70.00	-24.3	-70.2	-18
7.0	-45.68	-70.00	-24.3	-70.2	-22
8.0	-45.68	-70.00	-24.3	-70.2	-26
9.0	-45.68	-70.00	-24.3	-70.2	-29
10.0	-45.68	-70.00	-24.3	-70.2	-31
12.0	-45.68	-70.00	-24.3	-70.2	-36
14.0	-45.68	-70.00	-24.3	-70.2	-40
16.0	-45.68	-70.00	-24.3	-70.2	-44
18.0	-45.68	-70.00	-24.3	-70.2	-47
20.0	-45.68	-70.00	-24.3	-70.2	-50
25.0	-45.68	-70.00	-24.3	-70.2	-50
30.0	-45.68	-70.00	-24.3	-70.2	-50
35.0	-45.68	-70.00	-24.3	-70.2	-50
40.0	-45.68	-70.00	-24.3	-70.2	-50
45.0	-45.68	-70.00	-24.3	-70.2	-50
50.0	-45.68	-70.00	-24.3	-70.2	-50

**ULTRATECH GROUP OF LABS**

3000 Bristol Circle, Oakville, Ontario, Canada L6H 6G4  
 Tel. #: 905-829-1570, Fax. #: 905-829-8050, Email: [vic@ultratech-labs.com](mailto:vic@ultratech-labs.com), Website: <http://www.ultratech-labs.com>

File #: ICOM-364F90  
 June 2, 2014

All test results contained in this engineering test report are traceable to National Institute of Standards and Technology (NIST)

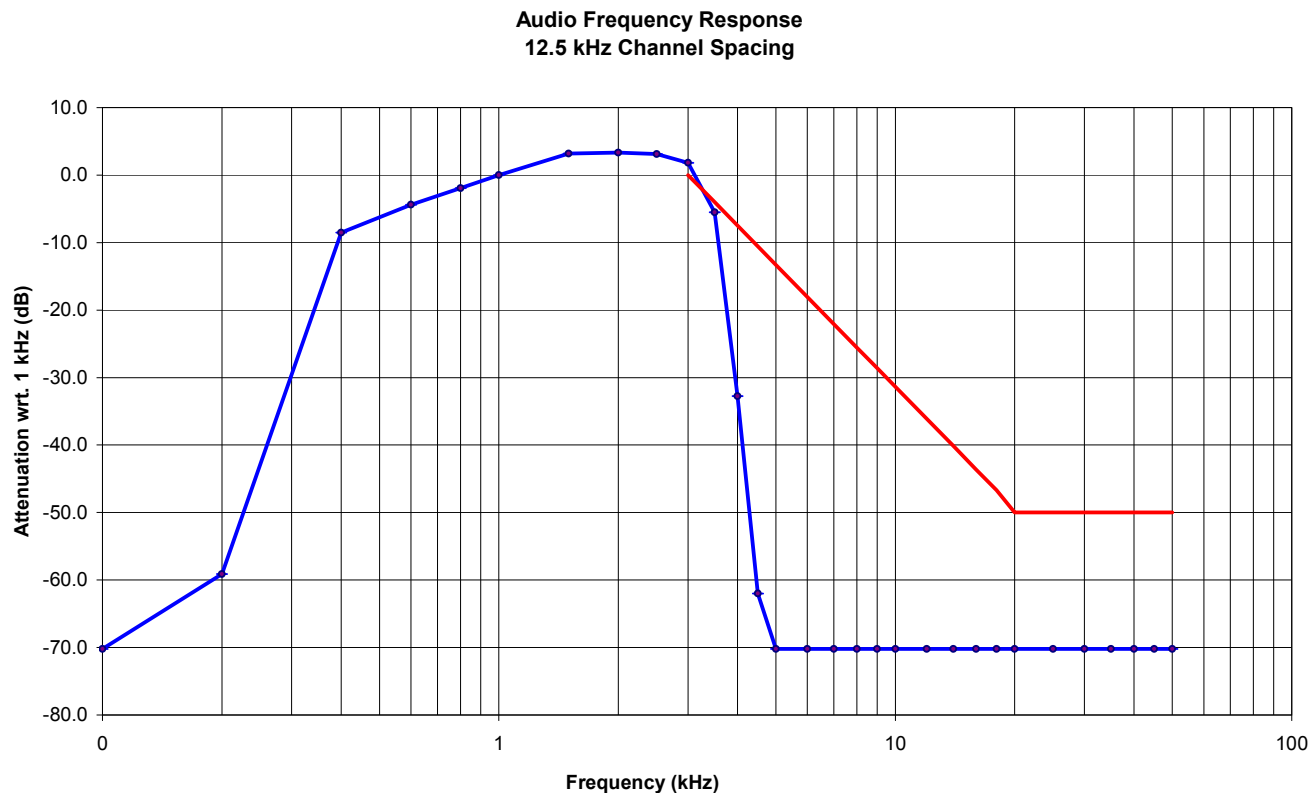

**ULTRATECH GROUP OF LABS**

3000 Bristol Circle, Oakville, Ontario, Canada L6H 6G4  
Tel. #: 905-829-1570, Fax. #: 905-829-8050, Email: [vic@ultratech-labs.com](mailto:vic@ultratech-labs.com), Website: <http://www.ultratech-labs.com>

**File #: ICOM-364F90**

June 2, 2014

All test results contained in this engineering test report are traceable to National Institute of Standards and Technology (NIST)

**5.2.4.2. 25 kHz Channel Spacing, F3E, Frequency of All Modulation States**

**Remark:** Due to the difficulty of measuring the Frequency Response of the internal low-pass filter, the Frequency Response of All Modulation States is performed to show the roll-off at 3 kHz in comparison with the recommended audio filter attenuation.

Frequency (KHz)	Audio In (dBV)	Audio Out (dBV)	Attenuation (Out - In) (dB)	Attenuation Rel. to 1 KHz (dB)	Recommended Attenuation (dB)
0.1	-45.68	-70.00	-24.3	-76.3	--
0.2	-45.68	-58.78	-13.1	-65.1	--
0.4	-45.68	-2.30	43.4	-8.6	--
0.6	-45.68	1.89	47.6	-4.4	--
0.8	-45.68	4.32	50.0	-2.0	--
1.0	-45.68	6.27	52.0	0.0	--
1.5	-45.68	9.48	55.2	3.2	--
2.0	-45.68	9.38	55.1	3.1	--
2.5	-45.68	9.38	55.1	3.1	--
3.0	-45.68	8.07	53.8	1.8	0
3.5	-45.68	0.71	46.4	-5.6	-4
4.0	-45.68	-26.51	19.2	-32.8	-7
4.5	-45.68	-70.00	-24.3	-76.3	-11
5.0	-45.68	-70.00	-24.3	-76.3	-13
6.0	-45.68	-70.00	-24.3	-76.3	-18
7.0	-45.68	-70.00	-24.3	-76.3	-22
8.0	-45.68	-70.00	-24.3	-76.3	-26
9.0	-45.68	-70.00	-24.3	-76.3	-29
10.0	-45.68	-70.00	-24.3	-76.3	-31
12.0	-45.68	-70.00	-24.3	-76.3	-36
14.0	-45.68	-70.00	-24.3	-76.3	-40
16.0	-45.68	-70.00	-24.3	-76.3	-44
18.0	-45.68	-70.00	-24.3	-76.3	-47
20.0	-45.68	-70.00	-24.3	-76.3	-50
25.0	-45.68	-70.00	-24.3	-76.3	-50
30.0	-45.68	-70.00	-24.3	-76.3	-50
35.0	-45.68	-70.00	-24.3	-76.3	-50
40.0	-45.68	-70.00	-24.3	-76.3	-50
45.0	-45.68	-70.00	-24.3	-76.3	-50
50.0	-45.68	-70.00	-24.3	-76.3	-50

**ULTRATECH GROUP OF LABS**

3000 Bristol Circle, Oakville, Ontario, Canada L6H 6G4  
 Tel. #: 905-829-1570, Fax. #: 905-829-8050, Email: [vic@ultratech-labs.com](mailto:vic@ultratech-labs.com), Website: <http://www.ultratech-labs.com>

File #: ICOM-364F90

June 2, 2014

All test results contained in this engineering test report are traceable to National Institute of Standards and Technology (NIST)

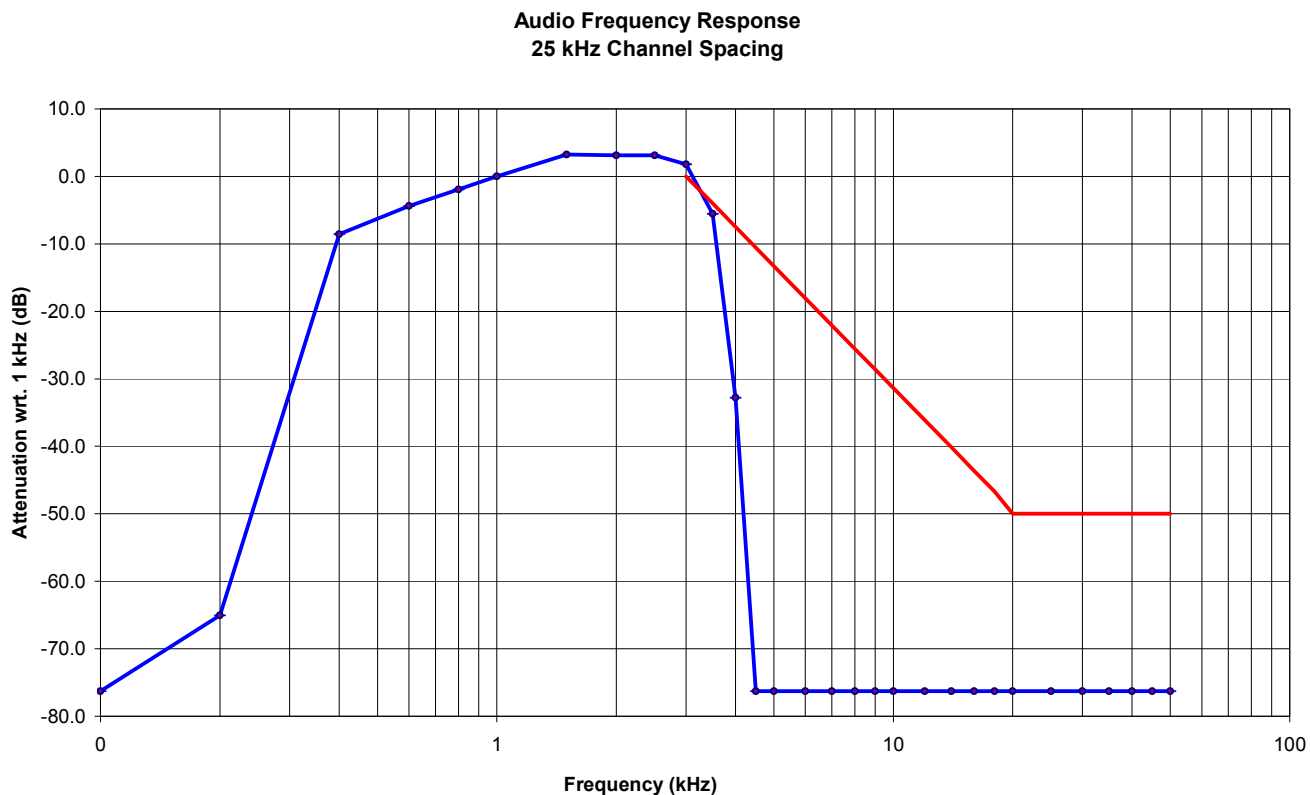

### 5.3. MODULATION LIMITING [§§ 2.1047 (b), 74.463 & 80.213]

#### 5.3.1. Limits

§ 2.1047(b): Equipment which employs modulation limiting. A curve or family of curves showing the percentage of modulation versus the modulation input voltage shall be supplied. The information submitted shall be sufficient to show modulation limiting capability throughout the range of modulating frequencies and input modulating signal levels employed.

Recommended frequency deviation characteristics are given below:

- 1.25 kHz for 6.25 kHz Channel Spacing System
- 2.5 kHz for 12.5 kHz Channel Spacing System
- 5 kHz for 25 kHz Channel Spacing System

#### 5.3.2. Method of Measurements

**For Audio Transmitter:** The carrier frequency deviation was measured with the tone input signal level varied from 0 Vp to audio input rating level plus 16 dB at frequencies 0.1, 0.5, 1.0, 3.0 and 5.0 kHz. The maximum deviation was recorded at each test condition.

**For Data Transmitter with Maximum Frequency Deviation set by Factory:** The EUT was set at maximum frequency deviation, and its peak frequency deviation was then measured using EUT's internal random data source.

#### 5.3.3. Test Arrangement

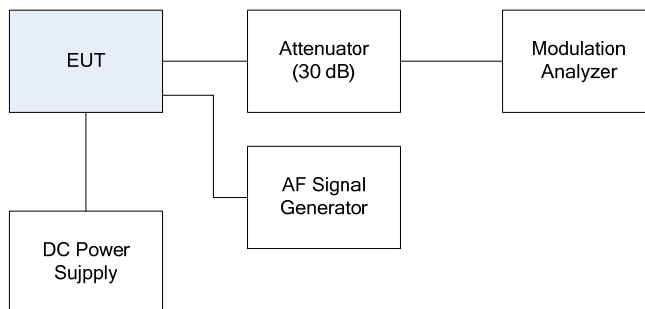



**5.3.4. Test Data**

**5.3.4.1. Voice Modulation Limiting for 25 KHz Channel Spacing Operation (Not for FCC Part 90 Certification)**

Modulating Signal Level (mVrms)	Peak Frequency Deviation (kHz) at the following modulating frequency:					Maximum Limit (kHz)
	0.1 kHz	0.5 kHz	1.0 kHz	3.0 kHz	5.0 kHz	
2	0.19	0.66	1.21	2.78	0.18	5.0
4	0.19	1.18	2.34	3.47	0.18	5.0
6	0.19	1.79	3.43	3.61	0.18	5.0
8	0.19	2.38	4.31	3.61	0.18	5.0
10	0.19	2.88	4.31	3.61	0.18	5.0
15	0.19	4.16	4.31	3.61	0.18	5.0
20	0.19	4.26	4.31	3.61	0.18	5.0
25	0.19	4.26	4.31	3.61	0.18	5.0
30	0.19	4.26	4.31	3.61	0.18	5.0
35	0.19	4.26	4.31	3.61	0.18	5.0
40	0.19	4.26	4.31	3.61	0.17	5.0
45	0.19	4.26	4.31	3.61	0.16	5.0
50	0.19	4.26	4.31	3.61	0.14	5.0
60	0.16	4.26	4.31	3.61	0.13	5.0
70	0.14	4.26	4.31	3.61	0.12	5.0
80	0.14	4.26	4.31	3.61	0.11	5.0
90	0.14	4.26	4.31	3.61	0.11	5.0
100	0.14	4.26	4.31	3.61	0.11	5.0

<b>Voice Signal Input Level</b> = STD MOD Level + 16 dB = 14.32 dB(mVrms) + 16 dB = 30.32 dB(mVrms) = 32.81 mVrms		
Modulation Frequency (kHz)	Peak Deviation (kHz)	Maximum Limit (kHz)
0.1	0.19	5.0
0.2	0.18	5.0
0.4	4.25	5.0
0.6	4.28	5.0
0.8	4.28	5.0
1.0	4.31	5.0
1.2	4.25	5.0
1.4	4.29	5.0
1.6	4.26	5.0
1.8	4.24	5.0
2.0	4.18	5.0
2.5	4.16	5.0
3.0	1.56	5.0
3.5	0.24	5.0
4.0	0.17	5.0
4.5	0.18	5.0
5.0	0.18	5.0
6.0	0.18	5.0
7.0	0.18	5.0
8.0	0.18	5.0
9.0	0.18	5.0
10.0	0.18	5.0

**ULTRATECH GROUP OF LABS**

3000 Bristol Circle, Oakville, Ontario, Canada L6H 6G4  
 Tel. #: 905-829-1570, Fax. #: 905-829-8050, Email: [vic@ultratech-labs.com](mailto:vic@ultratech-labs.com), Website: <http://www.ultratech-labs.com>

File #: ICOM-364F90

June 2, 2014

All test results contained in this engineering test report are traceable to National Institute of Standards and Technology (NIST)

**5.3.4.2. Voice Modulation Limiting for 12.5 KHz Channel Spacing Operation**

Modulating Signal Level (mVrms)	Peak Frequency Deviation (kHz) at the following modulating frequency:					Maximum Limit (kHz)
	0.1 kHz	0.5 kHz	1.0 kHz	3.0 kHz	5.0 kHz	
2	0.11	0.34	0.61	1.43	0.10	2.5
4	0.11	0.58	1.18	1.74	0.10	2.5
6	0.11	0.87	1.73	1.81	0.10	2.5
8	0.11	1.18	2.14	1.79	0.10	2.5
10	0.11	1.42	2.15	1.81	0.09	2.5
15	0.11	2.11	2.14	1.81	0.09	2.5
20	0.11	2.14	2.14	1.81	0.09	2.5
25	0.11	2.14	2.14	1.81	0.09	2.5
30	0.11	2.14	2.14	1.81	0.09	2.5
35	0.11	2.14	2.14	1.81	0.09	2.5
40	0.11	2.14	2.14	1.81	0.09	2.5
45	0.11	2.14	2.14	1.81	0.09	2.5
50	0.11	2.14	2.14	1.81	0.09	2.5
60	0.11	2.14	2.14	1.81	0.09	2.5
70	0.11	2.14	2.14	1.81	0.09	2.5
80	0.11	2.14	2.14	1.81	0.09	2.5
90	0.11	2.14	2.14	1.81	0.09	2.5
100	0.11	2.14	2.14	1.81	0.09	2.5

**ULTRATECH GROUP OF LABS**

3000 Bristol Circle, Oakville, Ontario, Canada L6H 6G4  
 Tel. #: 905-829-1570, Fax. #: 905-829-8050, Email: [vic@ultratech-labs.com](mailto:vic@ultratech-labs.com), Website: <http://www.ultratech-labs.com>

File #: ICOM-364F90

June 2, 2014

All test results contained in this engineering test report are traceable to National Institute of Standards and Technology (NIST)

<b>Voice Signal Input Level</b> = STD MOD Level + 16 dB = 14.32 dB(mVrms) + 16 dB = 30.32 dB(mVrms) = 32.81 mVrms		
Modulation Frequency (kHz)	Peak Deviation (kHz)	Maximum Limit (kHz)
0.1	0.11	2.5
0.2	0.11	2.5
0.4	2.13	2.5
0.6	2.15	2.5
0.8	2.15	2.5
1.0	2.14	2.5
1.2	2.13	2.5
1.4	2.15	2.5
1.6	2.13	2.5
1.8	2.13	2.5
2.0	2.15	2.5
2.5	2.08	2.5
3.0	1.81	2.5
3.5	0.79	2.5
4.0	0.14	2.5
4.5	0.10	2.5
5.0	0.09	2.5
6.0	0.10	2.5
7.0	0.10	2.5
8.0	0.10	2.5
9.0	0.10	2.5
10.0	0.10	2.5

**5.3.4.3. Digital Modulation for 12.5 KHz Channel Spacing**

Max Deviation measured = 3.14 kHz

**5.3.4.4. Digital Modulation for 6.25 KHz Channel Spacing**

Max Deviation measured = 1.45 kHz

**ULTRATECH GROUP OF LABS**

3000 Bristol Circle, Oakville, Ontario, Canada L6H 6G4  
 Tel. #: 905-829-1570, Fax. #: 905-829-8050, Email: [vic@ultratech-labs.com](mailto:vic@ultratech-labs.com), Website: <http://www.ultratech-labs.com>

File #: ICOM-364F90

June 2, 2014

All test results contained in this engineering test report are traceable to National Institute of Standards and Technology (NIST)

**5.4. OCCUPIED BANDWIDTH & EMISSION MASK [§§ 2.1049, 74.462, 80.211(f), 90.209 & 90.210]**

**5.4.1. Limits**

**§80.211(f) Emission limitations**

Emissions shall be attenuated below the mean output power of the transmitter as follows:

- (1) On any frequency removed from the assigned frequency by more than 50 percent up to and including 100 percent of the authorized bandwidth: At least 25 dB;
- (2) On any frequency removed from the assigned frequency by more than 100 percent up to and including 250 percent of the authorized bandwidth: At least 35 dB; and
- (3) On any frequency removed from the assigned frequency by more than 250 percent of the authorized bandwidth: At least 43 plus  $10\log_{10}$  (mean power in watts) dB.

**§90.209 Bandwidth limitations**

Frequency band (MHz)	Channel spacing (kHz)	Authorized bandwidth (kHz)
406-512 <sup>2</sup>	<sup>1</sup> 6.25	<sup>1</sup> <sup>3</sup> 20/11.25/6

<sup>1</sup>For stations authorized on or after August 18, 1995.

<sup>2</sup>Bandwidths for radiolocation stations in the 420-450 MHz band and for stations operating in bands subject to this footnote will be reviewed and authorized on a case-by-case basis.

<sup>3</sup>Operations using equipment designed to operate with a 25 kHz channel bandwidth will be authorized a 20 kHz bandwidth. Operations using equipment designed to operate with a 12.5 kHz channel bandwidth will be authorized a 11.25 kHz bandwidth. Operations using equipment designed to operate with a 6.25 kHz channel bandwidth will be authorized a 6 kHz bandwidth. All stations must operate on channels with a bandwidth of 12.5 kHz or less beginning January 1, 2013, unless the operations meet the efficiency standard of §90.203(j)(3).

**§90.210 Emission masks**

Mask for equipment with audio low pass filter	Mask for equipment without audio low pass filter	Mask for equipment without audio low pass filter
421-512 <sup>1</sup> <sup>2</sup>	B, D, or E	C, D, or E

<sup>1</sup>Equipment designed to operate with a 25 kHz channel bandwidth must meet the requirements of Emission Mask B or C, as applicable. Equipment designed to operate with a 12.5 kHz channel bandwidth must meet the requirements of Emission Mask D, and equipment designed to operate with a 6.25 kHz channel bandwidth must meet the requirements of Emission Mask E.

<sup>2</sup>Equipment may alternatively meet the Adjacent Channel Power limits of §90.221.

#### 5.4.2. Method of Measurements

Refer to Section 8.4 of this report for measurement details.

#### 5.4.3. Test Arrangement

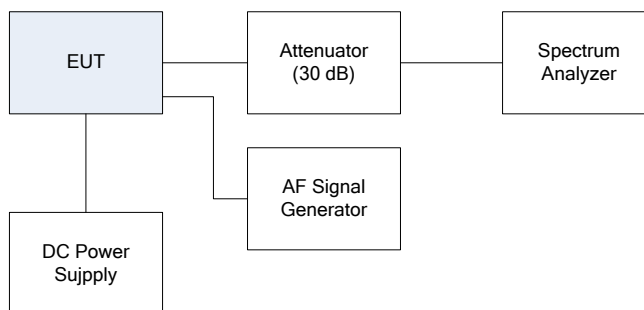

5.4.4. Test Data

5.4.4.1. 99% Occupied Bandwidth

Frequency (MHz)	Channel Spacing (kHz)	Modulation	Measured 99% OBW at Maximum Freq. Deviation (kHz)	Maximum Authorized Bandwidth (kHz)
406.2	25*	FM with 2.5 kHz sine wave signal	15.22*	20
450.1	25*	FM with 2.5 kHz sine wave signal	15.29*	20
469.9	25*	FM with 2.5 kHz sine wave signal	15.36*	20
406.2	12.5	FM with 2.5 kHz sine wave signal	10.27	11.25
450.1	12.5	FM with 2.5 kHz sine wave signal	10.22	11.25
469.9	12.5	FM with 2.5 kHz sine wave signal	10.27	11.25
406.2	12.5	Digital	7.58	11.25
450.1	12.5	Digital	7.62	11.25
469.9	12.5	Digital	7.58	11.25
406.2	6.25	Digital	3.53	6
450.1	6.25	Digital	3.55	6
469.9	6.25	Digital	3.51	6

\* Not for FCC Part 90 Certification.

**Note:** 99% Occupied Bandwidth measurements were done using the built-in auto function of the analyzer.

Refer to the following test data plots for details.

Plot 5.4.4.1.1. 99% Occupied Bandwidth for 25 kHz Channel Spacing, Analog  
 406.2 MHz, High Power, FM with 2.5 kHz sine wave signal

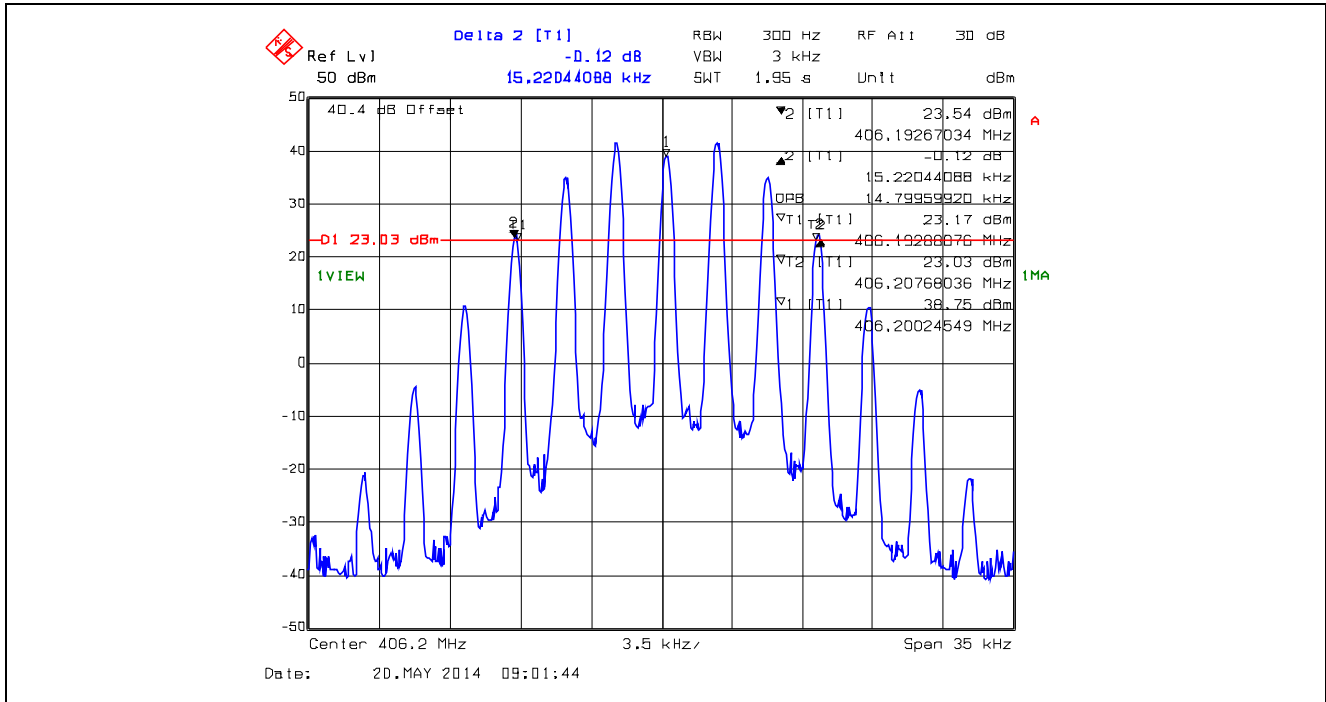

Plot 5.4.4.1.2. 99% Occupied Bandwidth for 25 kHz Channel Spacing, Analog  
 450.1 MHz, High Power, FM with 2.5 kHz sine wave signal

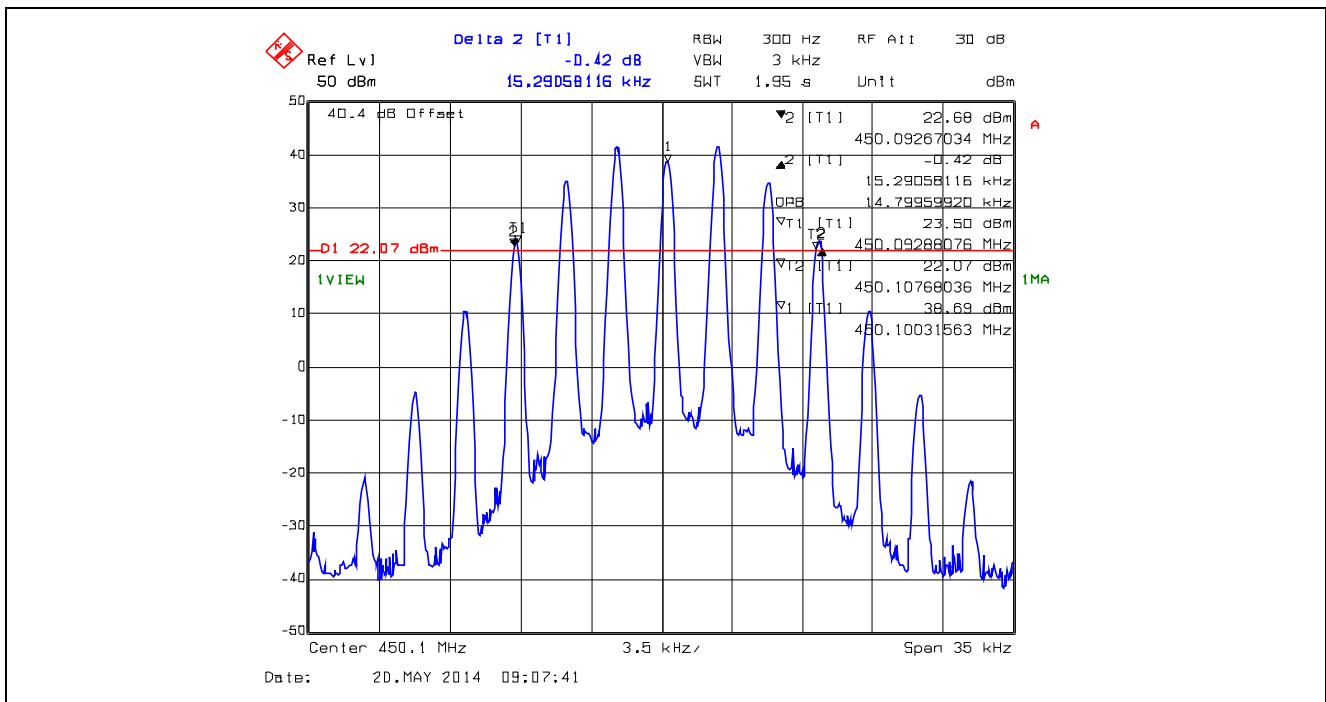



Plot 5.4.4.1.3. 99% Occupied Bandwidth for 25 kHz Channel Spacing, Analog  
 469.9 MHz, High Power, FM with 2.5 kHz sine wave signal

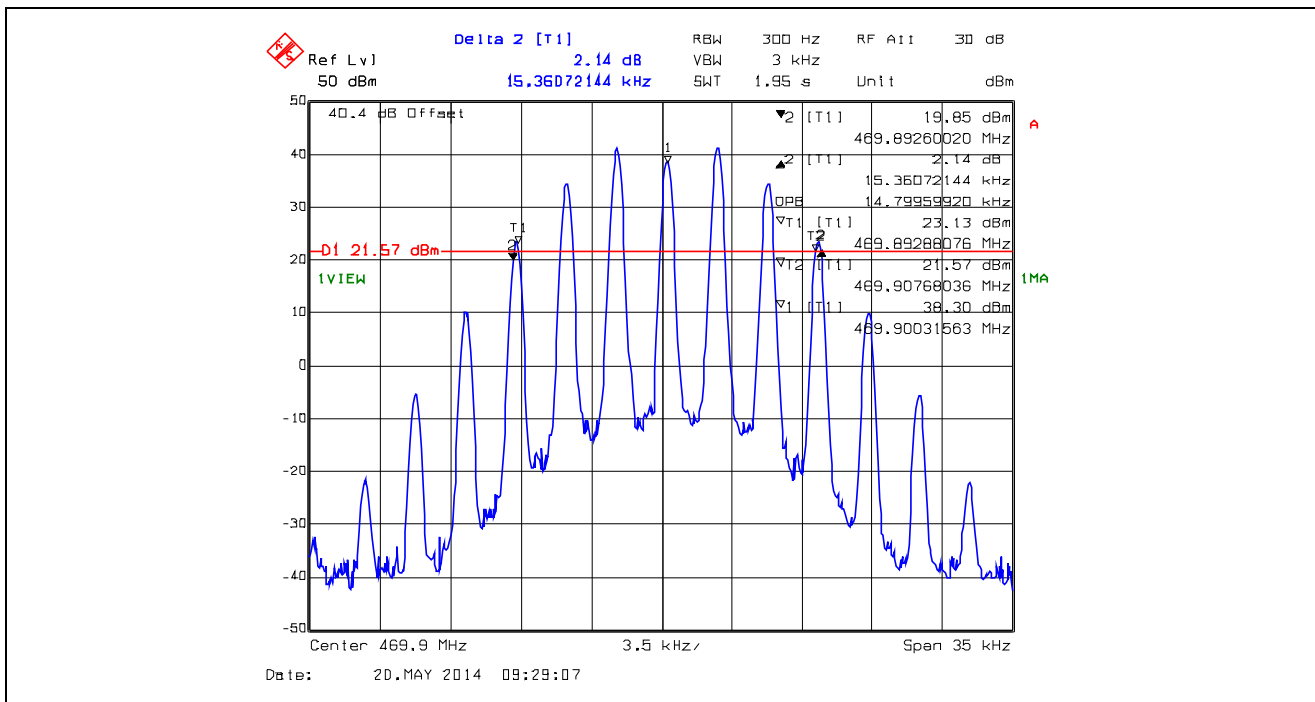

Plot 5.4.4.1.4. 99% Occupied Bandwidth for 12.5 kHz Channel Spacing, Analog  
 406.2 MHz, High Power, FM with 2.5 kHz sine wave signal

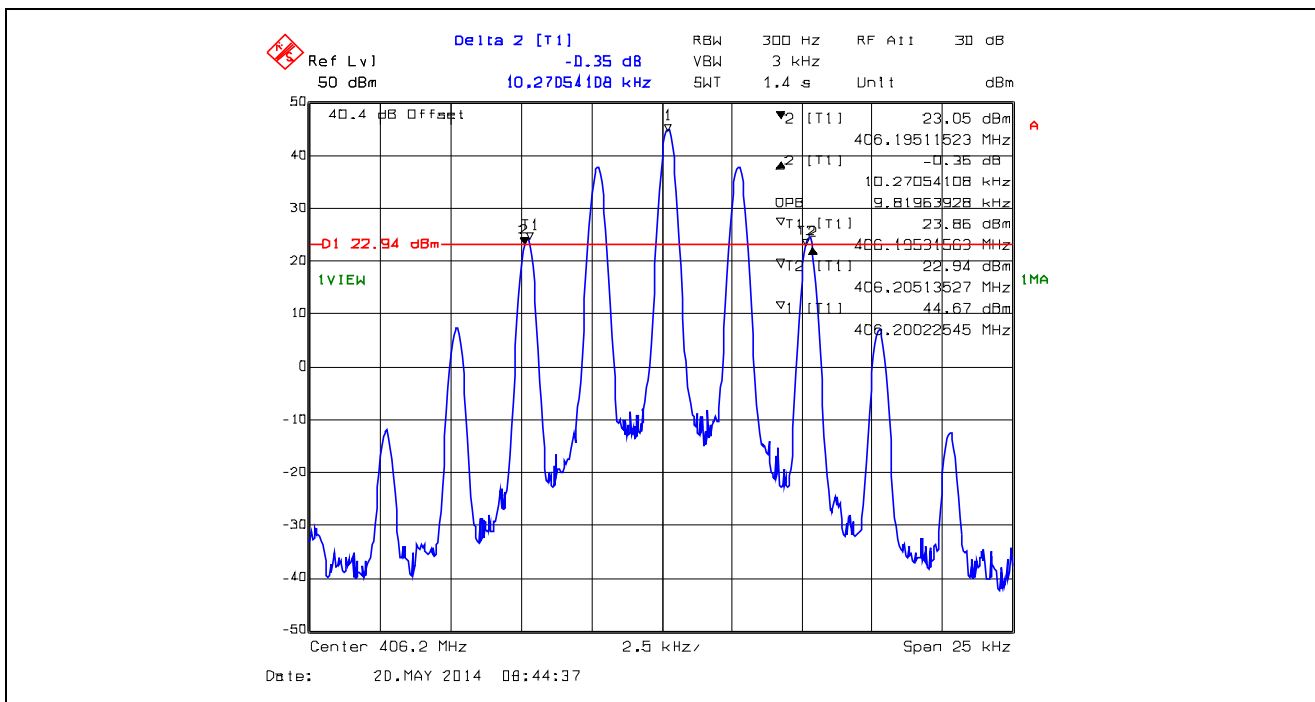

**ULTRATECH GROUP OF LABS**

3000 Bristol Circle, Oakville, Ontario, Canada L6H 6G4  
 Tel. #: 905-829-1570, Fax. #: 905-829-8050, Email: [vic@ultratech-labs.com](mailto:vic@ultratech-labs.com), Website: <http://www.ultratech-labs.com>

File #: ICOM-364F90

June 2, 2014

All test results contained in this engineering test report are traceable to National Institute of Standards and Technology (NIST)

Plot 5.4.4.1.5. 99% Occupied Bandwidth for 12.5 kHz Channel Spacing, Analog  
 450.1 MHz, High Power, FM with 2.5 kHz sine wave signal

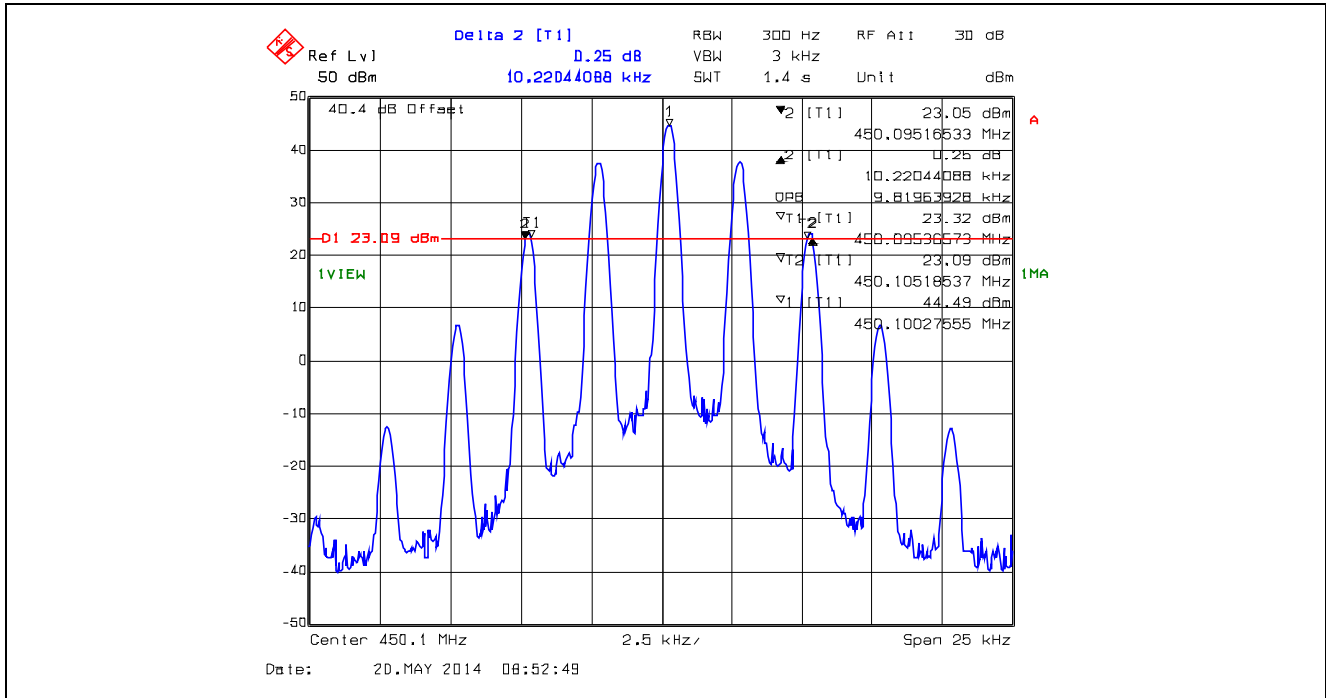

Plot 5.4.4.1.6. 99% Occupied Bandwidth for 12.5 kHz Channel Spacing, Analog  
 469.9 MHz, High Power, FM with 2.5 kHz sine wave signal

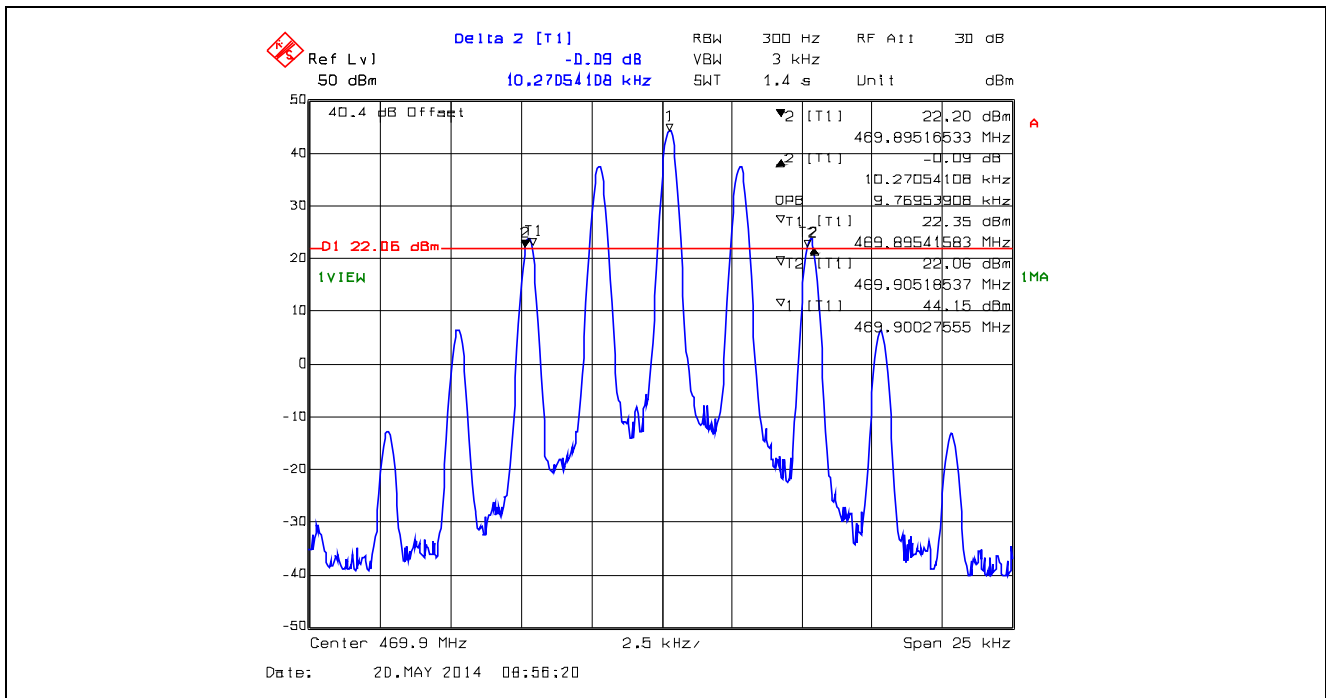

Plot 5.4.4.1.7. 99% Occupied Bandwidth for 12.5 kHz Channel Spacing, Digital  
 406.2 MHz, High Power

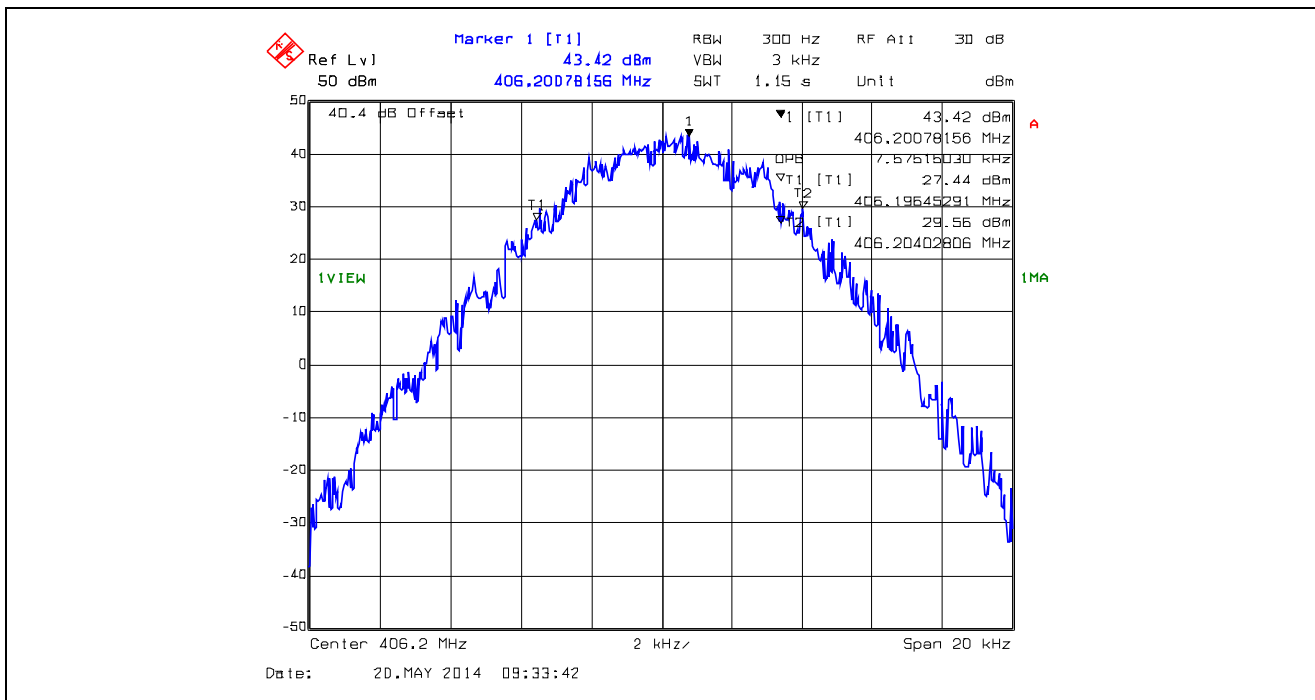

Plot 5.4.4.1.8. 99% Occupied Bandwidth for 12.5 kHz Channel Spacing, Digital  
 450.1 MHz, High Power

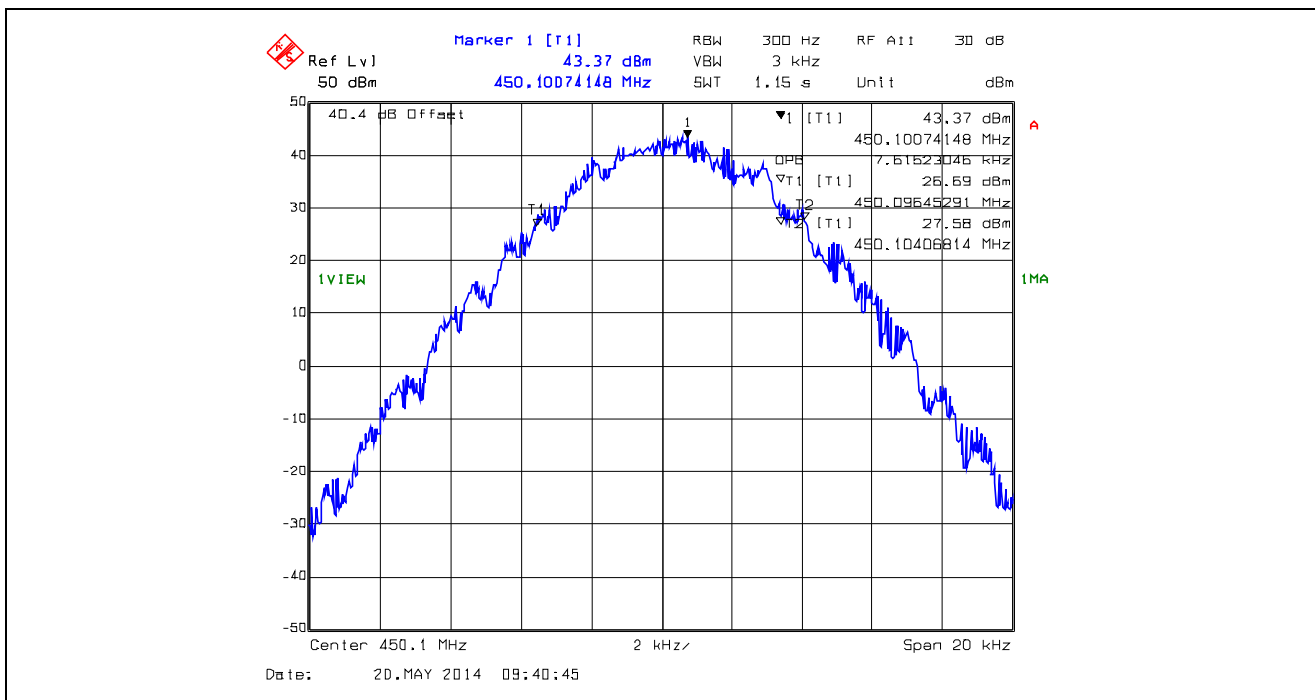

**Plot 5.4.4.1.9.** 99% Occupied Bandwidth for 12.5 kHz Channel Spacing, Digital  
 469.9 MHz, High Power

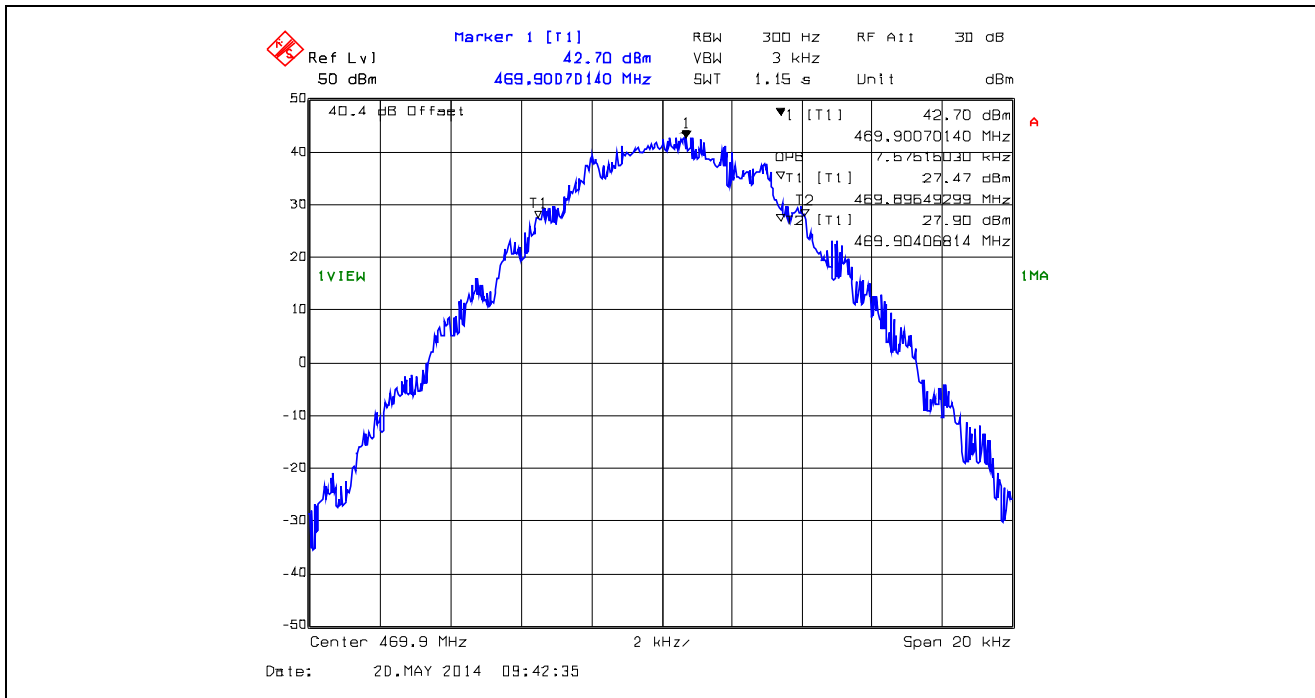

**Plot 5.4.4.1.10.** 99% Occupied Bandwidth for 6.25 kHz Channel Spacing, Digital  
 406.2 MHz, High Power

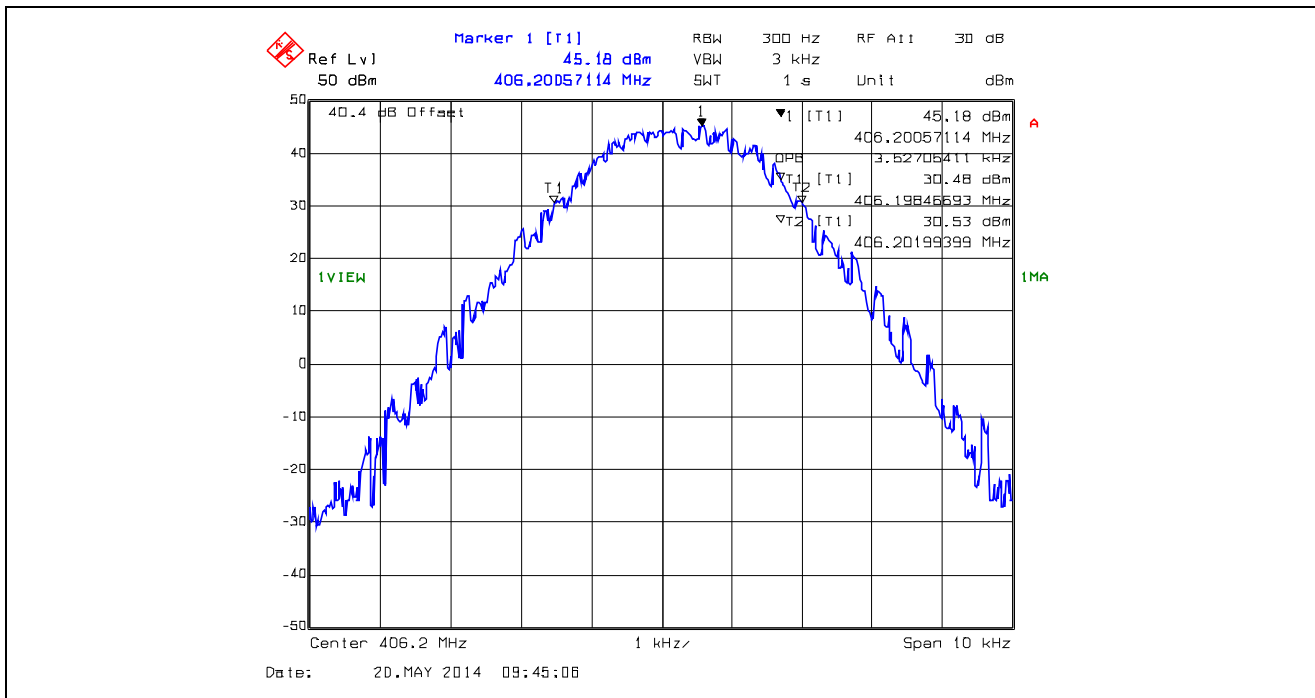

Plot 5.4.4.1.11. 99% Occupied Bandwidth for 6.25 kHz Channel Spacing, Digital  
 450.1 MHz, High Power

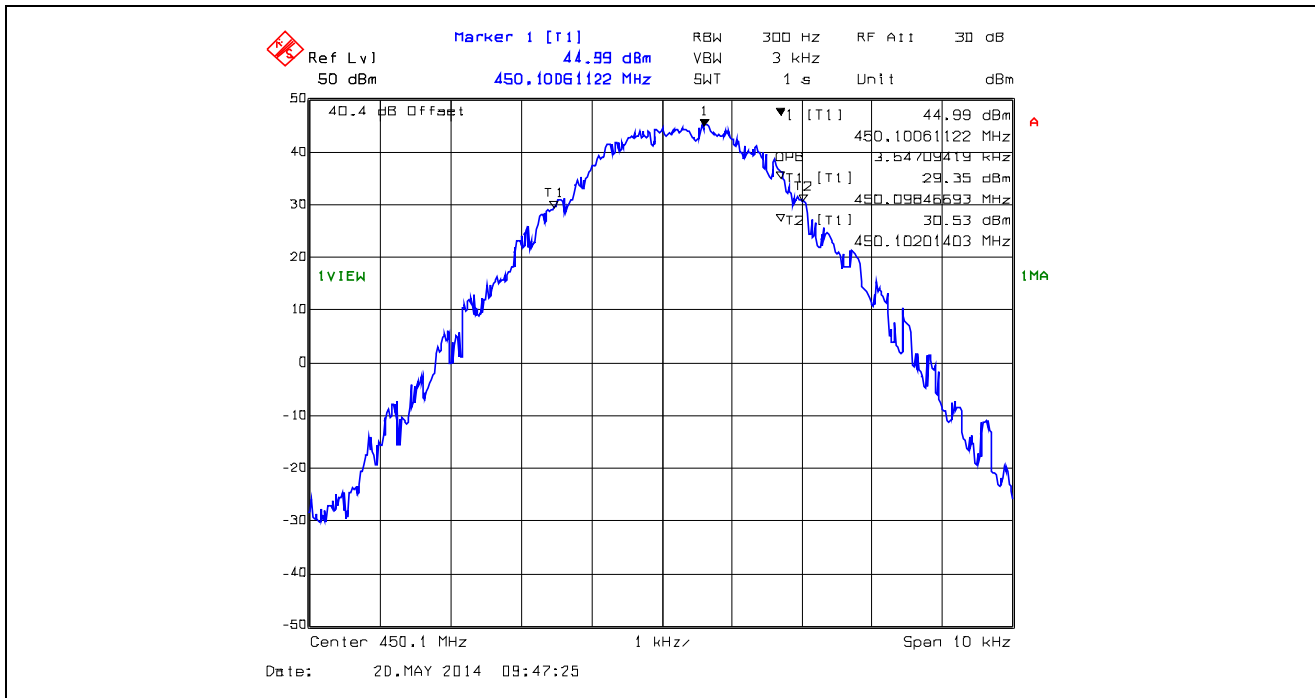

Plot 5.4.4.1.12. 99% Occupied Bandwidth for 6.25 kHz Channel Spacing, Digital  
 469.9 MHz, High Power

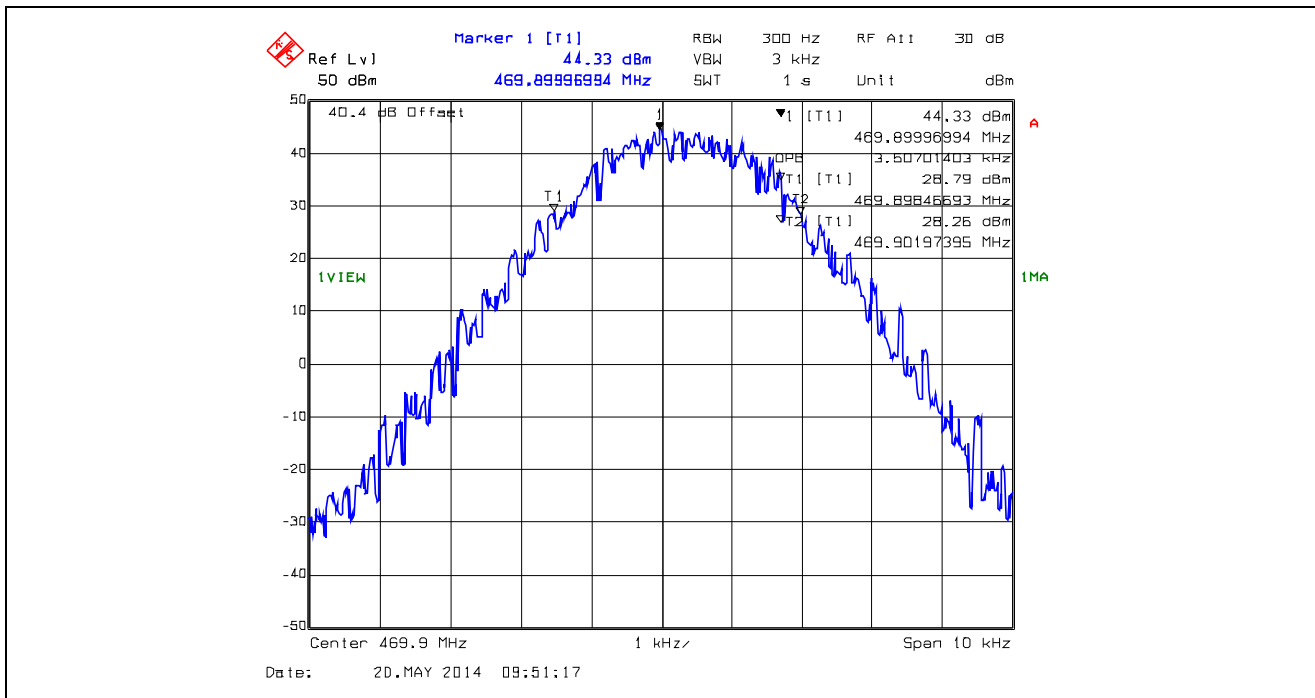

### 5.4.4.2. Emission Mask B

Plot 5.4.4.2.1. Emission Mask B, 406.2 MHz, Analog, High Power

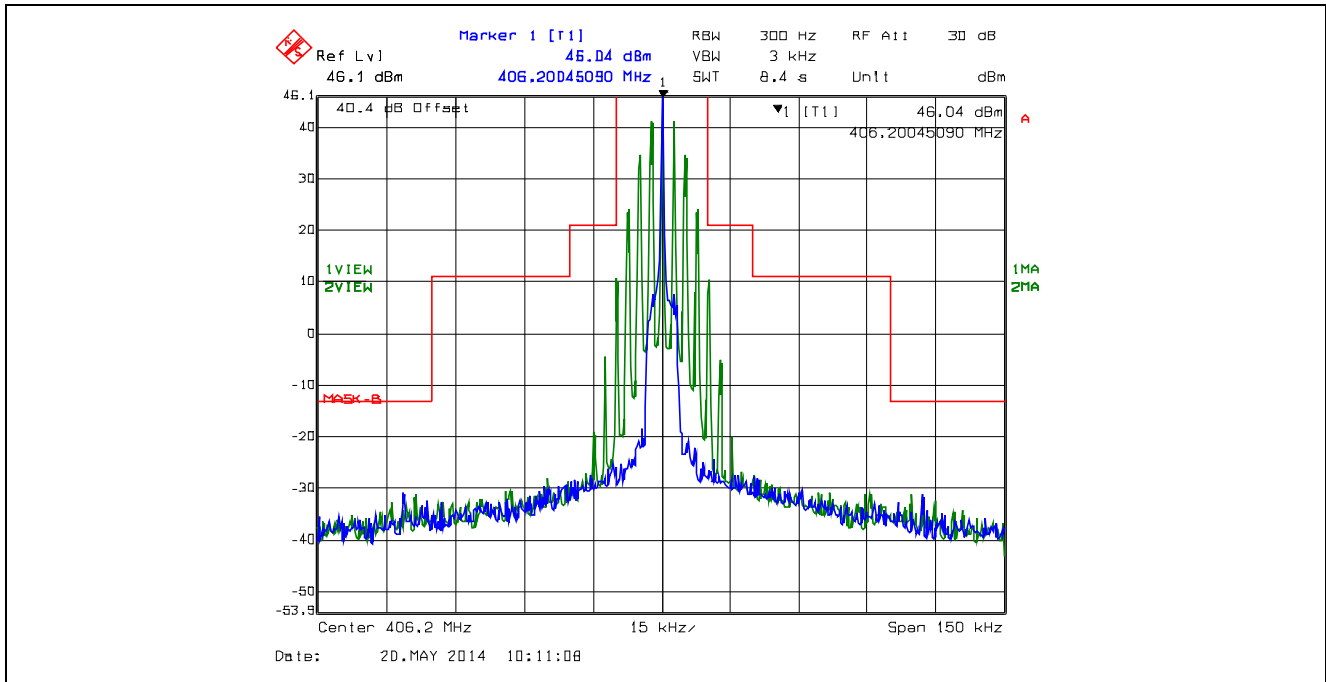

Plot 5.4.4.2.2. Emission Mask B, 406.2 MHz, Analog, Low Power

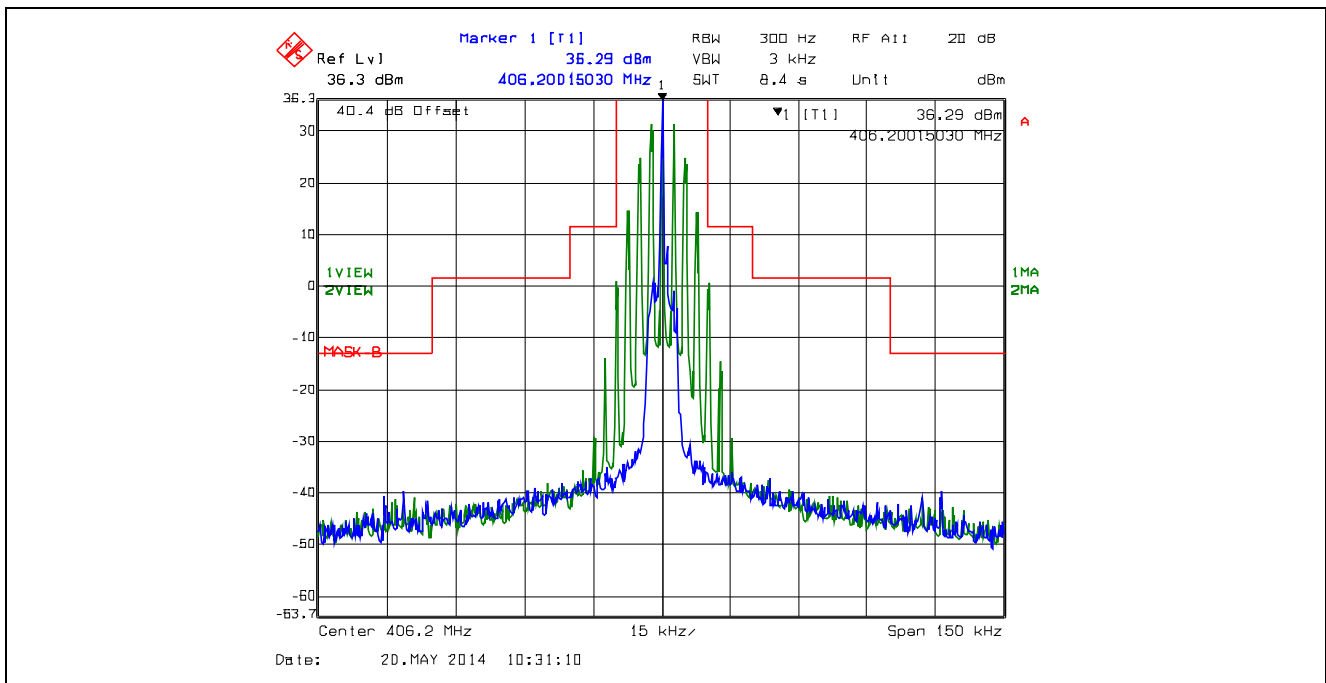

Plot 5.4.4.2.3. Emission Mask B, 450.1 MHz, Analog, High Power

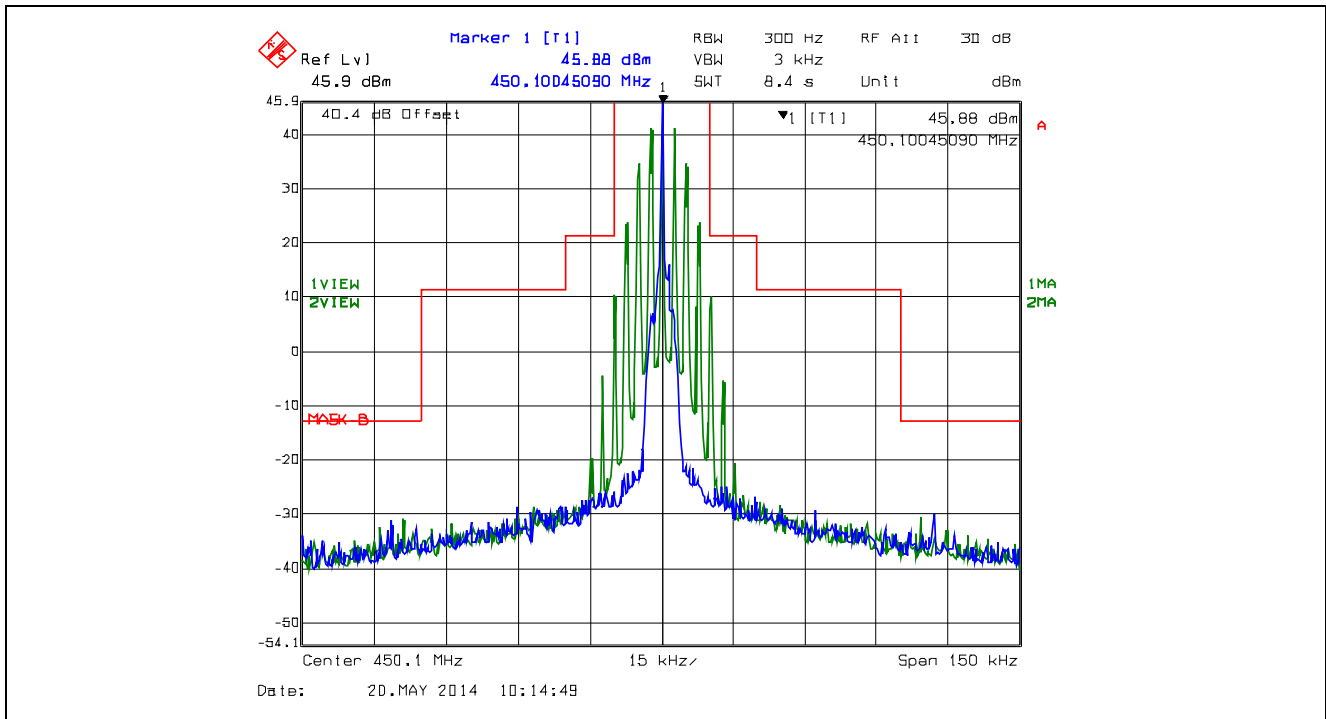

Plot 5.4.4.2.4. Emission Mask B, 450.1 MHz, Analog, Low Power

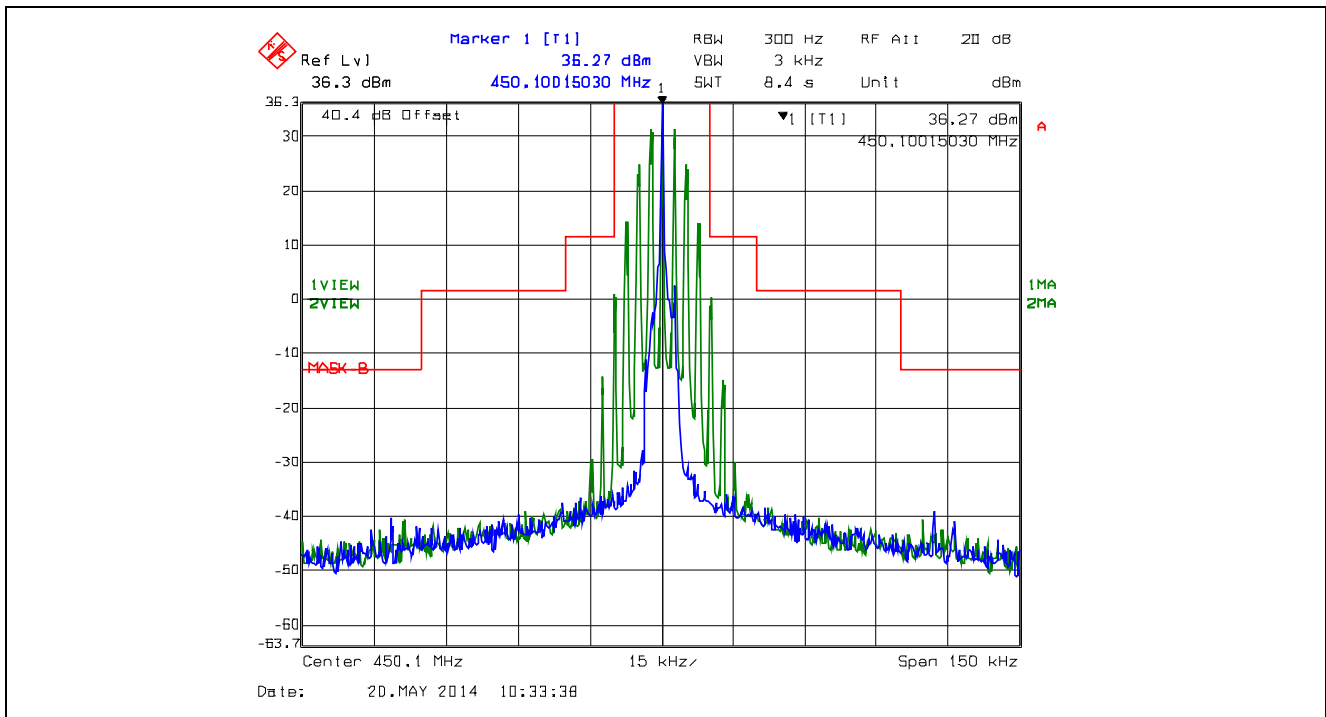

**ULTRATECH GROUP OF LABS**

3000 Bristol Circle, Oakville, Ontario, Canada L6H 6G4  
Tel. #: 905-829-1570, Fax. #: 905-829-8050, Email: [vic@ultratech-labs.com](mailto:vic@ultratech-labs.com), Website: <http://www.ultratech-labs.com>

File #: ICOM-364F90

June 2, 2014

All test results contained in this engineering test report are traceable to National Institute of Standards and Technology (NIST)

Plot 5.4.4.2.5. Emission Mask B, 469.9 MHz, Analog, High Power

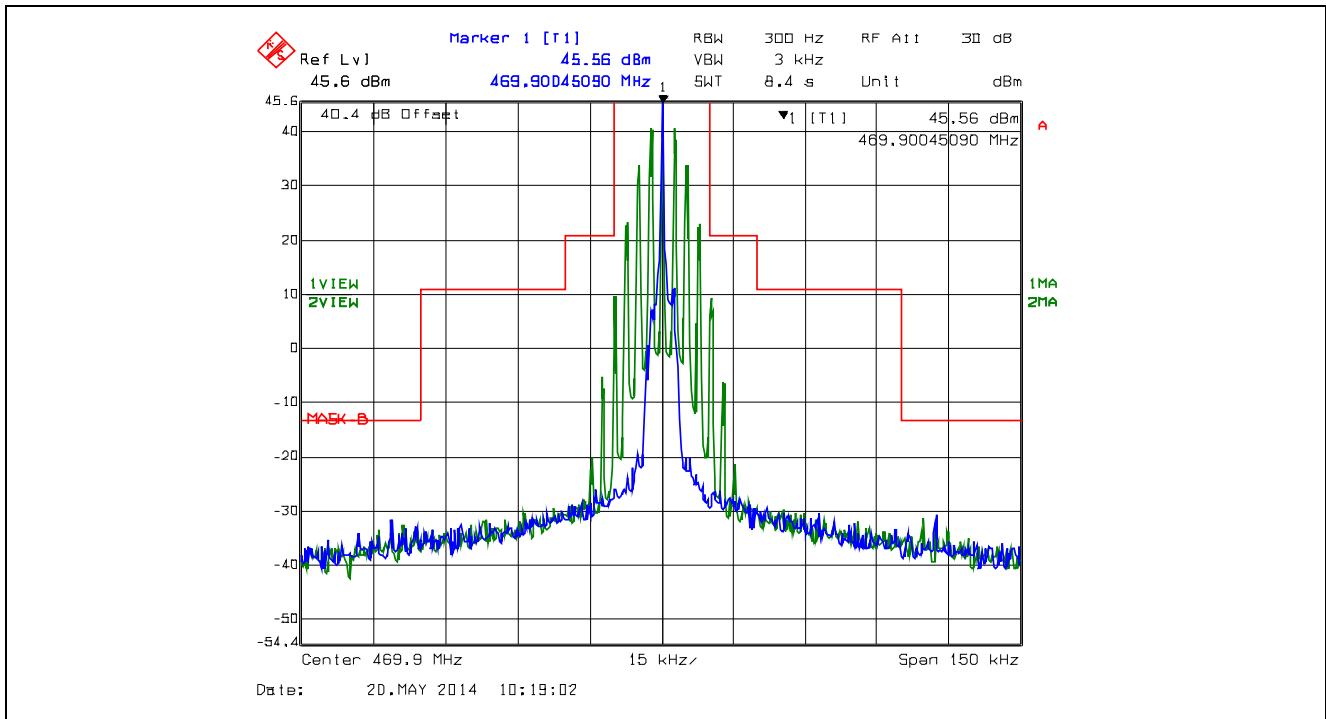

Plot 5.4.4.2.6. Emission Mask B, 469.9 MHz, Analog, Low Power

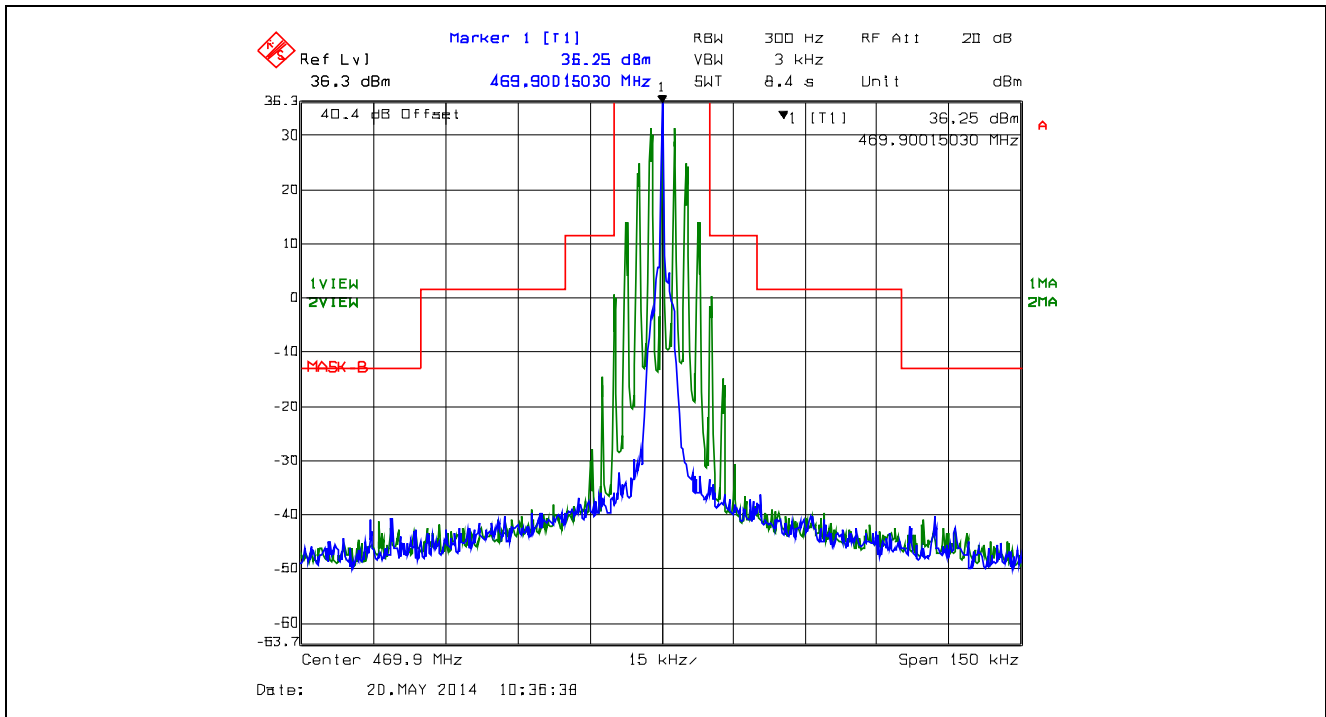



### 5.4.4.3. Emission Mask D

Plot 5.4.4.3.1. Emission Mask D, 406.2 MHz, Analog, High Power

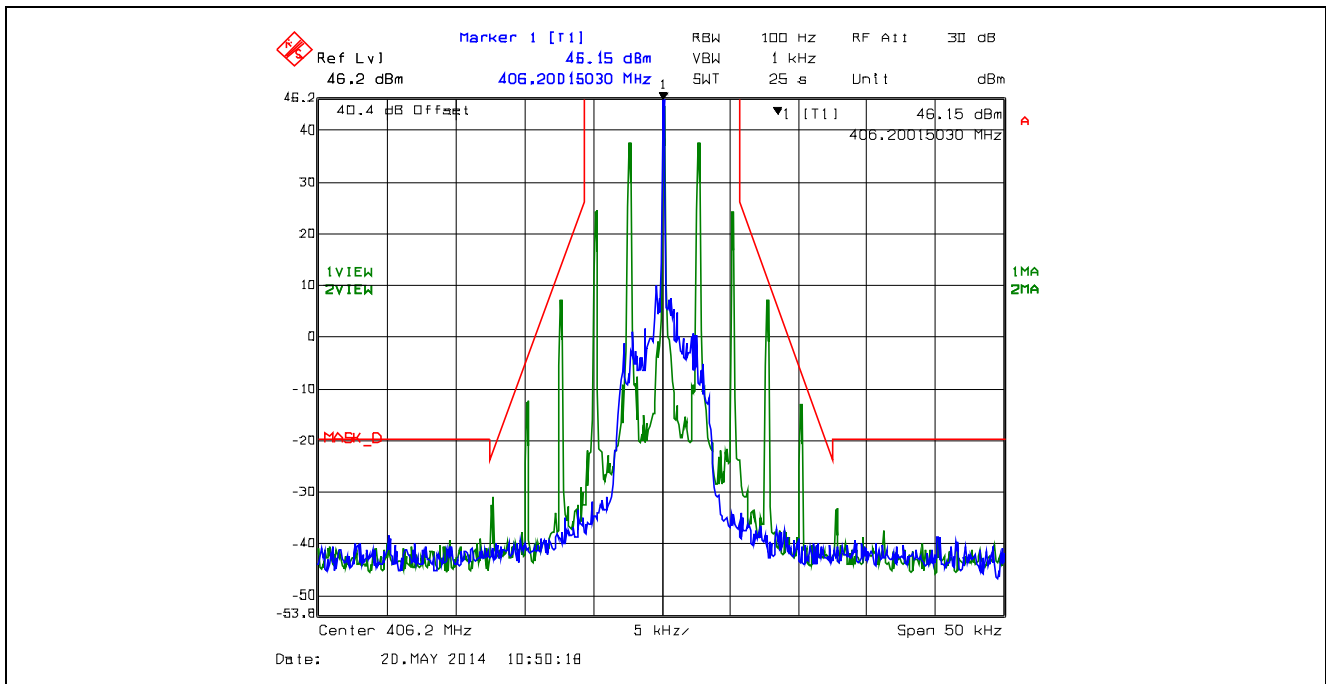

Plot 5.4.4.3.2. Emission Mask D, 406.2 MHz, Analog, Low Power

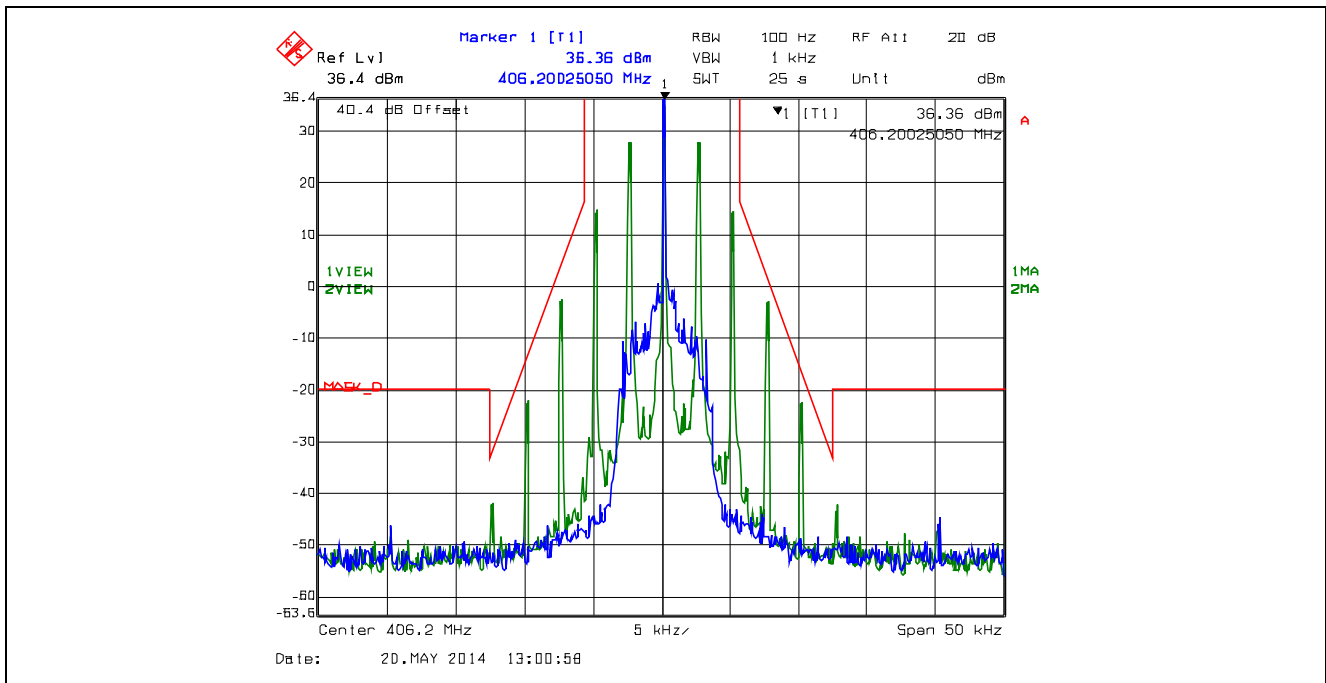

## ULTRATECH GROUP OF LABS

3000 Bristol Circle, Oakville, Ontario, Canada L6H 6G4  
Tel. #: 905-829-1570, Fax. #: 905-829-8050, Email: [vic@ultratech-labs.com](mailto:vic@ultratech-labs.com), Website: <http://www.ultratech-labs.com>

File #: ICOM-364F90

June 2, 2014

All test results contained in this engineering test report are traceable to National Institute of Standards and Technology (NIST)

Plot 5.4.4.3.3. Emission Mask D, 450.1 MHz, Analog, High Power

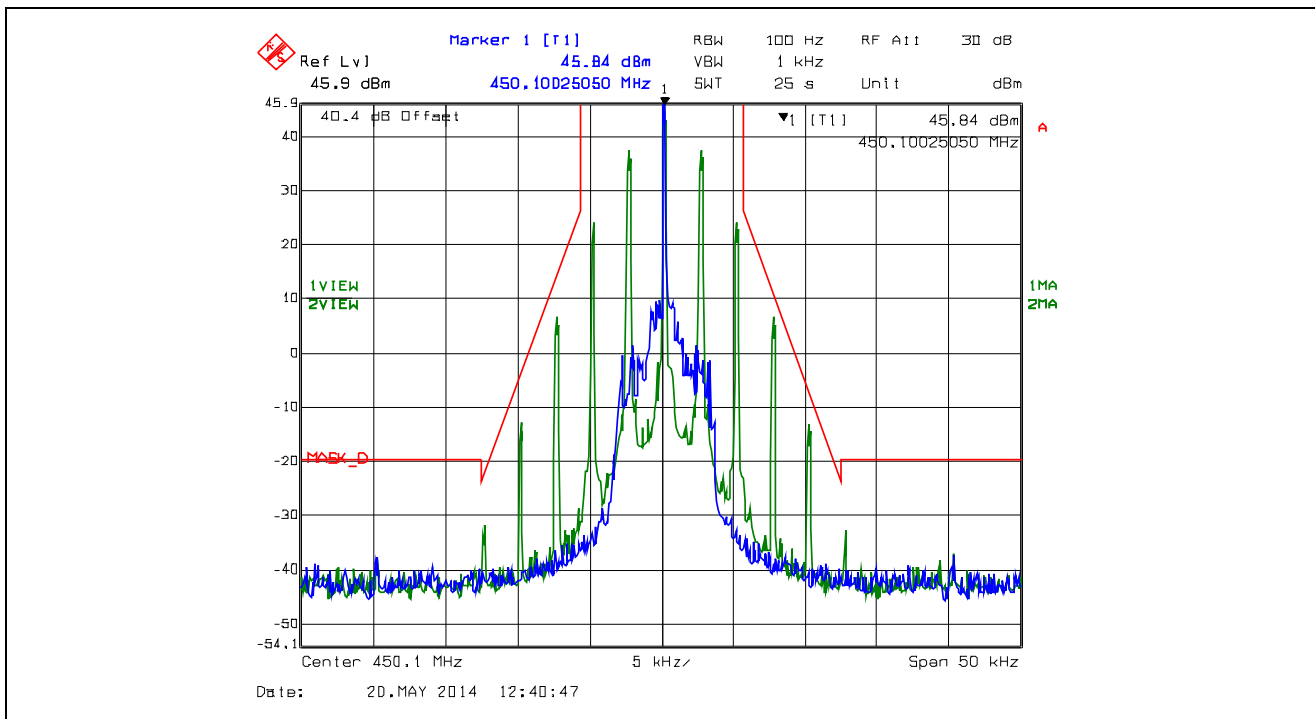

Plot 5.4.4.3.4. Emission Mask D, 450.1 MHz, Analog, Low Power

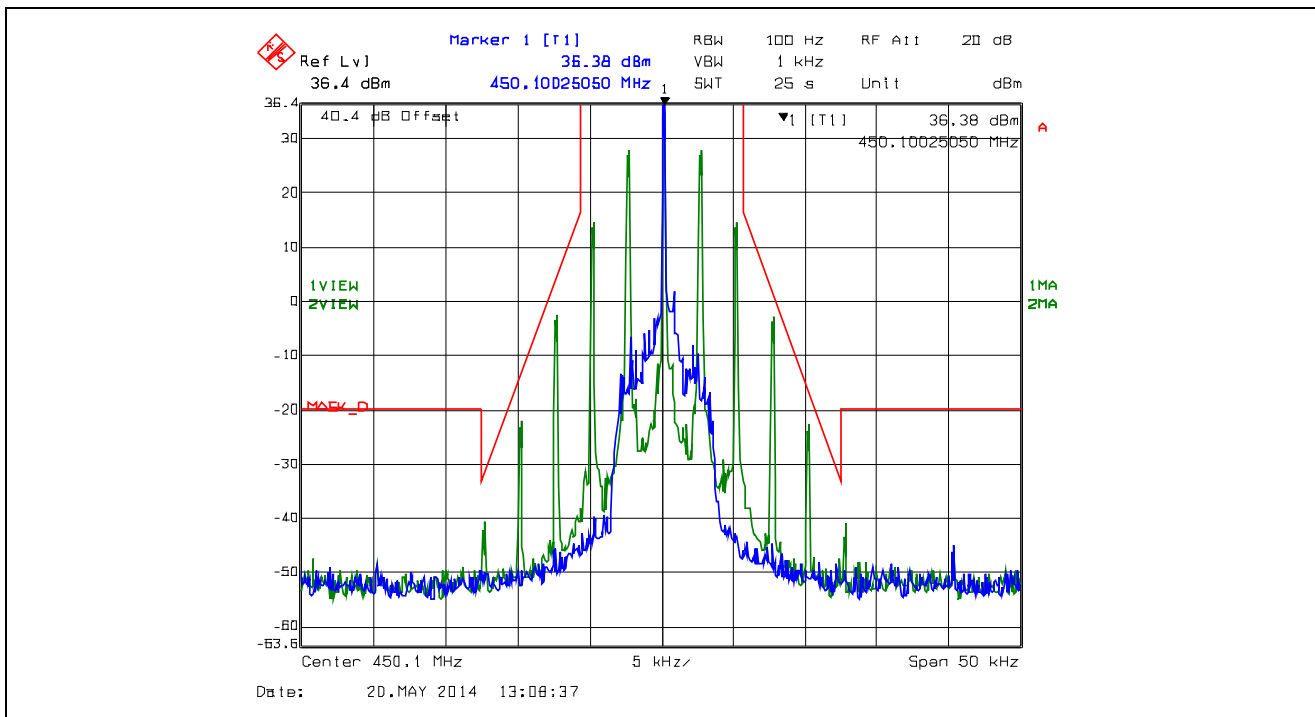

**ULTRATECH GROUP OF LABS**

3000 Bristol Circle, Oakville, Ontario, Canada L6H 6G4  
 Tel. #: 905-829-1570, Fax. #: 905-829-8050, Email: [vic@ultratech-labs.com](mailto:vic@ultratech-labs.com), Website: <http://www.ultratech-labs.com>

File #: ICOM-364F90

June 2, 2014

All test results contained in this engineering test report are traceable to National Institute of Standards and Technology (NIST)

Plot 5.4.4.3.5. Emission Mask D, 469.9 MHz, Analog, High Power

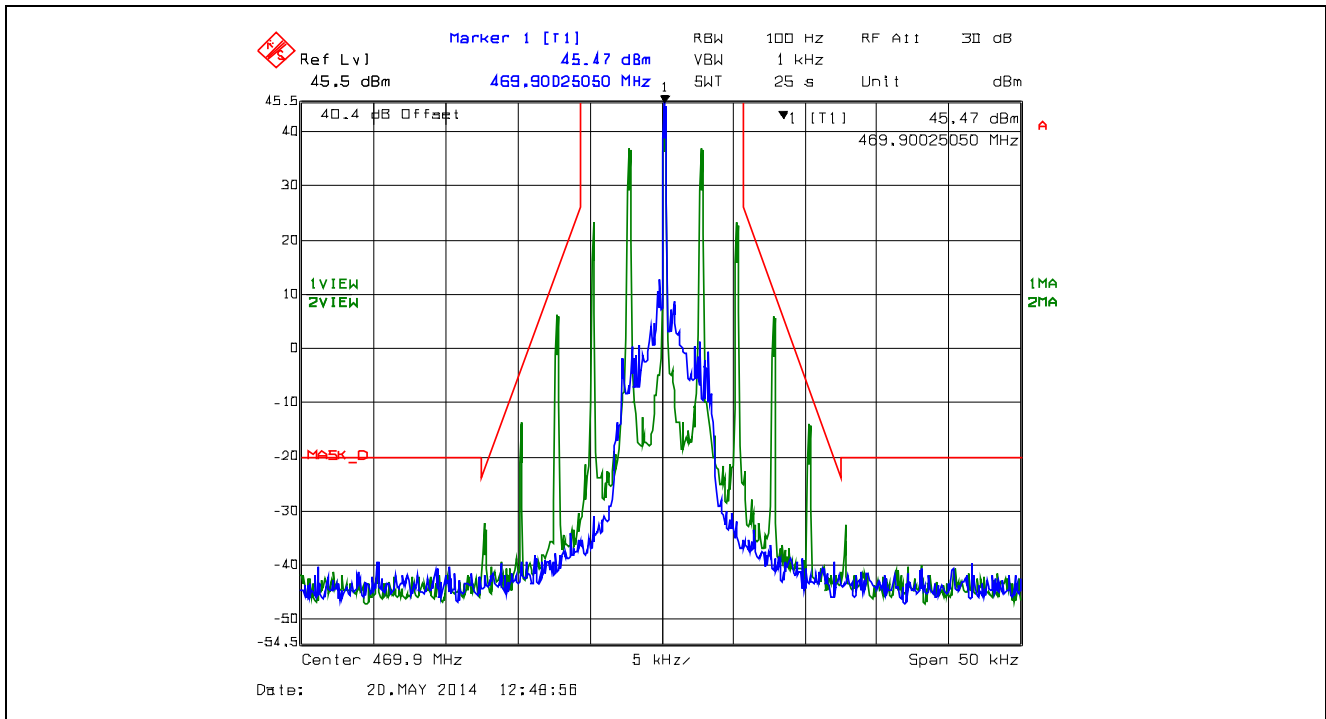

Plot 5.4.4.3.6. Emission Mask D, 469.9 MHz, Analog, Low Power

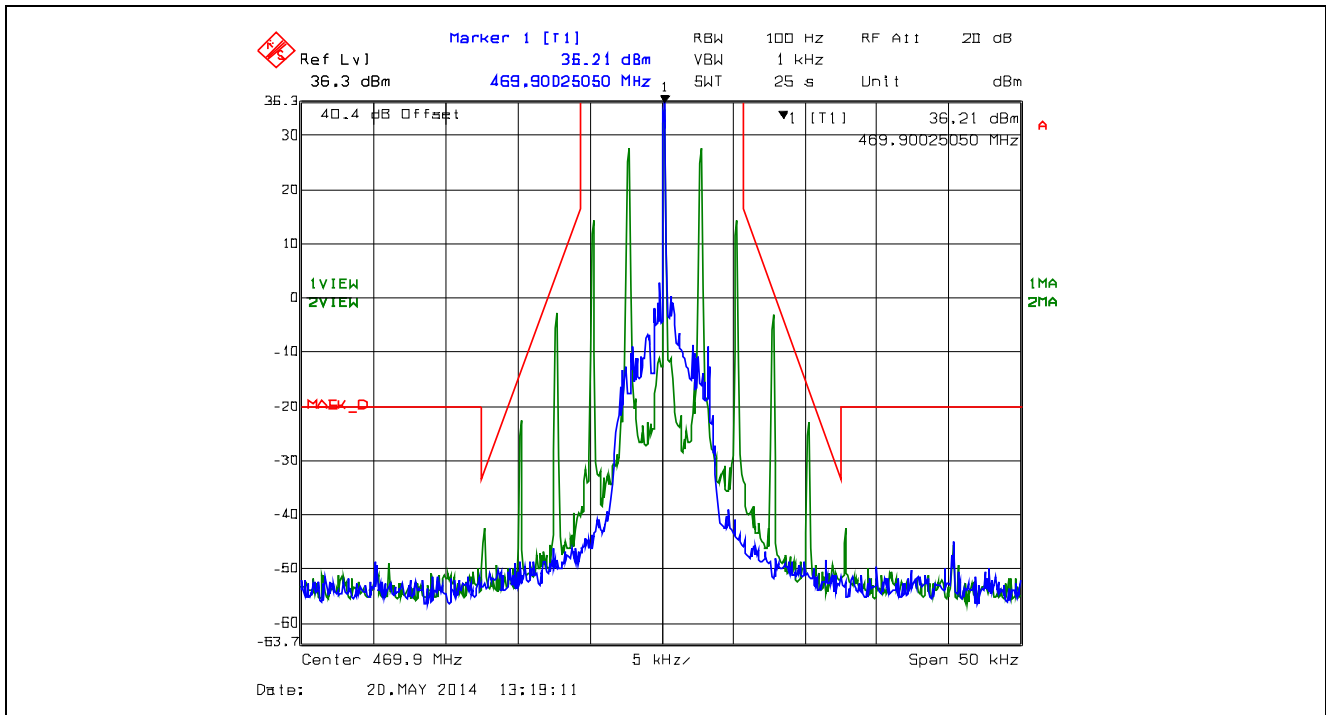

Plot 5.4.4.3.7. Emission Mask D, 406.2 MHz, Digital, High Power

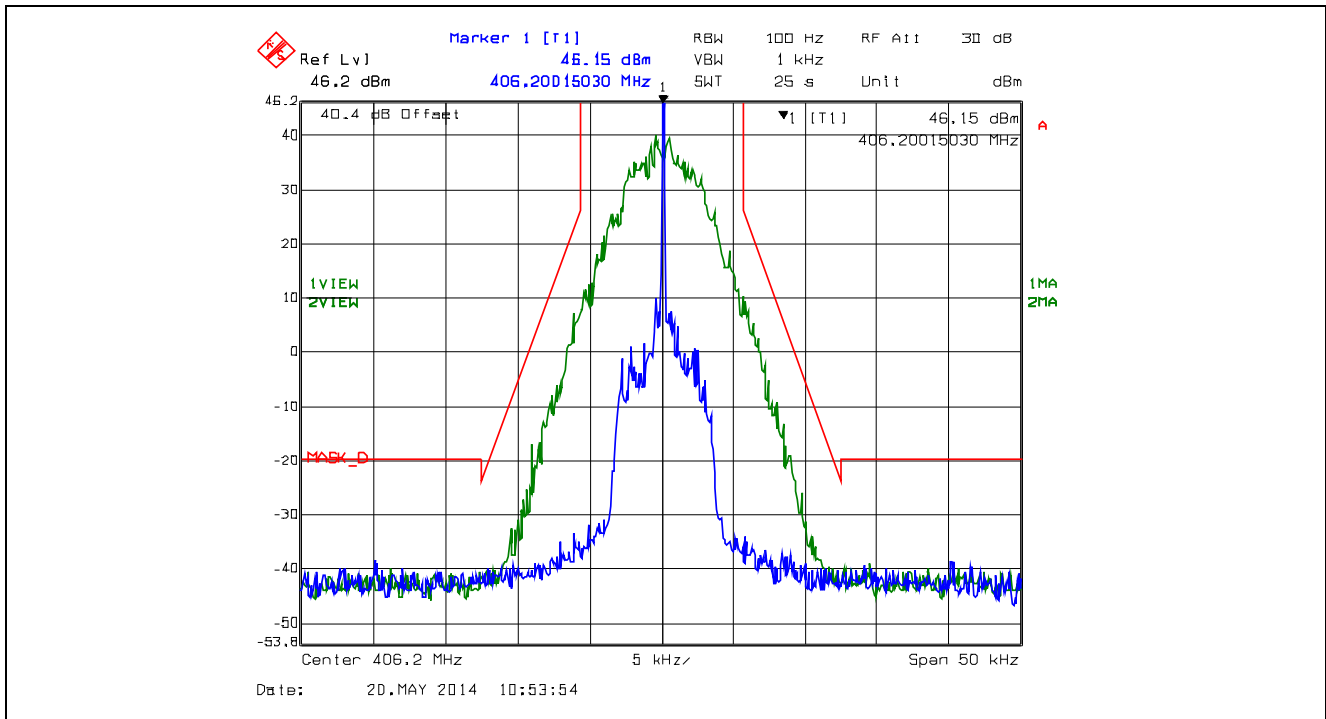

Plot 5.4.4.3.8. Emission Mask D, 406.2 MHz, Digital, Low Power

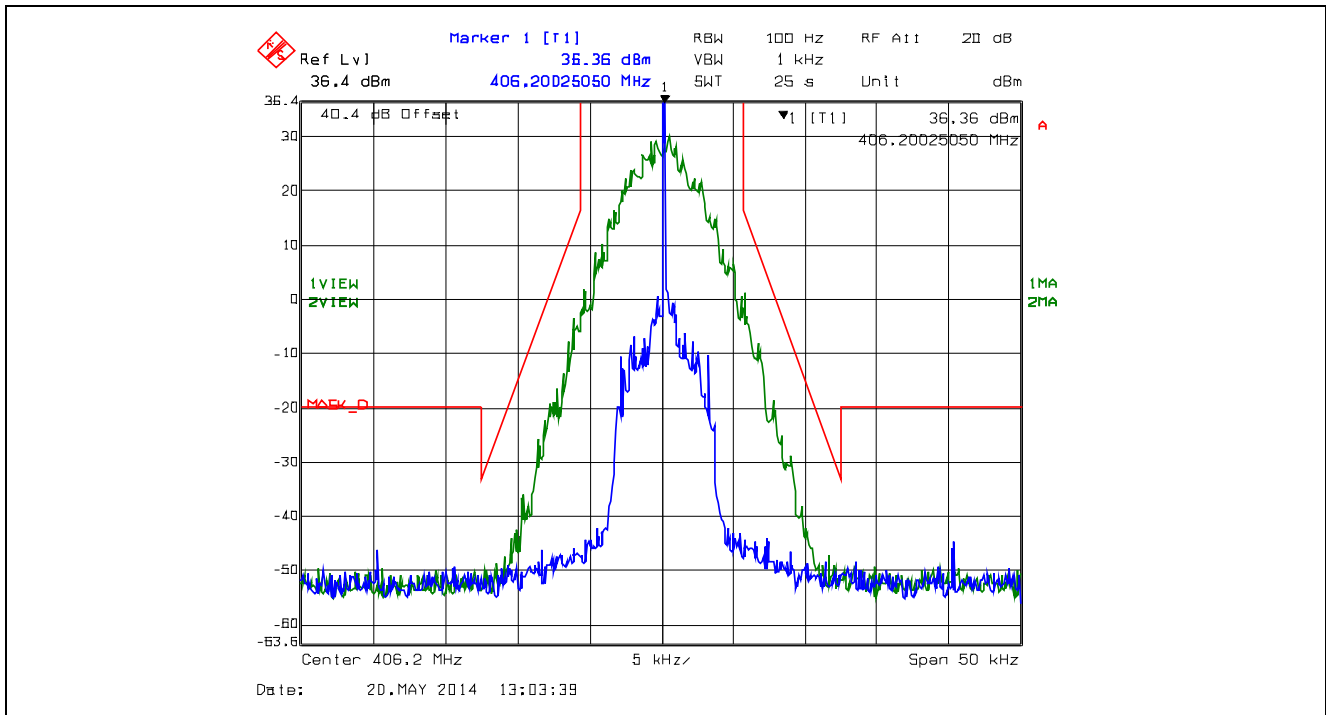

Plot 5.4.4.3.9. Emission Mask D, 450.1 MHz, Digital, High Power

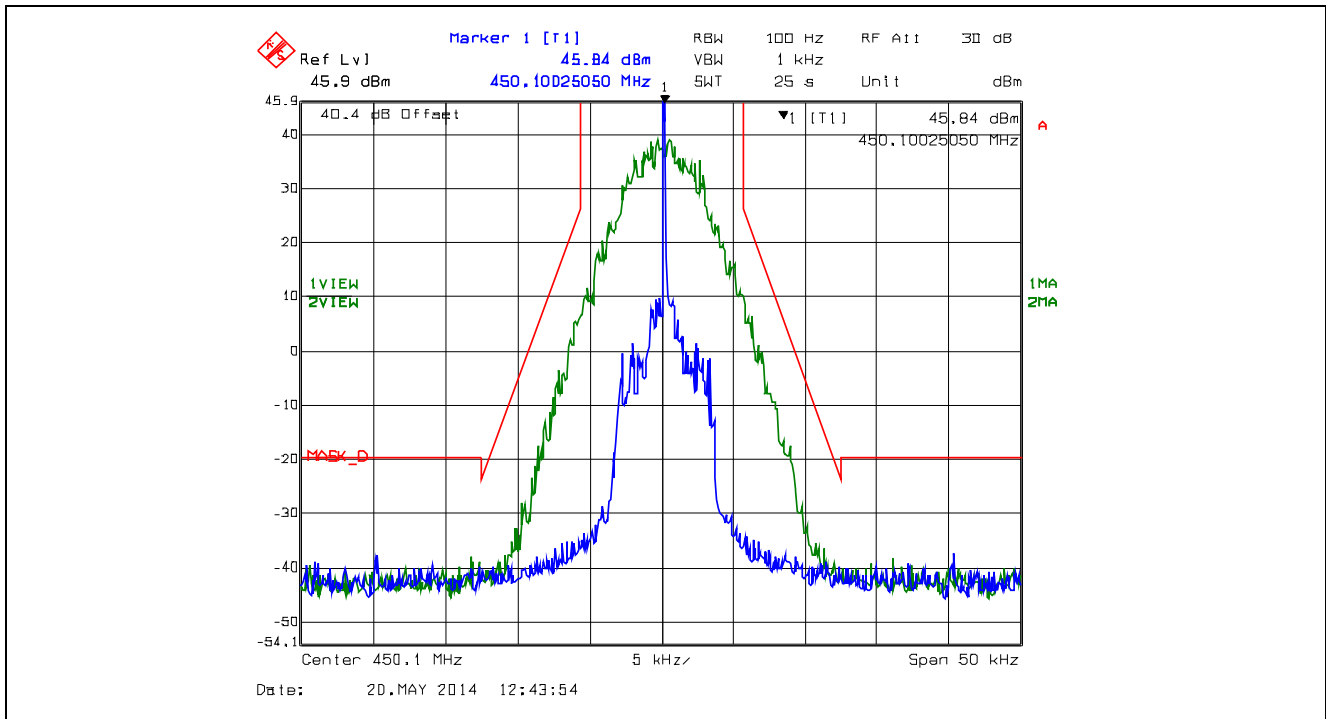

Plot 5.4.4.3.10. Emission Mask D, 450.1 MHz, Digital, Low Power

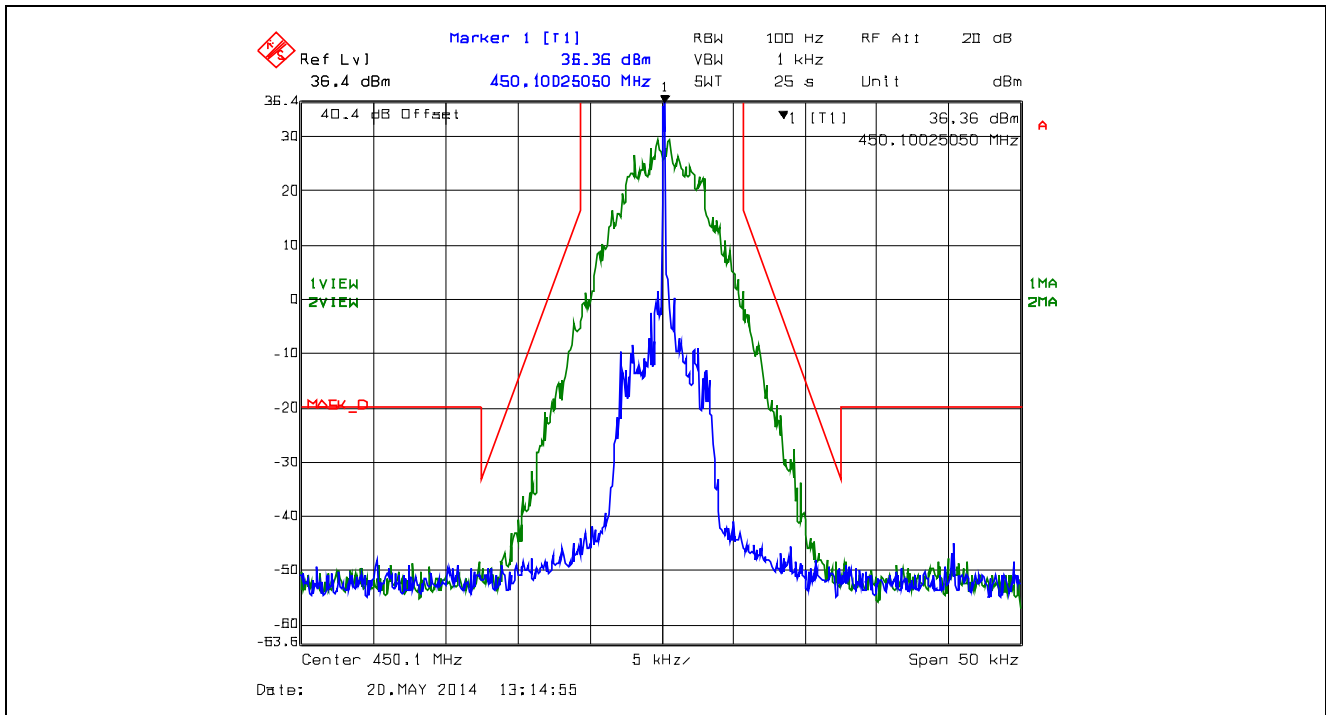

Plot 5.4.4.3.11. Emission Mask D, 469.9 MHz, Digital, High Power

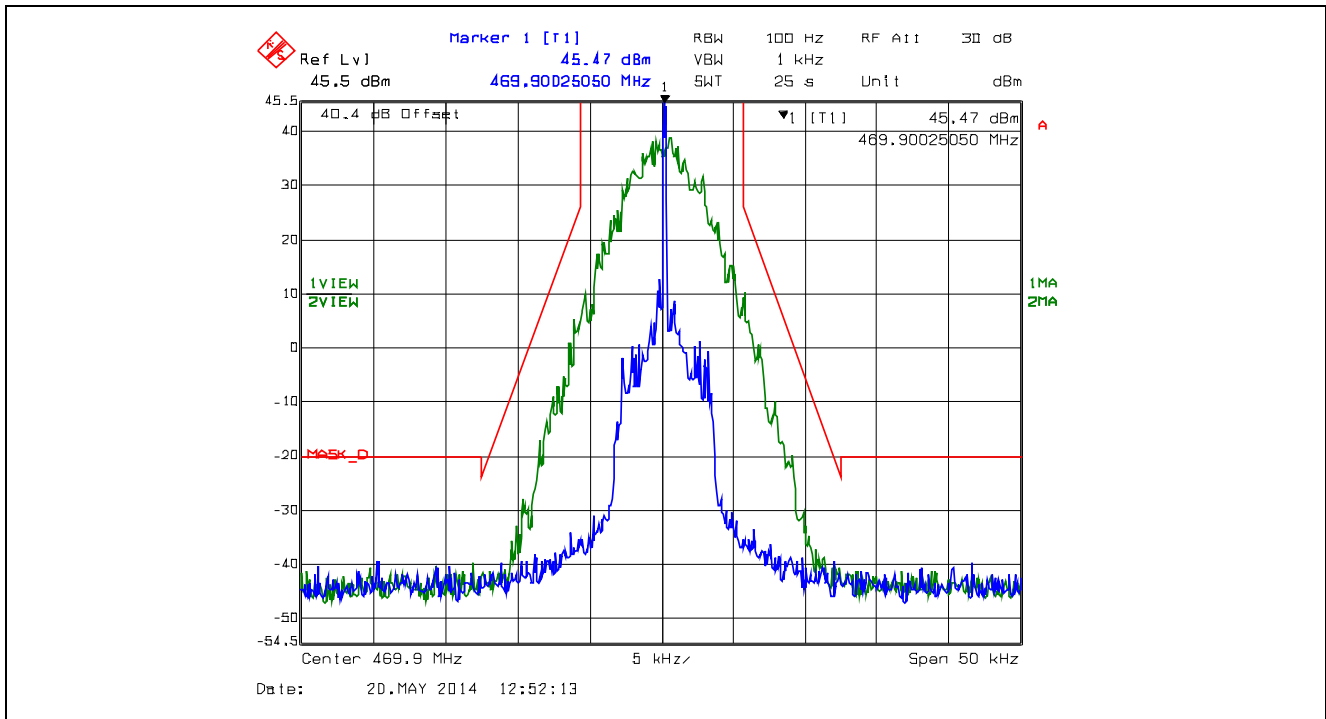

Plot 5.4.4.3.12. Emission Mask D, 469.9 MHz, Digital, Low Power

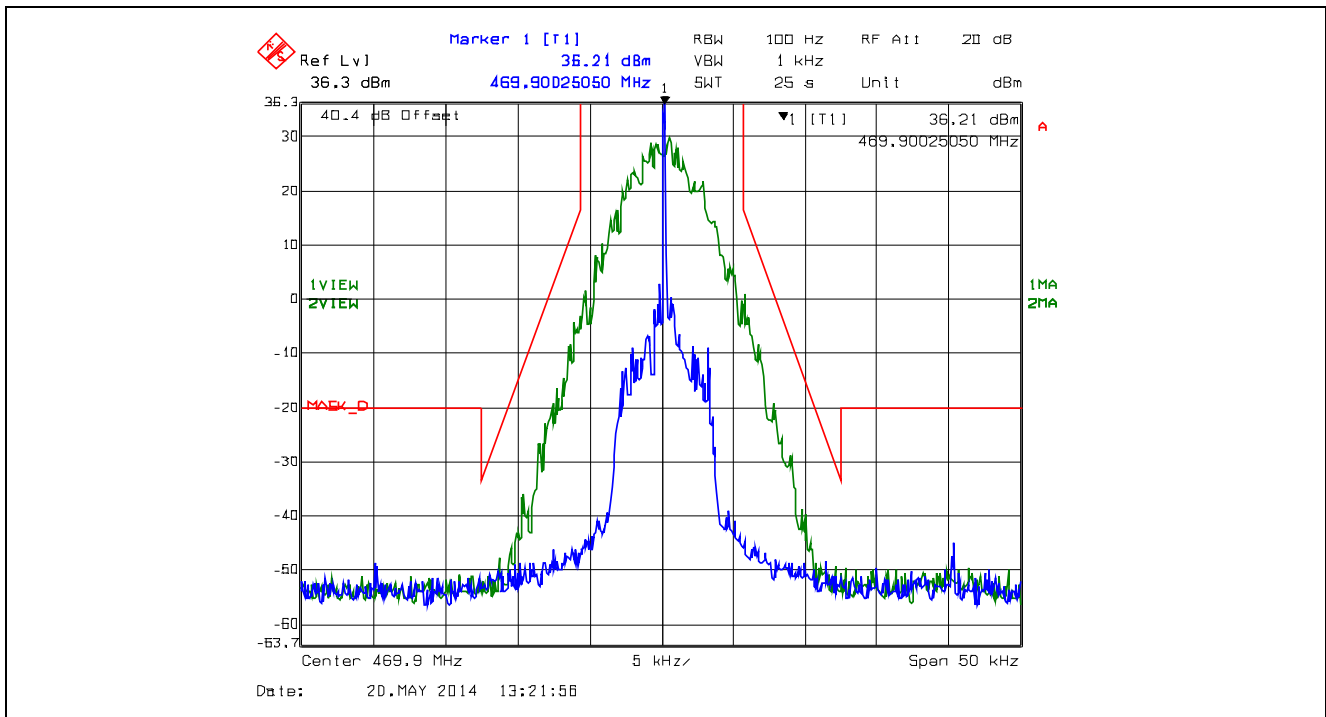

5.4.4.4. Emission Mask E

Plot 5.4.4.4.1. Emission Mask E, 406.2 MHz, Digital, High Power

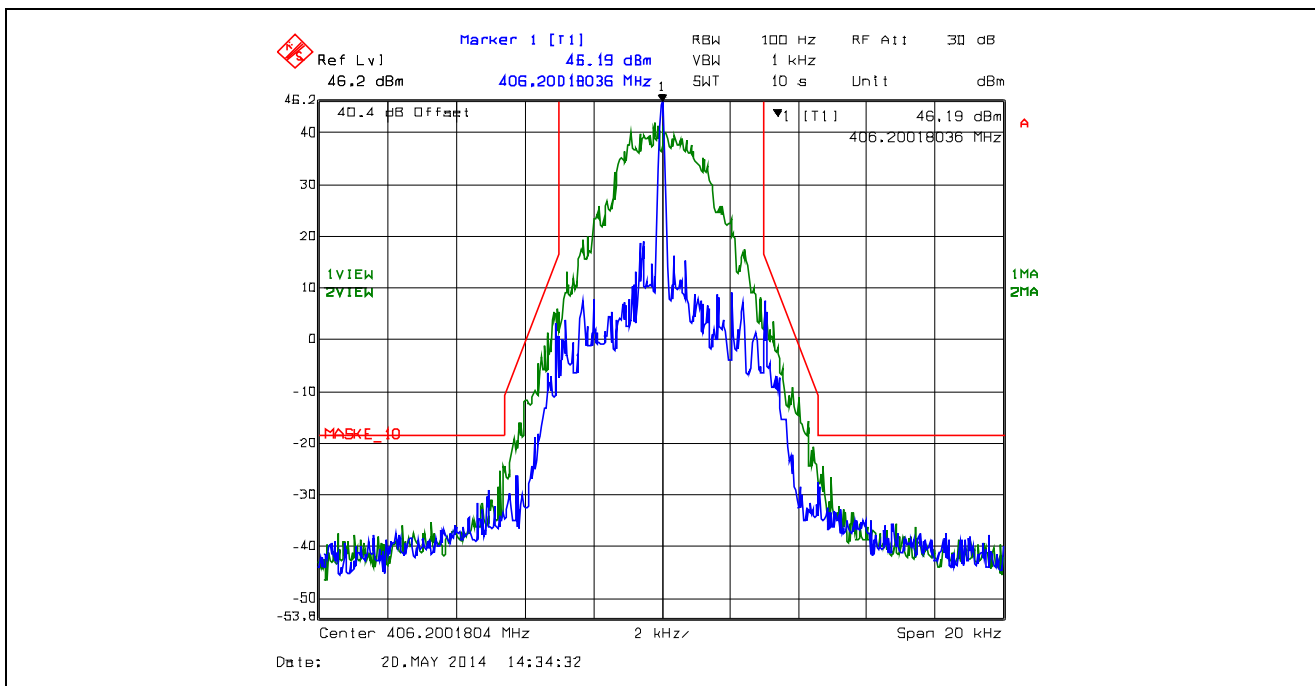

Plot 5.4.4.4.2. Emission Mask E, 406.2 MHz, Digital, Low Power

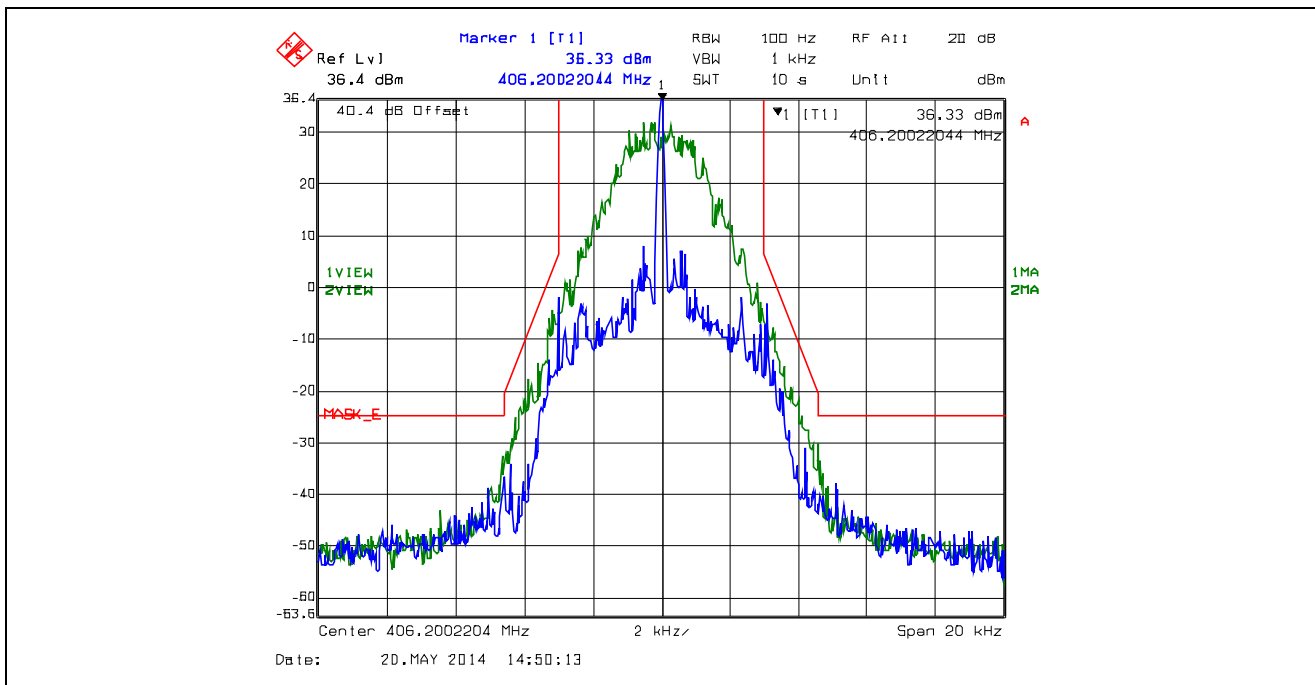

Plot 5.4.4.4.3. Emission Mask E, 450.1 MHz, Digital, High Power

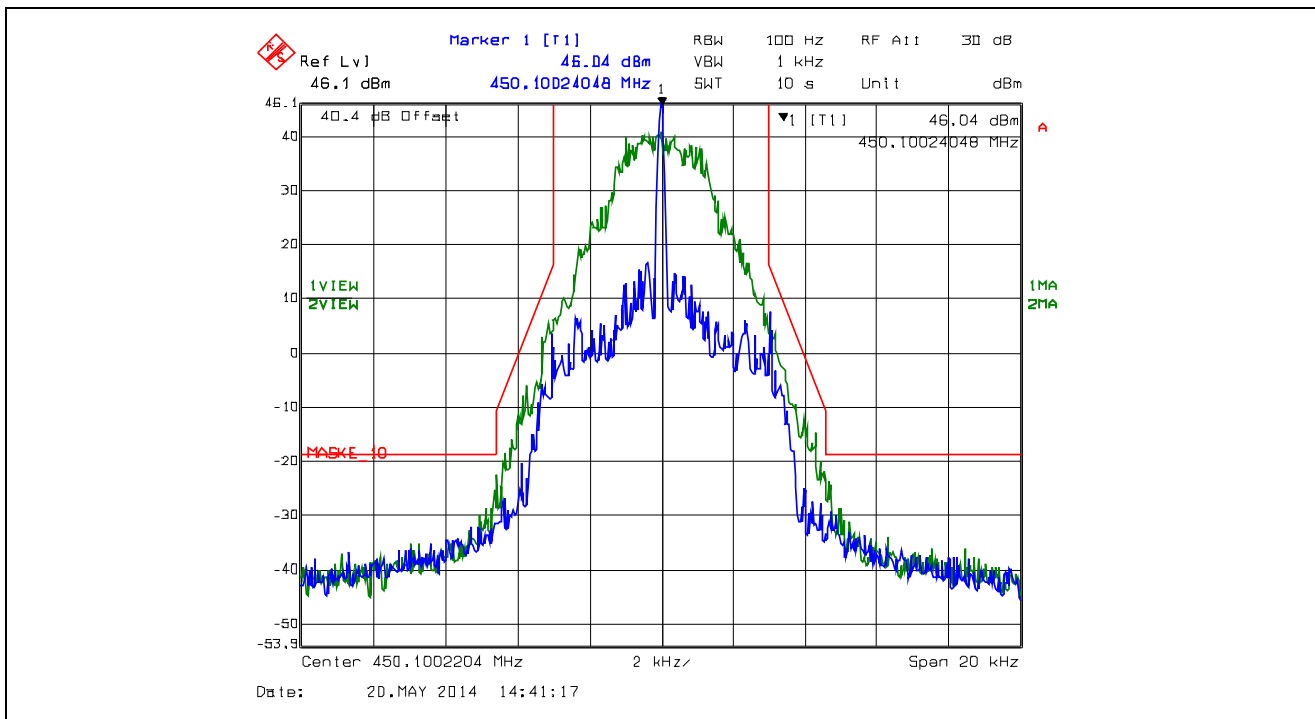

Plot 5.4.4.4.4. Emission Mask E, 450.1 MHz, Digital, Low Power

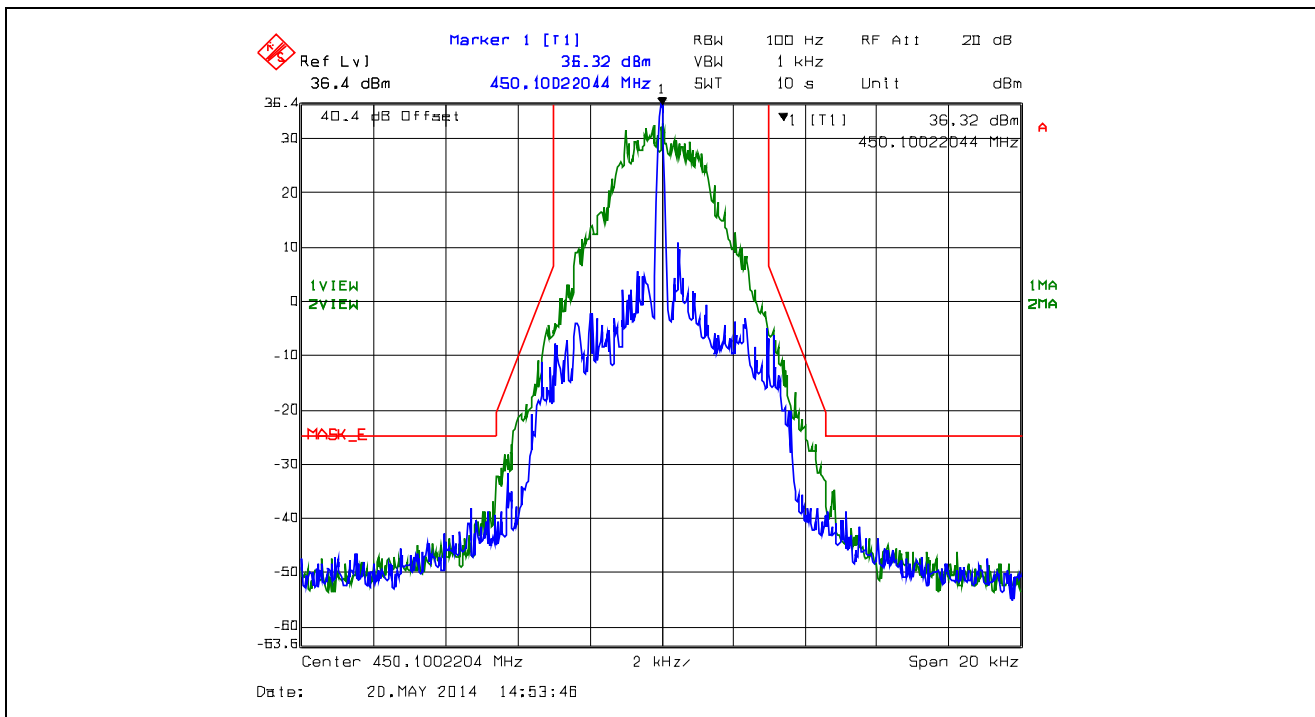

**ULTRATECH GROUP OF LABS**

3000 Bristol Circle, Oakville, Ontario, Canada L6H 6G4  
 Tel. #: 905-829-1570, Fax. #: 905-829-8050, Email: [vic@ultratech-labs.com](mailto:vic@ultratech-labs.com), Website: <http://www.ultratech-labs.com>

File #: ICOM-364F90

June 2, 2014

All test results contained in this engineering test report are traceable to National Institute of Standards and Technology (NIST)



Plot 5.4.4.4.5. Emission Mask E, 469.9 MHz, Digital, High Power

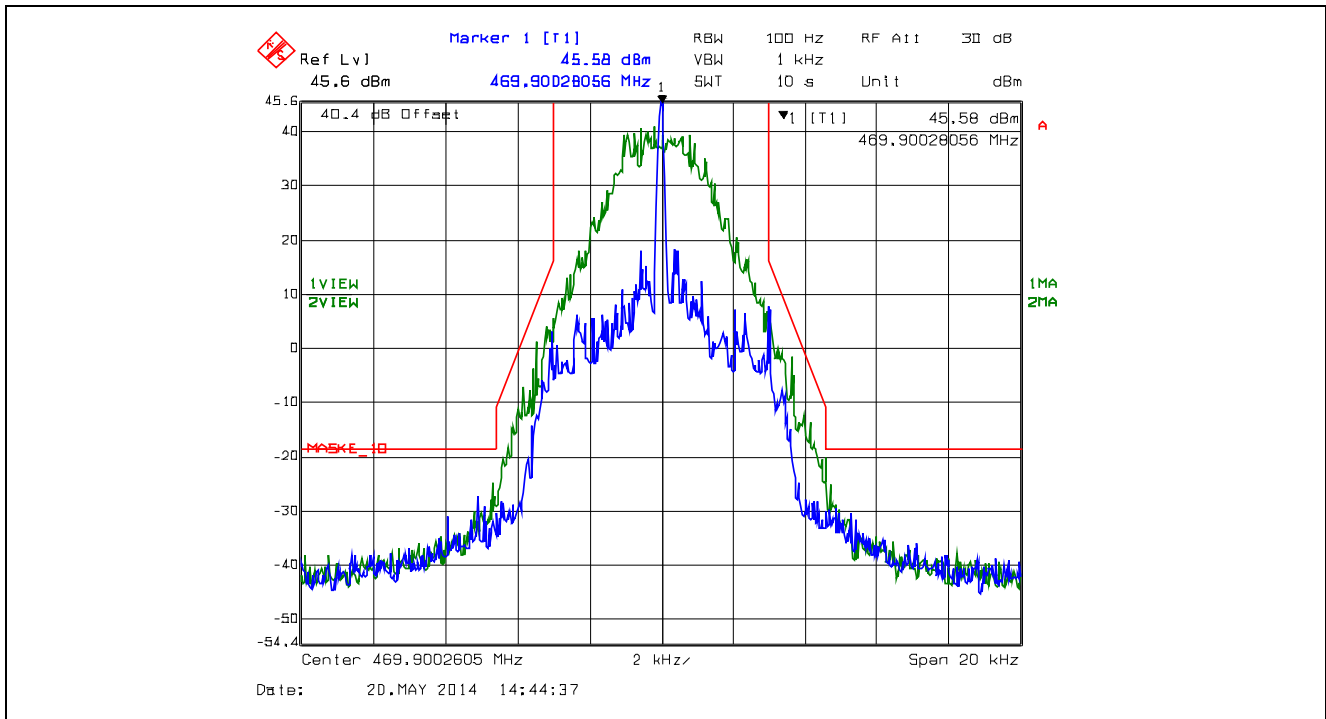

Plot 5.4.4.4.6. Emission Mask E, 469.9 MHz, Digital, Low Power

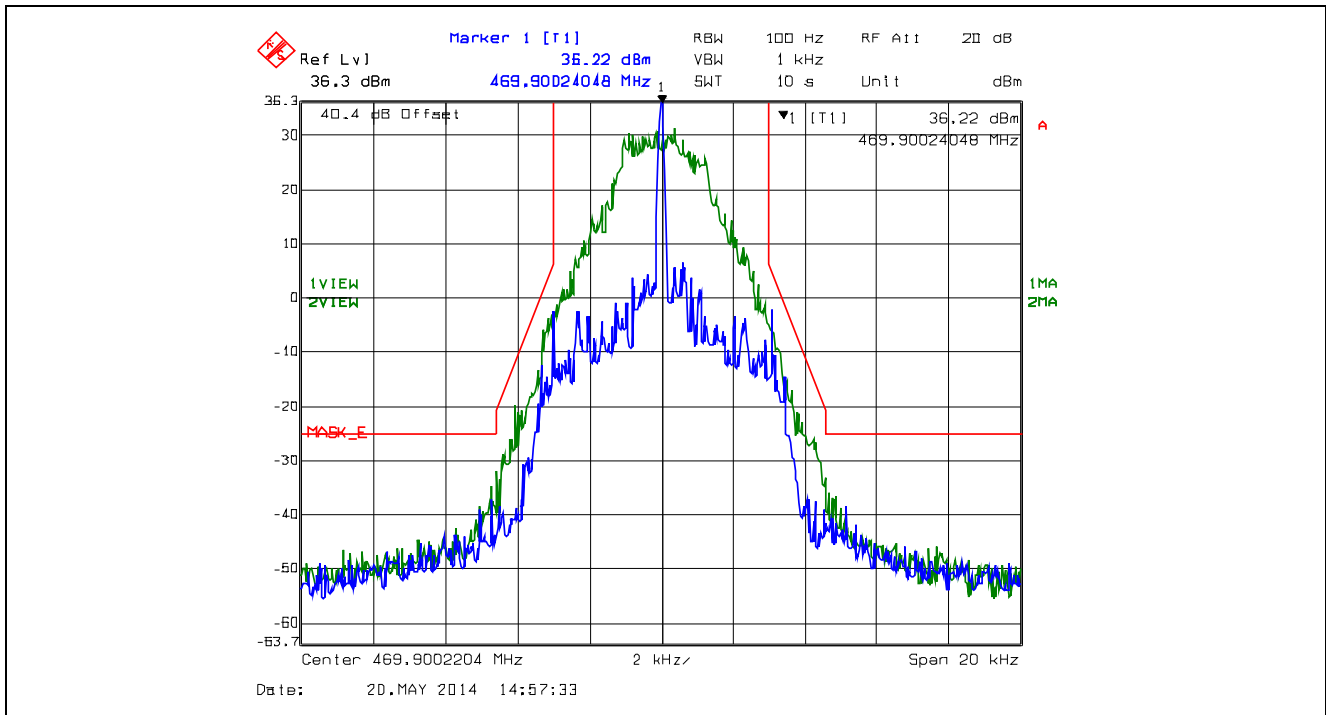

**5.5. SPURIOUS EMISSIONS AT ANTENNA TERMINALS [§§ 2.1051, 2.1057, 22.359(a), 80.211(f)(3) & 90.210]**

**5.5.1. Limits**

Emissions shall be attenuated below the mean output power of the transmitter as follows:

FCC Rules	Attenuation Limit (dBc)
§ 22.359	At least $43 + 10 \log (P)$ dB.
§ 80.211(f)(3),	At least $43 + 10 \log_{10}$ (mean power in watts) dB
§ 90.210(b)	At least $43 + 10 \log (P)$ dB
§ 90.210(d)	At least $50 + 10 \log (P)$ dB or 70 dB, whichever is the lesser attenuation.
§ 90.210(e)	At least $55 + 10 \log (P)$ or 65 dB, whichever is the lesser attenuation.

**5.5.2. Method of Measurements**

Refer to Section 8.5 of this report for measurement details

**5.5.3. Test Arrangement**

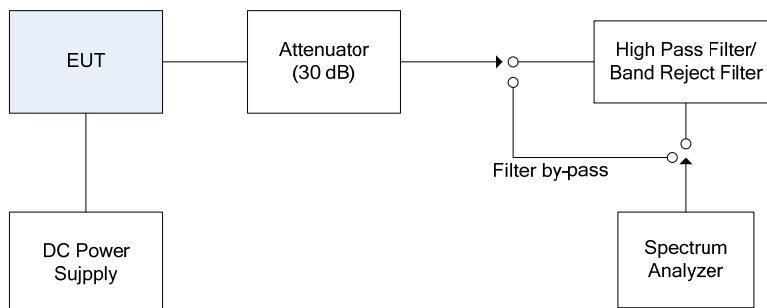

5.5.4. Test Data

Remark: Exploratory tests were conducted with modulations in the range of typical modes of operation to identify the worst-case modulation. There were no discernable differences detected. The digital mode, operating at 6.25 kHz channel spacing was used to represent the worst-case test configuration for the final measurement.

Plot 5.5.4.1. Conducted Transmitter Spurious Emissions, 406.2 MHz, High Power, 30 MHz – 600 MHz

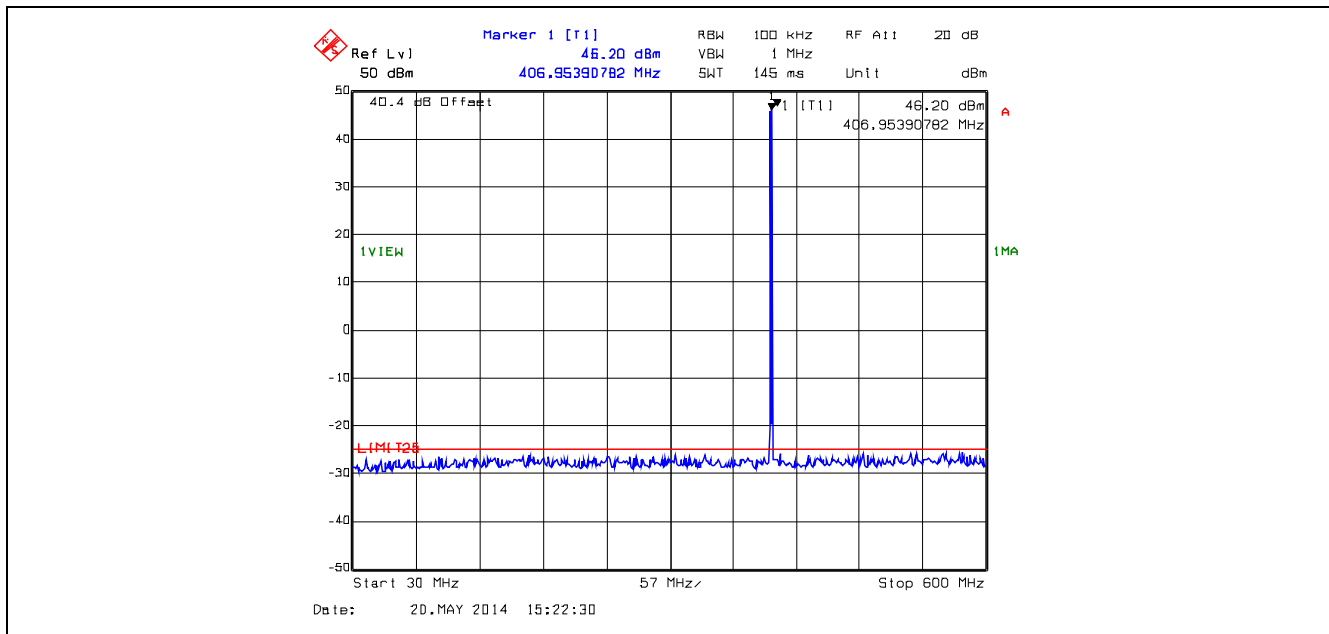

Plot 5.5.4.2. Conducted Transmitter Spurious Emissions, 406.2 MHz, High Power, 30 MHz – 600 MHz (with Band Reject Filter)

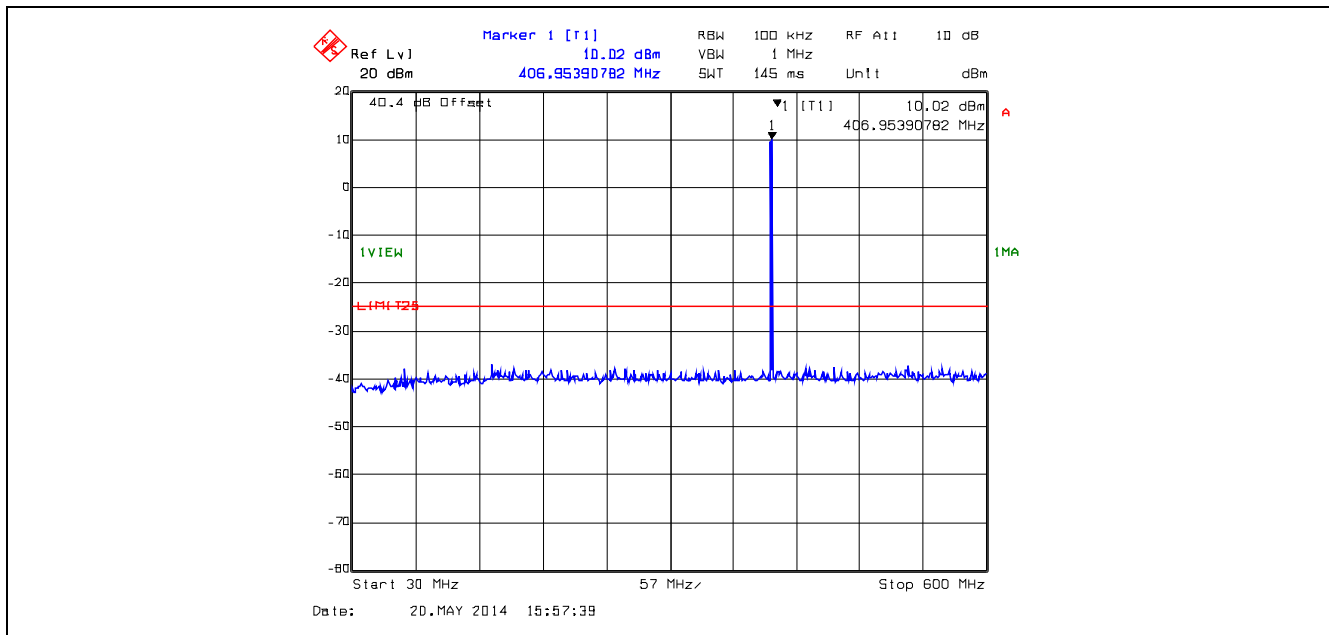

Plot 5.5.4.3. Conducted Transmitter Spurious Emissions, 406.2 MHz, High Power, 600 MHz – 5 GHz (with High Pass Filter)

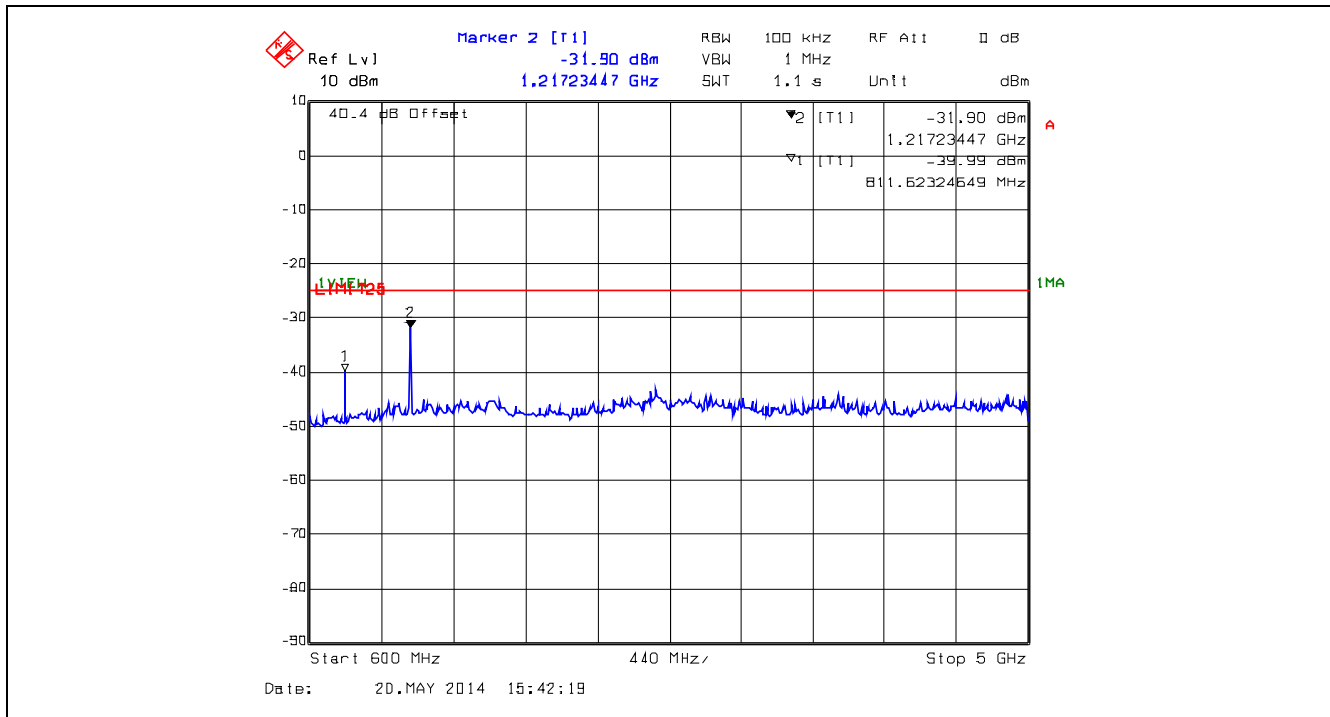

Plot 5.5.4.4. Conducted Transmitter Spurious Emissions, 406.2 MHz, Low Power, 30 MHz – 600 MHz

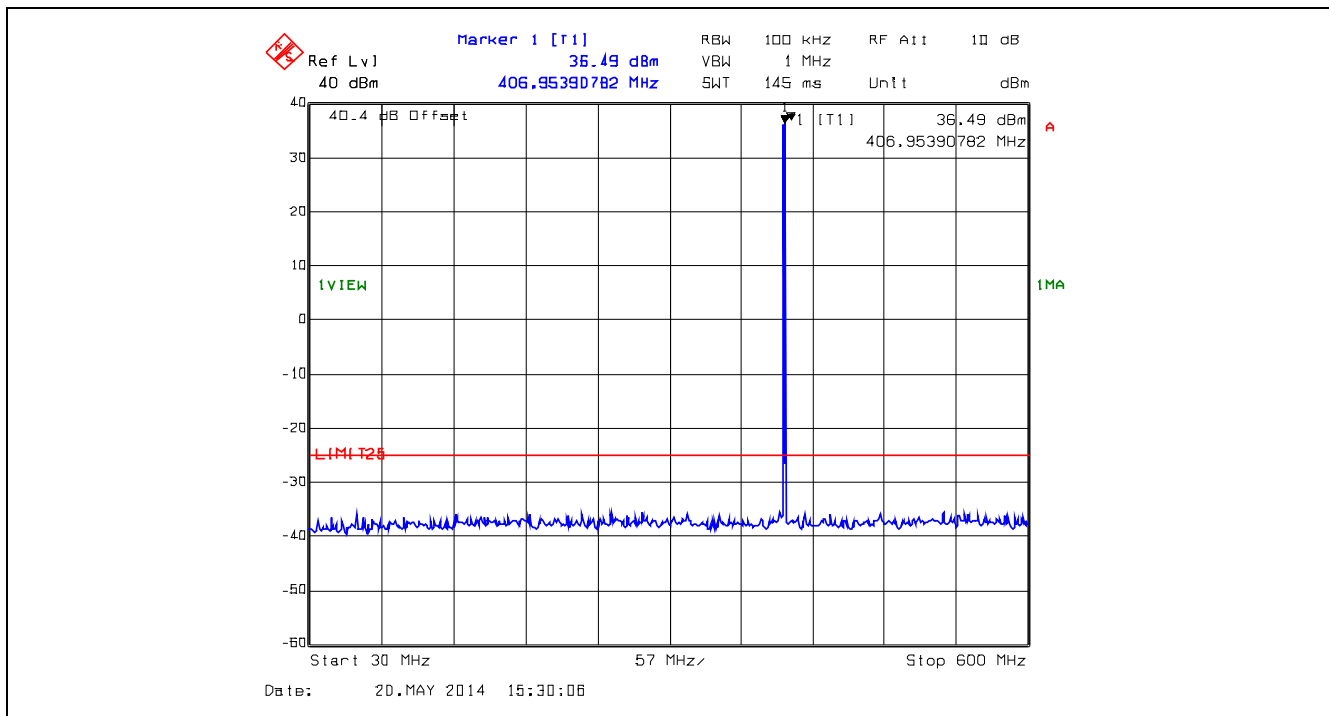

Plot 5.5.4.5. Conducted Transmitter Spurious Emissions, 406.2 MHz, Low Power, 600 MHz – 5 GHz (with High Pass Filter)

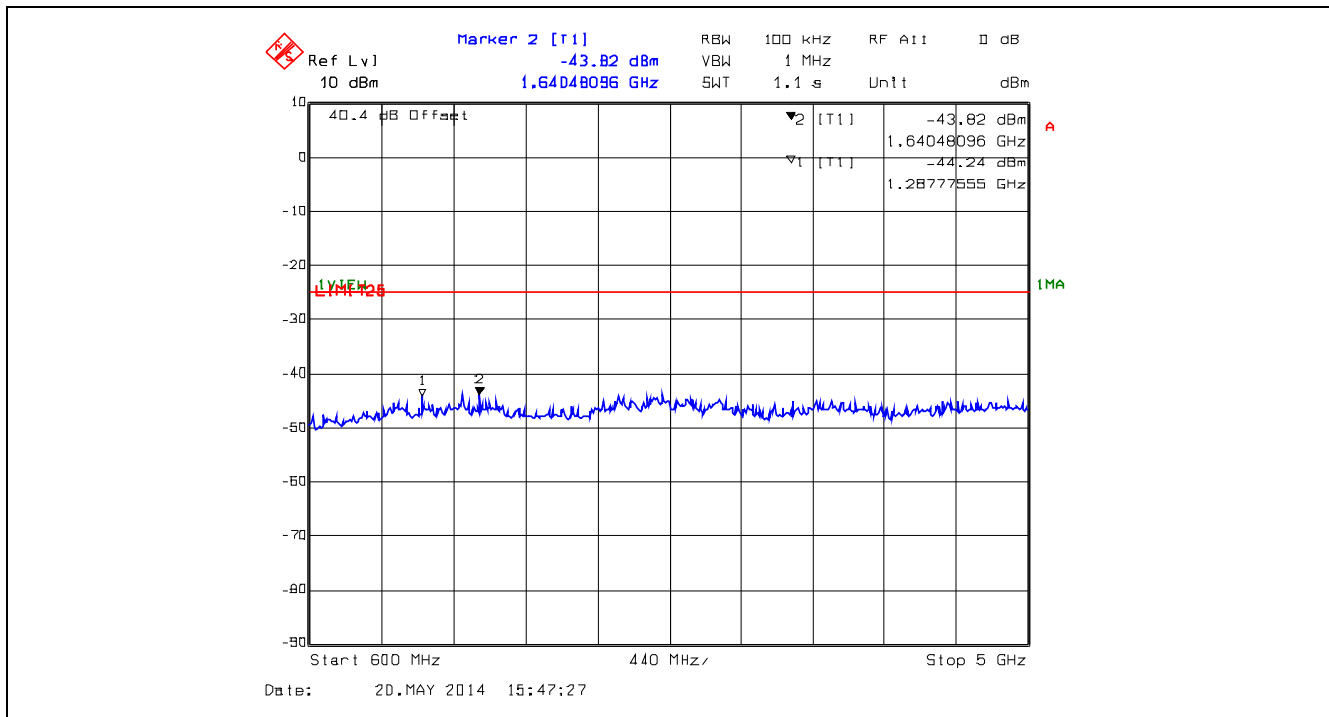

**ULTRATECH GROUP OF LABS**

3000 Bristol Circle, Oakville, Ontario, Canada L6H 6G4  
 Tel. #: 905-829-1570, Fax. #: 905-829-8050, Email: [vic@ultratech-labs.com](mailto:vic@ultratech-labs.com), Website: <http://www.ultratech-labs.com>

File #: ICOM-364F90

June 2, 2014

All test results contained in this engineering test report are traceable to National Institute of Standards and Technology (NIST)

Plot 5.5.4.6. Conducted Transmitter Spurious Emissions, 450.1 MHz, High Power, 30 MHz – 600 MHz

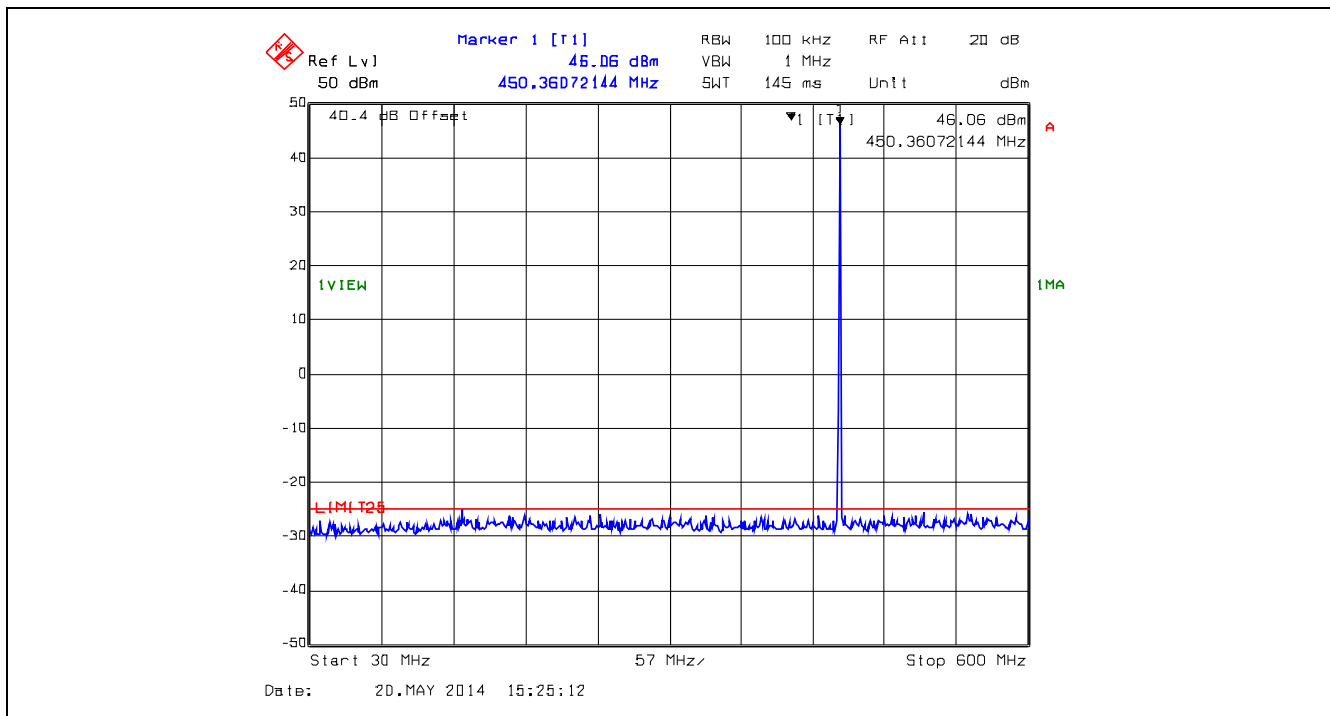

Plot 5.5.4.7. Conducted Transmitter Spurious Emissions, 450.1 MHz, High Power, 30 MHz – 600 MHz (with Band Reject Filter)

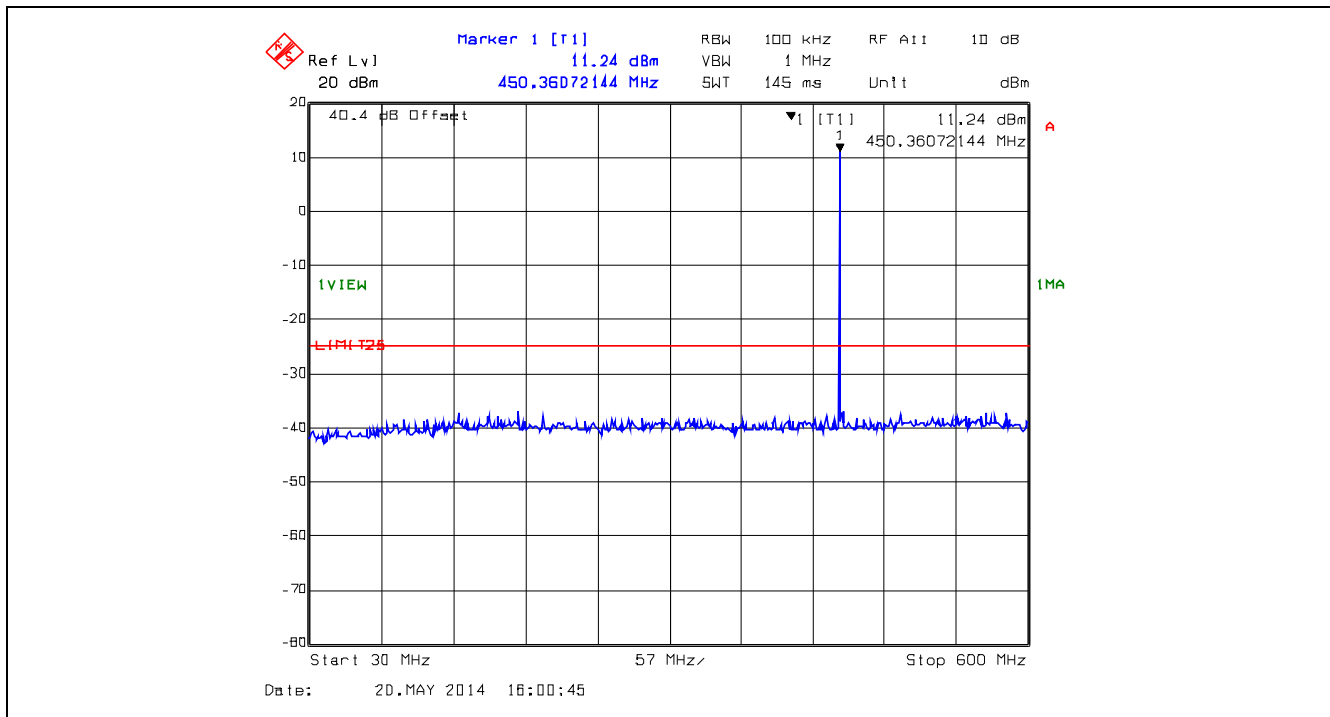

**ULTRATECH GROUP OF LABS**

3000 Bristol Circle, Oakville, Ontario, Canada L6H 6G4  
 Tel. #: 905-829-1570, Fax. #: 905-829-8050, Email: [vic@ultratech-labs.com](mailto:vic@ultratech-labs.com), Website: <http://www.ultratech-labs.com>

File #: ICOM-364F90

June 2, 2014

All test results contained in this engineering test report are traceable to National Institute of Standards and Technology (NIST)

Plot 5.5.4.8. Conducted Transmitter Spurious Emissions, 450.1 MHz, High Power, 600 MHz – 5 GHz (with High Pass Filter)

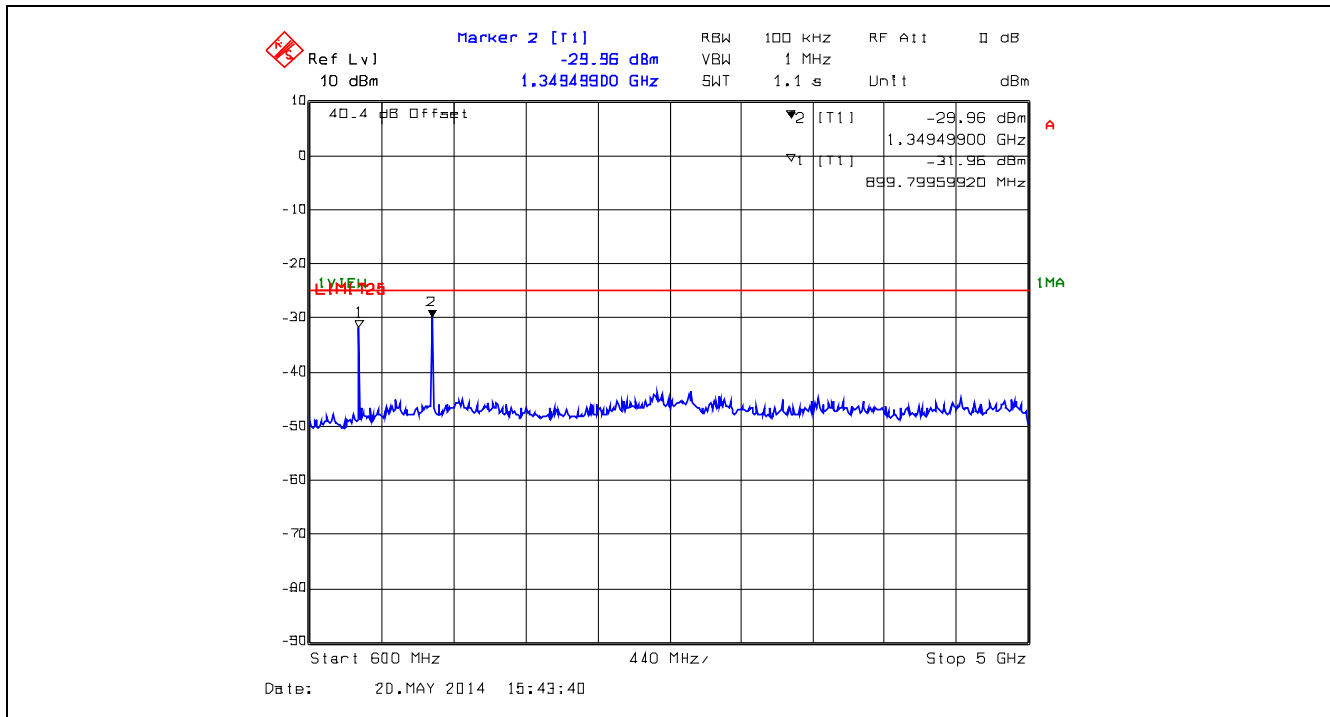

**ULTRATECH GROUP OF LABS**

3000 Bristol Circle, Oakville, Ontario, Canada L6H 6G4  
Tel. #: 905-829-1570, Fax. #: 905-829-8050, Email: [vic@ultratech-labs.com](mailto:vic@ultratech-labs.com), Website: <http://www.ultratech-labs.com>

File #: ICOM-364F90

June 2, 2014

All test results contained in this engineering test report are traceable to National Institute of Standards and Technology (NIST)

Plot 5.5.4.9. Conducted Transmitter Spurious Emissions, 450.1 MHz, Low Power, 30 MHz – 600 MHz

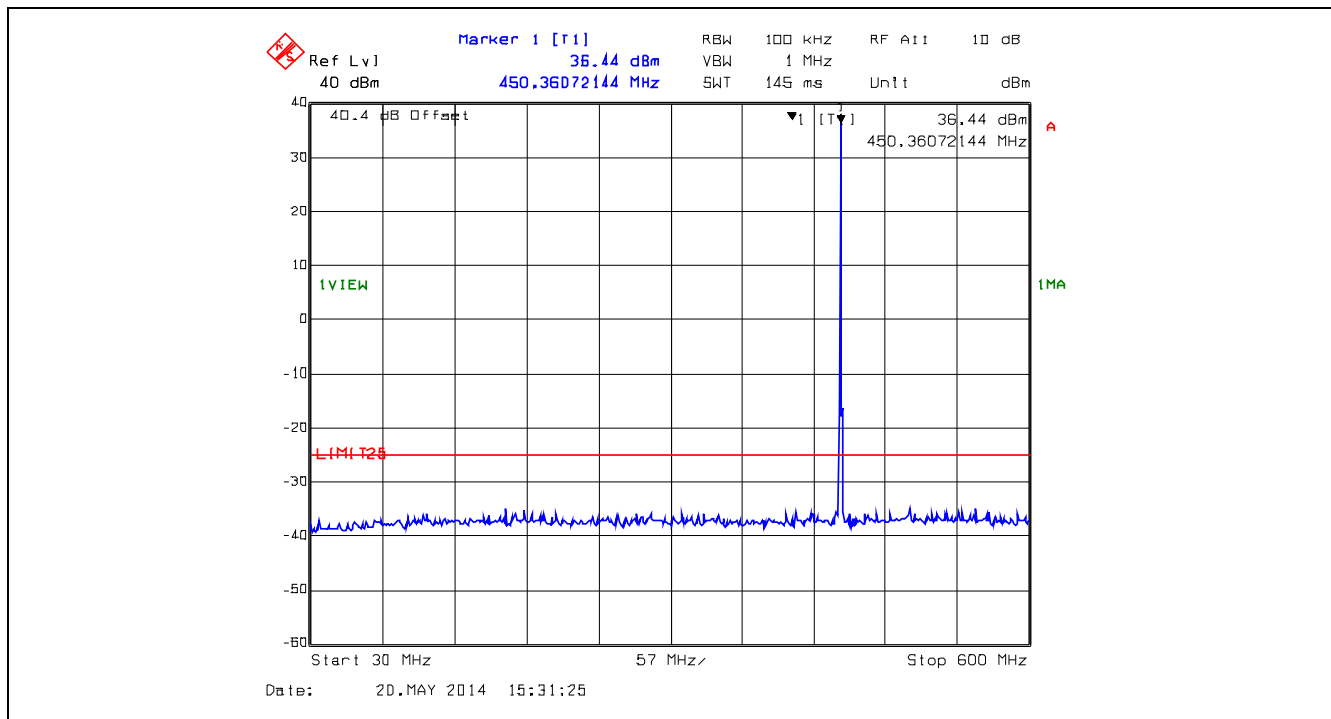

Plot 5.5.4.10. Conducted Transmitter Spurious Emissions, 450.1 MHz, Low Power, 600 MHz – 5 GHz (with High Pass Filter)

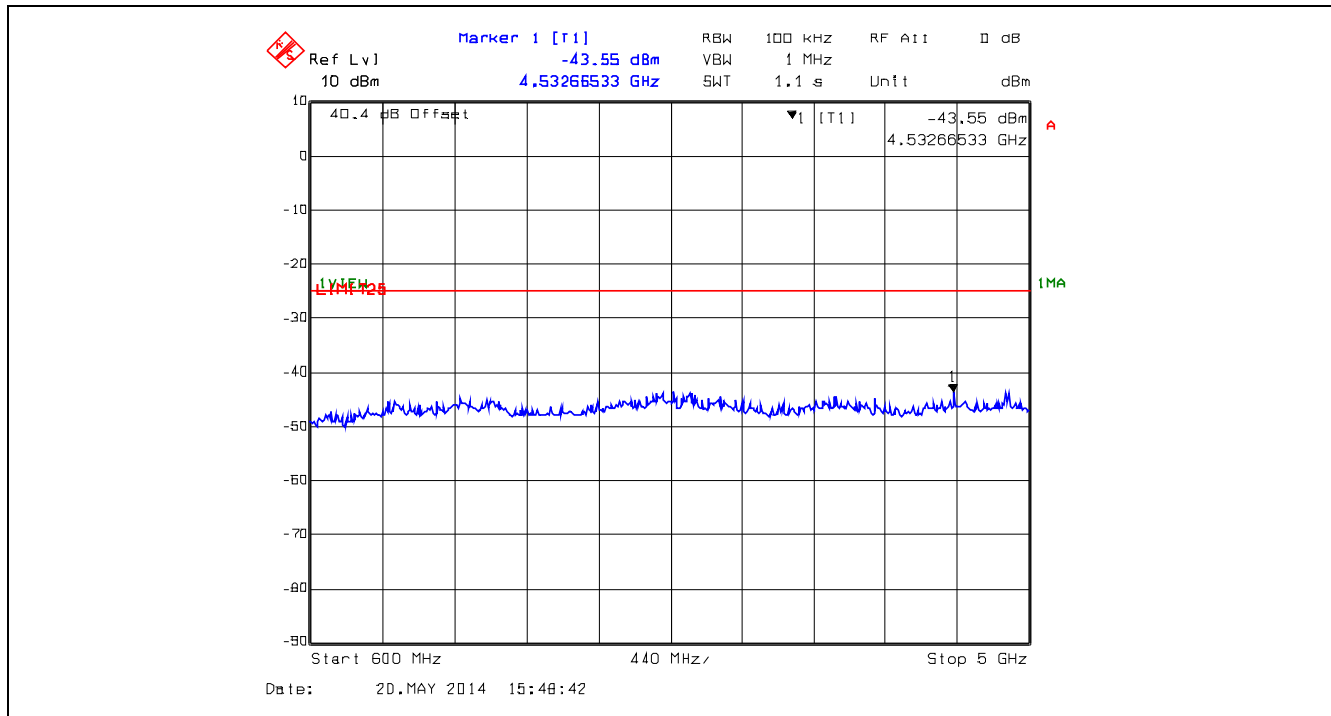

**ULTRATECH GROUP OF LABS**

3000 Bristol Circle, Oakville, Ontario, Canada L6H 6G4  
 Tel. #: 905-829-1570, Fax. #: 905-829-8050, Email: [vic@ultratech-labs.com](mailto:vic@ultratech-labs.com), Website: <http://www.ultratech-labs.com>

File #: ICOM-364F90

June 2, 2014

All test results contained in this engineering test report are traceable to National Institute of Standards and Technology (NIST)



Plot 5.5.4.11. Conducted Transmitter Spurious Emissions, 469.9 MHz, High Power, 30 MHz – 600 MHz

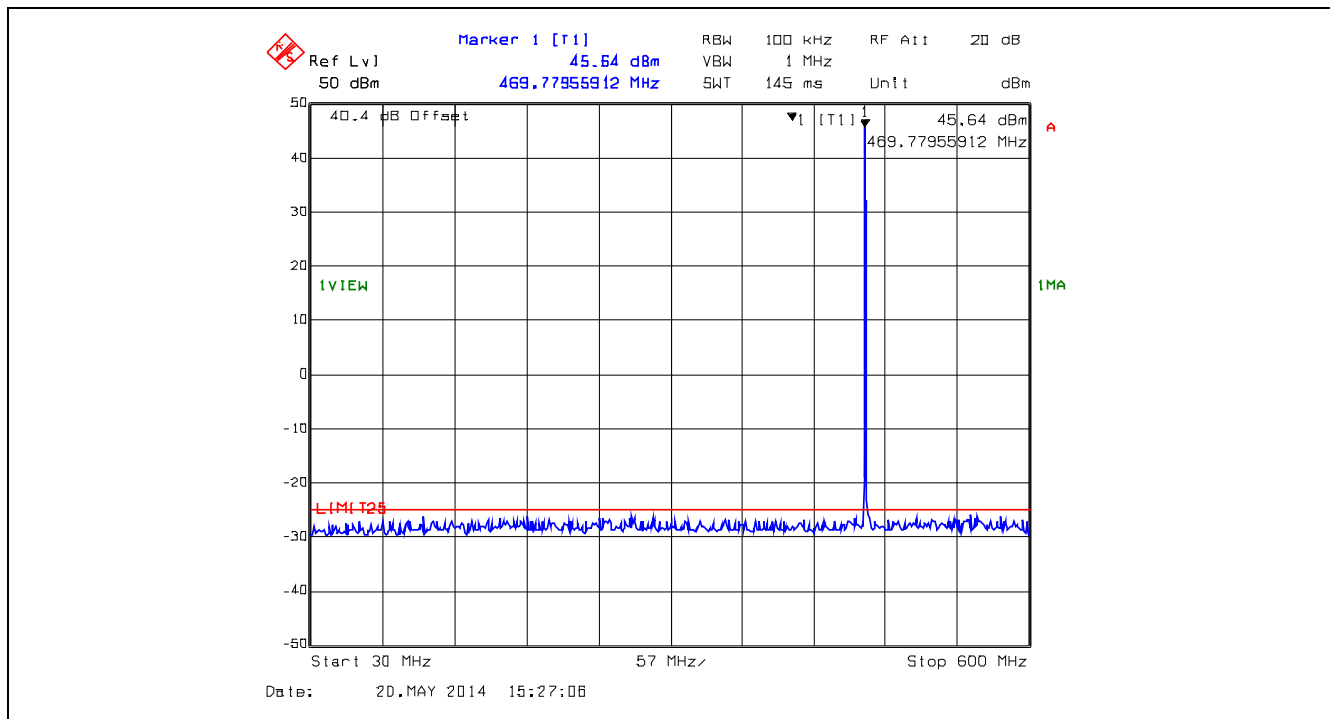

Plot 5.5.4.12. Conducted Transmitter Spurious Emissions, 469.9 MHz, High Power, 30 MHz – 600 MHz (with Band Reject Filter)

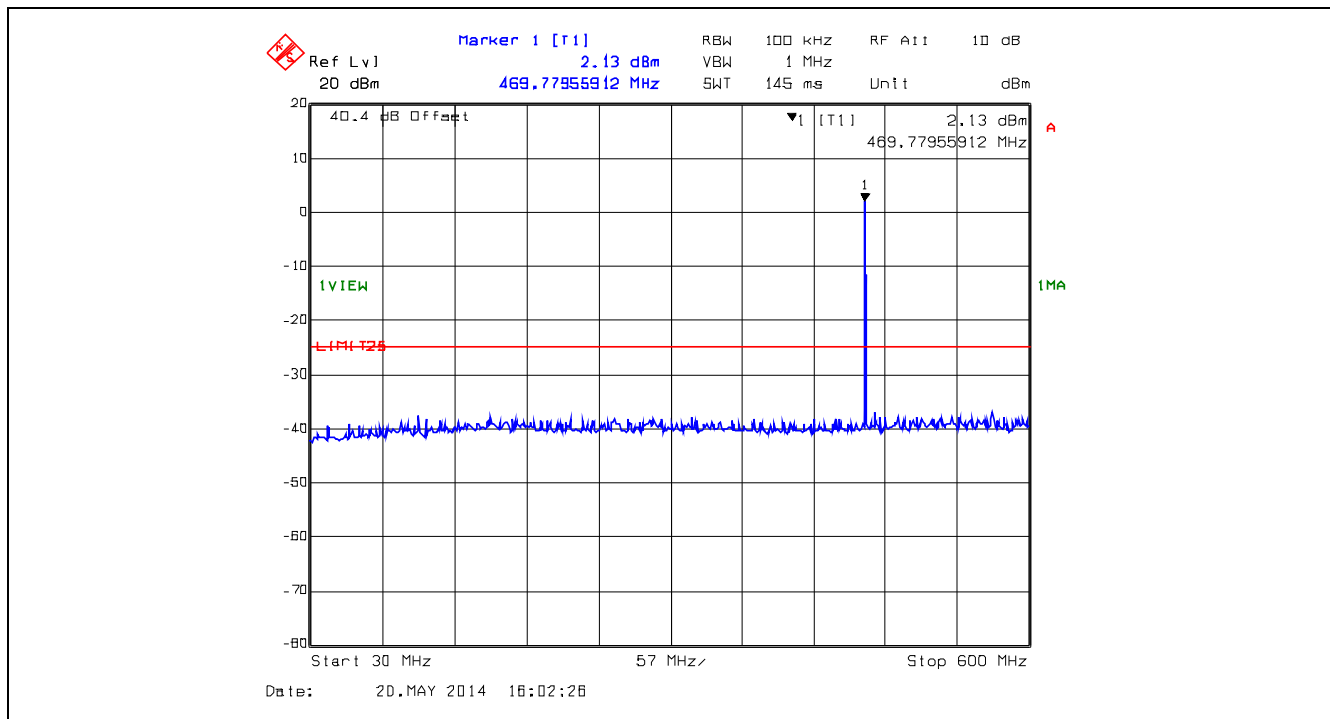

**ULTRATECH GROUP OF LABS**

3000 Bristol Circle, Oakville, Ontario, Canada L6H 6G4  
 Tel. #: 905-829-1570, Fax. #: 905-829-8050, Email: [vic@ultratech-labs.com](mailto:vic@ultratech-labs.com), Website: <http://www.ultratech-labs.com>

File #: ICOM-364F90

June 2, 2014

All test results contained in this engineering test report are traceable to National Institute of Standards and Technology (NIST)

Plot 5.5.4.13. Conducted Transmitter Spurious Emissions, 469.9 MHz, High Power, 600 MHz – 5 GHz (with High Pass Filter)

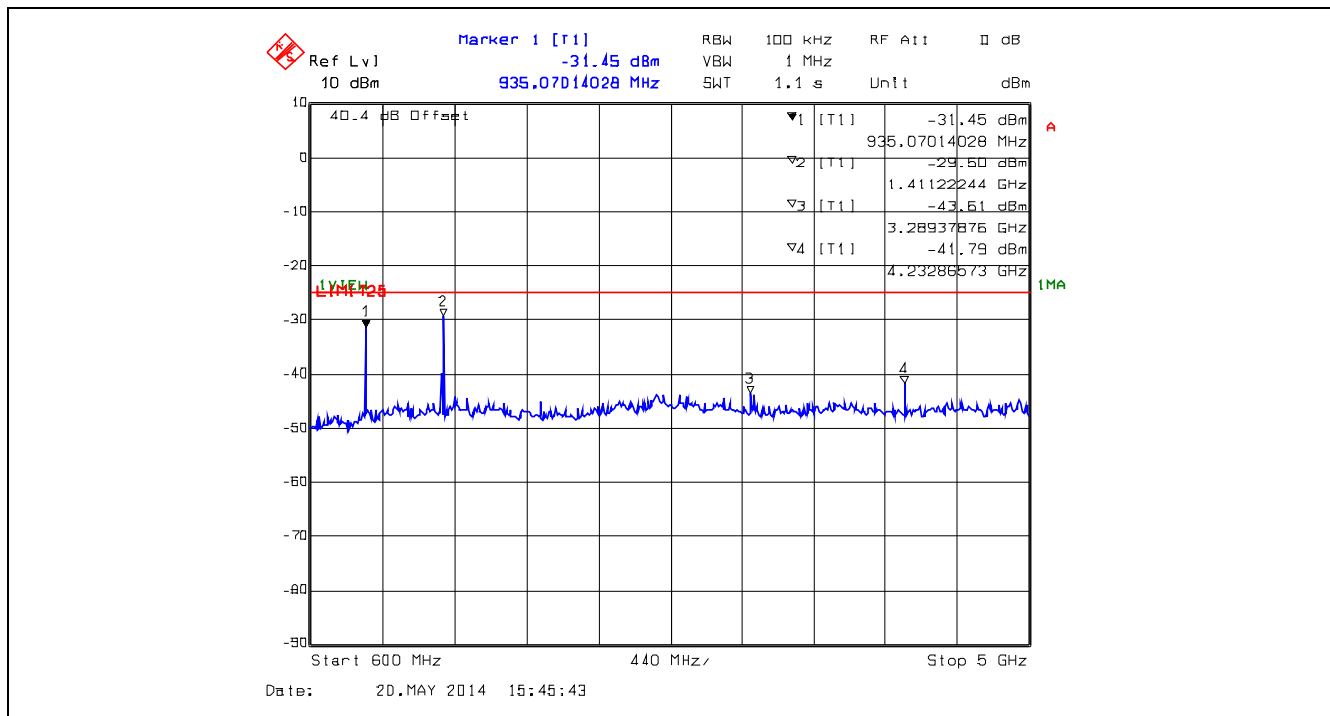

**ULTRATECH GROUP OF LABS**

3000 Bristol Circle, Oakville, Ontario, Canada L6H 6G4  
 Tel. #: 905-829-1570, Fax. #: 905-829-8050, Email: [vic@ultratech-labs.com](mailto:vic@ultratech-labs.com), Website: <http://www.ultratech-labs.com>

File #: ICOM-364F90

June 2, 2014

All test results contained in this engineering test report are traceable to National Institute of Standards and Technology (NIST)

Plot 5.5.4.14. Conducted Transmitter Spurious Emissions, 469.9 MHz, Low Power, 30 MHz – 600 MHz

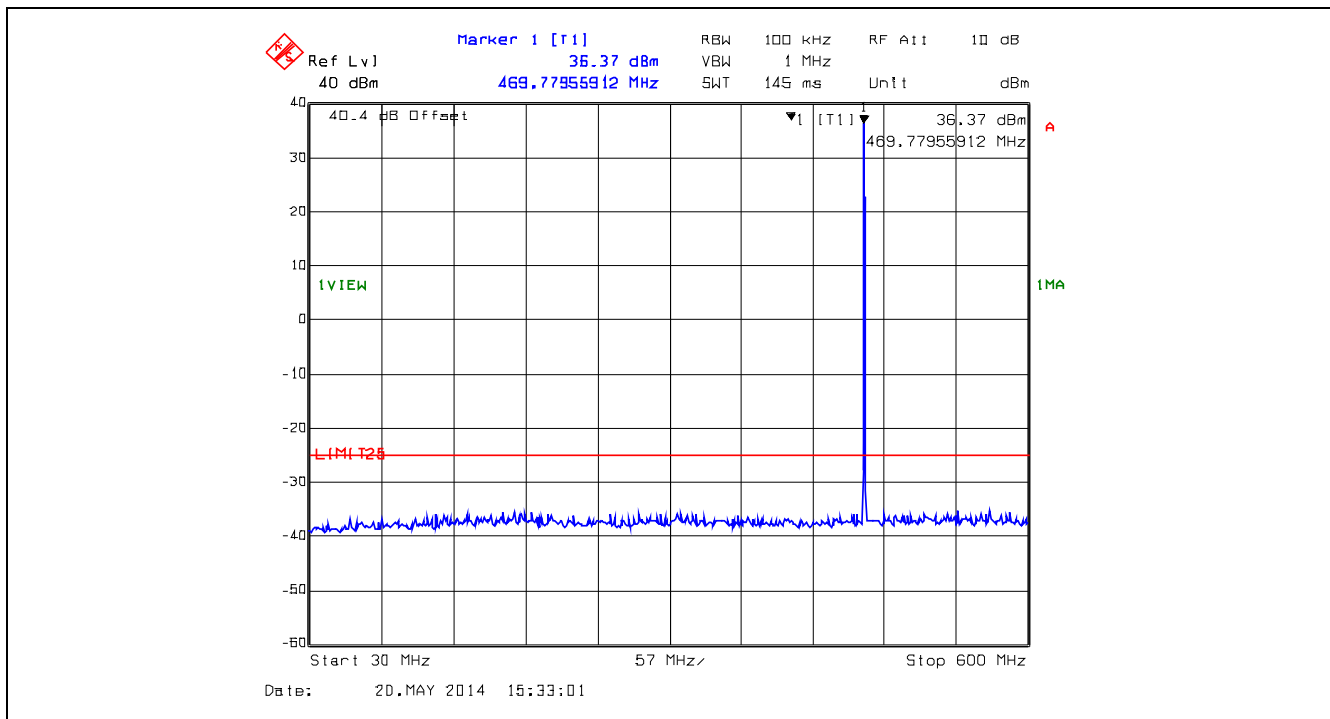

Plot 5.5.4.15. Conducted Transmitter Spurious Emissions, 469.9 MHz, Low Power, 600 MHz – 5 GHz (with High Pass Filter)

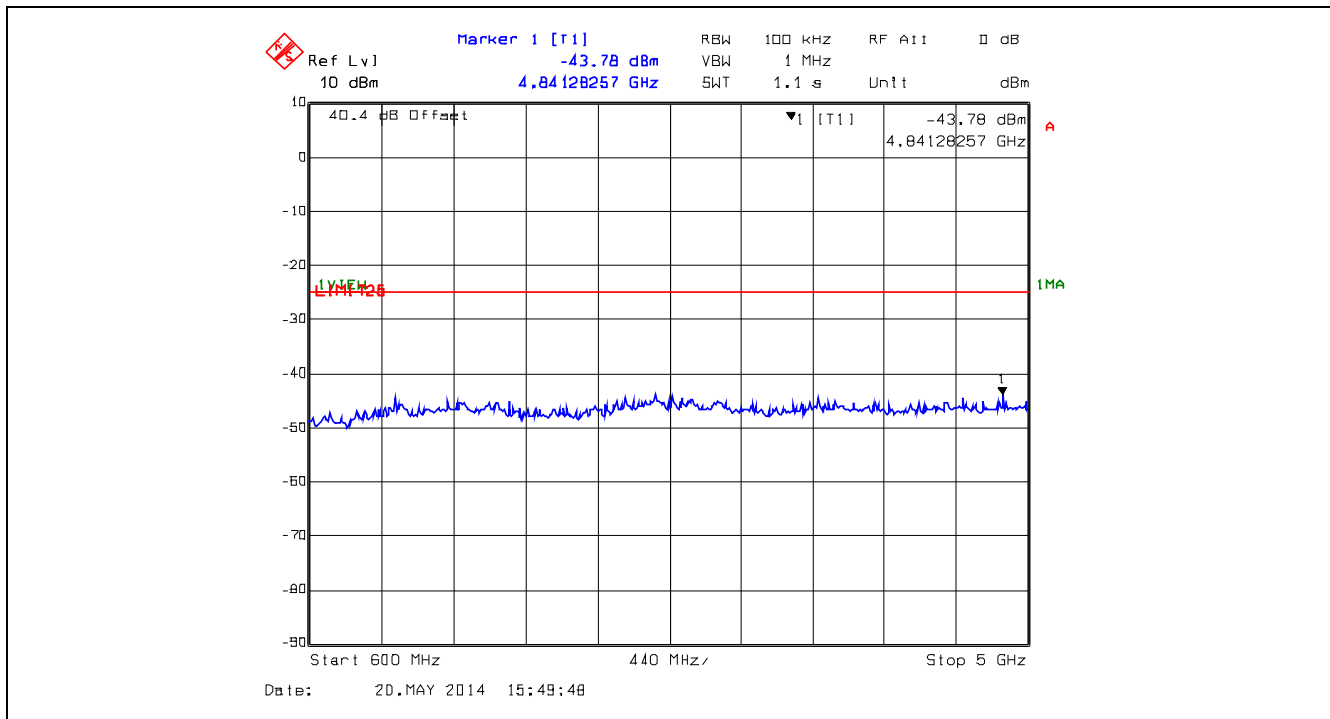

**ULTRATECH GROUP OF LABS**

3000 Bristol Circle, Oakville, Ontario, Canada L6H 6G4  
 Tel. #: 905-829-1570, Fax. #: 905-829-8050, Email: [vic@ultratech-labs.com](mailto:vic@ultratech-labs.com), Website: <http://www.ultratech-labs.com>

File #: ICOM-364F90

June 2, 2014

All test results contained in this engineering test report are traceable to National Institute of Standards and Technology (NIST)

**5.6. FIELD STRENGTH OF SPURIOUS EMISSIONS [§§ 2.1053, 2.1057, 22.359(a), 80.211(f)(3) & 90.210]**

**5.6.1. Limits**

Emissions shall be attenuated below the mean output power of the transmitter as follows:

FCC Rules	Attenuation Limit (dBc)
§ 22.359(a)	At least $43 + 10 \log (P)$ dB.
§ 80.211(f)(3),	At least $43 + 10 \log_{10}$ (mean power in watts) dB
§ 90.210(b)	At least $43 + 10 \log (P)$ dB
§ 90.210(d)	At least $50 + 10 \log (P)$ dB or 70 dB, whichever is the lesser attenuation.
§ 90.210(e)	At least $55 + 10 \log (P)$ or 65 dB, whichever is the lesser attenuation.

**5.6.2. Method of Measurements**

The spurious/harmonic ERP measurements are using substitution method specified in Section 8.2 of this report.

**5.6.3. Test Arrangement**

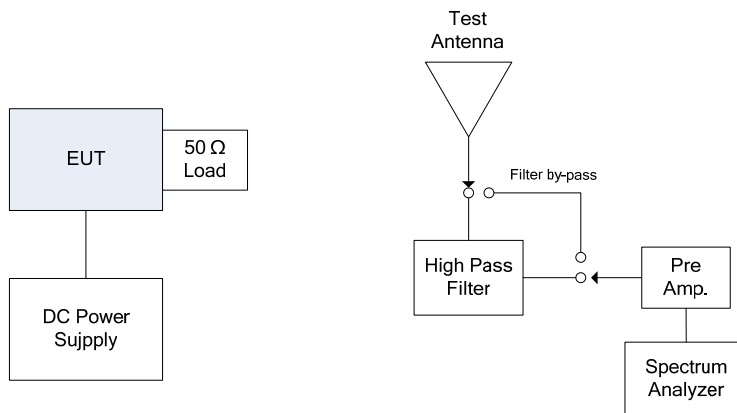

**5.6.4. Test Data**

**Remarks:**

- There was no discernable spurious/harmonic emission detected on the pre-scans for different channel spacing and modulation types. Therefore, the following radiated emissions were performed at 6.25 kHz channel spacing operation, and the results were compared with the more stringent limit for the worst-case.
- The radiated emissions were performed with high power setting at 3 m distance to represents the worst-case test configuration.
- The emissions were scanned from 30 MHz to 10<sup>th</sup> harmonics (5 GHz); all spurious emissions that are in excess of 20dB below the specified limit shall be recorded.

<b>Test Frequency (MHz):</b> 406.2						
<b>Power conducted (dBm):</b> 46.18						
<b>Limit (dBm):</b> -25						
Frequency (MHz)	E-Field (dBµV/m)	EMI Detector (Peak/QP)	Antenna Polarization (H/V)	ERP measured (dBm)	Limit (dBm)	Margin (dB)
All spurious emissions found are more than 20dB below the specified limit.						

<b>Test Frequency (MHz):</b> 450.1						
<b>Power conducted (dBm):</b> 45.85						
<b>Limit (dBm):</b> -25						
Frequency (MHz)	E-Field (dBµV/m)	EMI Detector (Peak/QP)	Antenna Polarization (H/V)	ERP measured (dBm)	Limit (dBm)	Margin (dB)
All spurious emissions found are more than 20dB below the specified limit.						

<b>Test Frequency (MHz):</b> 469.9						
<b>Power conducted (dBm):</b> 45.54						
<b>Limit (dBm):</b> -25						
Frequency (MHz)	E-Field (dBµV/m)	EMI Detector (Peak/QP)	Antenna Polarization (H/V)	ERP measured (dBm)	Limit (dBm)	Margin (dB)
All spurious emissions found are more than 20dB below the specified limit.						

**5.7. FREQUENCY STABILITY [§§ 2.1055, 22.355, 74.464, 80.209 & 90.213]**

**5.7.1. Limits**

**§22.355 Frequency tolerance**

Frequency Tolerance for Transmitters in the Public Mobile Services			
Frequency range (MHz)	Base, fixed (ppm)	Mobile ≤3 watts (ppm)	Mobile ≤3 watts (ppm)
50 to 450	5.0	5.0	50.0
450 to 512	2.5	5.0	5.0

**§74.464 Frequency tolerance**

For operations on frequencies above 25 MHz using authorized bandwidths up to 30 kHz, the licensee of a remote pickup broadcast station or system shall maintain the operating frequency of each station in compliance with the frequency tolerance requirements of §90.213 of this chapter. For all other operations, the licensee of a remote pickup broadcast station or system shall maintain the operating frequency of each station in accordance with the following:

Frequency range	Tolerance (percent)	
	Base station	Mobile station
300 to 500 MHz, all powers	.00025	.0005

**§80.209 Transmitter frequency tolerances**

(a) The frequency tolerance requirements applicable to transmitters in the maritime services are shown in the following table. Tolerances are given as parts in 10<sup>6</sup> unless shown in Hz.

Frequency bands and categories of stations	Tolerances <sup>1</sup>
(7) Band 400-466 MHz:	
(i) EPIRBs operating on 406-406.1 MHz	5.
(ii) On-board stations	5.
(iii) Radiolocation and telecommand stations.	5.

<sup>1</sup>Transmitters authorized prior to January 2, 1990, with frequency tolerances equal to or better than those required after this date will continue to be authorized in the maritime services provided they retain approval and comply with the applicable standards in this part.

**§90.213 Frequency stability**

Minimum Frequency Stability (ppm)			
Frequency range (MHz)	Fixed and base stations	Mobile stations	
		Over 2 watts output power	2 watts or less output power
421-512	<sup>1</sup> 3 <sup>4</sup> 2.5	<sup>2</sup> 5	<sup>2</sup> 5

<sup>1</sup>In the 421-512 MHz band, fixed and base stations with a 12.5 kHz channel bandwidth must have a frequency stability of 1.5 ppm. Fixed and base stations with a 6.25 kHz channel bandwidth must have a frequency stability of 0.5 ppm.

<sup>2</sup>In the 421-512 MHz band, mobile stations designed to operate with a 12.5 kHz channel bandwidth must have a frequency stability of 2.5 ppm. Mobile stations designed to operate with a 6.25 kHz channel bandwidth must have a frequency stability of 1.0 ppm.

<sup>3</sup>Paging transmitters operating on paging-only frequencies must operate with frequency stability of 5 ppm in the 150-174 MHz band and 2.5 ppm in the 421-512 MHz band.

<sup>4</sup>Control stations may operate with the frequency tolerance specified for associated mobile frequencies.

**5.7.2. Method of Measurements**

Refer to Section 8.3 of this report for measurement details.

**5.7.3. Test Arrangement**

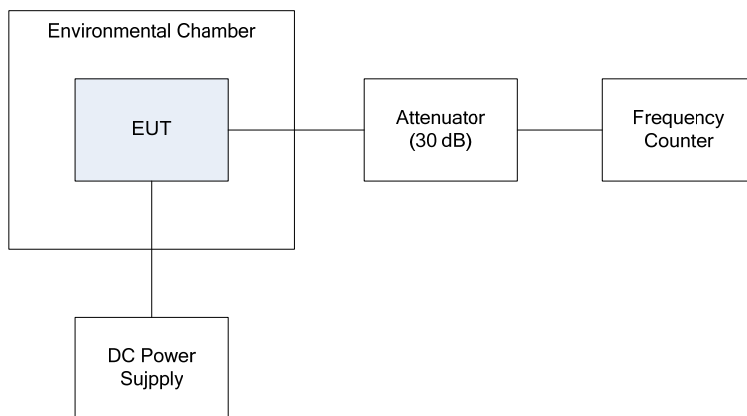

5.7.4. Test Data

<b>Test Frequency:</b>	406.2 MHz		
<b>Full Power Level:</b>	46.18 dBm		
<b>Frequency Tolerance Limit:</b>	± 1 ppm or ± 406 Hz		
<b>Max. Frequency Tolerance Measured:</b>	+127 Hz or 0.31 ppm		
<b>Input Voltage Rating:</b>	13.6 VDC (nominal)		
<b>Ambient Temperature (°C)</b>	<b>Frequency Drift (Hz)</b>		
	<b>Supply Voltage (Nominal) 13.6 VDC</b>	<b>Supply Voltage (85% of Nominal) 11.56 VDC</b>	<b>Supply Voltage (115% of Nominal) 15.64 VDC</b>
-30	-108	--	--
-20	-50	--	--
-10	+21	--	--
0	+24	--	--
+10	+75	--	--
+20	+105	+106	+105
+30	+127	--	--
+40	+116	--	--
+50	+109	--	--
+60	+103	--	--

**ULTRATECH GROUP OF LABS**

3000 Bristol Circle, Oakville, Ontario, Canada L6H 6G4  
 Tel. #: 905-829-1570, Fax. #: 905-829-8050, Email: [vic@ultratech-labs.com](mailto:vic@ultratech-labs.com), Website: <http://www.ultratech-labs.com>

**File #: ICOM-364F90**

June 2, 2014

All test results contained in this engineering test report are traceable to National Institute of Standards and Technology (NIST)



**5.8. TRANSIENT FREQUENCY BEHAVIOR [§§ 90.214 & 74.462(c)]**

**5.8.1. Limits**

Transient frequencies must be within the maximum frequency difference limits during the time intervals indicated:

Time intervals <sup>1, 2</sup>	Maximum frequency difference <sup>3</sup>	All equipment	
		150 to 174 MHz	421 to 512MHz
Transient Frequency Behavior for Equipment Designed to Operate on 25 KHz Channels			
t <sub>1</sub> <sup>4</sup> .....	± 25.0 KHz	5.0 ms	10.0 ms
t <sub>2</sub> .....	± 12.5 KHz	20.0 ms	25.0 ms
t <sub>3</sub> <sup>4</sup> .....	± 25.0 KHz	5.0 ms	10.0 ms
Transient Frequency Behavior for Equipment Designed to Operate on 12.5 KHz Channels			
t <sub>1</sub> <sup>4</sup> .....	± 12.5 KHz	5.0 ms	10.0 ms
t <sub>2</sub> .....	± 6.25 KHz	20.0 ms	25.0 ms
t <sub>3</sub> <sup>4</sup> .....	± 12.5 KHz	5.0 ms	10.0 ms
Transient Frequency Behavior for Equipment Designed to Operate on 6.25 KHz Channels			
t <sub>1</sub> <sup>4</sup> .....	±6.25 KHz	5.0 ms	10.0 ms
t <sub>2</sub> .....	±3.125 KHz	20.0 ms	25.0 ms
t <sub>3</sub> <sup>4</sup> .....	±6.25 KHz	5.0 ms	10.0 ms

- t<sub>on</sub> is the instant when a 1 kHz test signal is completely suppressed, including any capture time due to phasing.  
 t<sub>1</sub> is the time period immediately following t<sub>on</sub>.  
 t<sub>2</sub> is the time period immediately following t<sub>1</sub>.  
 t<sub>3</sub> is the time period from the instant when the transmitter is turned off until t<sub>off</sub>.  
 t<sub>off</sub> is the instant when the 1 kHz test signal starts to rise.
- During the time from the end of t<sub>2</sub> to the beginning of t<sub>3</sub>, the frequency difference must not exceed the limits specified in § 90.213.
- Difference between the actual transmitter frequency and the assigned transmitter frequency.
- If the transmitter carrier output power rating is 6 Watts or less, the frequency difference during this time period may exceed the maximum frequency difference for this time period.

**5.8.2. Method of Measurements**

Refer to Section 8.6 of this test report and ANSI/TIA/EIA-603-D-2010, Section 2.

### 5.8.3. Test Arrangement

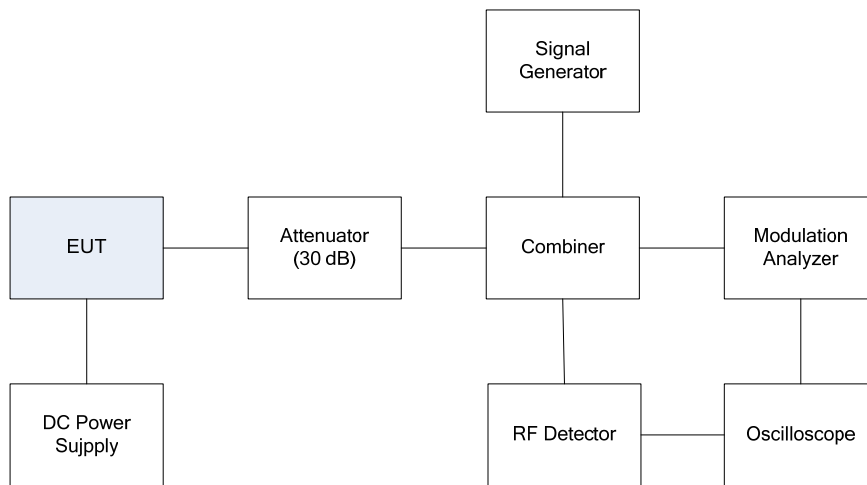

5.8.4. Test Data

Plot 5.8.4.1. Transient Frequency Behavior for 25 kHz Channel Spacing  
406.2 MHz, High Power Setting, Switch on condition  $t_{on}$ ,  $t_1$ , and  $t_2$

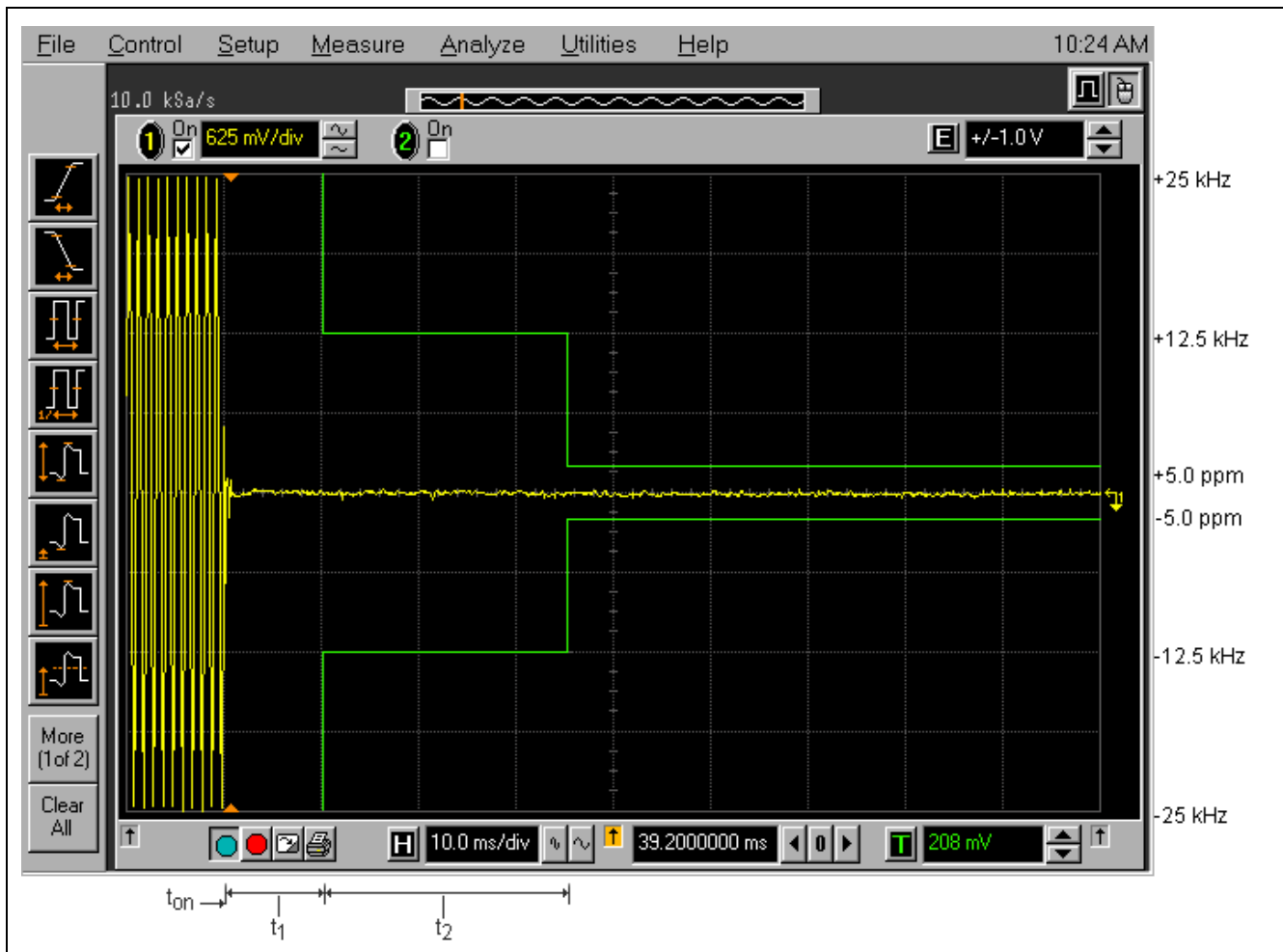

**Plot 5.8.4.2.** Transient Frequency Behavior for 25 kHz Channel Spacing  
406.2 MHz, High Power Setting, Switch off condition  $t_3$ ,  $t_{off}$

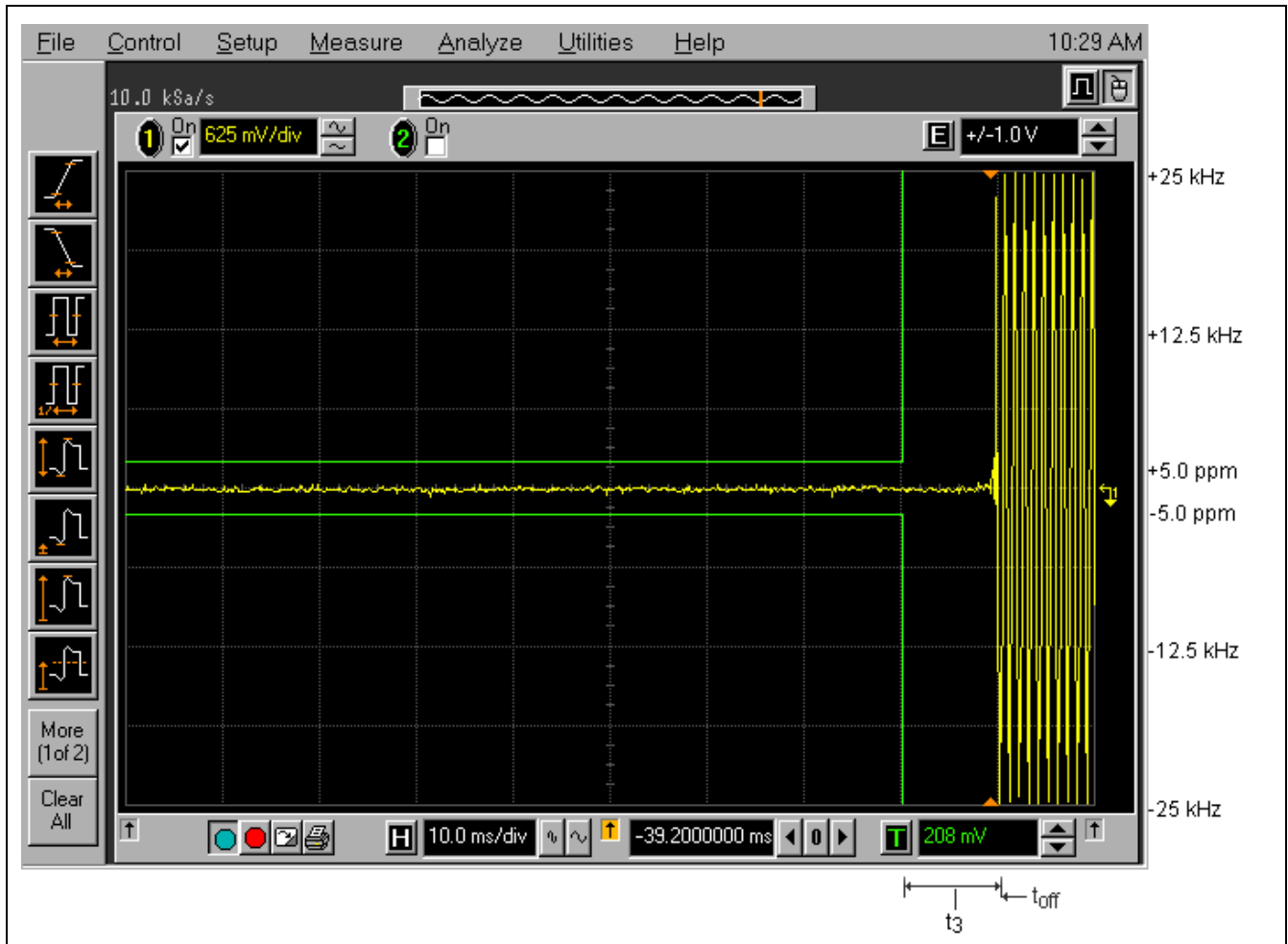

**ULTRATECH GROUP OF LABS**

3000 Bristol Circle, Oakville, Ontario, Canada L6H 6G4  
Tel. #: 905-829-1570, Fax. #: 905-829-8050, Email: [vic@ultratech-labs.com](mailto:vic@ultratech-labs.com), Website: <http://www.ultratech-labs.com>

File #: ICOM-364F90

June 2, 2014

All test results contained in this engineering test report are traceable to National Institute of Standards and Technology (NIST)

**Plot 5.8.4.3.** Transient Frequency Behavior for 12.5 kHz Channel Spacing  
406.2 MHz, High Power Setting, Switch on condition  $t_{on}$ ,  $t_1$ , and  $t_2$

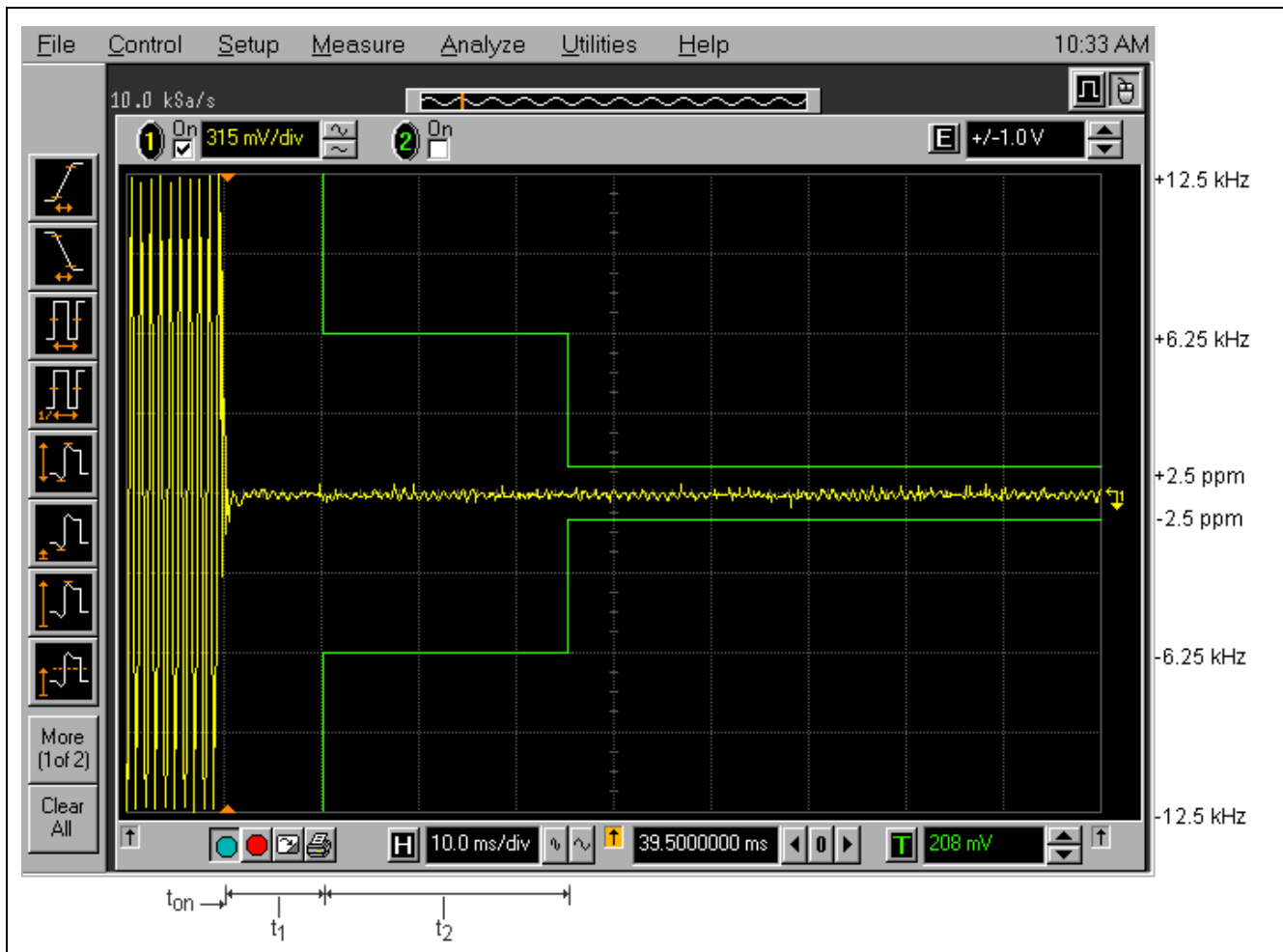

**ULTRATECH GROUP OF LABS**

3000 Bristol Circle, Oakville, Ontario, Canada L6H 6G4  
Tel. #: 905-829-1570, Fax. #: 905-829-8050, Email: [vic@ultratech-labs.com](mailto:vic@ultratech-labs.com), Website: <http://www.ultratech-labs.com>

File #: ICOM-364F90

June 2, 2014

All test results contained in this engineering test report are traceable to National Institute of Standards and Technology (NIST)

**Plot 5.8.4.4.** Transient Frequency Behavior for 12.5 kHz Channel Spacing  
406.2 MHz, High Power Setting, Switch off condition  $t_3$ ,  $t_{off}$

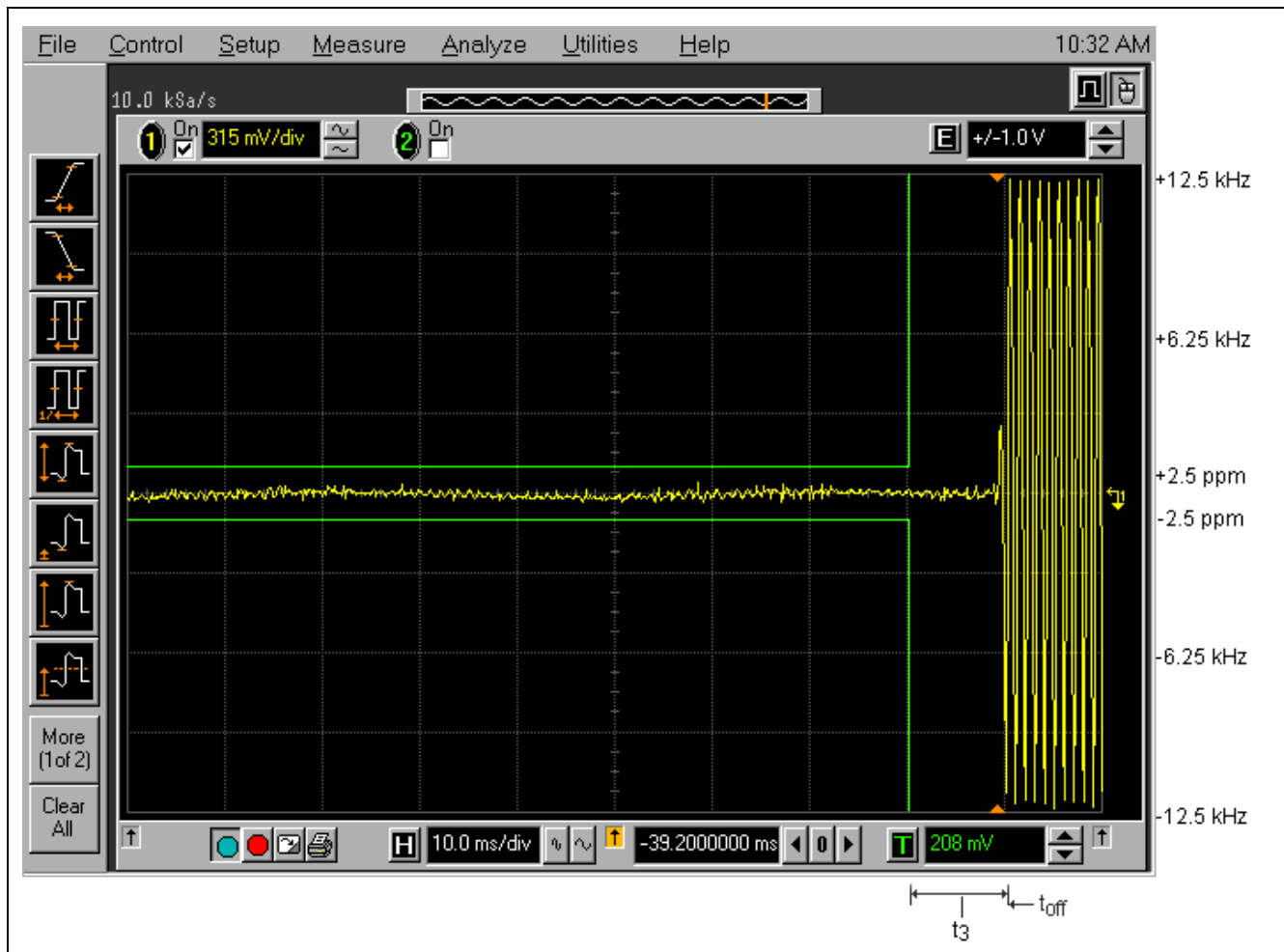

**ULTRATECH GROUP OF LABS**

3000 Bristol Circle, Oakville, Ontario, Canada L6H 6G4  
Tel. #: 905-829-1570, Fax. #: 905-829-8050, Email: [vic@ultratech-labs.com](mailto:vic@ultratech-labs.com), Website: <http://www.ultratech-labs.com>

File #: ICOM-364F90

June 2, 2014

All test results contained in this engineering test report are traceable to National Institute of Standards and Technology (NIST)

**Plot 5.8.4.5. Transient Frequency Behavior for 6.25 kHz Channel Spacing**  
406.2 MHz, High Power Setting, Switch on condition  $t_{on}$ ,  $t_1$ , and  $t_2$

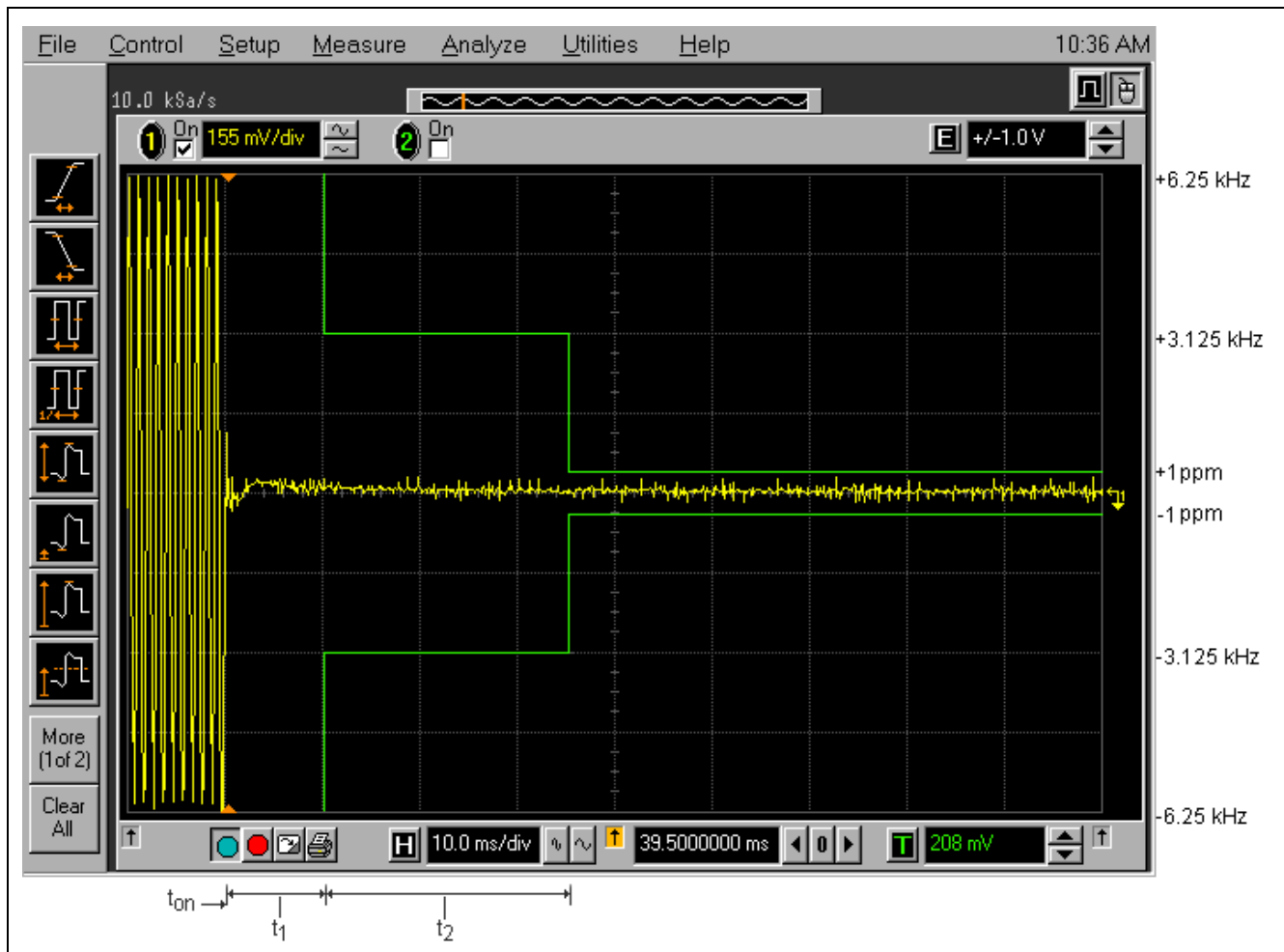

**Plot 5.8.4.6.** Transient Frequency Behavior for 6.25 kHz Channel Spacing  
406.2 MHz, High Power Setting, Switch off condition  $t_3$ ,  $t_{off}$



**ULTRATECH GROUP OF LABS**

3000 Bristol Circle, Oakville, Ontario, Canada L6H 6G4  
Tel. #: 905-829-1570, Fax. #: 905-829-8050, Email: [vic@ultratech-labs.com](mailto:vic@ultratech-labs.com), Website: <http://www.ultratech-labs.com>

File #: ICOM-364F90

June 2, 2014

All test results contained in this engineering test report are traceable to National Institute of Standards and Technology (NIST)



**5.9. RF EXPOSURE REQUIREMENTS [§§ 1.1310 & 2.1091]**

**5.9.1. Limits**

§ 1.1310: The criteria listed in the following table shall be used to evaluate the environmental impact of human exposure to radio-frequency (RF) radiation as specified in 1.1307(b).

**Limits for Maximum Permissible Exposure (MPE)**

Frequency range (MHz)	Electric field strength (V/m)	Magnetic field strength (A/m)	Power density (mW/cm <sup>2</sup> )	Averaging time (minutes)
<b>(A) Limits for Occupational/Controlled Exposures</b>				
0.3-3.0	614	1.63	*(100)	6
3.0-30	1842/f	4.89/f	*(900/f <sup>2</sup> )	6
30-300	61.4	0.163	1.0	6
300-1500			f/300	6
1500-100,000			5	6
<b>(B) Limits for General Population/Uncontrolled Exposure</b>				
0.3-1.34	614	1.63	*(100)	30
1.34-30	824/f	2.19/f	*(180/f <sup>2</sup> )	30
30-300	27.5	0.073	0.2	30
300-1500			f/1500	30
1500-100,000			1.0	30

f = frequency in MHz

\* = Plane-wave equivalent power density

Note 1: Occupational/controlled limits apply in situations in which persons are exposed as a consequence of their employment provided those persons are fully aware of the potential for exposure and can exercise control over their exposure. Limits for occupational/controlled exposure also apply in situations when an individual is transient through a location where occupational/controlled limits apply provided he or she is made aware of the potential for exposure.

Note 2: General population/uncontrolled exposures apply in situations in which the general public may be exposed, or in which persons that are exposed as a consequence of their employment may not be fully aware of the potential for exposure or can not exercise control over their exposure.

### 5.9.2. Method of Measurements

#### Calculation Method of RF Safety Distance:

$$S = \frac{PG}{4\pi \cdot r^2} = \frac{EIRP}{4\pi \cdot r^2}$$

Where, P: power input to the antenna in mW  
 EIRP: Equivalent (effective) isotropic radiated power.  
 S: power density mW/cm<sup>2</sup>  
 G: numeric gain of antenna relative to isotropic radiator  
 r: distance to centre of radiation in cm

$$r = \sqrt{\frac{PG}{4\pi \cdot S}} = \sqrt{\frac{EIRP}{4\pi \cdot S}}$$

### 5.9.3. Evaluation of RF Exposure Compliance Requirements

Maximum RF Power conducted, <b>P<sub>conducted</sub>[dBm]:</b>	46.53
Maximum Antenna Gain, <b>G[dBi]:</b>	0
Maximum EIRP, <b>P<sub>EIRP</sub>[dBm]:</b>	46.53
User-based time-average for PTT	50%
MPE Limit for Occupational/Controlled Exposure, <b>S<sub>controlled</sub>[mW/cm<sup>2</sup>]:</b>	= 400/300 = 1.33
MPE Limit for General Population/Uncontrolled Exposure, <b>S<sub>uncontrolled</sub>[mW/cm<sup>2</sup>]</b>	= 400/1500 = 0.27
Calculated RF Safety Distance for Occupational/Controlled Exposure, <b>r<sub>safety_controlled</sub>[cm]:</b>	36.98
Calculated RF Safety Distance for General Population/Uncontrolled Exposure, <b>r<sub>safety_uncontrolled</sub>[cm]</b>	81.41

**EXHIBIT 6. TEST EQUIPMENT LIST**

Test Instruments	Manufacturer	Model No.	Serial No.	Operating Range	Cal. Due Date
Spectrum Analyzer	R/S	FSEK	834157/005	9 kHz – 40 GHz	03 Jan 2015
Attenuator (40dB)	Aeroflex/Weinschel	53-40-34	MN917	DC - 1 GHz	Note 1
High Pass Filter	Mini Circuit	SHP 250	--	Cut off 230 MHz	Note 1
Power Meter	Hewlett Packard	436A	2016A07747	100 kHz –50 GHz sensor dependent	12 Feb 2015
Power Sensor	Hewlett Packard	8481A	2237A33409	100 kHz-18 GHz	12 Feb 2015
Modulation Analyzer	Hewlett Packard	8901B	3226A04606	150 kHz - 1300 MHz	29 Jan 2015
Combiner	Mini Circuit	ZFSC-3-4	15542	1 MHz - 1 GHz	Note 1
RF Detector	Pasternack	PE8000-50	--	10 MHz - 1GHz	Note 1
Infinium Digital Oscilloscope	Hewlett-Packard	54801A	US38380192	DC – 500 MHz 1 GHz sampling	14 Jun 2014
Environmental Chamber	Envirotronics	SSH32C	11994847-S-11059	-60 to 177 °C	01 May 2015
RF Synthesized signal Generator	HP	8648C	3343U00391	100K-3200M Hz AM/ FM/ PM	03 Jan 2015
Power supply	Tenma	72-7295	490300297	1-40V DC 5A	Note 1
FFT Digital Spectrum Analyzer	Advantest	R9211E	8202336	10 mHz - 100 kHz	03 Feb 2015
RF Communication Test Set	Hewlett Packard	8920B	US39064699	30 MHz – 1 GHz	17 Jan 2015
Horn antenna	EMCO	3115	9701-5061	1-18 GHz	08 Oct 2014
Preamplifier	Hewlett Packard	8449B	3008A00769	1-26.5 GHz	06 Aug 2014
High Pass Filter	Mini Circuit	SHP 600	--	Cut off 560 MHz	Note 1
Power supply	XANTREX	XKW 60-50	26509	0-60V 0-50A DC	Note 1
High Pass Filter	Mini Circuit	SHP 800	--	Cut off 750 MHz	Note 1
Attenuator	Aeroflex/Weinschel	23-20-34	BH7876	DC-18 GHz	Note 1
Antenna	ETS	93148	1101	200-2000 MHz	14 Apr 2015
Attenuator	Aeroflex/Weinschel	24-20-34	BJ2364	DC-18 GHz	Note 1
Frequency counter	EIP	545A	2683	10 Hz -18 GHz	07 Apr 2015
Biconical Antenna	ETS	3110B	3379	20-200 MHz	27 Jul 2014
Loop Antenna	EMCO	6502	9104-2611	10 kHz – 30 MHz	26 Aug 2014
Tunable Band-Reject Filter	K & L	3TFNF-30/76-N-N	36	28-300 MHz	Note 1
Attenuator	Aeroflex/Weinschel	24-10-34	BK8612	DC - 8.5 GHz	Note 1
Tunable Band-Reject Filter	K & L	3TFNF-250/500-N-N	21	250 - 500 MHz	Note 1

\*Note 1: Internal Verification/Calibration check

**ULTRATECH GROUP OF LABS**

3000 Bristol Circle, Oakville, Ontario, Canada L6H 6G4  
 Tel. #: 905-829-1570, Fax. #: 905-829-8050, Email: [vic@ultratech-labs.com](mailto:vic@ultratech-labs.com), Website: <http://www.ultratech-labs.com>

File #: ICOM-364F90  
 June 2, 2014

All test results contained in this engineering test report are traceable to National Institute of Standards and Technology (NIST)

## EXHIBIT 7. MEASUREMENT UNCERTAINTY

The measurement uncertainties stated were calculated in accordance with the requirements of CISPR 16-4-2 @ IEC:2003 and JCGM 100:2008 (GUM 1995) – Guide to the Expression of Uncertainty in Measurement.

### 7.1. RADIATED EMISSION MEASUREMENT UNCERTAINTY

	<b>Radiated Emission Measurement Uncertainty @ 3m, Horizontal (30-1000 MHz):</b>	<b>Measured (dB)</b>	<b>Limit (dB)</b>
<b>u<sub>c</sub></b>	<b>Combined standard uncertainty:</b> $u_c(y) = \sqrt{\sum_{i=1}^m u_i^2(y)}$	<b>± 2.39</b>	<b>± 2.6</b>
<b>U</b>	<b>Expanded uncertainty U:</b> $U = 2u_c(y)$	<b>± 4.79</b>	<b>± 5.2</b>

	<b>Radiated Emission Measurement Uncertainty @ 3m, Vertical (30-1000 MHz):</b>	<b>Measured (dB)</b>	<b>Limit (dB)</b>
<b>u<sub>c</sub></b>	<b>Combined standard uncertainty:</b> $u_c(y) = \sqrt{\sum_{i=1}^m u_i^2(y)}$	<b>± 2.39</b>	<b>± 2.6</b>
<b>U</b>	<b>Expanded uncertainty U:</b> $U = 2u_c(y)$	<b>± 4.78</b>	<b>± 5.2</b>

	<b>Radiated Emission Measurement Uncertainty @ 3 m, Horizontal &amp; Vertical (1 – 18 GHz):</b>	<b>Measured (dB)</b>	<b>Limit (dB)</b>
<b>u<sub>c</sub></b>	<b>Combined standard uncertainty:</b> $u_c(y) = \sqrt{\sum_{i=1}^m u_i^2(y)}$	<b>± 1.87</b>	<b>Under consideration</b>
<b>U</b>	<b>Expanded uncertainty U:</b> $U = 2u_c(y)$	<b>± 3.75</b>	<b>Under consideration</b>

## EXHIBIT 8. MEASUREMENT METHODS

### 8.1. CONDUCTED POWER MEASUREMENTS

- The following shall be applied to the combination(s) of the radio device and its intended antenna(e).
- If the RF level is user adjustable, all measurements shall be made with the highest power level available to the user for that combination.
- The following method of measurement shall apply to both conducted and radiated measurements.
- The radiated measurements are performed at the Ultratech Calibrated Open Field Test Site.
- The measurement shall be performed using normal operation of the equipment with modulation.

Test procedure shall be as follows:

#### Step 1: Duty Cycle measurements if the transmitter's transmission is transient

- Using a EMI Receiver with the frequency span set to 0 Hz and the sweep time set at a suitable value to capture the envelope peaks and the duty cycle of the transmitter output signal;
- The duty cycle of the transmitter,  $x = \text{Tx on} / (\text{Tx on} + \text{Tx off})$  with  $0 < x < 1$ , is measure and recorded in the test report. For the purpose of testing, the equipment shall be operated with a duty cycle that is equal or more than 0.1.

#### Step 2: Calculation of Average EIRP. See Figure 1

- The average output power of the transmitter shall be determined using a wideband, calibrated RF average power meter with the power sensor with an integration period that exceeds the repetition period of the transmitter by a factor 5 or more. The observed value shall be recorded as "A" (in dBm);
- The e.i.r.p. shall be calculated from the above measured power output "A", the observed duty cycle x, and the applicable antenna assembly gain "G" in dBi, according to the formula:

$$\text{EIRP} = \text{A} + \text{G} + 10\log(1/x)$$

{X = 1 for continuous transmission =>  $10\log(1/x) = 0$  dB}

Figure 1.

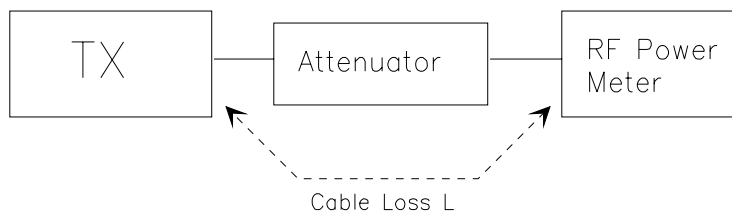

## 8.2. RADIATED POWER MEASUREMENTS (ERP & EIRP) USING SUBSTITUTION METHOD

### 8.2.1. MAXIMIZING RF EMISSION LEVEL (E-FIELD)

- (a) The measurements were performed with full rf output power and modulation.
- (b) Test was performed at listed 3m open area test site (listed with FCC, IC, ITI, NVLAP, ACA & VCCI).
- (c) The transmitter under test was placed at the specified height on a non-conducting turntable (80 cm height)
- (d) The BICONILOG antenna (20 MHz to 1 GHz) or HORN antenna (1 GHz to 18 GHz) was used for measuring.
- (e) Load an appropriate correction factors file in EMI Receiver for correcting the field strength reading level

Total Correction Factor recorded in the EMI Receiver = Cable Loss + Antenna Factor  
 $E \text{ (dB}\mu\text{V/m)} = \text{Reading (dB}\mu\text{V)} + \text{Total Correction Factor (dB/m)}$

- (f) Set the EMI Receiver and #2 as follows:

Center Frequency: test frequency  
Resolution BW: 100 KHz  
Video BW: same  
Detector Mode: positive  
Average: off  
Span: 3 x the signal bandwidth

- (g) The test antenna was lowered or raised from 1 to 4 meters until the maximum signal level was detected.
- (h) The transmitter was rotated through  $360^\circ$  about a vertical axis until a higher maximum signal was received.
- (i) The test antenna was lowered or raised again from 1 to 4 meters until a maximum was obtained. This level was recorded.
- (j) The recorded reading was corrected to the true field strength level by adding the antenna factor, cable loss and subtracting the pre-amplifier gain.
- (k) The above steps were repeated with both transmitters' antenna and test receiving antenna placed in vertical and horizontal polarization. Both readings with the antennas placed in vertical and horizontal polarization shall be recorded.
- (l) Repeat for all different test signal frequencies.

### 8.2.2. Measuring the EIRP of Spurious/Harmonic Emissions using Substitution Method

- (a) Set the EMI Receiver (for measuring E-Field) and Receiver #2 (for measuring EIRP) as follows:

Center Frequency: equal to the signal source  
Resolution BW: 100 KHz  
Video BW: VBW > RBW  
Detector Mode: positive  
Average: off  
Span: 3 x the signal bandwidth

- (b) Load an appropriate correction factors file in EMI Receiver for correcting the field strength reading level

Total Correction Factor recorded in the EMI Receiver = Cable Loss + Antenna Factor  
E (dBuV/m) = Reading (dBuV) + Total Correction Factor (dB/m)

- (c) Select the frequency and E-field levels obtained in the Section 8.2.1 for ERP/EIRP measurements.  
(d) Substitute the EUT by a signal generator and one of the following transmitting antenna (substitution antenna):  
♦ DIPOLE antenna for frequency from 30-1000 MHz or  
♦ HORN antenna for frequency above 1 GHz }.  
(e) Mount the transmitting antenna at 1.5 meter high from the ground plane.  
(f) Use one of the following antenna as a receiving antenna:  
♦ DIPOLE antenna for frequency from 30-1000 MHz or  
♦ HORN antenna for frequency above 1 GHz }.  
(g) If the DIPOLE antenna is used, tune it's elements to the frequency as specified in the calibration manual.  
(h) Adjust both transmitting and receiving antenna in a VERTICAL polarization.  
(i) Tune the EMI Receivers to the test frequency.  
(j) Lower or raise the test antenna from 1 to 4 meters until the maximum signal level was detected.  
(k) The transmitter was rotated through 360° about a vertical axis until a higher maximum signal was received.  
(l) Lower or raise the test antenna from 1 to 4 meters until the maximum signal level was detected.  
(m) Adjust input signal to the substitution antenna until an equal or a known related level to that detected from the transmitter was obtained in the test receiver.  
(n) Record the power level read from the Average Power Meter and calculate the ERP/EIRP as follows:

$$P = P1 - L1 = (P2 + L2) - L1 = P3 + A + L2 - L1$$

$$EIRP = P + G1 = P3 + L2 - L1 + A + G1$$

$$ERP = EIRP - 2.15 \text{ dB}$$

$$\text{Total Correction factor in EMI Receiver \# 2} = L2 - L1 + G1$$

Where: P: Actual RF Power fed into the substitution antenna port after corrected.  
P1: Power output from the signal generator  
P2: Power measured at attenuator A input  
P3: Power reading on the Average Power Meter  
EIRP: EIRP after correction  
ERP: ERP after correction

- (o) Adjust both transmitting and receiving antenna in a HORIZONTAL polarization, then repeat step (k) to (o)  
(p) Repeat step (d) to (o) for different test frequency  
(q) Repeat steps (c) to (j) with the substitution antenna oriented in horizontal polarization.  
(r) Actual gain of the EUT's antenna is the difference of the measured EIRP and measured RF power at the RF port. Correct the antenna gain if necessary.

Figure 2

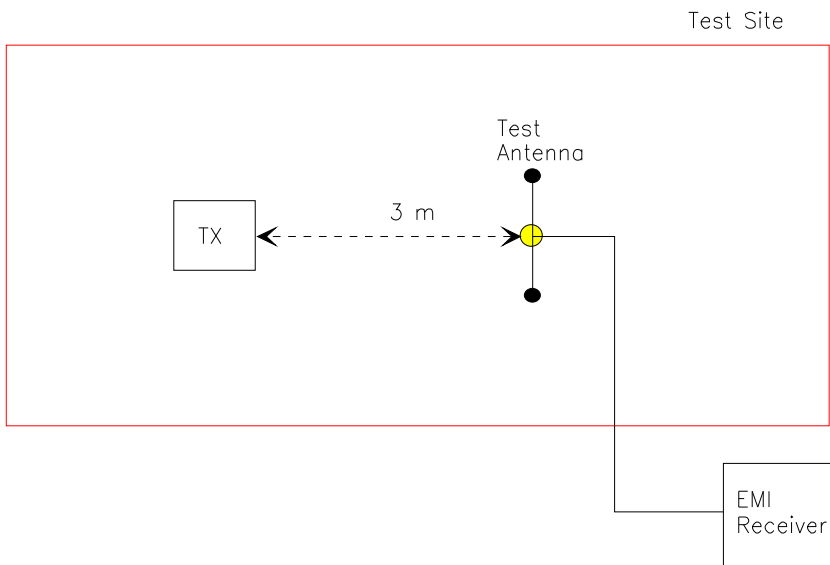
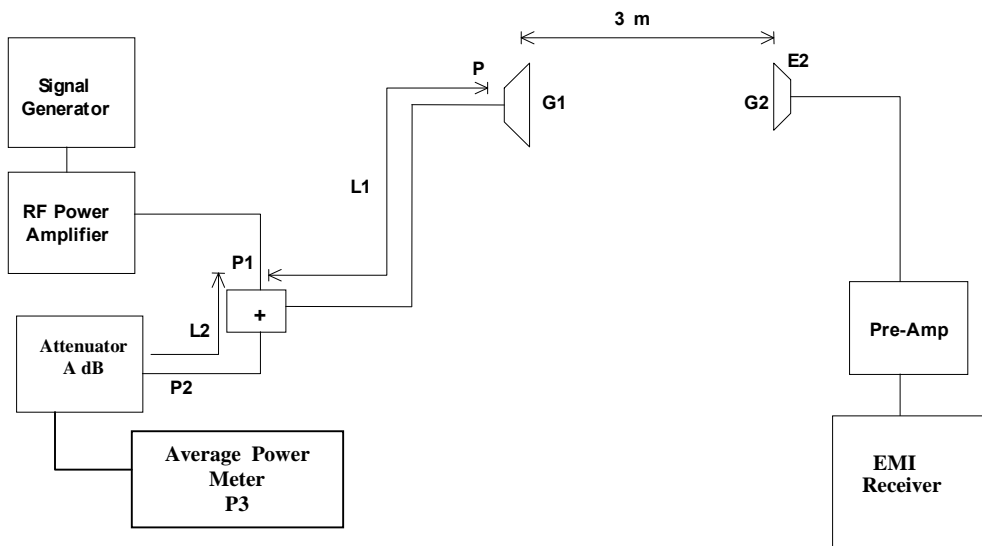

Figure 3





### 8.3. FREQUENCY STABILITY

Refer to FCC @ 2.1055.

- (a) The frequency stability shall be measured with variation of ambient temperature as follows: From -30 to +50 centigrade except that specified in subparagraph (2) & (3) of this paragraph.
- (b) Frequency measurements shall be made at extremes of the specified temperature range and at intervals of not more than 10 centigrade through the range. A period of time sufficient to stabilize all of the components of the oscillator circuit at each temperature level shall be allowed prior to frequency measurement. The short-term transient effects on the frequency of the transmitter due to keying (except for broadcast transmitters) and any heating element cycling normally occurring at each ambient temperature level also shall be shown. Only the portion or portions of the transmitter containing the frequency determining and stability circuitry need be subjected to the temperature variation test.
- (d) The frequency stability supply shall be measured with variation of primary supply voltage as follows:
  - (1) Vary primary supply voltage from 85 to 115 percent of the nominal value for other than hand carried battery equipment.
  - (2) For hand carried, battery powered equipment, reduce primary supply voltage to the battery operating end point which shall be specified by the manufacturer.
  - (3) The supply voltage shall be measured at the input to the cable normally provide with the equipment, or at the power supply terminals if cables are not normally provided. Effects on frequency of transmitter keying (except for broadcast transmitters) and any heating element cycling at the nominal supply voltage and at each extreme also shall be shown.
- (e) When deemed necessary, the Commission may require tests of frequency stability under conditions in addition to those specifically set out in paragraphs (a), (b), (c) and (d) of this section. (For example, measurements showing the effect of proximity to large metal objects, or of various types of antennas, may be required for portable equipment).

---

**ULTRATECH GROUP OF LABS**

3000 Bristol Circle, Oakville, Ontario, Canada L6H 6G4  
Tel. #: 905-829-1570, Fax. #: 905-829-8050, Email: [vic@ultratech-labs.com](mailto:vic@ultratech-labs.com), Website: <http://www.ultratech-labs.com>

**File #: ICOM-364F90**  
June 2, 2014

*All test results contained in this engineering test report are traceable to National Institute of Standards and Technology (NIST)*

#### 8.4. EMISSION MASK

**Voice or Digital Modulation Through a Voice Input Port @ 2.1049(c)(i):**- The transmitter was modulated by a 2.5 KHz tone signal at an input level 16 dB greater than that required to produce 50% modulation (e.g.:  $\pm 2.5$  KHz peak deviation at 1 KHz modulating frequency). The input level was established at the frequency of maximum response of the audio modulating circuit.

**Digital Modulation Through a Data Input Port @ 2.1049(h):**- Transmitters employing digital modulation techniques - when modulated by an input signal such that its amplitude and symbol rate represent the maximum rated conditions under which the equipment will be operated. The signal shall be applied through any filter networks, pseudo-random generators or other devices required in normal service. Additionally, the Emission Masks shall be shown for operation with any devices used for modifying the spectrum when such devices are operational at the discretion of the user.

The following EMI Receiver bandwidth shall be used for measurement of Emission Mask/Out-of-Band Emission Measurements:

- (1) For 25 KHz Channel Spacing: RBW = 300 Hz
- (2) For 12.5 KHz or 6.25 KHz Channel Spacings: RBW = 100 Hz

The all cases the Video Bandwidth shall be equal or greater than the measuring bandwidth.

#### 8.5. SPURIOUS EMISSIONS (CONDUCTED)

With transmitter modulation characteristics described in Out-of-Band Emissions measurements @ 2.1049, the transmitter spurious and harmonic emissions were scanned. The spurious and harmonic emissions were measured with the EMI Receiver controls set as RBW = 30 KHz minimum, VBW  $\geq$  RBW and SWEEP TIME = AUTO). The transmitter was operated at a full rated power output, and modulated as follows:

**FCC 47 CFR 2.1057 - Frequency spectrum to be investigated:** The spectrum was investigated from the lowest radio generated in the equipment up to at least the 10<sup>th</sup> harmonic of the carrier frequency or to the highest frequency practicable in the present state of the art of measuring techniques, whichever is lower. Particular attention should be paid to harmonics and subharmonics of the carrier frequency. Radiation at the frequencies of multiplier stages should be checked. The amplitude of spurious emissions which are attenuated more than 20 dB below the permissible value need not be reported.

**FCC 47 CFR 2.1051 - Spurious Emissions at Antenna Terminal:** The radio frequency voltage or powers generated within the equipment and appearing on a spurious frequency shall be checked at the equipment output terminals when properly loaded with a suitable artificial antenna. Curves or equivalent data shall show the magnitude of the harmonic and other spurious emission that can be detected when the equipment is operated under the conditions specified in 2.1049 as appropriate. The magnitude of spurious emissions, which are attenuated more than 20 dB below the permissible value, need not be specified.

## 8.6. TRANSIENT FREQUENCY BEHAVIOR

1. Connect the transmitter under tests as shown in the above block diagram
2. Set the signal generator to the assigned frequency and modulate with a 1 KHz tone at  $\pm 12.5$  KHz deviation and its output level to be 50 dB below the transmitter rf output at the test receiver end.
3. Set the horizontal sweep rate on the storage scope to 10 milliseconds per division and adjust the display to continuously view the 1000 Hz tone from the Demodulator Output Port (DOP) of the Test Receiver. Adjust the vertical scale amplitude control of the scope to display the 1000 Hz at  $\pm 4$  divisions vertical Center at the display.
4. Adjust the scope so it will trigger on an increasing magnitude from the RF trigger signal of the transmitter under test when the transmitter was turned on. Set the controls to store the display.
5. The output at the DOP, due to the change in the ratio of the power between the signal generator input power and transmitter output power will, because of the capture effect of the test receiver, produce a change in display: For the first part of the sweep it will show the 1 KHz test signal. Then once the receiver's demodulator has been captured by the transmitter power, the display will show the frequency difference from the assigned frequency to the actual transmitter frequency versus time. The instant when the 1 KHz test signal is completely suppressed (including any capture time due to phasing) is considered to be  $t_{on}$ . The trace should be maintained within the allowed divisions during the period  $t_1$  and  $t_2$ .
6. During the time from the end of  $t_2$  to the beginning of  $t_3$  the frequency difference should not exceed the limits set by the FCC in Part 90.214 and the outlined in the Carrier Frequency Stability sections. The allowed limit is equal to FCC frequency tolerance limits specified in FCC 90.213.
7. Repeat the above steps when the transmitter was turned off for measuring  $t_3$ .