

# ENGINEERING TEST REPORT

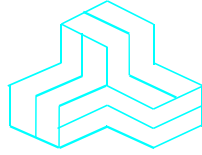

**Dual Band Transceiver  
Model No.: IC-2730A**

**FCC ID: AFJ359800**

*Applicant:*

**ICOM Incorporated**  
1-1-32, Kamiminami, Hirano-ku  
Osaka, Japan, 547-0003

**Tested in Accordance With**

**Federal Communications Commission (FCC)  
47 CFR, Part 15, Subpart B, Scanning Receivers**

**UltraTech's File No.: ICOM-392Q\_FCC15.121**

This Test report is Issued under the Authority of  
Tri M. Luu, BAsC  
Vice President of Engineering  
UltraTech Group of Labs

Date: December 10, 2014

Report Prepared by: Dharmajit Solanki

Tested by: Wei Wu and Hien Luu

Issued Date: December 10, 2014

Test Dates: December 4-8, 2014

- *The results in this Test Report apply only to the sample(s) tested, and the sample tested is randomly selected.*
- *This report must not be used by the client to claim product endorsement by NVLAP or any agency of the US Government.*

## UltraTech

3000 Bristol Circle, Oakville, Ontario, Canada, L6H 6G4  
Tel.: (905) 829-1570 Fax.: (905) 829-8050  
Website: [www.ultratech-labs.com](http://www.ultratech-labs.com), Email: [vic@ultratech-labs.com](mailto:vic@ultratech-labs.com), Email: [tri@ultratech-labs.com](mailto:tri@ultratech-labs.com)



91038



1309



46390-2049



NVLAP LAB  
CODE 200093-0



SL2-IN-E-  
1119R



CA2049



TL363\_B



TPTDP  
DA1300

## TABLE OF CONTENTS

<b>EXHIBIT 1. INTRODUCTION</b> .....	<b>1</b>
1.1. SCOPE.....	1
1.2. RELATED SUBMITTAL(S)/GRANT(S) .....	1
1.3. NORMATIVE REFERENCES .....	1
<b>EXHIBIT 2. PERFORMANCE ASSESSMENT</b> .....	<b>2</b>
2.1. CLIENT INFORMATION.....	2
2.2. EQUIPMENT UNDER TEST (EUT) INFORMATION .....	2
2.3. EUT'S TECHNICAL SPECIFICATIONS .....	3
2.4. LIST OF EUT'S PORTS.....	3
2.5. ANCILLARY EQUIPMENT.....	3
<b>EXHIBIT 3. EUT OPERATING CONDITIONS AND CONFIGURATIONS DURING TESTS</b> .....	<b>4</b>
3.1. OPERATIONAL TEST CONDITIONS & ARRANGEMENT FOR TEST SIGNALS.....	4
<b>EXHIBIT 4. SUMMARY OF TEST RESULTS</b> .....	<b>5</b>
4.1. LOCATION OF TESTS.....	5
4.2. APPLICABILITY & SUMMARY OF EMC EMISSION TEST RESULTS .....	5
4.3. MODIFICATIONS REQUIRED FOR COMPLIANCE.....	5
<b>EXHIBIT 5. MEASUREMENTS, EXAMINATIONS &amp; TEST DATA FOR EMC EMISSIONS</b> .....	<b>6</b>
5.1. TEST PROCEDURES.....	6
5.2. MEASUREMENT UNCERTAINTIES .....	6
5.3. MEASUREMENT EQUIPMENT USED .....	6
5.4. POWER LINE CONDUCTED EMISSIONS [§ 15.107(A)] .....	7
5.5. RECEIVER ANTENNA POWER SPURIOUS/HARMONIC CONDUCTED EMISSIONS [§15.111(A)] .....	10
5.6. SPURIOUS/HARMONIC RADIATED EMISSIONS FROM RECEIVER AND CLASS B UNINTENTIONAL RADIATORS (DIGITAL DEVICES) [§ 15.109(A)] .....	17
5.7. REQUIREMENTS FOR SCANNING RECEIVERS [§ 15.121].....	22
5.8. SCANNING RECEIVERS CELLULAR BAND REJECTION [§ 15.121(B)] .....	25
<b>EXHIBIT 6. TEST EQUIPMENTS LIST</b> .....	<b>27</b>
<b>EXHIBIT 7. MEASUREMENT UNCERTAINTY</b> .....	<b>28</b>
7.1. LINE CONDUCTED EMISSION MEASUREMENT UNCERTAINTY .....	28
7.2. RADIATED EMISSION MEASUREMENT UNCERTAINTY .....	28

## EXHIBIT 1. INTRODUCTION

### 1.1. SCOPE

<b>Reference:</b>	FCC Part 15, Subpart B, Sections 15.107, 15.109, 15.111 & 15.121
<b>Title:</b>	Code of Federal Regulations (CFR), Title 47, Telecommunication, Part 15
<b>Purpose of Test:</b>	To gain FCC Certification Authorization for Scanning Receivers
<b>Test Procedures:</b>	Both conducted and radiated emissions measurements were conducted in accordance with American National Standards Institute ANSI C63.4 - American National Standard for Methods of Measurement of Radio-Noise Emissions from Low-Voltage Electrical and Electronic Equipment in the Range of 9 kHz to 40 GHz
<b>Environmental Classification:</b>	Residential, Commercial, Industrial or Business environment

### 1.2. RELATED SUBMITTAL(S)/GRANT(S)

None

### 1.3. NORMATIVE REFERENCES

Publication	Year	Title
FCC CFR Parts 0-19, 80-End	2014	Code of Federal Regulations – Telecommunication
ANSI C63.4	2009	American National Standard for Methods of Measurement of Radio-Noise Emissions from Low-Voltage Electrical and Electronic Equipment in the Range of 9 kHz to 40 GHz
ANSI C63.10	2009	American National Standard for Testing Unlicensed Wireless Devices
TIA/EIA 603, Edition C	2004	Land Mobile FM or PM Communications Equipment Measurement and Performance Standards

## EXHIBIT 2. PERFORMANCE ASSESSMENT

### 2.1. CLIENT INFORMATION

APPLICANT	
<b>Name:</b>	Icom Incorporated
<b>Address:</b>	1-1-32, Kamiminami, Hirano-ku, Osaka Japan, 547-0003
<b>Contact Person:</b>	Mr. Hideji Fujishima Phone #: +81-66-793-8424 Fax #: +81-66-793-3336 Email Address: <a href="mailto:world_support@icom.co.jp">world_support@icom.co.jp</a>

MANUFACTURER	
<b>Name:</b>	Icom Incorporated
<b>Address:</b>	1-1-32, Kamiminami Hirano-ku, Osaka Japan, 547-0003
<b>Contact Person:</b>	Mr. Hideji Fujishima Phone #: +81-66-793-8424 Fax #: +81-66-793-3336 Email Address: <a href="mailto:world_support@icom.co.jp">world_support@icom.co.jp</a>

### 2.2. EQUIPMENT UNDER TEST (EUT) INFORMATION

The following information (with the exception of the Date of Receipt) has been supplied by the applicant.

<b>Brand Name:</b>	ICOM Incorporated
<b>Product Name:</b>	Dual Band Transceiver
<b>Model Name or Number:</b>	IC-2730A
<b>Serial Number:</b>	00000205
<b>Type of Equipment:</b>	Amateur Transmitter & Scanning Receiver
<b>Power Input Source:</b>	13.8V DC $\pm$ 15%

### 2.3. EUT'S TECHNICAL SPECIFICATIONS

<b>RECEIVER</b>	
<b>Equipment Type:</b>	Mobile or Fixed
<b>Power Supply Requirement:</b>	13.8V DC $\pm$ 15%
<b>Operating Frequency Range:</b>	118 - 174 MHz 375 - 550 MHz
<b>RF Input Impedance:</b>	50 $\Omega$

### 2.4. LIST OF EUT'S PORTS

Port Number	EUT's Port Description	Number of Identical Ports	Connector Type	Cable Type (Shielded/Non-shielded)
1	Antenna Connector [ANT]	1	UHF Female	Shielded
2	Ext Speaker [SP]	2	Mini Jack	Non-Shielded
3	Microphone [MIC]	1	RJ45	Non-Shielded
4	DC IN JACK [DC IN]	1	Plug-In Jack	Non-Shielded
5	Data	1	Mini Jack	Non-Shielded
6	Controller	1	RJ11	Non-Shielded

### 2.5. ANCILLARY EQUIPMENT

The EUT was tested while connected to the following representative configuration of ancillary equipment necessary to exercise the ports during tests:

<b>Ancillary Equipment # 1</b>	
Description:	External Microphone
Brand name:	ICOM
Model Name or Number:	HM-207

<b>Ancillary Equipment # 2</b>	
Description:	Display Controller
Brand name:	ICOM
Model Name or Number:	IC-2730

<b>Ancillary Equipment # 3 &amp; 4</b>	
Description:	External Speakers
Brand name:	ICOM
Model Name or Number:	SP-5 & SP-10

#### ULTRATECH GROUP OF LABS

3000 Bristol Circle, Oakville, Ontario, Canada L6H 6G4  
 Tel. #: 905-829-1570, Fax. #: 905-829-8050, Email: [vic@ultratech-labs.com](mailto:vic@ultratech-labs.com), Website: <http://www.ultratech-labs.com>

File #: ICOM-392Q\_FCC15.121

December 10, 2014

All test results contained in this engineering test report are traceable to National Institute of Standards and Technology (NIST)

## EXHIBIT 3. EUT OPERATING CONDITIONS AND CONFIGURATIONS DURING TESTS

### 3.1. OPERATIONAL TEST CONDITIONS & ARRANGEMENT FOR TEST SIGNALS

<b>Operating Modes:</b>	The receiver was operated in the normal intended mode during testing
<b>Special Test Software:</b>	None
<b>Special Hardware Used:</b>	None
<b>Receiver Test Antenna:</b>	The EUT was tested with its antenna port terminated to 50Ω

Receiver Test Signals	
<b>Frequency Band(s):</b>	118 - 174 MHz 375 - 550 MHz
<b>Test Frequency(ies):</b> (Near lowest, near middle & near highest frequencies in the frequency range of operation.)	118 MHz, 137 MHz, 174 MHz and 375 MHz, 462.5 MHz, 550 MHz

## EXHIBIT 4. SUMMARY OF TEST RESULTS

### 4.1. LOCATION OF TESTS

All of the measurements described in this report were performed at Ultratech Group of Labs located in the city of Oakville, Province of Ontario, Canada.

- AC Power Line Conducted Emissions were performed in UltraTech's shielded room, 24'(L) by 16'(W) by 8'(H).
- Radiated Emissions were performed at the Ultratech's 3-10 TDK Semi-Anechoic Chamber situated in the Town of Oakville, province of Ontario. This test site been calibrated in accordance with ANSI C63.4, and found to be in compliance with the requirements of Sec. 2.948 of the FCC Rules. The descriptions and site measurement data of the Oakville 3-10 TDK Semi-Anechoic Chamber has been filed with FCC office (FCC File No.: 91038) and Industry Canada office (Industry Canada File No.: 2049A-3). Expiry Date: 2017-04-02.

### 4.2. APPLICABILITY & SUMMARY OF EMC EMISSION TEST RESULTS

FCC Part 15, Subpart B	Test Requirements	Compliance (Yes/No)
15.107(a), Class B	Power Line Conducted Emissions Measurements	Yes
15.111(a)	Receiver Antenna Power Conducted Emissions for Non-Integral Antenna Port	Yes
15.109(a)	Radiated Emissions from Scanning Receivers & Class B Digital Device	Yes
15.121	Requirements for Scanning Receivers	Yes

### 4.3. MODIFICATIONS REQUIRED FOR COMPLIANCE

None

## **EXHIBIT 5. MEASUREMENTS, EXAMINATIONS & TEST DATA FOR EMC EMISSIONS**

### **5.1. TEST PROCEDURES**

Please refer to Ultratech Test Procedures, File# ULTR-P001-2004 and for Test Procedures.

### **5.2. MEASUREMENT UNCERTAINTIES**

The measurement uncertainties stated were calculated in accordance with the requirements of CISPR 16-4-2 @ IEC:2003 and JCGM 100:2008 (GUM 1995) – Guide to the Expression of Uncertainty in Measurement. Please refer to Exhibit 7 for Measurement Uncertainties.

### **5.3. MEASUREMENT EQUIPMENT USED**

The measurement equipment used complied with the requirements contained in ANSI C63.10 and CISPR 16-1-1.



## 5.4. POWER LINE CONDUCTED EMISSIONS [§ 15.107(a)]

### 5.4.1. Limits

The equipment shall meet the limits of the following table:

Frequency of Emissions (MHz)	Class B Conducted Limit (dB $\mu$ V)	
	Quasi-Peak	Average
0.15 to 0.5	66 to 56*	56 to 46*
0.5 to 5	56	46
5 to 30	60	50

\* Decreasing linearly with logarithm of frequency

### 5.4.2. Method of Measurements

Refer to Ultratech Test Procedures ULTR-P001-200 & ANSI C63.4 for method of measurements.

### 5.4.3. Test Arrangement (DC Power-line Conducted Emissions)

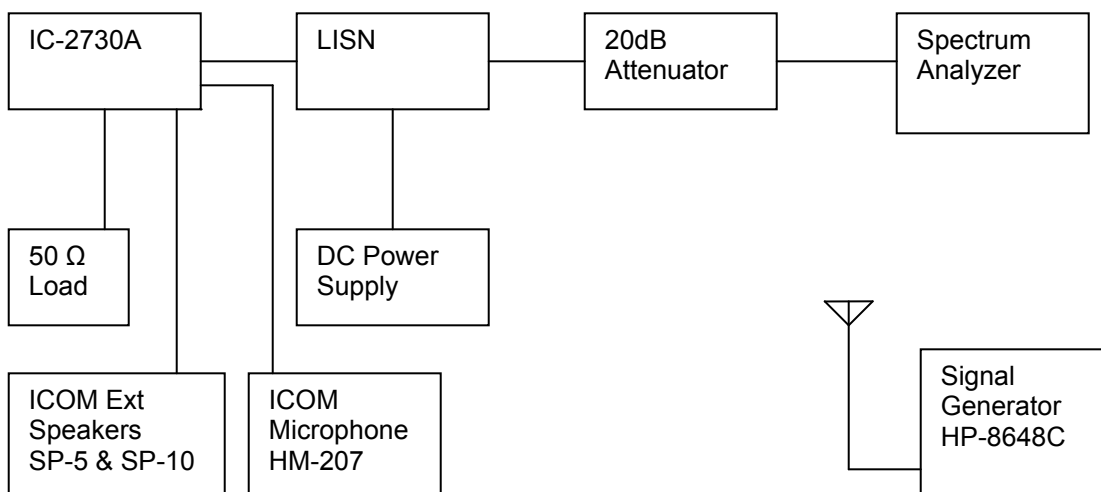

5.4.4. Test Data

5.4.4.1. DC Conducted Line Emissions

Plot 1: Power Line Conducted Emissions

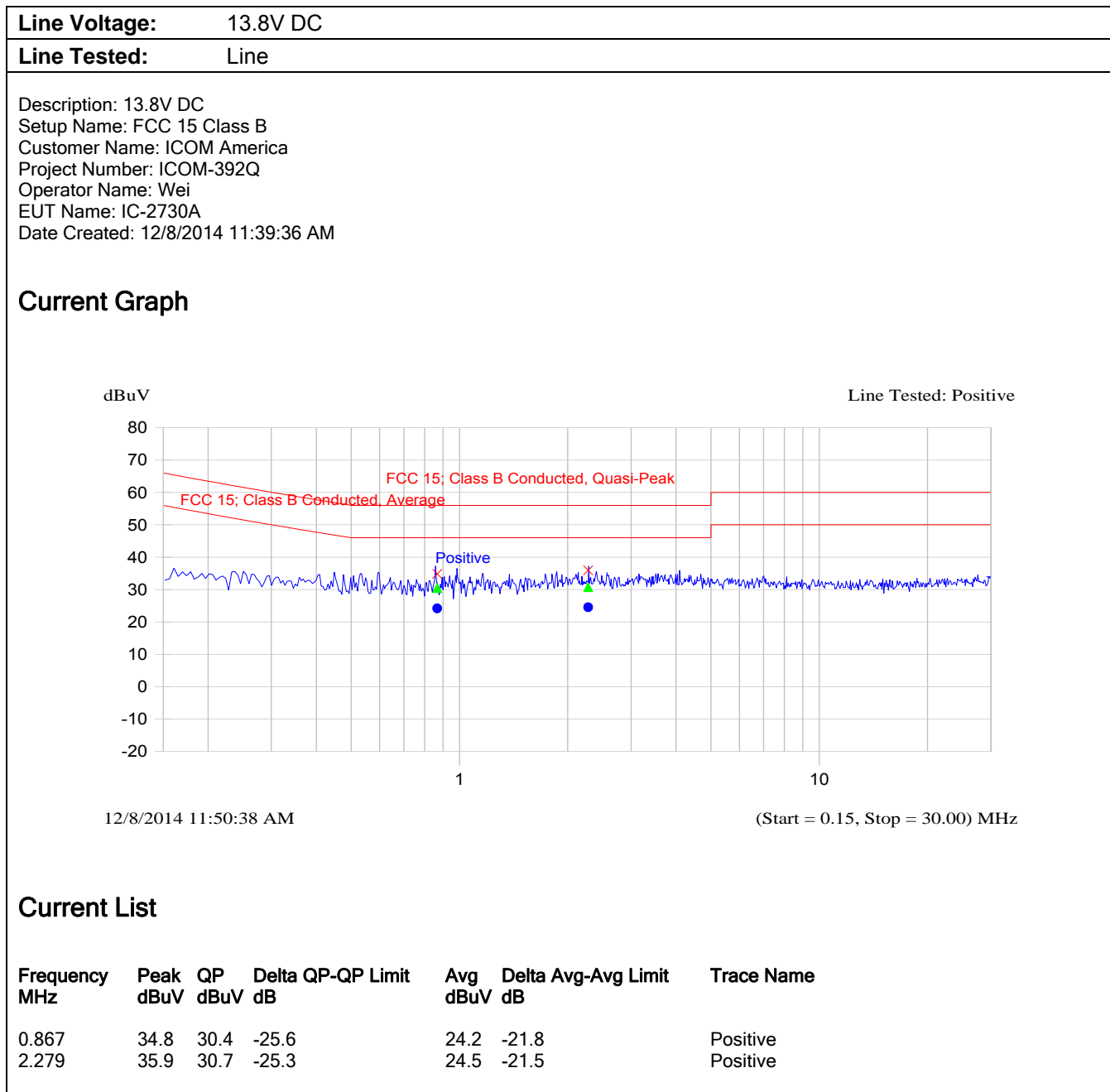

**Plot 2: Power Line Conducted Emissions**

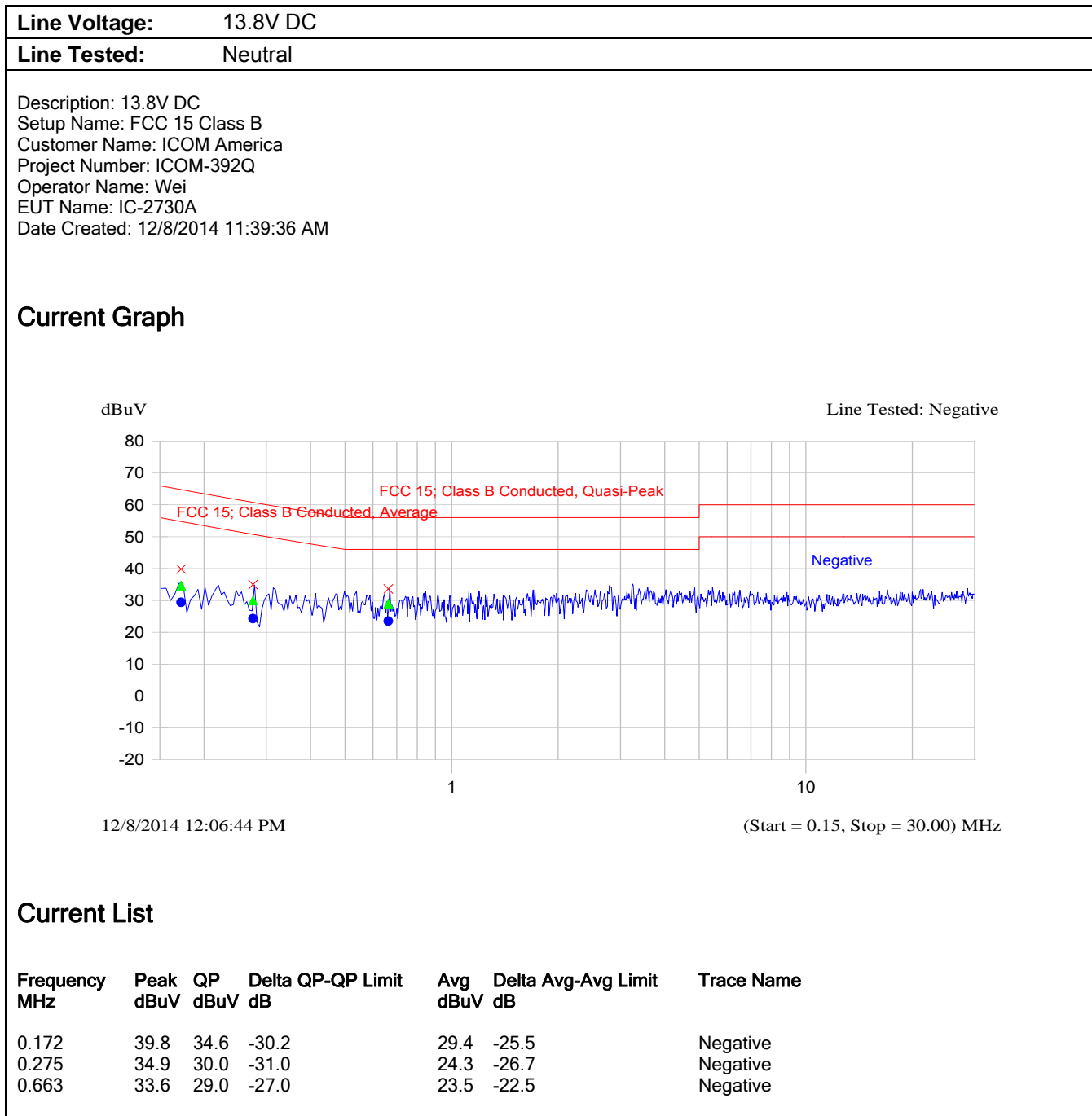

## 5.5. RECEIVER ANTENNA POWER SPURIOUS/HARMONIC CONDUCTED EMISSIONS [§ 15.111(a)]

### 5.5.1. Limits

Receivers that operate (tune) in the frequency range 30 to 960 MHz and CB receivers that provides terminals for the connection of an external antenna may be tested to demonstrate compliance with the provisions of @ 15.109 with the antenna terminals shielded and terminated with a resistive termination equal to the impedance specified for the antenna, provided these receivers also comply with the following:- With the receiver antenna terminal connected to a resistive termination equal to the impedance specified or employed for the antenna, the power at the antenna terminal at frequency within the range from 30 MHz to 5<sup>th</sup> harmonic of the highest frequency shall not exceed 2.0 nanowatts (or -57 dBm @ 50 Ohm).

### 5.5.2. Method of Measurements

Refer to Ultratech Test Procedures ULTR-P001-200 & ANSI C63.4 for method of measurements.

The spectrum shall be investigated from the lowest radio frequency signal generated or used in the device, without going below the lowest frequency for which the emission limit is specified, up to 5<sup>th</sup> harmonic of the highest frequency

### 5.5.3. Test Arrangement

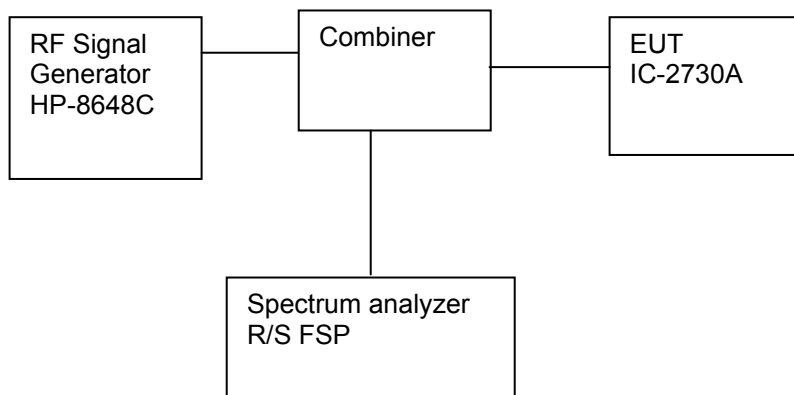

### 5.5.4. Test Data

#### 5.5.4.1. Rx Mode

Plot 3: Conducted Receiver Spurious Emissions, 30 MHz – 3.0 GHz

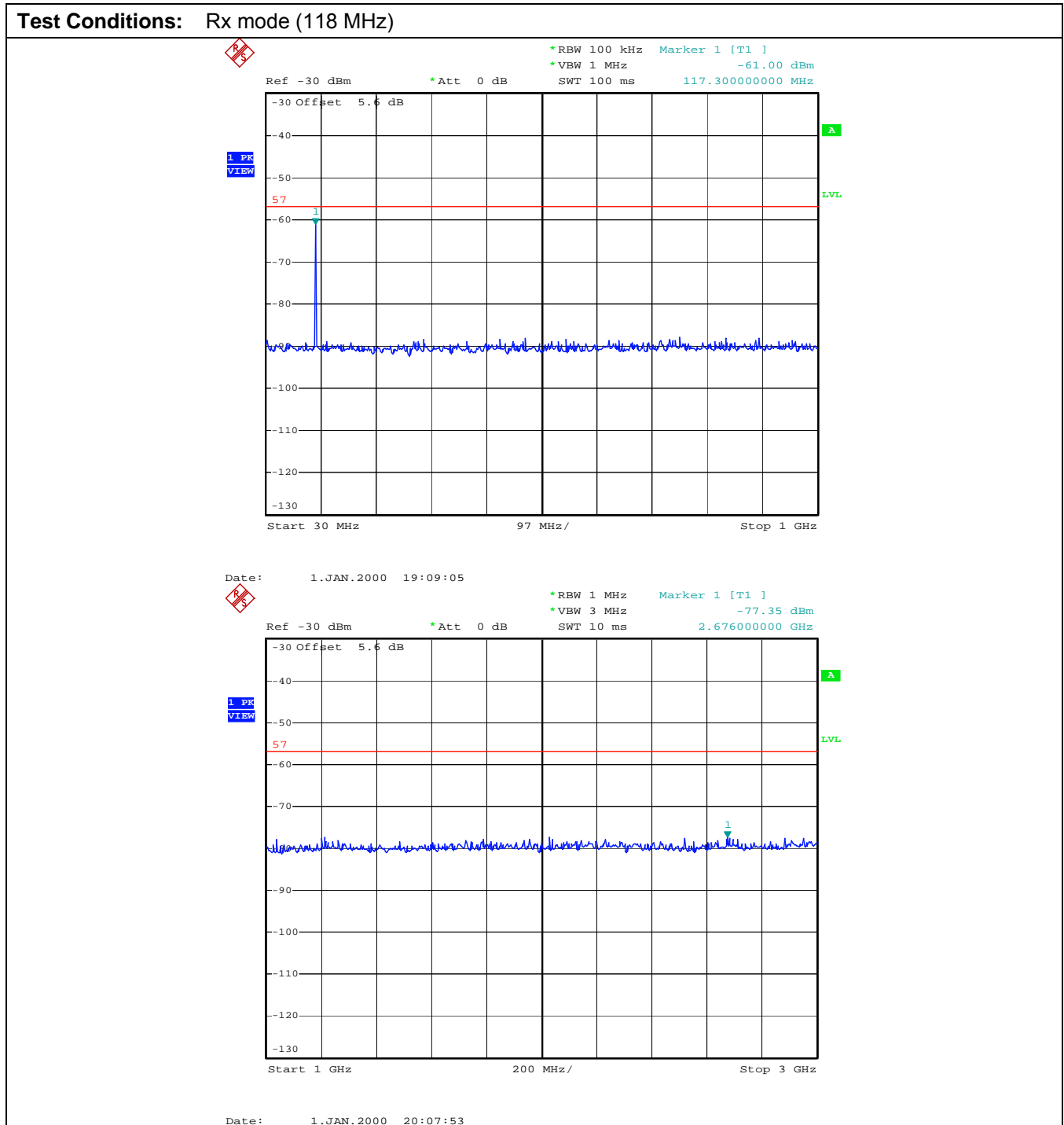

**ULTRATECH GROUP OF LABS**

3000 Bristol Circle, Oakville, Ontario, Canada L6H 6G4  
Tel. #: 905-829-1570, Fax. #: 905-829-8050, Email: [vic@ultratech-labs.com](mailto:vic@ultratech-labs.com), Website: <http://www.ultratech-labs.com>

File #: ICOM-392Q\_FCC15.121

December 10, 2014

All test results contained in this engineering test report are traceable to National Institute of Standards and Technology (NIST)

Plot 4: Conducted Receiver Spurious Emissions, 30 MHz – 3.0 GHz

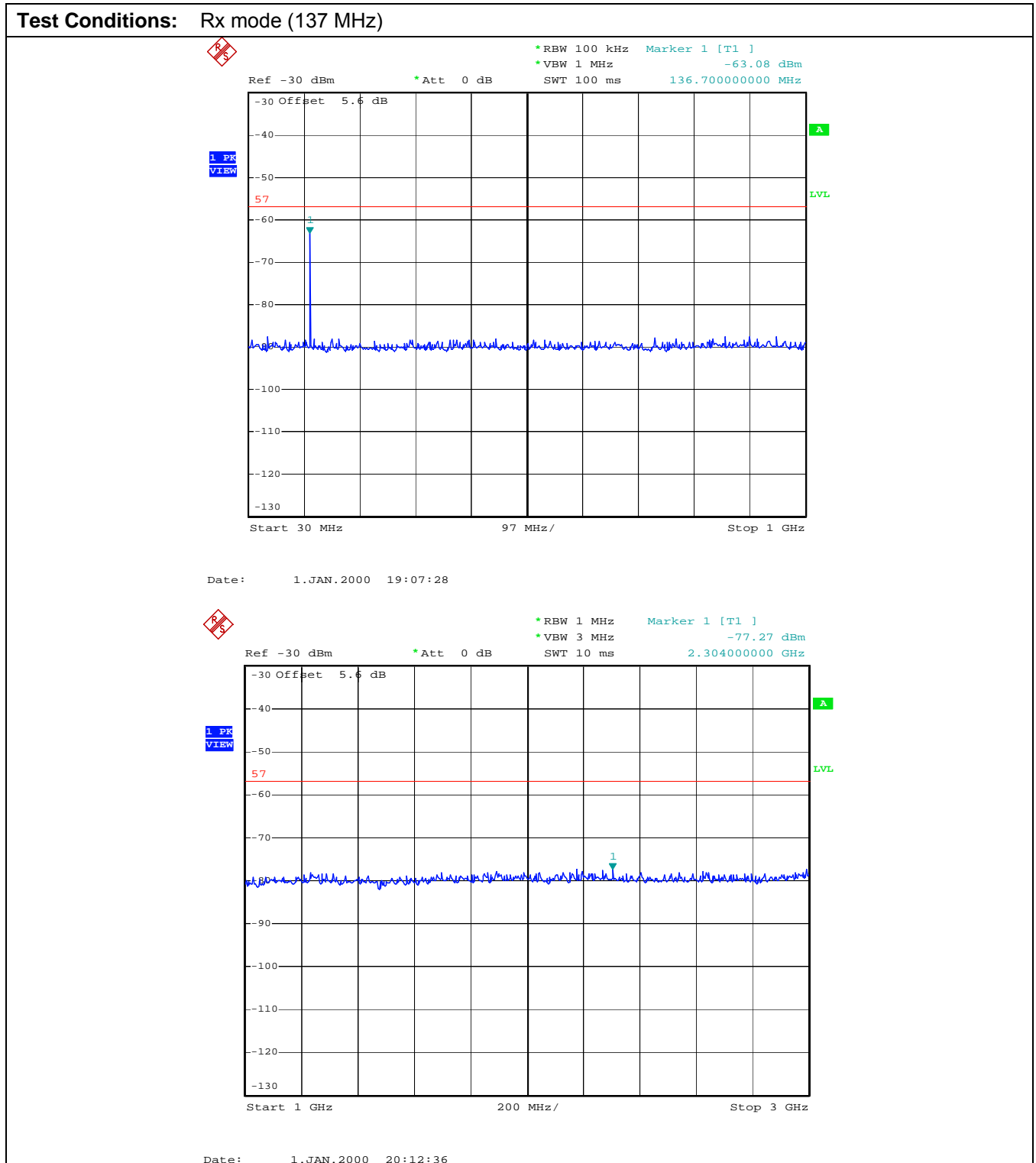

**ULTRATECH GROUP OF LABS**

3000 Bristol Circle, Oakville, Ontario, Canada L6H 6G4  
Tel. #: 905-829-1570, Fax. #: 905-829-8050, Email: [vic@ultratech-labs.com](mailto:vic@ultratech-labs.com), Website: <http://www.ultratech-labs.com>

File #: ICOM-392Q\_FCC15.121

December 10, 2014

All test results contained in this engineering test report are traceable to National Institute of Standards and Technology (NIST)

Plot 5: Conducted Receiver Spurious Emissions, 30 MHz – 3.0 GHz

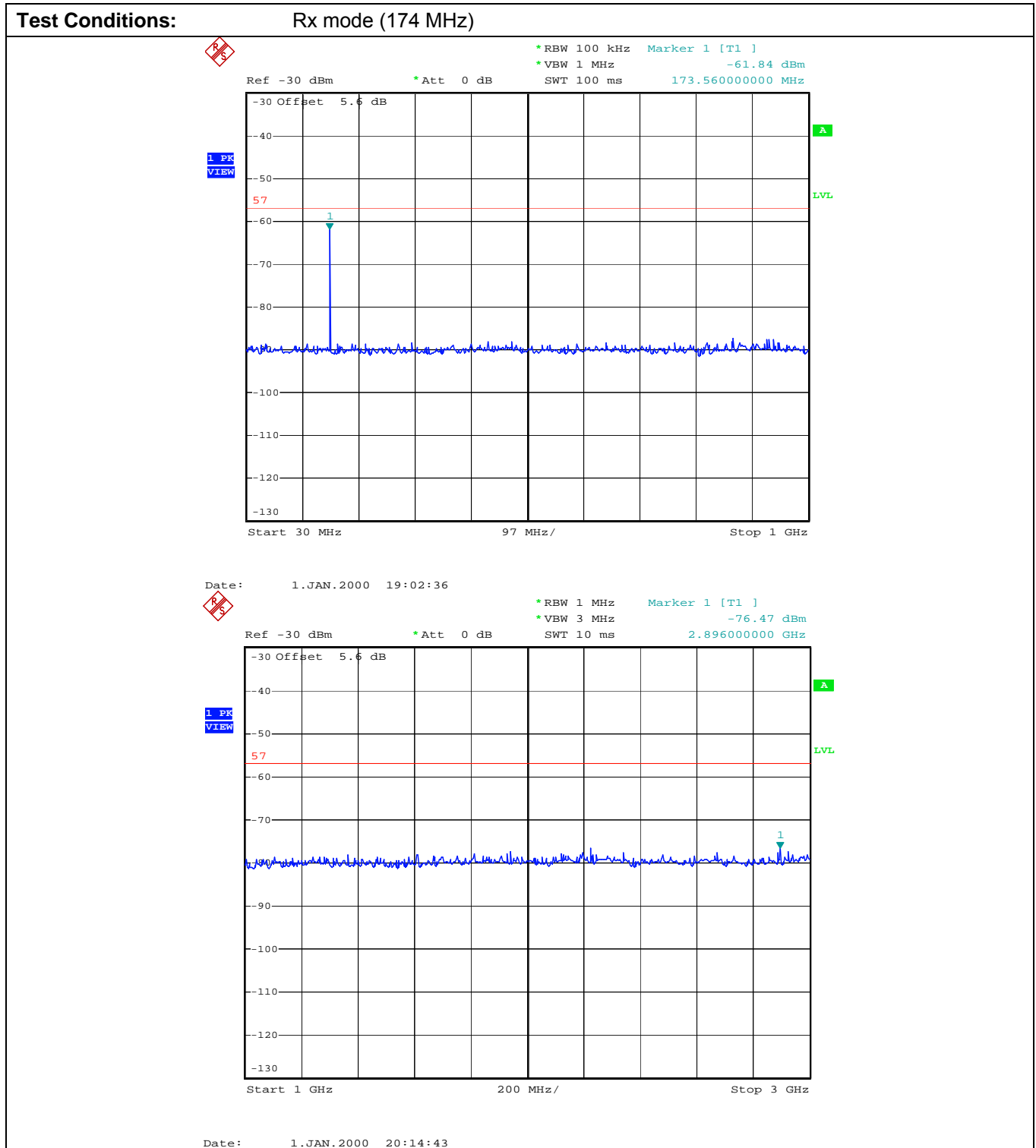

**ULTRATECH GROUP OF LABS**

3000 Bristol Circle, Oakville, Ontario, Canada L6H 6G4  
Tel. #: 905-829-1570, Fax. #: 905-829-8050, Email: [vic@ultratech-labs.com](mailto:vic@ultratech-labs.com), Website: <http://www.ultratech-labs.com>

File #: ICOM-392Q\_FCC15.121

December 10, 2014

All test results contained in this engineering test report are traceable to National Institute of Standards and Technology (NIST)

Plot 6: Conducted Receiver Spurious Emissions, 30 MHz – 3.0 GHz

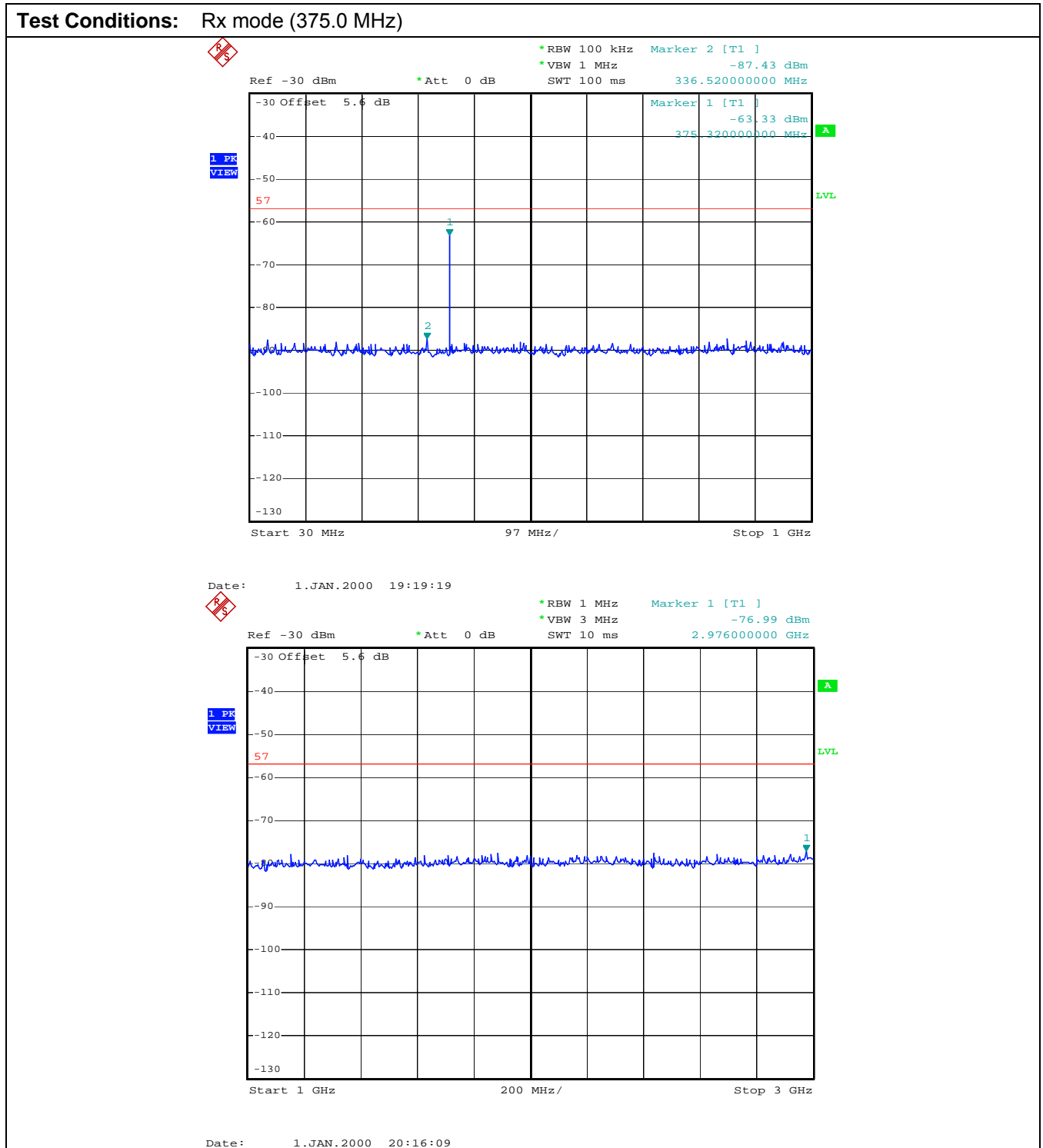

**ULTRATECH GROUP OF LABS**

3000 Bristol Circle, Oakville, Ontario, Canada L6H 6G4  
Tel. #: 905-829-1570, Fax. #: 905-829-8050, Email: [vic@ultratech-labs.com](mailto:vic@ultratech-labs.com), Website: <http://www.ultratech-labs.com>

File #: ICOM-392Q\_FCC15.121

December 10, 2014

All test results contained in this engineering test report are traceable to National Institute of Standards and Technology (NIST)



Plot 7: Conducted Receiver Spurious Emissions, 30 MHz – 3.0 GHz

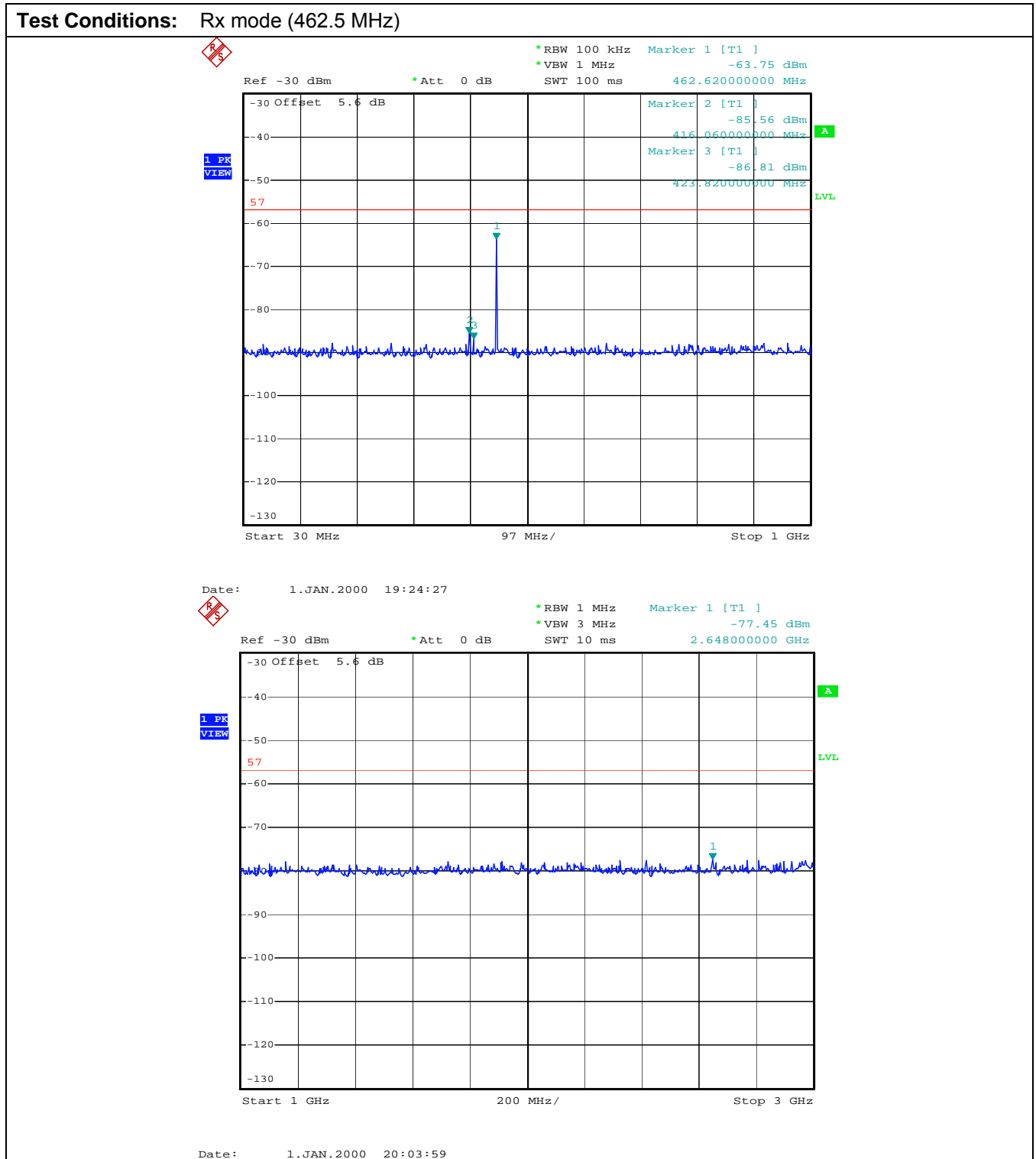

**ULTRATECH GROUP OF LABS**

3000 Bristol Circle, Oakville, Ontario, Canada L6H 6G4  
Tel. #: 905-829-1570, Fax. #: 905-829-8050, Email: [vic@ultratech-labs.com](mailto:vic@ultratech-labs.com), Website: <http://www.ultratech-labs.com>

File #: ICOM-392Q\_FCC15.121

December 10, 2014

All test results contained in this engineering test report are traceable to National Institute of Standards and Technology (NIST)

Plot 8: Conducted Receiver Spurious Emissions, 30 MHz – 3.0 GHz

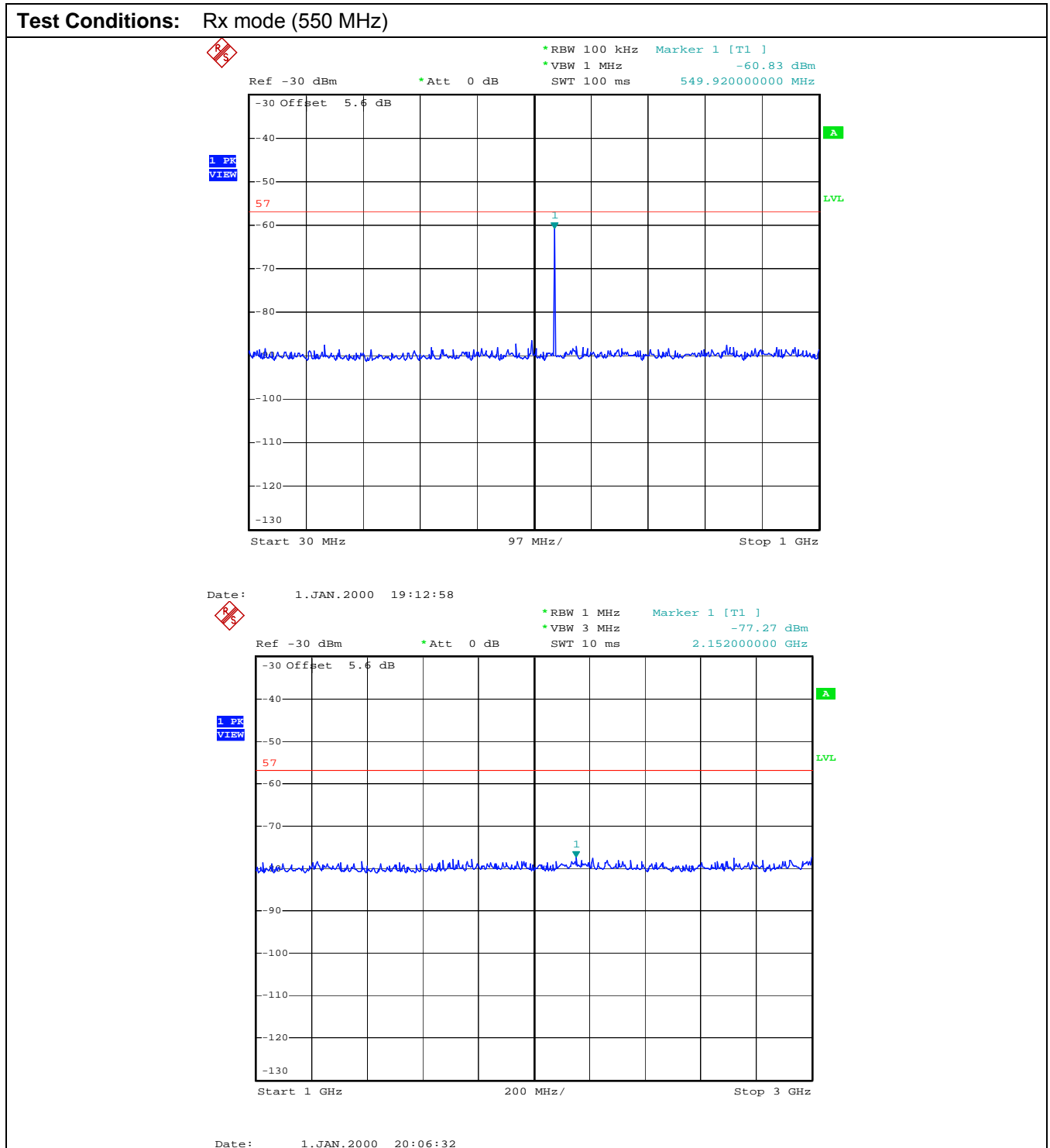

**ULTRATECH GROUP OF LABS**

3000 Bristol Circle, Oakville, Ontario, Canada L6H 6G4  
Tel. #: 905-829-1570, Fax. #: 905-829-8050, Email: [vic@ultratech-labs.com](mailto:vic@ultratech-labs.com), Website: <http://www.ultratech-labs.com>

File #: ICOM-392Q\_FCC15.121

December 10, 2014

All test results contained in this engineering test report are traceable to National Institute of Standards and Technology (NIST)

## 5.6. SPURIOUS/HARMONIC RADIATED EMISSIONS FROM RECEIVER AND CLASS B UNINTENTIONAL RADIATORS (DIGITAL DEVICES) [§ 15.109(a)]

### 5.6.1. Limits

The equipment shall meet the limits of the following table:

Test Frequency Range (MHz)	Class B Limits @ 3 m (dB $\mu$ V/m)
30 – 88	40.0
88 – 216	43.5
216 – 960	46.0
Above 960	54.0

### 5.6.2. Method of Measurements

Refer to Ultratech Test Procedures ULTR-P001-200 & ANSI C63.4 for method of measurements.

The spectrum shall be investigated from the lowest radio frequency signal generated or used in the device, without going below the lowest frequency for which a radiated emission limit is specified, up to the frequency shown in the following table:

Highest frequency generated or used in the device or on which the device operates or tunes (MHz)	Upper frequency of measurement range (MHz)
Below 1.705	30
1.705 - 108	1000
108 – 500	2000
500 -1000	5000
Above 1000	5 <sup>th</sup> harmonic of the highest frequency or 40 GHz, whichever is lower

### 5.6.3. Test Arrangement

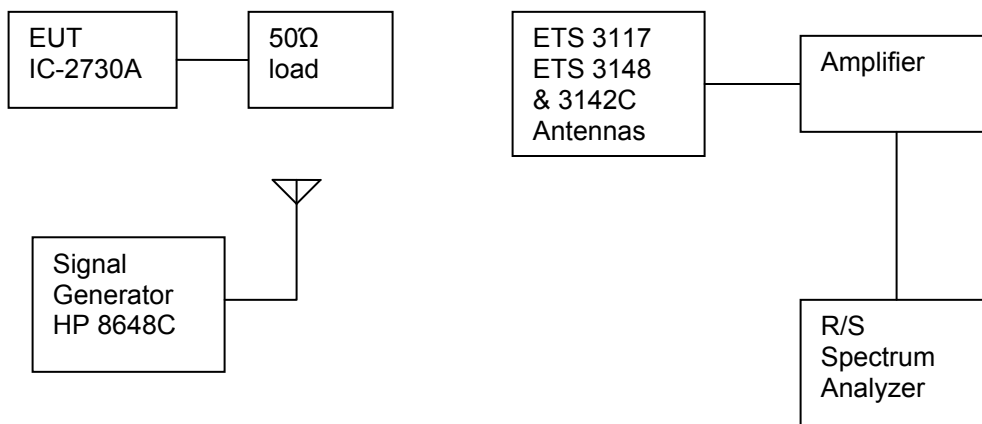

### 5.6.4. Test Data

Remarks:

- The measuring receiver shall be tuned over the frequency range 30 MHz to 6 GHz @ 3m.
- All spurious emissions that are in excess of 20 dB below the specified limit shall be recorded.

#### (A) Left Side Receiver (IF is 38.85 MHz)

##### 5.6.4.1. Lowest Frequency (118.0 MHz)

Frequency (MHz)	RF Level (dBμV/m)	Detector Used (Peak/QP/Avg)	Antenna Plane (H/V)	Limit (dBμV/m)	Margin (dB)	Pass/Fail
Up to 5 <sup>th</sup> Harmonics	--	Peak	V/H	As applicable	--	Pass
All receiver spurious emissions are more than 20 dB below the limit.						

##### 5.6.4.2. Near Middle Frequency (137 MHz)

Frequency (MHz)	RF Level (dBμV/m)	Detector Used (Peak/QP/Avg)	Antenna Plane (H/V)	Limit (dBμV/m)	Margin (dB)	Pass/Fail
Up to 5 <sup>th</sup> Harmonics	--	Peak	V/H	As applicable	--	Pass
All receiver spurious emissions are more than 20 dB below the limit.						

**5.6.4.3. Highest Frequency (174.0 MHz)**

Frequency (MHz)	RF Level (dBµV/m)	Detector Used (Peak/QP/Avg)	Antenna Plane (H/V)	Limit (dBµV/m)	Margin (dB)	Pass/Fail
Up to 5 <sup>th</sup> Harmonics	--	Peak	V/H	As applicable	--	Pass
All receiver spurious emissions are more than 20 dB below the limit.						

**5.6.4.4. Lowest Frequency (375.0 MHz)**

Frequency (MHz)	RF Level (dBµV/m)	Detector Used (Peak/QP/Avg)	Antenna Plane (H/V)	Limit (dBµV/m)	Margin (dB)	Pass/Fail
Up to 5 <sup>th</sup> Harmonics	--	Peak	V/H	As applicable	--	Pass
All receiver spurious emissions are more than 20 dB below the limit.						

**5.6.4.5. Near Middle Frequency (462.5 MHz)**

Frequency (MHz)	RF Level (dBµV/m)	Detector Used (Peak/QP/Avg)	Antenna Plane (H/V)	Limit (dBµV/m)	Margin (dB)	Pass/Fail
2118.25	38.27	Peak	V	54.0	-15.7	Pass
2118.25	37.65	Peak	H	54.0	-16.3	Pass
All receiver spurious emissions are more than 20 dB below the limit.						

**5.6.4.6. Highest Frequency (550 MHz)**

Frequency (MHz)	RF Level (dBµV/m)	Detector Used (Peak/QP/Avg)	Antenna Plane (H/V)	Limit (dBµV/m)	Margin (dB)	Pass/Fail
1533.45	44.02	Peak	V	54.0	-10.0	Pass
1533.45	42.63	Peak	H	54.0	-11.4	Pass
2044.6	43.87	Peak	V	54.0	-10.1	Pass
2044.6	41.19	Peak	H	54.0	-12.8	Pass
2555.75	41.52	Peak	V	54.0	-12.5	Pass
All receiver spurious emissions are more than 20 dB below the limit.						

**(B) Right side Receiver (IF is 46.35 MHz)**

**5.6.4.7. Lowest Frequency (118.0 MHz)**

Frequency (MHz)	RF Level (dBµV/m)	Detector Used (Peak/QP/Avg)	Antenna Plane (H/V)	Limit (dBµV/m)	Margin (dB)	Pass/Fail
Up to 5 <sup>th</sup> Harmonics	--	Peak	V/H	As applicable	--	Pass
All receiver spurious emissions are more than 20 dB below the limit.						

**5.6.4.8. Near Middle Frequency (137 MHz)**

Frequency (MHz)	RF Level (dBµV/m)	Detector Used (Peak/QP/Avg)	Antenna Plane (H/V)	Limit (dBµV/m)	Margin (dB)	Pass/Fail
Up to 5 <sup>th</sup> Harmonics	--	Peak	V/H	As applicable	--	Pass
All receiver spurious emissions are more than 20 dB below the limit.						

**5.6.4.9. Highest Frequency (174.0 MHz)**

Frequency (MHz)	RF Level (dBµV/m)	Detector Used (Peak/QP/Avg)	Antenna Plane (H/V)	Limit (dBµV/m)	Margin (dB)	Pass/Fail
Up to 5 <sup>th</sup> Harmonics	--	Peak	V/H	As applicable	--	Pass
All receiver spurious emissions are more than 20 dB below the limit.						

**5.6.4.10. Lowest Frequency (375.0 MHz)**

Frequency (MHz)	RF Level (dBµV/m)	Detector Used (Peak/QP/Avg)	Antenna Plane (H/V)	Limit (dBµV/m)	Margin (dB)	Pass/Fail
Up to 5 <sup>th</sup> Harmonics	--	Peak	V/H	As applicable	--	Pass
All receiver spurious emissions are more than 20 dB below the limit.						

**5.6.4.11. Near Middle Frequency (462.5 MHz)**

Frequency (MHz)	RF Level (dBµV/m)	Detector Used (Peak/QP/Avg)	Antenna Plane (H/V)	Limit (dBµV/m)	Margin (dB)	Pass/Fail
Up to 5 <sup>th</sup> Harmonics	--	Peak	V/H	As applicable	--	Pass
All receiver spurious emissions are more than 20 dB below the limit.						

**5.6.4.12. Highest Frequency (550 MHz)**

Frequency (MHz)	RF Level (dBµV/m)	Detector Used (Peak/QP/Avg)	Antenna Plane (H/V)	Limit (dBµV/m)	Margin (dB)	Pass/Fail
Up to 5 <sup>th</sup> Harmonics	--	Peak	V/H	As applicable	--	Pass
All receiver spurious emissions are more than 20 dB below the limit.						

### 5.6.4.13. Radiated Emissions from Class B Digital Devices

**Remark:** The emissions were scanned from 30 MHz to 6 GHz at 3 m distance.  
Rx was set at 118 MHz & also in scanning mode.

Frequency (MHz)	Measured Field Strength @ 3 m (dBµV/m)	Detector Used (Peak/QP)	Antenna Plane (H/V)	Field Strength Limits (dBµV/m)	Margin (dB)
30-6000	--	Peak	V/H	As applicable	--
All emissions are more than 20 dB below the limit.					

## 5.7. REQUIREMENTS FOR SCANNING RECEIVERS [§ 15.121]

### 5.7.1. FCC Rules

- a. Except as provided in paragraph (c) of this section, scanning receivers and frequency converters designed or marketed for use with scanning receivers, shall:
  - (1) Be incapable of operating (tuning), or readily being altered by the user to operate, within the frequency bands allocated to the Cellular Radiotelephone Service in part 22 of this chapter (cellular telephone bands). Scanning receivers capable of "readily being altered by the user" include, but are not limited to, those for which the ability to receive transmissions in the cellular telephone bands can be added by clipping the leads of, or installing, a simple component such as a diode, resistor or jumper wire; replacing a plug-in semiconductor chip; or programming a semiconductor chip using special access codes or an external device, such as a personal computer. Scanning receivers, and frequency converters designed for use with scanning receivers, also shall be incapable of converting digital cellular communication transmissions to analog voice audio.
  - (2) Be designed so that the tuning, control and filtering circuitry is inaccessible. The design must be such that any attempts to modify the equipment to receive transmissions from the Cellular Radiotelephone Service likely will render the receiver inoperable.
- b. Except as provided in paragraph (c) of this section, scanning receivers shall reject any signals from the Cellular Radiotelephone Service frequency bands that are 38 dB or lower based upon a 12 dB SINAD measurement, which is considered the threshold where a signal can be clearly discerned from any interference that may be present.
- c. Scanning receivers and frequency converters designed or marketed for use with scanning receivers, are not subject to the requirements of paragraphs (a) and (b) of this section provided that they are manufactured exclusively for, and marketed exclusively to, entities described in 18 U.S.C. 2512(2), or are marketed exclusively as test equipment pursuant to Sec. 15.3(dd)
- d. Modification of a scanning receiver to receive transmissions from Cellular Radiotelephone Service frequency bands will be considered to constitute manufacture of such equipment. This includes any individual, individuals, entity or organization that modifies one or more scanners. Any modification to a scanning receiver to receive transmissions from the Cellular Radiotelephone Service frequency bands voids the certification of the scanning receiver, regardless of the date of manufacture of the original unit. In addition, the provisions of Sec. 15.23 shall not be interpreted as permitting modification of a scanning receiver to receive cellular radiotelephone service transmissions.
- e. Scanning receivers and frequency converters designed for use with scanning receivers shall not be assembled from kits or marketed in kit form unless they comply with the requirements in paragraph (a) through (c) of this section.



- f. Scanning receivers shall have a label permanently affixed to the product, and this label shall be readily visible to the purchaser at the time of purchase. The label shall read as follows: WARNING: MODIFICATION OF THIS DEVICE TO RECEIVE CELLULAR RADIOTELEPHONE SERVICE SIGNALS IS PROHIBITED UNDER FCC RULES AND FEDERAL LAW.
- (1) ``Permanently affixed'' means that the label is etched, engraved, stamped, silkscreened, indelible printed or otherwise permanently marked on a permanently attached part of the equipment or on a nameplate of metal, plastic or other material fastened to the equipment by welding, riveting, or permanent adhesive. The label shall be designed to last the expected lifetime of the equipment in the environment in which the equipment may be operated and must not be readily detachable. The label shall not be a stick-on, paper label.
  - (2) When the device is so small that it is not practicable to place the warning label on it, the information required by this paragraph shall be placed in a prominent location in the instruction manual or pamphlet supplied to the user and shall also be placed on the container in which the device is marketed. However, the FCC identifier must be displayed on the device.

### 5.7.2. Declaration for Compliance with FCC §15.121

- Comply with FCC 121(a)(1) – This Scanning Receiver is incapable of operating (tuning), or readily being altered by the user to operate, within the frequency bands allocated to the Cellular Radiotelephone Service in part 22 of this chapter (cellular telephone bands).

Please refer to ICOM attestation letter conforming compliance with this requirement.

- Comply with FCC 121(a)(2) – This Scanning Receiver is designed so that the tuning, control and filtering circuitry is inaccessible. The design is such that any attempts to modify the equipment to receive transmissions from the Cellular Radiotelephone Service likely will render the receiver inoperable.

Please refer to ICOM attestation letter conforming compliance with this requirement.

- Comply with FCC 121(b) – Please refer to the Section 5.8 of this Test Report for Scanning Receivers Cellular Band Rejection test.
- Comply with FCC 121(c) – Not applicable.
- Comply with FCC 121(d) – The Users Manual of this Scanning Receiver is provided with the Warning statement as below.

**CAUTION: Changes or modifications to this device, not expressly approved by ICOM Inc., could void your authority to operate this device under FCC regulations.**

- Comply with FCC 121(e) – This Scanning Receiver is not assembled from kits or marketed in kit form.
- Comply with FCC 121(f) – Scanning receivers shall have a label permanently affixed to the product, and this label shall be readily visible to the purchaser at the time of purchase. The label reads as follows: **WARNING: MODIFICATION OF THIS DEVICE TO RECEIVE CELLULAR RADIOTELEPHONE SERVICE SIGNALS IS PROHIBITED UNDER FCC RULES AND FEDERAL LAW.**

## 5.8. SCANNING RECEIVERS CELLULAR BAND REJECTION [§ 15.121(b)]

### 5.8.1. Limits

Except as provided in paragraph (c) of this section, scanning receivers shall reject any signals from the Cellular Radiotelephone Service frequency bands that are 38dB or lower based upon a 12dB SINAD measurement, which is considered the threshold where a signal can be clearly discerned from any interference that may be present.

### 5.8.2. Method of Measurements

- (1) Connected the EUT as shown in the following block diagram
- (2) Apply a standard RF signal to the receiver input port
- (3) Adjust the audio output signal of the receiver to it's rated value with the distortion less than 10%
- (4) Adjust the RF Signal Generator Output Power to produce 12 dB SINAD without the audio output power dropping by more than 3 dB
- (5) Repeat step (4) at lowest, middle and highest channel frequencies across all cellular base station band to establish a reference sensitivity level. The reference sensitivity taken was the lowest or worse-case sensitivity for all of the bands.
- (6) Adjust the RF Signal Generator output to a level of +60 dB above the reference sensitivity obtained in step (5)
- (7) Set the Receiver squelch threshold (the signal required to open the squelch) no greater than +20 dB above the reference sensitivity level.
- (8) Put the receiver in a scanning mode and allow it to scan across it's complete receive range
- (9) If the receiver unsquelched or stopped on any frequency, the display frequency is recorded. The signal generator output level was then adjusted until 12 dB SINAD from the receiver was produced. The signal generator level associated with this response was also noted.
- (10) Repeat this procedure for 3 frequencies in the cellular base station transmit band.
- (11) The difference between the signal generator output for any response recorded and reference sensitivity is the rejection ratio

### 5.8.3. Test Arrangement

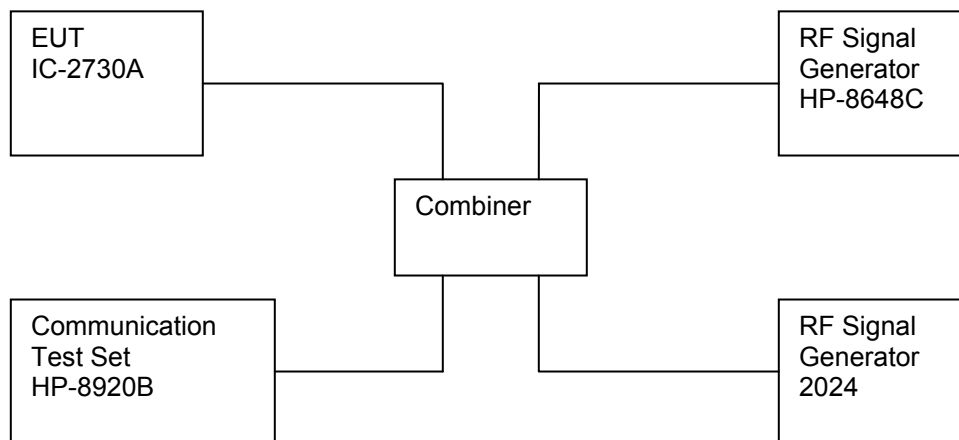

**Receiver Sensitivity Test**

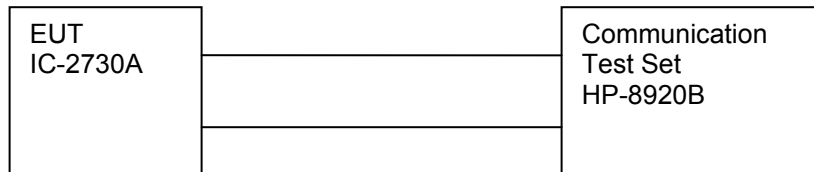

**5.8.4. Test Data**

Remark: Cellular Transmitter Test frequencies are 824.04, 836.4, 848.97, 869.04, 880.62 and 893.97 MHz.

Test Modulations: AM, FM & FM-N

Eut’s sensitivity specification: FM/FM-N  $\leq 0.32\mu\text{V}$  (-116.9 dBm) &  $0.56\mu\text{V}$  (-112.0 dBm), AM (10dB S/N)  $\leq 1\mu\text{V}$  (-107 dBm)

**5.8.4.1. Left Side Receiver (IF is 38.85 MHz)**

EUT’s Scanning Frequency Band & Rx locked frequencies (MHz)	Cellular Transmitter Test Frequencies (MHz)	RF Input Signal Level @ Cellular Frequencies for 12 dB SINAD (dBm)	Sensitivity for 12 dB SINAD (dBm)	Rejection Ratio (dB)	Rejection Ratio Limit (dB)
118–174, 375–550 & 164.345, 380.50, 417.5, 493.05	824.04, 836.40, 848.97, 869.04, 880.62, 893.97.	-45.0	<-118.5	<-73.0	<-38.0

**5.8.4.2. Right side Receiver (IF is 46.35 MHz)**

EUT’s Scanning Frequency Band & Rx locked frequencies (MHz)	Cellular Transmitter Test Frequencies (MHz)	RF Input Signal Level @ Cellular Frequencies for 12 dB SINAD (dBm)	Sensitivity for 12 dB SINAD (dBm)	Rejection Ratio (dB)	Rejection Ratio Limit (dB)
118–174, 375–550 & 156.845, 417.5, 470.55	824.04, 836.40, 848.97, 869.04, 880.62, 893.97.	-45.0	<-115.3	<-70.0	<-38.0

## EXHIBIT 6. TEST EQUIPMENTS LIST

Test Instruments	Manufacturer	Model No.	Serial No.	Frequency Range	Cal. Due Date
Spectrum Analyzer	Rohde & Schwarz	FSP	834157/005	9 KHz – 40 GHz	06 Oct 2015
EMI Receiver	Rohde & Schwarz	ESU40	100037	20 Hz - 40 GHz	05 Apr 2015
Pre Amplifier	AH System	PAM-0118	225	20 MHz - 18 GHz	07 Apr 2015
Bi-Conilog antenna	EMCO	3142C	26873	26-3000 MHz	14 Apr 2015
Log Periodic Antenna	ETS	3148	23845	200-2000 MHz	14 Apr 2015
Horn Antenna	EMCO	3117	119425	1GHz - 18 GHz	02 May 2015
Combiner	Mini Circuit	ZFSC-3-4	15542	1MHz - 1GHz	--
Radio Communication Test Set	HP	HP-8920B	US39064699	30M-1000MHz	17 Jan 2015
Signal Generator	Marconi Instruments	2024	202304/141	9KHz-2.4GHz	16 Jan 2015
Signal Generator	HP	8648C	3443U00391	100KHz-3.2GHz	11 Feb 2015
Preamplifier	Hewlett Packard	8449B	3008A00769	1-26.5GHz	25 Nov 2015

### ULTRATECH GROUP OF LABS

3000 Bristol Circle, Oakville, Ontario, Canada L6H 6G4  
 Tel. #: 905-829-1570, Fax. #: 905-829-8050, Email: [vic@ultratech-labs.com](mailto:vic@ultratech-labs.com), Website: <http://www.ultratech-labs.com>

File #: ICOM-392Q\_FCC15.121

December 10, 2014

All test results contained in this engineering test report are traceable to National Institute of Standards and Technology (NIST)

## EXHIBIT 7. MEASUREMENT UNCERTAINTY

The measurement uncertainties stated were calculated in accordance with the requirements of CISPR 16-4-2 @ IEC:2003 and JCGM 100:2008 (GUM 1995) – Guide to the Expression of Uncertainty in Measurement.

### 7.1. LINE CONDUCTED EMISSION MEASUREMENT UNCERTAINTY

	Line Conducted Emission Measurement Uncertainty (150 kHz – 30 MHz):	Measured	Limit
$u_c$	Combined standard uncertainty: $u_c(y) = \sqrt{\sum_{i=1}^m u_i^2(y)}$	$\pm 1.57$	$\pm 1.8$
<b>U</b>	Expanded uncertainty U: $U = 2u_c(y)$	$\pm 3.14$	$\pm 3.6$

### 7.2. RADIATED EMISSION MEASUREMENT UNCERTAINTY

	Radiated Emission Measurement Uncertainty @ 3m, Horizontal (30-1000 MHz):	Measured	Limit
$u_c$	Combined standard uncertainty: $u_c(y) = \sqrt{\sum_{i=1}^m u_i^2(y)}$	$\pm 2.15$	$\pm 2.6$
<b>U</b>	Expanded uncertainty U: $U = 2u_c(y)$	$\pm 4.30$	$\pm 5.2$

	Radiated Emission Measurement Uncertainty @ 3m, Vertical (30-1000 MHz):	Measured	Limit
$u_c$	Combined standard uncertainty: $u_c(y) = \sqrt{\sum_{i=1}^m u_i^2(y)}$	$\pm 2.39$	$\pm 2.6$
<b>U</b>	Expanded uncertainty U: $U = 2u_c(y)$	$\pm 4.78$	$\pm 5.2$

	Radiated Emission Measurement Uncertainty @ 3 m, Horizontal & Vertical (1 – 18 GHz):	Measured	Limit
$u_c$	Combined standard uncertainty: $u_c(y) = \sqrt{\sum_{i=1}^m u_i^2(y)}$	$\pm 1.87$	Under consideration
<b>U</b>	Expanded uncertainty U: $U = 2u_c(y)$	$\pm 3.75$	Under consideration