



INSTRUCTION MANUAL

VHF MARINE TRANSCEIVER

IC-M73 IC-M73EURO

This device complies with Part 15 of the FCC Rules. Operation is subject to the condition that this device does not cause harmful interference.

Icom Inc.



FOREWORD

Thank you for purchasing this Icom product. The IC-M73/IC-M73EURO VHF MARINE TRANSCEIVER is designed and built with Icom's state of the art technology and craftsmanship. With proper care, this product should provide you with years of trouble-free operation.

IMPORTANT

READ ALL INSTRUCTIONS carefully and completely before using the transceiver.

SAVE THIS INSTRUCTION MANUAL — This instruction manual contains important operating instructions for the IC-M73/IC-M73EURO.

EXPLICIT DEFINITIONS

WORD	DEFINITION
⚠ WARNING!	Personal injury, fire hazard or electric shock may occur.
CAUTION	Equipment damage may occur.
NOTE	If disregarded, inconvenience only. No risk of personal injury, fire or electric shock.

FEATURES

Submersible construction

Built tough to withstand the punishing marine environment, the IC-M73/IC-M73EURO's submersible construction meets IPX8 of the corresponding International Standard IEC 60529 (2001) while using BP-245N.

In addition, the new speaker grill structure with a water self-draining function is helpful for draining water or seawater easily.

Dualwatch and tri-watch functions

Convenient functions that allow you to monitor the distress channel (Ch 16) while receiving one other channel of your choice (dualwatch), or while receiving one other channel of your choice and the call channel (Ch 09) (tri-watch). See p. 16 for details.

Large, easy-to-read LCD

With the generous dimensions of 22.5(H) × 31.5(W) mm; 7/8(H) × 1 1/4(W) inch, the IC-M73/IC-M73EURO's function display is easy to read and shows operating conditions at a glance. Backlighting and contrast can be adjusted to suit your preferences.

Simple operation

The volume knob is on top of the radio, while the channel buttons are on the front panel. This allows for convenient, one-handed operation.

PRECAUTION

⚠ WARNING! NEVER connect the transceiver to an AC outlet. This may pose a fire hazard or result in an electric shock.

⚠ WARNING! NEVER hold the transceiver so that the antenna is closer than 2.5 cm (1 inch) from exposed parts of the body, especially the face or eyes, while transmitting. The transceiver will perform best if the microphone is 5 to 10 cm (2 to 4 inches) away from the lips and the transceiver is vertical.

NEVER connect the transceiver to a power source other than the BP-245N. Such a connection will ruin the transceiver.

AVOID using or placing the transceiver in direct sunlight or in areas with temperatures below -20°C (-4°F) or above $+60^{\circ}\text{C}$ ($+140^{\circ}\text{F}$).

KEEP the transceiver out of the reach of children.

KEEP the transceiver at least 0.9 meters (3.0 ft) away from your vessel's magnetic navigation compass.

MAKE SURE the flexible antenna and battery pack are securely attached to the transceiver, and that the antenna and battery pack are dry before attachment. Exposing the inside of the transceiver to water will result in serious damage to the transceiver.

BE CAREFUL! The IC-M73/IC-M73EURO employs submersible construction (1.5 m; 4.9 ft depth for 30 min.). However, once the transceiver has been dropped, waterproofing cannot be guaranteed due to the fact that the transceiver may be cracked, or the waterproof seal damaged, etc.

For the U.S.A. only

CAUTION: Changes or modifications to this device, not expressly approved by Icom Inc., could void your authority to operate this device under FCC regulations.

CLEAN THE TRANSCEIVER AND MICROPHONE THOROUGHLY WITH FRESH WATER after exposure to water including salt, otherwise, the keys and switch may become inoperable due to salt crystallization.

Icom, Icom Inc. and the Icom logo are registered trademarks of Icom Incorporated (Japan) in the United States, the United Kingdom, Germany, France, Spain, Russia and/or other countries.

RADIO OPERATOR WARNING



Icom requires the radio operator to meet the FCC Requirements for Radio Frequency Exposure. An omnidirectional antenna with gain not greater than 9 dBi must be mounted a minimum of 5 meters (measured from the lowest point of the antenna) vertically above the main deck and all possible personnel. This is the minimum safe separation distance estimated to meet all RF exposure compliance requirements. This 5 meter distance is based on the FCC Safe Maximum Permissible Exposure (MPE) distance of 3 meters added to the height of an adult (2 meters) and is appropriate for all vessels.

For watercraft without suitable structures, the antenna must be mounted so as to maintain a minimum of 1 meter vertically between the antenna, (measured from the lowest point of the antenna), to the heads of all persons AND all persons must stay outside of the 3 meter MPE radius.

Do not transmit with radio and antenna when persons are within the MPE radius of the antenna, unless such persons (such as driver or radio operator) are shielded from antenna field by a grounded metallic barrier. The MPE Radius is the minimum distance from the antenna axis that person should maintain in order to avoid RF exposure higher than the allowable MPE level set by FCC.

FAILURE TO OBSERVE THESE LIMITS MAY ALLOW THOSE WITHIN THE MPE RADIUS TO EXPERIENCE RF RADIATION ABSORPTION WHICH EXCEEDS THE FCC MAXIMUM PERMISSIBLE EXPOSURE (MPE) LIMIT. IT IS THE RESPONSIBILITY OF THE RADIO OPERATOR TO ENSURE THAT THE MAXIMUM PERMISSIBLE EXPOSURE LIMITS ARE OBSERVED AT ALL TIMES DURING RADIO TRANSMISSION. THE RADIO OPERATOR IS TO ENSURE THAT NO BYSTANDERS COME WITHIN THE RADIUS OF THE MAXIMUM PERMISSIBLE EXPOSURE LIMITS.

Determining MPE Radius

THE MAXIMUM PERMISSIBLE EXPOSURE (MPE) RADIUS HAS BEEN ESTIMATED TO BE A RADIUS OF ABOUT 3M PER OET BULLETIN 65 OF THE FCC. THIS ESTIMATE IS MADE ASSUMING THE MAXIMUM POWER OF THE RADIO AND ANTENNAS WITH A MAXIMUM GAIN OF 9dBi ARE USED FOR A SHIP MOUNTED SYSTEM.

AVERTISSEMENT POUR LES OPÉRATEURS RADIO



AVERTISSEMENT

Icom exige que l'opérateur radio se conforme aux exigences de la FCC en matière d'exposition aux radiofréquences. Une antenne omnidirectionnelle dont le gain ne dépasse pas 9dBi doit être fixée à une distance minimale de 5 mètres (mesurée depuis le point le plus bas de l'antenne) verticalement au-dessus du pont principal et de tout le personnel qui peut s'y trouver. Il s'agit de la distance de sécurité minimale prévue pour satisfaire aux exigences de conformité en matière d'exposition aux RF. Cette distance de 5 mètres est établie en fonction de l'exposition maximale admissible sécuritaire de 3 mètres établie par la FCC, à laquelle on ajoute la hauteur d'un adulte (2 mètres); cette distance convient pour tous les navires.

Dans le cas des embarcations sans structure convenable, l'antenne doit être fixée de façon à maintenir une distance minimale de 1 mètre verticalement entre cette antenne (mesurée depuis son point le plus bas) et la tête de toute personne présente; toutes les personnes présentes doivent se tenir à l'extérieur d'un rayon d'exposition maximale admissible de 3 mètres.

Ne pas émettre à l'aide de la radio et de l'antenne lorsque des personnes se trouvent à l'intérieur du rayon d'exposition maximale admissible de cette antenne, à moins que ces personnes (comme le conducteur ou l'opérateur radio) ne soient protégées du champ de l'antenne par un écran métallique relié à la masse. Le rayon d'exposition maximale admissible équivaut à la distance minimale que cette personne doit maintenir entre elle et l'axe de l'antenne pour éviter une exposition aux RF supérieure au niveau d'exposition maximale admissible fixé par la FCC.

LE NON-RESPECT DE CES LIMITES PEUT CAUSER, POUR LES PERSONNES SITUÉES DANS LE RAYON D'EXPOSITION MAXIMALE ADMISSIBLE, UNE ABSORPTION DE RAYONNEMENT DE RF SUPÉRIEURE À L'EXPOSITION MAXIMALE ADMISSIBLE FIXÉE PAR LA FCC.

L'OPÉRATEUR RADIO EST RESPONSABLE D'ASSURER QUE LES LIMITES D'EXPOSITION MAXIMALE ADMISSIBLE SOIENT RESPECTÉES EN TOUT TEMPS PENDANT LA TRANSMISSION RADIO. L'OPÉRATEUR RADIO DOIT S'ASSURER QU'AUCUNE PERSONNE PRÉSENTE NE SE SITUE À L'INTÉRIEUR DU RAYON D'EXPOSITION MAXIMALE ADMISSIBLE.

Établir le rayon d'exposition maximale admissible ON ESTIME QUE LE RAYON D'EXPOSITION MAXIMALE ADMISSIBLE EST D'ENVIRON 3 M, TEL QUE STIPULÉ DANS LE BULLETIN OET 65 DE LA FCC. CETTE DISTANCE ESTIMÉE TIEN COMPTE D'UN SYSTÈME INSTALLÉ SUR UN NAVIRE UTILISANT LA PUISSANCE MAXIMALE DE LA RADIO ET DES ANTENNES DONT LE GAIN MAXIMAL EST DE 9dBi.

FCC INFORMATION

FOR CLASS A UNINTENTIONAL RADIATORS

This equipment has been tested and found to comply with the limits for a Class A digital device, pursuant to part 15 of the FCC Rules. These limits are designed to provide reasonable protection against harmful interference when the equipment is operated in a commercial environment. This equipment generates, uses, and can radiate radio frequency energy and, if not installed and used in accordance with the instruction manual, may cause harmful interference to radio communications. Operation of this equipment in a residential area is likely to cause harmful interference in which case the user will be required to correct the interference at his own expense.

CAUTION: Changes or modifications to this device, not expressly approved by Icom Inc., could void your authority to operate this device under FCC regulations.

COUNTRY CODE LIST

• ISO 3166-1

	Country	Codes		Country	Codes
1	Austria	AT	18	Liechtenstein	LI
2	Belgium	BE	19	Lithuania	LT
3	Bulgaria	BG	20	Luxembourg	LU
4	Croatia	HR	21	Malta	MT
5	Czech Republic	CZ	22	Netherlands	NL
6	Cyprus	CY	23	Norway	NO
7	Denmark	DK	24	Poland	PL
8	Estonia	EE	25	Portugal	PT
9	Finland	FI	26	Romania	RO
10	France	FR	27	Slovakia	SK
11	Germany	DE	28	Slovenia	SI
12	Greece	GR	29	Spain	ES
13	Hungary	HU	30	Sweden	SE
14	Iceland	IS	31	Switzerland	CH
15	Ireland	IE	32	Turkey	TR
16	Italy	IT	33	United Kingdom	GB
17	Latvia	LV			

IN CASE OF EMERGENCY

If your vessel requires assistance, contact other vessels and the Coast Guard by sending a distress call on Channel 16.

○ **USING CHANNEL 16**

DISTRESS CALL PROCEDURE

1. "MAYDAY MAYDAY MAYDAY."
2. "THIS IS" (name of vessel)
3. Say your call sign or other indication of the vessel.
4. "LOCATED AT" (your position)
5. State the nature of the distress and assistance required.
6. Give any other information which might facilitate the rescue.

RECOMMENDATION

CLEAN THE TRANSCEIVER THOROUGHLY WITH FRESH WATER after exposure to saltwater, and dry it before operation. Otherwise, the transceiver's keys, switches and controllers may become inoperable due to salt crystallization.

NOTE: DO NOT wash the transceiver in water if there is any reason to suspect the waterproofing may not be effective. For example, in cases where the transceiver/battery pack is cracked or broken, or has been dropped, or when the battery pack is detached from the transceiver.



TABLE OF CONTENTS

FOREWORD	i		
IMPORTANT	i		
EXPLICIT DEFINITIONS	i		
FEATURES	i		
PRECAUTION	ii		
RADIO OPERATOR WARNING	iii		
AVERTISSEMENT POUR LES OPÉRATEURS RADIO.....	iv		
FCC INFORMATION	v		
COUNTRY CODE LIST	v		
IN CASE OF EMERGENCY	vi		
RECOMMENDATION	vi		
TABLE OF CONTENTS	vii		
1 OPERATING RULES.....	1		
2 SUPPLIED ACCESSORIES AND ATTACHMENTS.....	2		
■ Supplied accessories	2		
■ Attachments	2		
3 PANEL DESCRIPTION	4		
■ Front, top and side panels	4		
■ Function display	6		
4 BASIC OPERATION.....	8		
■ Channel selection.....	8		
■ Receiving and transmitting.....	11		
■ Call channel programming	12		
■ Lock function.....	12		
■ Monitor function.....	12		
■ Adjusting the squelch level.....	13		
■ AquaQuake water draining function	13		
5 SCAN OPERATION.....	14		
■ Scan types	14		
■ Setting Favorite channels.....	15		
■ Starting a scan	15		
6 DUALWATCH/TRI-WATCH.....	16		
■ Description	16		
■ Operation.....	16		
7 FUNCTION MODE OPERATION.....	17		
■ About the function mode	17		
■ Play back function	18		
■ Manual recording function	19		
■ Automatic recording function.....	20		
■ Backlighting function	21		
■ Channel naming function	21		
■ Opening comment entry function	22		
■ ATIS code programming.....	23		
8 SET MODE	25		
■ SET mode programming	25		
■ SET mode items.....	26		
9 Battery charging	31		
■ Battery cautions	31		
■ Supplied battery charger	33		
■ Optional battery chargers.....	34		
10 OPTIONAL SWIVEL BELT CLIP	35		
■ Attachment	35		
■ Detachment.....	35		
11 OPTIONAL SPEAKER-MICROPHONE	36		
■ HM-167 descriptions	36		
■ Attachment	36		
12 SPECIFICATIONS	38		
13 VHF MARINE CHANNEL LIST	40		
14 OPTIONS.....	43		

◇ Priorities

- Read all rules and regulations pertaining to call priorities, and keep an up-to-date copy handy. Safety and distress calls take priority over all others.
- You must monitor Channel 16 when you are not operating on another channel.
- False or fraudulent distress calls are prohibited under law.

◇ Privacy

- Information overheard, but not intended for you, cannot lawfully be used in any way.
- Indecent or profane language is prohibited.

◇ Radio licenses

(1) SHIP STATION LICENSE

You may require a current radio station license before using the transceiver. It is unlawful to operate a ship station which is not licensed, but required to be.

If required, contact your dealer or the appropriate government agency for a Ship-Radiotelephone license application. This government-issued license states the call sign which is your craft's identification for radio purposes.

(2) OPERATOR'S LICENSE

A Restricted Radiotelephone Operator Permit is the license most often held by small vessel radio operators when a radio is not required for safety purposes.

If required, the Restricted Radiotelephone Operator Permit must be posted or kept with the operator. If required, only a licensed radio operator may operate a transceiver.

However, non-licensed individuals may talk over a transceiver if a licensed operator starts, supervises, ends the call and makes the necessary log entries.

A current copy of the applicable government rules and regulations is only required to be on hand for vessels in which a radio telephone is compulsory. However, even if you are not required to have these on hand it is your responsibility to be thoroughly acquainted with all pertinent rules and regulations.

NOTE: Even though the transceiver is capable of operation on VHF marine channels 3, 21, 23, 61, 64, 81, 82 and 83, according to FCC regulations these simplex channels cannot be lawfully used by the general population in USA waters.

■ Supplied accessories

The following accessories are supplied:

	Qty.
① Handstrap	1
② Battery charger (with two screws)	1
③ Belt clip (with two screws).....	1
④ Li-Ion battery pack	1
⑤ AC adapter	1
⑥ Flexible antenna	1
⑦ Cigarette lighter cable	1

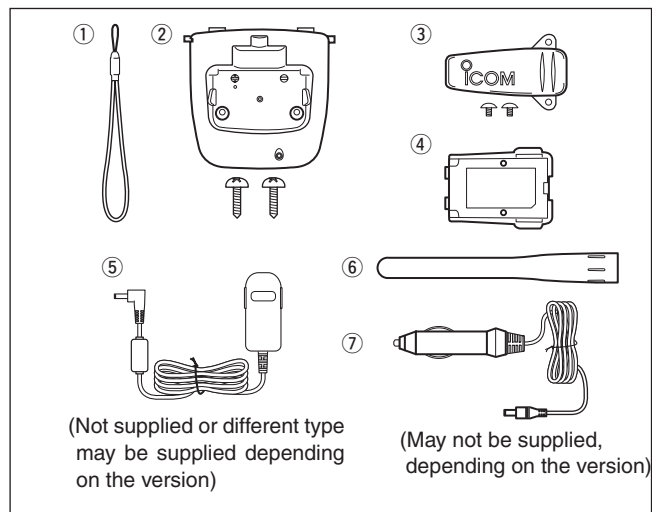

■ Attachments

◇ Flexible antenna

Connect the supplied flexible antenna to the antenna connector.

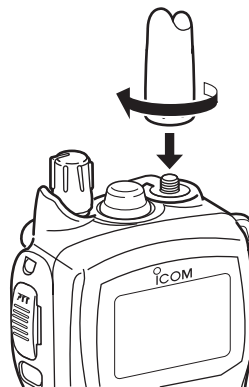

CAUTION: Transmitting without an antenna may damage the transceiver.

NEVER HOLD by the antenna when carrying the transceiver.

◇ Handstrap

Pass the handstrap through the loop on the top corner of the transceiver as illustrated at left. Facilitates carrying.

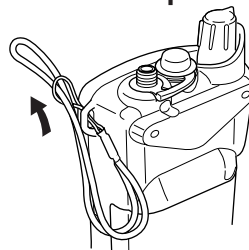

◇ Battery pack

- ① Attach the battery pack into the transceiver as below.

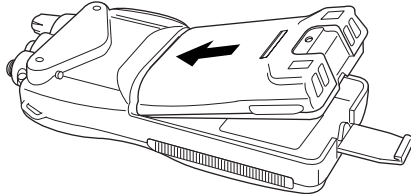

- ② Lock the battery pack with the latch.

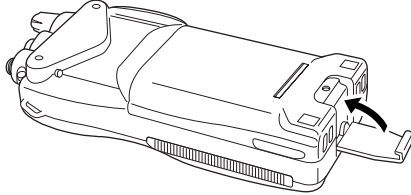

CAUTION:
NEVER attach or detach the battery pack when wet.

Be careful when releasing the latch. Because the latch is tightly locked, don't use a finger nail to open it— you may injure yourself. Instead, use something relatively flat, like the edge of a coin or the tip of a screwdriver, to carefully release the latch.

◇ Belt clip

Attach the belt clip to the transceiver as illustrated below.

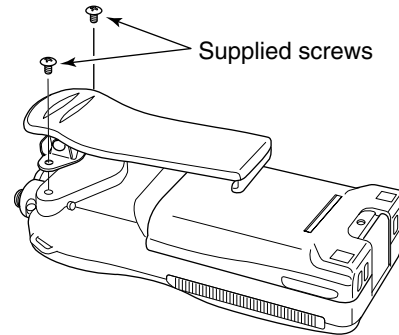

■ Front, top and side panels

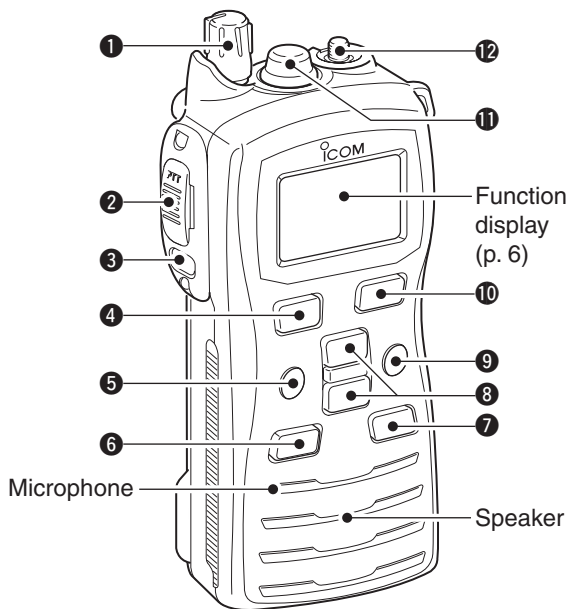

① VOLUME CONTROL [VOL]

Turns power ON and adjusts the audio level.

② PTT SWITCH [PTT]

Hold down to transmit; release to receive.

③ MONITOR KEY [MON]

- Manually opens the squelch for monitoring the channel while held down. (p. 10)
- Push this switch, then adjust the squelch level with [▲]/[▼]. (p. 11)
- While holding down this switch, turn power ON to enter the SET mode. (p. 17)

④ CHANNEL 16 KEY [16/C]

- Selects Channel 16 when pushed. (p. 7)
- Selects call channel when pushed for 1 second. (p. 7)
- Enters call channel write mode when the call channel is selected and this key is held down for 3 seconds. (p. 10)

⑤ FUNCTION KEY [F]

- Enter the function mode. (p. 7)
- The AquaQuake function is activated after hold down for 1 second. (p. 7)

⑥ SCAN KEY [SCAN•DUAL]

- Starts and stops normal or priority scan when pushed. (pp. 14, 15)
- Enters watch mode when held down for 1 second. (p. 16)

7 CHANNEL/WEATHER CHANNEL KEY
[CH/WX•U/I/C] (IC-M73), [CH] (IC-73EURO)

- Selects and toggles the regular channels and weather channel* when pushed. (p. 8)
- Selects the U.S.A., International, or Canadian* channel group when held down for 1 second. (p. 8)
 - The function display shows which channel group is active.
- Push to return to the condition before selecting the channel when the priority channel or the call channel is selected.

*Available with the U.S.A. and EXP versions only.

 **NOTE:** [CH/WX•U/I/C] and [CH] write as [CH/WX•U/I/C] in this instruction manual.

8 CHANNEL UP/DOWN KEYS [▲]/[▼]

- Selects an operating channel. (pp. 7–9)
- Selects the SET mode condition of the item. (p. 17)
- Selects the SET mode item when pushed with [(⏏)]. (p. 17)
- Checks Favorite (TAG) channels or changes scanning direction during scan. (p. 15)

9 TRANSMIT POWER/LOCK KEY [H/L•LOCK]

- Selects high, middle or low power when pushed. (p. 9)
- Toggles the lock function ON/OFF when held down for 1 second. (p. 10)

10 FAVORITE (TAG) KEY [FAV•★]

- Push this key to sequentially select the Favorite (TAG) channels, while ignoring untagged channels, in a channel group. (p. 8)
- Hold down for 1 second to set or clear Favorite (TAG) for the displayed channel. (p. 8)
- While holding down this key, turn power ON to clear or set all Favorite (TAG) channels in the selected channel group. (p. 8)

11 SPEAKER-MICROPHONE CONNECTOR [SP MIC]

Connects the optional external speaker-microphone or headset.

 **NOTE:** Attach the [SP MIC] cap when the optional speaker-microphone or headset is not used.

12 ANTENNA CONNECTOR

Connects the supplied antenna.

3 PANEL DESCRIPTION

■ Function display

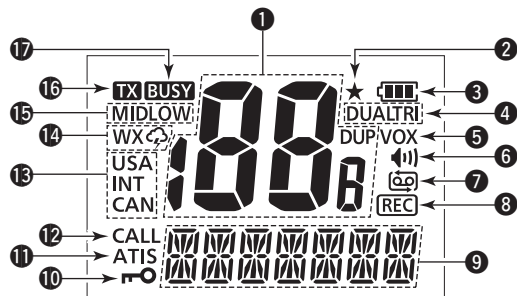

1 CHANNEL NUMBER READOUT





- Indicates the selected operating channel number.
- In SET mode, indicates the selected condition.
- “DUP” appears when a duplex channel is selected.

2 FAVORITE CHANNEL INDICATOR (p. 15)

Appears when favorite channel is selected.

3 BATTERY INDICATOR

Indicates remaining battery power.

Indication				
Battery level	Full	Middle	Charging required	No battery

 blinks when the battery is overcharged (or over voltage).

4 DUALWATCH/TRI-WATCH INDICATORS (p. 16)

“DUAL” blinks during dualwatch; “TRI” blinks during tri-watch.

5 VOX INDICATOR (p. 12)

Appears when the VOX function using is available.
Ask your dealer for details.

6 MONITOR INDICATOR (p. 10)

Appears when the monitor function is activated.

7 AUTOMATIC RECORDING INDICATOR (pp. 11, 22)

Appears when the automatic recording is activated.

8 RECORDING INDICATOR

Appears while the receiving audio is recording.

9 CHANNEL NAMING

- Indicates or scrolls operating channel name or comment. (p. 13)
- In SET mode, indicates or scrolls the selected item. (pp. 17–22)

10 LOCK INDICATOR (p. 10)

Appears when the lock function is activated.

11 ATIS INDICATOR (p. 10)

Appears when the channel group, which ATIS function is activated, is selected.

- Available with the German and Holland versions only.

12 CALL CHANNEL INDICATOR (p. 7)

Appears when the call channel is selected.

13 CHANNEL GROUP INDICATOR (p. 8)

“USA” appears when U.S.A.; “INT” appears when International; “CAN*” appears when Canadian channel group is selected.

*Available with the U.S.A. and EXP versions only

14 WEATHER CHANNEL/WEATHER ALERT INDICATORS
(p. 8)

- “WX” appears when the weather channel group is selected.
- “WX” appears when the weather alert function is activated.

15 TRANSMIT POWER INDICATORS (p. 9)

- “LOW” appears when low power is selected.
- “MID” appears when middle power is selected.
- No indication appears when high power is selected.

16 TRANSMIT INDICATOR (p. 9)

Appears during transmit.

17 BUSY INDICATOR (pp. 9, 10)

Appears when a signal is received or squelch is open.

■ Channel selection

IMPORTANT! Prior to using the transceiver for the first time, fully charge the battery pack. This will help maximize the capability and life of the battery. To avoid damage to the transceiver, turn the radio OFF while charging.

◇ Channel 16

Channel 16 (Distress channel) is used for establishing initial contact with another station and for emergency communications. Channel 16 is automatically monitored during both dualwatch and tri-watch. While standing by, you must monitor Channel 16.

- ① Push **[16•9]** to select Channel 16.
- ② Push **[CH/WX•U/I/C]** to return to the condition before selecting Channel 16, or push **[▲]/[▼]** to select the operating channel.

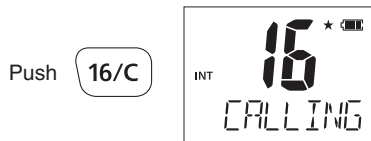

◇ Channel 9 (Call channel)

Channel 9 is the leisure-use call channel. Each regular channel group has separate call channels. In addition, the call channel is monitored during tri-watch. The call channels can be re-programmed (p. 10) and may be used to store your most often used channels in each channel group for quick recall.

- ① Hold down **[16•9]** for 1 second to select the call channel.
 - “CALL” and the call channel number appear.
 - Call channel can be re-programmed. See the “Call channel programming” on p. 10 for details.
- ② Push **[CH/WX•U/I/C]** to return to the condition before selecting Channel 9 (call channel), or push **[▲]/[▼]** to select the operating channel.



◇ **U.S.A., International, Canadian and ATIS channels**

The IC-M73/IC-M73EURO have U.S.A.*¹, International, Canadian*² and ATIS*³ channels. You must select the proper channels for the operating area.

- *¹U.S.A., EXP, China and U.K. versions only
- *²U.S.A and EXP versions only.
- *³German and Holland versions only.

- ① Push [CH/WX•U//C] to select the regular channel.
 - If the weather channel appears, push [CH/WX•U//C] again.
- ② Push [▲]/[▼] to select a channel.
 - “DUP” appears for duplex channels.
- ③ To change the channel group, hold down [CH/WX•U//C] for 1 second.
 - Repeat until you reach the desired channel group.

For U.K. version

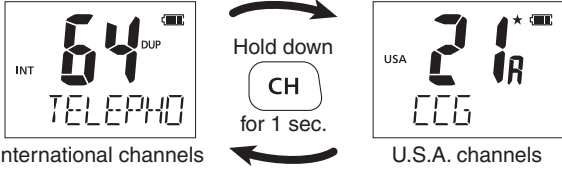

For German and Holland versions

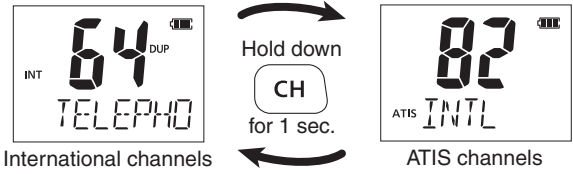

For U.S.A. and China versions

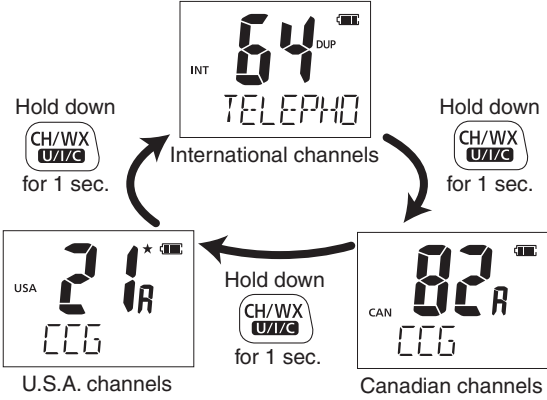

4 BASIC OPERATION

◇ Weather channels

The IC-M73 has 10 weather channels. They are used for monitoring NOAA (National Oceanographic and Atmospheric Administration) broadcasts (reception of weather channels possible in U.S.A. only).

- ① Push [**CH/WX•U//C**] to select the weather channel group.
- ② Push [**▲**]/[**▼**] to select a weather channel.
- ③ Push [**CH/WX•U//C**] to return to the condition before selecting the weather channel group.

✓ **CONVENIENT!**

The IC-M73 can detect a weather alert tone on the selected weather channel while in another channel (when the power save function is turned ON) or during scanning. See the “SET mode items” on p. 18 for details.

■ Receiving and transmitting

CAUTION: Transmitting without an antenna may damage the transceiver.

- ① Rotate **[VOL]** clockwise to turn power ON.
 - Opening comment scrolls across the function display. (p. 13)
 - Push **[16/•]** to skip the opening comment indication.
- ② Set the volume and squelch level.
 - ➔ Push **[M/•]**, and push **[▼]** to open the squelch.
 - ➔ Rotate **[VOL]** to set the volume level.
 - ➔ Push **[M/•]**, and push **[▲]/[▼]** to set the squelch level.
- ③ Push **[▲]/[▼]** to select the desired channel.
 - When receiving a signal, "**BUSY**" indicator appears while audio is emitted from the speaker.
 - Further adjustment of **[VOL]** may be necessary at this point.
- ④ Push **[H/L•LOCK]** to select the output power, if necessary.
 - "LOW" appears when low power is selected; "MID" appears when middle power is selected; no indication when high power is selected.
 - Choose low or mid. power to conserve battery power, choose high power for longer distance communications.
 - Some channels are for low power only.
- ⑤ Hold down **[PTT]** to transmit, and speak into the microphone.
 - The transmit indicator appears while transmitting.
 - Channel 70 cannot be used for transmission.
- ⑥ Release **[PTT]** to receive.

IMPORTANT: To maximize the readability of your transmitted signal, pause a second after pushing **[PTT]**, hold the microphone 5 to 10 cm (2 to 4 inches) from your mouth, and speak into the microphone using a normal voice level.

NOTE: The transceiver has a power save function to conserve the battery power. The power save function activates automatically when no signal is received for 5 seconds.

To prevent accidental prolonged transmission, etc., the IC-M73 has a time-out timer function. This timer cuts a transmission OFF after 5 min. of continuous transmission.

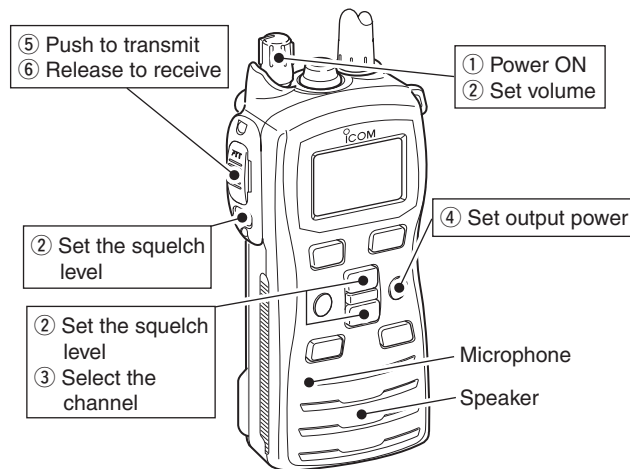

4 BASIC OPERATION

■ Call channel programming

The call channel key is used to select Channel 9 by default, however, you can program your most often-used channel in each channel group for quick recall.

- ① Hold down **[CH/WX•U//C]** for 1 second several times to select the desired channel group (USA, INT, CAN) to be programmed.
- ② Hold down **[16•9]** for 1 second to select the call channel.
 - “CALL” and call channel number appear.
- ③ Hold down **[16•9]** again for 3 seconds (until a long beep changes to 2 short beeps) to enter call channel programming condition.
 - Call channel number to be programmed blinks.
- ④ Push **[▲]/[▼]** to select the desired channel.
- ⑤ Push **[16•9]** to program the displayed channel as the call channel.
 - The call channel number stops blinking.

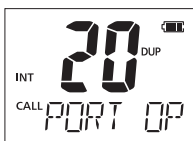
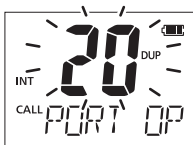
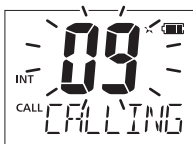
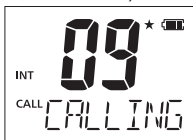

■ Lock function

This function electronically locks all keys (except for **[PTT]**, **[MON]** and **[H/L•LOCK]**) to prevent accidental channel changes and function access.

- ➔ Push **[H/L•LOCK]** for 1 second to turn the lock function ON or OFF.

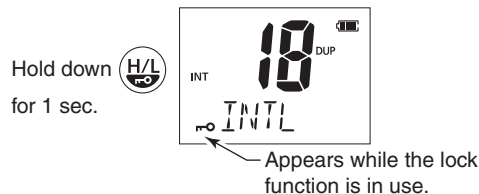

■ Monitor function

The monitor function releases the noise squelch mute to check the volume level. See p. 19 for details of the monitor switch action.

- ➔ Hold down **[MON]** for 1 second to activate the monitor function.
 - “**[MON]**” and “**[BUSY]**” appear and audio is emitted.

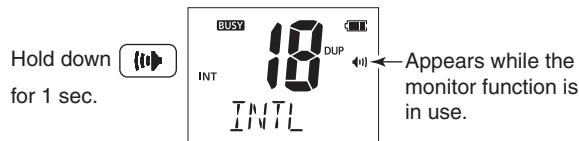

■ Adjusting the squelch level

To adjust the IC-M73/IC-M73EURO's squelch level, use the [▲]/[▼] keys as desired below. In order to receive signals properly, as well as for the scan to function effectively, the squelch must be adjusted to the proper level.

- ① Push [(M)], then adjust the squelch level with [▲]/[▼].
 - "SQL" and the squelch level are displayed.
 - There are 11 squelch levels to choose from: OP is completely open; 10 is tight squelch; 1 is loose squelch level.
 - When no key is pushed for 5 seconds, the transceiver returns to normal condition.
- ② Push [(M)] again to return to normal operating mode.

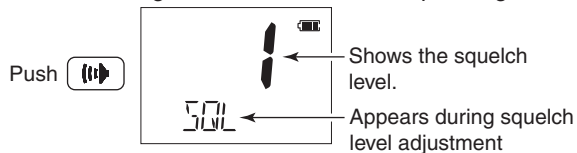

■ AquaQuake water draining function

The IC-M73/IC-M73EURO uses a new technology to clear water away from the speaker grill: AquaQuake. AquaQuake helps drain water away from the speaker housing (water that might otherwise muffle the sound coming from the speaker). The IC-M73/IC-M73EURO emits a vibrating noise when this function is being used.

- Hold down [F].
 - A low beep tone sounds for 9 seconds to drain water, regardless of [VOL] control setting.
 - The transceiver never accepts a key operation while the Aqua-Quake function is activated. And this function won't be activated when an optional speaker-microphone or headset is connected.

■ Scan types

Scanning is an efficient way to quickly locate signals over a wide frequency range. The transceiver has a priority scan setting and normal scan setting.

In addition, the “Weather alert” and “Auto scan” functions are also available for scanning. These functions can be activated simultaneously, depending on the settings on the SET mode. (pp. 18, 19)

PRIORITY SCAN

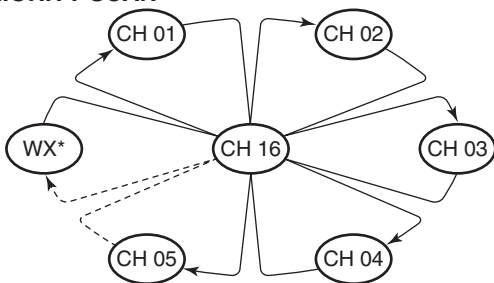

* Previously selected weather channel when weather alert function is ON

Priority scan searches through all Favorite channels in sequence while monitoring Channel 16. When a signal is detected on Channel 16, scan pauses until the signal disappears; when a signal is detected on a channel other than Channel 16, scan becomes dualwatch until the signal disappears.

Set the Favorite channels (scanned channel) before scanning. Clear those Favorite channels which are not needed or inconveniently stop scanning, such as digital communications.

/// Choose priority or normal scan on the SET mode. (p. 18)

NORMAL SCAN

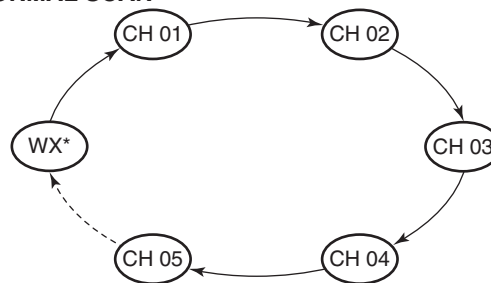

* Previously selected weather channel when weather alert function is ON.

Normal scan, like priority scan, searches through all Favorite channels in sequence. However, unlike priority scan, Channel 16 is not checked unless Channel 16 is set as a Favorite channel.

■ Setting Favorite channels

For more efficient scanning, add desired channels as Favorite channels or clear the Favorite for unwanted channels. Untagged will be skipped during scanning. Favorite channels can be assigned to each channel group (USA, INT, CAN) independently.

- ① Select the desired channel to set as a Favorite channel.
- ② Hold down **[FAV•★]** for 1 second to set the displayed channel as a Favorite channel.
 - “★” appears in the function display.
- ③ To cancel the Favorite channel setting, hold down **[FAV•★]** for 1 second.
 - “★” disappears.

✓ Clearing All Favorite Channels in the Selected Channel Group

While holding down **[FAV•★]**, turn power ON to clear all Favorite channels setting in the channel group.

■ Starting a scan

Set the weather alert function, priority scan function, scan resume timer and auto scan function in advance, using the SET mode. (pp. 18, 19)

- ① Make sure the desired channel group (e.g., USA, CAN, INT) is selected. Move between channel groups by repeatedly pushing **[CH/WX•U//C]** for 1 second at a time.
 - When the weather alert function is in use, select the desired weather channel with **[CH/WX•U//C]** and **[▲]/[▼]**.
- ② Push **[SCAN•DUAL]** to start priority or normal scan.
 - “SCAN” blinks in the function display.
 - “16” appears on the comment indicator during priority scan.
 - When a signal is received, scan pauses until the signal disappears or resumes after pausing 5 seconds according to scan resume timer setting. (Channel 16 is still monitored during priority scan.)
 - Push **[▲]/[▼]** to check the scanning Favorite channels, change the scanning direction or resume the scan manually.
- ③ To stop the scan, push **[SCAN•DUAL]**.
 - “SCAN” disappears.
 - Pushing **[PTT]**, **[16•9]** or **[CH/WX•U//C]** also stops the scan.

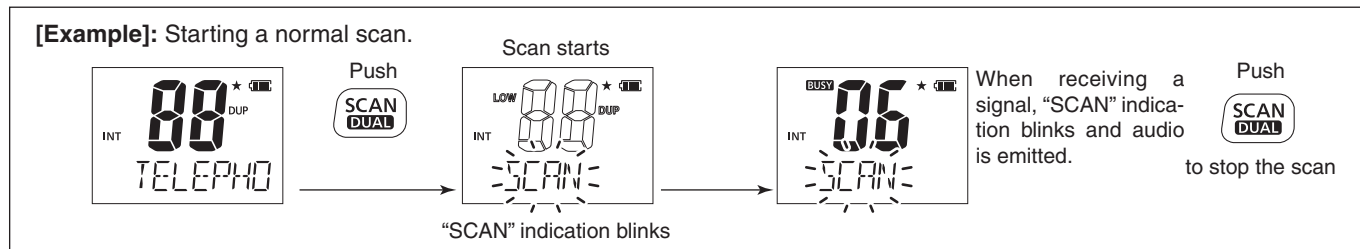

■ Description

Dualwatch monitors Channel 16 while you are receiving another channel; tri-watch monitors Channel 16 and the call channel while receiving another channel.

DUALWATCH/TRI-WATCH SIMULATION

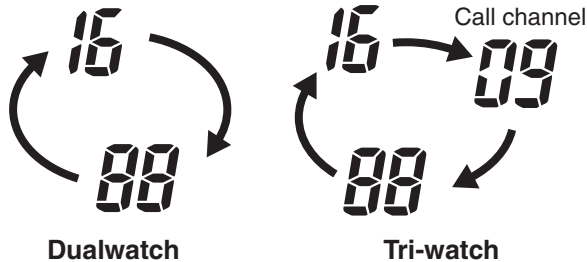

- If a signal is received on Channel 16, dualwatch/tri-watch pauses on Channel 16 until the signal disappears.
- If a signal is received on the call channel during tri-watch, tri-watch becomes dualwatch until the signal disappears.
- To transmit on the selected channel during dualwatch/tri-watch, hold down [PTT].

■ Operation

- ① Select the desired operating channel.
- ② Hold down [SCAN•DUAL] for 1 second to start dualwatch or tri-watch (depending on the SET mode setting; p. 19).
 - “DUAL” blinks during dualwatch; “TRI” blinks during tri-watch.
 - A beep tone sounds when a signal is received on Channel 16.
 - Tri-watch becomes dualwatch when receiving a signal on the call channel.
- ③ To cancel dualwatch/tri-watch, push [SCAN•DUAL] again.

[Example]: Operating tri-watch on INT channel 07.

Hold down  for 1 sec.

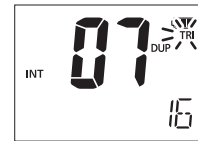

Tri-watch starts.

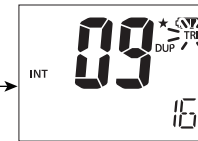

Signal is received on the call channel.

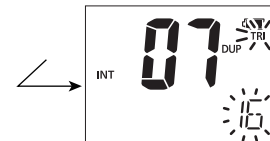

A signal receive on Channel 16 always takes priority.

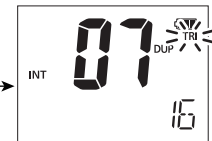

Tri-watch resumes after the signal disappears.

■ About the function mode

There are 7 transceiver functions in the function mode: Play back function, Manual recording function, Automatic recording function, backlight function, channel naming function, opening comment entry function and ATIS code programming function†.

†Depending on versions.

◇ Entering the function mode

- ① Turn power ON.
- ② Push **[F]** to enter the function mode.
 - “PLAY” (Play back function) appears.
- ③ Push **[▲]/[▼]** to select the desired item.
- ④ Push **[H/L•KEY]** to select or decide the desired condition of the item.
 - Some items exit the function mode when push **[H/L•KEY]**.
- ⑤ To exit the function mode, push **[F]**.

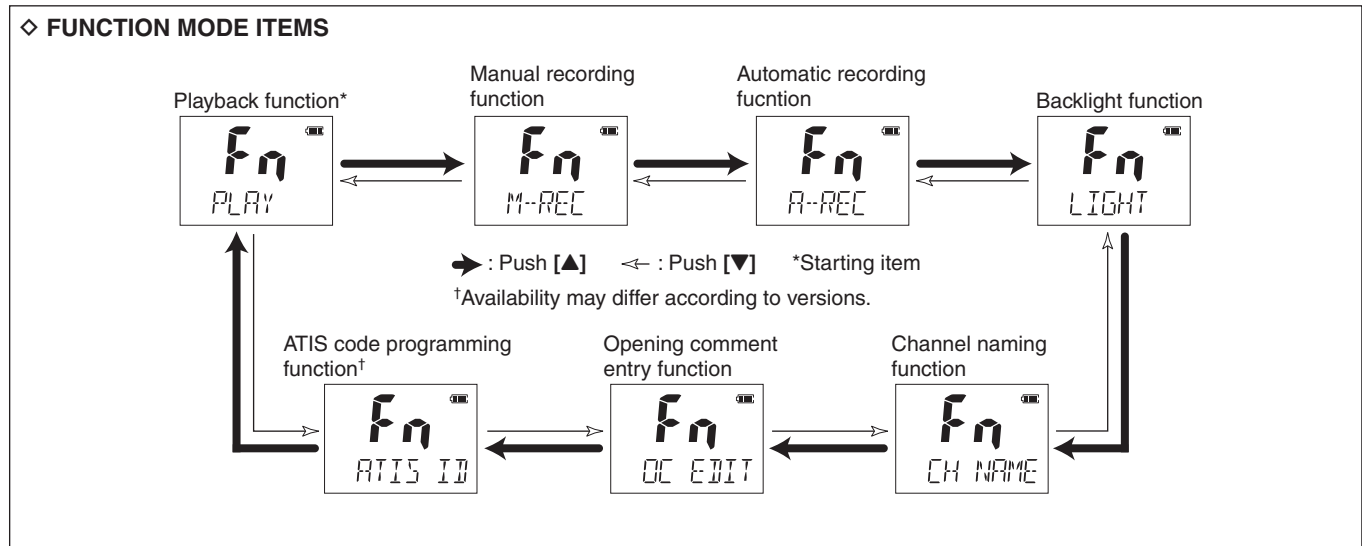

■ Play back function

This transceiver has the two voice recorders. One is the manual recording function which can record for 30 seconds, the other is the automatic recording function which can record the end of 60 seconds of the receiving signal.

There are three playing back mode as follow.

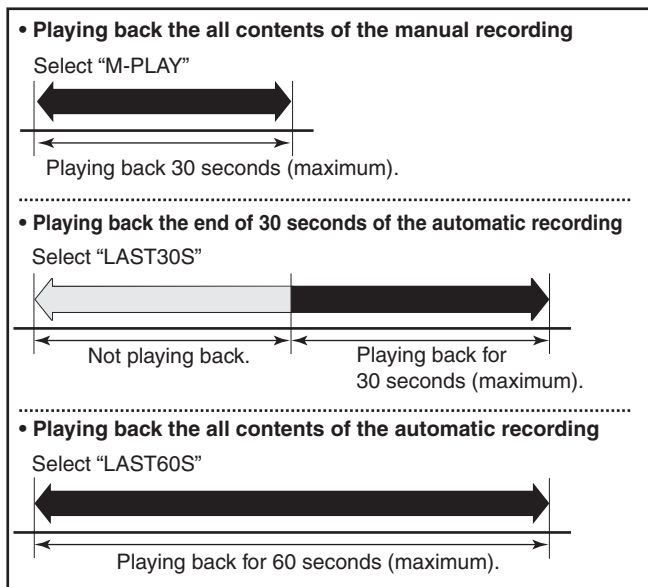

- ① Push **[F]** to enter the function mode.
 - "PLAY" appears.
- ② Push **[H/L•KEY]** to enter the play back selection mode, and then push **[▲]/[▼]** to select the desired play back mode from "M-PLAY," "LAST30S," or "LAST60S."
 If there is no recorded signal in the transceiver, "BLANK" is appeared.
 - M-PLAY : Play back the manual recorded signal.
 - LAST30S : Play back the automatic recorded signal from last 30 seconds.
 - LAST60S : Play back the automatic recorded signal.
- ③ Push **[H/L•KEY]** to play back the recorded signal.
 - "PL" blinks.
 - To stop the play backing, push **[H/L•KEY]** again.

Blinks while playbacking.



Playback mode appears.



"BLANK" is appeared when the transceiver has no recorded signal.

Manual recording function

You can record the received signal whenever you want by using the manual recording function. This function can record the receiving signal for 30 seconds.

• Example— Manual recording
[Less than 30 seconds]

Turn the manual recording ON. Turn the manual recording OFF.

When receiving signal within 30 seconds, this function records the all contents.

[More than 30 seconds]

Turn the manual recording ON. Stops recording automatically.

These contents won't be recorded.

After passing 30 seconds from starting the manual recording, the recording will be automatically stopped.

- ① Push **[F]** to enter the function mode, and then push **[▲]/[▼]** to select the manual recording function.
 - “M-REC” appears.
- ② Push **[H/L•KEY]** to start to record the receiving signal.
 - “REC” appears.
 - The recording will automatically stop after 30 seconds.
- ③ The recording will automatically stop after 30 seconds.
 - Push **[F]** to stop the recording.



Manual recording mode appears.



“REC” is appeared while recording.

■ Automatic recording function

When this function turns ON, the transceiver automatically records the receiving signal into the memory.

A maximum recording length of 60 seconds can be recorded into the memory.

- The transmitting signal cannot be recorded into the memory.
- The recording threshold level can be set in the set mode. See p. 30 for details.

• Example— Automatic recording

[Less than 60 seconds]

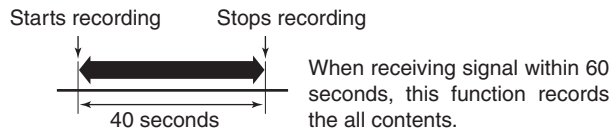

[More than 60 seconds]

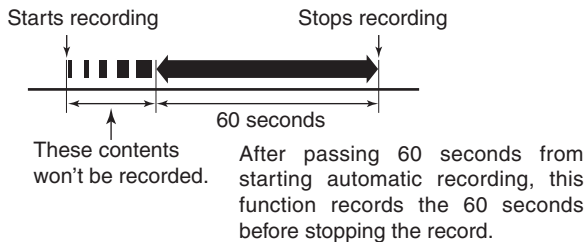

- ① Push **[F]** to enter the function mode, and then push **[▲]/[▼]** to select the automatic recording function.

- “A-REC” appears.

- ② Push **[H/L•KEY]** to turn the function ON or OFF.

- The automatic recording icon is appeared.

- The function mode will be automatically cancelled after pushing **[H/L•KEY]**.

- ③ When the transceiver receives a signal, it will **automatically** record the receiving signal into the memory.

- “REC” appears while recording.

- The recording will automatically stop when the receiving signal disappears.



Automatic recording mode appears.

Automatic recording icon is appeared.



“REC” is appeared while recording.

■ Backlighting function

This function is convenient for nighttime operation. The backlighting can be turned OFF in the SET mode. (p. 19)

- ➔ Push any key other than [PTT] to turn the backlighting ON.
 - The backlighting is automatically turned OFF after 5 seconds of inactivity.

- ① Push [F] to enter the function mode, and then push [▲]/[▼] to select the backlighting function.
 - “LIGHT” appears.
- ② Push [H/L•KEY] to turn the function ON or OFF.
 - The function mode will be automatically cancelled after pushing [H/L•KEY].
- ③ Push any key other than [PTT] to turn the backlighting ON.
 - The backlighting is automatically turned OFF after 5 seconds of inactivity.

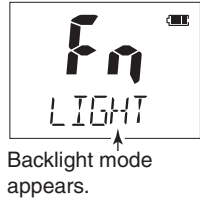

■ Channel naming function

The IC-M73/IC-M73EURO has a capability to assign up to 10-character channel names for each operating channel, including each weather channel. This provides easy recognition of channel usage, or station names, etc.

When shipped from the factory, the IC-M73/IC-M73EURO is programmed with default names for each VHF marine channel. These defaults can be changed, if desired.

◇ Available characters

-- (=)	※ (*)	+ (+)	-- (-)	, (.)	' (/)	0 (0)	1 (1)	2 (2)	3 (3)
4 (4)	5 (5)	6 (6)	7 (7)	8 (8)	9 (9)	(Space)	A (A)	B (B)	C (C)
D (D)	E (E)	F (F)	G (G)	H (H)	I (I)	J (J)	K (K)	L (L)	M (M)
N (N)	O (O)	P (P)	Q (Q)	R (R)	S (S)	T (T)	U (U)	V (V)	W (W)
X (X)	Y (Y)	Z (Z)	a (a)	b (b)	c (c)	d (d)	e (e)	f (f)	g (g)
h (h)	i (i)	j (j)	k (k)	l (l)	m (m)	n (n)	o (o)	p (p)	q (q)
r (r)	s (s)	t (t)	u (u)	v (v)	w (w)	x (x)	y (y)	z (z)	

◇ Channel name programming

- ① Push **[▲]/[▼]** to select a channel to program.
 - Hold down **[CH/WX•U/I/C]** for 1 second to select a channel group, if necessary.
- ② Push **[F]** to enter the function mode, and then push **[▲]/[▼]** to select the channel naming function.
 - “CH NAME” appears.
- ③ Push **[H/L•KEY]** to edit the channel name.
 - The 1st character of the currently programmed name blinks.
- ④ Push **[▲]/[▼]** to select a character.
- ⑤ Push **[CH/WX•U/I/C]** to move to the right; then push **[▲]/[▼]** to select a character.
 - Pushing **[SCAN•DUAL]**, moves to left
- ⑥ Continue until the desired characters have been selected, then push **[H/L•KEY]** to return to normal operation.

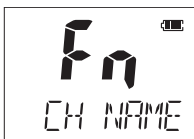

■ Opening comment entry function

The IC-M73/IC-M73EURO has a capability to assign up to 10-character opening comments.

You may replace the factory-set opening comment with a comment of your own. The opening comment appears each time the IC-M73/IC-M73EURO is powered ON. The comment may be up to 16 characters long.

You can use same characters as “Channel naming function.” (p. 22)

◇ Opening comment programming

- ① Push **[F]** to enter the function mode, and then push **[▲]/[▼]** to select the channel naming function.
 - “OC EDIT” appears.
- ② Push **[H/L•KEY]** to edit the opening comment.
 - The 1st character of the currently programmed comment blinks.



- ③ Push [**▲**]/[**▼**] to select a character.
- ④ Push [**CH/WX**•**U/I/C**] to move to the right; then push [**▲**]/[**▼**] to select a character.
 - Pushing [**SCAN**•**DUAL**], moves to left
- ⑤ Continue until the desired characters have been selected, then push [**H/L**•**KEY**] to return to normal operation.

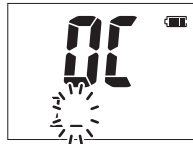
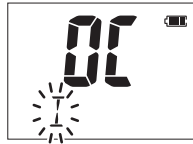

- ▨ The programmed opening comment is briefly displayed or scrolled when the transceiver is powered ON.
- ▨ However, the opening comment indication can be skipped by pushing [**16**•**9**].

■ ATIS code programming

The 10-digit ATIS code can be programmed and confirmed with the following operation.

- ▨ The ATIS code programming is not necessary and confirmation can only be performed when the ATIS code has been programmed by your dealer. The code programming can be performed 1 time only, when the code has not been programmed by your dealer.

◇ Opening comment programming

- ① Push [**F**] to enter the function mode, and then push [**▲**]/[**▼**] to select the ATIS code programming function.
 - “ATIS ID” appears.
- ② Push [**H/L**•**KEY**] to edit the ATIS code.
 - “Id” and “ATIS” appear, and the 1st character of the code blinks.

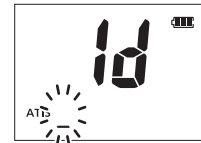

7 FUNCTION MODE OPERATION

- ③ Push [▲]/[▼] to select a character.
- ④ Push [CH/WX•U/I/C] to move to the right; then push [▲]/[▼] to select a character.
 - Pushing [SCAN•DUAL], moves to left
- ⑤ After inputting the 10-digit ATIS code, push [H/L•KEY] to write the code into the memory, then return to normal operation.

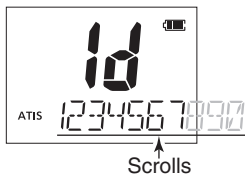
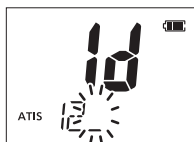

◇ ATIS code confirmation (When the ATIS code has been programmed)

- ① Push [F] to enter the function mode, and then push [▲]/[▼] to select the ATIS code programming function.
 - “ATIS ID” appears.
- ② Push [H/L•KEY] to confirm the ATIS code.
 - “10” and “ATIS” appear.
 - The ATIS code is displayed and scrolls at the channel comment indicator.
- ③ Push [H/L•KEY] to return to normal operation.



■ SET mode items

◇ Beep tone function “BEEP”

Selects the key touch beep sound ON or AJ, or turns sound OFF.

- ON : A fixed beep sounds (default)
- AJ : The preset beeps (e.g. do, re, mi) sound
- OFF : Silent operation

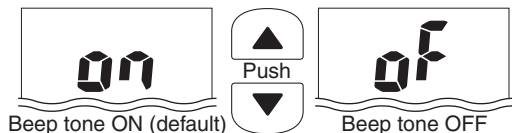

◇ Weather alert function “WX ALERT”

A NOAA broadcast station transmits a weather alert tone before any important weather announcements. When the weather alert function is turned ON, any detected weather alert will make the IC-M73 activate a blinking “WXALT” alert indicator on the function display and repeatedly sound a beep tone. The blinking and beeping stops when the radio is picked up and operated. The previously selected weather channel is checked any time during standby, or while scanning, when the power save function is activated.

- “ALT” appears when the function is set ON.

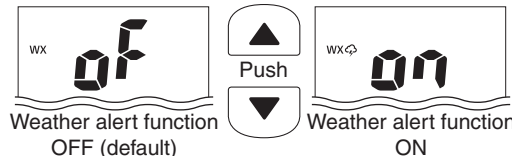

◇ Priority scan function “PRIO SCAN”

The transceiver has 2 scan types— normal (OFF) and priority (ON) scans. Normal scan searches all TAG channels in the selected channel group. Priority scan searches all TAG channels in sequence while monitoring Channel 16.

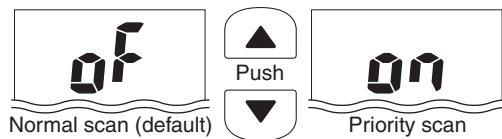

◇ Scan resume timer “SCAN TIMER”

The scan resume timer can be set as a pause (OFF) or timer scan (ON). When OFF is selected, the scan pauses until a received signal disappears. When ON is selected, the scan pauses for 5 seconds after receiving a signal and then resumes even if the signal has been received.

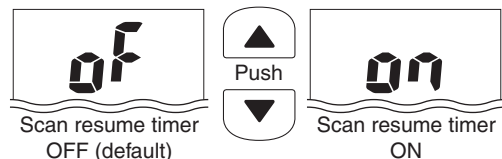

◇ **Auto scan function** “AUTO SCAN”

The auto scan function starts the desired scan automatically when no signal is received, and no operation is performed for 30 seconds

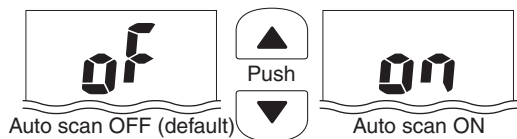

◇ **Dual/Tri-watch function** “DUAL”

This item selects dual or tri-watch as desired. See p. 16 for details.

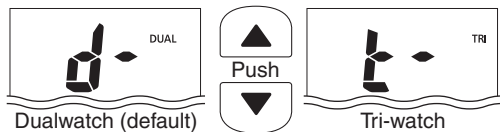

◇ **Monitor key action** “MONITOR”

The monitor key action cuts off the squelch function temporarily. This key action contains PUSH (Pu) or HOLD (Ho) settings as shown below.

- Pu (PUSH): After pushing [(P)] for 1 second, the squelch opens and emits audio. The squelch is held open while continuously holding down [(P)]. (default)
- Ho (HOLD): After pushing [(H)] for 1 second, the squelch opens and emits audio even [(H)] is released. To close the squelch, push any key.

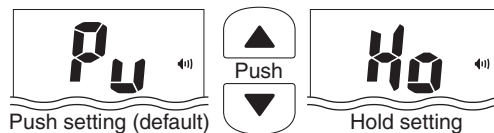

◇ **Backlight function** “BACKLIGHT”

This function is convenient for nighttime operation. The backlight can be selected from ON and OFF.

- The backlight is automatically activated when any key except for [PTT] is pushed.
- The backlight is automatically turned OFF after 5 seconds of inactivity.

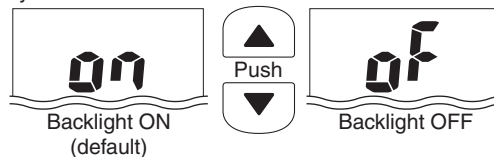

8 SET MODE

◇ LCD contrast selection

“CONTRAST”

The contrast of the LCD can be selected from Hi (default) and Lo.

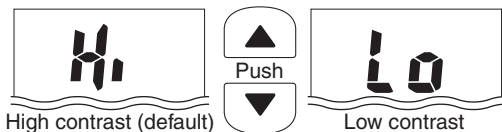

◇ Auto power save function

“POWER SAVE”

The auto power save function reduces current drain by deactivating the receiver circuit for preset intervals.

- ON : The power save function is turned ON. The power save function will activate when no signal is received, and no operation is performed for 5 seconds
- OFF : The power save function is turned OFF.

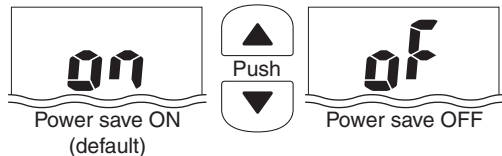

◇ Channel name scroll type

“SCR TYPE”

Selects the channel name/comment scroll type from 1 and 2.

- 1: The first 7 characters are displayed for 1 second (approx.) then scrolls. When the channel name/comment is 7 character or less, it does not scroll (default).
- 2: The channel name/comment scrolls regardless of the number of characters after no name/comment (blank) is indicated for 1 second.

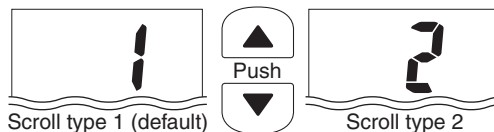

◇ Scrolling speed

“SCR SPEED”

Selects the channel name/comment scroll speed.

- 1: Scrolls 3.33 characters in a second.
- 2: Scrolls 2.5 characters in a second.
- 3: Scrolls 2 characters in a second.

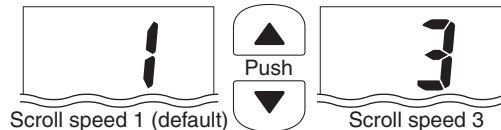

◇ RX Noise Cancel function

“RX ANC”

Set the Noise Cancel function for receive.

OFF : Turns OFF the function.

- 1 : The Noise Cancel function reduces random noise components in the received signal to approximately one half.
- 2 : The Noise Cancel function reduces random noise components in the received signal to approximately one third.
- 3 : The Noise Cancel function reduces random noise components in the received signal to approximately one tenth.

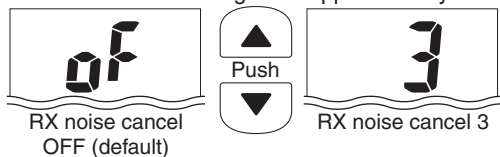

◇ TX Noise Cancel function

“TX ANC”

Set the Noise Cancel function for transmit.

OFF : Turns OFF the function.

ON : The Noise Cancel function reduces random noise components in the transmitted signal to one third.

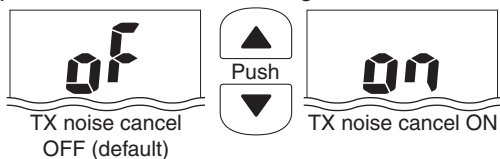

◇ RX bass boost function

“RX BASS BOOST”

Set the bass boost function for receive.

OFF : Turns OFF the function.

ON : The RX bass boost function boosts the level of the receive audio tone.

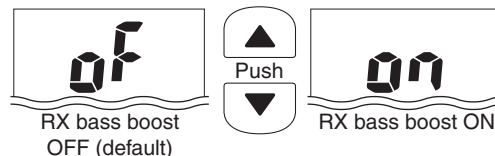

◇ TX bass boost function

“TX BASS BOOST”

Set the bass boost function for transmit.

OFF : Turns OFF the function.

ON : The TX bass boost function boosts the level of the transmit audio tone.

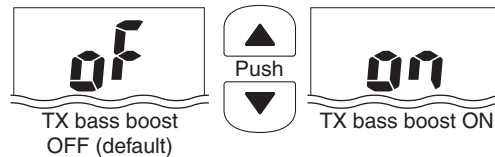

8 SET MODE

◇ Automatic recording threshold level

"AUTO REC"

Set the automatic recording threshold level.

- 1 : Set the threshold level to shallow. The weak signal will automatically record into the memory.
- 2 : Set the threshold level to middle.
- 3 : Set the threshold level to deep. The weak signal will not automatically record into the memory.

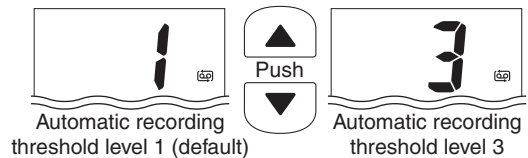

■ Battery cautions

Misuse of Lithium-ion batteries may result in the following hazards: smoke, fire, or battery rupture. Misuse can also cause other battery damage or degradation of battery performance.

- **⚠ DANGER!** Use and charge only specified Icom battery pack with Icom transceiver. Only Icom battery pack is tested and approved for use with Icom transceiver. Using third-party or counterfeit battery packs may cause smoke, fire, or cause the battery to burst.

◇ Battery caution

- **⚠ DANGER! DO NOT** hammer or otherwise impact the battery. Do not use the battery if it has been severely impacted or dropped, or if the battery has been subjected to heavy pressure. Battery damage may not be visible on the outside of the case. Even if the surface of the battery does not show cracks or any other damage, the cells inside the battery may rupture or catch fire.
- **⚠ DANGER! NEVER** use or leave battery pack in areas with temperatures above +60°C (+140°F). High temperature buildup in the battery, such as could occur near fires or stoves, inside a sun-heated car, or by setting the battery in direct sunlight may cause the battery to rupture or catch fire. Excessive temperatures may also degrade battery performance or shorten battery life.

- **⚠ DANGER! DO NOT** expose the battery to rain, snow, seawater, or any other liquids. Do not charge or use a wet battery. If the battery gets wet, be sure to wipe it dry before using. The battery by itself is not waterproof.
- **⚠ DANGER! NEVER** incinerate a used battery pack since internal battery gas may cause a rupture or explosion.
- **⚠ DANGER! NEVER** solder the battery terminals, or **NEVER** modify the battery pack. This may cause heat generation, and the battery may rupture, emit smoke or catch fire.
- **⚠ DANGER!** Use the battery only with the transceiver for which it is specified. Never use a battery with any other equipment, or for any purpose that is not specified in this instruction manual.
- **⚠ DANGER!** If fluid from inside the battery gets in your eyes, blindness can result. Rinse your eyes with clean water, without rubbing them, and see a doctor immediately.
- **WARNING!** Immediately stop using the battery if it emits an abnormal odor, heats up, or is discolored or deformed. If any of these conditions occur, contact your Icom dealer or distributor.
- **WARNING!** Immediately wash, using clean water, any part of the body that comes into contact with fluid from inside the battery.

9 Battery charging

- **WARNING! NEVER** put the battery in a microwave oven, high-pressure container, or in an induction heating cooker. This could cause overheating, a fire, or cause the battery to rupture.
- **CAUTION!** Always use the battery within the specified temperature range for the transceiver (−20°C to +60°C; −4°F to +140°F) and the battery itself (−20°C to +60°C; −4°F to +140°F). Using the battery out of its specified temperature range will reduce the battery’s performance and battery life. Please note that the specified temperature range of the battery may exceed that of the transceiver. In such cases, the transceiver may not work properly because it is out of its operating temperature range.
- **CAUTION!** Shorter battery life could occur if the battery is left fully charged, completely discharged, or in an excessive temperature environment (above +45°C; +113°F) for an extended period of time. If the battery must be left unused for a long time, it must be detached from the radio after discharging. **You may use the battery until the remaining capacity is about half, then keep it safely in a cool dry place with the temperature range as below;**
 - −20°C to +50°C (−4°F to +122°F) (within a month)
 - −20°C to +35°C (−4°F to +95°F) (within three months)
 - −20°C to +20°C (−4°F to +68°F) (within a year)

◇ Charging caution

- **⚠ DANGER! NEVER** charge the battery pack in areas with extremely high temperatures, such as near fires or stoves, inside a sun-heated car, or in direct sunlight. In such environments, the safety/protection circuit in the battery will activate, causing the battery to stop charging.
- **WARNING! DO NOT** charge or leave the battery in the battery charger beyond the specified time for charging. If the battery is not completely charged by the specified time, stop charging and remove the battery from the battery charger. Continuing to charge the battery beyond the specified time limit may cause a fire, overheating, or the battery may rupture.
- **WARNING! NEVER** insert the battery and transceiver (battery attached to the transceiver) into the charger if it is wet or soiled. This could corrode the battery charger terminals or damage the charger. The charger is not waterproof.
- **CAUTION! DO NOT** charge the battery outside of the specified temperature range: ±0°C to +45°C (+32°F to +113°F). Icom recommends charging the battery at +20°C (+68°F). The battery may heat up or rupture if charged out of the specified temperature range. Additionally, battery performance or battery life may be reduced.

■ Supplied battery charger

◇ BC-210 installation

• To a desktop
Supplied screws

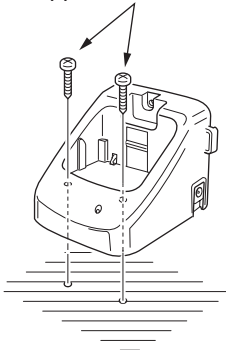

• To a wall

Supplied screws

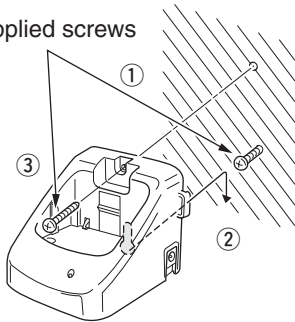

• For added stability

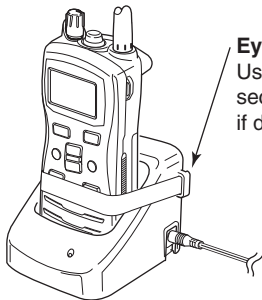

Eyelet:
Use a rubber band to secure the transceiver, if desired.

◇ Charging

- ① Connect the AC adapter as shown below.
- ② Insert the battery pack with/without the transceiver into the charger.
 - The charge indicator lights orange.
- ③ Charge the battery pack approx. 3 hours, depending on the remaining power condition.
 - The charge indicator lights green when charging is complete.

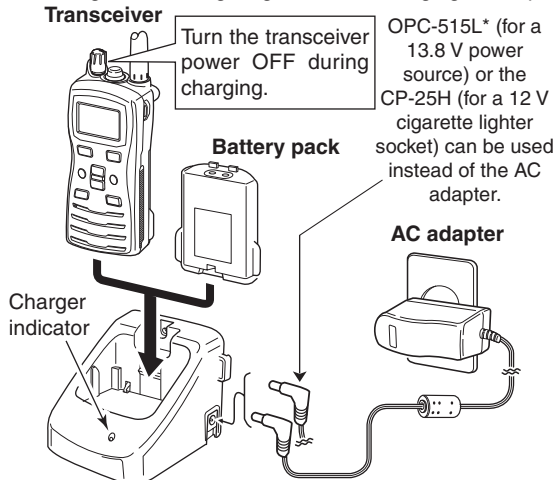

***CAUTION: NEVER** connect the OPC-515L to a power source using reverse polarity. This will ruin the battery charger.

White line: ⊕ Black line: ⊖

■ Optional battery chargers

◇ AD-129 installation

- ① Connect 8-pin connector of the each charger slots to the AD-129 desktop charger adapter's plug.
- ② Install the adapter into the each charger slots in the direction of the arrow, then use the supplied 2 screws to secure the charger adapter to the charger.

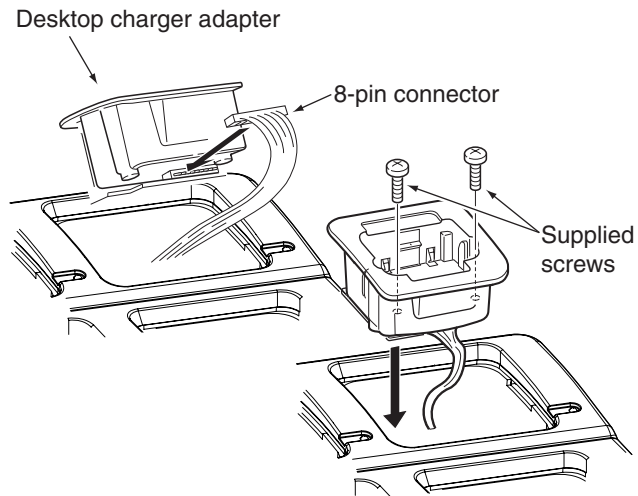

◇ Rapid charging with the BC-197+BC-157S or OPC-656

The optional BC-197 with the BC-157S will simultaneously charge up to 6 Li-ion battery packs. The following items are additionally required. (Charging time: approximately 2.5 hours)

- Six AD-129 charger adapters
- An AC adapter (BC-157S) or the DC power cable (OPC-656)

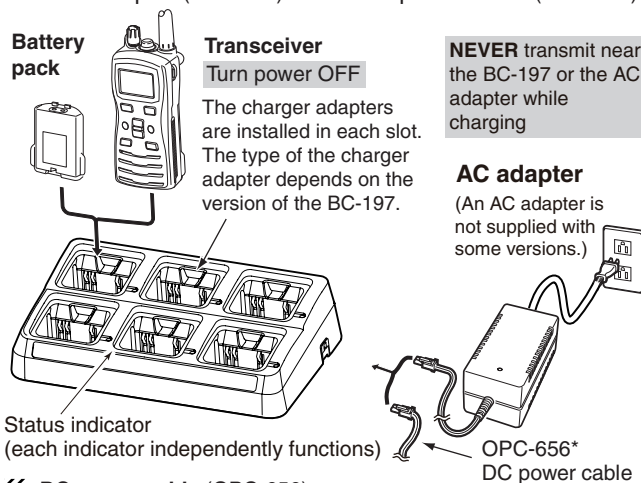

■ DC power cable (OPC-656)

(Connect to a DC power supply: 12 to 16 V/at least 7 A)

NEVER reverse the polarity when connecting the power cable to a power source. This will ruin the battery charger.

Red line : ⊕ Black line : ⊖

OPTIONAL SWIVEL BELT CLIP 10

■ Attachment

- ① Screw the base clip to the back of the transceiver using the two screws (supplied), as shown at right.

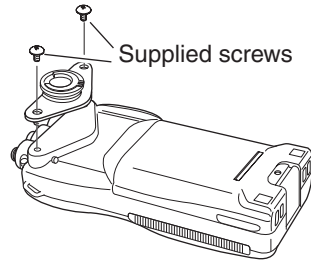

- ② Clip the belt clip over your belt and insert the transceiver.

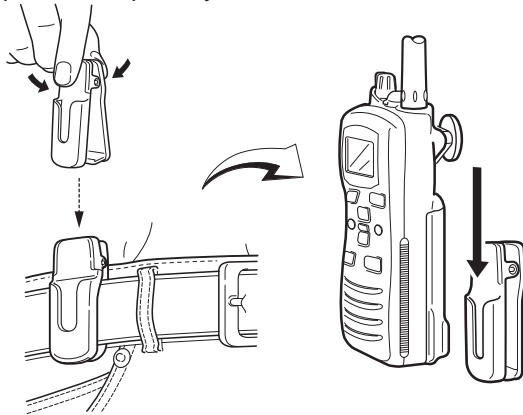

- ③ Once the transceiver is locked in place, it swivels.

■ Detachment

- Turn the transceiver upside down in the direction of the arrow and pull out from the belt clip.

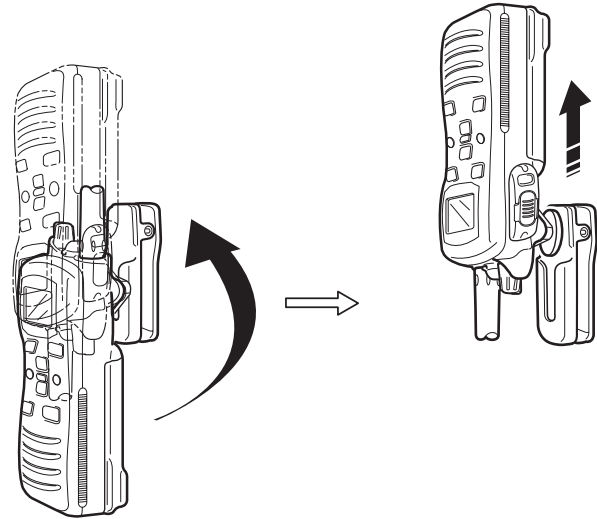

⚠ CAUTION: HOLD THE TRANSCEIVER TIGHTLY WHEN HANGING OR DETACHING THE TRANSCEIVER FROM THE BELT CLIP.

Otherwise the transceiver may not be attached to the belt clip or swivelled properly if the transceiver is accidentally dropped and the base clip is scratched or damaged.

■ HM-167 descriptions

Alligator type clip

To attach the speaker-mic. to your shirt or collar, etc.

PTT switch

Transmits during push.
Receives during release.

Microphone

Speaker

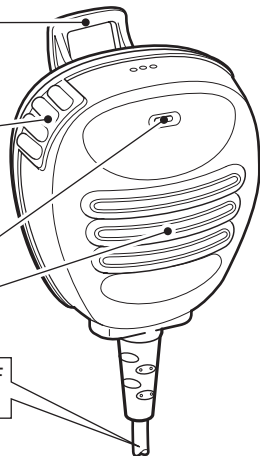

Turn the transceiver power OFF when connecting the HM-167.

NEVER immerse the connector in water. If the connector becomes wet, be sure to dry it **BEFORE** attaching it to the transceiver.

NOTE: The microphone is located at the top of the speaker-microphone, as shown in the diagram above. To maximize the readability of your transmitted signal (voice), hold the microphone approx. 2.5 cm (1 inch) from your mouth, and speak in a normal voice level.

■ Attachment

Insert the speaker-mic connector onto the [SP MIC] connector and carefully screw it tight, as shown in the diagram below. Be careful not to cross-thread the connection.

Set the triangle mark to the front side.

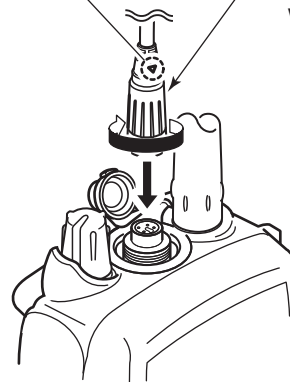

CAUTION: Attach the speaker-microphone's connector securely to prevent accidental dropping, or water intrusion in the connector.

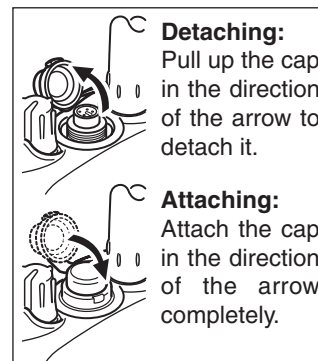

Detaching:

Pull up the cap in the direction of the arrow to detach it.

Attaching:

Attach the cap in the direction of the arrow completely.

IMPORTANT: **KEEP** the transceiver's [SP MIC] connector cap attached when the speaker-microphone is not in use. Water will not get into the transceiver even if the cover is not attached; however, the terminals (pins) will become rusty, or the transceiver will function abnormally if the connector has become wet.

PROBLEM	POSSIBLE CAUSE	SOLUTION	REF.
The transceiver does not turn ON.	<ul style="list-style-type: none"> • The battery is depleted. • Bad connection to the battery pack. 	<ul style="list-style-type: none"> • Recharge the battery pack. • Check the connection to the transceiver. 	pp. 25–27 p. 3
No sound from the speaker.	<ul style="list-style-type: none"> • Squelch level is too tight. • Volume level is too low. • Speaker has been exposed to water. • Water has entered to [SP MIC] connector. 	<ul style="list-style-type: none"> • Set squelch to the threshold point. • Rotate [VOL] to set a suitable level. • Hold down both [16•9] and [H/L•LOCK] to drain water from the speaker. • Dry [SP MIC] connector. 	p. 11 p. 9 p. 12 —
Transmitting is impossible, or high power can not be selected.	<ul style="list-style-type: none"> • Some channels are for low power or receive only. • The battery is exhausted. • The battery is overcharged. • The output power is set to low. 	<ul style="list-style-type: none"> • Change channels. • Recharge the battery pack. • Verify the battery voltage is correct. • Push [H/L•LOCK] to select high power. 	pp. 8, 9, 31 pp. 25–27 — p. 9
The displayed channel cannot be changed.	<ul style="list-style-type: none"> • Lock function is activated. 	<ul style="list-style-type: none"> • Push [H/L•LOCK] for 1 second to cancel the function. 	p. 10
Scan does not start.	<ul style="list-style-type: none"> • “TAG” channels are not programmed. 	<ul style="list-style-type: none"> • Set the desired channels as “TAG” channels. 	p. 15
No beeps.	<ul style="list-style-type: none"> • Beep tones are turned OFF. 	<ul style="list-style-type: none"> • Set the beep tones to ON (Fix Beep/User Beep) in the SET mode. 	p. 18
Self check error. (Temperature)	<ul style="list-style-type: none"> • The temperature is outside of –35°C to +73°C; –31°F to +163°F (approx.). 	<ul style="list-style-type: none"> • Leave the transceiver at room temperature for a while. Turn the power ON to check if the internal temperature has returned to normal. 	—
Self check error. (Battery voltage)	<ul style="list-style-type: none"> • The connected battery pack’s voltage is more than 11 V. 	<ul style="list-style-type: none"> • Verify the battery voltage is correct. 	—
Transmitting continuously while not speaking when using VOX function.	<ul style="list-style-type: none"> • Ambient noise is too loud. 	<ul style="list-style-type: none"> • Push [(I)] and [H/L•LOCK] to deactivate the VOX function. • Set the VOX gain to lower sensitive value. 	p. 12 p. 22
“CHARGE” comment blinks	<ul style="list-style-type: none"> • The connected battery is depleted. 	<ul style="list-style-type: none"> • Recharge the battery pack. 	pp. 25–27

13 SPECIFICATIONS

• IC-M73

◇ General

- Frequency coverage
 - Tx 156.025–157.425 MHz
 - Rx 156.050–163.275 MHz (USA and EXP versions)
 - Rx 156.300–162.025 MHz (AUS version)
- Mode : FM (16K0G3E)
- Operating temperature range
 - USA and EXP versions : –20°C to +60°C (–4°F to +140°F)
 - AUS version : –10°C to +55°C
- Current drain (at 7.4 V) : TX high 1.5 A
(approximately) Max. audio 0.5 A
- Power supply requirement : 7.4 V DC nominal (negative ground)
- Frequency stability
 - USA and EXP versions : ±10 ppm (–20°C to +60°C)
 - AUS version : ±10 ppm (–10°C to +55°C)
- Antenna impedance : 50 Ω nominal
- Dimensions (approximately)
(Projections not included) : 52.5(W) × 125(H) × 30(D)mm
: 2.0(W) × 4.9(H) × 1.2(D) inches
- Weight (approximately) : 280 g/9.9 oz with BP-245N

◇ Transmitter

- Output power
 - USA and EXP versions : 6 W/3 W/1 W
 - AUS version : 5 W (approximately)/1 W
- Modulation system : Variable reactance frequency modulation
- Max. frequency deviation : ±5.0 kHz

- Adjacent channel power : 70 dB
- Spurious emissions (typical)
 - USA and EXP versions : –68 dBc
 - AUS version : 0.25 μW

◇ Receiver

- Sensitivity (typical)
 - USA and EXP versions : 0.22 μV (12 dB SINAD)
 - AUS version : –5 dBμ emf (20 dB SINAD)
- Squelch sensitivity (at threshold, typical)
 - USA and EXP versions : 0.35 μV
 - AUS version : –6 dBμ emf
- Intermodulation rejection ratio
 - USA and EXP versions : 70 dB (typical)
 - AUS version : 65 dB
- Spurious response rejection ratio:
 - USA and EXP versions : 70 dB (typical)
 - AUS version : 65 dB
- Adjacent channel selectivity :
 - USA and EXP versions : 70 dB (typical)
 - AUS version : 65 dB
- Audio output power (at 10% distortion with an 8 Ω load)
 - USA and EXP versions : 0.35 W typical (External)
: 0.7 W typical (Internal)
 - AUS version : 0.2 W (External)
: 0.7 W typical at 1 kHz (Internal)

All stated specifications are subject to change without notice or obligation.

• IC-M73EURO

◇ General

- Frequency coverage : Tx 156.000–161.450 MHz
Rx 156.000–163.425 MHz
- Mode : FM (16K0G3E)
- Operating temperature range : –15°C to +55°C
- Current drain (approximately) : Tx (5 W) 1.5 A
Tx (1 W) 0.7 A
Tx (0.5 W) 0.6 A
Rx Max. audio 0.45 A
- Power supply requirement : 7.4 V DC nominal (negative ground)
- Frequency stability : ±1.5 kHz
- Antenna impedance : 50 Ω nominal
- Dimensions (approximately) : 52.5(W) × 125(H) × 30(D) mm
(Projections not included)
- Weight (approximately) : 280 g with BP-245N

◇ Transmitter

- Output power : 5 W/1 W/0.5 W*
*German version only
- Modulation system : Variable reactance frequency modulation
- Max. frequency deviation : ±5 kHz
- Adjacent channel power : 70 dB
- Spurious emissions : 0.25 μW

◇ Receiver

- Sensitivity (typical) : –4 dBμ emf at 20 dB SINAD
- Squelch sensitivity (threshold) : –5 dBμ emf (typical)
- Intermodulation rejection ratio : 68 dB
- Spurious response rejection ratio : 70 dB
- Adjacent channel selectivity : 70 dB
- Audio output power (at 10% distortion with an 8 Ω load) : 0.2 W (External)
0.7 W typical at 1 kHz (Internal)

All stated specifications are subject to change without notice or obligation.

14 VHF MARINE CHANNEL LIST

◇ For IC-M73EURO • International channels

CH	Frequency (MHz)		CH	Frequency (MHz)		CH	Frequency (MHz)		CH	Frequency (MHz)		CH	Frequency (MHz)		CH	Frequency (MHz)	
	Transmit	Receive		Transmit	Receive		Transmit	Receive		Transmit	Receive		Transmit	Receive		Transmit	Receive
01	156.050	160.650	11	156.550	156.550	21	157.050	161.650	61	156.075	160.675	71	156.575	156.575	81	157.075	161.675
02	156.100	160.700	12	156.600	156.600	22	157.100	161.700	62	156.125	160.725	72	156.625	156.625	82	157.125	161.725
03	156.150	160.750	13	156.650	156.650	23	157.150	161.750	63	156.175	160.775	73	156.675	156.675	83	157.175	161.775
04	156.200	160.800	14	156.700	156.700	24	157.200	161.800	64	156.225	160.825	74	156.725	156.725	84	157.225	161.825
05	156.250	160.850	15 ^{*2}	156.750	156.750	25	157.250	161.850	65	156.275	160.875	75 ^{*4}	156.775	156.775	85	157.275	161.875
06	156.300	156.300	16	156.800	156.800	26	157.300	161.900	66	156.325	160.925	76 ^{*4}	156.825	156.825	86	157.325	161.925
07	156.350	160.950	17 ^{*2}	156.850	156.850	27	157.350	161.950	67	156.375	156.375	77	156.875	156.875	87	157.375	157.375
08	156.400	156.400	18	156.900	161.500	28	157.400	162.000	68	156.425	156.425	78	156.925	161.525	88	157.425	157.425
09	156.450	156.450	19	156.950	161.550	37A ^{*3}	157.850	157.850	69	156.475	156.475	79	156.975	161.575	P4 ^{*3}	161.425	161.425
10	156.500	156.500	20	157.000	161.600	60	156.025	160.625	70 ^{*1}	156.525	156.525	80	157.025	161.625			

*1 DSC operation only.

*2 Channels 15 and 17 may also be used for on-board communications provided the effective radiated power does not exceed 1 W, and subject to the national regulations of the administration concerned when these channels are used in its territorial waters.

*3 UK Marina Channels: M1=37A (157.850 MHz), M2=P4 (161.425 MHz) for U.K. version only

*4 The output power of channels 75 and 76 are limited to low power (1 W) only. The use of these channels should be restricted to navigation-related communications only and all precautions should be taken to avoid harmful interference to channel 16, e.g. by means geographical separation.

◇ For IC-M73EURO

• USA channels (for U.K. version only)

CH	Frequency (MHz)		CH	Frequency (MHz)		CH	Frequency (MHz)		CH	Frequency (MHz)		CH	Frequency (MHz)		CH	Frequency (MHz)	
	Transmit	Receive		Transmit	Receive		Transmit	Receive		Transmit	Receive		Transmit	Receive		Transmit	Receive
01A	156.050	156.050	12	156.600	156.600	22A	157.100	157.100	64A	156.225	156.225	75*1	156.775	156.775	85	157.275	161.875
--	---	---	13*2	156.650	156.650	23A	157.150	157.150	65A	156.275	156.275	76*1	156.825	156.825	85A	157.275	157.275
03A	156.150	156.150	14	156.700	156.700	24	157.200	161.800	66A	156.325	156.325	77*1	156.875	156.875	86	157.325	161.925
--	---	---	15*2	156.750	156.750	25	157.250	161.850	67*2	156.375	156.375	78A	156.925	156.925	86A	157.325	157.325
05A	156.250	156.250	16	156.800	156.800	26	157.300	161.900	68	156.425	156.425	79A	156.975	156.975	87	157.375	161.975
06	156.300	156.300	17*1	156.850	156.850	27	157.350	161.950	69	156.475	156.475	80A	157.025	157.025	87A	157.375	157.375
07A	156.350	156.350	18A	156.900	156.900	28	157.400	162.000	70*3	156.525	156.525	81A	157.075	157.075	88	157.425	162.025
08	156.400	156.400	19A	156.950	156.950	37A*4	157.850	157.850	71	156.575	156.575	82A	157.125	157.125	88A	157.425	157.425
09	156.450	156.450	20	157.000	161.600	61A	156.075	156.075	72	156.625	156.625	83A	157.175	157.175	P4*4	161.425	161.425
10	156.500	156.500	20A	157.000	157.000	--	---	---	73	156.675	156.675	84	157.225	161.825			
11	156.550	156.550	21A	157.050	157.050	63A	156.175	156.175	74	156.725	156.725	84A	157.225	157.225			

*1 Low power only.

*2 Momentary high power.

*3 DSC operation only.

*4 UK Marina Channels: M1=37A (157.850 MHz), M2=P4 (161.425 MHz) for U.K. version only

NOTE: Simplex channels, 3, 21, 23, 61, 64, 81, 82 and 83 **CANNOT** be lawfully used by the general public in U.S.A. waters.

14 VHF MARINE CHANNEL LIST

◇ For IC-M73

Channel number			Frequency (MHz)	
USA	INT	CAN	Transmit	Receive
	01	01	156.050	160.650
01A			156.050	156.050
	02	02	156.100	160.700
	03	03	156.150	160.750
03A			156.150	156.150
	04		156.200	160.800
		04A	156.200	156.200
	05		156.250	160.850
05A		05A	156.250	156.250
06	06	06	156.300	156.300
	07		156.350	160.950
07A		07A	156.350	156.350
08	08	08	156.400	156.400
09	09	09	156.450	156.450
10	10	10	156.500	156.500
11	11	11	156.550	156.550
12	12	12	156.600	156.600
13*	13	13*	156.650	156.650
14	14	14	156.700	156.700
15*	15*	15*	156.750	156.750
16	16	16	156.800	156.800
17*	17	17*	156.850	156.850
	18		156.900	161.500
18A		18A	156.900	156.900
	19		156.950	161.550

Channel number			Frequency (MHz)	
USA	INT	CAN	Transmit	Receive
19A		19A	156.950	156.950
20	20	20*	157.000	161.600
20A			157.000	157.000
	21	21	157.050	161.650
21A		21A	157.050	157.050
	22		157.100	161.700
22A		22A	157.100	157.100
	23	23	157.150	161.750
23A			157.150	157.150
24	24	24	157.200	161.800
25	25	25	157.250	161.850
26	26	26	157.300	161.900
27	27	27	157.350	161.950
28	28	28	157.400	162.000
	60	60	156.025	160.625
	61		156.075	160.675
61A		61A	156.075	156.075
	62		156.125	160.725
		62A	156.125	156.125
	63		156.175	160.775
63A			156.175	156.175
	64	64	156.225	160.825
64A		64A	156.225	156.225
	65		156.275	160.875
65A	65A	65A	156.275	156.275

Channel number			Frequency (MHz)	
USA	INT	CAN	Transmit	Receive
	66		156.325	160.925
66A	66A	66A*	156.325	156.325
67*	67	67	156.375	156.375
68	68	68	156.425	156.425
69	69	69	156.475	156.475
70	70	70	Rx only	156.525
71	71	71	156.575	156.575
72	72	72	156.625	156.625
73	73	73	156.675	156.675
74	74	74	156.725	156.725
77*	77	77*	156.875	156.875
	78		156.925	161.525
78A		78A	156.925	156.925
	79		156.975	161.575
79A		79A	156.975	156.975
	80		157.025	161.625
80A		80A	157.025	157.025
	81		157.075	161.675
81A		81A	157.075	157.075
	82		157.125	161.725
82A		82A	157.125	157.125
	83	83	157.175	161.775
83A		83A	157.175	157.175
84	84	84	157.225	161.825
84A			157.225	157.225

Channel number			Frequency (MHz)	
USA	INT	CAN	Transmit	Receive
85	85	85	157.275	161.875
85A			157.275	157.275
86	86	86	157.325	161.925
86A			157.325	157.325
87	87	87	157.375	161.975
87A			157.375	157.375
88	88	88	157.425	162.025
88A			157.425	157.425
		21b	Rx only	161.650
		25b	Rx only	161.850
		28b	Rx only	162.000
		83b	Rx only	161.775
WX channel	Frequency (MHz)			
	Transmit	Receive		
1		RX only	162.550	
2		RX only	162.400	
3		RX only	162.475	
4		RX only	162.425	
5		RX only	162.450	
6		RX only	162.500	
7		RX only	162.525	
8		RX only	161.650	
9		RX only	161.775	
10		RX only	163.275	

*Low power only. **NOTE:** Simplex channels 3, 21, 23, 61, 64, 81, 82 and 83 **CANNOT** be lawfully used by the general public in USA waters. The programmed channels are differ according to versions.

◇ BATTERY CASE AND PACK

- **BP-245N** Li-Ion BATTERY PACK
The same as supplied with the transceiver.
Voltage : 7.4 V
Capacity : 1900 mAh (minimum)/2000 mAh (typical)

◇ CHARGERS

- **BC-210** DESKTOP CHARGER + **BC-123SA/SE** AC ADAPTER
For rapid charging of battery packs. The same as supplied with the transceiver. An AC adapter is supplied with the charger depending on versions. Charging time: approx. 3 to 4 hours
- **BC-197** MULTI-CHARGER + **AD-129** CHARGER ADAPTER (6 pcs.) + **BC-157S** AC ADAPTER
For rapid charging of up to 6 battery packs (six AD-129's are required) simultaneously. An AC adapter should be purchased separately. Charging time: approx. 3 to 4 hours.

◇ BELT CLIPS

- **MB-103** BELT CLIP
The same as supplied with the transceiver.
- **MB-86** SWIVEL BELT CLIP
Belt clip for swivel type.
- **MB-96N** LEATHER BELT HANGER

◇ DC CABLES

- **CP-25H** CIGARETTE LIGHTER CABLE
Charges the battery pack through a 12 V cigarette lighter socket. (For BC-210)
- **OPC-515L/OPC-656** DC POWER CABLES
Charges the battery pack using 13.8 V power source instead of the AC adapter.
OPC-515L: For BC-210
OPC-656 : For BC-197

◇ OTHER OPTIONS

- **HM-167** SPEAKER-MICROPHONE
Full sized waterproof speaker-microphone including alligator type clip to attach to your shirt or collar, etc.
- **HM-202** SPEAKER-MICROPHONE
- **FA-S64V** FLEXIBLE ANTENNA
Same as that supplied with the transceiver.

Icom optional equipment is designed for optimal performance when used with this transceiver. We are not responsible for the transceiver being damaged or any accident caused when using non-Icom optional equipment.

Available or applicable options may differ according to countries. Ask your authorized dealer for details.

Count on us!

< Intended Country of Use >

AT BE CY CZ DK EE
FI FR DE GR HU IE
IT LV LT LU MT NL
PL PT SK SI ES SE
GB IS LI NO CH BG
RO TR HR

A-7070D-1EX
Printed in Japan
© 2013 Icom Inc.

Printed on recycled paper with soy ink.

Icom Inc.

1-1-32 Kamiminami, Hirano-ku, Osaka 547-0003, Japan