

ENGINEERING TEST REPORT

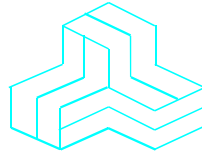

VHF Marine Transceiver
Model No (s): IC-M400BB AND IC-M424G
FCC ID: AFJ333810
IC:202D-333810 D

Applicant:
ICOM Incorporated
1-1-32, Kamiminami,
Hirano-ku, Osaka
Japan 547-0003

Tested in Accordance With

Federal Communications Commission (FCC)
47 CFR, Part 2, Part 80 (Marine in 156.025-157.425Hz)
Industry Canada RSS-182, Issue 5
Maritime Radio Transmitters and Receivers in the Band 156-162.5 MHz

UltraTech's File No.: 20ICOM-524_F80RSS182

This Test report is Issued under the Authority of
Tri M. Luu
Vice President of Engineering
UltraTech Group of Labs

Date: May 6, 2020

Report Prepared by: Santhosh Fernandez

Tested by: Nimisha Desai

Issued Date: May 6, 2020

Test Dates: April 16- 27, 2020

- *The results in this Test Report apply only to the sample(s) tested, and the sample tested is randomly selected.*
- *This report must not be used by the client to claim product endorsement by any agency of the US Government.*
- *This test report shall not be reproduced, except in full, without a written approval from UltraTech.*

UltraTech

3000 Bristol Circle, Oakville, Ontario, Canada, L6H 6G4
Tel.: (905) 829-1570 Fax.: (905) 829-8050

Website: www.ultratech-labs.com, Email: vic@ultratech-labs.com, Email: tri@ultratech-labs.com



APEC TEL
#CA0001



1309



CA 0001/2049



AT-1945



SL2-IN-E-
1119R



Korea
KCC-RRR

CA0001

TABLE OF CONTENTS

EXHIBIT 1. INTRODUCTION	1
1.1. SCOPE.....	1
1.2. RELATED SUBMITTAL(S)/GRANT(S).....	1
1.3. NORMATIVE REFERENCES	1
EXHIBIT 2. PERFORMANCE ASSESSMENT	2
2.1. CLIENT INFORMATION	2
2.2. EQUIPMENT UNDER TEST (EUT) INFORMATION.....	2
2.3. EUT'S TECHNICAL SPECIFICATIONS	3
2.4. LIST OF EUT'S PORTS	3
2.5. ANCILLARY EQUIPMENT	3
EXHIBIT 3. EUT OPERATING CONDITIONS AND CONFIGURATIONS DURING TESTS	4
3.1. CLIMATE TEST CONDITIONS	4
3.2. OPERATIONAL TEST CONDITIONS & ARRANGEMENT FOR TEST SIGNALS	4
3.3. MODIFICATIONS INCORPORATED IN THE EUT FOR COMPLIANCE PURPOSES.....	4
3.4. DEVIATION OF STANDARD TEST PROCEDURES	4
EXHIBIT 4. SUMMARY OF TEST RESULTS	5
4.1. LOCATION OF TESTS	5
4.2. APPLICABILITY & SUMMARY OF EMC EMISSION TEST RESULTS	5
EXHIBIT 5. TEST DATA.....	6
5.1. RF POWER OUTPUT [§§ 2.1046 & 80.215] [RSS-182, SECTION 7.5].....	6
5.2. MODULATION CHARACTERISTICS & AUDIO FREQUENCY RESPONSE [§§ 2.1047(A) & 80.213(E)]	8
5.3. MODULATION LIMITING [§ 80.213 & § 2.1047(B)].....	11
5.4. EMISSION MASK [§§ 2.1049, 80.205 & 80.211] [RSS-182, SECTIONS 7.3, 7.9.1 & 7.9.2]	14
5.5. TRANSMITTER ANTENNA POWER SPURIOUS/HARMONIC CONDUCTED EMISSIONS [§ 80.211(F)(3)] [RSS-182, SECTION 7.9]	32
5.6. TRANSMITTER SPURIOUS/HARMONIC RADIATED EMISSIONS [§ 80.211(F)(3)] [RSS-182, SECTION 7.9]	48
5.7. FREQUENCY STABILITY [§§ 2.1055 & 80.209] [RSS-182, SECTION 7.4].....	50
5.8. RF EXPOSURE REQUIREMENTS [§§ 1.1310 & 2.1091] [RSS GEN SEC 5.6 & RSS-102]	52
5.9. RECEIVER SPURIOUS EMISSIONS (RADIATED) [RSS-182 § 7.11, RSS-GEN §§ 7.3]	58
5.10. POWERLINE CONDUCTED EMISSIONS [ICES-003]	59
5.11. RADIATED EMISSIONS-UNINTENTIONAL [ICES-003]	64
EXHIBIT 6. TEST EQUIPMENT LIST AND SETUP	65
6.1. CONDUCTED POWER	65
6.2. MODULATION LIMIT.....	66
6.3. AUDIO FREQUENCY RESPONSE.....	67
6.4. 99% OBW AND MASK	68
6.5. RX CONDUCTED	69
6.6. TX CONDUCTED EMISSION	70
6.7. FREQUENCY STABILITY	71
6.8. TX RADIATED.....	72
6.9. RX RADIATED	73
6.10. ISED DIGITAL /UNINTENTIONAL TESTS	74
EXHIBIT 7. MEASUREMENT UNCERTAINTY.....	78
7.1. LINE CONDUCTED EMISSION MEASUREMENT UNCERTAINTY	78

ULTRATECH GROUP OF LABS

3000 Bristol Circle, Oakville, Ontario, Canada L6H 6G4
Tel. #: 905-829-1570, Fax. #: 905-829-8050, Email: vic@ultratech-labs.com, Website: <http://www.ultratech-labs.com>

File #: 20ICOM-524_F80RSS182
May 6, 2020

All test results contained in this engineering test report are traceable to National Institute of Standards and Technology (NIST)

7.2.	RADIATED EMISSION MEASUREMENT UNCERTAINTY	78
EXHIBIT 8.	MEASUREMENT METHODS	79
8.1.	CONDUCTED POWER MEASUREMENTS	79
8.2.	RADIATED POWER MEASUREMENTS (ERP & EIRP) USING SUBSTITUTION METHOD	80
8.3.	FREQUENCY STABILITY	83
8.4.	EMISSION MASK	84
8.5.	SPURIOUS EMISSIONS (CONDUCTED)	84

EXHIBIT 1. INTRODUCTION

1.1. SCOPE

Reference:	FCC Parts 2 and 80 Industry Canada RSS-182, Issue 5
Title:	Telecommunication - Code of Federal Regulations, 47CFR, Parts 2 and 80 Maritime Radio Transmitters and Receivers in the Band 156-162.5 MHz
Purpose of Test:	To gain FCC Equipment Authorization for Radio operating in the frequency bands, 156.025-161.600 MHz (Marine) and Industry Canada Type Acceptance Authorization for Maritime Radio Transmitters and Receivers in the Band 156-162.5 MHz
Test Procedures:	Both conducted and radiated emissions measurements were conducted in accordance with TIA/EIA Standard TIA/EIA-603 E – Land Mobile FM or PM Communications Equipment Measurement and performance Standards.
Categories of Station:	Ship station transceiver operating in 156.025-157.425 MHz band

1.2. RELATED SUBMITTAL(S)/GRANT(S)

None

1.3. NORMATIVE REFERENCES

Publication	Year	Title
FCC CFR Parts 0-19, 80-End	2019	Code of Federal Regulations – Telecommunication
ANSI C63.4	2014	American National Standard for Methods of Measurement of Radio-Noise Emissions from Low-Voltage Electrical and Electronic Equipment in the Range of 9 kHz to 40 GHz
TIA/EIA 603, Edition E	2016	Land Mobile FM or PM Communications Equipment Measurement and Performance Standards
CISPR 16-1-1	2010	Specification for radio disturbance and immunity measuring apparatus and methods. Part 1-1: Measuring Apparatus
CISPR 16-1-2 +A1 +A2	2003 2004 2006	Specification for radio disturbance and immunity measuring apparatus and methods. Part 1-2: Conducted disturbances
RSS-182, Issue 5	2012	Maritime Radio Transmitters and Receivers in the Band 156-162.5 MHz
RSS-Gen, Issue 5	2018	General Requirements for Compliance of Radio Apparatus
TIA/EIA 603, Edition E	2016	Land Mobile FM or PM Communications Equipment Measurement and Performance Standards
ICES-003, Issue 6	2016	Digital Apparatus
ITU-R M.493-13	2009	Digital selective-calling system for use in the maritime mobile service

ULTRATECH GROUP OF LABS

3000 Bristol Circle, Oakville, Ontario, Canada L6H 6G4
Tel. #: 905-829-1570, Fax. #: 905-829-8050, Email: vic@ultratech-labs.com, Website: <http://www.ultratech-labs.com>

File #: 20ICOM-524_F80RSS182
May 6, 2020

All test results contained in this engineering test report are traceable to National Institute of Standards and Technology (NIST)

EXHIBIT 2. PERFORMANCE ASSESSMENT

2.1. CLIENT INFORMATION

Applicant	
Name:	Icom Incorporated
Address:	1-1-32, Kamiminami Hirano-ku, Oaska Japan, 547-0003
Contact Person:	Mr. Atsushi Tomiyama Phone #: +81-66-793-8424 Fax #: +81-66-793-3336 Email Address: world_support@icom.co.jp

Manufacturer	
Name:	Icom Incorporated
Address:	1-1-32, Kamiminami Hirano-ku, Oaska Japan, 547-0003
Contact Person:	Mr. Atsushi Tomiyama Phone #: +81-66-793-8424 Fax #: +81-66-793-3336 Email Address: world_support@icom.co.jp

2.2. EQUIPMENT UNDER TEST (EUT) INFORMATION

The following information (with the exception of the Date of Receipt) has been supplied by the applicant.

Brand Name:	ICOM Incorporated
Product Name:	VHF Marine Transceiver
Model Name or Number:	IC-M424G
Serial Number:	00000006
Type of Equipment:	Licensed Non-Broadcast Transmitter Held to Face
Power Supply Requirement:	13.8 V DC
Transmitting/Receiving Antenna Type:	Non-integral
Primary User Functions of EUT:	VHF Marine Transceiver

2.3. EUT'S TECHNICAL SPECIFICATIONS

Transmitter	
Equipment Type:	Mobile
Intended Operating Environment:	Marine
Power Supply Requirement:	13.8 V DC
RF Output Power Rating:	25 Watts (High) and 1 Watt (Low)
Operating Frequency Range:	156.025-157.425 MHz (Marine)
RF Output Impedance:	50 Ohm
Channel Spacing:	25 kHz
Modulation Employed:	Variable reactance FM (frequency modulation)
Occupied Bandwidth (99%):	14.93 kHz, 12.84 kHz (DSC)
Emission Designation*:	FM (16K0G3E) DSC(16K0G2B)
Antenna Type:	UHF

*For an average case of commercial telephony, the Necessary Bandwidth is calculated as follows:

Channel Spacing = 25 KHz, D = 5 KHz max, K = 1, M = 3 KHz

$$B_n = 2M + 2DK = 2(3) + 2(5)(1) = \mathbf{16\text{ kHz}}$$

Emission designation: 16K0G3E

Receiver	
Operating Frequency Range:	156.50-163.275 MHz
Intermediate Frequencies:	21.7 MHz

2.4. LIST OF EUT'S PORTS

Port Number	EUT's Port Description	Number of Identical Ports	Connector Type
1	Antenna Connector	1	UHF
2	NMEA IN/OUT	1	Leads
3	AF OUT bundle	1	Leads
4	DC Power	1	Leads(pair)
5	Ground terminal	1	Lead
6	Microphone Jack	1	8 pin circular

2.5. ANCILLARY EQUIPMENT

Description:	Speaker Microphone
Brand Name:	Icom Inc.
Model Name or Number:	HM-205B

ULTRATECH GROUP OF LABS

3000 Bristol Circle, Oakville, Ontario, Canada L6H 6G4
Tel. #: 905-829-1570, Fax. #: 905-829-8050, Email: vic@ultratech-labs.com, Website: <http://www.ultratech-labs.com>

File #: 20ICOM-524_F80RSS182
May 6, 2020

All test results contained in this engineering test report are traceable to National Institute of Standards and Technology (NIST)

EXHIBIT 3. EUT OPERATING CONDITIONS AND CONFIGURATIONS DURING TESTS

3.1. CLIMATE TEST CONDITIONS

The climate conditions of the test environment are as follows:

Temperature:	21°C to 24°C
Humidity:	45 to 55%
Pressure:	102 kPa
Power input source:	13.8 V DC

3.2. OPERATIONAL TEST CONDITIONS & ARRANGEMENT FOR TEST SIGNALS

Operating Modes:	The transmitter was operated in a continuous transmission mode with the carrier modulated as specified in the Test Data.
Special Test Software:	N/A
Special Hardware Used:	N/A
Transmitter Test Antenna:	The EUT is tested with the transmitter antenna port terminated to a 50 Ohm RF Load.

Transmitter Test Signals	
Frequency Band(s):	156.025-157.425 MHz
Test Frequency(ies):	156.050 and 157.425 MHz, 156.525 MHz (DSC)
Transmitter Wanted Output Test Signals:	
Transmitter Power (rated output power):	25 Watts High, 1 Watt Low
Normal Test Modulation:	Variable reactance frequency modulation
Modulating signal source:	External

3.3. MODIFICATIONS INCORPORATED IN THE EUT FOR COMPLIANCE PURPOSES

None

3.4. DEVIATION OF STANDARD TEST PROCEDURES

None

EXHIBIT 4. SUMMARY OF TEST RESULTS

4.1. LOCATION OF TESTS

All of the measurements described in this report were performed at Ultratech Group of Labs located in the city of Oakville, Province of Ontario, Canada.

Radiated Emissions were performed at the Ultratech's 3-10 TDK Semi-Anechoic Chamber situated in the Town of Oakville, province of Ontario. This test site been calibrated in accordance with ANSI C63.4, and found to be in compliance with the requirements of Sec. 2.948 of the FCC Rules. The descriptions and site measurement data of the Oakville 3-10 TDK Semi-Anechoic Chamber has been filed with ANAB File No.: AT-1945.

4.2. APPLICABILITY & SUMMARY OF EMC EMISSION TEST RESULTS

FCC/RSS Section(s)	Test Requirements	Applicability (Yes/No)
2.1046 & 80.215 RSS-182, Section 7.5	RF Power Output	Yes
2.1047(a) & 80.213(e)	Modulation Characteristics - Audio Frequency Response	Yes
2.1047(b) & 80.213	Modulation Characteristics - Modulation Limiting	Yes
2.1049, 80.205 & 80.211(f) RSS-182, Sections 7.3, 7.9.1 & 7.9.2	Occupied Bandwidth and Emission Limitations	Yes
2.1051, 2.1057 & 80.211(f)(3) RSS-182, Section 7.9	Spurious Emissions at Antenna Terminal	Yes
2.1053, 2.1057 & 80.211(f)(3) RSS-182, Section 7.9	Field Strength of Spurious Emissions	Yes
2.1055 & 80.209 RSS-182, Section 7.4	Frequency Stability	Yes
80.217	Suppression of Interference aboard ships	Yes ¹
1.1307, 1.1310, 2.1091 & 2.1093 RSS-Gen, §3.4 & RSS-102	RF Exposure Limit	Yes
RSS-182, Section 4.3	Transport Canada Requirements	Yes
RSS-182, Section 7.7	VHF AIS Transponders	N/A
RSS-182, Section 7.10	Data Modem	N/A
RSS-182, Section 7.11	Receiver Spurious Emissions	Yes
RSS-Gen, Section B6	Modular Construction	N/A
RSS-Gen, Section 6.4	External Controls	Yes
RSS-Gen, §3.4 & RSS-102	Exposure of Humans to RF Fields	Yes
RSS-Gen, Section 6.8	Transmitter Antenna	Yes
ICES-003, Issue 6	Digital Apparatus	Yes

¹ Complies with FCC Part 15, Subpart B.

EXHIBIT 5. TEST DATA

5.1. RF POWER OUTPUT [§§ 2.1046 & 80.215] [RSS-182, SECTION 7.5]

5.1.1. Limits

§ 80.215(e)(1) Ship stations 156–162 MHz - 25W(1,2)
Marine utility stations and hand-held portable transmitters: 156–162 MHz -10W

1 Reducible to 1 watt or less, except for transmitters limited to public correspondence channels and used in an automated system.

2 The frequencies 156.775 and 156.825 MHz are available for navigation-related port operations or ship movement only, and all precautions must be taken to avoid harmful interference to channel 16. Transmitter output power is limited to 1 watt for ship stations, and 10 watts for coast stations.

[RSS-182, SECTION 7.5]

The output power shall be within ± 1.0 dB of the manufacturer's rated power and not exceed the limits listed in Table 3, unless indicated otherwise.

Table 3 lists typical transmitter output powers for equipment certified under this standard.

RSS-182, Table 3 - Transmitter Power

Stations	Typical Power
Coast stations	50 W
Ship stations Minimum: Maximum:	6 W 25 W
Hand-held portable transmitters	5 W
Survival two-way radiotelephones	Should have a minimum e.i.r.p. of 0.25 watt

Ship station transmitters shall have power control features implemented to reduce the carrier power to one watt or less for use at short ranges, except for DSC equipment operating on the 156.525 MHz (channel 70) frequency, for which the power reduction facility is optional.

The VHF radio transmitters shall be equipped with an automatic timing device that deactivates the transmitter and reverts the transmitter to the receive mode after an uninterrupted transmission period of five minutes, plus or minus 10 percent. Furthermore, these transmitters shall have a device that indicates when the automatic timer has deactivated the transmitter.

5.1.2. Method of Measurements

Refer to Section 8.1 of this report for measurement details.

5.1.3. Test Data

Transmitter Channel Output	Fundamental Frequency (MHz)	Measured (Average) Conducted Power (W)	Power Rating (W)
Power Setting: High			
Lowest	156.050	23.17	25
Highest	157.425	23.01	25
DSC	156.525	23.28	25
Power Setting: Low			
Lowest	156.050	0.84	1.0
Highest	157.425	0.83	1.0
DSC	156.525	0.84	1.0

5.2. MODULATION CHARACTERISTICS & AUDIO FREQUENCY RESPONSE [§§ 2.1047(a) & 80.213(e)]

5.2.1. Limits

(e) Coast station transmitters operated in the 156–162 MHz band must be equipped with an audio low-pass filter. The filter must be installed between the modulation limiter and the modulated radio frequency stage. At frequencies between 3 kHz and 20 kHz it must have an attenuation greater than at 1 kHz by at least $60\log_{10}(f/3)$ dB where “f” is the audio frequency in kilohertz. At frequencies above 20 kHz the attenuation must be at least 50 dB greater than at 1 kHz

5.2.2. Method of Measurements

The rated audio input signal was applied to the input of the audio lowpass filter (or of all modulation stages) using an audio oscillator, this input signal level and its corresponding output signal were then measured and recorded using the FFT (Audio) spectrum analyzer. Tests were repeated at different audio signal frequencies from 0 to 50 kHz.

5.2.3. Test Data

Note: Due to the difficulty of measuring the Frequency Response of the internal lowpass filter, the Frequency Response of All Modulation States are performed to show the roll-off at 3 kHz in comparison with the limit for audio low-pass filter.

▪ **Minimum Attenuation Rel. to 1 kHz Attenuation (25 kHz channel spacing)**

Frequency (kHz)	Audio IN (dBV)	Audio OUT (dBV)	Attenuation (OUT - IN) (dB)	Attenuation wrt. 1 kHz (dB)	Recommended FCC Limit (dB)
0.1	-44.44	-18.65	25.8	-23.3	--
0.2	-44.44	-10.31	34.1	-14.9	--
0.4	-44.44	-3.26	41.2	-7.9	--
0.6	-44.44	0.24	44.7	-4.4	--
0.8	-44.44	2.72	47.2	-1.9	--
1.0	-44.44	4.60	49.0	0.0	--
1.5	-44.44	7.88	52.3	3.3	--
2.0	-44.44	9.46	53.9	4.9	--
2.5	-44.44	9.62	54.1	5.0	--
3.0	-44.44	8.45	52.9	3.8	0
3.5	-44.44	6.21	50.7	1.6	-4
4.0	-44.44	3.04	47.5	-1.6	-7
4.5	-44.44	-0.44	44.0	-5.0	-11
5.0	-44.44	-3.71	40.7	-8.3	-13
6.0	-44.44	-9.92	34.5	-14.5	-18
7.0	-44.44	-15.88	28.6	-20.5	-22
8.0	-44.44	-38.90	5.5	-43.5	-26
9.0	-44.44	-70.00	-25.6	-74.6	-29
10.0	-44.44	-70.00	-25.6	-74.6	-31
12.0	-44.44	-70.00	-25.6	-74.6	-36
14.0	-44.44	-70.00	-25.6	-74.6	-40
16.0	-44.44	-70.00	-25.6	-74.6	-44
18.0	-44.44	-70.00	-25.6	-74.6	-47
20.0	-44.44	-70.00	-25.6	-74.6	-49
22.0	-44.44	-70.00	-25.6	-74.6	-50
25.0	-44.44	-70.00	-25.6	-74.6	-50
30.0	-44.44	-70.00	-25.6	-74.6	-50
35.0	-44.44	-70.00	-25.6	-74.6	-50
40.0	-44.44	-70.00	-25.6	-74.6	-50
45.0	-44.44	-70.00	-25.6	-74.6	-50
50.0	-44.44	-70.00	-25.6	-74.6	-50

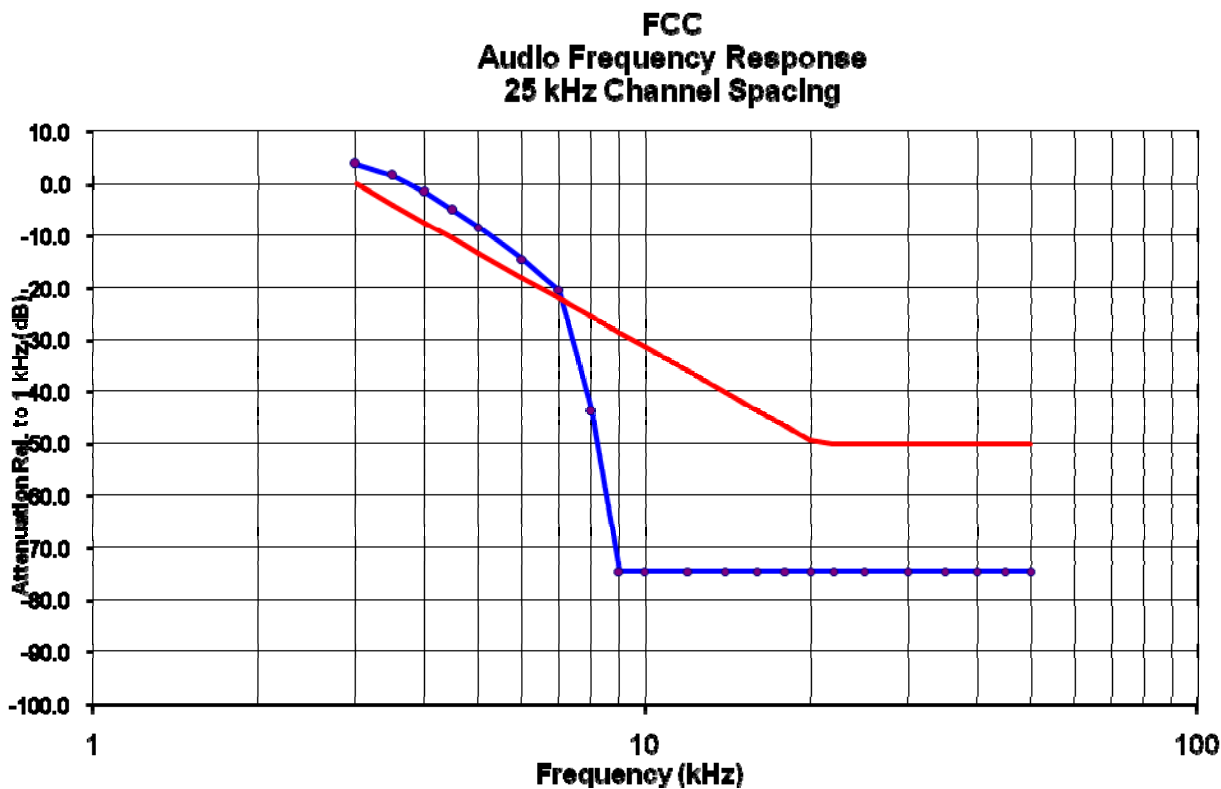

5.3. MODULATION LIMITING [§ 80.213 & § 2.1047(b)]

5.3.1. Limits

§ 80.213 (a)(2) When phase or frequency modulation is used in the 156-162 MHz band the peak modulation must be maintained between 75 and 100 percent. A frequency deviation of ± 5 kHz is defined as 100 percent peak modulation; and

§ 80.213 (b) Radiotelephone transmitters using A3E, F3E and G3E emission must have a modulation limiter to prevent any modulation over 100 percent. This requirement does not apply to survival craft transmitters, to transmitters that do not require a license or to transmitters whose output power does not exceed 3 watts.

§ 80.213 (d) Ship and coast station transmitters operating in the 156-162 MHz and 216-220 bands must be capable of proper operation with a frequency deviation that does not exceed ± 5 kHz when using any emission authorized by Sec. 80.207.

5.3.2. Method of Measurements

For Audio Transmitter:- The carrier frequency deviation was measured with the tone input signal level varied from 0 Vp to audio input rating level plus 16 dB at frequencies 0.1, 0.5, 1.0, 3.0 and 5.0 kHz. The maximum deviation was recorded at each test condition.

5.3.3. Test Data

Test Channel: 156.050 MHz High Power

5.3.3.1. Voice Modulation Limiting

Modulating Signal Level (mVrms)	Peak Frequency Deviation (kHz)					Maximum Limit (kHz)
	0.1 kHz	0.5 kHz	1.0 kHz	3.0 kHz	5.0 kHz	
1	0.17	0.30	0.506	1.04	0.34	5.0
2	0.18	0.56	0.92	1.94	0.55	5.0
4	0.24	0.88	1.80	3.56	0.98	5.0
6	0.26	1.34	2.52	3.76	0.99	5.0
8	0.36	1.76	3.39	3.78	0.97	5.0
10	0.37	2.10	3.76	3.79	0.97	5.0
15	0.55	3.10	4.27	3.79	0.95	5.0
20	0.66	3.84	4.34	3.79	0.95	5.0
25	0.85	3.96	4.35	3.79	0.95	5.0
30	0.96	4.01	4.36	3.80	0.95	5.0
35	1.12	4.07	4.36	3.80	0.94	5.0
40	1.26	4.18	4.36	3.80	0.94	5.0
45	1.46	4.23	4.36	3.80	0.94	5.0
50	1.60	4.26	4.37	3.80	0.94	5.0
60	1.88	4.26	4.37	3.80	0.94	5.0
70	2.17	4.26	4.38	3.80	0.94	5.0
80	2.47	4.25	4.38	3.80	0.94	5.0
90	2.67	4.24	4.38	3.80	0.94	5.0
100	2.98	4.23	4.38	3.80	0.94	5.0

Voice Signal Input Level = STD MOD Level + 16 dB = 6mV+16dB = 31.56 dB(mVrms) = 37.86 mVrms		
Modulation Frequency (KHz)	Peak Deviation (KHz)	Maximum Limit (KHz)
0.1	1.25	5.0
0.2	2.87	5.0
0.4	4.08	5.0
0.6	4.39	5.0
0.8	4.38	5.0
1.0	4.39	5.0
1.2	4.39	5.0
1.4	4.34	5.0
1.6	4.32	5.0
1.8	4.33	5.0
2.0	4.34	5.0
2.5	4.28	5.0
3.0	3.82	5.0
3.5	2.95	5.0
4.0	2.04	5.0
4.5	1.38	5.0
5.0	0.94	5.0
6.0	0.49	5.0
7.0	0.30	5.0
8.0	0.22	5.0
9.0	0.08	5.0
10.0	0.09	5.0

ULTRATECH GROUP OF LABS

3000 Bristol Circle, Oakville, Ontario, Canada L6H 6G4
Tel. #: 905-829-1570, Fax. #: 905-829-8050, Email: vic@ultratech-labs.com, Website: <http://www.ultratech-labs.com>

File #: 20ICOM-524_F80RSS182

May 6, 2020

All test results contained in this engineering test report are traceable to National Institute of Standards and Technology (NIST)

5.4. EMISSION MASK [§§2.1049, 80.205 & 80.211] [RSS-182, SECTIONS 7.3, 7.9.1 & 7.9.2]

5.4.1. Limits

Emissions shall be attenuated below the mean output power of the transmitter as follows:

Emission designator	Maximum Authorized BW (kHz)	Channel Spacing (kHz)	Recommended Frequency Deviation (kHz)	Applicable Mask
16K0G3E	20	25	5	See § 80.211 (f)

§ 80.211 (f) Emission Limitations:

- (1) On any frequency removed from the assigned frequency by more than 50 percent up to and including 100 percent of the authorized bandwidth: At least 25 dB;
- (2) On any frequency removed from the assigned frequency by more than 100 percent up to and including 250 percent of the authorized bandwidth: At least 35 dB; and
- (3) On any frequency removed from the assigned frequency by more than 250 percent of the authorized bandwidth: At least 43 plus 10log₁₀ (mean power in watts) dB.

[RSS-182, SECTIONS 7.3, 7.9.1 & 7.9.2]
RSS-182, Section 7.3:

- (e) the authorized channel bandwidth for voice shall be 16 kHz; and
- (f) the authorized channel bandwidth for data shall be 20 kHz.

RSS-182, Section 7.9.1 Emission Mask B for Equipment with 25 kHz Channel Spacing

This mask is for FM or PM modulation equipment with 25 kHz channel spacing, an authorized bandwidth of 16 kHz for voice or 20 kHz for data, and equipped with or without an audio low-pass filter. The power of any emission shall be attenuated below the transmitter output power (P, in dBW) as follows:

- (a) on any frequency removed from the carrier frequency by more than 50%, but not more than 100% of the authorized bandwidth: at least 25 dB, measured with a bandwidth of 300 Hz;
- (b) on any frequency removed from the carrier frequency by more than 100%, but not more than 250% of the authorized bandwidth: at least 35 dB, measured with a bandwidth of 300 Hz; and
- (c) on any frequency removed from the carrier frequency by more than 250% of the authorized bandwidth: at least 43 + 10 log₁₀ p(watts) dB, measured with a bandwidth of 30 kHz.

RSS-182, Section 7.9.2 Emission Mask C for equipment with 12.5 kHz Channel Spacing

This mask is for equipment with channel spacing of 12.5 kHz, an authorized bandwidth of 11.25 kHz, equipped with or without an audio low-pass filter. The power of any emission shall be attenuated below the transmitter power (P, in dBW) as follows:

- (a) on any frequency removed from the carrier frequency f_c up to a displacement frequency of 5.625 kHz: 0 dB, measured with a bandwidth of 100 Hz;

ULTRATECH GROUP OF LABS

3000 Bristol Circle, Oakville, Ontario, Canada L6H 6G4
Tel. #: 905-829-1570, Fax. #: 905-829-8050, Email: vic@ultratech-labs.com, Website: <http://www.ultratech-labs.com>

File #: 20ICOM-524_F80RSS182
May 6, 2020

(b) on any frequency removed from the carrier frequency by a displacement frequency (f_d in kHz) of more than 5.625 kHz, but no more than 12.5 kHz: at least $7.27 (f_d - 2.88 \text{ kHz}) \text{ dB}$, measured with a bandwidth of 100 Hz; and

(c) on any frequency removed from the carrier frequency by a displacement frequency (f_d in kHz) of more than 12.5 kHz: at least $50 + 10 \log_{10} p(\text{watts}) \text{ dB}$ or 70 dB, whichever is the lesser attenuation, measured with a bandwidth of 100 Hz for a displacement frequency of more than 12.5 kHz, but no more than 50 kHz, and measured with a bandwidth of 10 kHz for a displacement frequency of more than 50 kHz.

5.4.2. Method of Measurements

Refer to Section 8.4 of this report for measurement details

5.4.3. Test Data

5.4.3.1. 99% Occupied Bandwidth

Remark: 99% Occupied Bandwidth measurements were done using the built-in auto function of the analyzer.

Frequency (MHz)	Channel Spacing (kHz)	Measured 99% OBW (kHz)	Authorized Bandwidth (kHz)
156.050	25	14.87	16*/20
157.425	25	14.93	16*/20
DSC (1300 Hz)156.525	25	8.01	16*/20
DSC (2100 Hz)156.525	25	12.84	16*/20

*RSS 182 voice limit
See the following plots for details of measurements.

5.4.3.2. Configuration: 99% OBW, CH 1001 156.050MHz, 25 KHz, High power
OBW: 14.87 KHz

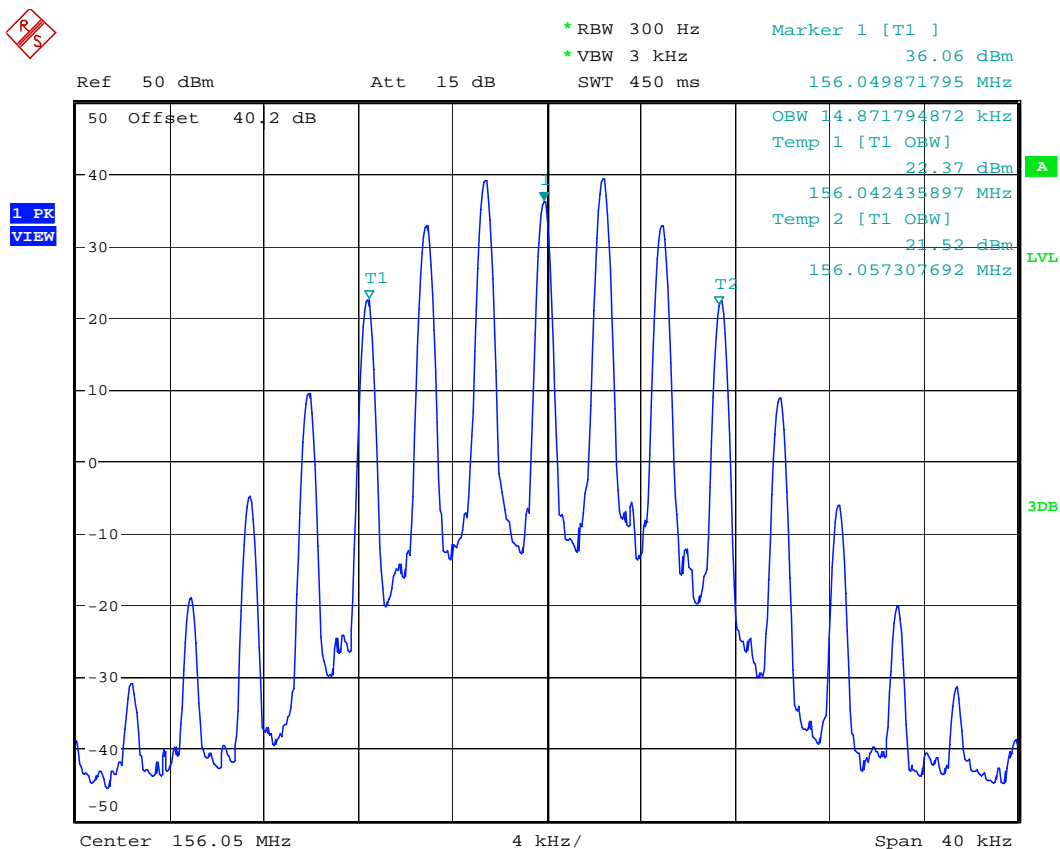

Date: 20.APR.2020 09:54:45

5.4.3.3. Configuration: 99% OBW, CH 88 157.425MHz, 25 KHz, High power
OBW: 14.93 KHz

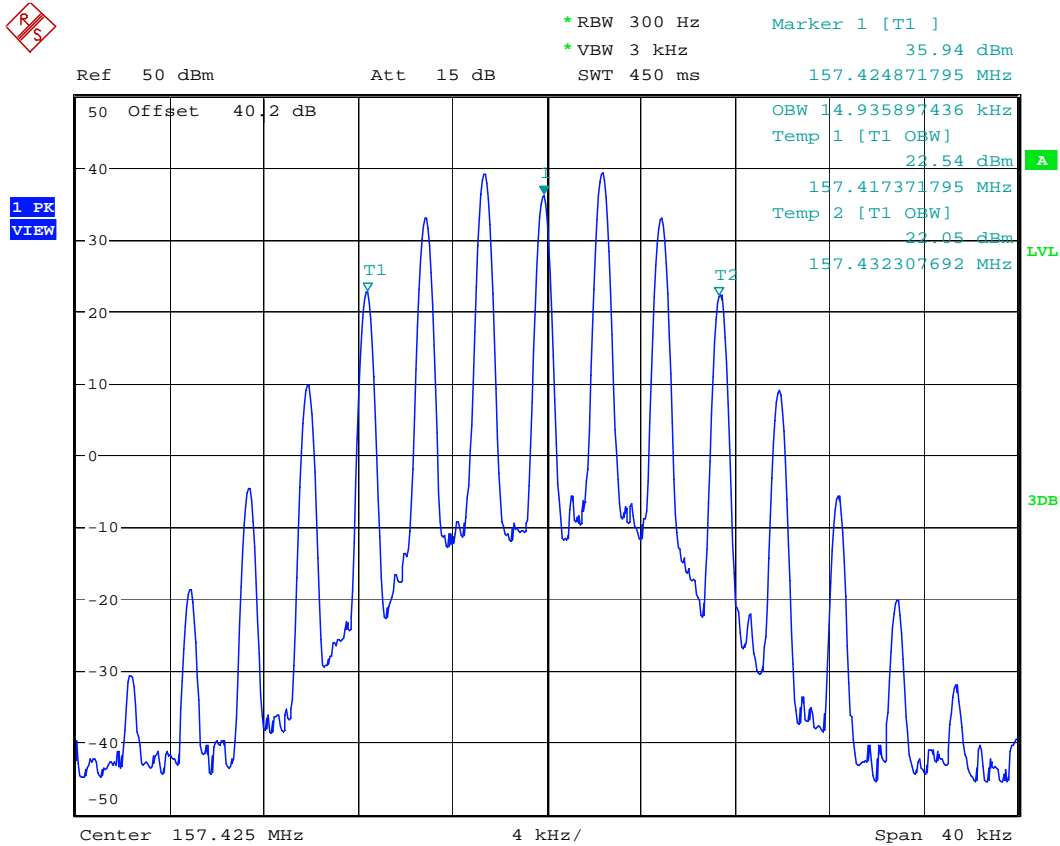

Date: 20.APR.2020 09:56:25

5.4.3.4. Configuration: 99% OBW, CH 70 (DSC 1300Hz) 156.525MHz, 25 KHz, High power
 OBW: 8.01 KHz

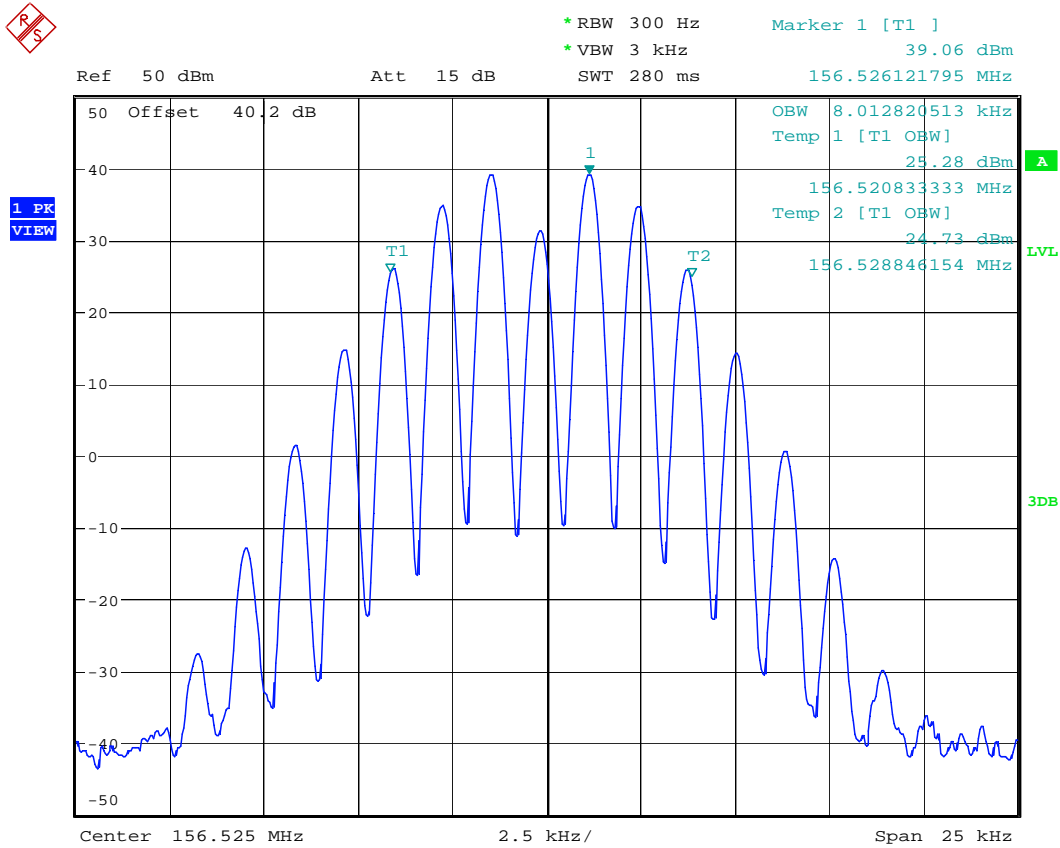

Date: 20.APR.2020 09:58:40

5.4.3.5. Configuration: 99% OBW, CH 70 (DSC 2100Hz) 156.525MHz, 25 KHz, High power
OBW: 12.84 KHz

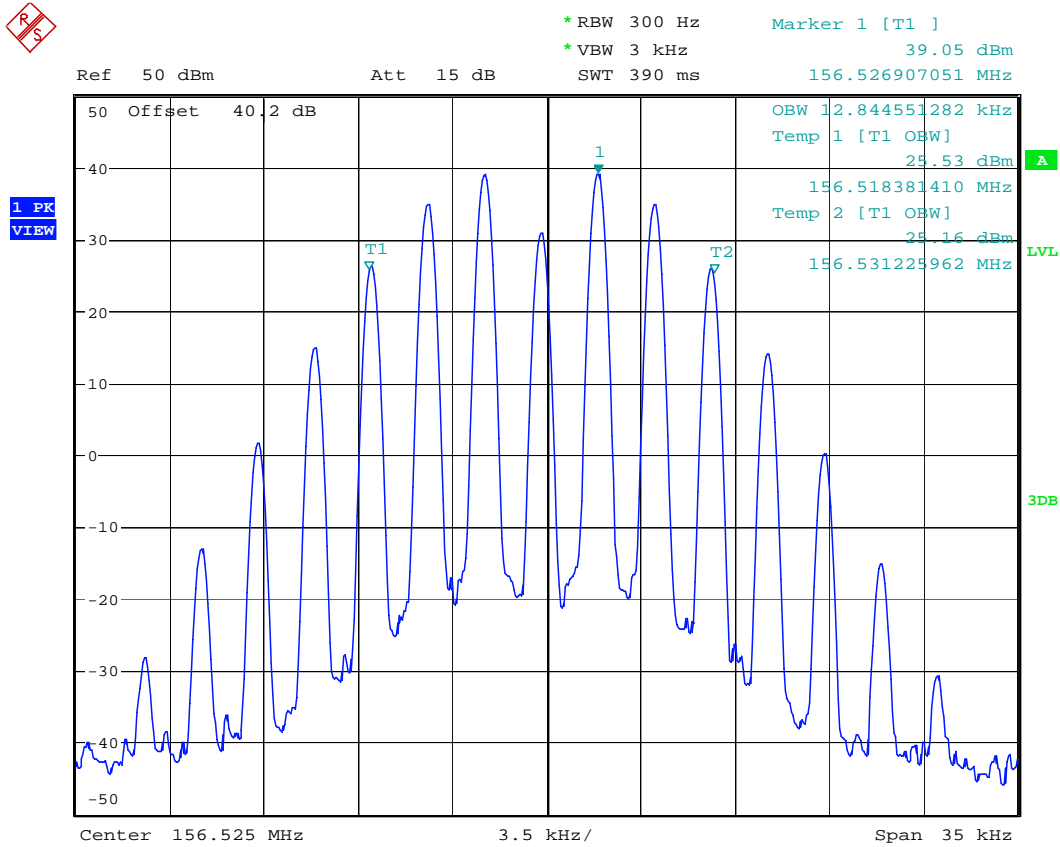

Date: 20.APR.2020 10:00:25

EMISSION MASKS- MASK B High Power*

5.4.3.6. Configuration: Mask B, CH 1001 156.050MHz, 25 KHz, High power

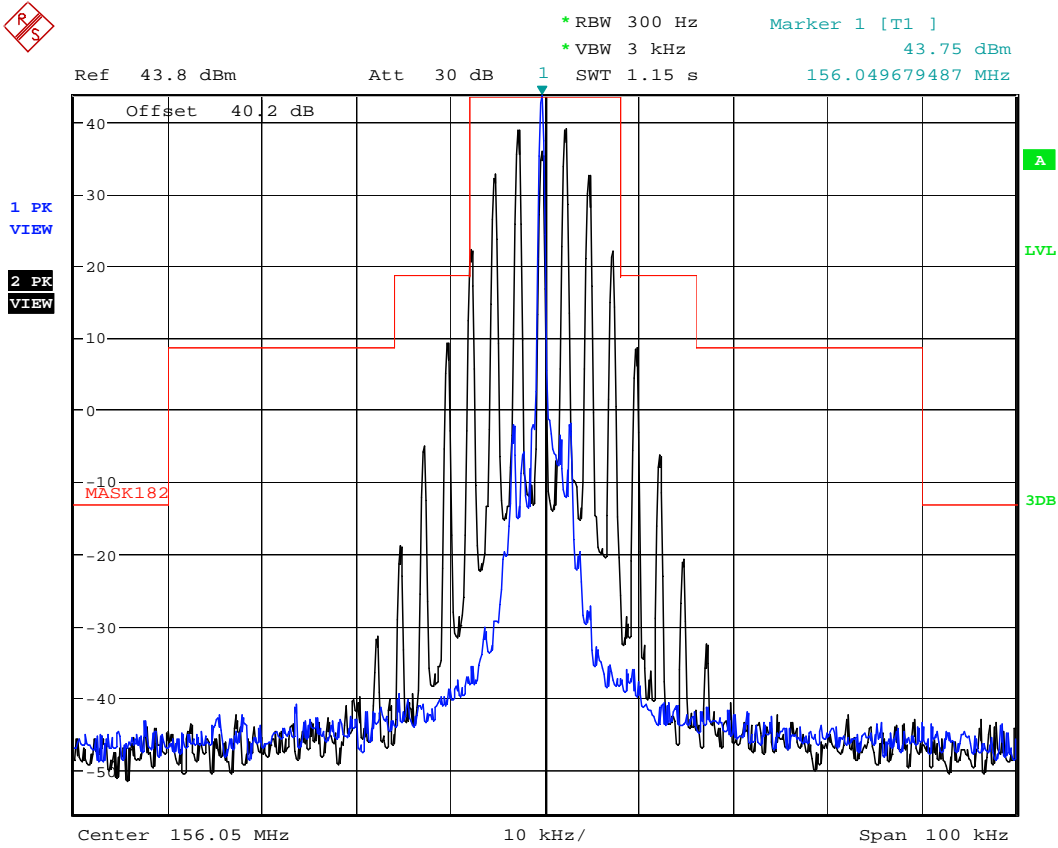

Date: 20.APR.2020 10:32:08

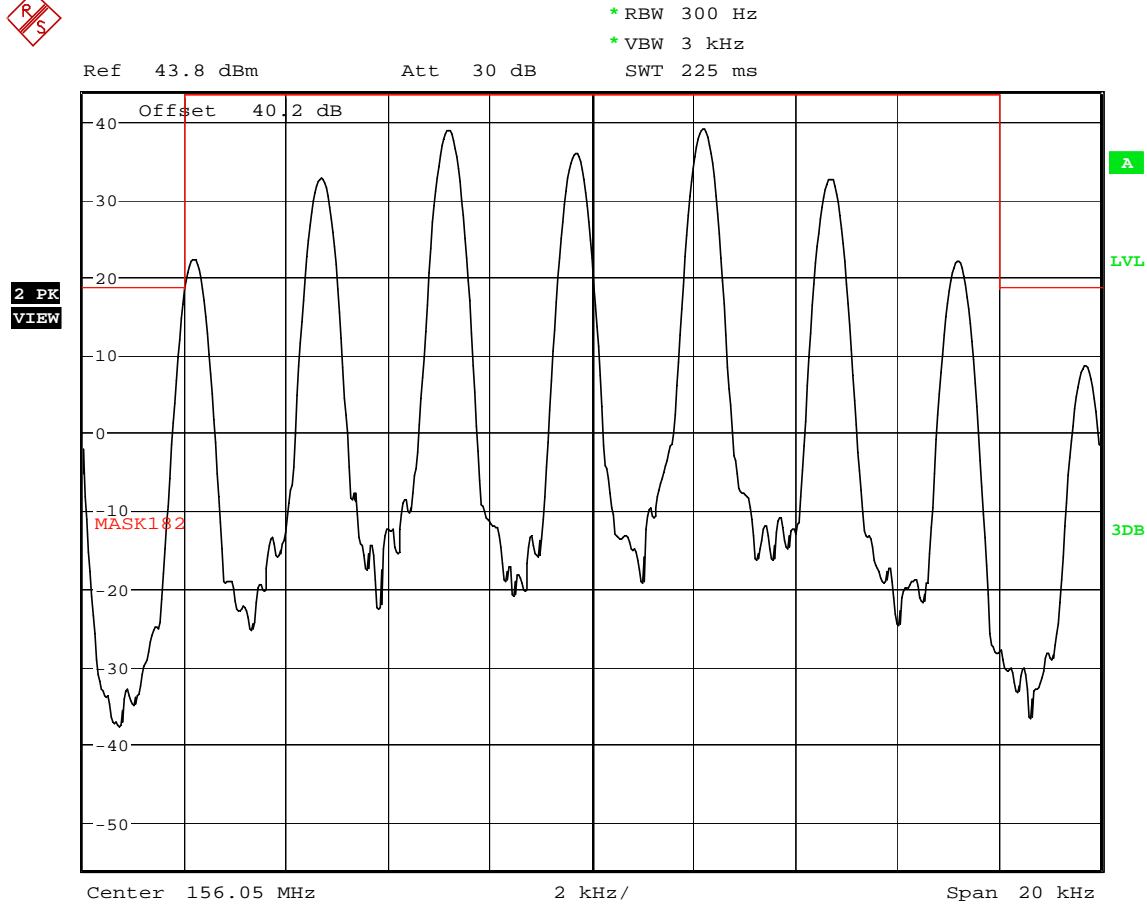

Date: 20.APR.2020 10:32:58

ULTRATECH GROUP OF LABS

3000 Bristol Circle, Oakville, Ontario, Canada L6H 6G4
Tel. #: 905-829-1570, Fax. #: 905-829-8050, Email: vic@ultratech-labs.com, Website: <http://www.ultratech-labs.com>

File #: 20ICOM-524_F80RSS182

May 6, 2020

All test results contained in this engineering test report are traceable to National Institute of Standards and Technology (NIST)

5.4.3.7. Configuration: Mask B, CH 88 157.425MHz, 25 KHz, High power

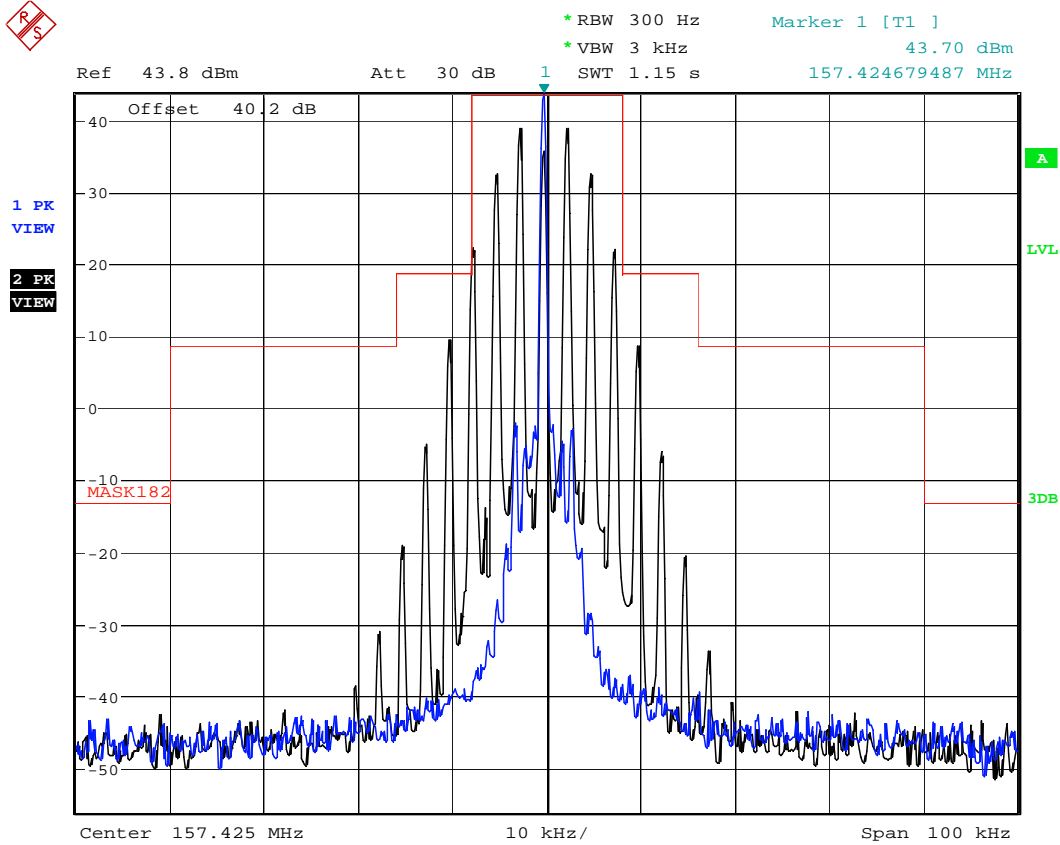

Date: 20.APR.2020 10:35:35

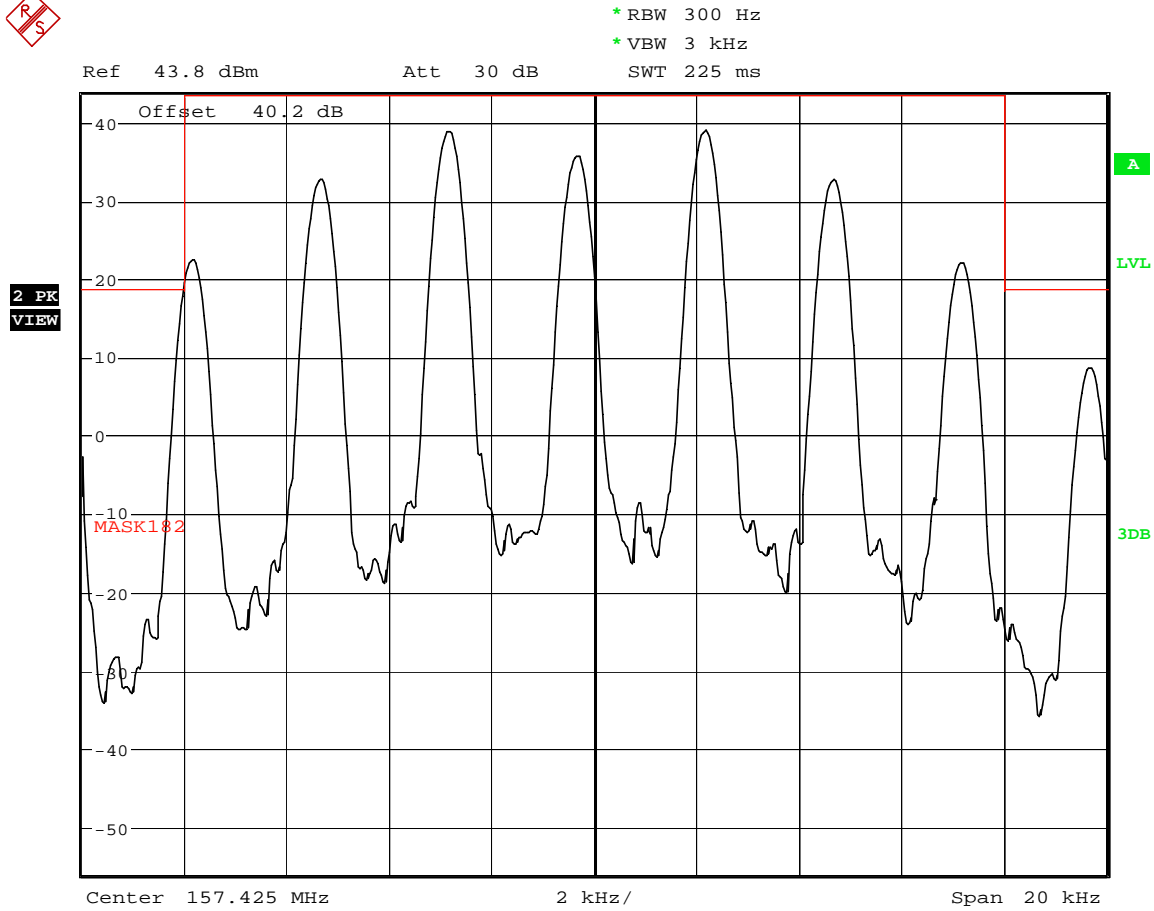

Date: 20.APR.2020 10:39:16

ULTRATECH GROUP OF LABS

3000 Bristol Circle, Oakville, Ontario, Canada L6H 6G4
Tel. #: 905-829-1570, Fax. #: 905-829-8050, Email: vic@ultratech-labs.com, Website: <http://www.ultratech-labs.com>

File #: 20ICOM-524_F80RSS182

May 6, 2020

All test results contained in this engineering test report are traceable to National Institute of Standards and Technology (NIST)

5.4.3.8. Configuration: Mask B, CH 70 (DSC 1300Hz) 156.525MHz, 25 KHz, High power

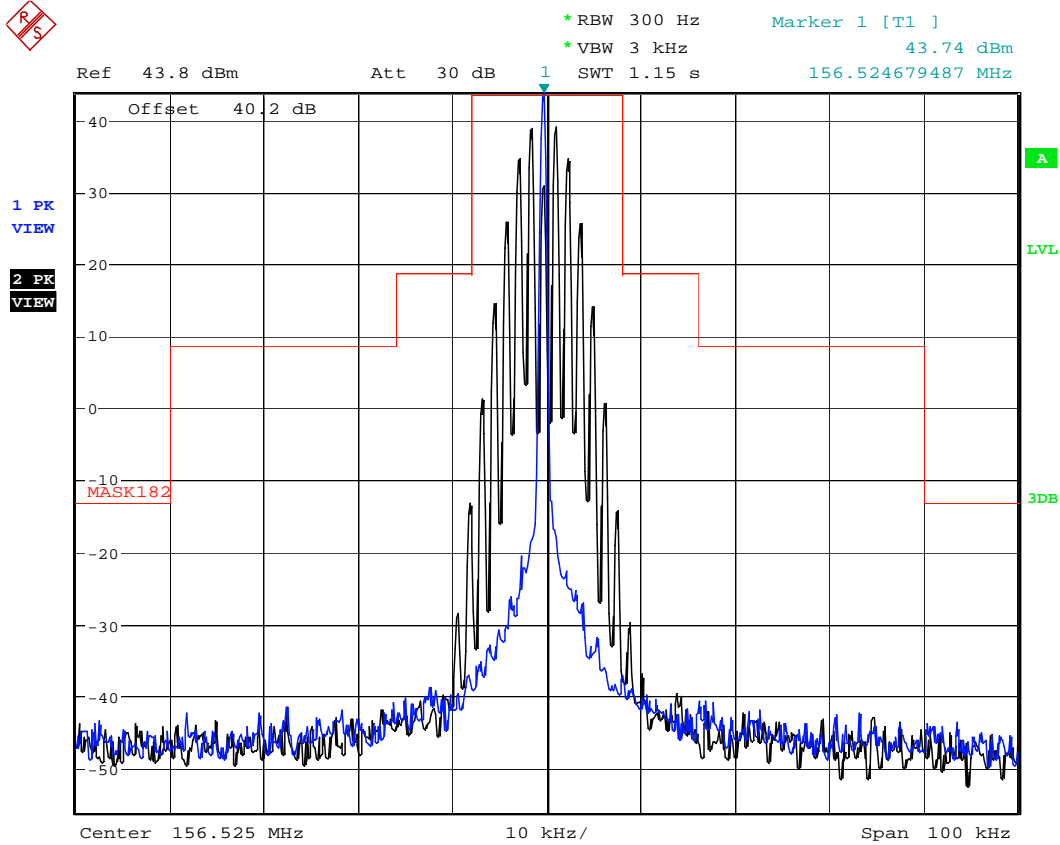

Date: 20.APR.2020 11:08:41

5.4.3.9. Configuration: Mask B, CH 70 (DSC 2100Hz) 156.525MHz, 25 KHz, High power

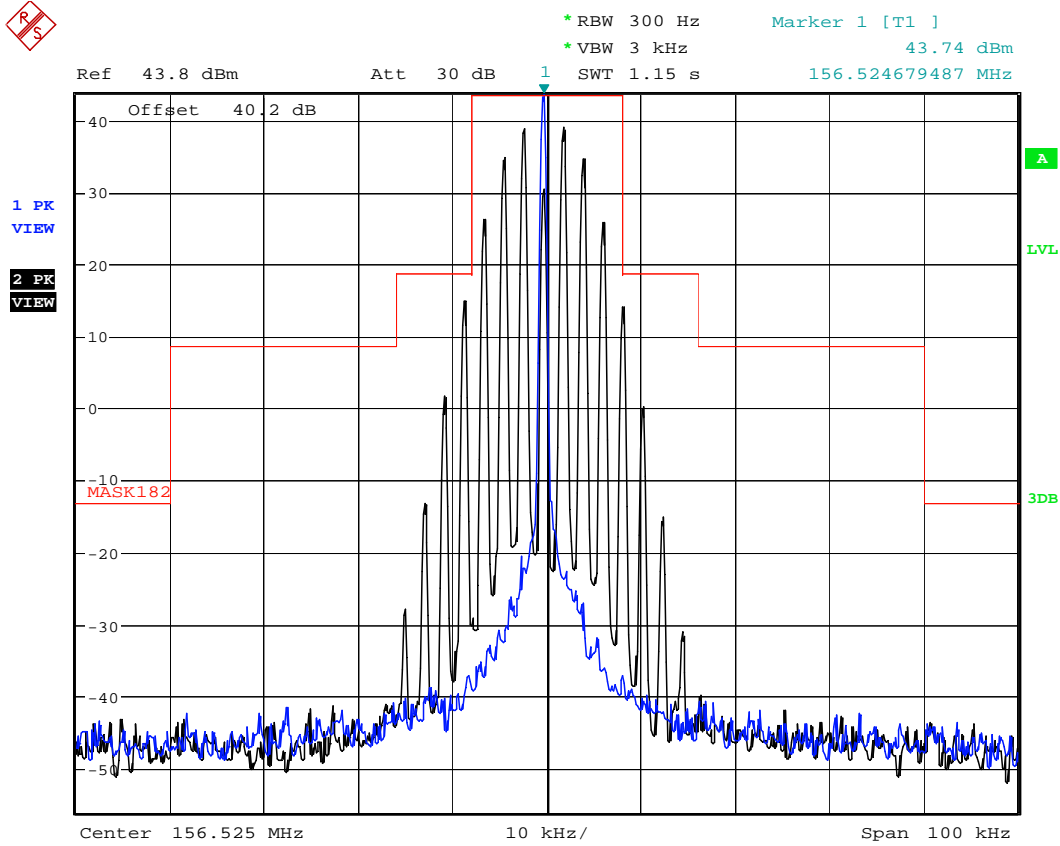

Date: 20.APR.2020 11:09:20

Low Power

5.4.3.10. Configuration: Mask B, CH 01A 156.050MHz, 25 KHz, Low power

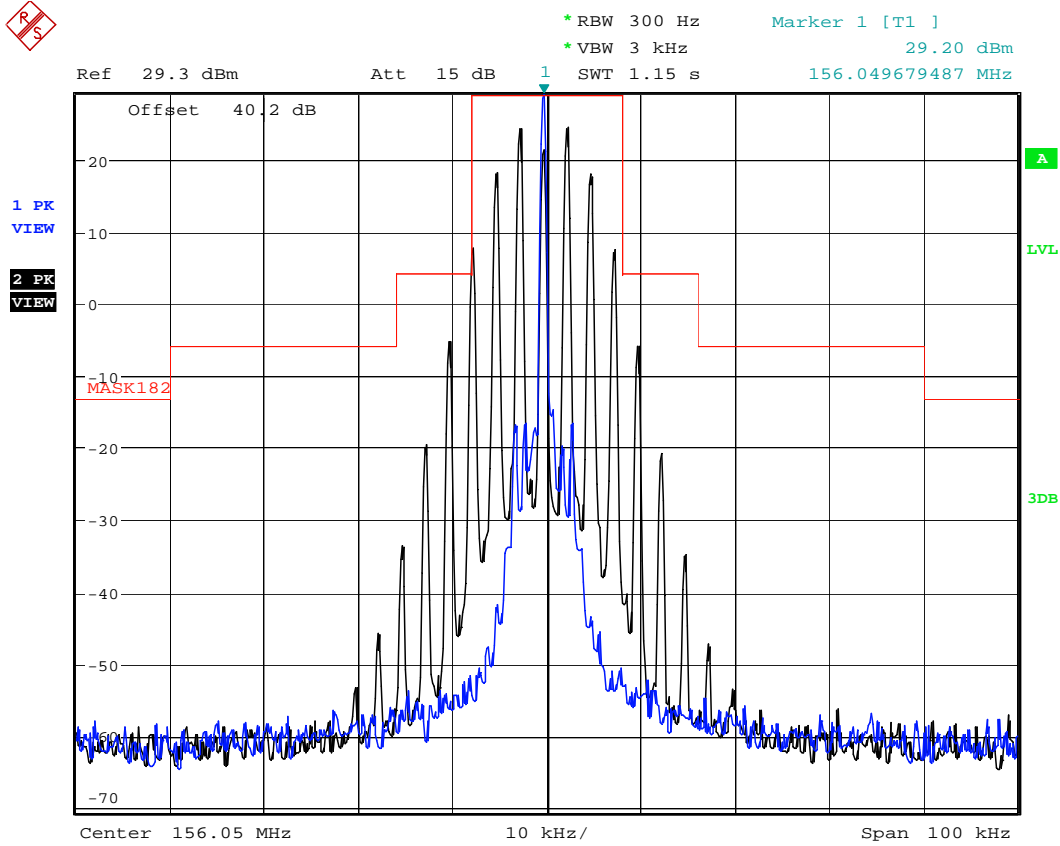

Date: 20.APR.2020 11:23:51

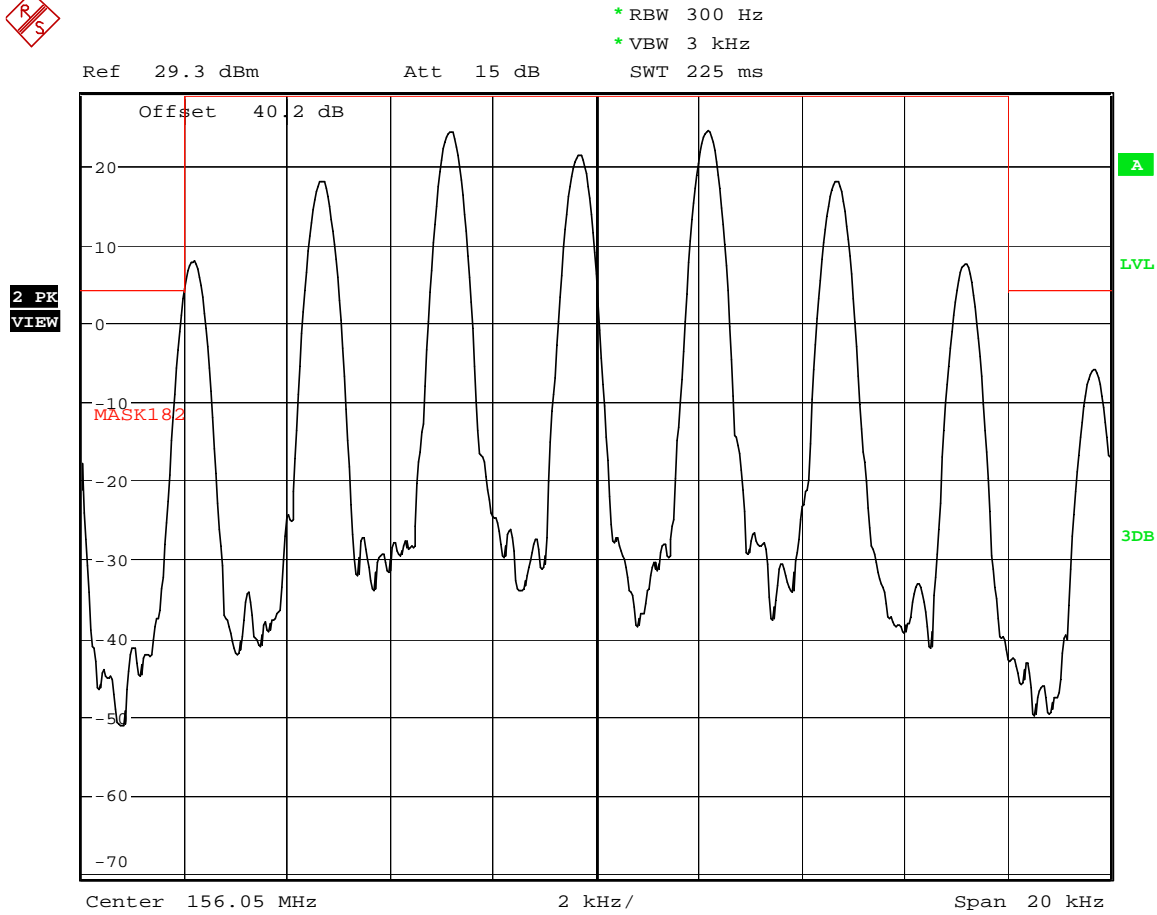

Date: 20.APR.2020 11:24:25

ULTRATECH GROUP OF LABS

3000 Bristol Circle, Oakville, Ontario, Canada L6H 6G4
Tel. #: 905-829-1570, Fax. #: 905-829-8050, Email: vic@ultratech-labs.com, Website: <http://www.ultratech-labs.com>

File #: 20ICOM-524_F80RSS182

May 6, 2020

All test results contained in this engineering test report are traceable to National Institute of Standards and Technology (NIST)

5.4.3.11. Configuration: Mask B, CH 88 157.425MHz, 25 KHz, Low power

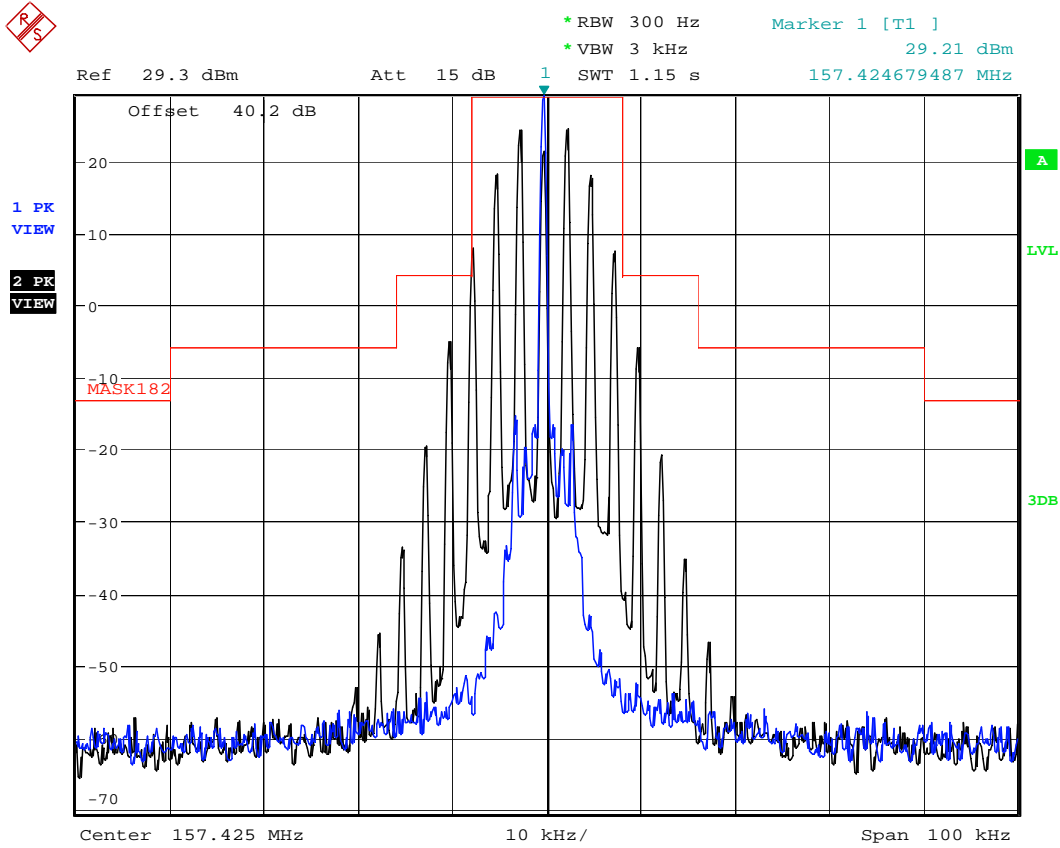

Date: 20.APR.2020 11:26:42

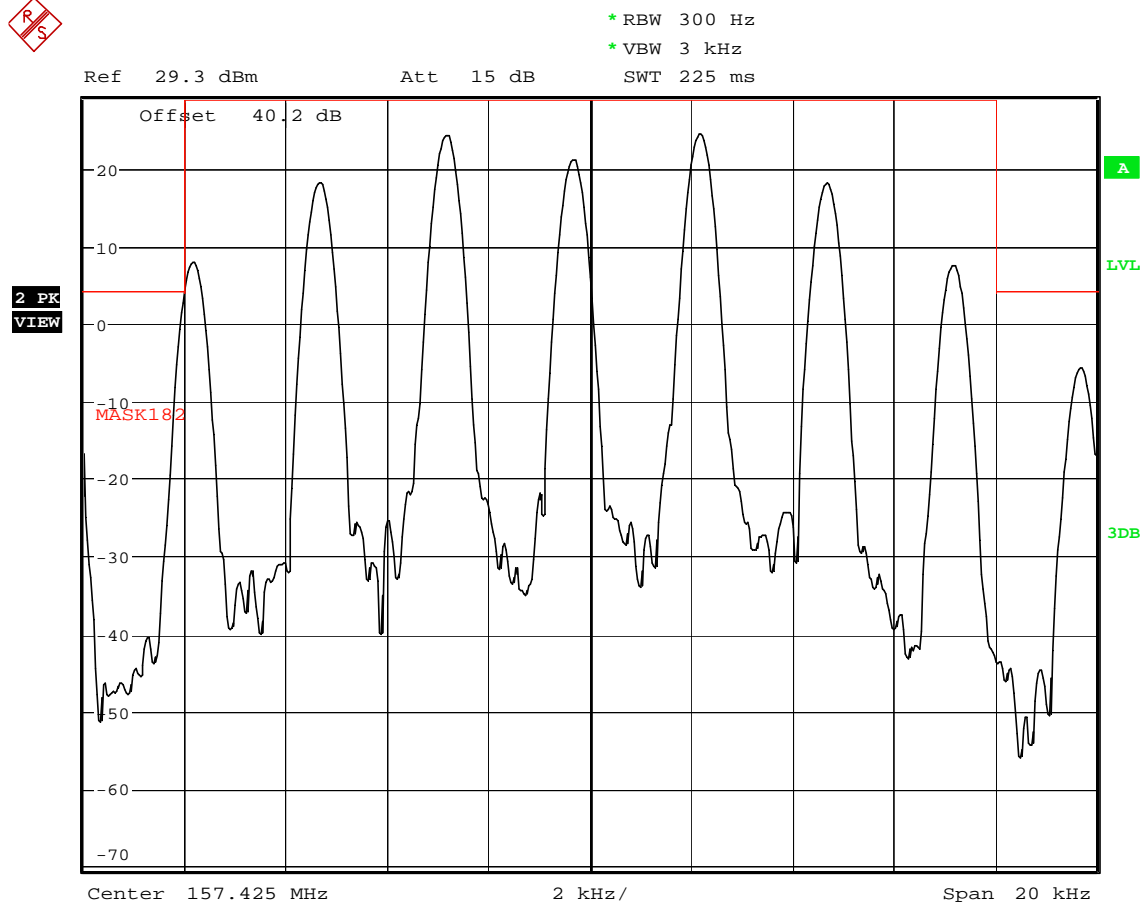

Date: 20.APR.2020 11:27:23

ULTRATECH GROUP OF LABS

3000 Bristol Circle, Oakville, Ontario, Canada L6H 6G4
Tel. #: 905-829-1570, Fax. #: 905-829-8050, Email: vic@ultratech-labs.com, Website: <http://www.ultratech-labs.com>

File #: 20ICOM-524_F80RSS182
May 6, 2020

All test results contained in this engineering test report are traceable to National Institute of Standards and Technology (NIST)

5.4.3.12. Configuration: Mask B, CH 70 (DSC 1300Hz) 156.525MHz, 25 KHz, Low power

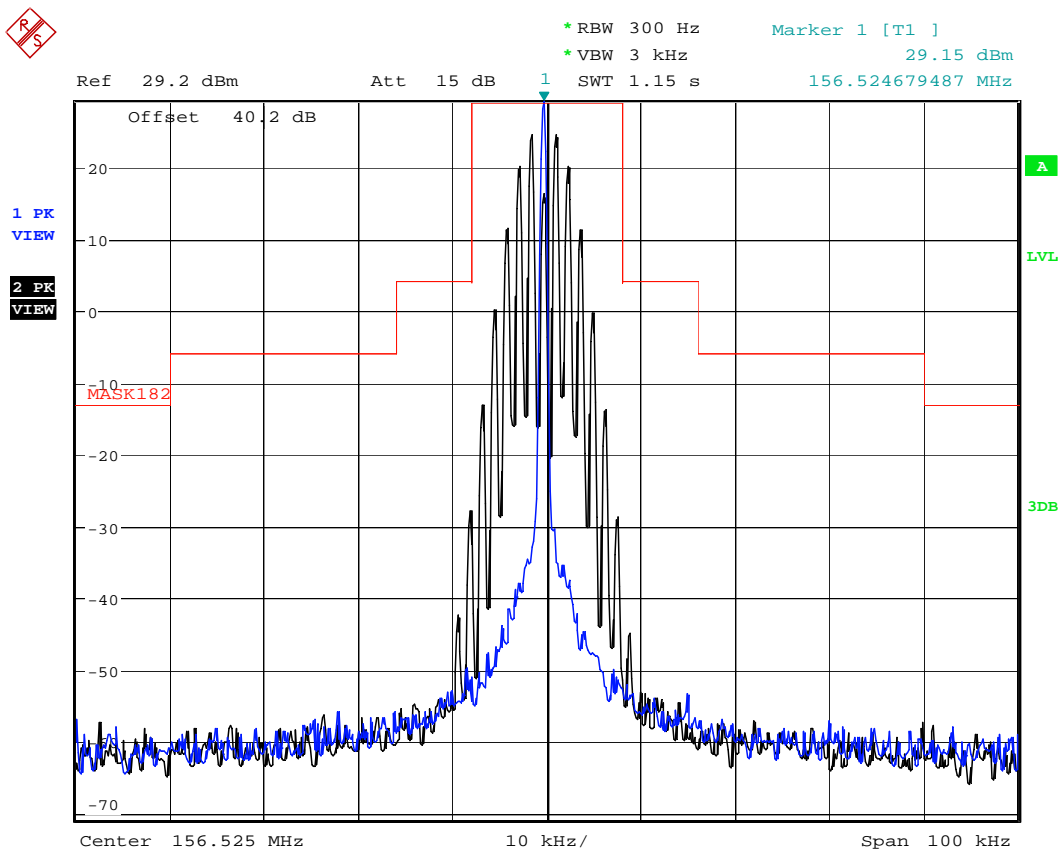

Date: 20.APR.2020 11:13:37

5.4.3.13. Configuration: Mask B, CH 70 (DSC 2100Hz) 156.525MHz, 25 KHz, Low power

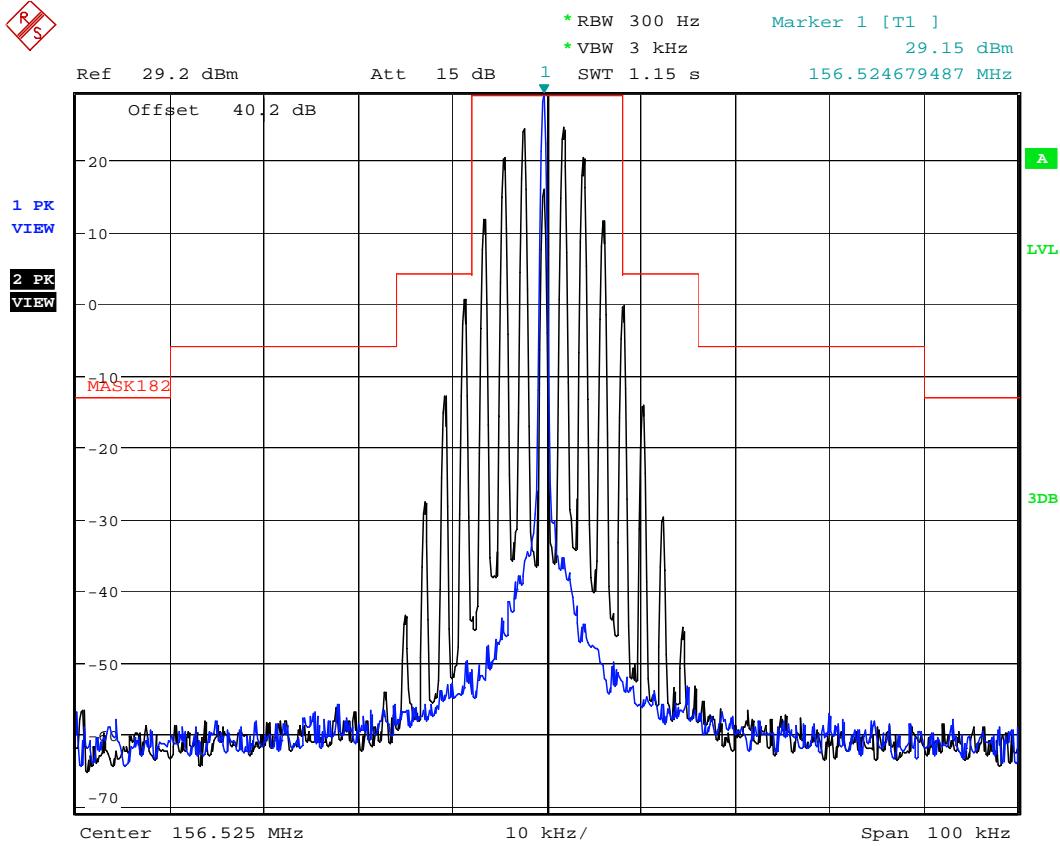

Date: 20.APR.2020 11:14:23

5.5. TRANSMITTER ANTENNA POWER SPURIOUS/HARMONIC CONDUCTED EMISSIONS [§80.211(f)(3)] [RSS-182, SECTION 7.9]

5.5.1. Limits

§ 80.211 (f)(3) On any frequency removed from the assigned frequency by more than 250 percent of the authorized bandwidth: At least 43 plus 10log10 (mean power in watts) dB.

[RSS-182, SECTION 7.9]

Equipment with 25 kHz channel spacing (equipment designator G and D) shall comply with emission mask B. Radio equipment with 12.5 kHz channel spacing, with or without an audio low-pass filter, shall comply with emission mask C.

5.5.2. Method of Measurements

Refer to Section 8.5 of this report for measurement details

5.5.3. Test Data

5.5.3.1. Configuration: Tx Conducted, CH 1001 156.050MHz, 25 KHz, High power

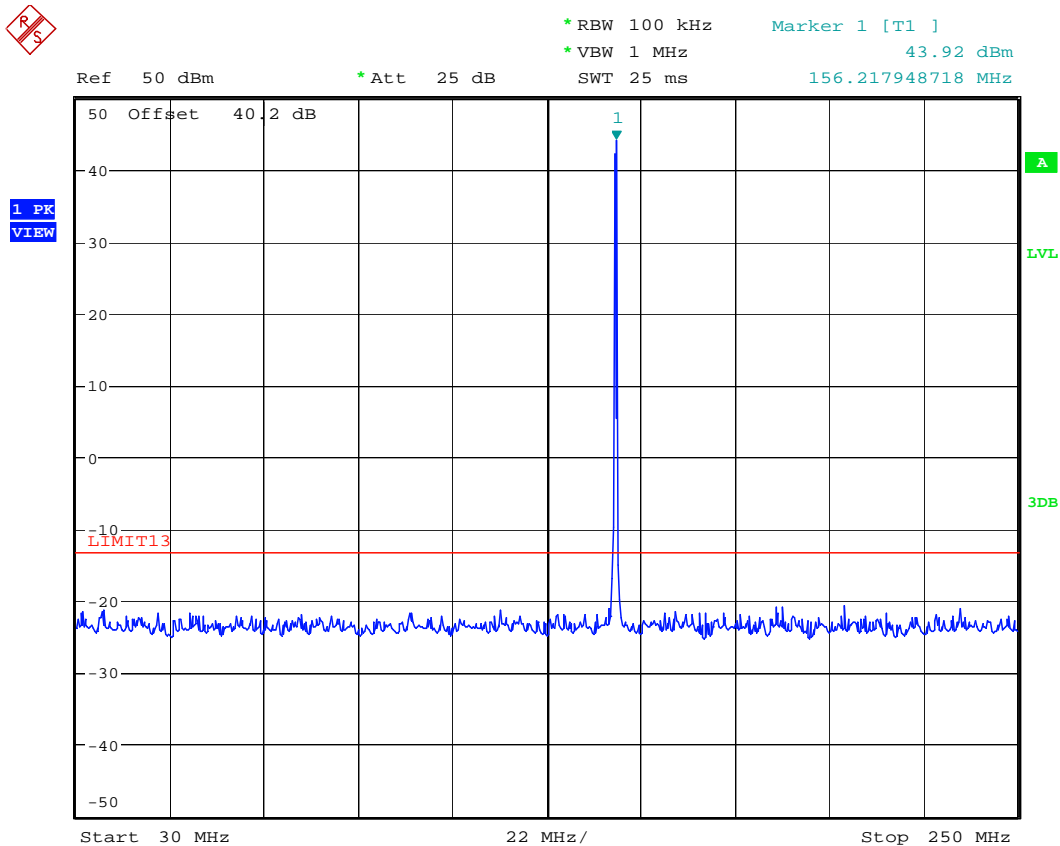

Date: 21.APR.2020 14:51:01

ULTRATECH GROUP OF LABS

3000 Bristol Circle, Oakville, Ontario, Canada L6H 6G4
Tel. #: 905-829-1570, Fax. #: 905-829-8050, Email: vic@ultratech-labs.com, Website: <http://www.ultratech-labs.com>

File #: 20ICOM-524_F80RSS182

May 6, 2020

All test results contained in this engineering test report are traceable to National Institute of Standards and Technology (NIST)

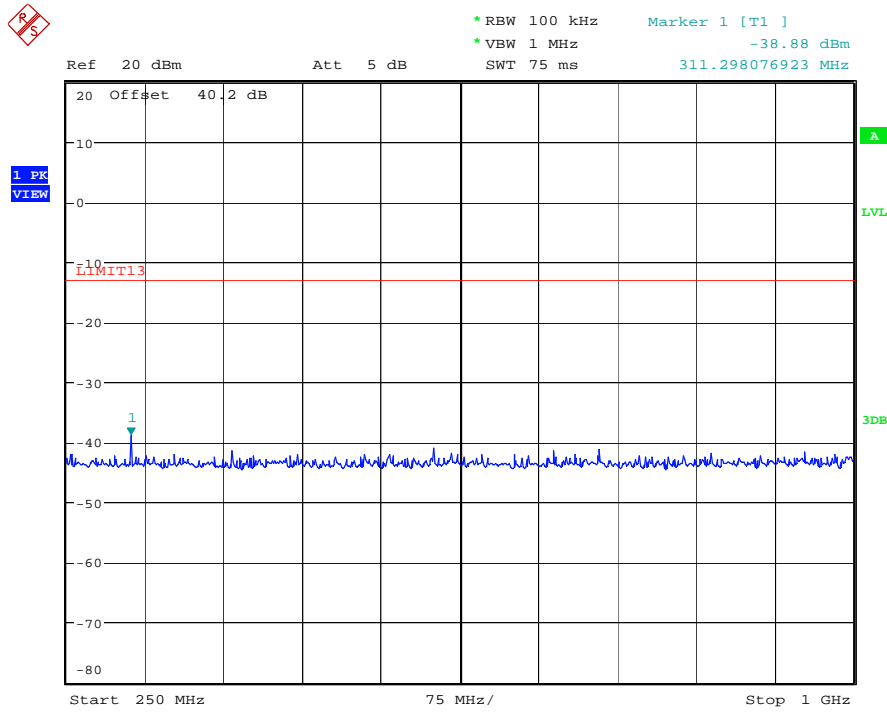

Date: 21.APR.2020 15:02:23

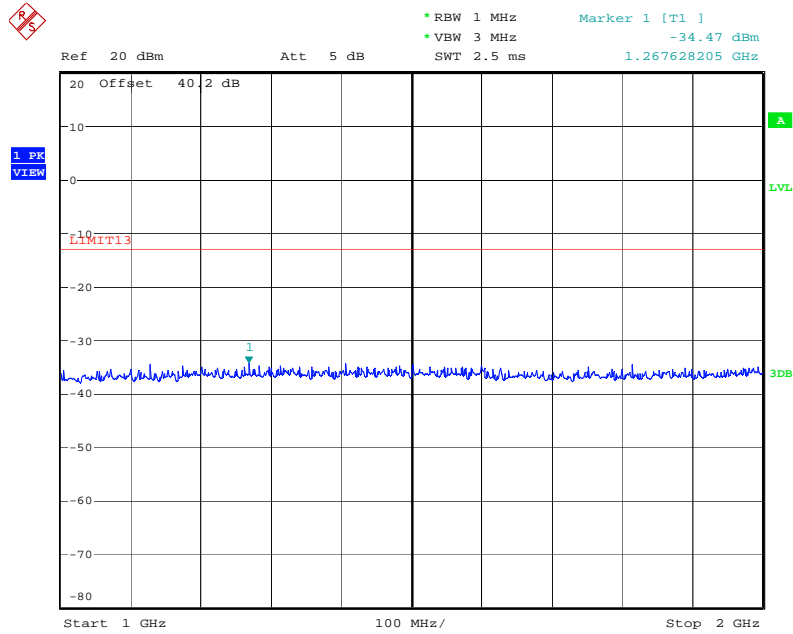

Date: 21.APR.2020 15:08:23

ULTRATECH GROUP OF LABS

3000 Bristol Circle, Oakville, Ontario, Canada L6H 6G4
 Tel. #: 905-829-1570, Fax. #: 905-829-8050, Email: vic@ultratech-labs.com, Website: <http://www.ultratech-labs.com>

File #: 20ICOM-524_F80RSS182

May 6, 2020

All test results contained in this engineering test report are traceable to National Institute of Standards and Technology (NIST)

5.5.3.2. Configuration: Tx Conducted, CH 88 157.425MHz, 25 KHz, High power

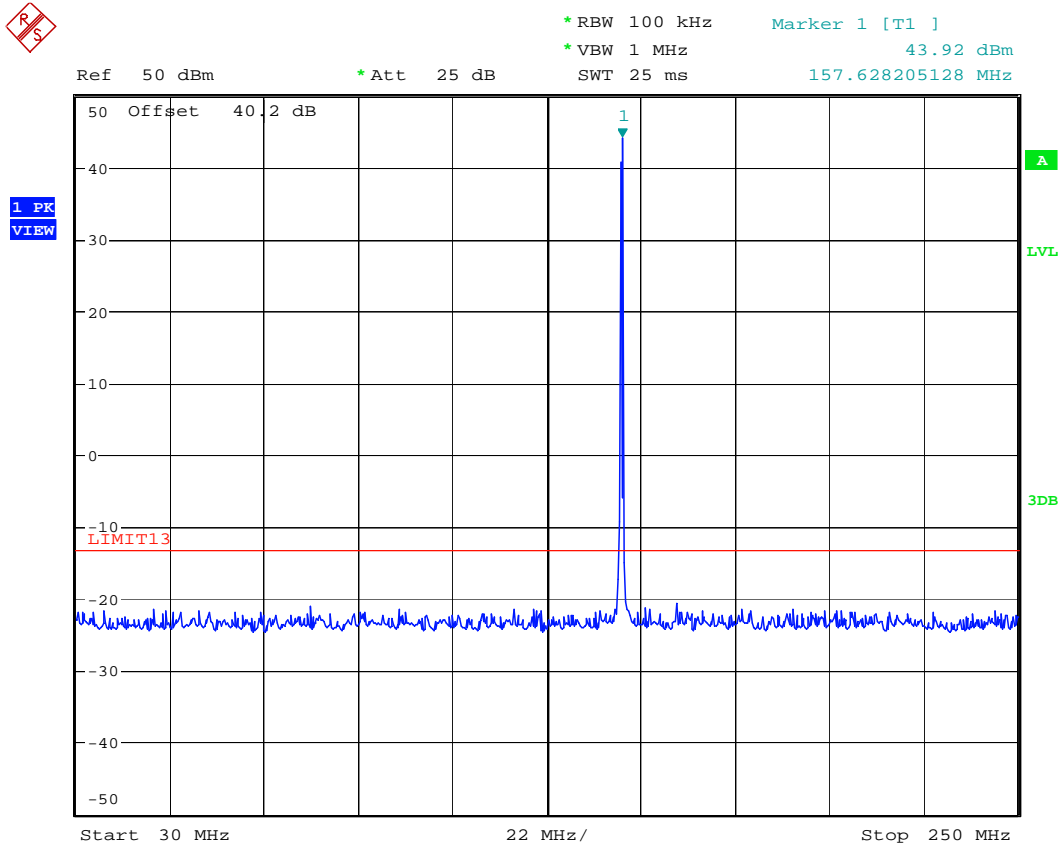

Date: 21.APR.2020 14:53:53

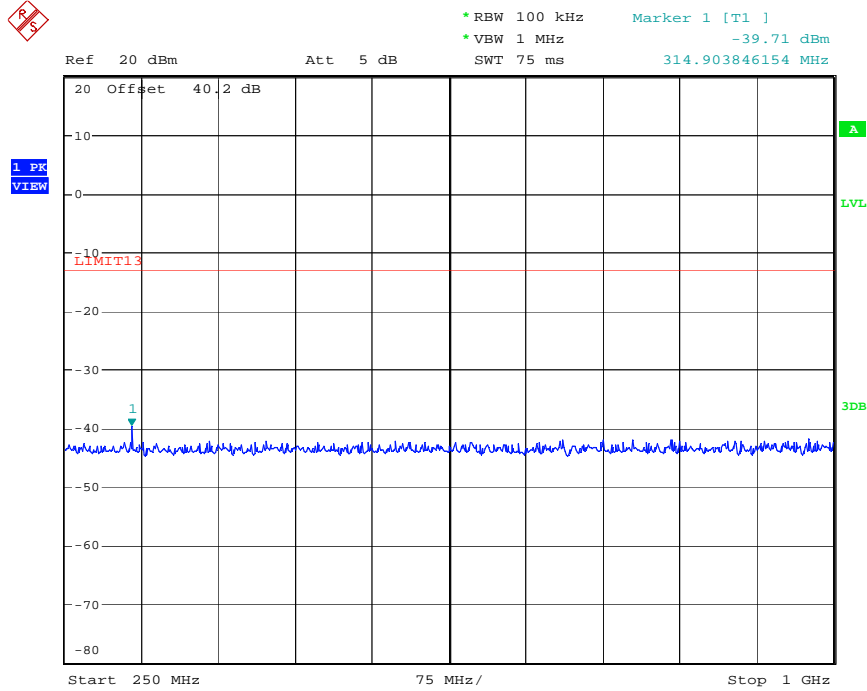

Date: 21.APR.2020 15:06:13

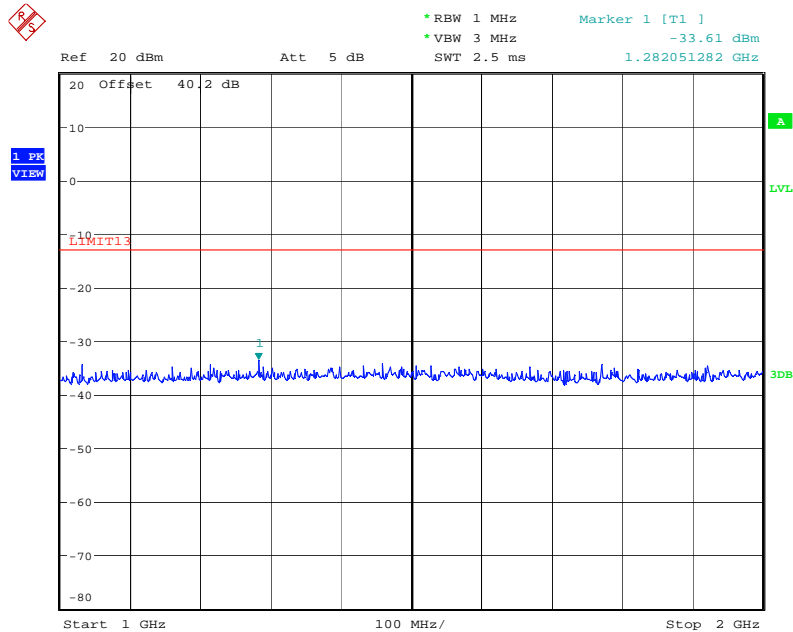

Date: 21.APR.2020 15:11:47

ULTRATECH GROUP OF LABS

3000 Bristol Circle, Oakville, Ontario, Canada L6H 6G4
Tel. #: 905-829-1570, Fax. #: 905-829-8050, Email: vic@ultratech-labs.com, Website: <http://www.ultratech-labs.com>

File #: 20ICOM-524_F80RSS182
May 6, 2020

All test results contained in this engineering test report are traceable to National Institute of Standards and Technology (NIST)

5.5.3.3. Configuration: Tx Conducted, CH 01A 156.050MHz, 25 KHz, Low power

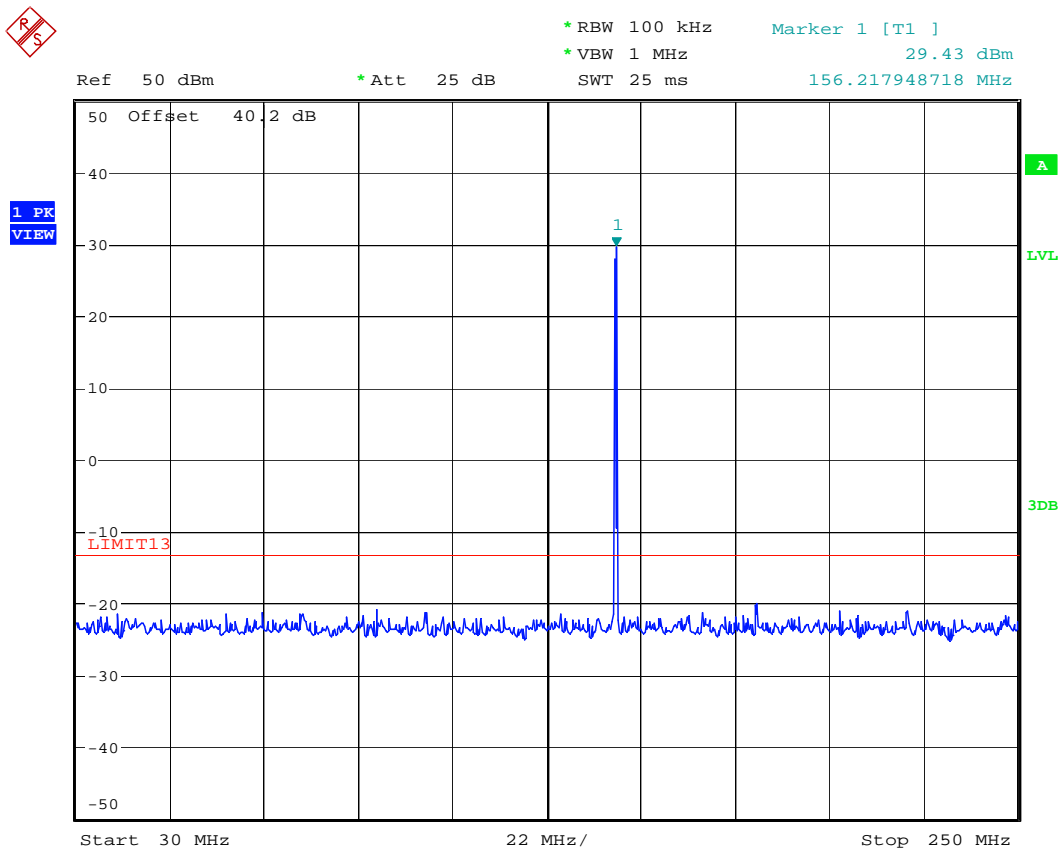

Date: 21.APR.2020 14:52:23

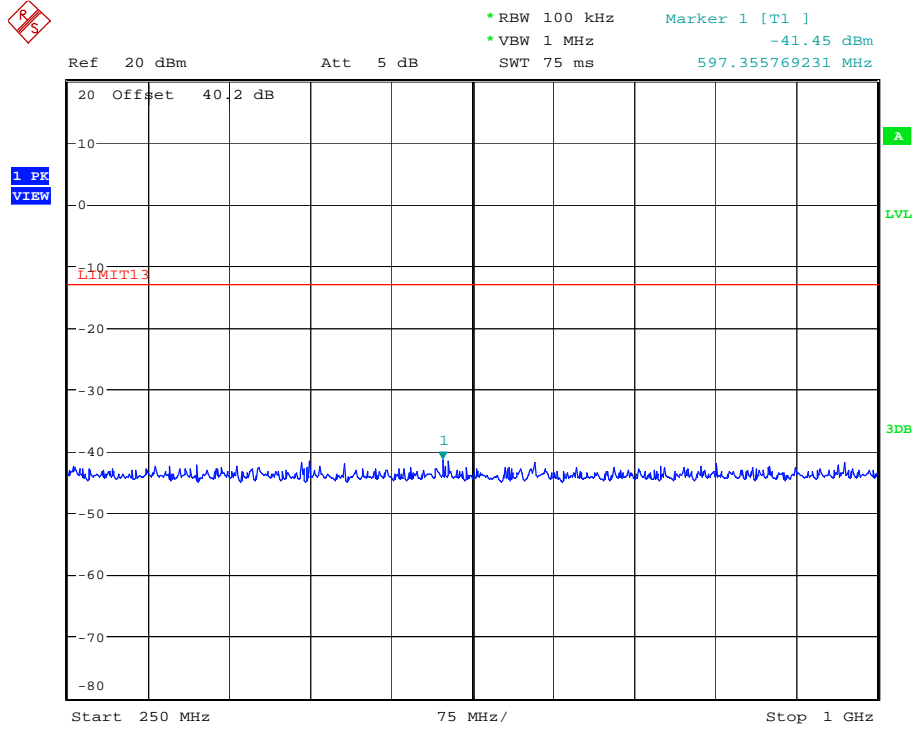

Date: 21.APR.2020 15:03:46

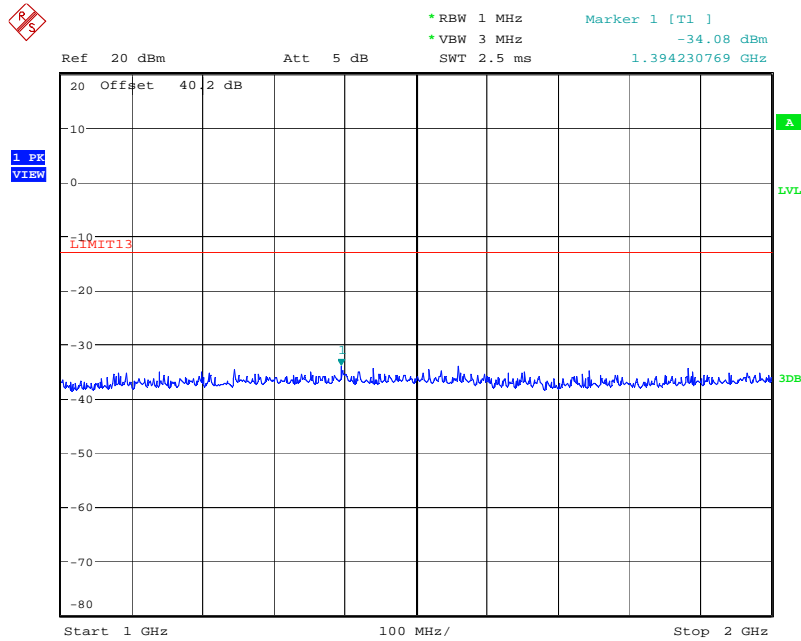

Date: 21.APR.2020 15:09:28

ULTRATECH GROUP OF LABS

3000 Bristol Circle, Oakville, Ontario, Canada L6H 6G4
Tel. #: 905-829-1570, Fax. #: 905-829-8050, Email: vic@ultratech-labs.com, Website: <http://www.ultratech-labs.com>

File #: 20ICOM-524_F80RSS182
May 6, 2020

All test results contained in this engineering test report are traceable to National Institute of Standards and Technology (NIST)

5.5.3.4. Configuration: Tx Conducted, CH 88 157.425MHz, 25 KHz, Low power

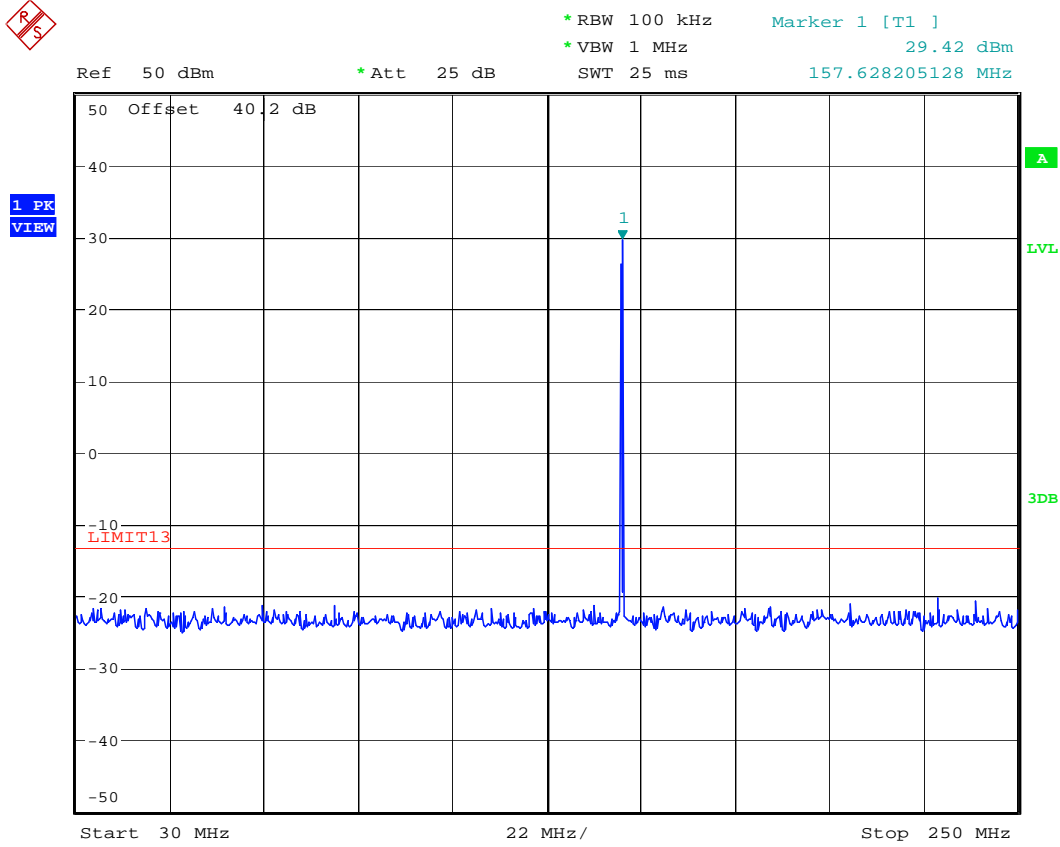

Date: 21.APR.2020 14:54:48

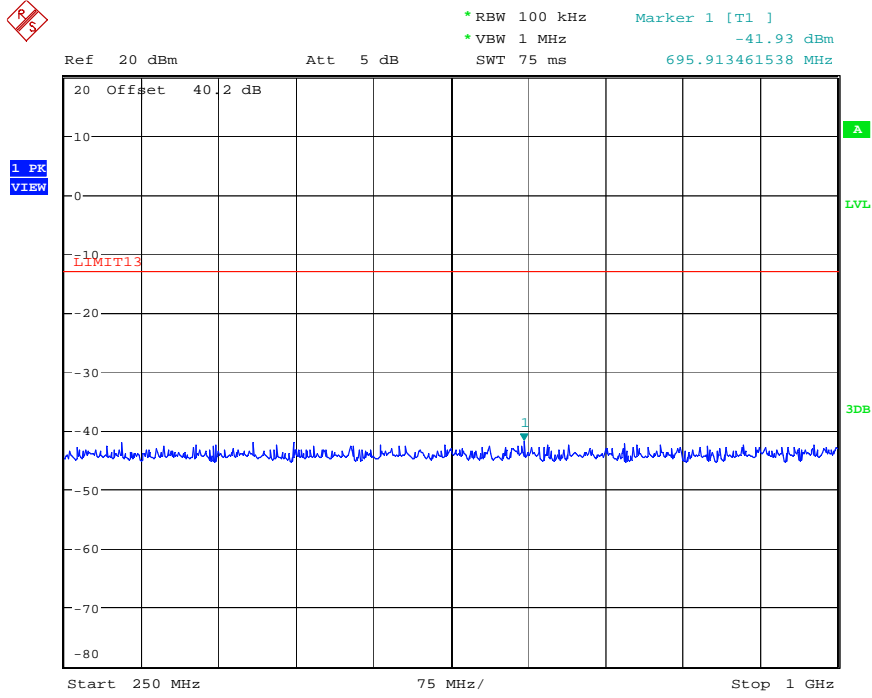

Date: 21.APR.2020 15:04:41

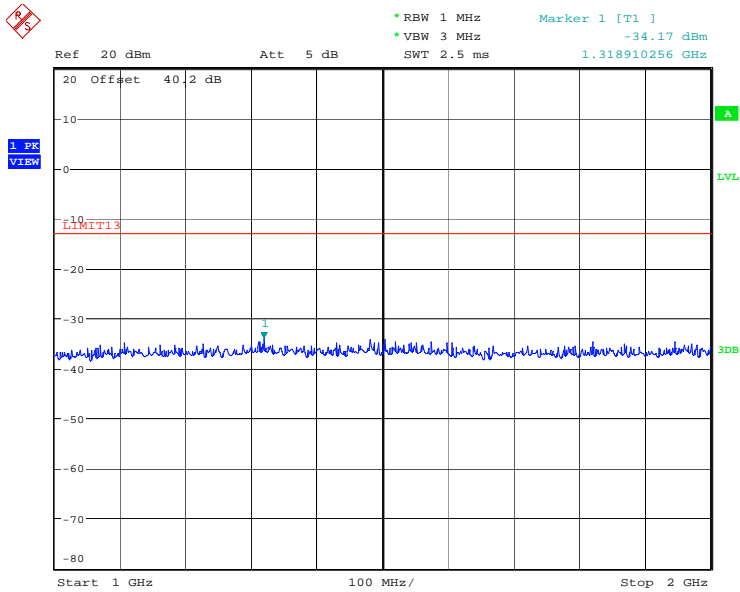

Date: 21.APR.2020 15:10:25

ULTRATECH GROUP OF LABS

3000 Bristol Circle, Oakville, Ontario, Canada L6H 6G4
Tel. #: 905-829-1570, Fax. #: 905-829-8050, Email: vic@ultratech-labs.com, Website: <http://www.ultratech-labs.com>

File #: 20ICOM-524_F80RSS182
May 6, 2020

All test results contained in this engineering test report are traceable to National Institute of Standards and Technology (NIST)

DSC

5.5.3.5. Configuration: Tx Conducted, CH 70(DSC 1300Hz) 156.525MHz, High power

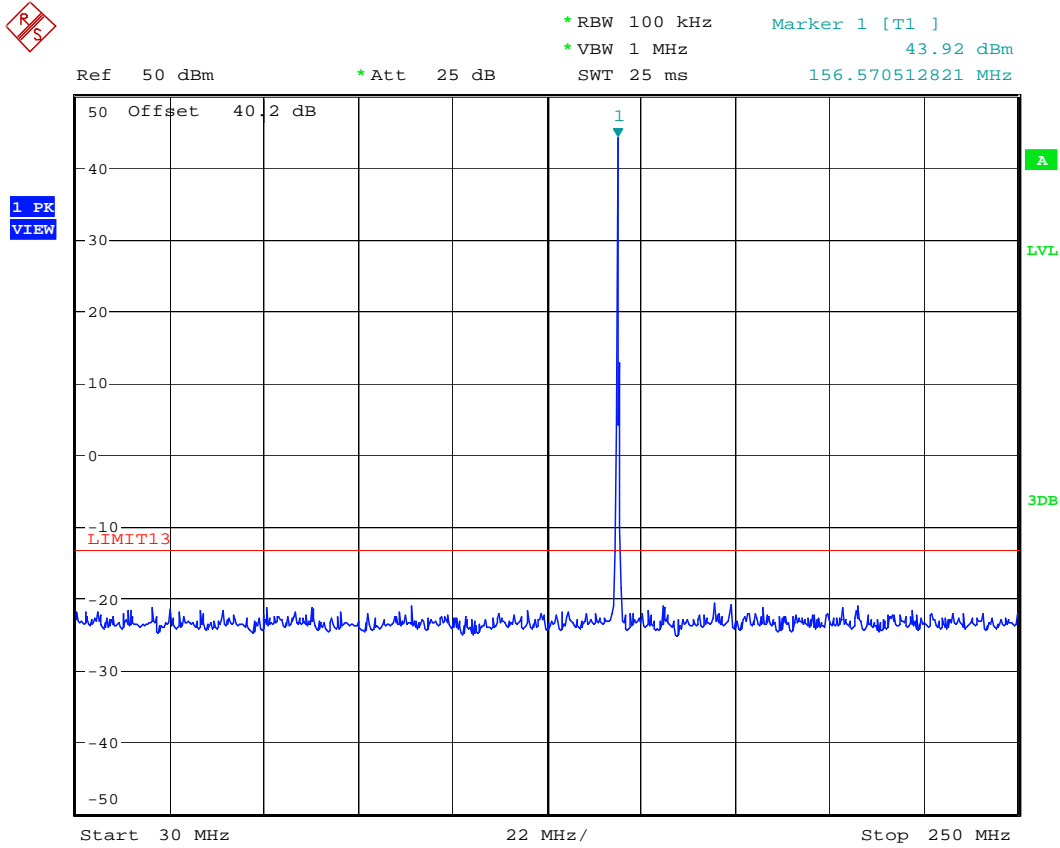

Date: 22.APR.2020 08:57:34

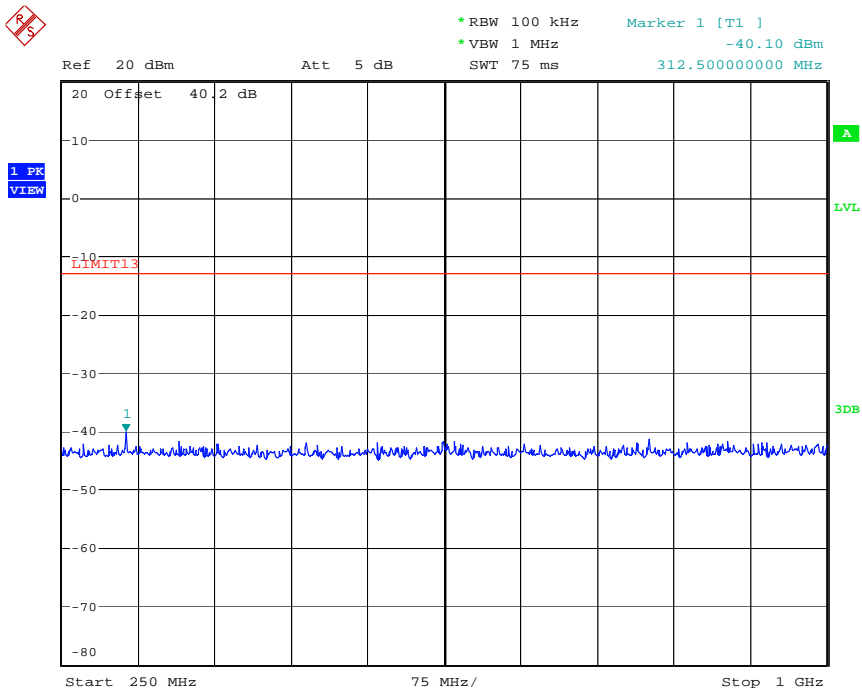

Date: 22.APR.2020 09:04:08

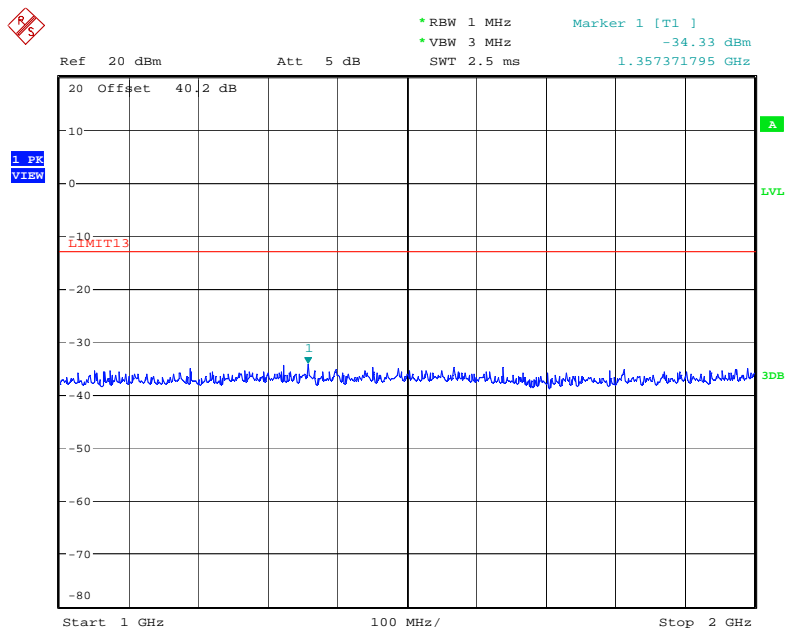

Date: 22.APR.2020 09:09:04

ULTRATECH GROUP OF LABS

3000 Bristol Circle, Oakville, Ontario, Canada L6H 6G4
 Tel. #: 905-829-1570, Fax. #: 905-829-8050, Email: vic@ultratech-labs.com, Website: <http://www.ultratech-labs.com>

File #: 20ICOM-524_F80RSS182
 May 6, 2020

All test results contained in this engineering test report are traceable to National Institute of Standards and Technology (NIST)

5.5.3.6. Configuration: Tx Conducted, CH 70(DSC 2100Hz) 156.525MHz, High power

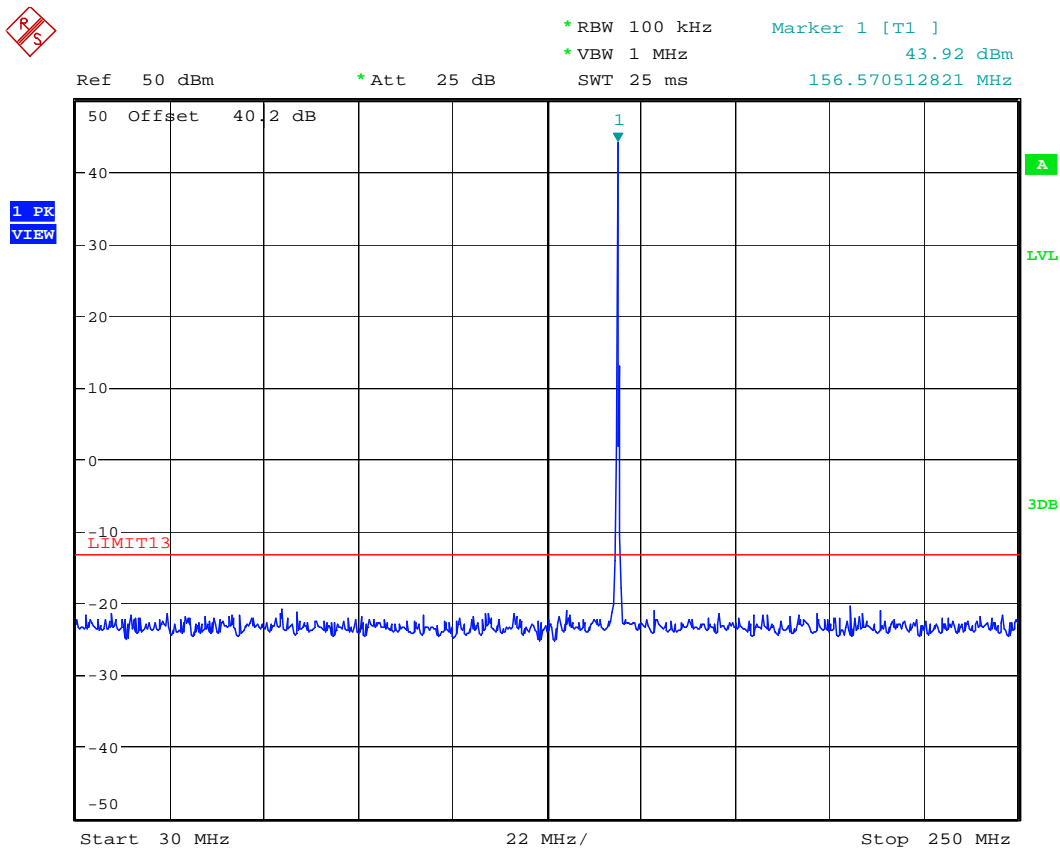

Date: 22.APR.2020 08:58:26

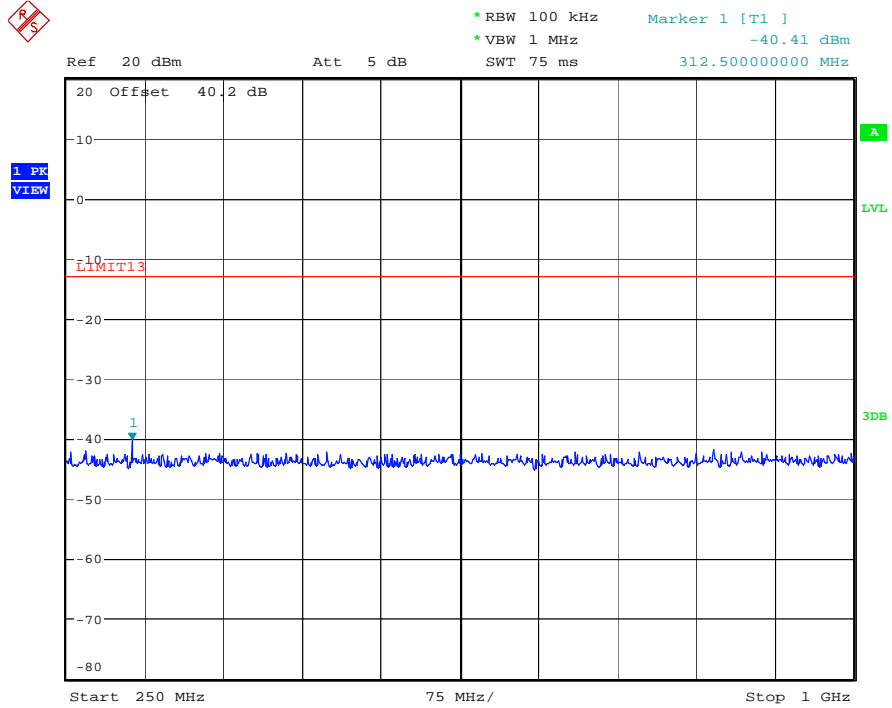

Date: 22.APR.2020 09:05:26

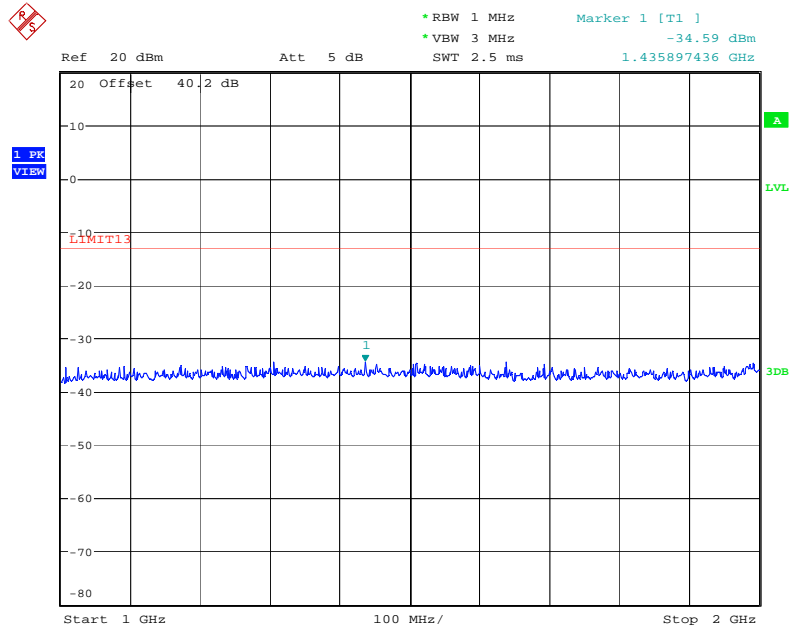

Date: 22.APR.2020 09:09:56

ULTRATECH GROUP OF LABS

3000 Bristol Circle, Oakville, Ontario, Canada L6H 6G4
 Tel. #: 905-829-1570, Fax. #: 905-829-8050, Email: vic@ultratech-labs.com, Website: <http://www.ultratech-labs.com>

File #: 20ICOM-524_F80RSS182
 May 6, 2020

All test results contained in this engineering test report are traceable to National Institute of Standards and Technology (NIST)

5.5.3.7. Configuration: Tx Conducted, CH 70(DSC 1300Hz) 156.525MHz, Low power

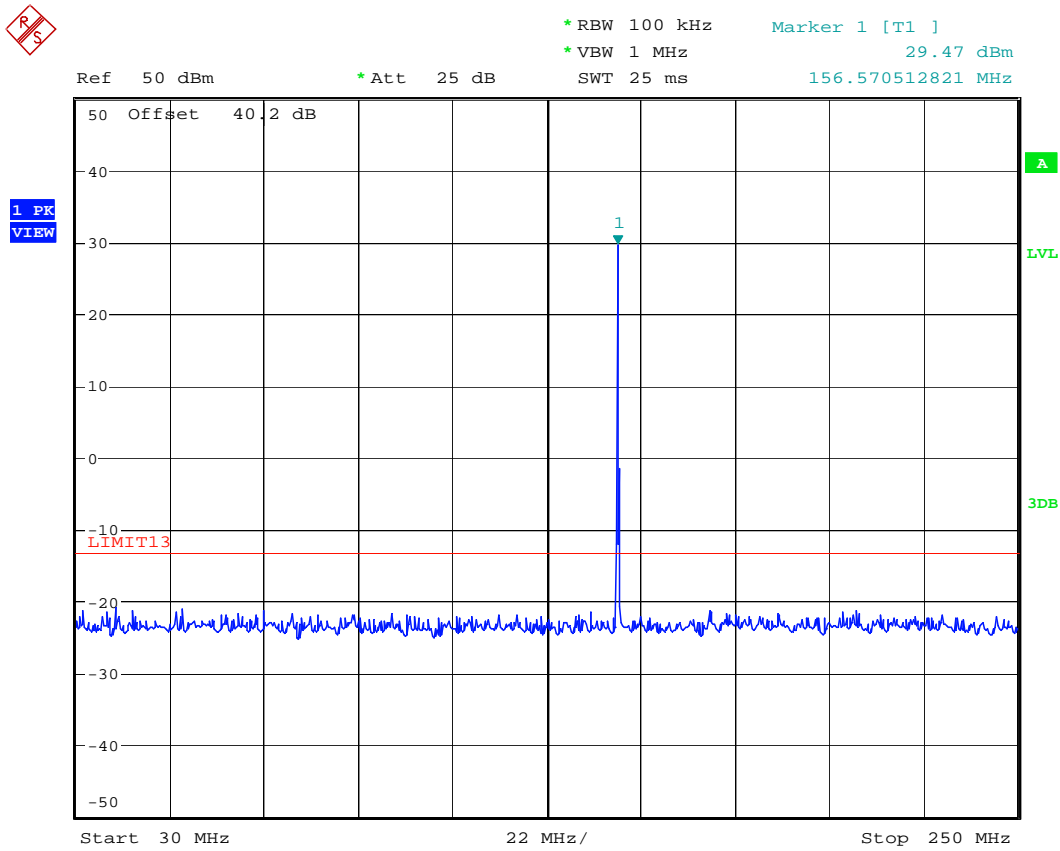

Date: 22.APR.2020 08:59:25

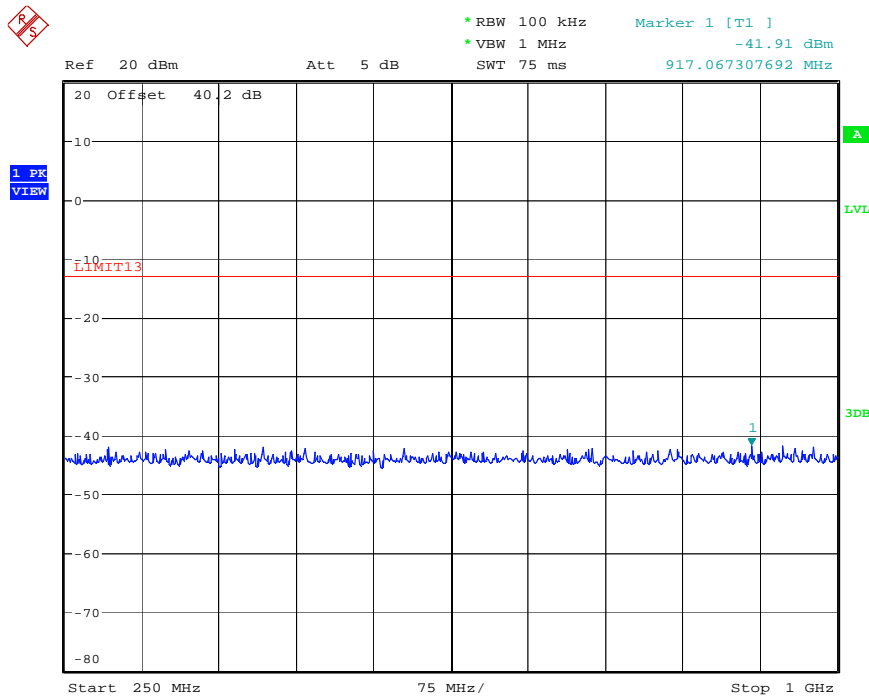

Date: 22.APR.2020 09:02:07

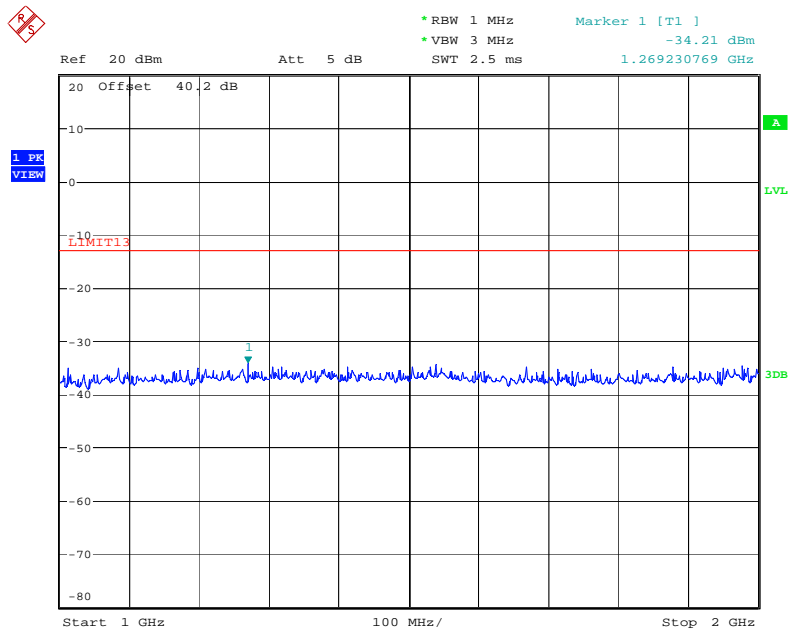

Date: 22.APR.2020 09:10:49

ULTRATECH GROUP OF LABS

3000 Bristol Circle, Oakville, Ontario, Canada L6H 6G4
Tel. #: 905-829-1570, Fax. #: 905-829-8050, Email: vic@ultratech-labs.com, Website: <http://www.ultratech-labs.com>

File #: 20ICOM-524_F80RSS182
May 6, 2020

All test results contained in this engineering test report are traceable to National Institute of Standards and Technology (NIST)

5.5.3.8. Configuration: Tx Conducted, CH 70(DSC 2100Hz) 156.525MHz, Low power

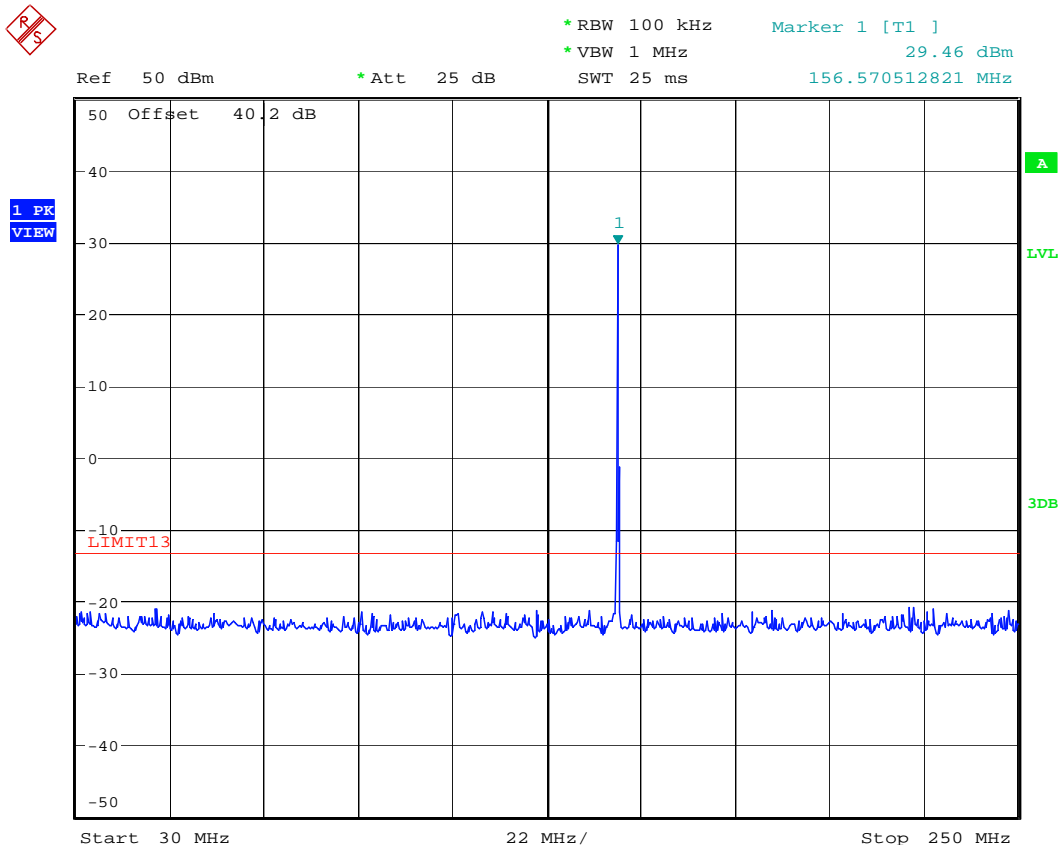

Date: 22.APR.2020 09:00:00

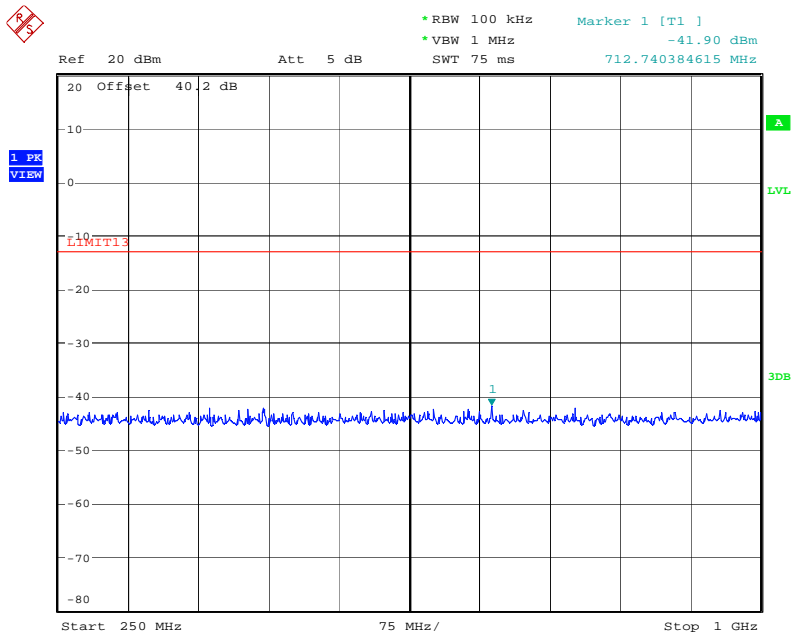

Date: 22.APR.2020 09:02:41

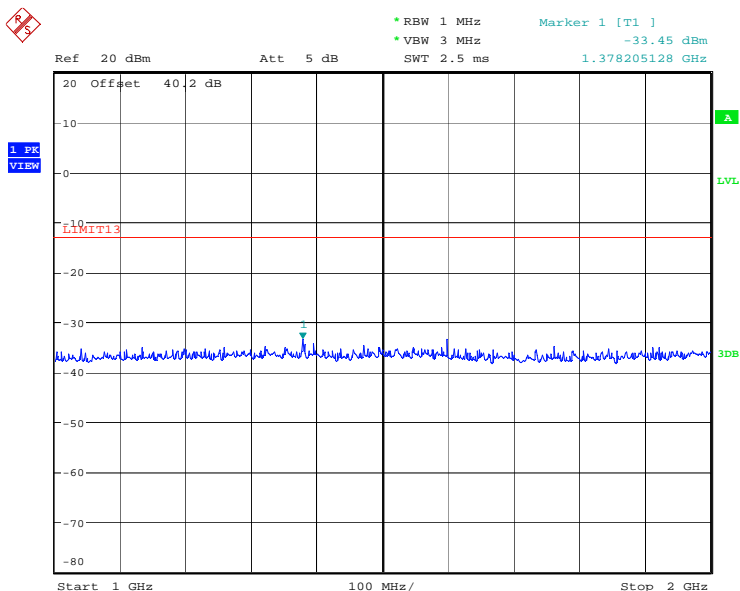

Date: 22.APR.2020 09:11:34

ULTRATECH GROUP OF LABS

3000 Bristol Circle, Oakville, Ontario, Canada L6H 6G4
Tel. #: 905-829-1570, Fax. #: 905-829-8050, Email: vic@ultratech-labs.com, Website: <http://www.ultratech-labs.com>

File #: 20ICOM-524_F80RSS182
May 6, 2020

All test results contained in this engineering test report are traceable to National Institute of Standards and Technology (NIST)

5.6. TRANSMITTER SPURIOUS/HARMONIC RADIATED EMISSIONS [§ 80.211(f)(3)] [RSS-182, SECTION 7.9]

5.6.1. Limits

§ 80.211 (f)(3) On any frequency removed from the assigned frequency by more than 250 percent of the authorized bandwidth: At least 43 plus 10log10 (mean power in watts) dB.

[RSS-182, SECTION 7.9]

Equipment with 25 kHz channel spacing (equipment designator G and D) shall comply with emission mask B. Radio equipment with 12.5 kHz channel spacing, with or without an audio low-pass filter, shall comply with emission mask C.

5.6.2. Method of Measurements

The spurious/harmonic ERP measurements are using substitution method specified in 8.2 of this report and its value in dBc is calculated as follows:

- (1) If the transmitter's antenna is an integral part of the EUT, the ERP is measured using substitution method.
- (2) If the transmitter's antenna is non-integral and diverse, the lowest ERP of the carrier with 0 dBi antenna gain is used for calculation of the spurious/harmonic emissions in dBc:

$$\text{Lowest ERP of the carrier} = \text{EIRP} - 2.15 \text{ dB} = \text{Pc} + \text{G} - 2.15 \text{ dB} = \text{Pc dBm (conducted)} + 0 \text{ dBi} - 2.15 \text{ dB}$$

5.6.3. Test Data

Remarks:

- The radiated emissions were performed with high power setting and 25 kHz channel spacing at 3 m distance to represent the worst-case test configuration.
- The emissions were scanned from 30 MHz to 2 GHz; all significant emissions were recorded.

Carrier Frequency:		156.050 MHz				
Power:		High				
Limit:		-13.0 dBm				
Frequency (MHz)	E-Field (dBµV/m)	EMI Detector (Peak/QP)	Antenna Polarization (H/V)	ERP (dBm)	Limit (dBm)	Margin (dB)
312.100	64.65	PEAK	H	-24.29	-13	-11.29
468.150	64.39	PEAK	H	-27.56	-13	-14.56
* All other harmonics and spurious emissions are more than 20 dB below the specified attenuation limit.						

Carrier Frequency:		157.425MHz				
Power:		High				
Limit:		-13.0 dBm				
Frequency (MHz)	E-Field (dBµV/m)	EMI Detector (Peak/QP)	Antenna Polarization (H/V)	ERP (dBm)	Limit (dBm)	Margin (dB)
314.850	65.11	PEAK	H	-23.47	-13	-10.47
472.275	64.99	PEAK	H	-27.14	-13	-14.14
* All other harmonics and spurious emissions are more than 20 dB below the specified attenuation limit.						

Carrier Frequency:		156.525MHz				
Power:		High				
Limit:		-13.0 dBm				
Frequency (MHz)	E-Field (dBµV/m)	EMI Detector (Peak/QP)	Antenna Polarization (H/V)	ERP (dBm)	Limit (dBm)	Margin (dB)
313.050	64.95	PEAK	H	-23.68	-13	-10.68
469.575	63.57	PEAK	H	-28.04	-13	-15.04
* All other harmonics and spurious emissions are more than 20 dB below the specified attenuation limit.						

5.7. FREQUENCY STABILITY [§§ 2.1055 & 80.209] [RSS-182, SECTION 7.4]

5.7.1. Limits

Frequency Band	Coast Stations		Ship Stations
	Below 3 W	3 to 100 W	
156–162 MHz	10 ppm	¹ 5 ppm	² 10 ppm

¹ For transmitters operated at private coast stations with antenna heights less than 6 meters (20 feet) above ground and output power of 225 Watts or less the frequency tolerance is 10 parts in 10⁶.

² For transmitters in the radiolocation and associated telecommand service operating on 154.585 MHz, 159.480 MHz, 160.725 MHz and 160.785 MHz the frequency tolerance is 15 parts in 10⁶.

[RSS-182, SECTION 7.4]

With the exception of DSC emissions, the RF carrier frequency shall not depart from the reference frequency in excess of the limits listed in Table 2.

RSS-182, Table 2 - Frequency Stability Limits

Type of Equipment	Frequency Stability Limit
Coast stations	+10.0 ppm for transmitter power less than 3 watts +5.0 ppm for transmitter power between 3 and 100 watts +2.5 ppm for transmitter power exceeding 100 watts
Ship stations	±10 ppm

5.7.2. Method of Measurements

Refer to Section 8.3 of this report for measurement details

5.7.3. Test Data

Center Frequency:	156.050 MHz		
Full Power Level:	23.17 W		
Frequency Tolerance Limit (Worst Case):	±10 ppm or 1560.5 Hz		
Max. Frequency Tolerance Measured:	-462 Hz or 2.96 ppm		
Input Voltage Rating:	13.8 VDC		
Ambient Temperature (°C)	Frequency Drift (Hz)		
	Supply Voltage (Nominal) 13.8 Volts	Supply Voltage (85%) 11.73 Volts	Supply Voltage (115% of Nominal) 15.87 Volts
-20	-462	--	--
-10	256	--	--
0	233	--	--
10	208	--	--
20	-210	-223	-319
30	-306	--	--
40	-339	--	--
50	-319	--	--
60	452	--	--

5.8. RF EXPOSURE REQUIREMENTS [§§ 1.1310 & 2.1091] [RSS Gen Sec 5.6 & RSS-102]

5.8.1. Limits

§ 1.1310: The criteria listed in the following table shall be used to evaluate the environmental impact of human exposure to radio-frequency (RF) radiation as specified in 1.1307(b).

Limits for Maximum Permissible Exposure (MPE)

Frequency range (MHz)	Electric field strength (V/m)	Magnetic field strength (A/m)	Power density (mW/cm ²)	Averaging time (minutes)
(A) Limits for Occupational/Controlled Exposures				
30-300	61.4	0.163	1.0	6
(B) Limits for General Population/Uncontrolled Exposure				
30-300	27.5	0.073	0.2	30

f = frequency in MHz

* = Plane-wave equivalent power density

Note 1: Occupational/controlled limits apply in situations in which persons are exposed as a consequence of their employment provided those persons are fully aware of the potential for exposure and can exercise control over their exposure. Limits for occupational/controlled exposure also apply in situations when an individual is transient

through a location where occupational/controlled limits apply provided he or she is made aware of the potential for exposure.

Note 2: General population/uncontrolled exposures apply in situations in which the general public may be exposed, or in which persons that are exposed as a consequence of their employment may not be fully aware of the potential for exposure or cannot exercise control over their exposure.

[RSS Gen Sec 5.6 & RSS-102]

RF Field Strength Limits for Controlled Use Devices (Controlled Environment)

Frequency Range (MHz)	Electric Field (V/m rms)	Magnetic Field (A/m rms)	Power Density (W/m ²)	Reference Period (minutes)
100-6000	$15.60 f^{0.25}$	$0.04138 f^{0.25}$	$0.6455 f^{0.5}$	6
Note: f is frequency in MHz.				

Table 4: RF Field Strength Limits for Devices Used by the General Public (Uncontrolled Environment)

Frequency Range (MHz)	Electric Field (V/m rms)	Magnetic Field (A/m rms)	Power Density (W/m ²)	Reference Period (minutes)
48-300	22.06	0.05852	1.291	6
Note: f is frequency in MHz.				

5.8.2. Method of Measurements

Calculation Method of RF Safety Distance:

$$S = \frac{PG}{4\pi \cdot r^2} = \frac{EIRP}{4\pi \cdot r^2}$$

Where, P: power input to the antenna in mW
EIRP: Equivalent (effective) isotropic radiated power.
S: power density mW/cm²
G: numeric gain of antenna relative to isotropic radiator
r: distance to centre of radiation in cm

$$r = \sqrt{\frac{PG}{4\pi \cdot S}} = \sqrt{\frac{EIRP}{4\pi \cdot S}}$$

FCC radio frequency exposure limits may be exceeded at distances closer than r cm from the antenna of this device.

Evaluation of RF Exposure Compliance Requirements

Maximum RF Power conducted, P_{conducted}[W]:	25
Maximum Antenna Gain, G[dBi]:	9
Maximum EIRP, P_{EIRP}[W]:	198.6
User-based time-average for PTT	50%
FCC MPE Limit for Occupational/Controlled Exposure, S_{controlled}[mW/cm²]:	1.0
ISED MPE Limit for Occupational/Controlled Exposure, S_{controlled}[mW/cm²]: 0.6455f^{0.5}	0.75277
Min Calculated RF Safety Distance for Occupational/Controlled Exposure, r_{safety_controlled}[cm]: FCC	45
Min Calculated RF Safety Distance for Occupational/Controlled Exposure, r_{safety_controlled}[m]: ISED	0.52
FCC MPE Limit for General Population/Un-controlled Exposure, S_{UNcontrolled}[mW/cm²]:	0.2
ISED MPE Limit for General Population/Un-controlled Exposure, S_{UNcontrolled}[mW/cm²]:	0.1291
Min Calculated RF Safety Distance for General Population/Un-controlled Exposure Exposure, r_{safety_uncontrolled}[cm]: FCC	199
Min Calculated RF Safety Distance for General Population/Un-controlled Exposure Exposure, r_{safety_uncontrolled}[m]: ISED	2.48

User manual specified distance (MPE Radius)=300cm
Calculated power density S for this distance=0.0878 mW/Cm² (0.88 W/m²)

5.8.3. RECEIVER ANTENNA POWER SPURIOUS/HARMONIC CONDUCTED EMISSIONS [RSS-1182 § 7.11, RSS-Gen §§ 7.4]

5.8.4. Limits

No spurious output signals appearing at the antenna terminals shall exceed 2 nanowatts per any 4 kHz spurious frequency in the band 30-1000 MHz, or 5 nanowatts above 1 GHz.

5.8.5. Method of Measurements

Refer to Industry Canada RSS-Gen and ANSI C63.4.

5.8.6. Test Data

Shown in next page

5.8.6.1. Configuration: Rx Conducted, CH 1001, 156.050MHz

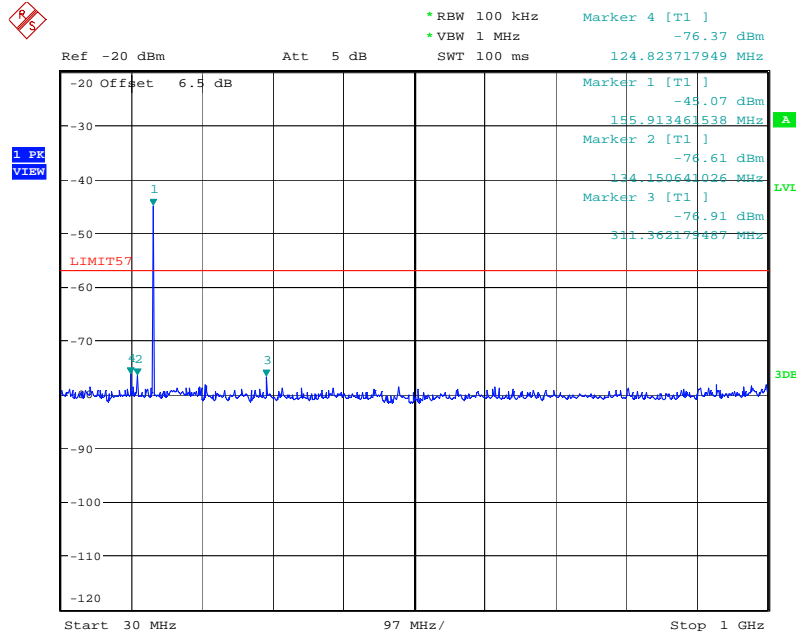

Date: 21.APR.2020 16:04:44

Highest peak is Rx Signal input (1mV rms)

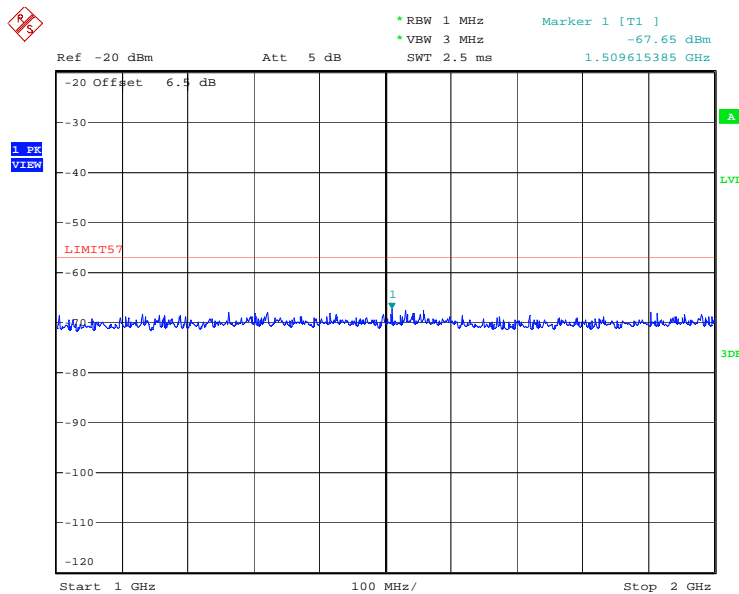

Date: 21.APR.2020 16:06:33

ULTRATECH GROUP OF LABS

3000 Bristol Circle, Oakville, Ontario, Canada L6H 6G4
 Tel. #: 905-829-1570, Fax. #: 905-829-8050, Email: vic@ultratech-labs.com, Website: <http://www.ultratech-labs.com>

File #: 20ICOM-524_F80RSS182
 May 6, 2020

All test results contained in this engineering test report are traceable to National Institute of Standards and Technology (NIST)

5.8.6.2. Configuration: Rx Conducted, CH Wx 10, 163.275MHz

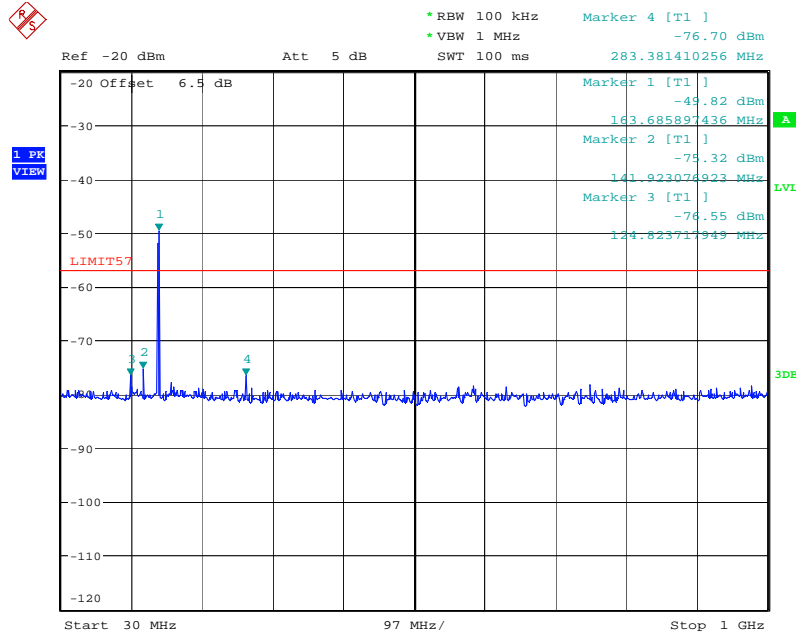

Date: 21.APR.2020 16:11:38

Highest peak is Rx Signal input (1mV rms)

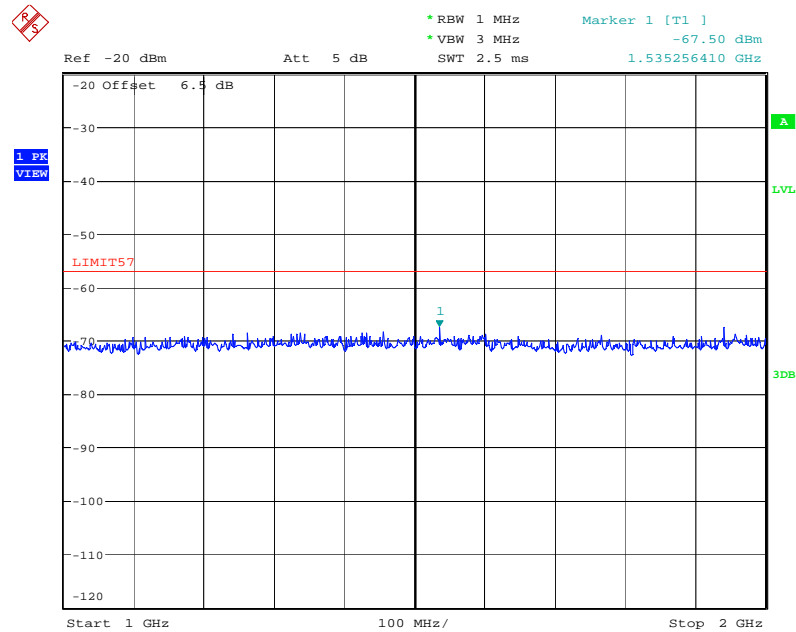

Date: 21.APR.2020 16:08:07

ULTRATECH GROUP OF LABS

3000 Bristol Circle, Oakville, Ontario, Canada L6H 6G4
 Tel. #: 905-829-1570, Fax. #: 905-829-8050, Email: vic@ultratech-labs.com, Website: <http://www.ultratech-labs.com>

File #: 20ICOM-524_F80RSS182
 May 6, 2020

All test results contained in this engineering test report are traceable to National Institute of Standards and Technology (NIST)

5.8.6.3. Configuration: Rx Conducted, CH 70(DSC), 156.525MHz

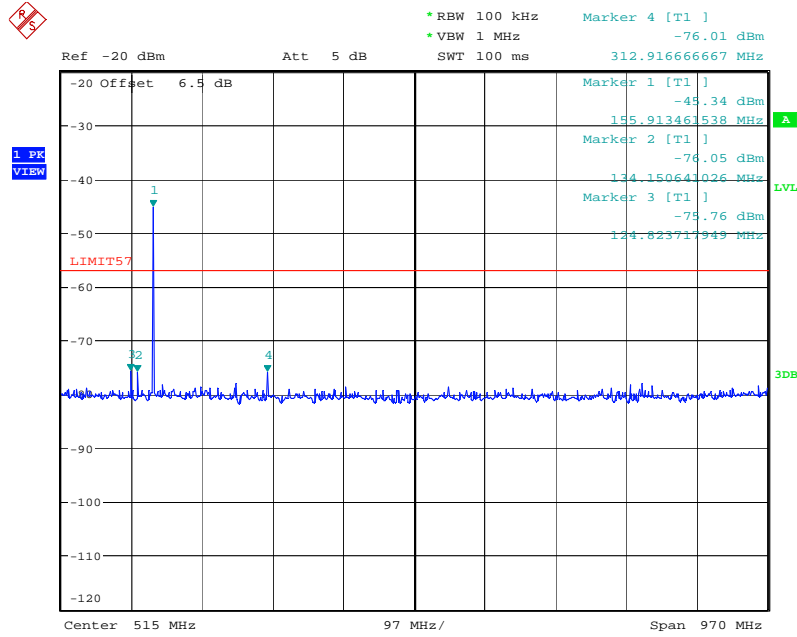

Date: 21.APR.2020 16:19:29

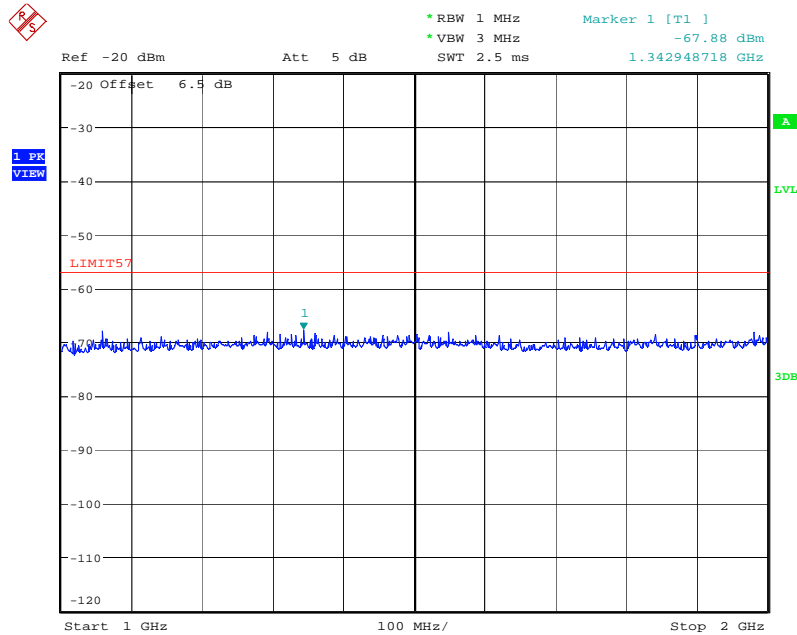

Date: 21.APR.2020 16:20:52

ULTRATECH GROUP OF LABS

3000 Bristol Circle, Oakville, Ontario, Canada L6H 6G4
 Tel. #: 905-829-1570, Fax. #: 905-829-8050, Email: vic@ultratech-labs.com, Website: <http://www.ultratech-labs.com>

File #: 20ICOM-524_F80RSS182
 May 6, 2020

All test results contained in this engineering test report are traceable to National Institute of Standards and Technology (NIST)

5.9. RECEIVER SPURIOUS EMISSIONS (RADIATED) [RSS-182 § 7.11, RSS-Gen §§ 7.3]

5.9.1. Limits

The equipment shall meet the limits of the following table:

Spurious Frequency (MHz)	Field Strength at 3 meters	
	(μ V/m)	(dB μ V/m)
30 – 88	100	40.0
88 – 216	150	43.5
216 – 960	200	46.0
Above 960	500	54.0

5.9.2. Method of Measurements

RSS-Gen and ANSI C63.4

5.9.3. Test Data

(IF= 21.7 MHz)

- The measuring receiver shall be tuned over the frequency range 30 MHz to 2 GHz.
- All spurious emissions that are in excess of 20 dB below the specified limit shall be recorded.
- IF=21.7 MHz

Near Lowest Frequency (156.050 MHz)

Frequency (MHz)	RF Level (dB μ V/m)	Detector Used (Peak/QP)	Antenna Plane (H/V)	Limit (dB μ V/m)	Margin (dB)
403.050	28.80	PEAK	V	46.02	-17.22
403.050	27.20	PEAK	H	46.02	-18.82

Near Highest Frequency (163.275 MHz)

Frequency (MHz)	RF Level (dB μ V/m)	Detector Used (Peak/QP)	Antenna Plane (H/V)	Limit (dB μ V/m)	Margin (dB)
424.725	29.48	PEAK	V	46.02	-16.54
424.725	24.81	PEAK	H	46.02	-21.21

DSC Frequency (156.525 MHz)

Frequency (MHz)	RF Level (dB μ V/m)	Detector Used (Peak/QP)	Antenna Plane (H/V)	Limit (dB μ V/m)	Margin (dB)
404.475	30.96	PEAK	V	46.02	-15.06
404.475	28.80	PEAK	H	46.02	-17.22

5.10. POWERLINE CONDUCTED Emissions [ICES-003]

5.10.1. Limits

The equipment shall meet the limits of the following table:

Test Frequency Range (MHz)	CLASS B LIMITS		Measuring Bandwidth
	Quasi-Peak (dBµV)	Average* (dBµV)	
0.15 to 0.5	66 to 56*	56 to 46*	RBW = 9 kHz VBW ≥ 9 kHz for QP VBW = 10 Hz for Average
0.5 to 5	56	46	RBW = 9 kHz VBW ≥ 9 kHz for QP VBW = 10 Hz for Average
5 to 30	60	50	RBW = 9 kHz VBW ≥ 9 kHz for QP VBW = 10 Hz for Average

* Decreasing linearly with logarithm of frequency

5.10.2. Method of Measurements

Refer to Ultratech Test Procedures ULTR-P001-2004 & ANSI C63.4 for method of measurements.

Calculation of Conducted Emission Voltage (dBµV):

This is calculated by adding the L.I.S.N factor, Cable loss factor, and Attenuator factor to the measured reading. The basic equation with a sample calculation is as follows:

$\text{Voltage (dB}\mu\text{V)} = \text{RA} + \text{AF} + \text{CF} + \text{LF}$
--

Where

- RA = Receiver/Analyzer Reading in dBµV
- AF = Attenuation Factor in dB
- CF = Cable loss Factor in dB
- LF = L.I.S.N Factor in dB

5.10.3. Test Data

The emissions were scanned from 150 kHz to 30 MHz at AC mains Terminal via a LISN, and all emissions less than 20 dB below the limits were recorded.

5.10.3.1. TX mode (IC-M424G)

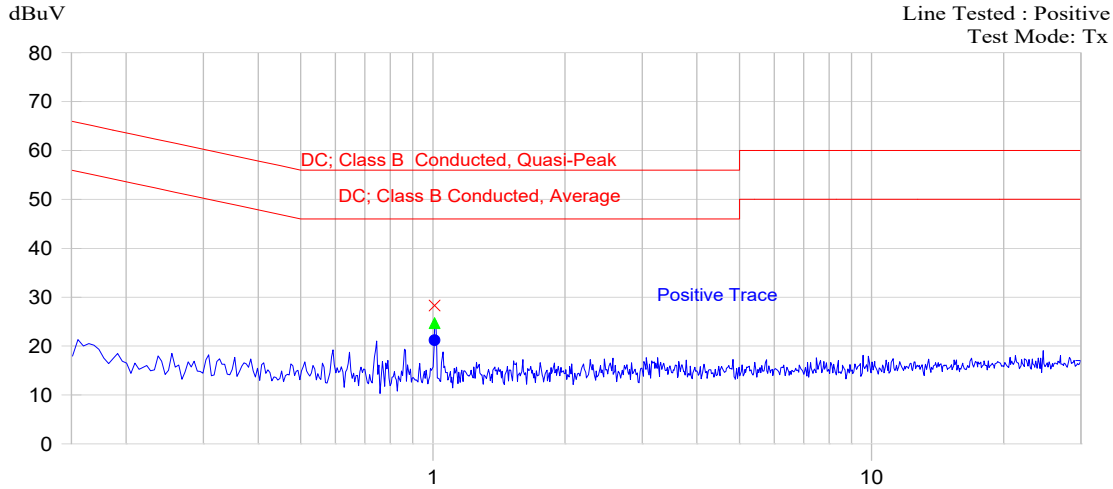

4/23/2020 3:08:32 PM

(Start = 0.15, Stop = 30.00) MHz

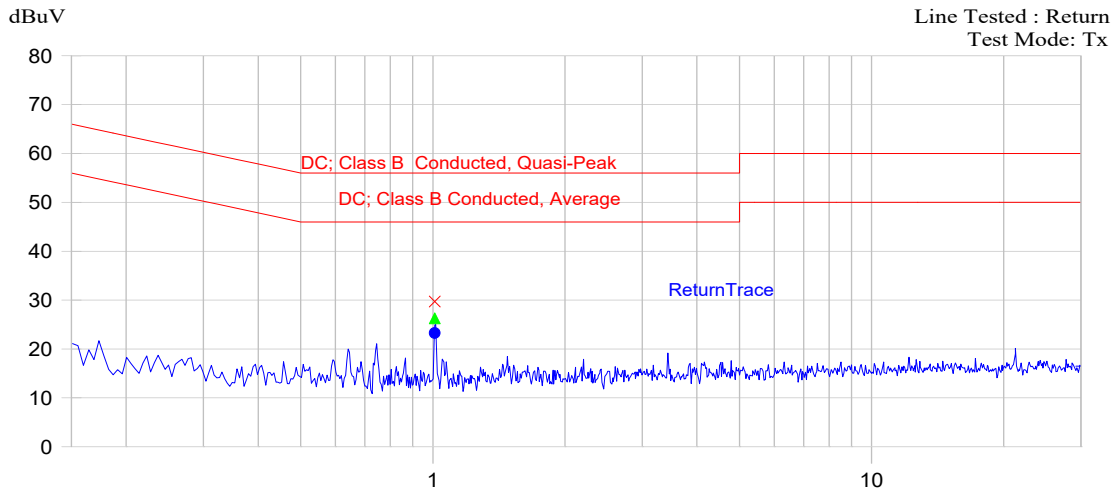

4/23/2020 3:03:19 PM

(Start = 0.15, Stop = 30.00) MHz

All emissions are less than 20 dB below the limit.

5.10.3.2. RX mode (IC-M424G)

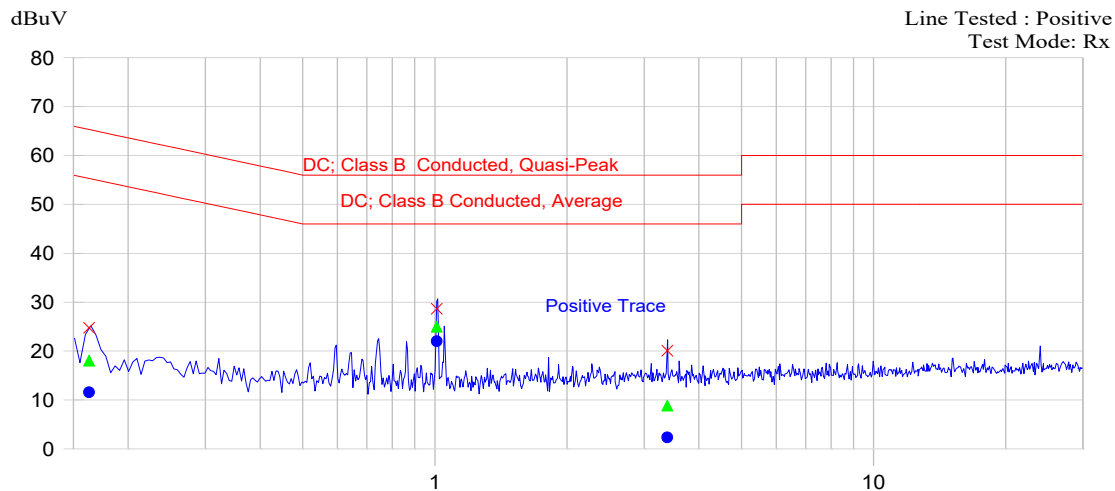

4/23/2020 2:43:42 PM

(Start = 0.15, Stop = 30.00) MHz

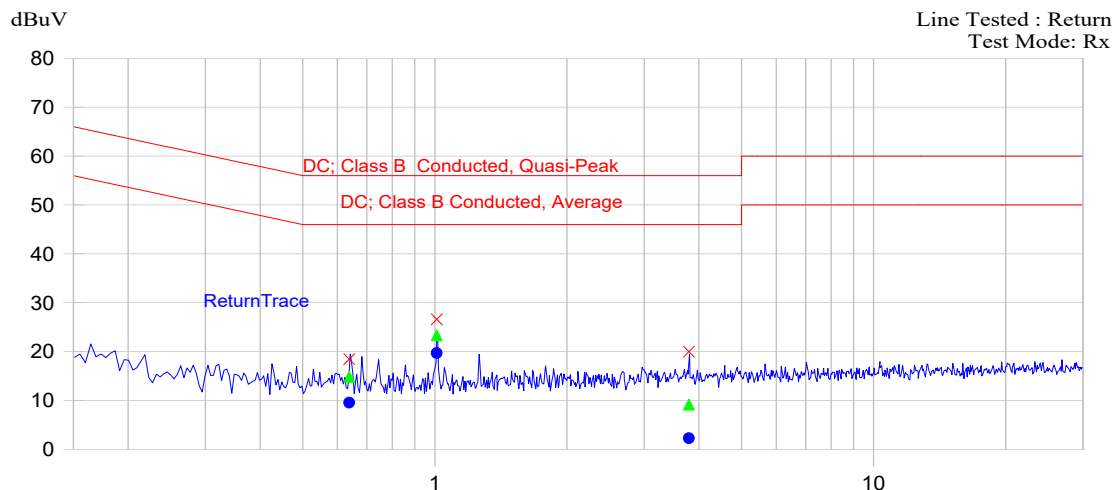

4/23/2020 2:55:04 PM

(Start = 0.15, Stop = 30.00) MHz

All emissions are less than 20 dB below the limit.

5.10.3.3. TX mode (IC-M400BB)

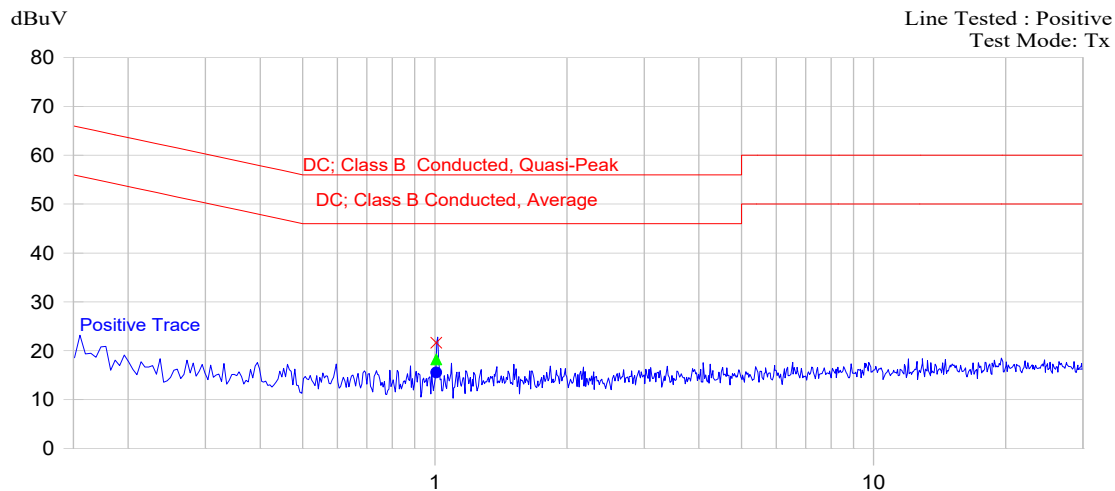

4/27/2020 10:11:44 AM

(Start = 0.15, Stop = 30.00) MHz

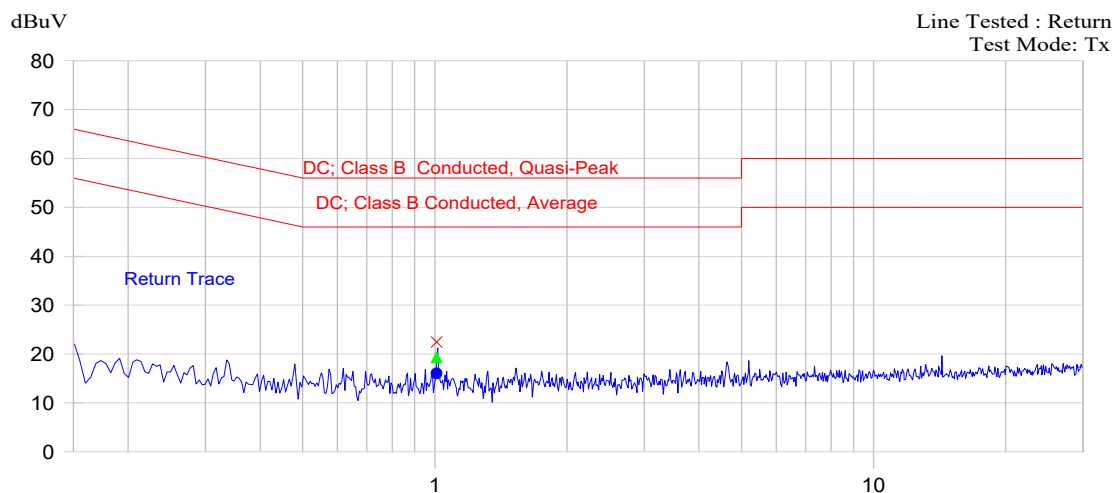

4/27/2020 10:20:24 AM

(Start = 0.15, Stop = 30.00) MHz

All emissions are less than 20 dB below the limit.

5.10.3.4. RX mode (IC-M400BB)

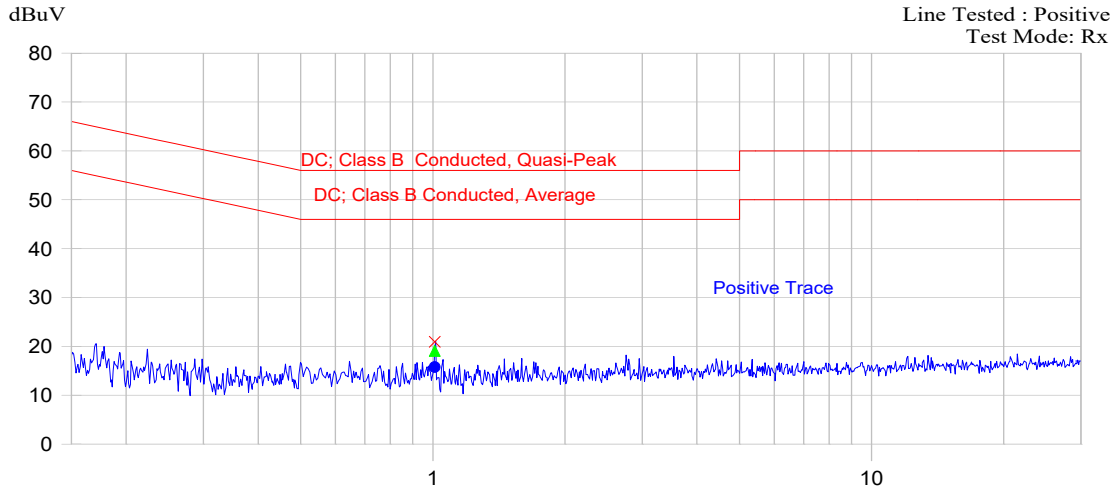

4/27/2020 10:00:01 AM

(Start = 0.15, Stop = 30.00) MHz

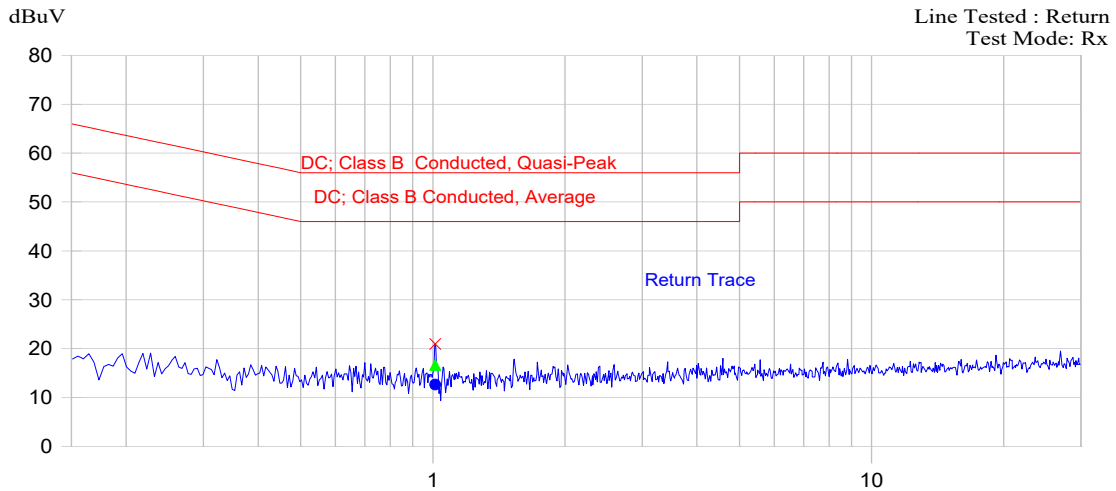

4/27/2020 10:16:14 AM

(Start = 0.15, Stop = 30.00) MHz

All emissions are less than 20 dB below the limit.

5.11. Radiated Emissions-Unintentional [ICES-003]

5.11.1. Limits

The equipment shall meet the limits of the following table:

Frequency of emission (MHz)	Class B Limits	
	(dB μ V/m at 3 m)	(dB μ V/m at 10 m)
30 – 88	40.0	29.5
88 – 216	43.5	33.1
216 – 960	46.0	35.6
Above 960	54.0	43.5

5.11.2. Method of Measurements

Refer to Ultratech Test Procedures ULTR-P001-2004 & ANSI C63.4 for method of measurements.

5.11.3. Test Data

EUT: IC-M400BB

The emissions were scanned from 1 GHz to 8 GHz at 3 meters distance and all emissions less than 20 dB below the limits were recorded.						
FREQUENCY (MHz)	RF LEVEL (dBuV/m)	DETECTOR USED (PEAK/QP)	ANTENNA PLANE (H/V)	LIMIT (dBuV/m)	MARGIN (dB)	PASS/ FAIL
125.6	28	PEAK	V	43.5	-15.5	PASS
134.3	24.1	PEAK	V	43.5	-19.4	PASS
134.3	25.2	PEAK	H	43.5	-18.3	PASS
403.2	31.2	PEAK	V	46	-14.8	PASS
403.2	31.3	PEAK	H	46	-14.7	PASS

EUT: IC-M424G

The emissions were scanned from 1 GHz to 8 GHz at 3 meters distance and all emissions less than 20 dB below the limits were recorded.						
FREQUENCY (MHz)	RF LEVEL (dBuV/m)	DETECTOR USED (PEAK/QP)	ANTENNA PLANE (H/V)	LIMIT (dBuV/m)	MARGIN (dB)	PASS/ FAIL
44.1	22.3	PEAK	V	40	-17.7	PASS
125.6	22.6	PEAK	V	40	-17.4	PASS
402.7	28.8	PEAK	V	46	-17.2	PASS
402.7	27.2	PEAK	H	46	-18.8	PASS

EXHIBIT 6. TEST EQUIPMENT LIST AND SETUP

6.1. Conducted Power

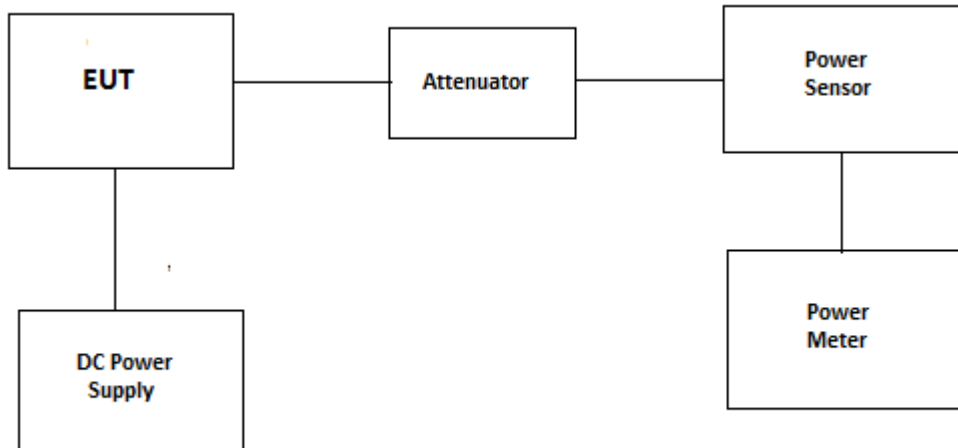

Test Instrument	Manufacturer	Model No	Serial No	Frequency Range	Cal Due date
Power Meter	HP	436A	2709A27515	100KHz-sensor dependant	13 May 2020
Power Sensor	HP	8482A	2652A14099	10MHz-4.2GHz	11 Mar 2022
Attenuator(20dB)	Weinschel	WA 35-20-33	A164	DC-8.5GHz	Cal on use
Attenuator(20dB)	Aeroflex\Weinschel	23-20-34	BH7876	DC-18GHz	Cal on use
Power supply	Pyramid	PS-36KX	--	12-15 Vdc, 35A	--
Multimeter	Fluke	8842A	5021295	---	19 Dec 2020

6.2. Modulation Limit

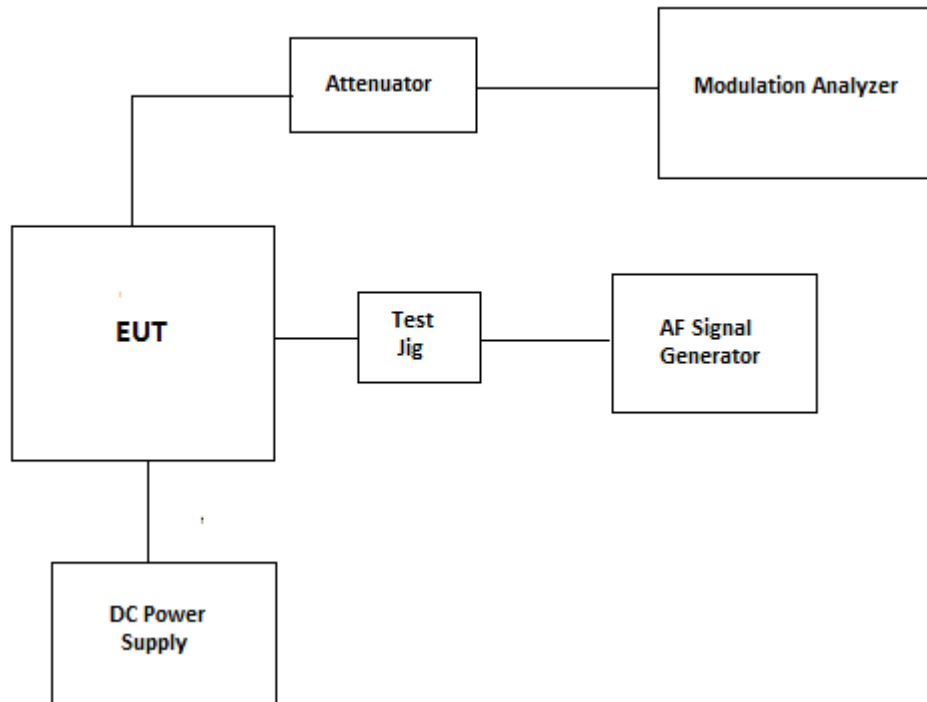

Test Instrument	Manufacturer	Model No	Serial No	Frequency Range	Cal Due date
Modulation Analyzer	HP	HP-8901B	3226A04606	150KHz-1300MHz	17 Mar 2022
AF Signal Generator	HP	HP-8920B	US39064699	30MHz-1GHz	17 Mar 2022
Digital Voltmeter	HP	3456A	2015A04523	--	21 Jan 2022
Attenuator(20dB)	Weinschel	WA 35-20-33	A164	DC-8.5GHz	Cal on use
Attenuator(20dB)	Aeroflex\Weinschel	23-20-34	BH7876	DC-18GHz	Cal on use
Power supply	Pyramid	PS-36KX	--	12-15 Vdc, 35A	--
Multimeter	Fluke	8842A	5021295	---	19 Dec 2020

ULTRATECH GROUP OF LABS

3000 Bristol Circle, Oakville, Ontario, Canada L6H 6G4
Tel. #: 905-829-1570, Fax. #: 905-829-8050, Email: vic@ultratech-labs.com, Website: <http://www.ultratech-labs.com>

File #: 20ICOM-524_F80RSS182
May 6, 2020

All test results contained in this engineering test report are traceable to National Institute of Standards and Technology (NIST)

6.3. Audio Frequency Response

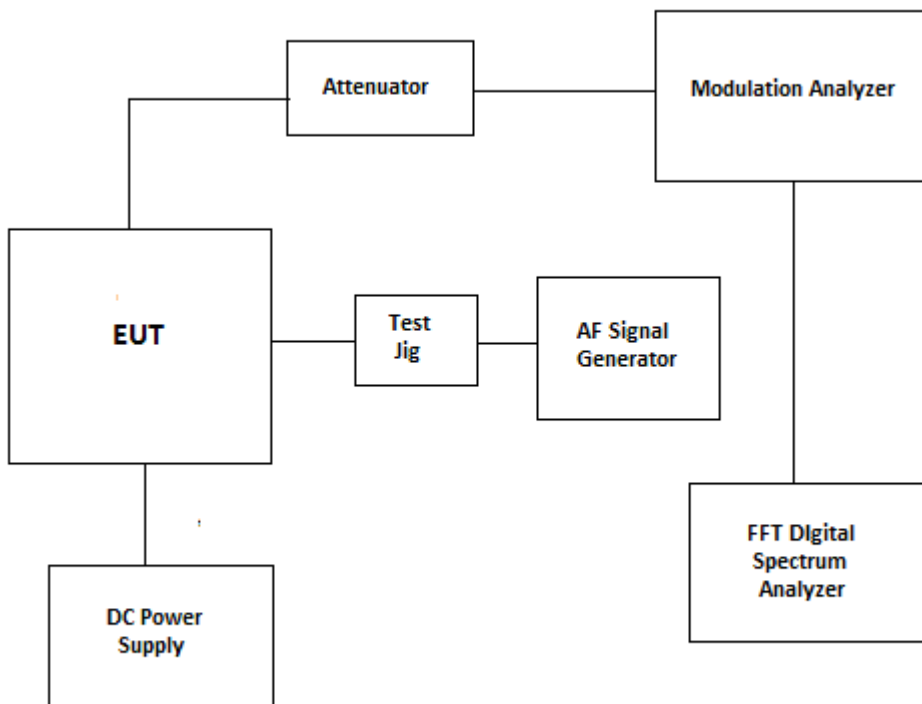

Test Instrument	Manufacturer	Model No	Serial No	Frequency Range	Cal Due date
Modulation Analyzer	HP	HP-8901B	3226A04606	150KHz-1300MHz	17 Mar 2022
AF Signal Generator	HP	HP-8920B	US39064699	30MHz-1GHz	17 Mar 2022
Digital Voltmeter	HP	3456A	2015A04523	--	21 Jan 2022
FFT Digital Spectrum Analyzer	Advantest	R9211E	8202336	10MHz-100KHz	12 Sep 2020
Attenuator(20dB)	Weinschel	WA 35-20-33	A164	DC-8.5GHz	Cal on use
Attenuator(20dB)	Aeroflex\Weinschel	23-20-34	BH7876	DC-18GHz	Cal on use
Power supply	Pyramid	PS-36KX	--	12-15 Vdc, 35A	--
Multimeter	Fluke	8842A	5021295	---	19 Dec 2020

ULTRATECH GROUP OF LABS

3000 Bristol Circle, Oakville, Ontario, Canada L6H 6G4
 Tel. #: 905-829-1570, Fax. #: 905-829-8050, Email: vic@ultratech-labs.com, Website: <http://www.ultratech-labs.com>

File #: 20ICOM-524_F80RSS182
 May 6, 2020

All test results contained in this engineering test report are traceable to National Institute of Standards and Technology (NIST)

6.4. 99% OBW and Mask

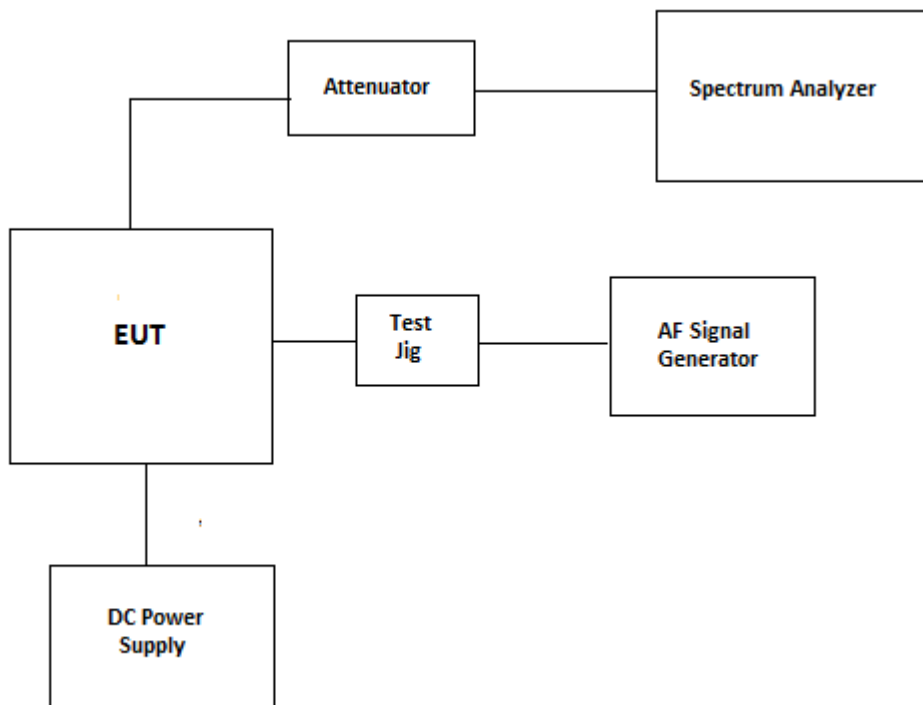

Test Instrument	Manufacturer	Model No	Serial No	Frequency Range	Cal Due date
Spectrum Analyzer	Rohde & Schwarz	FSU	100398	20Hz-26.5GHz	23 Oct 2021
AF Signal Generator	HP	HP-8920B	US39064699	30MHz-1GHz	17 Mar 2022
Digital Voltmeter	HP	3456A	2015A04523	--	21 Jan 2022
Attenuator(20dB)	Weinschel	WA 35-20-33	A164	DC-8.5GHz	Cal on use
Attenuator(20dB)	Aeroflex\Weinschel	23-20-34	BH7876	DC-18GHz	Cal on use
Power supply	Pyramid	PS-36KX	--	12-15 Vdc, 35A	--
Multimeter	Fluke	8842A	5021295	---	19 Dec 2020

6.5. Rx Conducted

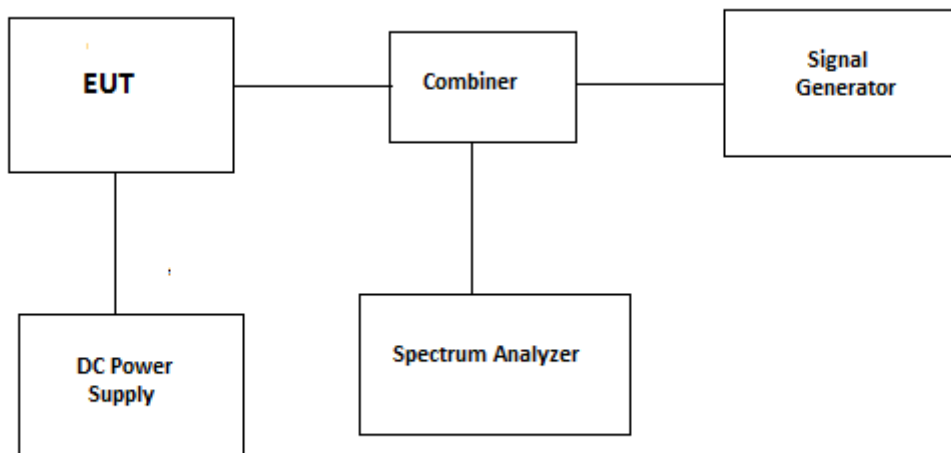

Emission

Test Instrument	Manufacturer	Model No	Serial No	Frequency Range	Cal Due date
Spectrum Analyzer	Rohde & Schwarz	FSU	100398	20Hz-26.5GHz	23 Oct 2021
Signal Generator	Marconi	2024	112255/164	9KHz-2.4GHz	19 Sep 2021
Combiner	Weinschel 93458	1515	PS119	DC-18GHz	Cal on use
Power supply	Pyramid	PS-36KX	--	12-15 Vdc, 35A	--
Multimeter	Fluke	8842A	5021295	---	19 Dec 2020

6.6. Tx Conducted Emission

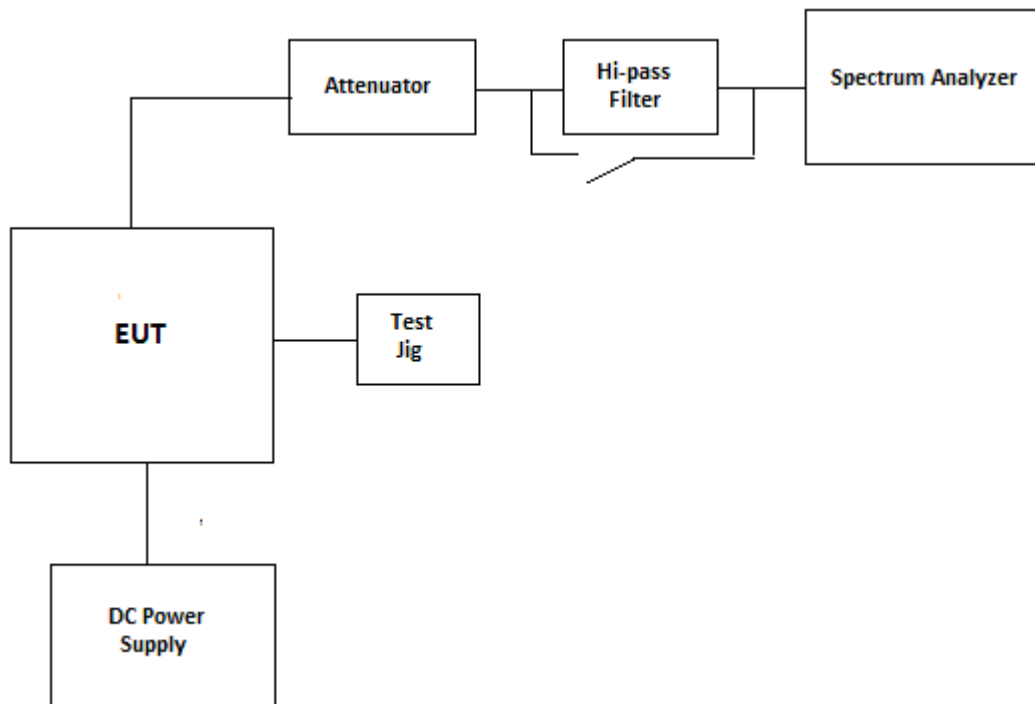

Test Instrument	Manufacturer	Model No	Serial No	Frequency Range	Cal Due date
Spectrum Analyzer	Rohde & Schwarz	FSU	100398	20Hz-26.5GHz	23 Oct 2021
Hi-pass filter	Mini-Circuit	SHP-250	--	Cut off 250MHz	Cal on use
Attenuator(20dB)	Weinschel	WA 35-20-33	A164	DC-8.5GHz	Cal on use
Attenuator(20dB)	Aeroflex\Weinschel	23-20-34	BH7876	DC-18GHz	Cal on use
Power supply	Pyramid	PS-36KX	--	12-15 Vdc, 35A	--
Multimeter	Fluke	8842A	5021295	---	19 Dec 2020

6.7. Frequency Stability

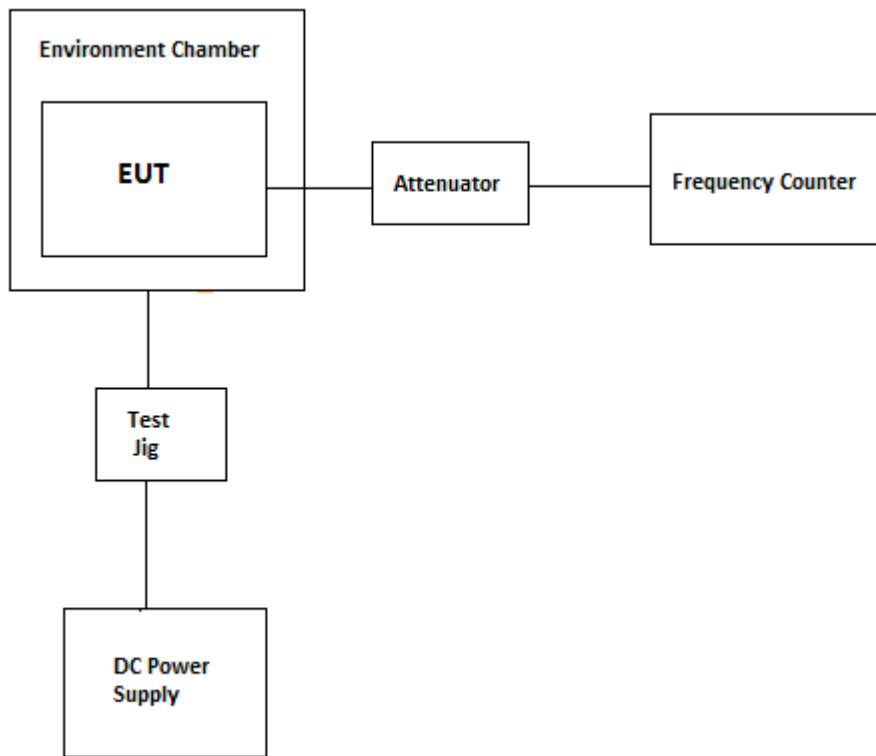

Test Instrument	Manufacturer	Model No	Serial No	Frequency Range	Cal Due date
Environmental Chamber	Envirotronics	SSH32C	11994847-S-11059	-60 to 177° C	10 Jun 2021
Frequency Counter	EIP	545A	2683	10MHz-1GHz	07 Aug 2020
Attenuator(20dB)	Aeroflex\Weinschel	34-20-34	BP6023	DC-18GHz	Cal on use
Attenuator(20dB)	Narda	26298	A577	DC-1GHz	Cal on use
Power Supply	Tenma	72-6153	--	1-18Vdc, 10A	----
Multimeter	Fluke	8842A	5021295	---	19 Dec 2020

6.8. Tx Radiated

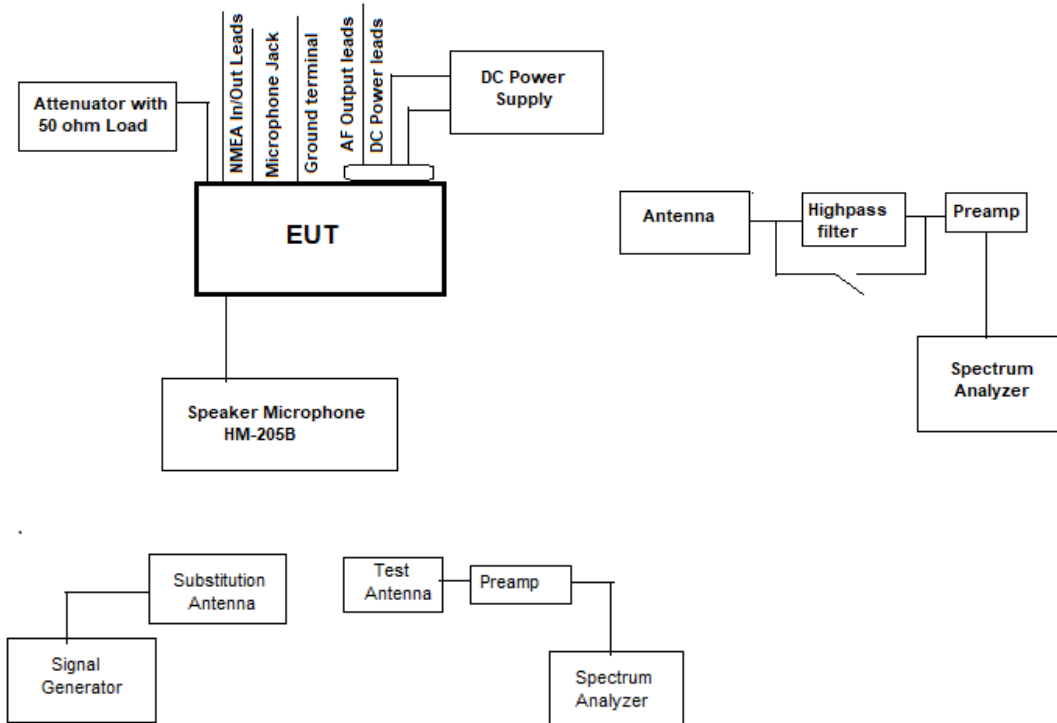

Test Instrument	Manufacturer	Model No	Serial No	Frequency Range	Cal Due date
Spectrum Analyzer	Rohde & Schwarz	FSU	100398	20Hz-26.5GHz	23 Oct 2021
Spectrum Analyzer	Rohde & Schwarz	ESU40	100037	20Hz-40GHz	18 Mar 2021
Biconilog Antenna	EMCO	3142B	1575	26-2000MHz	10 May 2020
Log Periodic Antenna	ETS	3148	00023845	200-2000MHz	02 Aug 2020
Dipole Antenna	EMCO	3121C-DB3 3121C-DB4	434	140-400 MHz 400-1000 MHz	03 Aug 2020
Horn Antenna	ETS	3117	00119425	1-18GHz	25 Jul 2021
Horn Antenna	ETS	3115	5061	1-18GHz	30 Apr 2020
Preamplifier	Com-Power	PAM-118A	551016	500MHz-18GHz	17 Mar 2021
Preamplifier	Com-Power	PA-103	161040	1-1000MHz	23 Mar 2021
Hi-pass filter	Mini-Circuit	SHP-250	--	Cut off 250MHz	Cal on use
Signal Generator	Marconi	2024	112255/164	9KHz-2.4GHz	19 Sep 2021
Attenuator(20dB)	Weinschel	WA 35-20-33	A164	DC-8.5GHz	Cal on use
Attenuator(20dB)	Aeroflex\Weinschel	23-20-34	BH7876	DC-18GHz	Cal on use
Load(50ohm)	Db products	--	--	DC-18GHz(15W)	Cal on use
Power supply	Pyramid	PS-36KX	--	12-18 Vdc, 35A	--
Multimeter	Fluke	8842A	5021295	---	19 Dec 2020

ULTRATECH GROUP OF LABS

3000 Bristol Circle, Oakville, Ontario, Canada L6H 6G4
 Tel. #: 905-829-1570, Fax. #: 905-829-8050, Email: vic@ultratech-labs.com, Website: <http://www.ultratech-labs.com>

File #: 20ICOM-524_F80RSS182
 May 6, 2020

All test results contained in this engineering test report are traceable to National Institute of Standards and Technology (NIST)

6.9. Rx Radiated

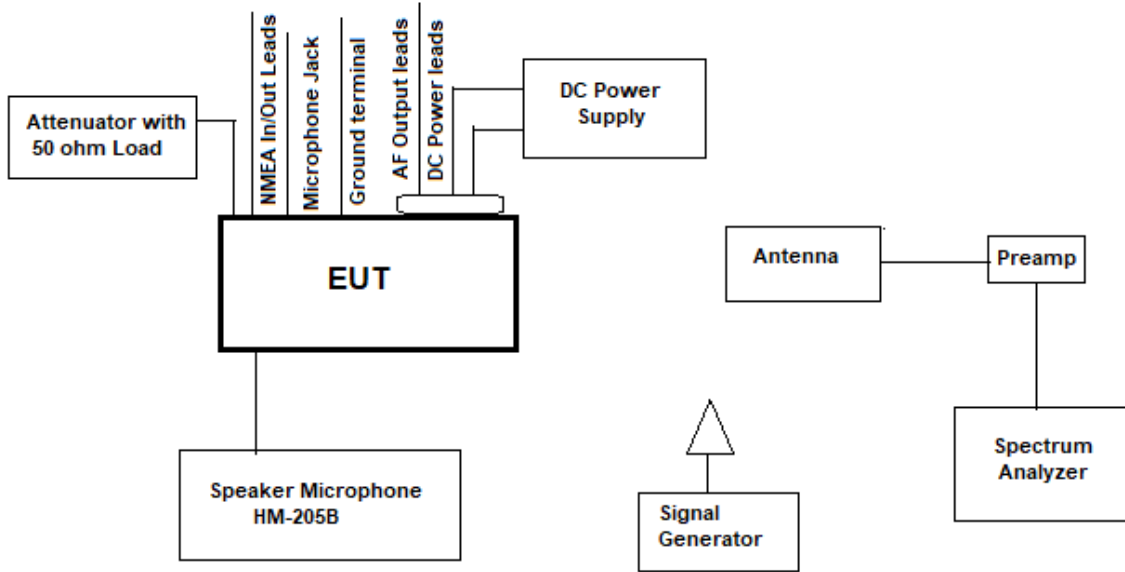

Test Instrument	Manufacturer	Model No	Serial No	Frequency Range	Cal Due date
Spectrum Analyzer	Rohde & Schwarz	FSU	100398	20Hz-26.5GHz	06 Oct 2019
Spectrum Analyzer	Rohde & Schwarz	ESU40	100037	20Hz-40GHz	18 Mar 2021
Biconilog Antenna	EMCO	3142B	1575	26-2000MHz	10 May 2020
Log Periodic Antenna	ETS	3148	00023845	200-2000MHz	02 Aug 2020
Horn Antenna	ETS	3115	5061	1-18GHz	30 Apr 2020
Preamplifier	Com-Power	PAM-118A	551016	500MHz-18GHz	17 Mar 2021
Preamplifier	Com-Power	PA-103	161040	1-1000MHz	23 Mar 2021
Signal Generator	Marconi	2024	112255/164	9KHz-2.4GHz	19 Sep 2021
Attenuator(20dB)	Weinschel	WA 35-20-33	A164	DC-8.5GHz	Cal on use
Attenuator(20dB)	Aeroflex\Weinschel	23-20-34	BH7876	DC-18GHz	Cal on use
Load(50ohm)	Db products	--	--	DC-18GHz(15W)	Cal on use
Power supply	Pyramid	PS-36KX	--	12-18 Vdc, 35A	--
Multimeter	Fluke	8842A	5021295	---	19 Dec 2020

ULTRATECH GROUP OF LABS

3000 Bristol Circle, Oakville, Ontario, Canada L6H 6G4
 Tel. #: 905-829-1570, Fax. #: 905-829-8050, Email: vic@ultratech-labs.com, Website: <http://www.ultratech-labs.com>

File #: 20ICOM-524_F80RSS182
 May 6, 2020

All test results contained in this engineering test report are traceable to National Institute of Standards and Technology (NIST)

6.10. ISED Digital /Unintentional Tests

6.10.1. Power line Conducted Emissions IC-M424G

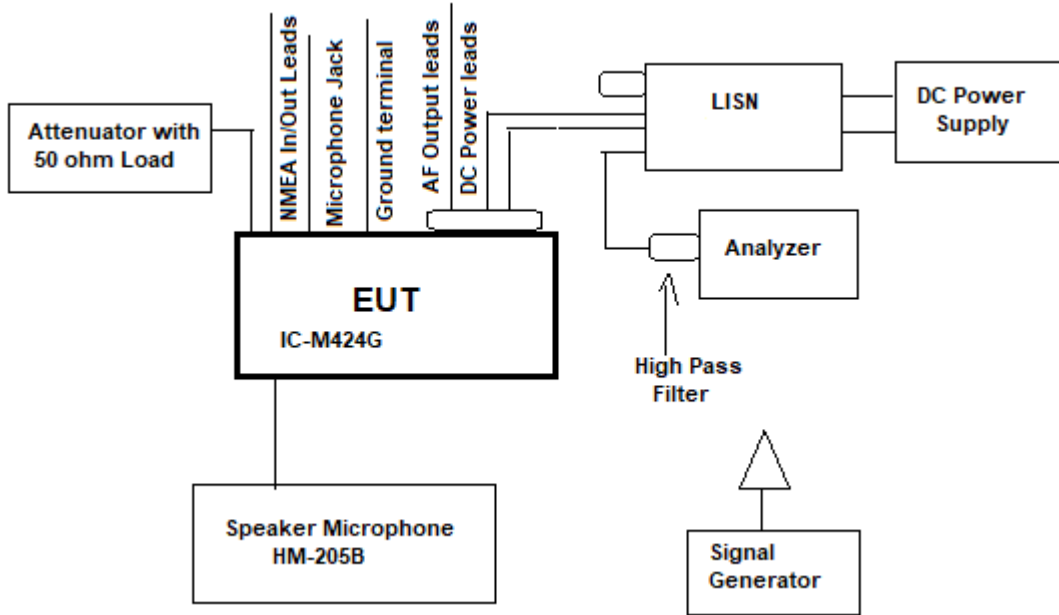

Test Instrument	Manufacturer	Model No	Serial No	Frequency Range	Cal Due date
Analyzer	Agilent	E7401A	US40240432	9KHz-1.5GHz	03 Jun 2020
Attenuator	Rhode&Schwarz	EZ-25	830164/006	150KHz-30MHz	07 Jun 2020
LISN	UEL	ULTLISN	ULT02&03	150KHz-30MHz	25 Nov 2020
Signal Generator	Marconi	2024	112255/164	9KHz-2.4GHz	19 sep 2021
Power supply	Pyramid	PS-36KX	--	12-18 Vdc, 35A	--
Multimeter	Fluke	8842A	5021295	---	19 Dec 2020

6.10.2. Power line Conducted Emissions IC-M400BB

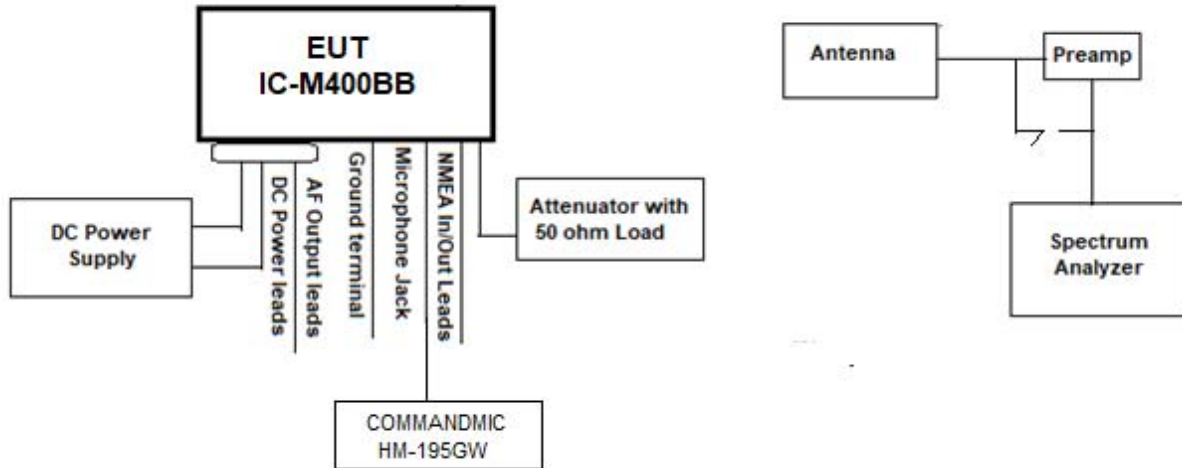

Test Instrument	Manufacturer	Model No	Serial No	Frequency Range	Cal Due date
Spectrum Analyzer	Rohde & Schwarz	ESU40	100037	20Hz-40GHz	18 Mar 2021
Biconilog Antenna	EMCO	3142B	1575	26-2000MHz	10 May 2020
Horn Antenna	ETS	3115	5061	1-18GHz	30 Apr 2020
Preamplifier	Com-Power	PAM-118A	551052	500MHz-18GHz	24 Jul 2020
Attenuator(20dB)	Weinschel	WA 35-20-33	A164	DC-8.5GHz	Cal on use
Attenuator(20dB)	Aeroflex\Weinschel	23-20-34	BH7876	DC-18GHz	Cal on use
Load(50ohm)	Db products	--	--	DC-18GHz(15W)	Cal on use
Power supply	Pyramid	PS-36KX	--	12-18 Vdc, 35A	--
Multimeter	Fluke	8842A	5021295	---	19 Dec 2020

6.10.3. Radiated Emissions IC-M424G-Unintentional/Digital

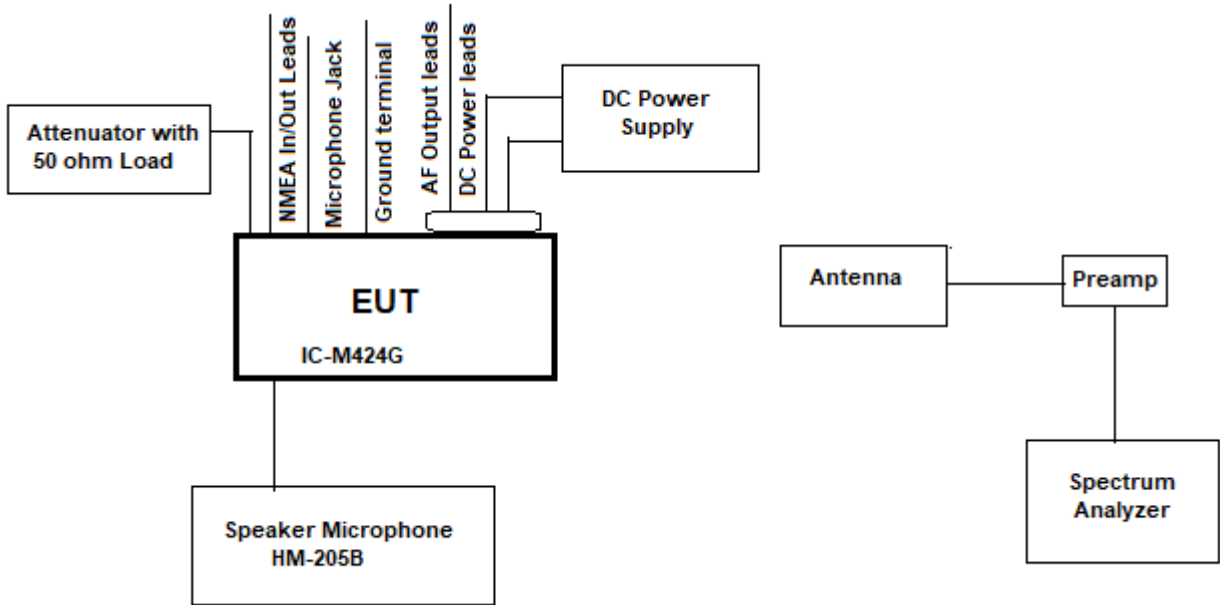

Test Instrument	Manufacturer	Model No	Serial No	Frequency Range	Cal Due date
Spectrum Analyzer	Rohde & Schwarz	ESU40	100037	20Hz-40GHz	18 Mar 2021
Biconilog Antenna	EMCO	3142B	1575	26-2000MHz	10 May 2020
Horn Antenna	ETS	3115	5061	1-18GHz	30 Apr 2020
Preamplifier	Com-Power	PAM-118A	551016	500MHz-18GHz	17 Mar 2021
Signal Generator	Marconi	2024	112255/164	9KHz-2.4GHz	19 Sep 2021
Attenuator(20dB)	Weinschel	WA 35-20-33	A164	DC-8.5GHz	Cal on use
Attenuator(20dB)	Aeroflex\Weinschel	23-20-34	BH7876	DC-18GHz	Cal on use
Load(50ohm)	Db products	--	--	DC-18GHz(15W)	Cal on use
Power supply	Pyramid	PS-36KX	--	12-18 Vdc, 35A	--
Multimeter	Fluke	8842A	5021295	---	19 Dec 2020

6.10.4. Radiated Emissions IC- M400BB-Unintentional

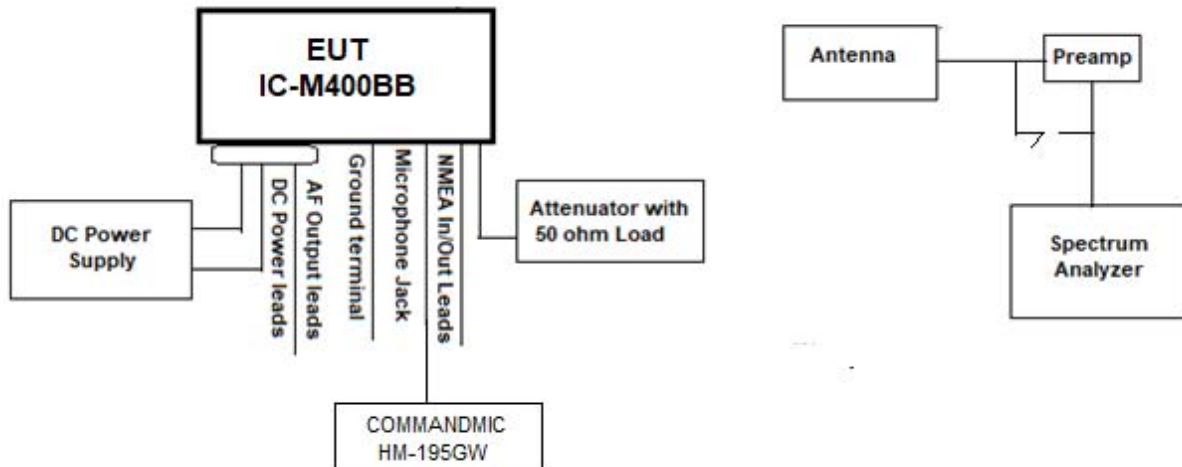

Test Instrument	Manufacturer	Model No	Serial No	Frequency Range	Cal Due date
Spectrum Analyzer	Rohde & Schwarz	ESU40	100037	20Hz-40GHz	18 Mar 2021
Biconilog Antenna	EMCO	3142B	1575	26-2000MHz	10 May 2020
Horn Antenna	ETS	3115	5061	1-18GHz	30 Apr 2020
Preamplifier	Com-Power	PAM-118A	551052	500MHz-18GHz	24 Jul 2020
Attenuator(20dB)	Weinschel	WA 35-20-33	A164	DC-8.5GHz	Cal on use
Attenuator(20dB)	Aeroflex\Weinschel	23-20-34	BH7876	DC-18GHz	Cal on use
Load(50ohm)	Db products	--	--	DC-18GHz(15W)	Cal on use
Power supply	Pyramid	PS-36KX	--	12-18 Vdc, 35A	--
Multimeter	Fluke	8842A	5021295	---	19 Dec 2020

EXHIBIT 7. MEASUREMENT UNCERTAINTY

The measurement uncertainties stated were calculated in accordance with the requirements of CISPR 16-4-2 @ IEC:2003 and JCGM 100:2008 (GUM 1995) – Guide to the Expression of Uncertainty in Measurement.

7.1. LINE CONDUCTED EMISSION MEASUREMENT UNCERTAINTY

	Line Conducted Emission Measurement Uncertainty (9 kHz – 30 MHz):	Measured	Limit
u_c	Combined standard uncertainty: $u_c(y) = \sqrt{\sum_{i=1}^m u_i^2(y)}$	± 1.44	± 1.8
U	Expanded uncertainty U: $U = 2u_c(y)$	± 2.89	± 3.6

7.2. RADIATED EMISSION MEASUREMENT UNCERTAINTY

	Radiated Emission Measurement Uncertainty @ 3m, Horizontal (30-1000 MHz):	Measured	Limit
u_c	Combined standard uncertainty: $u_c(y) = \sqrt{\sum_{i=1}^m u_i^2(y)}$	± 2.15	± 2.6
U	Expanded uncertainty U: $U = 2u_c(y)$	± 4.30	± 5.2

	Radiated Emission Measurement Uncertainty @ 3m, Vertical (30-1000 MHz):	Measured	Limit
u_c	Combined standard uncertainty: $u_c(y) = \sqrt{\sum_{i=1}^m u_i^2(y)}$	± 2.14	± 2.6
U	Expanded uncertainty U: $U = 2u_c(y)$	± 4.29	± 5.2

	Radiated Emission Measurement Uncertainty @ 3 m, Horizontal & Vertical (1 – 18 GHz):	Measured	Limit
u_c	Combined standard uncertainty: $u_c(y) = \sqrt{\sum_{i=1}^m u_i^2(y)}$	± 1.52	Under consideration
U	Expanded uncertainty U: $U = 2u_c(y)$	± 3.04	Under consideration

EXHIBIT 8. MEASUREMENT METHODS

8.1. CONDUCTED POWER MEASUREMENTS

The following shall be applied to the combination(s) of the radio device and its intended antenna(e).

- If the RF level is user adjustable, all measurements shall be made with the highest power level available to the user for that combination.
- The following method of measurement shall apply to both conducted and radiated measurements.
 - The radiated measurements are performed at the Ultratech Calibrated Open Field Test Site.
 - The measurement shall be performed using normal operation of the equipment with modulation.
- Test procedure shall be as follows:

Step 1: Duty Cycle measurements if the transmitter's transmission is transient

- Using a EMI Receiver with the frequency span set to 0 Hz and the sweep time set at a suitable value to capture the envelope peaks and the duty cycle of the transmitter output signal;
- The duty cycle of the transmitter, $x = \text{Tx on} / (\text{Tx on} + \text{Tx off})$ with $0 < x < 1$, is measure and recorded in the test report. For the purpose of testing, the equipment shall be operated with a duty cycle that is equal or more than 0.1.

Step 2: Calculation of Average EIRP. See Figure 1

- The average output power of the transmitter shall be determined using a wideband, calibrated RF average power meter with the power sensor with an integration period that exceeds the repetition period of the transmitter by a factor 5 or more. The observed value shall be recorded as "A" (in dBm);
- The e.i.r.p. shall be calculated from the above measured power output "A", the observed duty cycle x , and the applicable antenna assembly gain "G" in dBi, according to the formula:

$$\text{EIRP} = \text{A} + \text{G} + 10\log(1/x)$$

{ $X = 1$ for continuous transmission $\Rightarrow 10\log(1/x) = 0 \text{ dB}$ }

Figure 1.

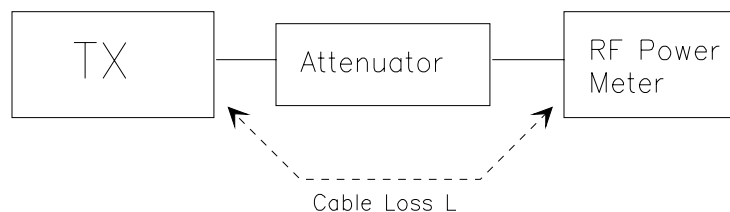

8.2. RADIATED POWER MEASUREMENTS (ERP & EIRP) USING SUBSTITUTION METHOD

8.2.1. Maximizing RF Emission Level (E-Field)

- (a) The measurements was performed with full rf output power and modulation.
- (b) Test was performed at listed 3m open area test site (listed with FCC, IC, ITI, NVLAP, ACA & VCCI).
- (c) The transmitter under test was placed at the specified height on a non-conducting turntable (80 cm height)
- (d) The BICONILOG antenna (20 MHz to 1 GHz) or HORN antenna (1 GHz to 18 GHz) was used for measuring.
- (e) Load an appropriate correction factors file in EMI Receiver for correcting the field strength reading level

Total Correction Factor recorded in the EMI Receiver = Cable Loss + Antenna Factor
 $E \text{ (dBuV/m)} = \text{Reading (dBuV)} + \text{Total Correction Factor (dB/m)}$

- (f) Set the EMI Receiver and #2 as follows:

Center Frequency: test frequency
Resolution BW: 100 kHz
Video BW: same
Detector Mode: positive
Average: off
Span: 3 x the signal bandwidth

- (g) The test antenna was lowered or raised from 1 to 4 meters until the maximum signal level was detected.
- (h) The transmitter was rotated through 360° about a vertical axis until a higher maximum signal was received.
- (i) The test antenna was lowered or raised again from 1 to 4 meters until a maximum was obtained. This level was recorded.
- (j) The recorded reading was corrected to the true field strength level by adding the antenna factor, cable loss and subtracting the pre-amplifier gain.
- (k) The above steps were repeated with both transmitters' antenna and test receiving antenna placed in vertical and horizontal polarization. Both readings with the antennas placed in vertical and horizontal polarization shall be recorded.
- (l) Repeat for all different test signal frequencies

8.2.2. Measuring the EIRP of Spurious/Harmonic Emissions using Substitution Method

(a) Set the EMI Receiver (for measuring E-Field) and Receiver #2 (for measuring EIRP) as follows:

Center Frequency: equal to the signal source
Resolution BW: 100 kHz
Video BW: VBW > RBW
Detector Mode: positive
Average: off
Span: 3 x the signal bandwidth

(b) Load an appropriate correction factors file in EMI Receiver for correcting the field strength reading level

Total Correction Factor recorded in the EMI Receiver = Cable Loss + Antenna Factor
 $E \text{ (dBuV/m)} = \text{Reading (dBuV)} + \text{Total Correction Factor (dB/m)}$

(c) Select the frequency and E-field levels obtained in the Section 8.2.1 for ERP/EIRP measurements.

(d) Substitute the EUT by a signal generator and one of the following transmitting antenna (substitution antenna):

- ◆ DIPOLE antenna for frequency from 30-1000 MHz or
- ◆ HORN antenna for frequency above 1 GHz }
(e) Mount the transmitting antenna at 1.5 meter high from the ground plane.

(f) Use one of the following antenna as a receiving antenna:

- ◆ DIPOLE antenna for frequency from 30-1000 MHz or
- ◆ HORN antenna for frequency above 1 GHz }.

(g) If the DIPOLE antenna is used, tune it's elements to the frequency as specified in the calibration manual.

(h) Adjust both transmitting and receiving antenna in a VERTICAL polarization.

(i) Tune the EMI Receivers to the test frequency.

(j) Lower or raise the test antenna from 1 to 4 meters until the maximum signal level was detected.

(k) The transmitter was rotated through 360° about a vertical axis until a higher maximum signal was received.

(l) Lower or raise the test antenna from 1 to 4 meters until the maximum signal level was detected.

(m) Adjust input signal to the substitution antenna until an equal or a known related level to that detected from the transmitter was obtained in the test receiver.

(n) Record the power level read from the Average Power Meter and calculate the ERP/EIRP as follows:

$$P = P1 - L1 = (P2 + L2) - L1 = P3 + A + L2 - L1$$

$$\text{EIRP} = P + G1 = P3 + L2 - L1 + A + G1$$

$$\text{ERP} = \text{EIRP} - 2.15 \text{ dB}$$

$$\text{Total Correction factor in EMI Receiver \# 2} = L2 - L1 + G1$$

Where: P: Actual RF Power fed into the substitution antenna port after corrected.
P1: Power output from the signal generator
P2: Power measured at attenuator A input
P3: Power reading on the Average Power Meter
EIRP: EIRP after correction
ERP: ERP after correction

(o) Adjust both transmitting and receiving antenna in a HORIZONTAL polarization, then repeat step (k) to (o)

(p) Repeat step (d) to (o) for different test frequency

(q) Repeat steps (c) to (j) with the substitution antenna oriented in horizontal polarization.

(r) Actual gain of the EUT's antenna is the difference of the measured EIRP and measured RF power at the RF port. Correct the antenna gain if necessary.

Figure 2

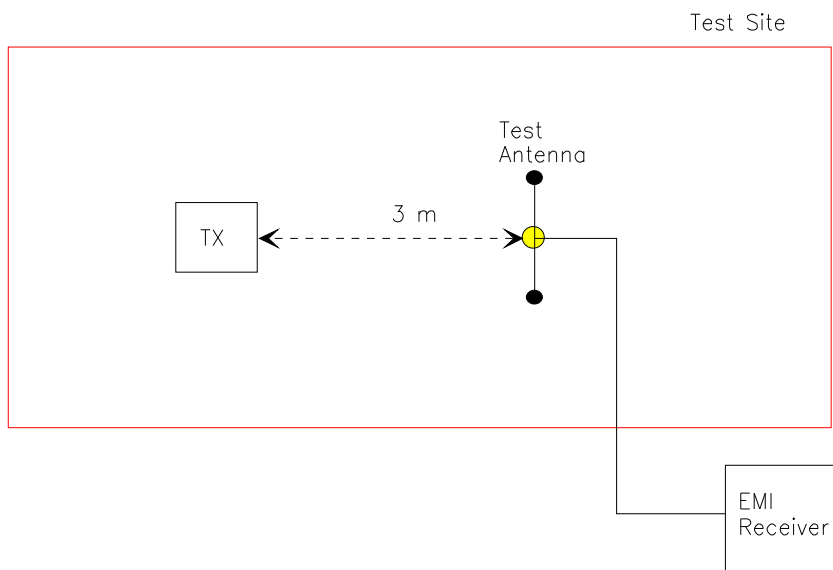
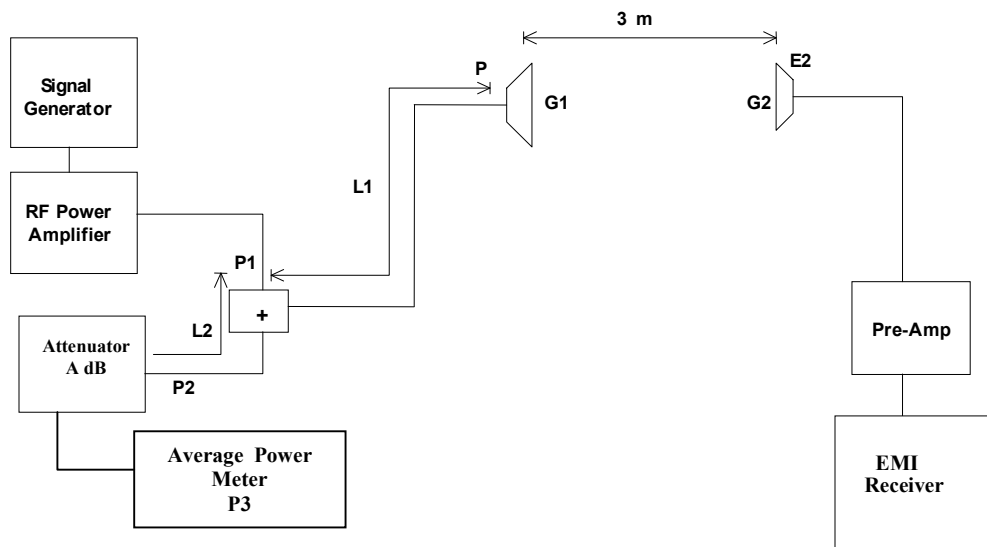

Figure 3



8.3. FREQUENCY STABILITY

Refer to § 2.1055.

- (a) The frequency stability shall be measured with variation of ambient temperature as follows: From -30 to +50 centigrade except that specified in subparagraph (2) & (3) of this paragraph.
- (b) Frequency measurements shall be made at extremes of the specified temperature range and at intervals of not more than 10 centigrade through the range. A period of time sufficient to stabilize all of the components of the oscillator circuit at each temperature level shall be allowed prior to frequency measurement. The short-term transient effects on the frequency of the transmitter due to keying (except for broadcast transmitters) and any heating element cycling normally occurring at each ambient temperature level also shall be shown. Only the portion or portions of the transmitter containing the frequency determining and stability circuitry need be subjected to the temperature variation test.
- (d) The frequency stability supply shall be measured with variation of primary supply voltage as follows:
 - (1) Vary primary supply voltage from 85 to 115 percent of the nominal value for other than hand carried battery equipment.
 - (2) For hand carried, battery powered equipment, reduce primary supply voltage to the battery operating end point which shall be specified by the manufacturer.
 - (3) The supply voltage shall be measured at the input to the cable normally provide with the equipment, or at the power supply terminals if cables are not normally provided. Effects on frequency of transmitter keying (except for broadcast transmitters) and any heating element cycling at the nominal supply voltage and at each extreme also shall be shown.
- (e) When deemed necessary, the Commission may require tests of frequency stability under conditions in addition to those specifically set out in paragraphs (a), (b), (c) and (d) of this section. (For example, measurements showing the effect of proximity to large metal objects, or of various types of antennas, may be required for portable equipment).

8.4. EMISSION MASK

Voice or Digital Modulation Through a Voice Input Port @ 2.1049(c)(i):- The transmitter was modulated by a 2.5 KHz tone signal at an input level 16 dB greater than that required to produce 50% modulation (e.g.: ± 2.5 KHz peak deviation at 1 KHz modulating frequency). The input level was established at the frequency of maximum response of the audio modulating circuit.

Digital Modulation Through a Data Input Port @ 2.1049(h):- Transmitters employing digital modulation techniques - when modulated by an input signal such that its amplitude and symbol rate represent the maximum rated conditions under which the equipment will be operated. The signal shall be applied through any filter networks, pseudo-random generators or other devices required in normal service. Additionally, the Emission Masks shall be shown for operation with any devices used for modifying the spectrum when such devices are operational at the discretion of the user.

The following EMI Receiver bandwidth shall be used for measurement of Emission Mask/Out-of-Band Emission Measurements:

For 25 kHz Channel Spacing: RBW = 300 Hz
For 12.5 kHz or 6.25 kHz Channel Spacings: RBW = 100 Hz

The all cases the Video Bandwidth shall be equal or greater than the measuring bandwidth.

8.5. SPURIOUS EMISSIONS (CONDUCTED)

With transmitter modulation characteristics described in Out-of-Band Emissions measurements @ 2.1049, the transmitter spurious and harmonic emissions were scanned. The spurious and harmonic emissions were measured with the EMI Receiver controls set as RBW = 30 kHz minimum , VBW \geq RBW and SWEEP TIME = AUTO). The transmitter was operated at a full rated power output, and modulated as follows:

FCC 47 CFR 2.1057 - Frequency Spectrum to be investigated: The spectrum was investigated from the lowest radio generated in the equipment up to at least the 10th harmonic of the carrier frequency or to the highest frequency practicable in the present state of the art of measuring techniques, whichever is lower. Particular attention should be paid to harmonics and subharmonics of the carrier frequency. Radiation at the frequencies of multiplier stages should be checked. The amplitude of spurious emissions which are attenuated more than 20 dB below the permissible value need not be reported.

FCC 47 CFR 2.1051 - Spurious Emissions at Antenna Terminal: The radio frequency voltage or powers generated within the equipment and appearing on a spurious frequency shall be checked at the equipment output terminals when properly loaded with a suitable artificial antenna. Curves or equivalent data shall show the magnitude of the harmonic and other spurious emission that can be detected when the equipment is operated under the conditions specified in 2.1049 as appropriate. The magnitude of spurious emissions which are attenuated more than 20 dB below the permissible value need not be specified.