



INSTRUCTION MANUAL

HF TRANSCEIVER

IC-F8100



This device complies with Part 15 of the FCC Rules. Operation is subject to the condition that this device does not cause harmful interference.

Icom Inc.

FOREWORD

Thank you for purchasing this Icom product. The IC-F8100 HF TRANSCEIVER is designed and built with Icom's state of the art technology and craftsmanship. With proper care, this product should provide you with years of trouble-free operation.

We appreciate you making the IC-F8100 your radio of choice, and hope you agree with Icom's philosophy of "technology first." Many hours of research and development went into the design of your IC-F8100.

◆ FEATURES

- ALE (Automatic Link Establishment)/Sel-call capability
- Digital Signal Processor (DSP) allows flexible filter selection
- Full-dot matrix LCD for a variety of information

IMPORTANT

READ THIS INSTRUCTION MANUAL CAREFULLY before attempting to operate the transceiver.

SAVE THIS INSTRUCTION MANUAL. This manual contains important safety and operating instructions for the IC-F8100.

EXPLICIT DEFINITIONS

WORD	DEFINITION
⚠ DANGER!	Personal death, serious injury or an explosion may occur.
⚠ WARNING!	Personal injury, fire hazard or electric shock may occur.
CAUTION	Equipment damage may occur.
NOTE	Recommended for optimum use. No risk of personal injury, fire or electric shock.

Icom, Icom Inc. and the Icom logo are registered trademarks of Icom Incorporated (Japan) in Japan, the United States, the United Kingdom, Germany, France, Spain, Russia and/or other countries.
All other products or brands are registered trademarks or trademarks of their respective holders.

TABLE OF CONTENTS

FOREWORD	i
IMPORTANT	i
EXPLICIT DEFINITIONS	i
TABLE OF CONTENTS	i
PRECAUTIONS	ii
FCC INFORMATION	iii
SAFETY TRAINING INFORMATION	iii
INFORMATION EN MATIÈRE DE SÉCURITÉ	iv
1 PANEL DESCRIPTION	1-7
■ Controller (Front panel or HM-192).....	1
■ Rear panel	4
■ LCD screen.....	5
■ AD-119 Optional Junction Box.....	7
2 BASIC OPERATION	8-11
■ Power ON	8
■ Selecting display mode.....	8
■ Selecting a channel	8
■ Setting audio volume	9
■ Squelch function	9
■ Scan function	9
■ Mode selection.....	10
■ Key Lock function.....	10
■ VFO operation.....	11
3 RECEIVE AND TRANSMIT	12-18
■ Basic voice transmit/receive	12
■ Functions for transmit	13
■ Functions for receive.....	15
4 SELCALL/ALE OPERATION	19-33
■ Selcall/ALE	19
5 MENU SCREEN	34-46
■ Edit Menu.....	34
■ User Menu	35
■ Admin Menu.....	38
■ CPU Reset.....	46
6 CONNECTION AND INSTALLATION	47-60
■ Supplied accessories.....	47
■ Connections.....	49
■ Ground connection	51
■ Power source	51
■ Antenna	52
■ CFU-F8100 (Optional Cooling Fan)	52
■ RMK-6 (Optional Separation kit).....	53
■ HM-192 (Optional Remote control microphone)	
.....	55
■ Mounting.....	56
■ Fuse replacement.....	58
■ Connector information for AD-119	59
7 SPECIFICATIONS	61
8 OPTIONS	62



N33

Versions of the IC-F8100 which display the "N33" symbol on the serial number seal, comply with Standard Australia Specification No. AS/NZS 4770: 2000.

PRECAUTIONS

⚠ **DANGER HIGH RF VOLTAGE! NEVER** attach an antenna or internal antenna connector during transmission. This may result in an electrical shock or burn.

⚠ **WARNING! NEVER** operate the transceiver with a headset or other audio accessories at high volume levels. Hearing experts advise against continuous high volume operation. If you experience a ringing in your ears, reduce the volume or discontinue use.

⚠ **WARNING! NEVER** operate or touch the transceiver with wet hands. This may result in an electric shock or damage to the transceiver.

⚠ **WARNING! NEVER** apply AC power to the [DC13.8V] socket on the transceiver rear panel. This could cause a fire or damage the transceiver.

⚠ **WARNING! NEVER** apply more than 16 V DC to the [DC13.8V] socket on the transceiver rear panel, or use reverse polarity. This could cause a fire or damage the transceiver.

⚠ **WARNING! NEVER** let metal, wire or other objects protrude into the transceiver or into connectors on the rear panel. This may result in an electric shock.

⚠ **WARNING! ALWAYS** use the supplied Black and red cables with fuse holders. After connecting the fuse holders, **NEVER** cut the DC power cable between the DC plug and fuse holder. If an incorrect connection is made after cutting, the transceiver might be damaged.

⚠ **WARNING!** Immediately turn OFF the transceiver power and remove the power cable if it emits an abnormal odor, sound or smoke. Contact your Icom dealer or distributor for advice.

CAUTION: NEVER change the internal settings of the transceiver. This may reduce transceiver performance and/or damage to the transceiver.

In particular, incorrect settings for transmitter circuits, such as output power, idling current, and so on, might damage the expensive final devices.

The transceiver warranty does not cover any problems caused by unauthorized internal adjustment.

CAUTION: NEVER install the transceiver in a place without adequate ventilation. Heat dissipation may be reduced, and the transceiver may be damaged.

DO NOT use or place the transceiver in direct sunlight or in areas with temperatures below -30°C ($+32^{\circ}\text{F}$) or above $+60^{\circ}\text{C}$ ($+122^{\circ}\text{F}$).

The basic operations, transmission and reception of the transceiver are guaranteed within the specified operating temperature range. However, the LCD display may not be operate correctly, or show an indication in the case of long hours of operation, or after being placed in extremely cold areas.

DO NOT use harsh solvents such as benzine or alcohol when cleaning, as they will damage the transceiver surfaces.

DO NOT push the PTT switch when you don't actually desire to transmit.

DO NOT place the transceiver against walls or putting anything on top of the transceiver. This may overheat the transceiver.

Always place unit in a secure place to avoid inadvertent use by children.

BE CAREFUL! If you use a linear amplifier, set the transceiver's RF output power to less than the linear amplifier's maximum input level, otherwise, the linear amplifier will be damaged.

BE CAREFUL! The transceiver will become hot when operating the transceiver continuously for long periods of time.

USE only the specified microphone. Other manufacturers' microphones have different pin assignments, and connection to the IC-F8100 may damage the transceiver or microphone.

During mobile operation, **NEVER** place the transceiver where air bag deployment may be obstructed.

During mobile operation, **DO NOT** place the transceiver where hot or cold air blows directly onto it.

During mobile operation, **DO NOT** operate the transceiver without running the vehicle's engine. When the transceiver's power is ON and your vehicle's engine is OFF, the vehicle's battery will soon become exhausted.

Make sure the transceiver power is OFF before starting the vehicle engine. This will avoid possible damage to the transceiver by ignition voltage spikes.

During maritime mobile operation, keep the transceiver and microphone as far away as possible from the magnetic navigation compass to prevent erroneous indications.

Turn OFF the transceiver's power and/or disconnect the DC power cable when you will not use the transceiver for long period of time.

KEEP the transceiver away from the heavy rain, and Never immerse it in the water. The transceiver meets IP54* requirements for dust-protection and splash resistance.

However, once the transceiver has been dropped, dust-protection and splash resistance cannot be guaranteed due to the fact that the transceiver may be cracked, or the waterproof seal damaged, and so on.

* Only when the supplied microphone is attached.

1

2

3

4

5

6

7

8

FCC INFORMATION

• FOR CLASS A UNINTENTIONAL RADIATORS:

This equipment has been tested and found to comply with the limits for a Class A digital device, pursuant to part 15 of the FCC Rules. These limits are designed to provide reasonable protection against harmful interference when the equipment is operated in a commercial environment. This equipment generates, uses, and can radiate radio frequency energy and, if not installed and used in accordance with the instruction manual, may cause harmful interference to radio communications. Operation of this equipment in a residential area is likely to cause harmful interference in which case the user will be required to correct the interference at his own expense.

CAUTION: Changes or modifications to this transceiver, not expressly approved by Icom Inc., could void your authority to operate this transceiver under FCC regulations.

SAFETY TRAINING INFORMATION



Your Icom radio generates RF electromagnetic energy during transmit mode. This radio is designed for and classified as “Occupational Use Only”, meaning it must be used only during the course of employment by individuals aware of the hazards, and the ways to minimize such hazards. This radio is **NOT** intended for use by the “General Population” in an uncontrolled environment.

- For compliance with FCC and Industry Canada RF Exposure Requirements, the transmitter antenna installation shall comply with the following two conditions:
 1. The transmitter antenna gain shall not exceed 0 dBi.
 2. The antenna is required to be located outside of a vehicle and kept at a distance of 80 centimeters or more between the transmitting antenna of this device and any persons during operation. For small vehicle as worst case, the antenna shall be located on the roof top at any place on the centre line along the vehicle in order to achieve 80 centimeters separation distance. In order to ensure this distance is met, the installation of the antenna must be mounted at least 80 centimeters away from the nearest edge of the vehicle in order to protect against exposure to bystanders.
 3. Transmit only when people outside the vehicle are at least the recommended minimum distance of 160 centimeters away from the properly installed antenna. This separation distance will ensure that there is sufficient distance from a properly installed externally-mounted antenna to satisfy the RF exposure requirements in the applicable RF exposure compliance standards.



To ensure that your exposure to RF electromagnetic energy is within the FCC allowable limits for occupational use, always adhere to the following guidelines:

- **DO NOT** operate the radio without a proper antenna attached, as this may damage the radio and may also cause you to exceed FCC RF exposure limits. A proper antenna is the antenna supplied with this radio by the manufacturer or an antenna specifically authorized by the manufacturer for use with this radio.
- **DO NOT** transmit for more than 50% of total radio use time (“50% duty cycle”). Transmitting more than 50% of the time can cause FCC RF exposure compliance requirements to be exceeded. The radio is transmitting when the TX/RX indicator lights red. You can cause the radio to transmit by pressing the “PTT” switch.

Electromagnetic Interference/Compatibility

During transmissions, your Icom radio generates RF energy that can possibly cause interference with other devices or systems. To avoid such interference, turn OFF the radio in areas where signs are posted to do so. **DO NOT** operate the transmitter in areas that are sensitive to electromagnetic radiation such as hospitals, aircraft, and blasting sites.

INFORMATION EN MATIÈRE DE SÉCURITÉ



AVERTISSEMENT

Votre radio Icom produit une énergie électromagnétique de radiofréquences (RF), en mode de transmission. Cette radio est conçue pour un «usage professionnel seulement» et classée comme tel, ce qui signifie qu'elle doit être utilisée uniquement dans le cadre d'un travail par des personnes conscientes des dangers et des mesures visant à minimiser ces dangers. Elle **N'EST PAS** conçue pour une «utilisation grand public», dans un environnement non contrôlé.

- Afin de satisfaire aux exigences de la FCC et d'Industrie Canada en matière d'exposition aux RF, il est nécessaire que l'antenne soit installée conformément aux trois conditions suivantes:
 1. Le gain de l'antenne du radio émetteur ne doit pas dépasser 0dBi.
 2. Il faut que l'antenne émettrice de cet appareil soit placée à l'extérieur d'un véhicule et tenue éloignée d'au moins 80 centimètres de toute personne pendant le fonctionnement. Dans le pire des cas, pour un petit véhicule, l'antenne doit être placée sur le toit, n'importe où dans l'axe central du véhicule, afin de respecter une distance de 80 cm du bord le plus rapproché du véhicule et ainsi éviter que les personnes présentes soient exposées.
 3. Émettre uniquement lorsque les personnes à l'extérieur du véhicule se trouvent à au moins la distance minimale recommandée de 160 cm de l'antenne correctement installée. Cette distance de sécurité assurera que les personnes soient placées suffisamment loin d'une antenne correctement fixée à l'extérieur pour satisfaire aux exigences en matière d'exposition aux RF, en vertu des normes de conformité applicables.



MISE EN GARDE

Afin de vous assurer que votre exposition à une énergie électromagnétique de RF se situe dans les limites permises par la FCC pour une utilisation grand public, veuillez en tout temps respecter les directives suivantes:

- **NE PAS** faire fonctionner la radio sans qu'une antenne appropriée y soit fixée, car ceci risque d'endommager la radio et causer une exposition supérieure aux limites établies par la FCC. L'antenne appropriée est celle qui est fournie avec cette radio par le fabricant ou une antenne spécialement autorisée par le fabricant pour être utilisée avec cette radio.
- **NE PAS** émettre pendant plus de 50 % du temps total d'utilisation de l'appareil («50 % du facteur d'utilisation»). Émettre pendant plus de 50 % du temps total d'utilisation peut causer une exposition aux RF supérieure aux limites établies par la FCC. La radio est en train d'émettre lorsque le témoin du mode de transmission s'affiche sur l'écran ACL. La radio émettra si vous appuyez sur le bouton du microphone.

Interférence électromagnétique et compatibilité

En mode de transmission, votre radio Icom produit de l'énergie de RF qui peut provoquer des interférences avec d'autres appareils ou systèmes. Pour éviter de telles interférences, mettez la radio hors tension dans les secteurs où une signalisation l'exige. **NE PAS** faire fonctionner l'émetteur dans des secteurs sensibles au rayonnement électromagnétique tels que les hôpitaux, les aéronefs et les sites de dynamitage.

■ Controller (Front panel or HM-192)

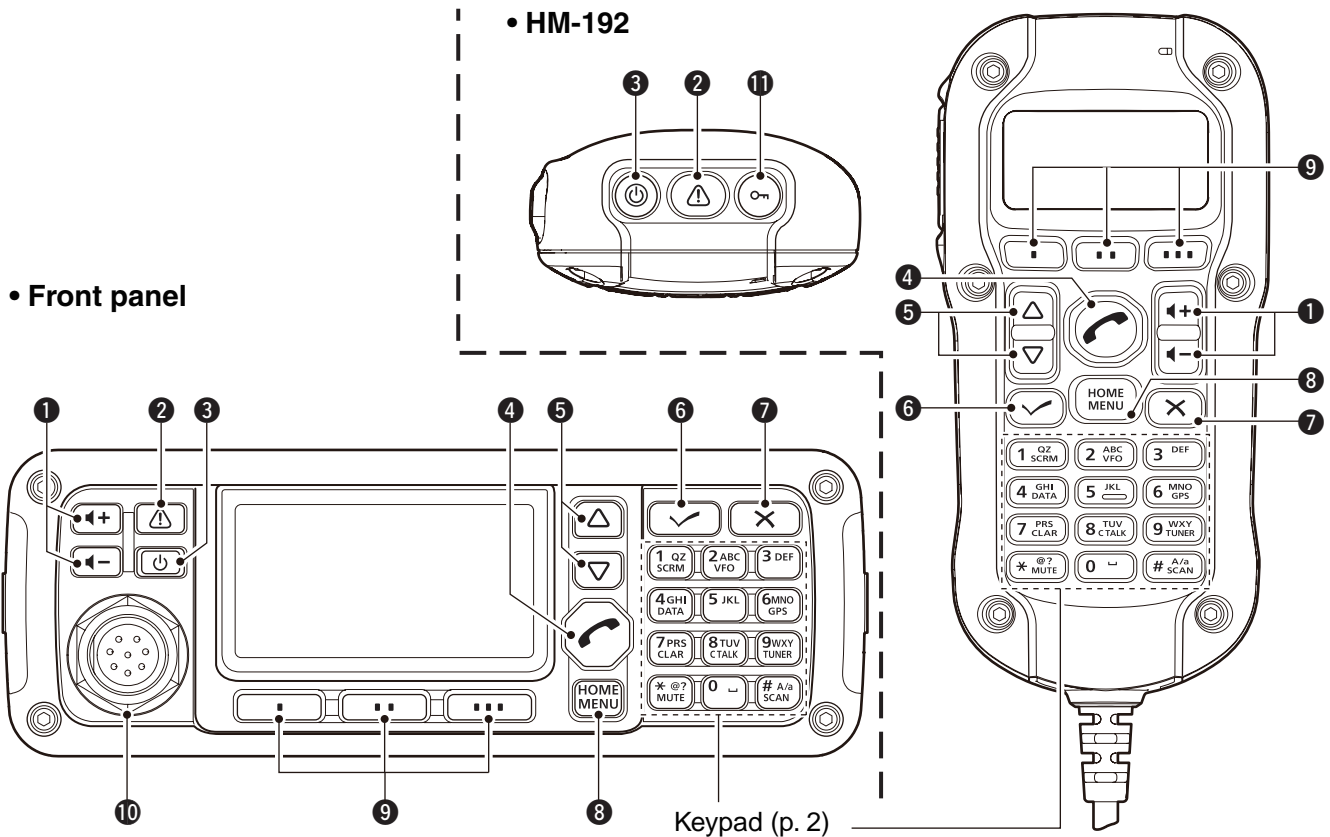

• Common

① VOLUME KEYS [◀+]/[▶-](p. 9)

Adjusts the audio output level.

② EMERGENCY KEY [▲]

NOTE: While in the VFO mode, the Emergency key cannot be used.

- ➔ Push to enter the Emergency channel list.
 - Push again to return to the normal operating screen.
- ➔ Hold down for 1 second to transmit the Selcall and RFDS (Royal Flying Doctor Service) calls to the specified Selcall addresses in sequential order.

NOTE: RFDS calls are available in only the AUS versions.

③ POWER KEY [⏻]

- ➔ When the transceiver's power is OFF:
 - Push to turn ON the transceiver power.
 - First, turn ON the DC power source.
- ➔ When the transceiver's power is ON:
 - Hold down for 2 seconds to turn OFF the power.

④ CALL KEY [☎]

- ➔ Push to enter the Call menu.
- Push again to go to the next screen in the Call menu.

⑤ UP/DOWN KEYS [▲]/[▼]

Selects the operating channel, the items in the Menu mode, and so on.

⑥ ENTER KEY [✓]

Push to enter or exit the selected Menu in the Menu screen.

⑦ CLEAR KEY [X]

- ➔ Push to exit the Menu screen.
- ➔ Push to return to the previous screen in the Call menu.

⑧ HOME/MENU KEY [HOME] [MENU](HOME)

- ➔ Push to return to the home display.
- ➔ Hold down for 1 second to enter the Menu screen.

⑨ FUNCTION KEYS [▪]/[▪▪]/[▪▪▪]

- ➔ Push to select the function that is displayed above each key on the LCD display.
- The functions vary, depending on the selected menu and the operating mode.

• Front panel

⑩ MICROPHONE CONNECTOR [MIC]

Connects to only the microphone supplied with the transceiver.

NOTE: NEVER connect the HM-192 or any other microphone here. This could damage the transceiver and/or the microphone.

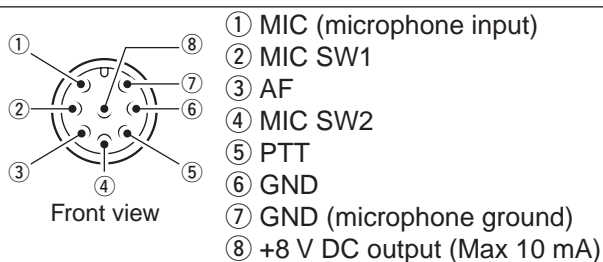

• HM-192

⑪ LOCK KEY [O-L]

Hold down for 1 second to set the Key lock function to ALL, NUMERIC KEY or OFF.

◇ Keypad

- Inputs numbers for the Clock Setting.
- Inputs numbers, characters or letters for the Sel-call direct input.

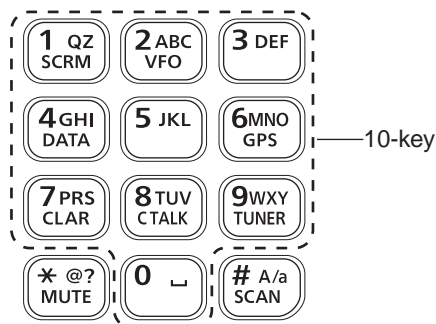

• Selectable characters

KEY	INPUT	KEY	INPUT
1 QZ SCRM	1 Q Z q z	8 TUV CTALK	8 T U V t u v
2 ABC VFO	2 A B C a b c	9 WXY TUNER	9 W X Y w x y
3 DEF	3 D E F d e f	0 []	0 (space)
4 GHI DATA	4 G H I g h i	* @? MUTE	, . ; ? : " ' ` / ! @ # \$ % ^ & * () _ - + = \ ~ < > { } []
5 JKL	5 J K L j k l	# A/a SCAN	Upper/Lower case letters/Numbers
6 MNO GPS	6 M N O m n o		
7 PRS CLAR	7 P R S p r s		

◇ Keypad (Continued)

VFO KEY [VFO]



Push to turn the VFO mode ON or OFF.
// **NOTE:** The VFO mode operation can be inhibited in the Admin Menu. (p. 39)

GPS KEY [GPS]



When a GPS receiver is connected through the optional AD-119 Junction Box or OPC-2205 Shielded control cable, and valid data is received, push to turn the GPS display ON or OFF. The GPS information that can be selected are Position, Direction and Elevation.

CLARIFIER KEY [CLAR]



Push to turn the Clarifier function ON or OFF.
// **NOTE:** This key cannot be used when the “Clarifier” item in the User Menu is set to “OFF.” (p. 36)

CLEAR TALK KEY [C TALK]



Push to turn the Clear Talk function ON or OFF.
• The “” icon appears when the function is ON.



TUNER KEY [TUNER]



Push to turn the Antenna tune mode to Auto, Manual or OFF. (p. 12)
• The “Auto Tune” or “Manual Tune” screen appears when the antenna tune mode is ON.
• The SWR meter appears when the antenna tune mode is ON.

MUTE KEY [MUTE]



Push to select the squelch type. Call squelch, S-meter squelch (level 1 to 50), Voice squelch or squelch OFF are selectable.
• The “” icon appears when the Call squelch function is ON.
• The “” icon appears when the S-meter squelch function is ON.
• The “” icon appears when the Voice squelch function is ON.

SCAN KEY [SCAN]



Push to start or stop a scan.

■ Rear panel

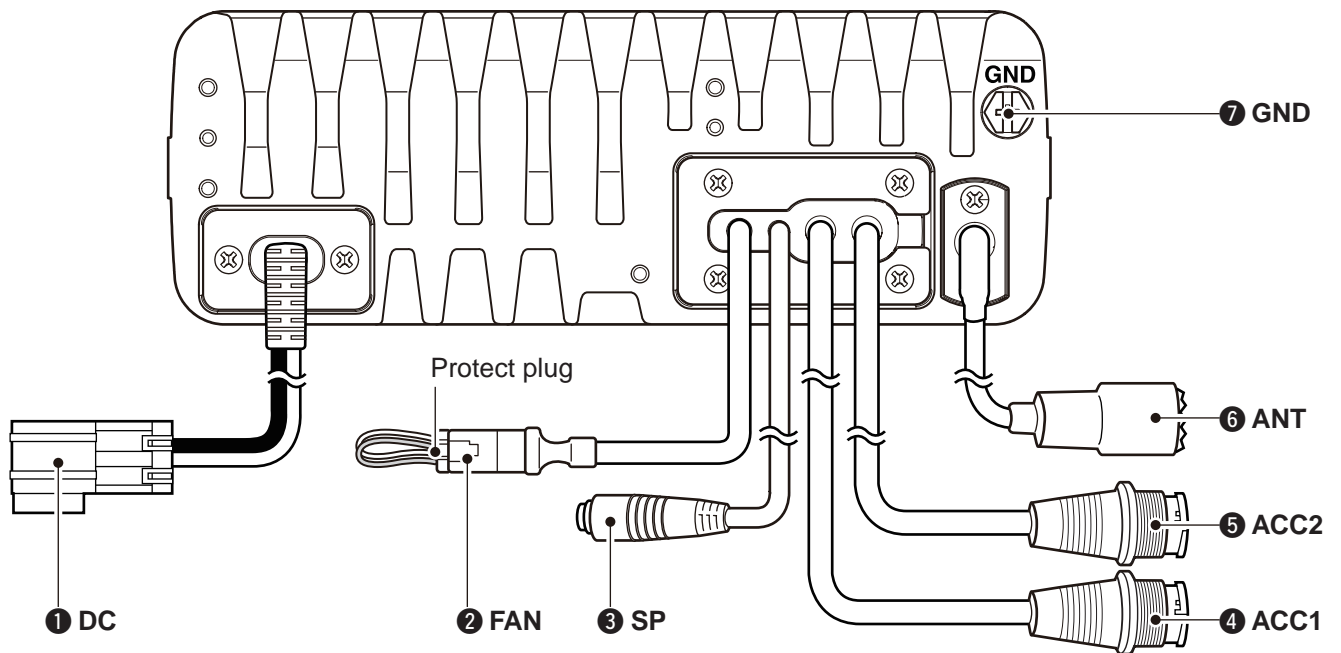

① DC POWER CONNECTOR [DC]

Accepts 13.8 V DC through a DC power cable.

② FAN CONNECTOR [FAN]

Connects to the optional CFU-F8100 Cooling Fan.

/// **NOTE:** Attach the protect plug when the optional Cooling Fan is not used.

③ SPEAKER JACK [SP]

Connects to an external speaker such as the supplied SP-25.

④ ACCESSORY CONNECTOR (10 PIN) [ACC1]

⑤ ACCESSORY CONNECTOR (12 PIN) [ACC2]

Connects to the optional AD-119 JUNCTION BOX or OPC-2205 SHIELDED CONTROL CABLE. Both connectors must be connected to use the AD-119 or OPC-2205.

/// **NOTE:** Attach the connector caps when the optional unit or cable is not used.

⑥ ANTENNA CONNECTOR

Connects to a 50 Ω HF band antenna.

⑦ GROUND TERMINAL

IMPORTANT! Connects to a solid ground point.

■ LCD screen

• Memory Channel Display

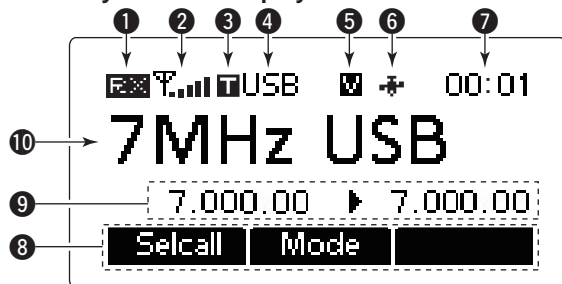

• Selcall Address Display



• ALE ID Display



1 RECEIVE/TRANSMIT ICON

- “RX” appears when signals are received or the squelch is open.
- “TX” appears during transmit.

2 S-METER/TX METERS

- Displays the receive signal strength.
 - Displays the transmit output power.
- Mic gain can also be displayed when the “METER TYPE” item in the Admin Menu is set to “MIC LEVEL.”

3 TUNE ICON

Appears after the automatic antenna tuner matches the transceiver and antenna.

4 OPERATING MODE INDICATOR

- Displays the selected operating mode.
- “LSB,” “USB,” “CW,” “AM,” “D1,”* “D2”* or “D3”* appears, depending on the operating mode.
- * When the “Modem” setting in the Admin Menu is set to “OFF,” “RTTY” appears instead. (p. 40)
- The D1, D2 or D3 mode can be set in the “Data mode 1,” “Data mode 2” or “Data mode 3” settings in the Admin Menu. (p. 40)

5 MUTE ICON

- “S” appears when the Call squelch function is selected.
- “L” appears when the S-meter squelch is selected.
- “V” appears when the Voice squelch is selected.

6 GPS ICON

Appears when valid position data is received from a GPS receiver that is connected to the AD-119 or OPC-2205.

7 TIME DISPLAY

Displays time data.

8 FUNCTION DISPLAY

Displays the function of the function keys ([▪], [▪▪] and [▪▪▪]).

9 SUB READOUTS

<Memory Channel display>

Shows the channel transmit and receive frequencies. The receive frequency is displayed on the right and the transmit frequency is displayed on the left.

▨ **NOTE:** The transmit frequency is not displayed when the selected channel is configured as “receive only.”

<Selcall Address display>

Shows the Selcall ID or phone number of the call.

<ALE ID display>

Displays the NET ID for ALE transmissions.

10 MAIN READOUTS

<Memory Channel display>

Displays the channel name.

<Selcall Address display>

Shows the Selcall Address of the call.

<ALE ID display>

Shows the ALE ID for ALE transmission.

• Memory Channel Display

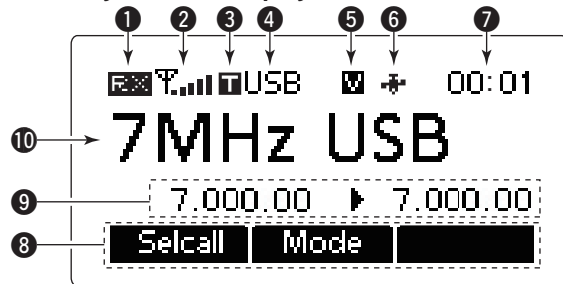

• Selcall Address Display



• ALE ID Display



11 CALL ICON

Displays the Call type icons for Selcall.

- The “” icon appears when Selective call is selected on the Selcall Address display.
- The “” icon appears when Phone call is selected on the Selcall Address display.
- The “” icon appears when Message call is selected on the Selcall Address display.
- The “” icon appears when GPS Send Position call is selected on the Selcall Address display.
- The “” icon appears when GPS Get Position call is selected on the Selcall Address display.
- The “” icon appears when Get Status call is selected on the Selcall Address display.
- The “” icon appears when RFDS Emergency call is selected on the Selcall Address display.
- The “” icon appears when Emergency call is selected on the Selcall Address display.
- The “” icon appears when Channel Test call is selected on the Selcall Address display.

■ AD-119 Optional Junction Box

◇ Front Panel

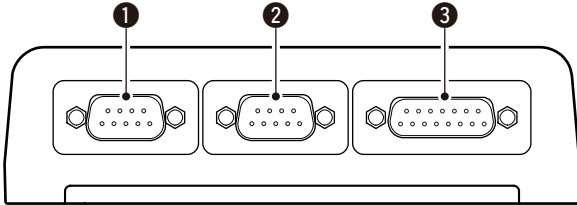

❶ DATA JACK [DATA]

Connects to a PC through an RS-232C cable (D-sub 9-pin) for remote control in the RS-232C format.

❷ GPS CONNECTOR [GPS]

Connects to a GPS receiver to automatically set your position and time data from data in NMEA0183 ver. 2.0 or 3.01 formats.

❸ GPIO CONNECTOR [GPIO]

Connects to the control cable of the optional AT-140 Antenna Tuner or AT230 Automatic Tuning Antenna.

◇ Rear Panel

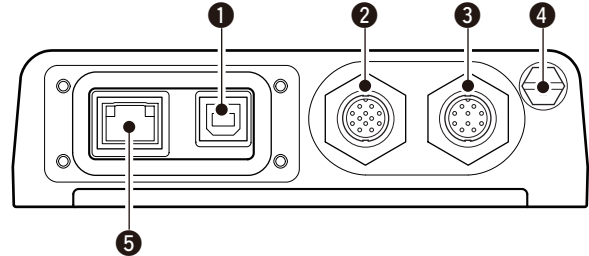

❶ USB CONNECTOR [USB]

Connects to a PC through an A-B type USB cable.

❷ ACCESSORY CONNECTOR 2 (12 PIN) [ACC2]

❸ ACCESSORY CONNECTOR 1 (10 PIN) [ACC1]

Connects to the IC-F8100's Accessory connectors. Both connectors must be connected to use this Junction Box.

❹ GROUND TERMINAL

IMPORTANT! Connects to a solid ground point.

❺ EXTERNAL MODEM CONNECTOR [EXT. MODEM]

Connects to an external unit such as an HF email modem or TNC (Terminal Node Controller).

NOTE: This connector may not be available, depending on the AD-119's version.

■ Power ON

- Push [⏻] to turn ON the Power.
 - Built-in Test is displayed.
The BIT display can be turned OFF in the Advance Menu.
 - Hold down [⏻] for 2 seconds to turn OFF the power.

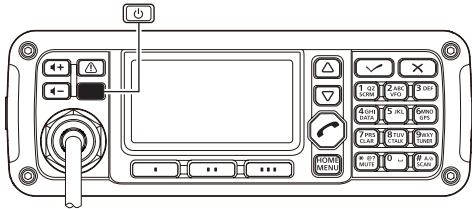

■ Selecting display mode

- Push [▪] one or more times to select a desired display mode.
 - The display sequentially selects “Channel” ⇄ “Selcall” ⇄ “ALE” ⇄ “Channel.”

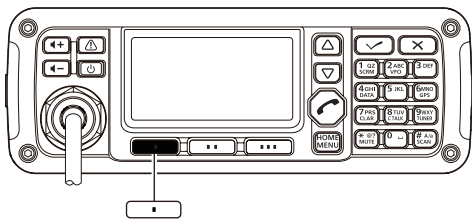

Memory channel display

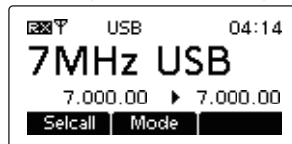

Selcall Address display ↓



ALE ID display ↓



■ Selecting a channel

- ① Push [▪] one or more times to select the Memory Channel display.
 - The display sequentially selects “Channel” ⇄ “Selcall” ⇄ “ALE” ⇄ “Channel.”
- ② Push [▲] or [▼] to select a desired memory channel.

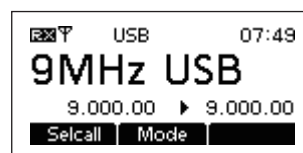
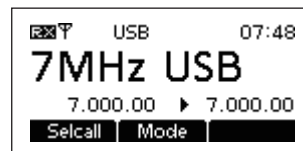
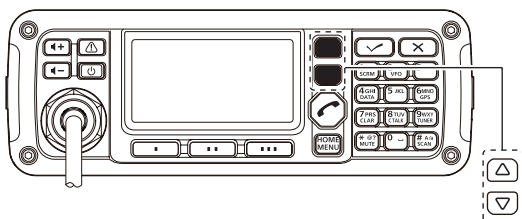

■ Setting audio volume

- ➔ Push [◀+] or [▶-] to adjust the audio level.
 - If the squelch is closed, push [MUTE](*) one or more times to open the squelch.
 - The display shows the volume level while adjusting.

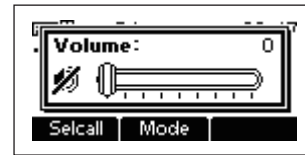
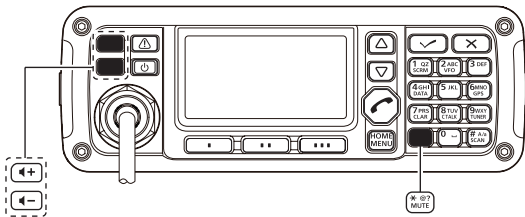

Minimum audio level

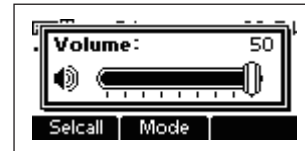

Maximum audio level

■ Squelch function

The squelch function detects signals with voice components and squelches (mutes) unwanted signals. This provides quiet stand-by.

When you need to receive weak signals, the squelch can be turned OFF.

- ➔ Push [MUTE](*) one or more times to select a squelch type. Selectable types are Call SQL, S-meter SQL (level 1 to 50), Voice SQL and OFF.
 - The S-meter squelch level can be adjusted in “Squelch Level” in the User Menu.

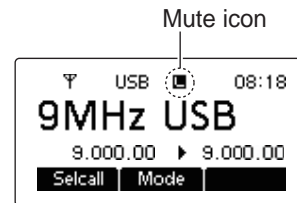
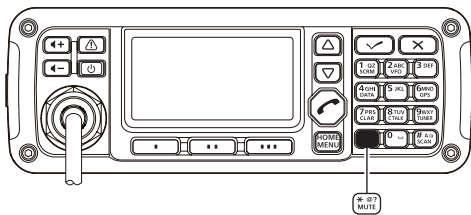

- The Mute icon, “S,” “L” or “V,” appears when the squelch function is turned ON.

■ Scan function

The scan function repeatedly scans programmed channels. This function is convenient to wait for calls on multiple channels.

- ➔ Push [SCAN](#) to start a scan.
 - “Scanning” and the Scan type are displayed.

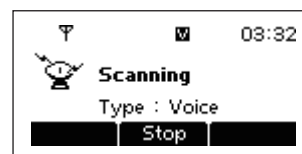

- ➔ When a signal is received, the scan pauses on that channel.
- ➔ Push [Stop](#) to cancel the scan.
 - Pushing [SCAN](#) also cancels the scan.

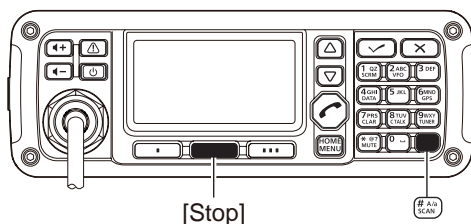

NOTE: The scan resume setting (the action after receiving a signal) can be changed in “Scan Resume” in the Admin Menu. (p. 41)

Mode selection

The following modes are selectable in the IC-F8100: LSB, USB, CW, AM, D1,* D2* and D3.*

* When the "Modem" setting in the Admin Menu is set to "OFF," "RTTY" can be selected instead. (p. 40)
The D1, D2 or D3 mode can be set in the "Data mode 1," "Data mode 2" or "Data mode 3" settings in the Admin Menu. (p. 40)

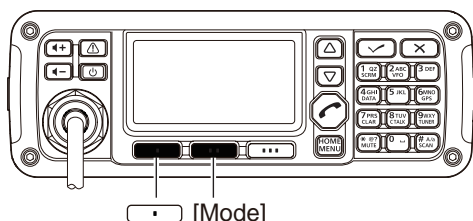

- Push [**■**] one or more times to select the Memory Channel display.
 - The display sequentially selects "Channel" ⇄ "Selcall" ⇄ "ALE" ⇄ "Channel."

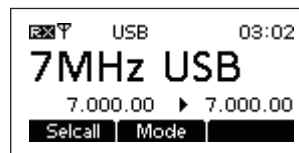

- Push [**Mode**](**■**) one or more times to select the desired mode.
 - The selected mode icon appears at the top of the display.

NOTE:

- The selected mode can be used only temporarily. When the channel is changed, it returns to the preprogrammed operating mode.
- Depending on the transceiver version or preprogramming, some operating modes may not be selectable or usable except receive.

2

Key Lock function

To prevent accidental channel changes, or unnecessary function access, use the Key Lock function. The transceiver has two types of Key Lock functions.

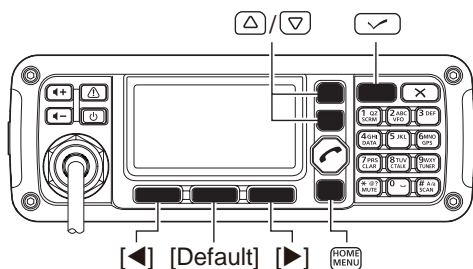

- Hold down [**MENU**](**HOME**) for 1 second to enter the Menu screen.
- Push [**△**] or [**▽**] to select the "User Menu," and then push [**✓**].
- Push [**△**] or [**▽**] to select "Key Lock."



- Push [**◀**](**■**) or [**▶**](**■**) to select the Key Lock function, "ALL" or "NUMERIC KEY"
 - Hold down [**Default**](**■**) for 1 second to return to the default setting.
- Push [**MENU**](**HOME**) twice to return to the normal operating screen.

• To turn OFF the function

When you push the locked key, "Numeric Key Locked" or "All Key Locked" appears, depending on the function. Then push [**Unlock**](**■**) to turn OFF the function.



■ VFO operation

In the VFO mode, you can set a desired operating frequency, operating mode or split frequency function.

NOTE:

- The VFO mode operation can be disabled in the Admin Menu.
- While in the VFO mode, the Selcall, ALE features or the Emergency key cannot be used.

• **Entering the VFO mode**

Push **[VFO]**(2) to turn the VFO mode ON or OFF.

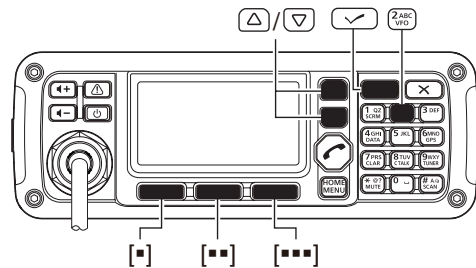
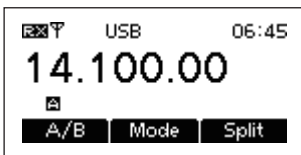

• **Frequency setting**

- ① Push **[A/B]**(■) to select VFO A or VFO B.
- ② Push **[✓]** to enter the frequency setting mode.



- ③ Push **[←]**(■) or **[→]**(■■■) to move the cursor to select the desired digit to change.
 - The cursor is displayed below the selected digit.
- ④ Push **[Δ]** or **[▽]** to change the frequency.
- ⑤ Push **[✓]** to exit the frequency setting mode.

• **Turning ON the split frequency function**

- ① Push **[A/B]**(■) to select VFO A or VFO B, and separately set the receive and transmit frequencies.
- ② Push **[Split]**(■■■) to turn the split frequency function ON.
 - The TX frequency appears below the RX frequency.
 - Pushing **[A/B]**(■) changes the VFOs between transmit and receive.

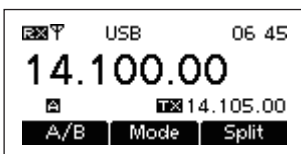

- ③ To turn OFF the split frequency function, push **[Split]**(■■■) again.

Basic voice transmit/receive

- ① First, check the following.
 - ➔ The microphone and external speaker are connected.
 - ➔ No “S,” “L” or “V” mute icon appears.
 - If “S,” “L” or “V” appears, push [MUTE](*) one or more times to turn OFF the mute.

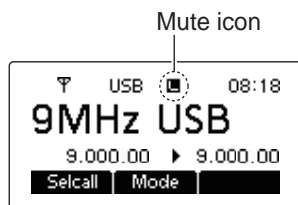

- ② Push [▲] or [▼] to select the desired receive channel.

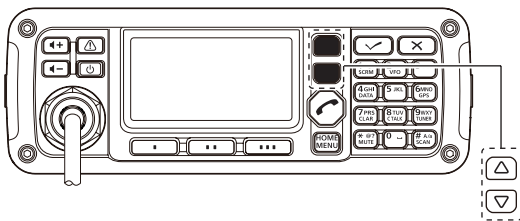

- The S-meter shows signal strength when signal is received.
- ③ Push [◀+] or [▶-] to adjust a desired audio level when receiving a signal.
 - If the bass or treble of the receive audio is too strong, set “Clarifier” to ON in the User Menu, and adjust to obtain clear audio. (See page 15 for the Clarifier function details.)
 - If the audio is distorted, select the suitable operating mode. (See page 10 for the Mode selection details.)

- ④ Push [TUNER](9) once or twice to enter the antenna tune mode.
 - The “Auto Tune” or “Manual Tune” screen sequentially appears.

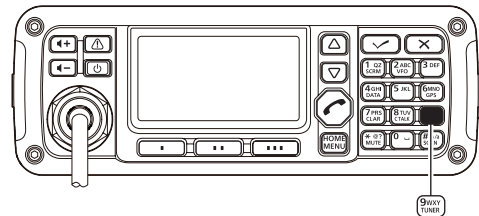

When the transceiver is connected to an optional antenna tuner and “Auto Tune” screen is selected, push [✓] to start auto tuning.

- The display shows the antenna SWR.
- If the antenna cannot be tuned after 20 seconds, the tuning circuit is automatically bypassed.
- After tuning is finished, the auto tune automatically stops transmitting.
- Push [✕] to manually stop transmitting, if necessary.
- Push [Through](***) to turn OFF the AT-140 (bypass).

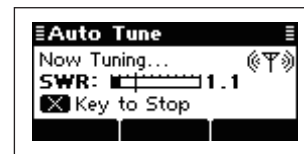

When the transceiver is connected to another antenna tuner, or directly connected to an antenna and the “Manual Tune” screen is selected, push [✓] to start transmitting and tune the antenna.

- The display shows the antenna SWR.
- Push [✕] to stop transmitting.

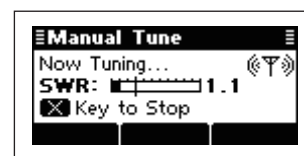

- ⑤ After tuning is finished, push [TUNER](9) once or twice to return to the normal operating screen.
- ⑥ To transmit on the channel, hold down [PTT] on the microphone, and speak at a normal voice level.
 - The RF meter shows the output power.
- ⑦ Release [PTT] to receive.

2
3

■ Functions for transmit

◇ Transmit power selection

The transceiver has three output power levels, HIGH, MID and LOW. High power provides longer distance communications and low power reduces power consumption.

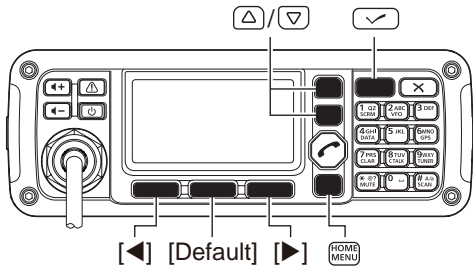

- ① Hold down **[MENU]**(HOME) for 1 second to enter the Menu screen.
- ② Push **[Δ]** or **[▽]** to select the “User Menu,” and then push **[✓]**.
- ③ Push **[Δ]** or **[▽]** to select “RF Power.”

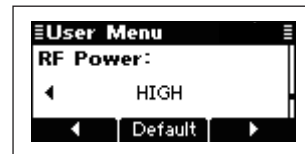

- ④ Push **[◀]**(■) or **[▶]**(■■■) to select the desired output power.
 - Hold down **[Default]**(■■) for 1 second to return to the default setting.
- ⑤ Push **[MENU]**(HOME) twice to return to the normal operating screen.

◇ Setting Microphone gain

The microphone gain must be properly adjusted so that your signal is not distorted when transmitted.

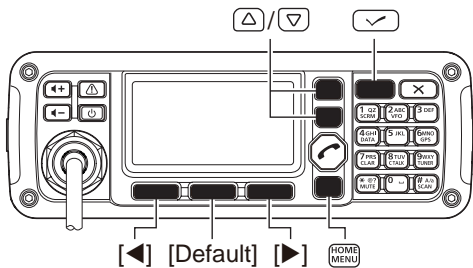

- ① Hold down **[MENU]**(HOME) for 1 second to enter the Menu screen.
- ② Push **[Δ]** or **[▽]** to select the “User Menu,” and then push **[✓]**.
- ③ Push **[Δ]** or **[▽]** to select “Mic Gain.”

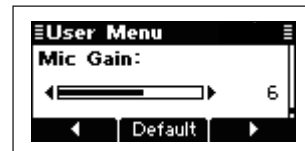

- ④ Push **[◀]**(■) or **[▶]**(■■■) to select the desired Mic gain.
 - Hold down **[Default]**(■■) for 1 second to return to the default setting.
- ⑤ Push **[MENU]**(HOME) twice to return to the normal operating screen.

◇ Checking the MIC level

The transceiver has a MIC level meter. You can check the MIC level before or after adjusting the Microphone gain.

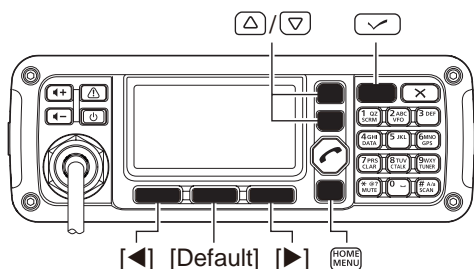

- ① Hold down **[MENU]**(HOME) for 1 second to enter the Menu screen.
- ② Push **[Δ]** or **[▽]** to select the “Admin Menu,” and then push **[✓]**.
- ③ Push **[Δ]** or **[▽]** to select “Meter Type.”

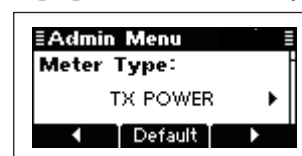

- ④ Push **[▶]**(*******) to select “MIC LEVEL.”
- ⑤ Push **[MENU]**(HOME) twice to return to the normal operating screen.
- ⑥ Hold down **[PTT]** on the microphone, and speak at a normal voice level.
- ⑦ While speaking into the microphone, check the TX meter reading.

◇ Speech Processor

The IC-F8100 has a built-in, low distortion Speech Processor circuit. This circuit increases your average talk power in the SSB mode and is especially useful when the receiving station is having difficulty hearing your audio.

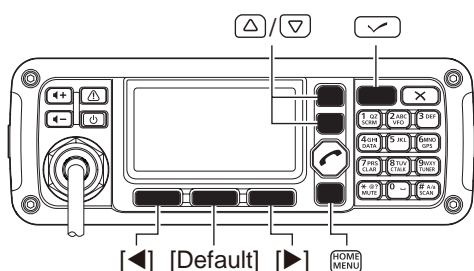

- ① Hold down **[MENU]**(HOME) for 1 second to enter the Menu screen.
- ② Push **[Δ]** or **[▽]** to select the “User Menu,” and then push **[✓]**.
- ③ Push **[Δ]** or **[▽]** to select “Speech Processor.”



- ④ Push **[◀]**(*****) or **[▶]**(*******) to turn the Speech processor function ON or OFF.
 - Hold down **[Default]**(******) for 1 second to return to the default setting.
- ⑤ Push **[MENU]**(HOME) twice to return to the normal operating screen.
- ⑥ Push **[Mode]**(******) one or more times to select the USB or LSB mode.
- ⑦ Hold down **[PTT]** on the microphone, and speak at a normal voice level.

■ Functions for receive

◇ Clarifier function

The Clarifier function compensates for off-frequency stations. The function shifts the receive frequency up to ± 200 Hz, without moving the transmit frequency.

• Setting

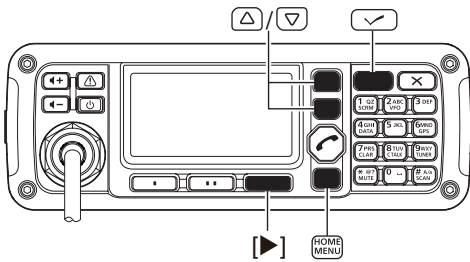

- ① Hold down **[MENU]**(HOME) for 1 second to enter the Menu screen.
- ② Push **[▲]** or **[▼]** to select the “User Menu,” and then push **[✓]**.
- ③ Push **[▲]** or **[▼]** to select “Clarifier.”



- ④ Push **[▶]**(*******) to turn ON the Clarifier function.
- ⑤ Push **[MENU]**(HOME) twice to return to the normal operating screen.

• Operation

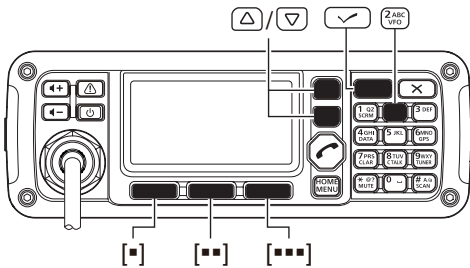

- ① Push **[CLAR]**(7) to turn ON the Clarifier function.

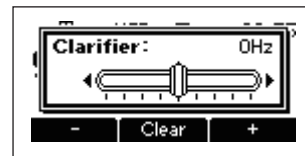

- ② Push **[−]**(**▣**) or **[+]**(**▣▣▣**) to tune the frequency shift.
 - The transmit frequency is not shifted.
 - Hold down **[Clear]**(**▣▣**) for 1 second to return to the center position, if desired.

▨ When cancelling the Clarifier function, push **[CLAR]**(7) again.

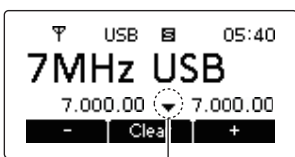

Lower shift

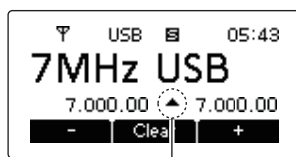

Upper shift

◇ Preamp and Attenuator

The preamp amplifies received signals in the front end circuit to improve the S/N ratio and sensitivity. Turn ON this function to better receive weak signals.

The attenuator prevents strong undesired signals near the desired frequency or near your location, such as from a broadcast station, from causing distortion or spurious signals.

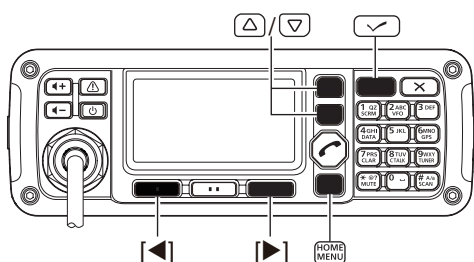

- ① Hold down **[MENU]**(HOME) for 1 second to enter the Menu screen.
- ② Push **[△]** or **[▽]** to select the “User Menu,” and then push **[✓]**.
- ③ Push **[△]** or **[▽]** to select “Pre Amp.”

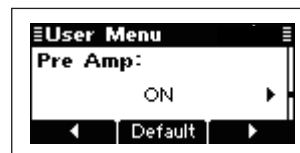

- ④ Push **[◀]**(■) or **[▶]**(■) to turn ON the Preamp or Attenuator function.
- ⑤ Push **[MENU]**(HOME) twice to return to the normal operating screen.

3

◇ Noise Blanker

The noise blanker reduces pulse-type noise such as that generated by automobile ignition systems.

The noise blanker may distort reception of strong signals. In such cases, the noise blanker should be turned OFF.

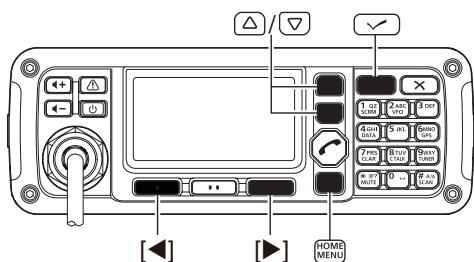

- ① Hold down **[MENU]**(HOME) for 1 second to enter the Menu screen.
- ② Push **[△]** or **[▽]** to select the “User Menu,” and then push **[✓]**.
- ③ Push **[△]** or **[▽]** to select “Noise Blanker.”



- ④ Push **[▶]**(■) to turn ON the Noise Blanker function.
- ⑤ Push **[▽]** to select “Blanker Level.”

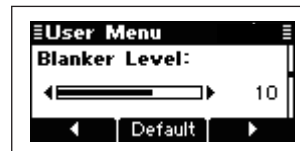

- ⑥ Push **[◀]**(■) or **[▶]**(■) to adjust the noise blanker level.
- ⑦ Push **[MENU]**(HOME) twice to return to the normal operating screen.

⚡ When using the noise blanker, received signals may be distorted if they are excessively strong.

■ Functions for receive (Continued)

◇ AGC function

The AGC (automatic gain control) controls receiver gain to produce a constant audio output level, even when the received signal strength varies by fading, and so on.

The transceiver has two AGC characteristics; AUTO and time constants FAST and SLOW.

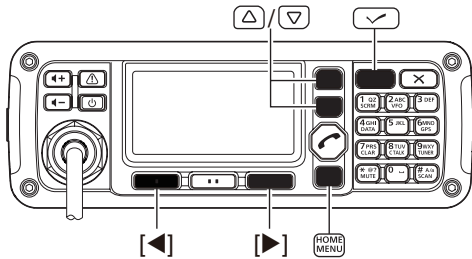

- ① Hold down **[MENU]**(HOME) for 1 second to enter the Menu screen.
- ② Push **[▲]** or **[▼]** to select the “User Menu,” and then push **[✓]**.
- ③ Push **[▲]** or **[▼]** to select “AGC.”



- ④ Push **[◀]**(■) or **[▶]**(■) to select the desired AGC time constant, FAST, SLOW or AUTO.
 ▨ When AUTO is selected, the AGC time constant varies, depending on the operating mode.
- ⑤ Push **[MENU]**(HOME) twice to return to the normal operating screen.

◇ AGC OFF function

When receiving weak signals with adjacent strong signals or noise, the AGC function may reduce the sensitivity. In this situation, the AGC function should be turned OFF.

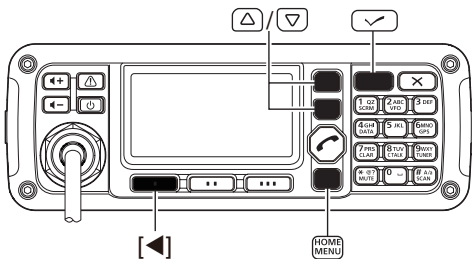

- ① Hold down **[MENU]**(HOME) for 1 second to enter the Menu screen.
- ② Push **[▲]** or **[▼]** to select the “Admin Menu,” and then push **[✓]**.
- ③ Push **[▲]** or **[▼]** to select “AGC.”

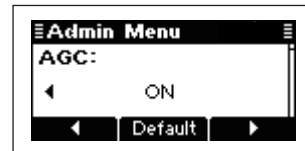

- ④ Push **[◀]**(■) to turn OFF the AGC function.
- ⑤ Push **[MENU]**(HOME) twice to return to the normal operating screen.

◇ Clear Talk function

The Clear Talk function enhances desired signals in the presence of noise by using the DSP circuit.

➔ Push **[C TALK]**(8) to turn the Clear Talk function ON or OFF.

- “**C**” appears when the Clear Talk function is ON.

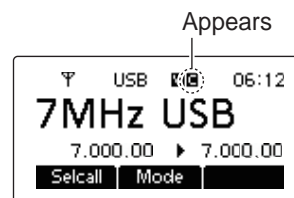
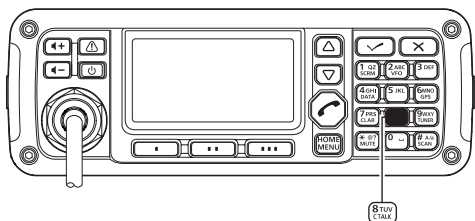

Clear Talk function OFF

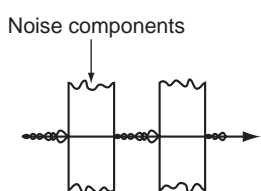

Clear Talk function ON

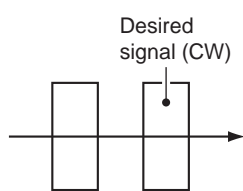

◇ IF Filter selection

The transceiver has three passband IF filter widths for each mode.

- ① Hold down **[MENU]**(HOME) for 1 second to enter the Menu screen.
- ② Push **[△]** or **[▽]** to select the “User Menu,” and then push **[✓]**.
- ③ Push **[△]** or **[▽]** to select “Bandwidth”

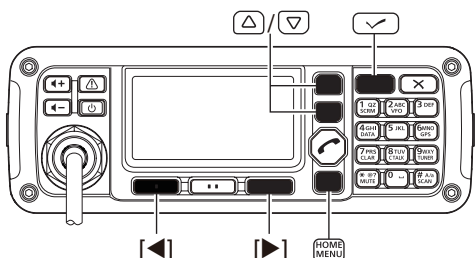

- ⑥ Push **[◀]**(■) or **[▶]**(■) to select the IF filter width, NARROW, MID or WIDE.
- ⑦ Push **[MENU]**(HOME) twice to return to the normal operating screen.

■ Selcall or ALE

Selcall uses a 4 or 6-digit ID address and allows you to make an individual or group call. The ALE (automatic link establishment) is a system which automatically selects an available frequency and establishes a communication link. The IC-F8100 ALE system complies with basic requirements of FED-STD-1045A.

▨ The Selcall or ALE features may not be available, depending on the preprogramming. Check the Selcall or ALE capabilities in the Admin Menu, and then set the settings to the “RX&TX” option.

◇ Available calls

• Selective call

Selective call allows you to make an individual or group call using an individual ID (identification) assigned to each transceiver.

• Phone call

Allows you to make a Phone call through a telephone interconnect service provider.

• Message call

Allows you to exchange text messages of up to 64 characters* with the intended ID station.

* 64 characters for ICOM Selcall system; 32 characters for Open Selcall system.

• Send Position call

Allows you to send your own position information to the intended ID station.

• Get Position call

The Get Position call allows you to request the intended ID station to send its position information.

• Get Status call

Requests to send radio status information including power supply voltage, signal strength, output power, VSWR, and so on.

• RFDS emergency call

The RFDS (Royal Flying Doctor Service) emergency call uses a 2-Tone signal for an emergency call.

• Emergency call

Allows you to broadcast an emergency signal with own position information.

▨ • The Phone call, Message call, Send Position call, Get Position call, Get Status call and Emergency call use Icom original commands. These calls may not be compatible with other brands. (Icom Selcall system)

▨ • Depending on the preprogramming, you can select the Open Selcall system* for these call, except the Get Status call.

▨ * Open Selcall system is compatible with other transceiver brands. Ask your dealer for details.

• Channel Test call

The Channel Test call allows the user to determine the signal quality between your transceiver and a specific transceiver, before an individual or group call.

• ALE individual or net call

Automatically establishes a communication link by using the ALE table.

• ALE sounding

Automatically sends a sounding signal at a set interval (0.5–16 hours) to check the propagation, and stores the data in a table. Manual soundings can also be sent.

• ALE AMD (Automatic Message Display)

Automatically sends and receives text messages of up to 90 characters.

◆ Selective call

The Selcall function allows you to make individual or group calls. Each transceiver is assigned an individual ID (identification) and can be called using this ID.

• Preparation for Selective call

Send a Channel Test call on several Selcall channels, and check the propagation on each one to select the channel with the best signal quality. (p. 30)

• Sending Selective call

- ① With the Memory Channel displayed, push [**SEL**] to enter the Call select menu.
- ② Push [**SEL**](*) or [**SEL**](***), then push [**SEL**] to enter the Selcall menu.

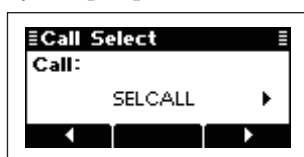

- ③ Push [**SEL**](*) or [**SEL**](***), then push [**SEL**] to set the Call type to "SELECTIVE."
 - "SELECTIVE," "PHONE," "MESSAGE," "SEND POSITION," "GET POSITION," "GET STATUS," "EMERGENCY" and "CHANNEL TEST" are selectable.

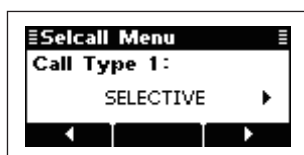

- ④ Push [**SEL**] to go to the next screen.
 - Push [**HOME**] to return to the previous screen.
 - **Call ID input**
 - Push the numeric keys to enter the Call ID.
 - Push [**X**] to delete the number.
 - This Call ID is not stored in the Call ID list.

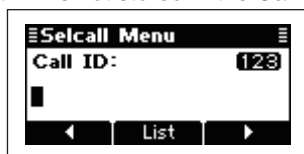

- **Call ID selection**
 - ➔ Push [**List**](**) to enter the list selection mode.
 - ➔ Push [**SEL**](*) or [**SEL**](***), then push [**SEL**] to select the Call ID.
 - Push [**Edit**](**) to return to the direct input mode.
- ⑤ Push [**SEL**] to go to the next screen.
 - Push [**HOME**] to return to the previous screen.
 - **Network selection**
 - Push [**SEL**](*) or [**SEL**](***), then push [**SEL**] to select the Network.

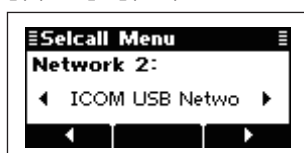

- ⑥ Push [**SEL**] to go to the next screen.
 - Push [**HOME**] to return to the previous screen.
 - **Self ID selection**
 - Push [**SEL**](*) or [**SEL**](***), then push [**SEL**] to select the Self ID.

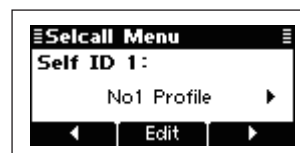

○ Self ID input

- ➔ Push [**Edit**](**) to enter the direct input mode.
- ➔ Push the numeric keys to enter the Self ID.
 - Push [**X**] to delete the number.
 - This Self ID is overwritten or stored in the Self ID list.
 - Push [**List**](**) to return to the list selection mode.
- ⑦ Push [**SEL**] to enter the Channel Menu, and then push [**SEL**](*) or [**SEL**](***), then push [**SEL**] to select the desired operating channel.
 - Push [**HOME**] to return to the Selcall menu.

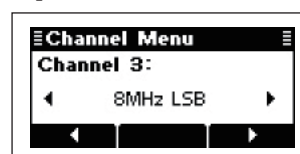

- ⑧ Push [**SEL**] to transmit the Selective call. The call is stored in the Call Out memory.
 - While calling, push [**PTT**] to cancel the call.

▨ You can also transmit a Selective call when the Selcall Address is displayed. In this case, you can skip steps ① to ⑤ above, after selecting the Selective call address.

• Receiving Selective calls

When a transceiver receives a Selective call with your individual ID, it automatically responds by transmitting. The received Selcall is stored in the Call In memory.

- ① After receiving a Selective call, and push any key to enter the Call In memory screen.

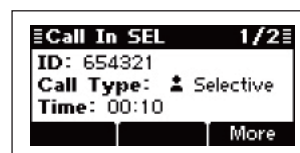

- ② Push [**More**](***) or [**Prev**](*) to select the information.

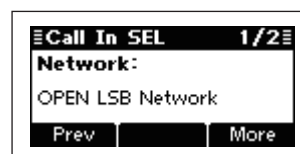

- ③ Push [**Home**] to return to the normal operating screen.

◇ Phone call

Allows you to make Phone calls through a telephone interconnect service provider.

• Preparation for Phone call

Send a Channel Test call on several Phone call channels, and check the propagation on each one to select the channel with the best signal quality. (p. 30)

• Sending Phone call

- ① With the Memory Channel displayed, push [↵] to enter the Call select menu.
- ② Push [◀](▪) or [▶](▪▪▪) to set the Call to "SELCALL," then push [↵] to enter the Selcall menu.

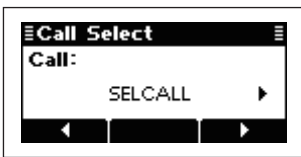

- ③ Push [◀](▪) or [▶](▪▪▪) to set the Call type to "PHONE."
- "SELECTIVE," "PHONE," "MESSAGE," "SEND POSITION," "GET POSITION," "GET STATUS," "EMERGENCY" and "CHANNEL TEST" are selectable.

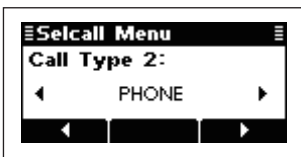

- ④ Push [↵] to go to the next screen.
- Push [HOME] to return to the previous screen.
- Phone number input
- ➔ Push the numeric keys to enter the Phone number.
- Push [X] to delete the number.
- This Number is not stored in the Phone address list.



- Phone address selection
- ➔ Push [List](▪▪) to enter the list selection mode.
- ➔ Push [◀](▪) or [▶](▪▪▪) to select the Phone address.
- Push [Edit](▪▪) to return to the direct input mode.

- ⑤ Push [↵] to go to the next screen.
- Push [HOME] to return to the previous screen.
- Phone Link selection
- ➔ Push [◀](▪) or [▶](▪▪▪) to select the Network.

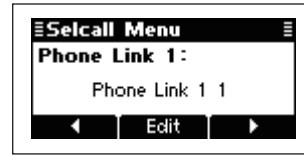

- Phone Link input
- ➔ Push [Edit](▪▪) to enter the direct input mode.
- ➔ Push the numeric keys to enter the Phone Link.
- Push [X] to delete the number.
- This Phone Link is not stored in the Phone Link list.
- Push [List](▪▪) to return to the list selection mode.

- ⑥ Push [↵] to go to the next screen.
- Push [HOME] to return to the previous screen.
- Network selection
- ➔ Push [◀](▪) or [▶](▪▪▪) to select the Network.

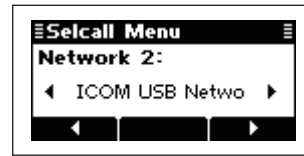

- ⑦ Push [↵] to go to the next screen.
- Push [HOME] to return to the previous screen.
- Self ID selection
- ➔ Push [◀](▪) or [▶](▪▪▪) to select the Self ID.

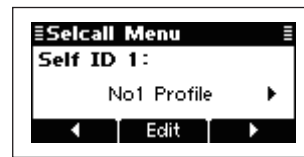

- Self ID input
- ➔ Push [Edit](▪▪) to enter the direct input mode.
- ➔ Push the numeric keys to enter the Self ID.
- Push [X] to delete the number.
- This Self ID is overwritten or stored in the Self ID list.
- Push [List](▪▪) to return to the list selection mode.

- ⑧ Push [] to enter the Channel Menu, and then push [] or [] to select the desired operating channel.

- Push [**HOME**] to return to Selcall menu.

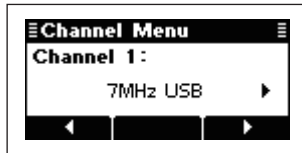

- ⑨ Push [] to transmit the Phone call. The call is stored in the Call Out memory.

- While calling, push [**PTT**] to cancel the call.

/// You can also transmit a Phone call when the Selcall Address is displayed. In this case, you can skip steps ① to ④ above, after selecting the Phone call address.

• After a Phone call

- ① When a Phone call is finished, push [] to enter the Selcall menu.

- “TEL DISCONNECT” appears.
- If desired, push [**HOME**] to return to the previous screen.

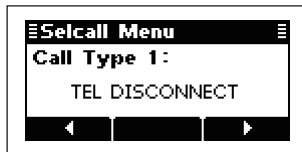

- ② Then, push [] to transmit the disconnect call.

- Until ‘TEL DISCONNECT’ is transmitted, the telephone interconnect service provider continues counting the time for toll charging.

◇ Message call

The Message call allows you to exchange text messages of up to 64 characters,* with the intended ID station, and also leave a message at the station.

* 64 characters for ICOM Selcall system; 32 characters for Open Selcall system.

• Preparation for Message call

Send a Channel Test call on several Phone call channels, and check the propagation on each one to select the channel with the best signal quality. (p. 30)

• Sending Message call

- ① With the Memory Channel displayed, push [**↶**] to enter the Call select menu.
- ② Push [**◀**](▪) or [**▶**](▪▪▪) to set the Call to “SEL-CALL,” then push [**↶**] to enter the Selcall menu.
- ③ Push [**◀**](▪) or [**▶**](▪▪▪) to set the Call type to “MESSAGE.”
 - “SELECTIVE,” “PHONE,” “MESSAGE,” “SEND POSITION,” “GET POSITION,” “GET STATUS,” “EMERGENCY” and “CHANNEL TEST” are selectable.

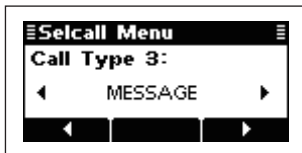

- ④ Push [**↶**] to go to the next screen.
 - Push [**HOME**] to return to the previous screen.
 - Call ID input
 - Push the numeric keys to enter the Call ID.
 - Push [**X**] to delete the number.
 - This Call ID is not stored in the Call ID list.
 - Call ID selection
 - ➔ Push [**List**](▪▪) to enter the list selection mode.
 - ➔ Push [**◀**](▪) or [**▶**](▪▪▪) to select the Call ID.
 - Push [**Edit**](▪▪) to return to the direct input mode.
- ⑤ Push [**↶**] to go to the next screen.
 - Push [**HOME**] to return to the previous screen.
 - Message selection
 - Push [**◀**](▪) or [**▶**](▪▪▪) to select the Message.



○ Message input

- ➔ Push [**Edit**](▪▪) to enter the direct input mode.
- ➔ Push the numeric keys to enter the Message.
 - Push [**A/a**](#) to select the character group, ABC (Upper case letters), abc (lower case letters) or 123 (numbers).
 - Push [**X**] to delete the character.
 - This Message is overwritten or stored in the Message list.
 - Push [**List**](▪▪) to return to the list selection mode.

- ⑥ Push [**↶**] to go to the next screen.
 - Push [**HOME**] to return to the previous screen.

○ Network selection

- Push [**◀**](▪) or [**▶**](▪▪▪) to select the Network.

- ⑦ Push [**↶**] to go to the next screen.

- Push [**HOME**] to return to the previous screen.
- Self ID selection

- Push [**◀**](▪) or [**▶**](▪▪▪) to select the Self ID.

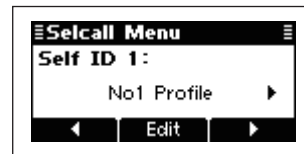

○ Self ID input

- ➔ Push [**Edit**](▪▪) to enter the direct input mode.
- ➔ Push the numeric keys to enter the Self ID.
 - Push [**X**] to delete the number.
 - This Self ID is overwritten or stored in the Self ID list.
 - Push [**List**](▪▪) to return to the list selection mode.

- ⑧ Push [**↶**] to enter the Channel Menu, and then push [**◀**](▪) or [**▶**](▪▪▪) to select the desired operating channel.
 - Push [**HOME**] to return to the Selcall menu.

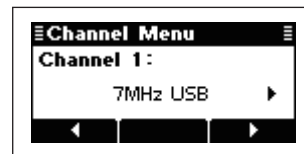

- ⑨ Push [**↶**] to transmit the Message call. The call is stored in the Call Out memory.
 - While calling, push [**PTT**] to cancel the call.

▨ You can also transmit a Selective call when the Selcall Address is displayed. In this case, you can skip steps ① to ⑥ above, after selecting the Message call address.

• Receiving Message call

When your transceiver receives a Message call with your individual ID, it automatically responds by transmitting. The received Message is stored in the Call In memory.

- ① After receiving a Message call, and push any key to enter the Call In memory.

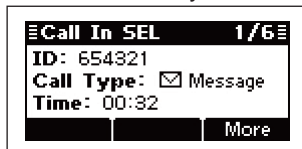

- ② Push **[More](***)** or **[Prev](▢)** to select the information.



- ③ Push **[HOME]** to return to the normal operating screen.

◆ Send Position call

The Send Position call allows you to send your own position/time information to the intended ID station.

• Preparation for Send Position call

Send a Channel Test call on several Phone call channels, and check the propagation on each one to select the channel with the best signal quality. (p. 30)

• Sending Send Position call

- ① With the Memory Channel displayed, push [↵] to enter the Call select menu.
- ② Push [←](*) or [→](***), to set the Call to "SELCALL," then push [↵] to enter the Selcall menu.

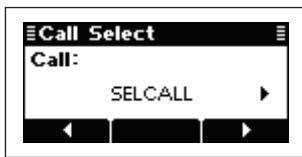

- ③ Push [←](*) or [→](***), to set the Call type to "SEND POSITION."
 - "SELECTIVE," "PHONE," "MESSAGE," "SEND POSITION," "GET POSITION," "GET STATUS," "EMERGENCY" and "CHANNEL TEST" are selectable.

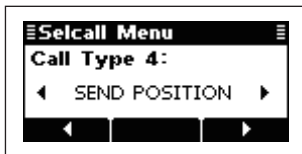

- ④ Push [↵] to go to the next screen.
 - Push [HOME] to return to the previous screen.
- Call ID input
- Push the numeric keys to enter the Call ID.
- Push [X] to delete the number.
 - This Call ID is not stored in the Call ID list.



- Call ID selection
- ➔ Push [List](**) to enter the list selection mode.
 - ➔ Push [←](*) or [→](***), to select the Call ID.
 - Push [Edit](**) to return to the direct input mode.
- ⑤ Push [↵] to go to the next screen.
 - Push [HOME] to return to the previous screen.
- Network selection
- Push [←](*) or [→](***), to select the Network.
- ⑥ Push [↵] to go to the next screen.
 - Push [HOME] to return to the previous screen.
- Self ID selection
- Push [←](*) or [→](***), to select the Self ID.

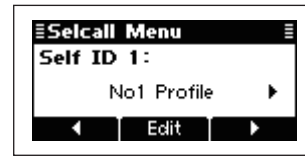

- Self ID input
- ➔ Push [Edit](**) to enter the direct input mode.
 - ➔ Push the numeric keys to enter the Self ID.
 - Push [X] to delete the number.
 - This Self ID is overwritten or stored in the Self ID list.
 - Push [List](**) to return to the list selection mode.

- ⑦ Push [↵] to enter the Channel Menu, and then push [←](*) or [→](***), to select the desired operating channel.
 - Push [HOME] to return to the Selcall menu.

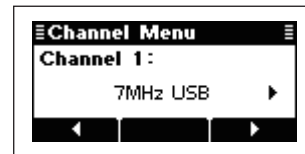

- ⑧ Push [↵] to transmit the Send Position call. The call is stored in the Call Out memory.
 - While calling, push [PTT] to cancel the call.

▨ You can also transmit a Send Position call when the Selcall Address is displayed. In this case, you can skip steps ① to ⑤ above, after selecting the Send Position call address.

• Receiving a Send Position call

When a transceiver receives a Send Position call with your individual ID, it automatically responds by transmitting. The received Send Position call is stored in the Call In memory.

- ① After receiving a Send Position call, and push any key to enter the Call In memory.

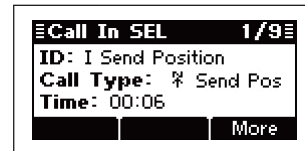

- ② Push [More](***) or [Prev](*) to select the information.

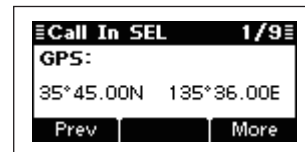

- ③ Push [HOME] to return to normal operating screen.

◇ Get Position call

The Get Position call allows you to request an intended ID station to send its position information.

• Preparation for Get Position call

Send a Channel Test call on several Phone call channels, and check the propagation on each one to select the channel with the best signal quality. (p. 30)

• Sending Get Position call

- ① With the Memory Channel displayed, push [**↶**] to enter the Call select menu.
- ② Push [**◀**](**▪**) or [**▶**](**▪▪▪**) to set the Call to “SEL-CALL,” then push [**↶**] to enter the Selcall menu.
- ③ Push [**◀**](**▪**) or [**▶**](**▪▪▪**) to set the Call type to “GET POSITION.”
 - “SELECTIVE,” “PHONE,” “MESSAGE,” “SEND POSITION,” “GET POSITION,” “GET STATUS,” “EMERGENCY” and “CHANNEL TEST” are selectable.

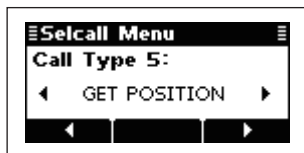

- ④ Push [**↶**] to go to the next screen.
 - Push [**HOME**] to return to the previous screen.

○ Call ID input

- Push the numeric keys to enter the Call ID.
 - Push [**X**] to delete the number.
 - This Call ID is not stored in the Call ID list.

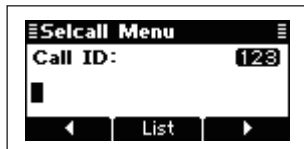

○ Call ID selection

- Push [**List**](**▪▪**) to enter the list selection mode.
- Push [**◀**](**▪**) or [**▶**](**▪▪▪**) to select the Call ID.
 - Push [**Edit**](**▪▪**) to return to the direct input mode.

- ⑤ Push [**↶**] to go to the next screen.
 - Push [**HOME**] to return to the previous screen.

○ Network selection

- Push [**◀**](**▪**) or [**▶**](**▪▪▪**) to select the Network.

- ⑥ Push [**↶**] to go to the next screen.
 - Push [**HOME**] to return to the previous screen.

○ Self ID selection

- Push [**◀**](**▪**) or [**▶**](**▪▪▪**) to select the Self ID.

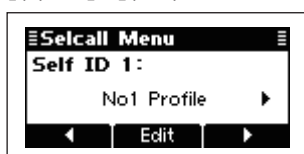

○ Self ID input

- Push [**Edit**](**▪▪**) to enter the direct input mode.
- Push the numeric keys to enter the Self ID.
 - Push [**X**] to delete the number.
 - This Self ID is overwritten or stored in the Self ID list.
 - Push [**List**](**▪▪**) to return to the list selection mode.

- ⑦ Push [**↶**] to enter the Channel Menu, and then push [**◀**](**▪**) or [**▶**](**▪▪▪**) to select the desired operating channel.
 - Push [**HOME**] to return to the Selcall menu.

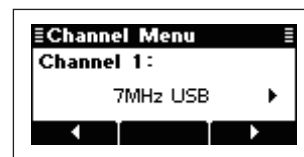

- ⑧ Push [**↶**] to transmit the Get Position call. The call is stored in the Call Out memory.
 - While calling, push [**PTT**] to cancel the call.

▨ You can also transmit a Get Position call when the Selcall Address is displayed. In this case, you can skip steps ① to ⑤ above, after selecting the Get Position call address.

• Receiving a Get Position call acknowledgement

- ① After the call is transmitted, your called station sends position/time information as an acknowledgement. Push [**↶**] to enter the Call In memory.

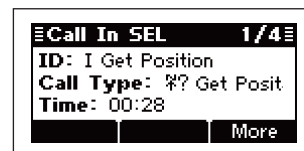

- ② Push [**More**](**▪▪▪**) or [**Prev**](**▪**) to select the information.

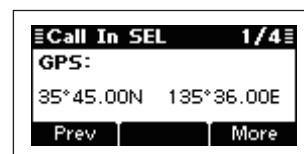

- ③ Push [**HOME**] to return to the normal operating screen.

• Receiving a Get Position call

When your transceiver receives a Get Position call that includes your individual ID, it automatically responds by transmitting.

◆ Get Status call

The Get Status call requests sending radio status information including power supply voltage, signal strength, output power, VSWR, and so on.

• Preparation for Get Status call

Send a Channel Test call on several Phone call channels, and check the propagation on each one to select the channel with the best signal quality. (p. 30)

• Sending Get Status call

- ① With the Memory Channel displayed, push [↵] to enter the Call select menu.
- ② Push [◀](*) or [▶](***), to set the Call to “SEL-CALL,” then push [↵] to enter the Selcall menu.
- ③ Push [◀](*) or [▶](***), to set the Call type to “GET STATUS.”
 - “SELECTIVE,” “PHONE,” “MESSAGE,” “SEND POSITION,” “GET POSITION,” “GET STATUS,” “EMERGENCY” and “CHANNEL TEST” are selectable.

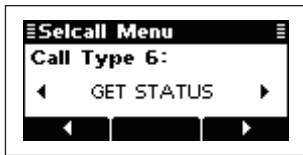

- ④ Push [↵] to go to the next screen.
 - Push [HOME] to return to the previous screen.

○ Call ID input

- ➔ Push the numeric keys to enter the Call ID.
- Push [X] to delete the number.
- This Call ID is not stored in the Call ID list.



○ Call ID selection

- ➔ Push [List](**) to enter the list selection mode.
- ➔ Push [◀](*) or [▶](***), to select the Call ID.
 - Push [Edit](**) to return to the direct input mode.

- ⑤ Push [↵] to go to the next screen.
 - Push [HOME] to return to the previous screen.

○ Network selection

Push [◀](*) or [▶](***), to select the Network.

- ⑥ Push [↵] to go to the next screen.
 - Push [HOME] to return to the previous screen.

○ Self ID selection

Push [◀](*) or [▶](***), to select the Self ID.

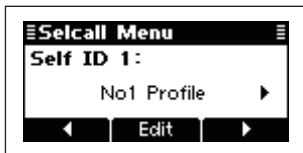

○ Self ID input

- ➔ Push [Edit](**) to enter the direct input mode.
- ➔ Push the numeric keys to enter the Self ID.
 - Push [X] to delete the number.
 - This Self ID is overwritten or stored in the Self ID list.
 - Push [List](**) to return to the list selection mode.

- ⑦ Push [↵] to enter the Channel Menu, and then push [◀](*) or [▶](***), to select the desired operating channel.
 - Push [HOME] to return to the Selcall menu.



- ⑧ Push [↵] to transmit the Get Status call. The call is stored in the Call Out memory.
 - While calling, push [PTT] to cancel the call.

▨ You can also transmit a Get Status call when the Selcall Address is displayed. In this case, you can skip steps ① to ⑤ above, after selecting the Get Status call address.

• Receiving a Get Status call acknowledgement

- ① After the call is transmitted, your called station sends status information as an acknowledgement. Push any key to enter the Call In memory.

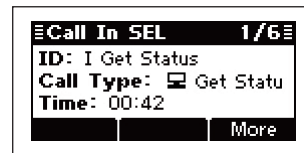

- ② Push [More](***) or [Prev](*) to select the information.

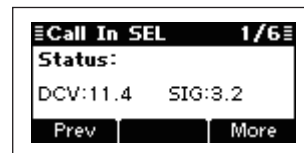

- Status information includes power supply voltage and signal strength.

- ③ Push [HOME] to return to the normal operating screen.

• Receiving a Get Status call

When a transceiver receives a Get Status call that includes your individual ID, it automatically responds by transmitting.

◇ RFDS emergency call (only AUS versions)

The RFDS (Royal Flying Doctor Service) emergency call uses a 2-Tone signal for an emergency call.

• Sending RFDS emergency call

- ① With the Memory Channel displayed, push [**↶**] to enter the Call select menu.
- ② Push [**⏪**](*) or [**⏩**](***) to set the Call to “SEL-CALL,” then push [**↶**] to enter the Selcall menu.

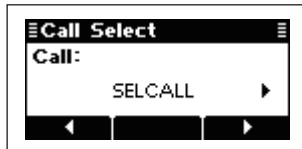

- ③ Push [**⏪**](*) or [**⏩**](***) to set the Call type to “RFDS EMERGENCY.”
 - “SELECTIVE,” “PHONE,” “MESSAGE,” “SEND POSITION,” “GET POSITION,” “GET STATUS,” “EMERGENCY,” “CHANNEL TEST” and “RFDS EMERGENCY” are selectable.

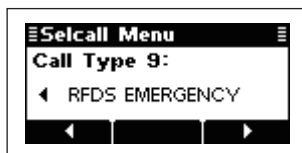

- ④ Push [**↶**] to enter the Channel Menu, and then push [**⏪**](*) or [**⏩**](***) to select the desired operating channel.
 - Push [**HOME**] to return to the Selcall menu.

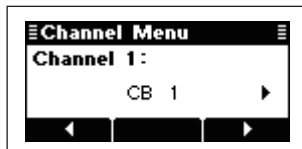

- ⑤ Push [**↶**] to transmit the RFDS emergency call. The call is stored in the Call Out memory.
 - While calling, push [**PTT**] to cancel the call.

/// You can also transmit an RFDS emergency call when the Selcall Address is displayed. In this case, you can skip steps ① to ③ above, after selecting the RFDS emergency call address.

◆ Emergency selcall

The Emergency call allows you to broadcast an emergency signal with your own position information.

• Sending Emergency call

- ① With the Memory Channel displayed, push [↵] to enter the Call select menu.
- ② Push [◀](*) or [▶](***) to set the Call to "SEL-CALL," then push [↵] to enter the Selcall menu.

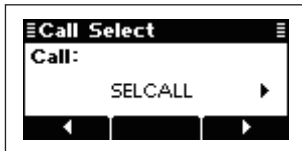

- ③ Push [◀](*) or [▶](***) to set the Call type to "EMERGENCY."
 - "SELECTIVE," "PHONE," "MESSAGE," "SEND POSITION," "GET POSITION," "GET STATUS," "EMERGENCY" and "CHANNEL TEST" are selectable.

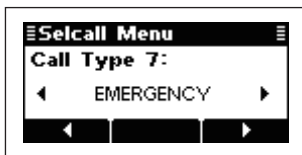

- ④ Push [↵] to go to the next screen.
 - Push [HOME] to return to the previous screen.

○ Call ID input

- ➔ Push the numeric keys to enter the Call ID.
 - Push [X] to delete the number.
 - This Call ID is not stored in the Call ID list.

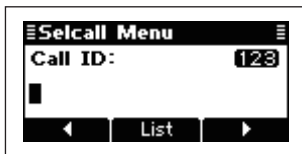

○ Call ID selection

- ➔ Push [List](**) to enter the list selection mode.
- ➔ Push [◀](*) or [▶](***) to select the Call ID.
 - Push [Edit](**) to return to the direct input mode.

- ⑤ Push [↵] to go to the next screen.
 - Push [HOME] to return to the previous screen.

○ Network selection

- ➔ Push [◀](*) or [▶](***) to select the Network.

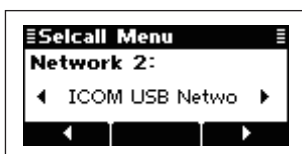

- ⑥ Push [↵] to go to the next screen.
 - Push [HOME] to return to the previous screen.
 - Self ID selection
 - ➔ Push [◀](*) or [▶](***) to select the Self ID.

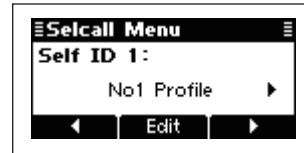

○ Self ID input

- ➔ Push [Edit](**) to enter the direct input mode.
- ➔ Push the numeric keys to enter the Self ID.
 - Push [X] to delete the number.
 - This Self ID is overwritten or stored in the Self ID list.
 - Push [List](**) to return to the list selection mode.

- ⑦ Push [↵] to enter the Channel Menu, and then push [◀](*) or [▶](***) to select the desired operating channel.
 - Push [HOME] to return to the Selcall menu.

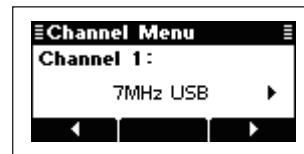

- ⑧ Push [↵] to transmit the Emergency call. The call is stored in the Call Out memory.
 - While calling, push [PTT] to cancel the call.

▨ You can also transmit an Emergency call when the Selcall Address is displayed. In this case, you can skip steps ① to ⑤ above, after selecting the Emergency call address.

• Receiving an Emergency Call

When your transceiver receives an Emergency Call with your individual ID, it automatically responds by transmitting. The received Emergency Call is stored in the Call In memory.

- ① After receiving a Emergency call, and push any key to enter the Call In memory.

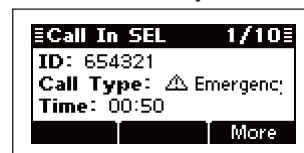

- ② Push [More](***) or [Prev](*) to select the information.

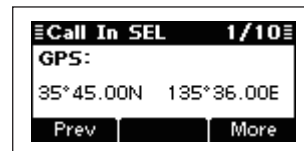

- ③ Push [HOME] to return to normal operating screen.

◇ Channel Test call

The Channel Test call allows the user determine the signal quality between your transceiver and a specific transceiver before an individual or group call. The Channel Test call is also used for checking the channel before sending a Phone call.

• Sending Channel Test call

- ① With the Memory Channel displayed, push [**↶**] to enter the Call select menu.
- ② Push [**⏪**](*) or [**⏩**](***) to set the Call to "SEL-CALL," then push [**↶**] to enter the Selcall menu.

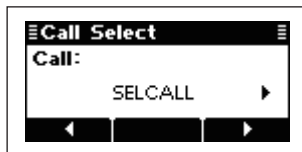

- ③ Push [**⏪**](*) or [**⏩**](***) to set the Call type to "CHANNEL TEST."
 - "SELECTIVE," "PHONE," "MESSAGE," "SEND POSITION," "GET POSITION," "GET STATUS," "EMERGENCY" and "CHANNEL TEST" are selectable.

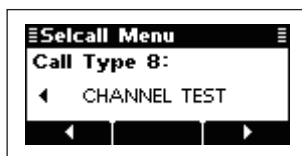

- ④ Push [**↶**] to go to the next screen.
 - Push [**HOME**] to return to the previous screen.
 - **Call ID input**
Push the numeric keys to enter the Call ID.
 - Push [**X**] to delete the number.
 - This Call ID is not stored in the Call ID list.

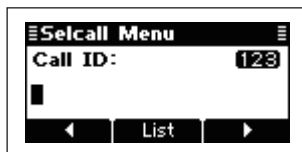

- **Call ID selection**
 - ➔ Push [**List**](***) to enter the list selection mode.
 - ➔ Push [**⏪**](*) or [**⏩**](***) to select the Call ID.
 - Push [**Edit**](**) to return to the direct input mode.
- ⑤ Push [**↶**] to go to the next screen.
 - Push [**HOME**] to return to the previous screen.
 - **Network selection**
Push [**⏪**](*) or [**⏩**](***) to select the Network.

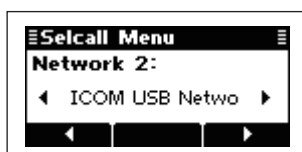

- ⑥ Push [**↶**] to go to the next screen.
 - Push [**HOME**] to return to the previous screen.
 - **Self ID selection**
Push [**⏪**](*) or [**⏩**](***) to select the Self ID.

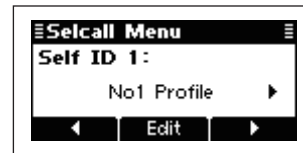

- **Self ID input**
 - ➔ Push [**Edit**](**) to enter the direct input mode.
 - ➔ Push the numeric keys to enter the Self ID.
 - Push [**X**] to delete the number.
 - This Self ID is overwritten or stored in the Self ID list.
 - Push [**List**](***) to return to the list selection mode.
- ⑦ Push [**↶**] to enter the Channel Menu, and then push [**⏪**](*) or [**⏩**](***) to select the desired operating channel.
 - Push [**HOME**] to return to the Selcall menu.

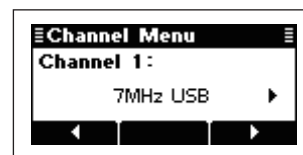

- ⑧ Push [**↶**] to transmit the Channel Test call. The call is stored in the Call Out memory.
 - While calling, push [**PTT**] to cancel the call.

▨ You can also transmit a Channel test call when the Selcall Address is displayed. In this case, you can skip steps ① to ⑤ above, after selecting the Channel Test call address.

◇ ALE call

Automatically establish a communication link by using the ALE table.

• Sending an Individual call

- ① With the Memory Channel displayed, push [↵] to enter the Call select menu.
- ② Push [←](*) or [→](***) to set the Call to “ALE,” then push [↵] to enter the ALE menu.

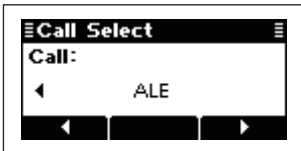

- ③ Push [←](*) or [→](***) to set the ALE type to “INDIVIDUAL.”
 - “INDIVIDUAL,” “NET,” “SOUNDING” and “AMD” are selectable.

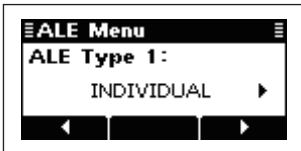

- ④ Push [↵] to go to the next screen.
 - Push [HOME] to return to the previous screen.
 - ALE ID selection
 - Push [←](*) or [→](***) to select the ALE ID.

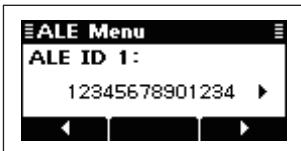

- ⑤ Push [↵] to go to the next screen.
 - Push [HOME] to return to the previous screen.
 - Self ID selection
 - Push [←](*) or [→](***) to select Self ID.

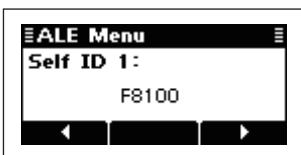

- ⑥ Push [↵] to enter the Channel Menu, and then push [←](*) or [→](***) to select the desired operating channel.
 - Push [HOME] to return to the ALE Menu.
 - When <Auto> is selected, the transceiver automatically selects the best quality channel in sequential order, using the LQA table.



- ⑦ Push [↵] to transmit an Individual call. The call is stored in the Call Out memory.
 - While calling, push [PTT] to cancel the call.

▨ You can also transmit an Individual call when the ALE ID is displayed. In this case, you can skip the Call selection.

• After an ALE call

- ① After an ALE call is finished, push any key to enter the ALE menu.
 - While linking the ALE call, “TERMINATION” appears.

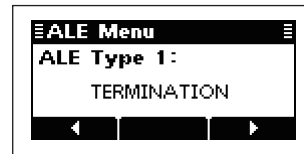

- ② Push [↵] to transmit a disconnect call.
 - Until 'TERMINATION' is transmitted, the channel cannot be changed.

• Sending Net call

- ① Set the Call to “ALE,” the same operation as Sending Individual call’s steps ① and ②, to the left.
- ② Push [←](*) or [→](***) to set the ALE type to “NET.”
 - “INDIVIDUAL,” “NET,” “SOUNDING” and “AMD” are selectable.

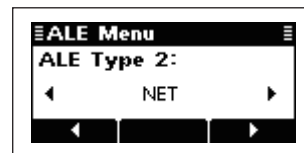

- ③ Push [↵] to go to the next screen.
 - Push [HOME] to return to the previous screen.
 - ALE ID selection
 - Push [←](*) or [→](***) to select an ALE ID for a Net call.

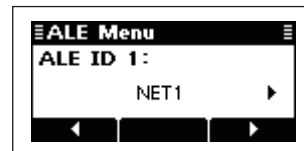

- ④ Select the Self ID and Operating channel, the same operation as Sending Individual call’s in steps ⑤ and ⑥ to the left.
- ⑤ Push [↵] to transmit the Net call. The call is stored in the Call Out memory.
 - While calling, push [PTT] to cancel the call.

▨ You can also transmit a Net call when the ALE ID is displayed. In this case, you can skip the Call selection.

◇ ALE sounding

Automatically sends a sounding signal at a certain interval (0.5–16 hours) to check the propagation and stores the data in a table. Manual soundings can also be made.

• Manual sounding

- ① With the Memory Channel displayed, push [**↶**] to enter the Call select menu.
- ② Push [**⏪**](*) or [**⏩**](***) to set the Call to “ALE,” then push [**↶**] to enter the ALE menu.

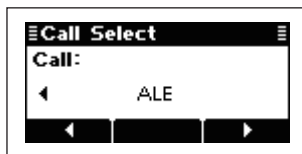

- ③ Push [**⏪**](*) or [**⏩**](***) to set the ALE type to “SOUNDING.”
 - “INDIVIDUAL,” “NET,” “SOUNDING” and “AMD” are selectable.

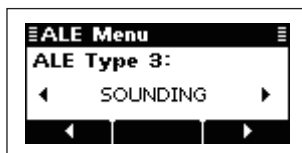

- ④ Push [**↶**] to go to the next screen.
 - Push [**HOME**] to return to the previous screen.

○ Self ID selection

Push [**⏪**](*) or [**⏩**](***) to select Self ID.

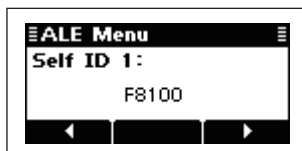

- ⑤ Push [**↶**] to enter the Channel Menu, and then push [**⏪**](*) or [**⏩**](***) to select the desired operating channel.
 - Push [**HOME**] to return to the ALE Menu.

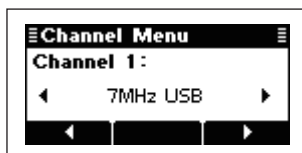

- ⑥ Push [**↶**] to transmit the ALE sounding.
 - While calling, push [**PTT**] to cancel the call.

▨ You can also transmit an ALE sounding when the ALE ID is displayed. In this case, you can skip the Call selection.

◇ ALE AMD

The ALE AMD (Automatic Message Display) sends and receives test messages of up to 90 characters.

- ① With the Memory Channel displayed, push [↵] to enter the Call select menu.
- ② Push [←](*) or [→](***) to set the Call to "ALE," then push [↵] to enter the ALE menu.



- ③ Push [←](*) or [→](***) to set the ALE type to "AMD."
 - "INDIVIDUAL," "NET," "SOUNDING" and "AMD" are selectable.

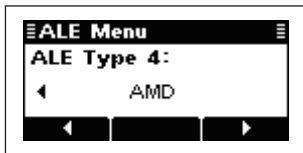

- ④ Push [↵] to go to the next screen.
 - Push [HOME] to return to the previous screen.
 - ALE ID selection
 - Push [←](*) or [→](***) to select the ALE ID.

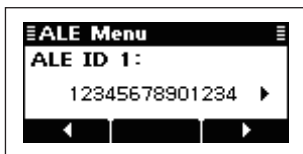

- ⑤ Push [↵] to go to the next screen.
 - Push [HOME] to return to the previous screen.
 - Self ID selection
 - Push [←](*) or [→](***) to select the Self ID.

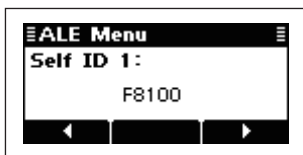

- ⑥ Push [↵] to go to the next screen.
 - Push [HOME] to return to the previous screen.
 - ALE Message selection
 - Push [←](*) or [→](***) to select the ALE Message.

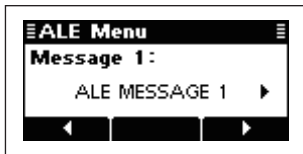

- ⑦ Push [↵] to enter the Channel Menu, and then push [←](*) or [→](***) to select the desired operating channel.
 - Push [HOME] to return to the ALE Menu.
 - When <Auto> is selected, the transceiver automatically selects the best quality channel in sequential order, using the LQA table.



- ⑧ Push [↵] to transmit an ALE AMD call. The call is stored in the Call Out memory.
 - While calling, push [PTT] to cancel the call.

▨ You can also transmit an ALE AMD when the ALE ID is displayed. In this case, you can skip the Call selection.

• Disconnecting an ALE call

- ① After an ALE call is finished, push [↵] to enter the ALE menu.
 - While linking the ALE call, "TERMINATION" appears.

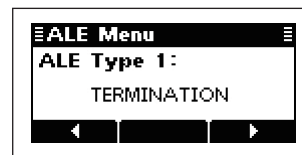

- ② Push [↵] to transmit and disconnect the call.
 - Until 'TERMINATION' is transmitted, the channel cannot be changed.

■ Edit Menu

◇ Editing the Clock Setting

- ① Hold down **[MENU](HOME)** for 1 second to enter the Menu screen.
- ② Push **[△]** one or more times to select the Edit Menu, and then push **[✓]**.
- ③ Push **[△]** once to select the Clock Setting, and then push **[✓]** again.

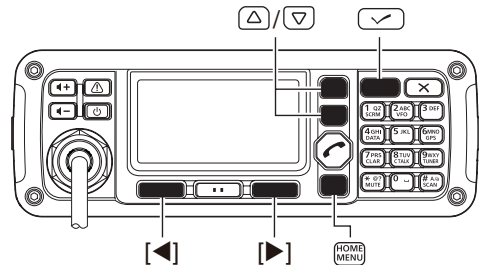
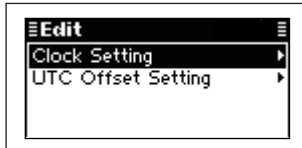

- ④ Push the numeric keys, 0 to 9 to edit the time.
 - Push **[◀](*)** or **[▶](***)** to move the cursor.

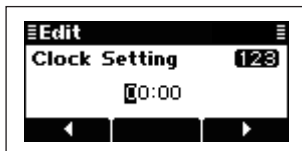

- ⑤ Push **[✓]** to save the time.
- ⑥ Push **[MENU](HOME)** twice to return to the normal operating screen.

4

5

◇ Editing the UTC Offset Setting

- ① Hold down **[MENU](HOME)** for 1 second to enter the Menu screen.
- ② Push **[△]** one or more times to select the Edit Menu, and then push **[✓]**.
- ③ Push **[▽]** once to select the UTC Offset Setting, and then push **[✓]** again.



- ④ Push **[◀](*)** or **[▶](***)** to adjust the offset time.
 - Hold down **[Clear](**)** for 1 second to clear the offset time.

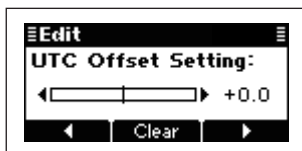

- ⑤ Push **[✓]** to save the offset.
- ⑥ Push **[MENU](HOME)** twice to return to the normal operating screen.

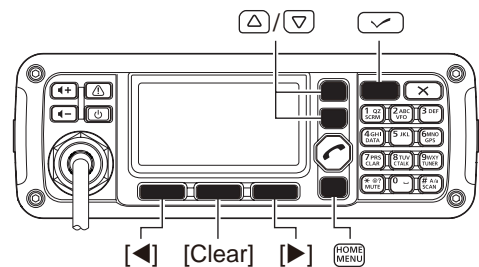

■ User Menu

◇ Entering the User Menu

- ① Hold down **[MENU](HOME)** for 1 second to enter the Menu screen.
- ② Push **[△]** or **[▽]** to select the User Menu, and then push **[✓]**.
- ③ Push **[△]** or **[▽]** to select the desired item.
- ④ Push **[◀](*)** or **[▶](***)** to adjust or set the value or setting.
 - Hold down **[Default](**)** for 1 second to set the default value or setting.
- ⑤ Push **[MENU](HOME)** twice to return to the normal operating screen.

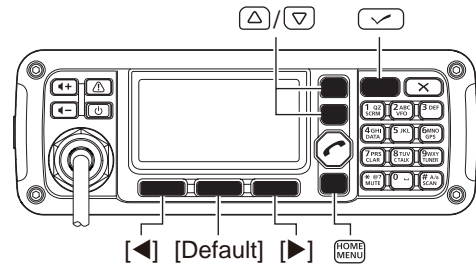

◇ User Menu items

LCD Contrast

Adjust the contrast of the LCD between 0 and 10 in 1 digit steps. (Default: 6)



LCD Dimmer

Adjusts the backlight brightness of the LCD between 0 (dark) and 10 (bright) in 1 digit steps. (Default: 5)
 1 to 10 : Lights while transceiver power is ON.
 0 : Turns OFF the backlight.



Backlight

Set the LCD backlight timer to OFF, Continuous, 5 seconds to 90 seconds in 5 second steps. (Default: CONT)

- CONT : Lights continuously while transceiver power is ON.
- 5sec to 90sec : Lights when some operation is performed, goes out after specified time period.
- OFF : Never lights.



BEEP Level

Adjust the confirmation beep level between 0 (OFF) and 50 (Maximum) in 1 digit steps. (Default: 30)

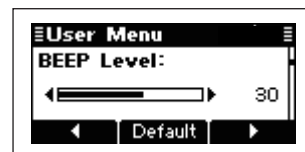

* When the Advanced User Menu in the Admin Menu is set to OFF, these items are not displayed. In this case, only the LCD Contrast, LCD Dimmer, Backlight, BEEP Level, Squelch Level, Noise Blanker, RF Power and Mic Gain values can be adjusted, or the settings selected.

Squelch Level

Adjust the squelch threshold level between 0 and 50, in 1 digit steps. (Default: 10)

When the S-meter squelch is activated, only signals stronger than this set level are received.



Noise Blanker

Turns the noise blanker function ON or OFF. (Default: OFF)

The Noise Blanker function eliminates pulse-type noise such as that from car ignitions.



Blanker Level*

This item appears when the "Advanced User Menu" in the Admin Menu is set to ON.

Adjust the Noise blanker level between 0 and 15 in 1 digit steps. (Default: 10)

The set level is effective when the Noise Blanker is activated.



AGC*

This item appears when the "Advanced User Menu" in the Admin Menu is set to ON.

Set the Automatic gain control settings to FAST, SLOW or AUTO. (Default: AUTO)



Bandwidth*

This item appears when the "Advanced User Menu" in the Admin Menu is set to ON.

Set the IF filter passband width to NARROW, MID or WIDE. (Default: WIDE)



Clarifier*

This item appears when the "Advanced User Menu" in the Admin Menu is set to ON.

Set the Clarifier function capability ON or OFF. (Default: OFF)

When this setting is ON, push [CLAR](7) to turn ON the Clarifier function in the VFO/Memory Channel display.



Pre Amp*

This item appears when the "Advanced User Menu" in the Admin Menu is set to ON.

Turn the receiver Preamplifier function ON or OFF. (Default: ON)

When receiving a weak signal, turn ON this item.



* When the Advanced User Menu in the Admin Menu is set to OFF, these items are not displayed. In this case, only the LCD Contrast, LCD Dimmer, Backlight, BEEP Level, Squelch Level, Noise Blanker, RF Power and Mic Gain values can be adjusted, or the settings selected.

◇ User Menu items (Continued)

RF Power

Set the transmit output power to LOW, MID or HIGH.
(Default: HIGH)

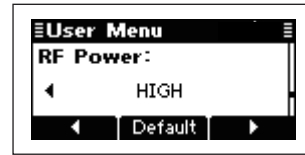

Speech Processor*

This item appears when “Advanced User Menu” in the Admin Menu is set to ON.
Turns the Speech Processor function ON or OFF.
(Default: OFF)



Processor Level*

This item appears when “Advanced User Menu” in the Admin Menu is set to ON.
Adjust the Speech Processor Level to between 0 (Minimum) and 10 (Maximum) in 1 digit steps.
(Default: 6)
The set level is effective only when the Speech Processor is turned ON.



Mic Gain

Adjust the Microphone gain to between 0 (Minimum) and 10 (Maximum) in 1 digit steps.
(Default: 6)

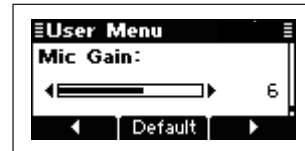

Key Lock*

This item appears when “Advanced User Menu” in the Admin Menu is set to ON.
Turn the Lock function ON or OFF. You can select the two types of Lock functions, “ALL” or “NUMERIC KEY.”
(Default: OFF)



Side Tone Level*

This item appears when “Advanced User Menu” in the Admin Menu is set to ON.
Adjust the CW side tone level from 0 (OFF) to 50 in 1 digit steps.
(Default: 30)



* When the Advanced User Menu in the Admin Menu is set to OFF, these items are not displayed. In this case, only the LCD Contrast, LCD Dimmer, Backlight, BEEP Level, Squelch Level, Noise Blanker, RF Power and Mic Gain values can be adjusted, or the settings selected.

Admin Menu

The Admin Menu is used for programming infrequently changed values, settings or functions.

◇ Entering the Administrator mode

When first entering the Administrator mode, a login password may be required, depending on the preprogramming.

- ① Turn OFF the transceiver power, if it is ON.
- ② While holding down [▲], [☎] and [✕], push [⏻] to turn ON the transceiver power and enter the Administrator mode.
 - The “Login” display appears, depending on the preprogramming.

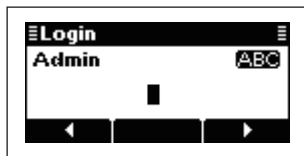

- ③ Push the keypad keys to enter your password, and then push [✓] to enter the Administrator mode.
 - Repeatedly push [A/a](#) to select the character group, ABC (upper case letters), abc (lower case letters) or 123 (numbers).
 - Push [✕] to delete a character.
 - Push [◀](▪) or [▶](•••) to move the cursor.

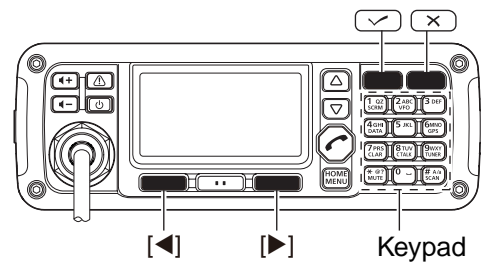
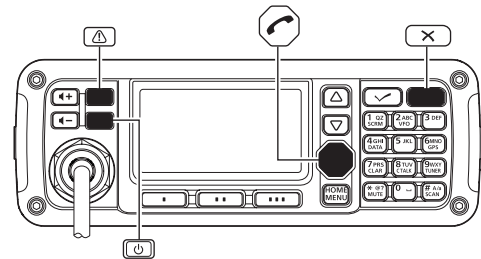

◇ Entering Admin Menu

- ① Hold down [MENU](HOME) for 1 second to enter the Menu screen.
- ② Push [▽] to select the Admin Menu, and then push [✓].
- ③ Push [▲] or [▽] to select the desired item.
- ④ Push [◀](▪) or [▶](•••) to adjust or set the value or setting.
 - Hold down [Default](••) for 1 second to set the default value or setting.
- ⑤ Push [MENU](HOME) twice to return to the normal operating screen.

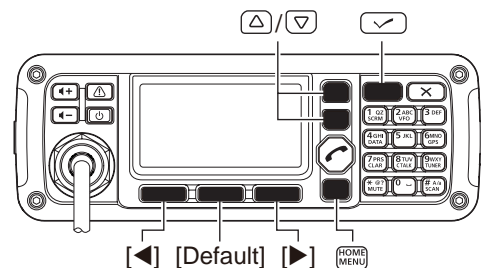

◇ Return to User mode

- ① Turn OFF the transceiver power, if the transceiver is powered ON.
- ② While holding down [HOME], push [⏻] to turn ON the transceiver power to return to the User mode.

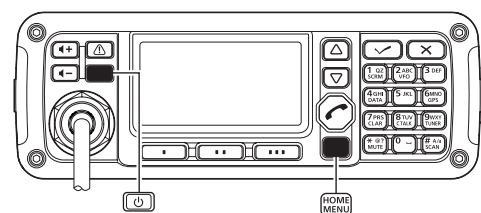

◇ Admin Menu items

Tuner type

Select the connected Icom antenna tuner from AT-140 or AT230 antenna tuner or OFF.

(Default: OFF)



TX Timeout

Set the Time-Out Timer function time to 1, 3, 5 or 10 minutes, or OFF. If a continuous transmission exceeds the selected time period, transmitting will be cut off.

(Default: 3min)



CW Break-In

The CW Break-In function toggles transmit and receive with your CW keying. This allows you to mute receiving the time delay ends after you stop keying. Turn ON the CW Break-In function and sets the delay to 0.5, 1, 2 or 3 seconds, or OFF. (Default: 2.0sec)



VFO Mode

Select the activation of the VFO mode ON or OFF.

(Default: ON)

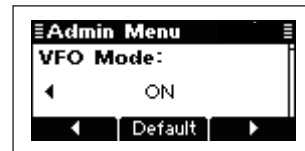

AGC

Turn the Automatic gain control function ON or OFF.

(Default: ON)

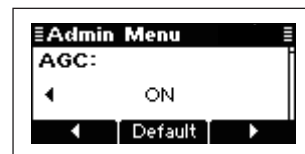

Clear Talk Level

The Clear Talk function adjusts signals in the presence of noise using the DSP circuit. This item adjusts the Clear Talk Level from 1 (Minimum) to 15 (Maximum). (Default: 10)



Meter Type

This item sets the transmit meter type to TX POWER or MIC LEVEL. (Default: TX POWER)

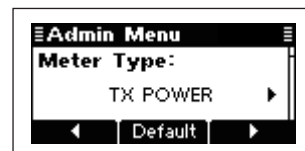

FSK Tone

Several mark frequencies are used for FSK operation. Select an FSK mark frequency for almost any FSK system, of 1200 Hz, 1275 Hz, 1487.5 Hz, 1615 Hz, 1700 Hz, 2100 Hz or 2125 Hz. (Default: 1615 Hz)

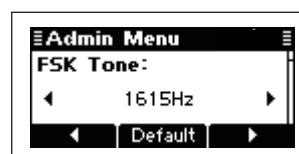
**FSK shift**

Several shift frequencies are used for FSK operation. Select an FSK shift frequency for almost any FSK system, of 170 Hz, 200 Hz, 425 Hz or 850 Hz. (Default: 170 Hz)

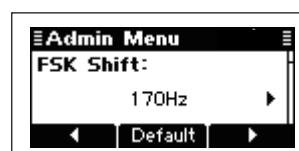
**FSK Polarity**

Normal and reverse FSK polarities are selectable. Select either NORMAL or REVERSE. (Default: NORMAL)

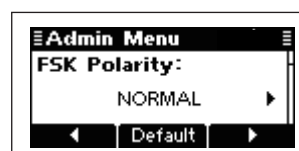
**Modem**

Set the Modem for the Data mode to INTERNAL, EXTERNAL or OFF. (Default: OFF)

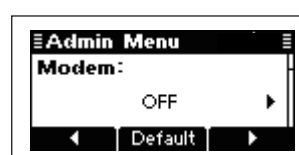
**Data Mode 1**

Set Data Mode 1 to S4539, M188-110B, S4285, S4529, S4415, M188-110A or FSK. (Default: S4539)

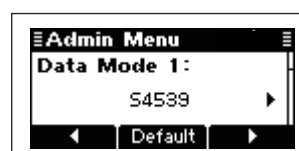
**Data Mode 2**

Set Data Mode 2 to S4539, M188-110B, S4285, S4529, S4415, M188-110A or FSK. (Default: M188-110B)

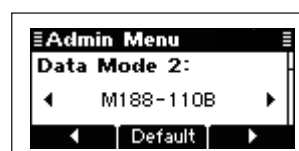
**Data Mode 3**

Set Data Mode 3 to S4539, M188-110B, S4285, S4529, S4415, M188-110A or FSK. (Default: FSK)

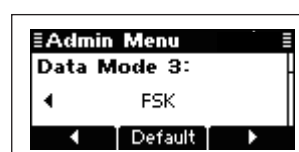

◇ Admin Menu items (Continued)

Shift Frequency

Set the frequency shift for the Data mode to 1800Hz USB, 1500Hz USB, 1800 Hz LSB or 1500Hz LSB.
(Default: 1800Hz USB)

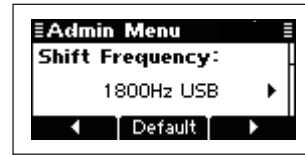

Scan

Set the scan type to ALE, SELCALL, VOICE, CALL, ALL MEMORY or OFF.
(Default: OFF)

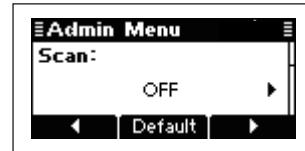

Scan Resume

Set the scan resume function to ON or OFF.
(Default: OFF)

When this setting is ON, a scan pauses for 10 seconds, then resumes, or resumes 2 seconds after the signal disappears.

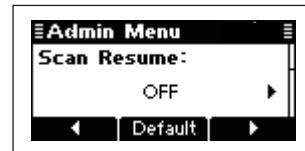

Scan Auto Start

Sets the scan resume timer to between 1 minute and 10 minutes or OFF, for all scan types. (Default: OFF)
When this setting is ON, the scan pauses for the set time period after your last transmission, then resumes.



Scan Speed

Set the scan speed for the All Memory scan to HIGH, MID or LOW.
(Default: HIGH)

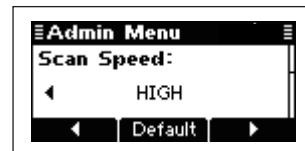

Selcall Silent

Set the automatic answer back function for the Selcall to ON or OFF.
(Default: OFF)

When OFF is selected, the transceiver automatically answers back if your station ID is called.

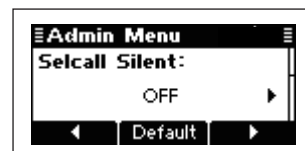

Selcall Time Out

If you are calling a specific station, but no answer is received, then transceiver cancels waiting for an answer back after this time period.

Set the waiting time for the Selcall answer back while calling.
(Default: 60 sec)



Selective Mode

Set the activation of Selcall to both reception and transmission, reception only, transmission only or disable. (Default: RX&TX)

**Channel Test Mode**

Set the activation of Channel Test call to both reception and transmission, reception only, transmission only or disable. (Default: RX&TX)

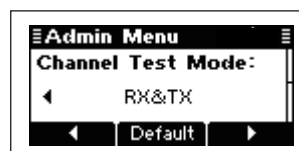
**Send Position Mode**

Set the activation of Position transmitting call to both reception and transmission, reception only, transmission only or disable. (Default: RX&TX)

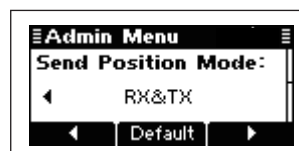
**Get Position Mode**

Set the activation of Position request call to both reception and transmission, reception only, transmission only or disable. (Default: RX&TX)

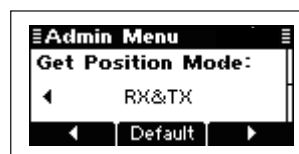
**Phone Mode**

Set the activation of Phone call to both reception and transmission, reception only, transmission only or disable. (Default: RX&TX)

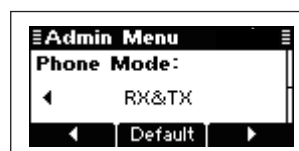
**Get Status Mode**

Set the activation of Status request call to both reception and transmission, reception only, transmission only or disable. (Default: RX&TX)

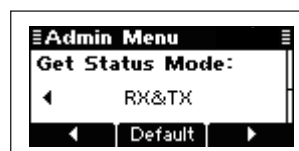
**Message Mode**

Set the activation of Message Call to both reception and transmission, reception only, transmission only or disable. (Default: RX&TX)



◇ Admin Menu items (Continued)

Emergency Mode

Select the activation of Emergency call to both reception and transmission, reception only, transmission only or disable. (Default: RX&TX)



ALE Mode

Select the activation of ALE to both reception and transmission, reception only, transmission only or disable. (Default: RX&TX)

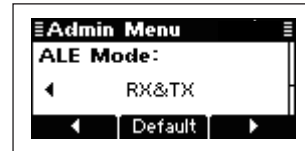

ALE Scan Group

Set the ALE scanning group to between 1 and 100. (Default: 1)

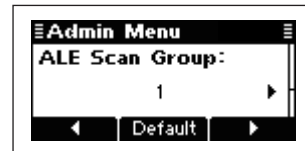

ALE Scan Speed

Set the scan speed for the ALE and Call scans to HIGH, MID or LOW. (Default: HIGH)

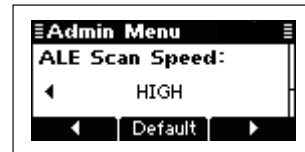

ALE Auto Sounding

The Auto Sounding function allows users to determine the signal quality.

Set the Auto Sounding interval to 30 minutes, 45 minutes, 1 hour, 2 hours, 3 hours, 4 hours, 8 hours, 16 hours or OFF.

(Default: OFF)



ALE Auto Sounding Group

Set the ALE Auto Sounding group to between 1 and 100.

(Default: 1)

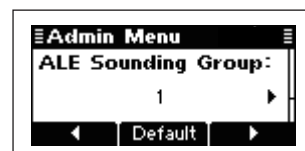

ALE Auto Sounding Self ID

Set the Self ID for the Auto Sounding function to between 1 and 20.

(Default: 1)

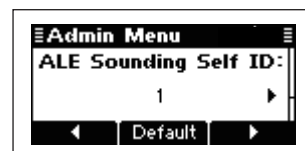

ALE Decay Time

Set the decay time for the Auto Sounding function to between 1 and 8 hours. (Default: 1 hour)

**ALE Sounding Length**

Set the signal length to between 5 words and 100 words, in 1 word steps. (Default: 5 words)

The transceiver repeats to call a calling ID during this setting length.

**ALE BER Threshold**

Set the Bit Error Ratio (BER) threshold level to between 0 and 48 bits for ALE communication quality. (Default: 12)

One unit consists of 48 bits of data.

**ALE Golay Threshold**

Set the Golay threshold level to between 0 and 3 bits for ALE communication quality. (Default: 3)

The Golay consists of 12 bits of original data and 12 bits of correction data.

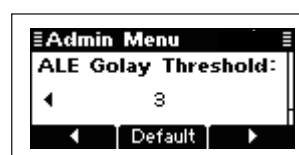
**ALE Error Threshold**

Set the Error threshold level to between 0 and 4 for ALE communication quality.

(Default: 0)

When errors detected by BER threshold or Golay threshold are over this setting, communication is not possible.

**ALE Silent**

Set the ALE Silent mode ON or OFF.

(Default: OFF)

When set to OFF, the transceiver automatically answers back if your station ID is called. When set to ON, the transceiver ignores the call.

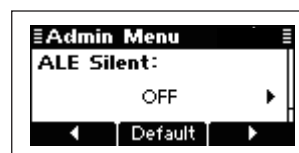
**ALE Call Retry**

Set the retry times to between 0 (OFF) and 99 when the called station does not answer back. (Default: 0)

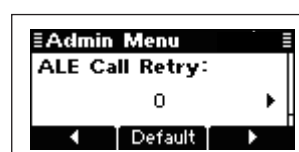

◇ Admin Menu items (Continued)

ALE LQA Average

Set the adopting number of LQA data for averaging to between 1 and 8. (Default: 8)

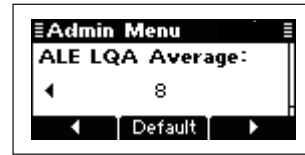

ALE LQA Request

Set the LQA request function to ON or OFF. (Default: ON)

When set to ON, the transceiver requests the called station to send LQA data with an ALE answer back call.



ALE Scan Call Time

Set the registration of the scan channel number for your group to set the ALE calling times. Selectable number are 1–100 in 1 digit steps, or AUTO. (Default: AUTO)

AUTO: The same setting as your scan channels.



RFDS TX Time

Set the time period of the RFDS call emission length to between 10 and 60 seconds in 1 second steps. (Default: 30sec)



Emer Link Interval

Set the interval time period of the Emergency Link function to between 10 and 300 seconds in 10 seconds steps. (Default: 120sec)

The transceiver will sequentially send a Selcall to the specified stations.



Advanced User Menu

Set the Advanced User Menu to ON or OFF. (Default: OFF)

When set to ON, additional set items, Blanker Level, AGC, Bandwidth, Clarifier, Pre Amp, Speech Processor, Processor Level, Key Lock and Side Tone Level appear in the User Menu.



BIT Display

Set the activation of Built-in Test display to ON or OFF. (Default: ON)

When set to ON, the transceiver displays the device check screen after turning ON the power.



AF Line Select

When the optional AD-119 is connected, select the input for the modulation signals from an external unit, such as an HF email modem or TNC (Terminal Node Controller). (Default: USB)

When MODEM is selected, the input for the modulation signals is from an internal or external modem.

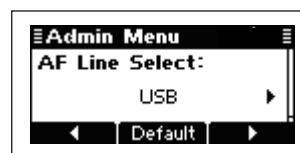

CI-V Baudrate

Set the data transfer rate to 300, 1200, 4800, 9600, 19200 bps or AUTO. (Default: AUTO)



CI-V Address

To distinguish equipment, each CI-V transceiver has its own Icom standard address in hexadecimal code. The IC-F8100's address is 82h. (Default: 82h)



5

■ CPU Reset

If you want to initialize the operating settings in the User Menu and Admin Menu without clearing memory channel contents or ID contents, do the following steps.

- ① Turn OFF the transceiver power, if the transceiver is powered ON.
- ② While holding down [△] and [▽], push [⏻] to turn ON the transceiver power to reset the CPU.

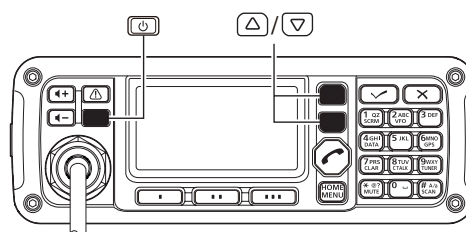

■ Supplied accessories

◇ One package type

The following accessories are supplied with IC-F8100 One package type.

- ① Microphone (HM-193) 1
- ② External speaker (SP-25)..... 1
- ③ DC power cable (OPC-2140) 1
- ④ Rubber feet 4
- ⑤ Black and red cables with fuse holders..... 1 set
- ⑥ Spare fuses (ATC 30 A) 2
- ⑦ Microphone hanger kit 1 set
- ⑧ Crimp terminals..... 2

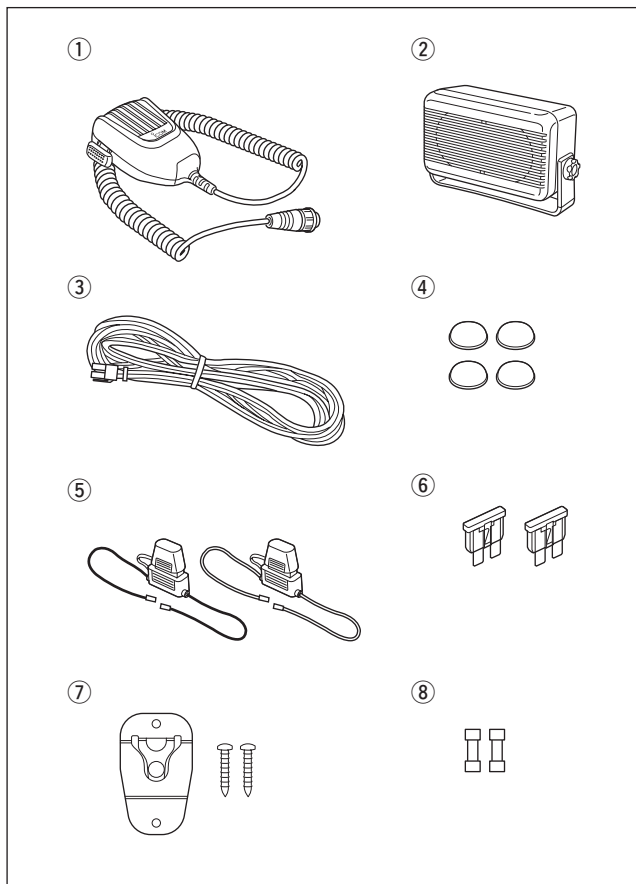

◇ Separated Type

The following accessories are supplied with IC-F8100 Separated type.

- ① Microphone (HM-193) 1
- ② External speaker (SP-25)..... 1
- ③ DC power cable (OPC-2140) 1
- ④ Rubber feet 4
- ⑤ Black and red cables with fuse holders..... 1 set
- ⑥ Spare fuses (ATC 30 A) 2
- ⑦ Microphone hanger kit 1 set
- ⑧ Crimp terminals..... 2
- ⑨ Remote controller with mounting bracket..... 1
- ⑩ Separation kit* 1 set

*The separation cable is not supplied, and must be purchased separately according to the cable length.

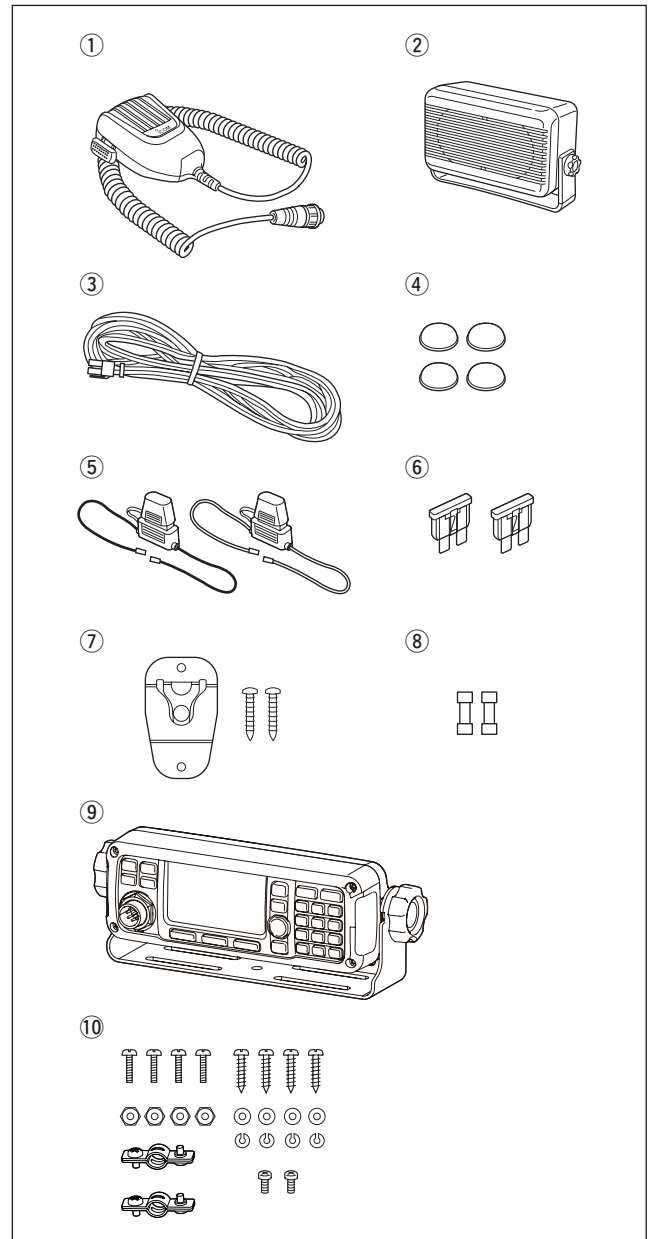

◇ Remote control microphone Type

The following accessories are supplied with IC-F8100 Remote control microphone type.

- ① Remote control microphone (HM-192)..... 1
- ② External speaker (SP-25)..... 1
- ③ DC power cable (OPC-2140) 1
- ④ Rubber feet 4
- ⑤ Black and red cables with fuse holders..... 1 set
- ⑥ Spare fuses (ATC 30 A) 2
- ⑦ Microphone hanger kit 1 set
- ⑧ Crimp terminals..... 2
- ⑨ Extension MIC connector..... 1

*The separation cable is not supplied, and must be purchased separately according to the cable length.

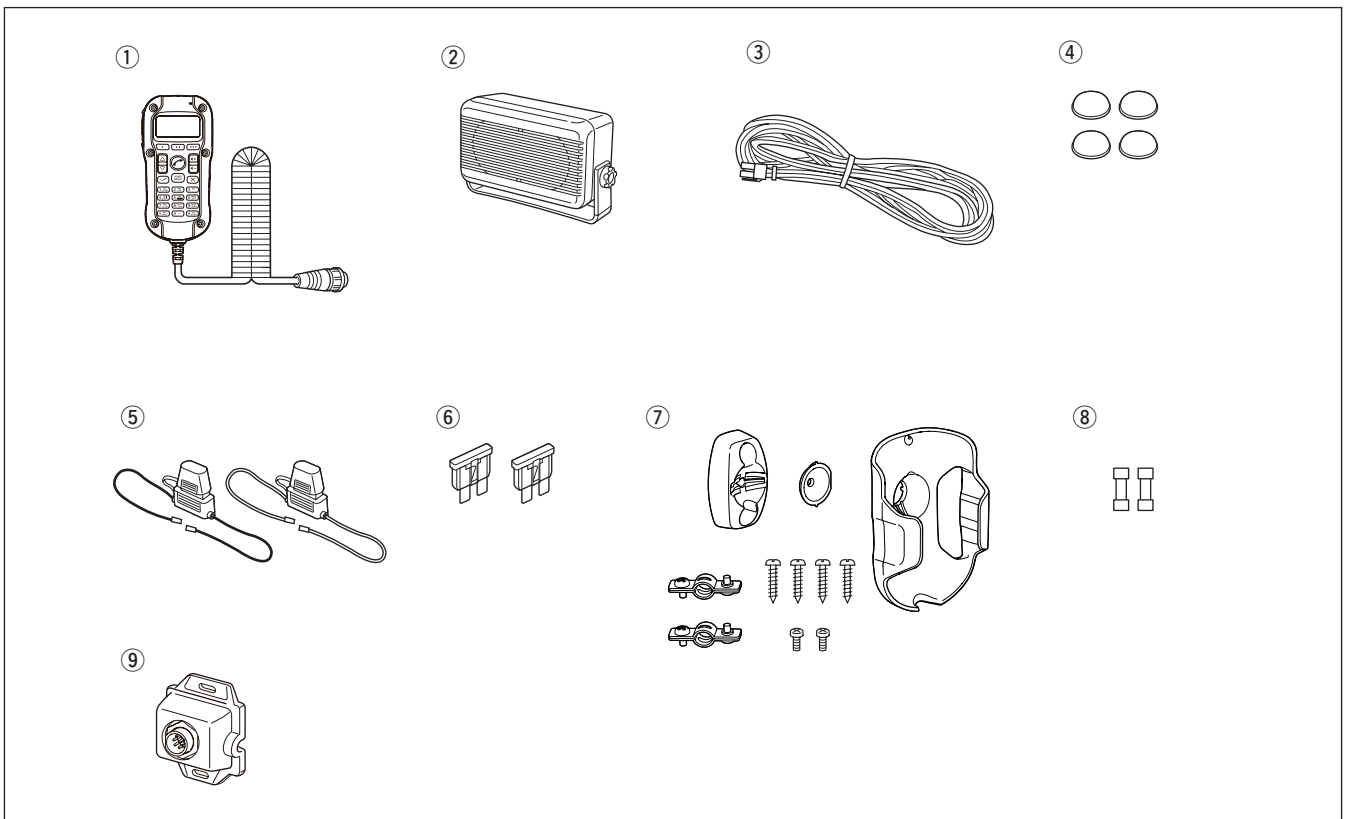

■ Connections

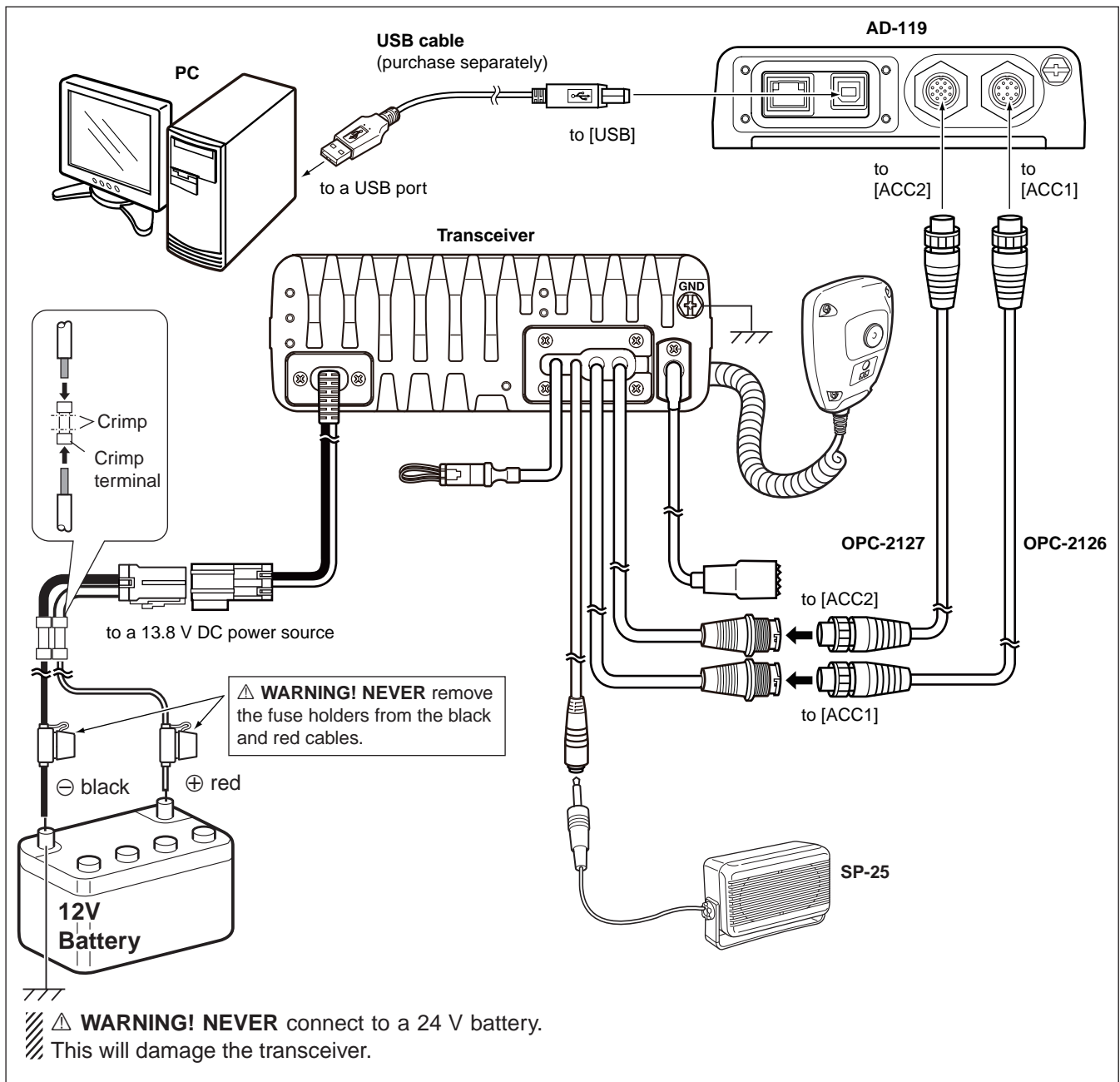

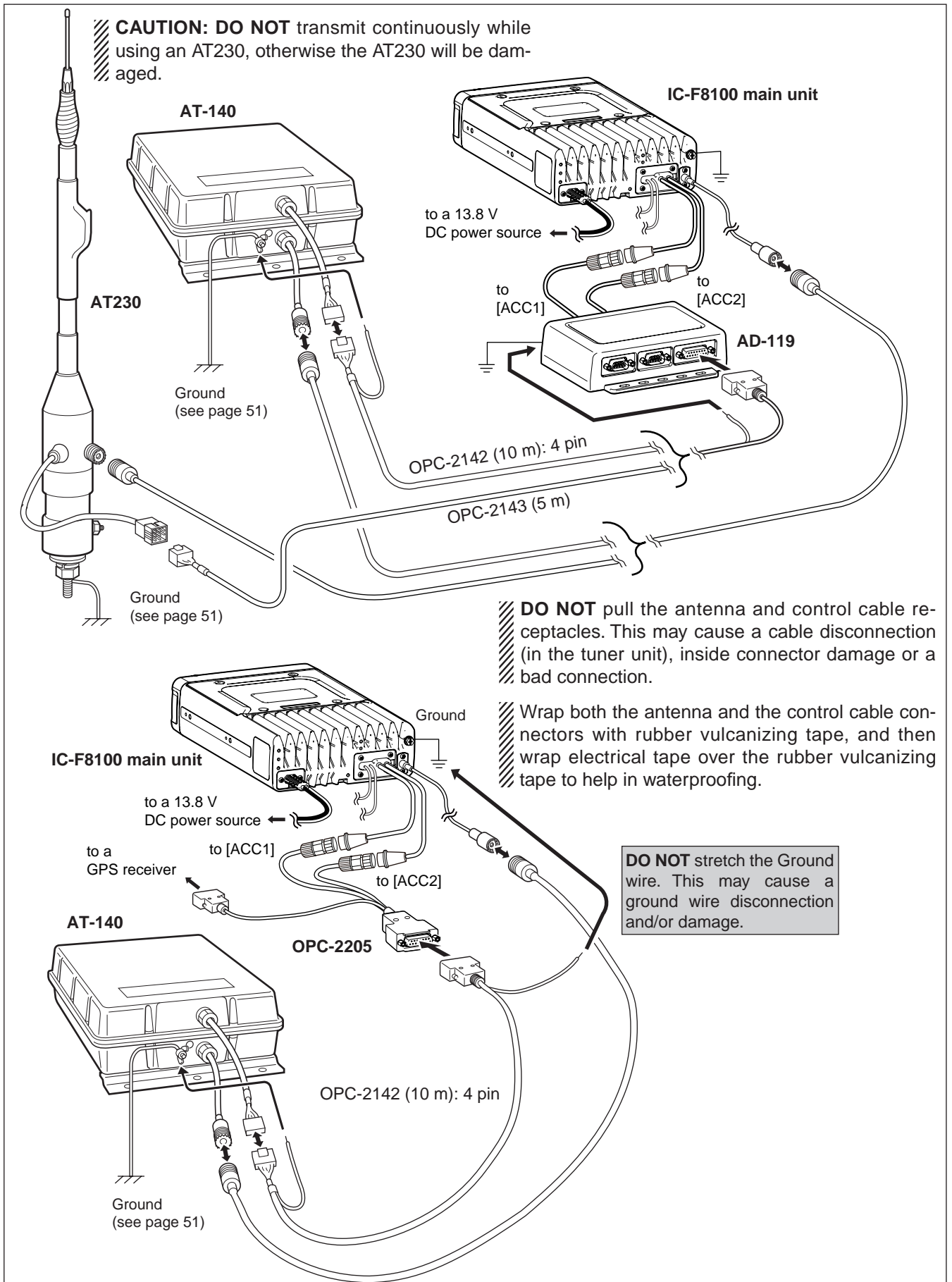

6

Ground connection

The transceiver and antenna tuner MUST have an adequate RF ground connection. Otherwise, the overall efficiency of the transceiver and antenna tuner installation will be reduced. Electrolysis, electrical shocks and interference from other equipment could also occur.

For best results, use a 50 or 75 mm (2 or 3 inches) wide copper strap and make the connection as short as possible. Ground the transceiver and antenna tuner to the same ground point, otherwise the voltage difference (at the RF level) between 2 ground points may cause electrolysis.

⚠ WARNING! When grounding to a metal hull
 Use Zinc anodes to protect the hull from electrolysis.
 Ask your dealer, technical installer or refer to a technical book, and so on, for RF grounding details.

Best ground points

- External ground plate
- Copper screen
- Copper foil

Unusable ground points

(These connections may cause an explosion or electrical shock)

- Gas or electrical pipe
- Fuel tank or oil-catch pan

Ground system example

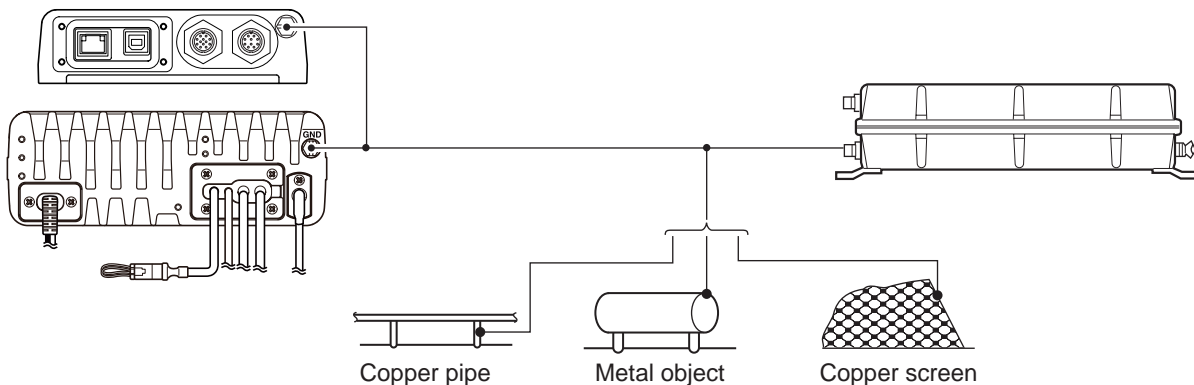

Power source

The transceiver requires regulated DC power of 13.8 V and at least 28 A. There are two ways to supply power:

- Direct connection to a 12 V battery in your vehicle through the supplied DC power cable.
- Use a DC power supply connected to an AC outlet.

DC power cable connection

⚠ NOTE: Use terminals for the cable connection.

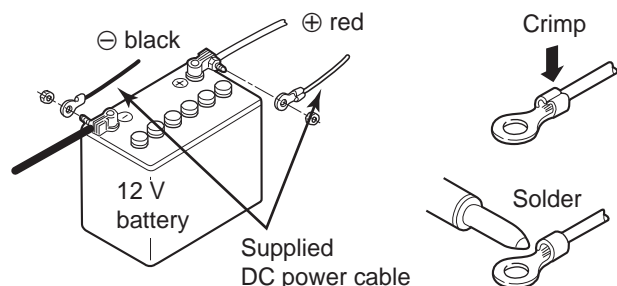

■ Antenna

Most stations operate with a whip or long wire (insulated back stay) antenna. However, these antennas cannot be connected directly to the transceiver since their impedance may not match with the transceiver antenna connector.

⚠ DANGER HIGH VOLTAGE!
NEVER touch the antenna element/wire while tuning or transmitting.

<p>◇ AT-140 AUTOMATIC ANTENNA TUNER See page 50.</p>	<p>◇ Non-Icom tuner Some non-Icom tuners may be used with the IC-F8100. Please consult your dealer if you wish to use one.</p>
--	--

■ CFU-F8100 (Optional Cooling Fan)

- ① Attach the Cooling fan to the transceiver's heat-sink, and tighten the 4 supplied M3 × 8 screws.
- ② Secure the connector and cables using the supplied cable tie.

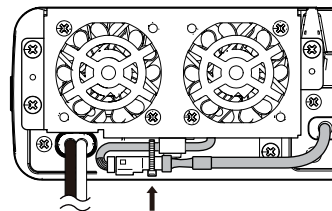
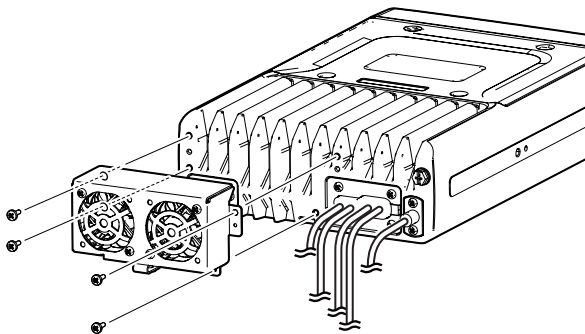

For Users in California (U.S.A.)

This CR-1632 Lithium Battery contains Perchlorate Material—special handling may apply.

See <http://www.dtsc.ca.gov/hazardouswaste/perchlorate>

■ RMK-6 (Optional Separation kit)

The RMK-6 allows you to install the IC-F8100's Front panel separately from the Main unit for added installation convenience and operation. Use either the optional OPC-607, OPC-608, OPC-609 or OPC726 SEPARATION CABLE with the RMK-6.

The RMK-6 is the same as the separation kit for the Separated type transceiver.

◇ Supplied Accessories

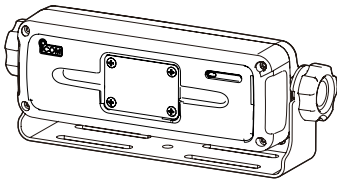

RMK-6 with Mounting bracket

Flat washers (M5)



Mounting screws (M5 x 12)



Cable clamps (Screws M2.6 x 5)



Spring washers (M5)



Self-tapping screws (M5 x 16)



Hex socket screws



Nuts (M5)



Screws (M3 x 8)



◇ Separation

The optional OPC-607 (3 m), OPC-608 (8 m), OPC-609 (1.9 m) or OPC-726 (5 m) SEPARATION CABLE is required for separately installing the transceiver front panel and Main unit.

- ① First, make sure the transceiver's power is OFF, then disconnect the DC power cable.
- ② Remove the knob bolts and mounting bracket from the RMK-6.

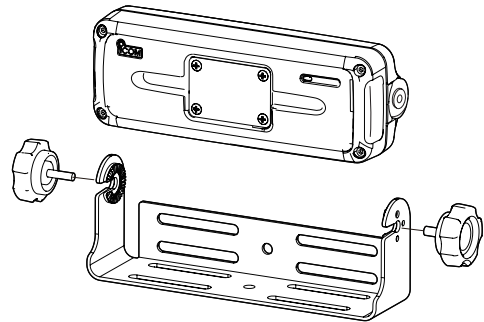

- ③ Unscrew the 4 hex socket screws using an allen wrench, then remove the front panel from the transceiver in the direction of the arrow.
 - Separate the RMK-6's front panel attachment and Main unit attachment in the same way.

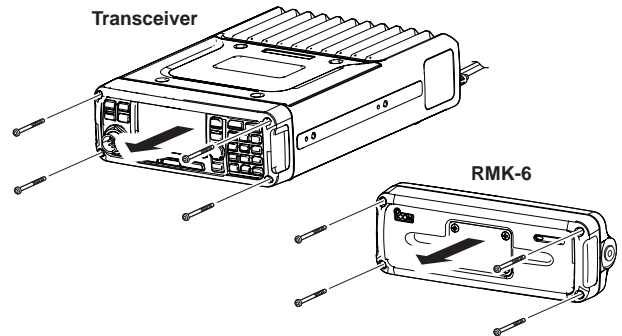

- ④ Disconnect the connection cable from the front panel.

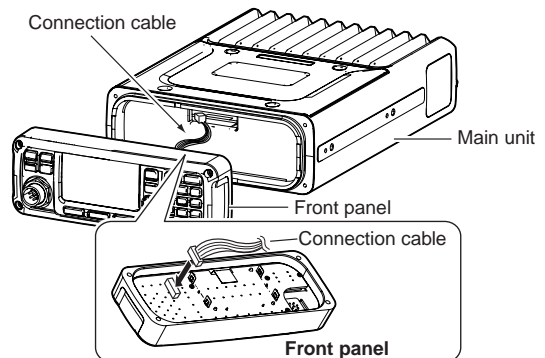

- ⑤ Unscrew the 4 rear plate screws, then remove the rear plates from both the front panel and Main unit attachments.

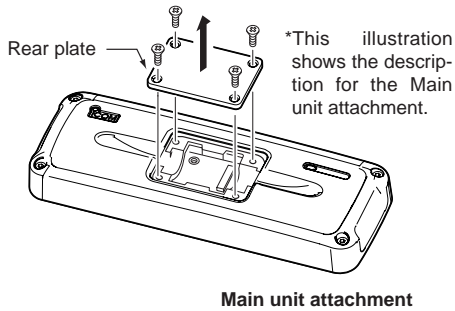

- ⑥ Connect either the OPC-607, OPC-608, OPC-609 or OPC-726 separation cable to the Main unit attachment, as shown below. After the connecting the cable, replace the rear plate and the 4 screws.
- The separation cable can be inserted into either the left or right grooves on the back of the attachment.

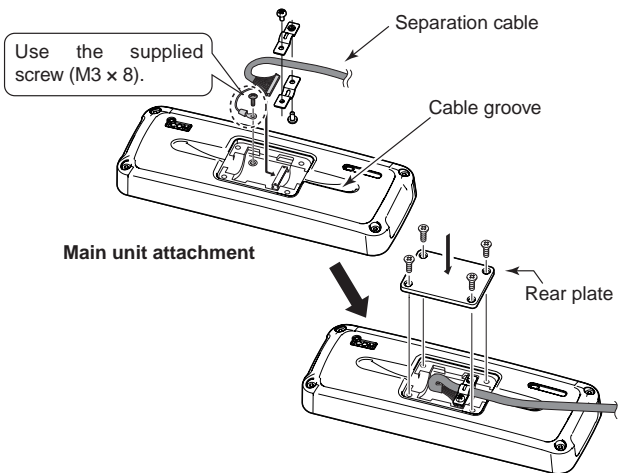

- ⑦ Connect the connection cable coming from the RMK-6, as shown below. Then tighten the 4 hex socket screws.

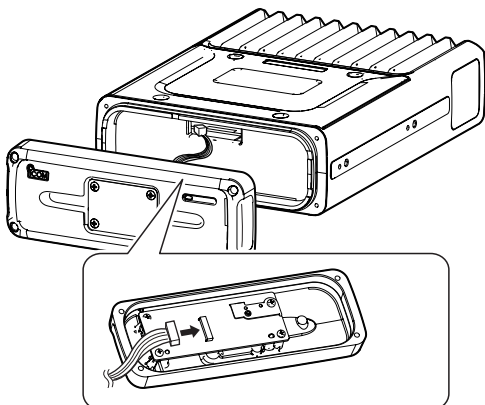

- ⑧ Connect the other end of the Separation cable to the front panel attachment, as shown below. After the cable connection, replace the removed rear plate and the 4 screws.
- The separation cable can be inserted into either the left or right grooves on the back of the attachment.

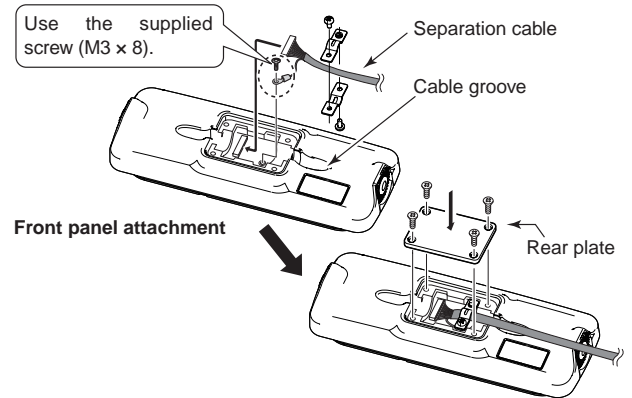

- ⑨ Connect the connection cable coming from the RMK-6, as shown below. Then tighten the 4 hex socket screws.

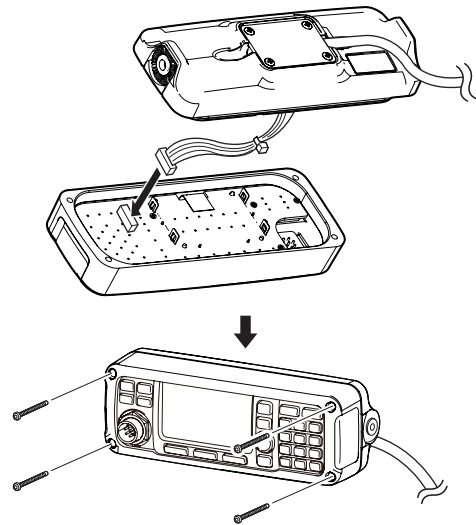

■ HM-192 (Optional Remote control microphone)

The HM-192 allows you to remotely control the transceiver by using the microphone. Use either the optional OPC-607, OPC-608, OPC-609 or OPC-726 SEPARATION CABLE.

The HM-192 is the same as the one supplied in the Remote control microphone type transceiver.

◇ Mounting

The optional OPC-607 (3 m), OPC-608 (8 m), OPC-609 (1.9 m) or OPC-726 (5 m) SEPARATION CABLE is required to install the transceiver's Main unit and Remote control microphone.

- ① Unscrew the 4 rear plate screws, then remove the rear plates from both the Extension MIC connector and the Main unit attachment.

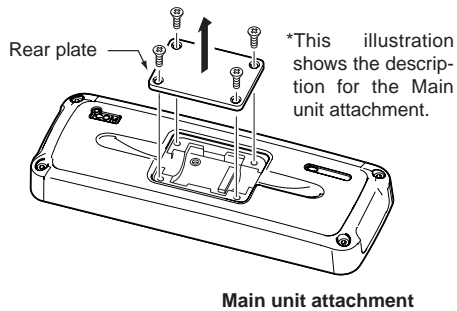

- ② Connect either the OPC-607, OPC-608, OPC-609 or OPC-726 separation cable to the Main unit attachment, as shown below.

After the connecting the cable, replace the rear plate and the 4 screws.

- The separation cable can be inserted into either the left or right grooves on the back of the attachment.

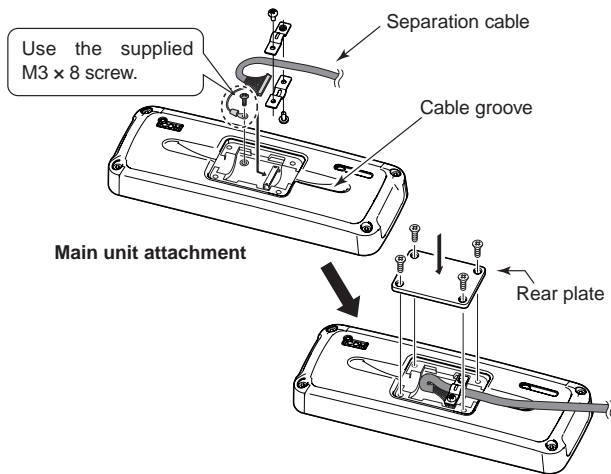

- ③ Connect the other side of the Separation cable to the Extension MIC connector, as described in step ②. After the cable is connected, replace the rear plate and the 4 screws.

- ④ Attach the Extension MIC connector to the desired place, then tighten the 2 supplied screws (M4 x 20).

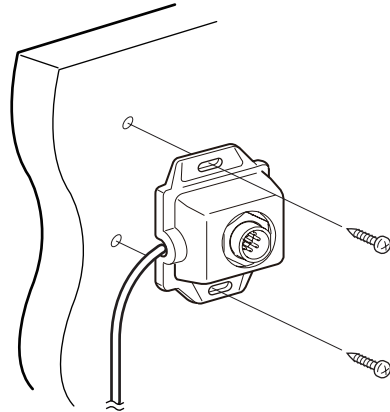

- ⑤ Attach the holder base to the desired place near the Extension MIC connector, then tighten the 2 supplied screws (M4 x 20).

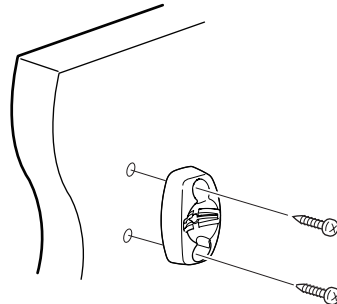

- ⑥ Adjust the MIC holder angle, then tighten the one supplied M4 x 14 screw.

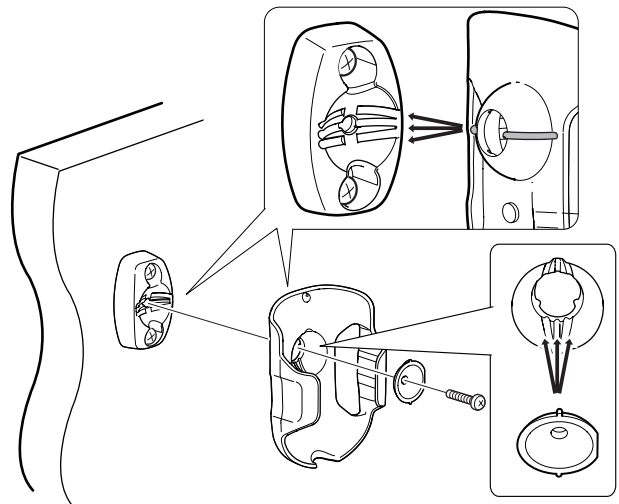

- ⑦ Connect the HM-192 to the Extension MIC connector.

■ Mounting

◇ Mounting location

Select a location which can support the weight of the transceiver and does not interfere with driving.

NEVER place the main unit or remote controller where normal operation of the vehicle may be hindered or where it could cause bodily injury.

NEVER place the main unit or remote controller where air bag deployment may be obstructed.

DO NOT place the main unit or remote controller where hot or cold air blows directly onto it.

DO NOT place the main unit or remote controller in direct sunlight.

◇ Mounting the controller or speaker

Check the installation angle; the display may not be easy to read at some angles.

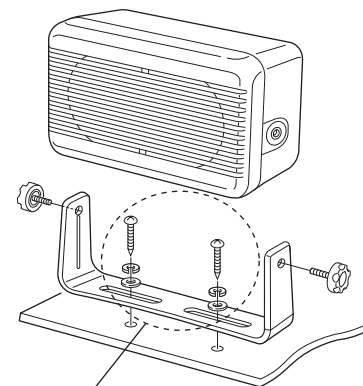
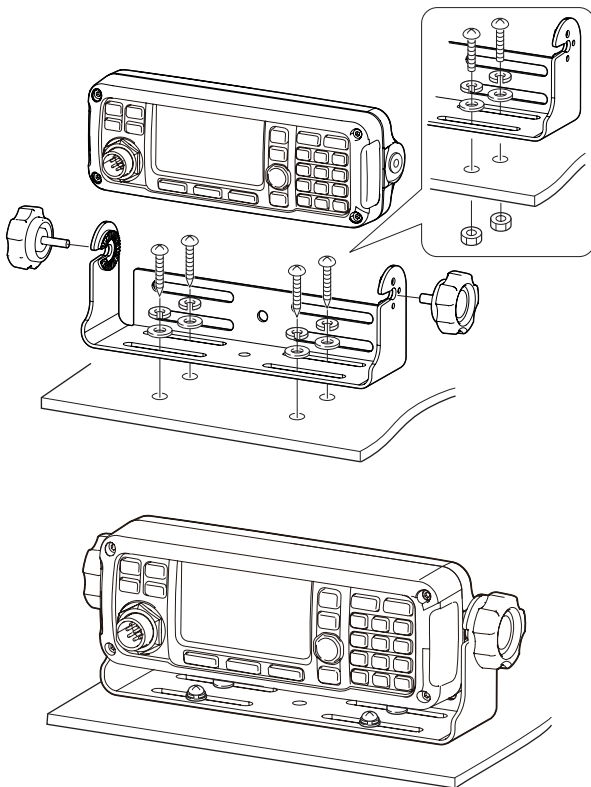

These screws are shown as mounting examples only.

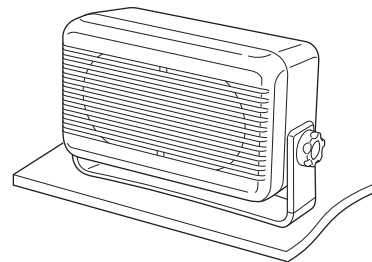

◇ **Mounting the transceiver**

A supplied mounting bracket is used to mount the transceiver or transceiver's Main unit to a flat surface.

- ① Attach the mounting plates, and tighten the 2 supplied M5 × 8 screws on each side.

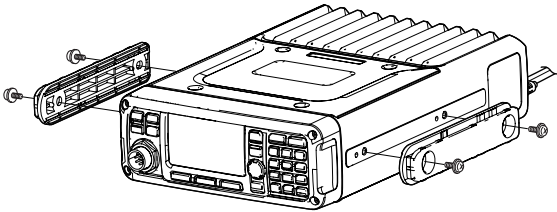

- ② Put the mounting bracket on the board, and then tighten the 4 supplied screws (M5 × 20).

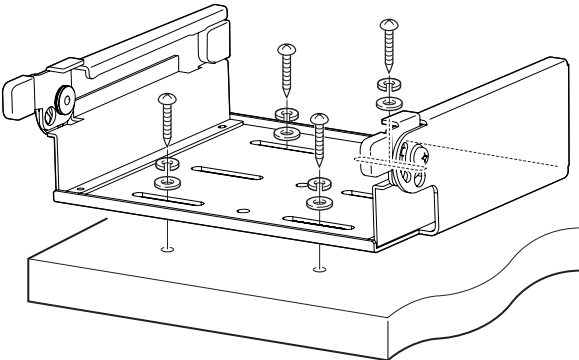

- ③ Attach the Main unit to the mounting bracket, as shown below.

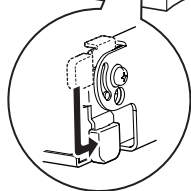
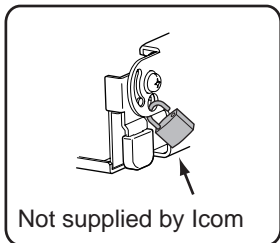
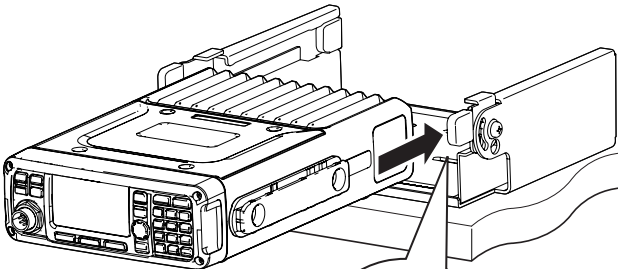

- ④ The completed mounting should look like this.

• **Mounting on the board**

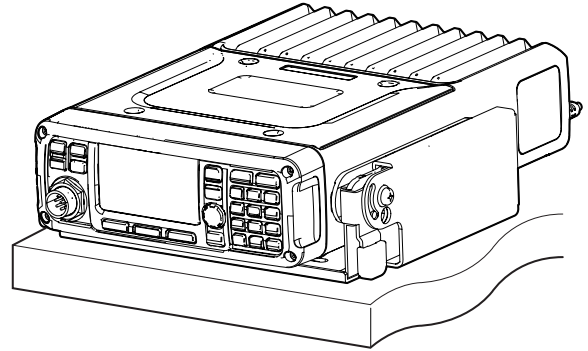

⚠ **WARNING!** Mount the mounting bracket with 4 supplied screws to surface that is more than 40 mm thick and can support more than 10 kg. The unit must be mounted on only a flat hard surface.

■ Fuse replacement

If a fuse blows, or the transceiver stops functioning, find the source of the problem, and repair it. Then replace the damaged fuse with a new, adequately rated fuse.

⚠ WARNING! Turn OFF the power and disconnect the DC power cable from the transceiver before performing any work on the transceiver. Otherwise, there is a danger of electric shock, equipment damage and/or fire or injury.

The IC-F8100 has two fuse types installed for transceiver protection.

- DC power cable ATC 30 A
- Circuitry fuse ATC 5 A

◇ DC power cable fuse replacement

Refer the figure described below for the DC power cable fuse replacement.

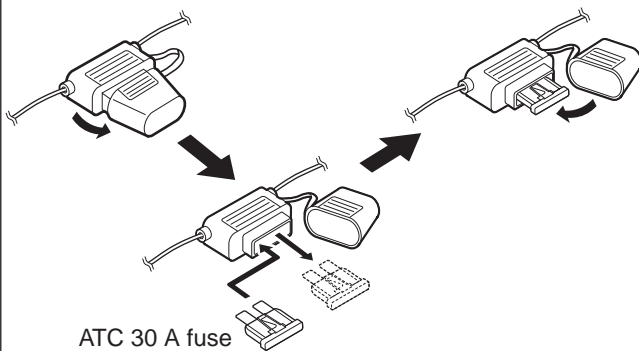

6

◇ Internal fuse replacement

- ① Turn the transceiver upside down.
- ② Unscrew 4 screws from the bottom cover, then lift up the cover.

- ③ Replace the circuitry fuse as shown in the diagram below.
 - Use the supplied ATC 5 A fuse.

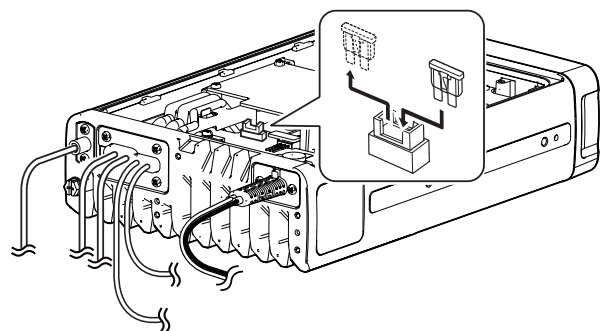
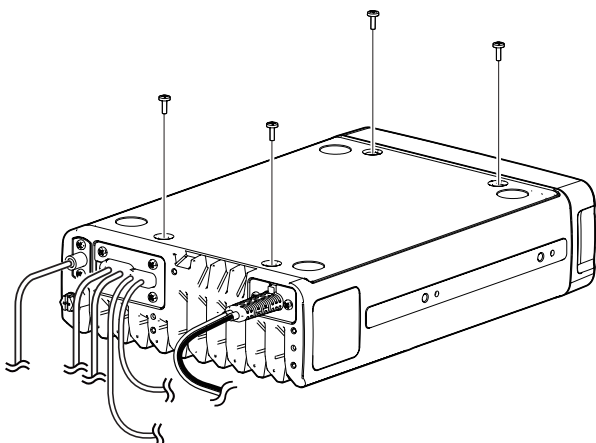

- ④ Reattach the bottom cover in its original position.

■ Connector information for AD-119

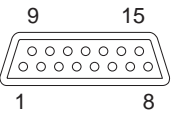
GPIO	Pin	Pin name	Description	Specification
	1	13.8V	13.8 V output for Antenna tuner.	
	2	SCAN	Outputs Antenna tuner control signal.	
	3	KEY	Key signal input.	-0.5 to 0.8 V while tuning
	4	RL1	Goes to ground when transmitting.	
	5	TUM4	Stepping motor control signal output for AT230.	
	6	TUM3	Stepping motor control signal output for AT230.	
	7	TUM2	Stepping motor control signal output for AT230.	
	8	TUM1	Stepping motor control signal output for AT230.	
	9	NC	No connection.	
	10	NC	No connection.	
	11	START	Start/bypass signal output.	
	12	CWKEY	CW and FSK keying input.	Input level : Less than 0.6 V for transmit
	13	ALC	ALC voltage input.	Control voltage : -4 to 0 V Input impedance : More than 10 kΩ
	14	GND	Connect to ground.	
	15	TUMB	Band control signal output for AT230.	

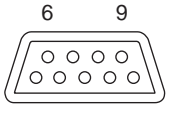
GPS	Pin	Pin name	Description
	1	3V	DC 3 V output (200 mA maximum).
	2	RXD	Input terminal for receive data.
	3	-	—
	4	NC	No connection.
	5	GND	Connect to ground.
	6	-	—
	7	-	—
	8	-	—
	9	ALCV	—

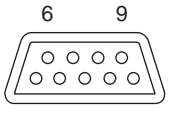
DATA	Pin	Pin name	Description
	1	NC	No connection.
	2	TXD	Outputs transmit data.
	3	RXD	Input terminal for receive data.
	4	DTR	Outputs data terminal ready signal.
	5	GND	Connect to ground.
	6	NC	No connection.
	7	CTS	Input terminal for clear-to-send data.
	8	RTS	Outputs request-to-send data.
	9	NC	No connection.

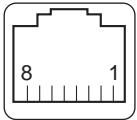
EXT. MODEM	Pin	Pin name	Description	Specification
	1	TXD	Output terminal for receive data.	RS-232C
	2	RXD	Input terminal for transmit data.	RS-232C
	3	GND	Connect to ground.	—
	4	PTT	PTT input terminal. When grounded, transmits.	0 V: transmit, 5 V: receive
	5	AF GND	Ground line for the AF signal.	
	6	AF OUT	Output terminal for the AF signal.	Output impedance: 1 kΩ Output level : 200 to 400 mVrms
	7	AF IN	Input terminal for the AF signal.	Input impedance : 1 kΩ Input level : 56 to 824 mVrms
	8	NC	No connection.	—

◇ General

- Frequency coverage : (Unit: MHz)
 - Receive 0.5–29.9999
 - Transmit 1.6–29.9999
- Type of emission :
 - AUS versions J3E (USB), A3E (AM) RX only
 - Other versions J3E (USB/LSB), A1A (CW), A3E (AM), F1B (FSK)
- No. of memory Ch. : 500 channels (maximum)
- Usable temp. range : –30°C to +60°C
- Frequency stability : ±0.3 ppm (–30°C to +60°C)
- Power supply : 13.8 V DC (negative ground)
 - AUS versions 10.8–15.6 V DC
 - Other versions 11.73–15.87 V DC
- Current drain :
 - Transmit Less than 28 A
(at maximum power)
 - Receive Less than 3.0 A
(at maximum audio)
- Dimensions : (projections are not included)
 - Main/Front package 62(W)×174(H)×259(D) mm
- Weight : (approximately)
 - Main/Front package 3.8 kg

◇ Transceiver

- Output power : (typical)
 - AUS versions
 - J3E HIGH 100 W p-p
 - MID 50 W p-p
 - LOW 10 W p-p
 - Other versions
 - J3E/A1A HIGH 125 W p-p
 - MID 50 W p-p
 - LOW 10 W p-p
 - A3E HIGH 30 W Carrier
 - MID 12.5 W Carrier
 - LOW 3 W Carrier
 - F1B HIGH 75 W p-p
 - MID 50 W p-p
 - LOW 10 W p-p
- Spurious emission : Less than –64 dB
below peak output power
- Carrier suppression : 50 dB
below peak output power
- Unwanted sideband suppression :
 - 400 Hz 55 dB
below peak output power
 - 1 kHz 65 dB
below peak output power

◇ Receiver

- Sensitivity :
 - J3E (Pre Amp ON)
 - (0.5–1.5999 MHz) 14 dBμV (10 dB S/N)
 - (1.6–29.9999 MHz) –14 dBμV (10 dB S/N)
 - A3E
 - (0.5–1.5999 MHz) 22 dBμV (10 dB S/N)
 - (1.6–29.9999 MHz) 6 dBμV (10 dB S/N)
- Spurious response rejection ratio:
 - More than 70 dB
- AF output power : (at 13.8 V DC)
 - More than 4.0 W at 10%
distortion with a 4 Ω load
- Clarifier range : ±200 Hz

All stated specifications are typical and subject to change without notice or obligation.

AT-140 AUTOMATIC ANTENNA TUNER



Antenna and control cable receptacles for easy installation and a tuner bypass function is available.

SP-10 EXTERNAL SPEAKER

SP-25 EXTERNAL SPEAKER

SP-30 EXTERNAL SPEAKER

The SP-25 is the same as that supplied with the IC-F8100. A mounting bracket is supplied with the speaker.

Maximum AF input/impedance: 6 W/4 Ω

HM-193 HAND MICROPHONE

The same as that supplied with the IC-F8100 One package type or Separated Type.

HM-192 REMOTE CONTROL MICROPHONE

The same as that supplied with the IC-F8100 Remote control microphone type. Allows you to remotely control the transceiver with the microphone. The HM-193 requires either the OPC-607, OPC-608, OPC-609 or OPC-726 separation cable.

RMK-6 SEPARATION KIT

The same as that supplied with the IC-F8100 Separated Type.

Allows you to install the transceiver front panel separate from the Main unit for operating convenience. The RMK-6 requires either the OPC-607, OPC-608, OPC-609 or OPC-726 separation cable.

OPC-607/OPC-608/OPC-609/OPC-726

SEPARATION CABLE

OPC-607 : 3 m

OPC-608 : 8 m

OPC-609 : 1.9 m

OPC-726 : 5 m

OPC-2142 SHIELDED CONTROL CABLE

The shielded control cable protects the transceiver from RF feedback and extends the separation between the AT-140 and the transceiver up to 10 meters.

OPC-2142: 4 pin

OPC-2143 SHIELDED CONTROL CABLE

The shielded control cable protects the transceiver from RF feedback and extends the separation between the AT230 and the transceiver up to 5 meters.

OPC-2205 SHIELDED CONTROL CABLE

The shielded control cable protects the transceiver from RF feedback and connects the AT-140 or a GPS receiver to the transceiver.

AD-119 JUNCTION BOX

Allows you to connect the AT-140, AT230, an external modem or PC to the transceiver.

MB-126 MOUNTING BRACKET

CFU-F8100 COOLING FAN

Recommended Automatic tuning antenna, AT230 from Moonraker Australia Pty. Limited

The AT230 is a 2.6 m length mobile whip antenna with an automatic tuning function. The antenna matches 2–30 MHz continuously. Use the optional OPC-2143 cable for use with the IC-F8100. Ask your dealer for details.

MEMO

Count on us!

