

ENGINEERING TEST REPORT

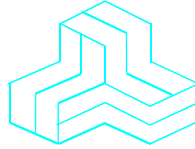

UHF FM Repeater
Model No.: IC-FR6000
FCC ID: AFJ306302

Applicant:

ICOM Incorporated
1-1-32, Kamiminami, Hirano-ku
Osaka
Japan, 547-0003

Tested in Accordance With

Federal Communications Commission (FCC)
47 CFR, Parts 2 and 90 (Subpart I)

UltraTech's File No.: ICOM-170F90

This Test report is Issued under the Authority of
Tri M. Luu, Professional Engineer,
Vice President of Engineering
UltraTech Group of Labs

Date: April 21, 2008



Report Prepared by: JaeWook Choi

Tested by: Wayne Wu, Hung Trinh

Issued Date: April 21, 2008

Test Dates: February 26 & 27, 2008, March 17, 18 & 20,
2008, April 1 & 6, 2008

- *The results in this Test Report apply only to the sample(s) tested, and the sample tested is randomly selected.*
- *This report must not be used by the client to claim product endorsement by NVLAP or any agency of the US Government.*

UltraTech

3000 Bristol Circle, Oakville, Ontario, Canada, L6H 6G4
Tel.: (905) 829-1570 Fax.: (905) 829-8050
Website: www.ultratech-labs.com, Email: vic@ultratech-labs.com, Email: tri@ultratech-labs.com



0685



31040/SIT



C-1376



46390-2049



200093-0



SL2-IN-E-1119R

TABLE OF CONTENTS

EXHIBIT 1.	SUBMITTAL CHECK LIST	1
EXHIBIT 2.	INTRODUCTION	2
2.1.	SCOPE.....	2
2.2.	RELATED SUBMITTAL(S)/GRANT(S).....	2
2.3.	NORMATIVE REFERENCES	2
EXHIBIT 3.	PERFORMANCE ASSESSMENT	3
3.1.	CLIENT INFORMATION	3
3.2.	EQUIPMENT UNDER TEST (EUT) INFORMATION.....	3
3.3.	EUT'S TECHNICAL SPECIFICATIONS	4
3.4.	LIST OF EUT'S PORTS	4
EXHIBIT 4.	EUT OPERATING CONDITIONS AND CONFIGURATIONS DURING TESTS	5
4.1.	CLIMATE TEST CONDITIONS	5
4.2.	OPERATIONAL TEST CONDITIONS & ARRANGEMENT FOR TEST SIGNALS	5
EXHIBIT 5.	SUMMARY OF TEST RESULTS	6
5.1.	LOCATION OF TESTS	6
5.2.	APPLICABILITY & SUMMARY OF EMISSION TEST RESULTS.....	6
5.3.	MODIFICATIONS INCORPORATED IN THE EUT FOR COMPLIANCE PURPOSES.....	6
5.4.	DEVIATION OF STANDARD TEST PROCEDURES	6
EXHIBIT 6.	MEASUREMENTS, EXAMINATIONS & TEST DATA FOR EMC EMISSIONS	7
6.1.	TEST PROCEDURES	7
6.2.	MEASUREMENT UNCERTAINTIES.....	7
6.3.	MEASUREMENT EQUIPMENT USED.....	7
6.4.	ESSENTIAL/PRIMARY FUNCTIONS AS DECLARED BY THE MANUFACTURER	7
6.5.	RF POWER OUTPUT [§§ 2.1046 & 90.205]	8
6.6.	FREQUENCY STABILITY [§§ 2.1055 & 90.213]	9
6.7.	AUDIO FREQUENCY RESPONSE [§ 2.1047(A)].....	11
6.8.	MODULATION LIMITING [§§ 2.1047(B) & 90.210].....	16
6.9.	OCCUPIED BANDWIDTH & EMISSION MASK [§§ 2.1049, 90.209 & 90.210].....	21
6.10.	TRANSMITTER ANTENNA POWER SPURIOUS/HARMONIC CONDUCTED EMISSIONS [§ 90.210].....	74
6.11.	TRANSMITTER SPURIOUS/HARMONIC RADIATED EMISSIONS [§ 90.210].....	96
6.12.	TRANSIENT FREQUENCY BEHAVIOR [§ 90.214]	100
EXHIBIT 7.	TEST EQUIPMENTS LIST	108
EXHIBIT 8.	MEASUREMENT UNCERTAINTY	110
8.1.	RADIATED EMISSION MEASUREMENT UNCERTAINTY	110
EXHIBIT 9.	MEASUREMENT METHODS	111
9.1.	CONDUCTED POWER MEASUREMENTS.....	111
9.2.	RADIATED POWER MEASUREMENTS (ERP & EIRP) USING SUBSTITUTION METHOD	112
9.3.	FREQUENCY STABILITY	115
9.4.	EMISSION MASK.....	116
9.5.	SPURIOUS EMISSIONS (CONDUCTED)	116
9.6.	TRANSIENT FREQUENCY BEHAVIOR	117

EXHIBIT 1. SUBMITTAL CHECK LIST

Annex No.	Exhibit Type	Description of Contents	Quality Check (OK)
--	Test Report	<ul style="list-style-type: none"> ▪ Exhibit 1: Submittal check lists ▪ Exhibit 2: Introduction ▪ Exhibit 3: Performance Assessment ▪ Exhibit 4: EUT Operation and Configuration during Tests ▪ Exhibit 5: Summary of test Results ▪ Exhibit 6: Measurement Data ▪ Exhibit 7: Measurement Uncertainty ▪ Exhibit 8: Measurement Methods 	OK
1	Test Setup Photos	Radiated Emissions Test Setup Photos	OK
2	External Photos of EUT	External EUT Photos	OK
3	Internal Photos of EUT	Internal EUT Photos	OK
4	Cover Letters	Cover Letter	OK
5	Attestation Statements	<ul style="list-style-type: none"> ▪ Letter from the Applicant to Appoint Ultratech to Act as an Agent ▪ Letter from the Applicant to Request for Confidentiality Filing ▪ Applicant Part 90 Attestation 	OK
6	ID Label/Location Info	<ul style="list-style-type: none"> ▪ ID Label ▪ Location of ID Label 	OK
7	Block Diagrams	Block Diagram	OK
8	Schematic Diagrams	Schematics	OK
9	Parts List/Tune Up Info	<ul style="list-style-type: none"> ▪ Parts List ▪ Adjustment for IC-FR6000 	OK
10	Operational Description	Circuit Description	OK
11	RF Exposure Info	N/A	OK
12	Users Manual	Instruction Manual	OK

EXHIBIT 2. INTRODUCTION

2.1. SCOPE

Reference:	FCC Parts 2 and 90
Title:	Code of Federal Regulations (CFR), Title 47 Telecommunication – Parts 2 & 90
Purpose of Test:	To obtain FCC Certification Authorization for Radio operating in the Frequency Band 450-512 MHz (25 KHz, 12.5 KHz and 6.25 KHz Channel Spacing).
Test Procedures:	Both conducted and radiated emissions measurements were conducted in accordance with TIA/EIA Standard TIA/EIA-603 (01-Nov-2002) – Land Mobile FM or PM Communications Equipment Measurement and performance Standards.

2.2. RELATED SUBMITTAL(S)/GRANT(S)

None.

2.3. NORMATIVE REFERENCES

Publication	Year	Title
FCC CFR Parts 0-19, 80-End	2007	Code of Federal Regulations – Telecommunication
ANSI C63.4	2003	American National Standard for Methods of Measurement of Radio-Noise Emissions from Low-Voltage Electrical and Electronic Equipment in the Range of 9 kHz to 40 GHz
CISPR 16-1-1	2004	Specification for Radio Disturbance and Immunity measuring apparatus and methods
TIA/EIA 603, Edition C	2004	Land Mobile FM or PM Communications Equipment Measurement and Performance Standards

EXHIBIT 3. PERFORMANCE ASSESSMENT

3.1. CLIENT INFORMATION

APPLICANT	
Name:	Icom Incorporated
Address:	1-1-32, Kamiminami, Hirano-ku, Osaka Japan, 547-0003
Contact Person:	Mr. Yoshiteru Yano Phone #: +81-66-793-5302 Fax #: +81-66-793-0013 Email Address: export@icom.co.jp

MANUFACTURER	
Name:	Icom Incorporated
Address:	1-1-32, Kamiminami, Hirano-ku, Osaka Japan, 547-0003
Contact Person:	Mr. Yoshiteru Yano Phone #: +81-66-793-5302 Fax #: +81-66-793-0013 Email Address: export@icom.co.jp

3.2. EQUIPMENT UNDER TEST (EUT) INFORMATION

The following information (with the exception of the Date of Receipt) has been supplied by the applicant.

Brand Name:	ICOM Incorporated
Product Name:	UHF FM Repeater
Model Name or Number:	IC-FR6000
Serial Number:	1100001
Type of Equipment:	Licensed Non-Broadcast UHF FM Repeater
Power Supply Requirement:	13.6 VDC nominal
Transmitting/Receiving Antenna Type:	Non-integral
Primary User Functions of EUT:	UHF FM Repeater

ULTRATECH GROUP OF LABS

3000 Bristol Circle, Oakville, Ontario, Canada L6H 6G4
Tel. #: 905-829-1570, Fax. #: 905-829-8050, Email: vic@ultratech-labs.com, Website: <http://www.ultratech-labs.com>

File #: ICOM-170F90
April 21, 2008

All test results contained in this engineering test report are traceable to National Institute of Standards and Technology (NIST)

3.3. EUT'S TECHNICAL SPECIFICATIONS

TRANSMITTER	
Equipment Type:	Fixed, Base Station
Intended Operating Environment:	Commercial, Industrial or Business
Power Supply Requirement:	13.6 VDC nominal
RF Output Power Rating:	5 to 50 Watts (Continuously variable)
Operating Frequency Range:	450-520 MHz
RF Output Impedance:	50 Ohms
Channel Spacing:	25 KHz, 12.5 KHz, 6.25 KHz
Occupied Bandwidth (99%):	<ul style="list-style-type: none"> • 13.16 KHz (for 25 KHz Channel Spacing) • 10.46 KHz (for 12.5 KHz Channel Spacing) • 3.84 KHz (for 6.25 KHz Channel Spacing)
Emission Designation*:	16K0F3E, 11K0F3E, 11K0F7E, 11K0F7D, 11K0F7W, 8K10F1E, 8K10F1D, 4K00F1E, 4K00F1D, 4K00F3E
Antenna Connector Type:	N

* For an average case of commercial telephony, the Necessary Bandwidth is calculated as follows:

For FM Voice Modulation:

Channel Spacing = 25 KHz, D = 5 KHz max, K = 1, M = 3 KHz

$$B_n = 2M + 2DK = 2(3) + 2(5)(1) = \mathbf{16\ KHz}$$

Emission designation: 16K0F3E

Channel Spacing = 12.5 KHz, D = 2.5 KHz max, K = 1, M = 3 KHz

$$B_n = 2M + 2DK = 2(3) + 2(2.5)(1) = \mathbf{11\ KHz}$$

Emission designation: 11K0F3E

3.4. LIST OF EUT'S PORTS

Port Number	EUT's Port Description	Number of Identical Ports	Connector Type	Shielded/Non-shielded
1	External Speaker Connector	1	Audio Jack	Shielded
2	Rx Antenna Connector	1	N-Type	Terminated to 50 Ω load
3	Accessory Connector	1	DB-25	Shielded
4	DC Power Receptacle	1	Mate-N-Lock 4 Position	Non-shielded
5	Tx Antenna Connector	1	N-Type	Terminated to 50 Ω load
6	Microphone Connector	1	RJ-45	Non-shielded

EXHIBIT 4. EUT OPERATING CONDITIONS AND CONFIGURATIONS DURING TESTS

4.1. CLIMATE TEST CONDITIONS

The climate conditions of the test environment are as follows:

Temperature:	21°C
Humidity:	51%
Pressure:	102 kPa
Power Input Source:	13.6 VDC Nominal

4.2. OPERATIONAL TEST CONDITIONS & ARRANGEMENT FOR TEST SIGNALS

Operating Modes:	The transmitter was operated in a continuous transmission mode with the carrier modulated as specified in the Test Data.
Special Test Software:	N/A
Special Hardware Used:	N/A
Transmitter Test Antenna:	The EUT is tested with the antenna port terminated to a 50 Ohms RF Load.

Transmitter Test Signals	
Frequency Band(s):	450-512 MHz
Test Frequencies: (Near lowest, near middle & near highest frequencies in the frequency range of operation.)	450.1 MHz, 481.1 MHz, 511.9 MHz
Transmitter Wanted Output Test Signals:	
Transmitter Power (measured maximum output power):	50 Watts High and 5 Watts Low
Normal Test Modulation:	FM Voice
Modulating signal source:	External

EXHIBIT 5. SUMMARY OF TEST RESULTS

5.1. LOCATION OF TESTS

All of the measurements described in this report were performed at Ultratech Group of Labs located in the city of Oakville, Province of Ontario, Canada.

Radiated Emissions were performed at the Ultratech's 3-10 TDK Semi-Anechoic Chamber situated in the Town of Oakville, province of Ontario. This test site been calibrated in accordance with ANSI C63.4, and found to be in compliance with the requirements of Sec. 2.948 of the FCC Rules. The descriptions and site measurement data of the Oakville 3-10 TDK Semi-Anechoic Chamber has been filed with FCC office (FCC File No.: 31040/SIT 1300B3) and Industry Canada office (Industry Canada File No.: IC2049A-3). Last Date of Site Calibration: May 17, 2007.

5.2. APPLICABILITY & SUMMARY OF EMISSION TEST RESULTS

FCC Section(s)	Test Requirements	Applicability (Yes/No)
90.205 & 2.1046	RF Power Output	Yes
90.213 & 2.1055	Frequency Stability	Yes
90.242(b)(8) & 2.1047(a)	Audio Frequency Response	Not applicable to new standard. However, tests are conducted under FCC's recommendation.
90.210 & 2.1047(b)	Modulation Limiting	Yes
90.210 & 2.1049	Emission Limitation & Emission Mask	Yes
90.210, 2.1057 & 2.1051	Emission Limits - Spurious Emissions at Antenna Terminal	Yes
90.210, 2.1057 & 2.1053	Emission Limits - Field Strength of Spurious Emissions	Yes
90.214	Transient Frequency Behavior	Yes
1.1307, 1.1310, 2.1091 & 2.1093	RF Exposure Limit	Not applicable for fixed, base station
<p>Portable UHF FM REPEATER, Model No.: IC-FR6000, by ICOM Incorporated has also been tested and found to comply with FCC Part 15, Subpart B - Radio Receivers and Class B Digital Devices. The engineering test report has been documented and kept on file and it is available upon request.</p>		

5.3. MODIFICATIONS INCORPORATED IN THE EUT FOR COMPLIANCE PURPOSES

None.

5.4. DEVIATION OF STANDARD TEST PROCEDURES

None.

ULTRATECH GROUP OF LABS

3000 Bristol Circle, Oakville, Ontario, Canada L6H 6G4
 Tel. #: 905-829-1570, Fax. #: 905-829-8050, Email: vic@ultratech-labs.com, Website: <http://www.ultratech-labs.com>

File #: ICOM-170F90
 April 21, 2008

All test results contained in this engineering test report are traceable to National Institute of Standards and Technology (NIST)

EXHIBIT 6. MEASUREMENTS, EXAMINATIONS & TEST DATA FOR EMC EMISSIONS

6.1. TEST PROCEDURES

This section contains test results only. Details of test methods and procedures can be found in Exhibit 8 of this report

6.2. MEASUREMENT UNCERTAINTIES

The measurement uncertainties stated were calculated in accordance with requirements of UKAS Document NIS 85 With a confidence level of 95%. Please refer to Exhibit 7 for Measurement Uncertainties.

6.3. MEASUREMENT EQUIPMENT USED

The measurement equipment used complied with the requirements of the Standards referenced in the Methods & Procedures ANSI C63.4 and CISPR 16-1-1.

6.4. ESSENTIAL/PRIMARY FUNCTIONS AS DECLARED BY THE MANUFACTURER

The essential function of the EUT is to communicate to and from radios over RF link.

6.5. RF POWER OUTPUT [§§ 2.1046 & 90.205]

6.5.1. Limits

Please refer to FCC 47 CFR 90.205 for specification details.

6.5.2. Method of Measurements

Refer to Section 9.1 (Conducted) and 9.2 (Radiated) of this report for measurement details

6.5.3. Test Arrangement

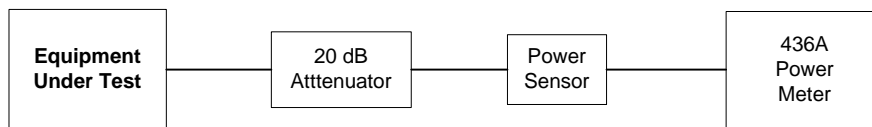

6.5.4. Test Data

Fundamental Frequency (MHz)	Measured (Average) Power (W)	Power Rating (W)
High Power Level, 50 Watts		
450.1	48.75	50
481.1	47.21	50
511.9	46.99	50
Low Power Level, 5 Watts		
450.1	4.92	5
481.1	4.95	5
511.9	4.90	5

6.6. FREQUENCY STABILITY [§§ 2.1055 & 90.213]

6.6.1. Limits

§§ 90.213 Transmitters used must have a minimum frequency stability as specified in the following table.

Frequency Range (MHz)	Channel Bandwidth (KHz)	Frequency Tolerance (ppm)		
		Fixed and Base Stations	Mobile Stations	
			> 2 W	≤ 2 W
150-174 MHz	6.25	1.0	2.0	2.0
	12.5	2.5	5.0	5.0
	25	5.0	5.0	50.0*
421-512 MHz	6.25	0.5	1.0	1.0
	12.5	1.5	2.5	2.5
	25	2.5	5.0	5.0

- Stations operating in the 154.45 to 154.49 MHz or the 173.2 to 173.4 MHz bands must have a frequency stability of 5 ppm.
- Paging transmitters operating on paging-only frequencies must operate with frequency stability of 5 ppm in the 150-174 MHz band and 2.5 ppm in the 421-512 MHz band.

6.6.2. Method of Measurements

Refer to Section 9.3 of this report for measurement details

6.6.3. Test Arrangement

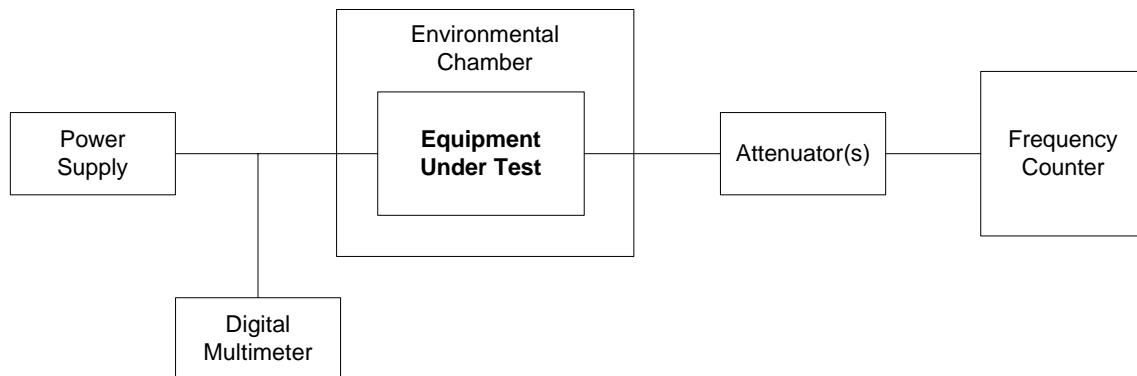

6.6.4. Test Data

Product Name: Model No.:	UHF FM Repeater IC-FR6000
Center Frequency:	450.1MHz
Full Power Level:	46.88 dBm
Frequency Tolerance Limit:	± 0.5 ppm or ± 225.05 Hz (Manufacturer's spec)
Max. Frequency Tolerance Measured:	-89 Hz or -0.20 ppm
Input Voltage Rating:	13.6 VDC (nominal)

Ambient Temperature (°C)	CENTER FREQUENCY & RF POWER OUTPUT VARIATION		
	Supply Voltage (Nominal) 13.6 Vdc	Supply Voltage (Battery End Point) 11.56 Vdc	Supply Voltage (Battery Fully Charged) 15.64 Vdc
	Hz	Hz	Hz
-30	-87	N/A	N/A
-20	-89	N/A	N/A
-10	-72	N/A	N/A
0	-36	N/A	N/A
+10	-22	N/A	N/A
+20	-20	-17	57
+30	63	N/A	N/A
+40	69	N/A	N/A
+50	63	N/A	N/A
+60	61	N/A	N/A

6.7. AUDIO FREQUENCY RESPONSE [§ 2.1047(a)]

6.7.1. Limits

Recommended audio filter attenuation characteristics are given below:

RF Band	Audio band	Minimum Attenuation Rel. to 1 KHz Attenuation
450-512 MHz	3 – 20 KHz 20 – 30 KHz	$60 \log_{10}(f/3)$ dB where f is in KHz 50dB

6.7.2. Method of Measurements

The rated audio input signal was applied to the input of the audio low-pass filter (or of all modulation stages) using an audio oscillator, this input signal level and its corresponding output signal were then measured and recorded using the FFT Digital Spectrum Analyzer. Tests were repeated at different audio signal frequencies from 0 to 50 KHz.

6.7.3. Test Arrangement

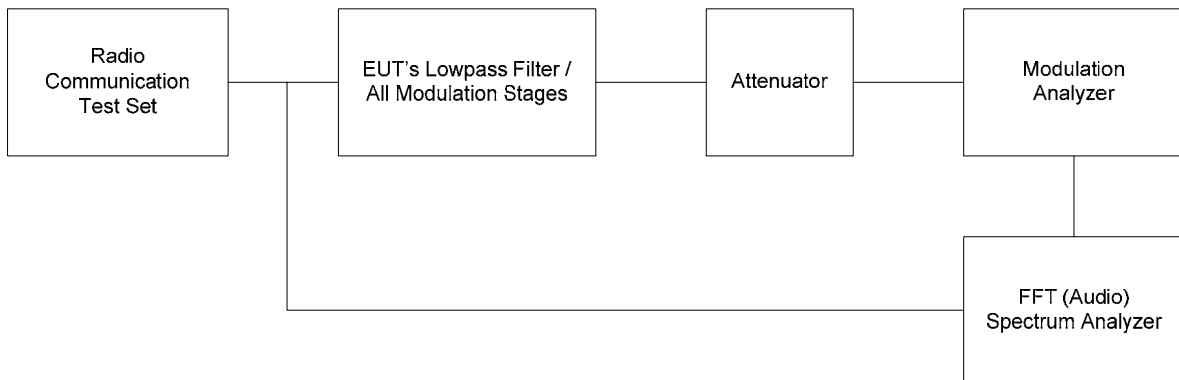

6.7.4. Test Data

6.7.4.1. 12.5 KHz Channel Spacing, F3E, Frequency of All Modulation States*

Note: Due to the difficulty of measuring the Frequency Response of the internal low-pass filter, the Frequency Response of All Modulation States are performed to show the roll-off at 3 KHz in comparison with the recommended audio filter attenuation.

Frequency (KHz)	Audio In (dBV)	Audio Out (dBV)	Attenuation (Out - In) (dB)	Attenuation Rel. KHz (dB)	Recommended Attenuation (dB)
0.1	-47.54	-35.74	11.8	-33.7	--
0.2	-47.54	-22.58	25.0	-20.6	--
0.4	-47.54	-12.94	34.6	-10.9	--
0.6	-47.54	-8.17	39.4	-6.2	--
0.8	-47.54	-5.11	42.4	-3.1	--
1.0	-47.54	-2.97	44.6	-1.0	--
1.5	-47.54	-0.33	47.2	1.7	--
2.0	-47.54	-0.62	46.9	1.4	--
2.5	-47.54	-1.49	46.1	0.5	--
3.0	-47.54	-2.01	45.5	0.0	0
3.5	-47.54	-58.12	-10.6	-56.1	-4
4.0	-47.54	-70.00	-22.5	-68.0	-7
4.5	-47.54	-70.00	-22.5	-68.0	-11
5.0	-47.54	-70.00	-22.5	-68.0	-13
6.0	-47.54	-70.00	-22.5	-68.0	-18
7.0	-47.54	-70.00	-22.5	-68.0	-22
8.0	-47.54	-70.00	-22.5	-68.0	-26
9.0	-47.54	-70.00	-22.5	-68.0	-29
10.0	-47.54	-70.00	-22.5	-68.0	-31
12.0	-47.54	-70.00	-22.5	-68.0	-36
14.0	-47.54	-70.00	-22.5	-68.0	-40
16.0	-47.54	-70.00	-22.5	-68.0	-44
18.0	-47.54	-70.00	-22.5	-68.0	-47
20.0	-47.54	-70.00	-22.5	-68.0	-49
22.0	-47.54	-70.00	-22.5	-68.0	-50
25.0	-47.54	-70.00	-22.5	-68.0	-50
30.0	-47.54	-70.00	-22.5	-68.0	-50
35.0	-47.54	-70.00	-22.5	-68.0	-50
40.0	-47.54	-70.00	-22.5	-68.0	-50
45.0	-47.54	-70.00	-22.5	-68.0	-50
50.0	-47.54	-70.00	-22.5	-68.0	-50

ULTRATECH GROUP OF LABS

3000 Bristol Circle, Oakville, Ontario, Canada L6H 6G4
 Tel. #: 905-829-1570, Fax. #: 905-829-8050, Email: vic@ultratech-labs.com, Website: <http://www.ultratech-labs.com>

File #: ICOM-170F90
 April 21, 2008

All test results contained in this engineering test report are traceable to National Institute of Standards and Technology (NIST)

Audio Frequency Response
12.5 kHz Channel Spacing

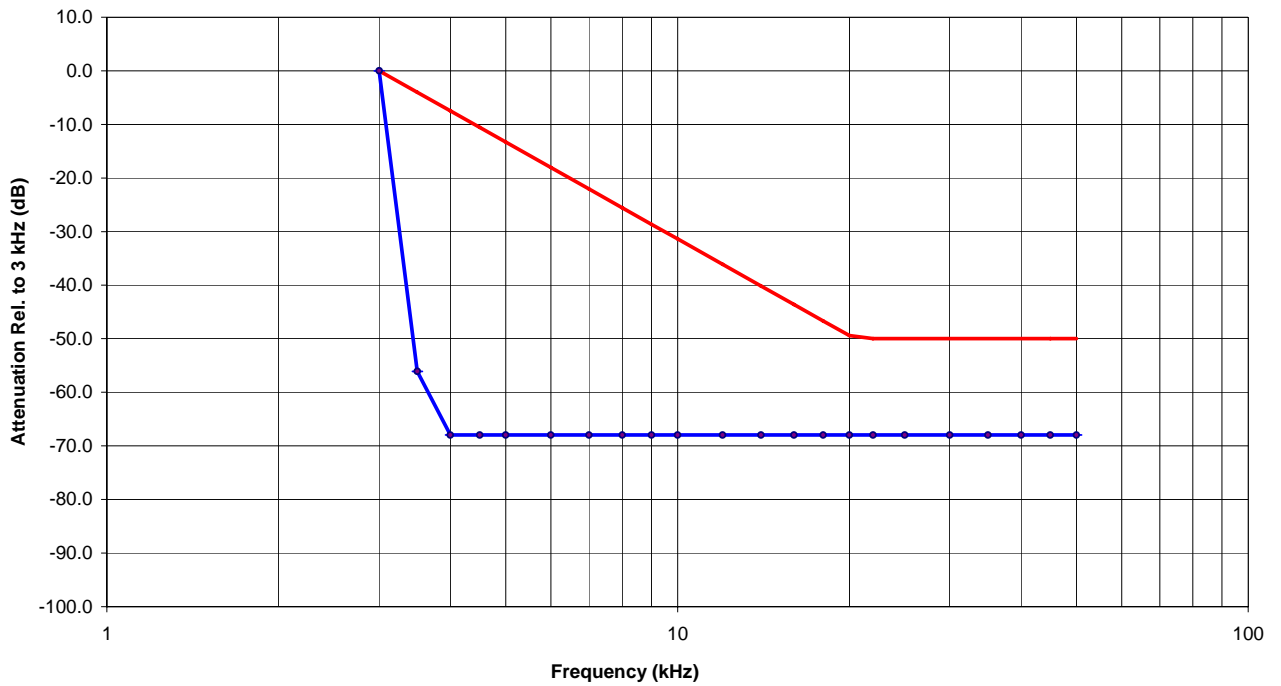

ULTRATECH GROUP OF LABS

3000 Bristol Circle, Oakville, Ontario, Canada L6H 6G4
Tel. #: 905-829-1570, Fax. #: 905-829-8050, Email: vic@ultratech-labs.com, Website: <http://www.ultratech-labs.com>

File #: ICOM-170F90
April 21, 2008

All test results contained in this engineering test report are traceable to National Institute of Standards and Technology (NIST)

6.7.4.2. 25 KHz Channel Spacing, F3E, Frequency of All Modulation States*

Note: Due to the difficulty of measuring the Frequency Response of the internal low-pass filter, the Frequency Response of All Modulation States are performed to show the roll-off at 3 KHz in comparison with the recommended audio filter attenuation.

Frequency (KHz)	Audio In (dBV)	Audio Out (dBV)	Attenuation (Out - In) (dB)	Attenuation Rel. KHz (dB)	Recommended Attenuation (dB)
0.1	-47.13	-29.50	17.6	-35.3	--
0.2	-47.13	-16.90	30.2	-22.7	--
0.4	-47.13	-7.12	40.0	-13.0	--
0.6	-47.13	-2.25	44.9	-8.1	--
0.8	-47.13	0.90	48.0	-4.9	--
1.0	-47.13	3.19	50.3	-2.7	--
1.5	-47.13	5.95	53.1	0.1	--
2.0	-47.13	6.02	53.2	0.2	--
2.5	-47.13	5.77	52.9	-0.1	--
3.0	-47.13	5.84	53.0	0.0	0
3.5	-47.13	-50.07	-2.9	-55.9	-4
4.0	-47.13	-70.00	-22.9	-75.8	-7
4.5	-47.13	-70.00	-22.9	-75.8	-11
5.0	-47.13	-70.00	-22.9	-75.8	-13
6.0	-47.13	-70.00	-22.9	-75.8	-18
7.0	-47.13	-70.00	-22.9	-75.8	-22
8.0	-47.13	-70.00	-22.9	-75.8	-26
9.0	-47.13	-70.00	-22.9	-75.8	-29
10.0	-47.13	-70.00	-22.9	-75.8	-31
12.0	-47.13	-70.00	-22.9	-75.8	-36
14.0	-47.13	-70.00	-22.9	-75.8	-40
16.0	-47.13	-70.00	-22.9	-75.8	-44
18.0	-47.13	-70.00	-22.9	-75.8	-47
20.0	-47.13	-70.00	-22.9	-75.8	-49
22.0	-47.13	-70.00	-22.9	-75.8	-50
25.0	-47.13	-70.00	-22.9	-75.8	-50
30.0	-47.13	-70.00	-22.9	-75.8	-50
35.0	-47.13	-70.00	-22.9	-75.8	-50
40.0	-47.13	-70.00	-22.9	-75.8	-50
45.0	-47.13	-70.00	-22.9	-75.8	-50
50.0	-47.13	-70.00	-22.9	-75.8	-50

Audio Frequency Response
25 kHz Channel Spacing

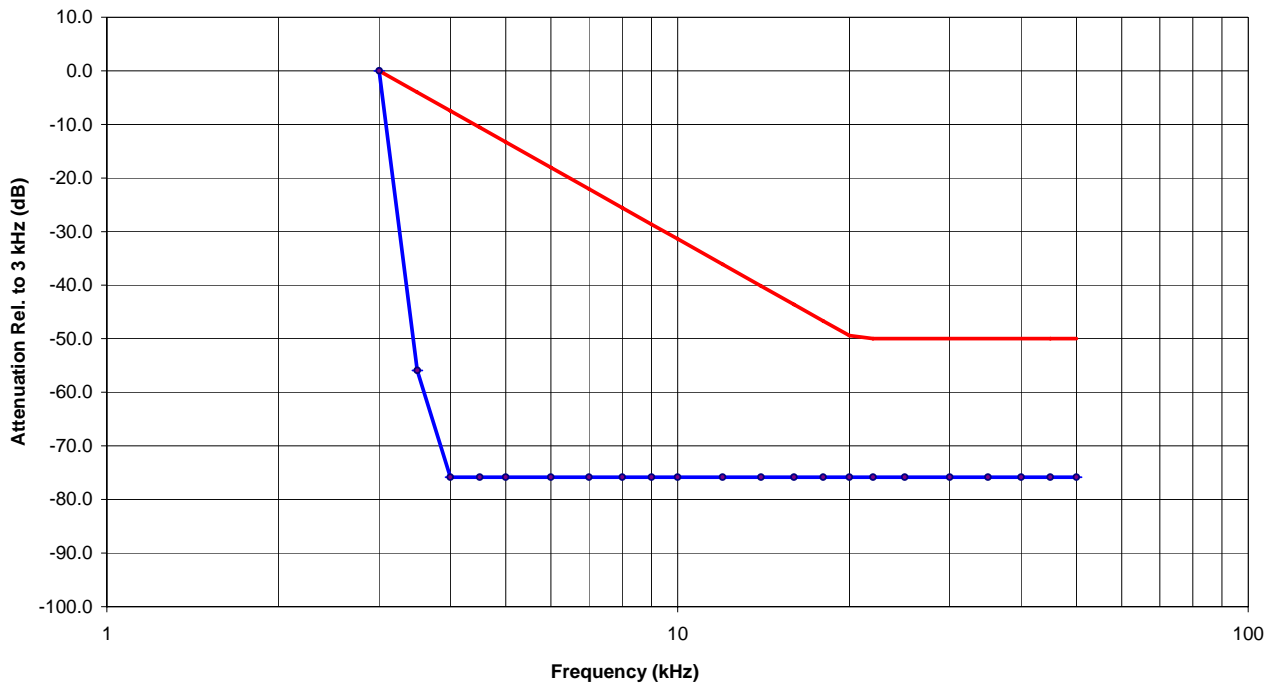

ULTRATECH GROUP OF LABS

3000 Bristol Circle, Oakville, Ontario, Canada L6H 6G4
Tel. #: 905-829-1570, Fax. #: 905-829-8050, Email: vic@ultratech-labs.com, Website: <http://www.ultratech-labs.com>

File #: ICOM-170F90
April 21, 2008

All test results contained in this engineering test report are traceable to National Institute of Standards and Technology (NIST)

6.8. MODULATION LIMITING [§§ 2.1047(b) & 90.210]

6.8.1. Limits

Recommended frequency deviation characteristics are given below:

- 2.5 KHz for 12.5 KHz Channel Spacing System
- 5 KHz for 25 KHz Channel Spacing System

6.8.2. Method of Measurements

For Audio Transmitter: The carrier frequency deviation was measured with the tone input signal level varied from 0 Vp to audio input rating level plus 16 dB at frequencies 0.1, 0.5, 1.0, 3.0 and 5.0 KHz. The maximum deviation was recorded at each test condition.

For Data Transmitter with Maximum Frequency Deviation set by Factory: The EUT was set at maximum frequency deviation, and its peak frequency deviation was then measured using EUT's internal random data source.

6.8.3. Test Arrangement

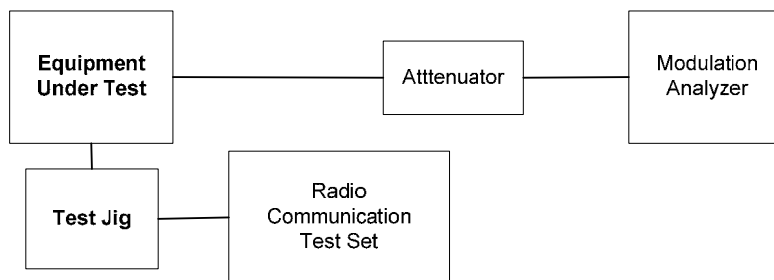

6.8.4. Test Data

6.8.4.1. Voice Modulation Limiting for 12.5 KHz Channel Spacing Operation

MODULATING SIGNAL LEVEL (mVrms)	PEAK FREQUENCY DEVIATION (KHz) at the following modulating frequency:					MAXIMUM LIMIT (KHz)
	0.1 KHz	0.5 KHz	1.0 KHz	3.0 KHz	5.0 KHz	
2	0.09	0.36	0.75	1.26	0.08	2.5
4	0.11	0.66	1.44	1.66	0.08	2.5
6	0.12	0.97	1.96	1.67	0.08	2.5
8	0.14	1.29	2.02	1.67	0.08	2.5
10	0.16	1.56	2.02	1.67	0.08	2.5
15	0.19	1.93	2.03	1.67	0.08	2.5
20	0.25	1.96	2.03	1.67	0.08	2.5
25	0.29	1.96	2.03	1.67	0.08	2.5
30	0.34	1.96	2.03	1.67	0.08	2.5
35	0.39	1.96	2.03	1.67	0.08	2.5
40	0.44	1.96	2.03	1.67	0.08	2.5
45	0.47	1.98	2.03	1.67	0.13	2.5
50	0.54	1.98	2.03	1.67	0.13	2.5
60	0.65	1.98	2.03	1.67	0.13	2.5
70	0.74	2.01	2.03	1.67	0.28	2.5
80	0.85	2.01	2.03	1.67	0.43	2.5
90	0.93	2.01	2.00	1.67	0.47	2.5
100	1.07	2.01	1.99	1.67	0.49	2.5
150	1.65	2.01	1.99	1.67	0.44	2.5
200	2.01	2.01	1.98	1.67	0.36	2.5
250	2.01	2.01	1.98	1.67	0.33	2.5

Voice Signal Input Level = STD MOD Level + 16 dB
= 12.46 dB(mVrms) + 16 dB
= 28.46 dB(mVrms)
= 26.50 mVrms

Modulation Frequency (KHz)	Peak Deviation (KHz)	Maximum Limit (KHz)
0.1	0.33	2.5
0.2	1.12	2.5
0.4	1.95	2.5
0.6	2.02	2.5
0.8	2.10	2.5
1.0	2.03	2.5
1.2	2.06	2.5
1.4	2.12	2.5
1.6	2.17	2.5
1.8	2.17	2.5
2.0	2.17	2.5
2.5	2.16	2.5
3.0	1.68	2.5
3.5	0.09	2.5
4.0	0.08	2.5
4.5	0.08	2.5
5.0	0.08	2.5
6.0	0.08	2.5
7.0	0.08	2.5
8.0	0.08	2.5
9.0	0.08	2.5
10.0	0.08	2.5

ULTRATECH GROUP OF LABS

3000 Bristol Circle, Oakville, Ontario, Canada L6H 6G4
Tel. #: 905-829-1570, Fax. #: 905-829-8050, Email: vic@ultratech-labs.com, Website: <http://www.ultratech-labs.com>

File #: ICOM-170F90
April 21, 2008

All test results contained in this engineering test report are traceable to National Institute of Standards and Technology (NIST)

6.8.4.2. Voice Modulation Limiting for 25 KHz Channel Spacing Operation

MODULATING SIGNAL LEVEL	PEAK FREQUENCY DEVIATION (KHz) at the following modulating frequency:					MAXIMUM LIMIT (KHz)
	0.1 KHz	0.5 KHz	1.0 KHz	3.0 KHz	5.0 KHz	
(mVrms)						
2	0.14	0.66	1.45	3.04	0.13	5
4	0.16	1.23	2.76	3.98	0.13	5
6	0.21	1.81	3.72	4.03	0.13	5
8	0.23	2.39	3.78	4.03	0.13	5
10	0.27	2.91	3.80	4.03	0.13	5
15	0.33	3.58	3.91	4.03	0.13	5
20	0.46	3.64	3.91	4.03	0.13	5
25	0.53	3.75	3.91	4.03	0.13	5
30	0.63	3.75	3.91	4.03	0.13	5
35	0.69	3.75	4.04	4.03	0.13	5
40	0.8	3.75	4.14	4.03	0.13	5
45	0.9	3.75	4.14	4.03	0.35	5
50	0.99	3.83	4.14	4.03	0.26	5
60	1.18	3.83	4.14	4.03	0.26	5
70	1.38	3.83	4.14	4.03	0.59	5
80	1.58	3.83	4.14	4.03	0.99	5
90	1.73	3.83	4.14	4.03	1.08	5
100	1.96	3.83	4.14	4.03	1.15	5
150	3.09	3.83	4.14	4.03	1.05	5
200	3.77	3.83	4.14	4.03	0.87	5
250	3.77	3.83	4.14	4.03	0.74	5

Voice Signal Input Level = STD MOD Level + 16 dB
= 12.87 dB(mVrms) + 16 dB
= 28.87 dB(mVrms)
= 27.76 mVrms

Modulation Frequency (KHz)	Peak Deviation (KHz)	Maximum Limit (KHz)
0.1	0.53	5.0
0.2	2.06	5.0
0.4	3.61	5.0
0.6	3.85	5.0
0.8	4.05	5.0
1.0	3.92	5.0
1.2	3.93	5.0
1.4	4.12	5.0
1.6	4.20	5.0
1.8	4.43	5.0
2.0	4.43	5.0
2.5	4.43	5.0
3.0	4.02	5.0
3.5	0.15	5.0
4.0	0.13	5.0
4.5	0.14	5.0
5.0	0.14	5.0
6.0	0.13	5.0
7.0	0.14	5.0
8.0	0.13	5.0
9.0	0.13	5.0
10.0	0.10	5.0

ULTRATECH GROUP OF LABS

3000 Bristol Circle, Oakville, Ontario, Canada L6H 6G4
Tel. #: 905-829-1570, Fax. #: 905-829-8050, Email: vic@ultratech-labs.com, Website: <http://www.ultratech-labs.com>

File #: ICOM-170F90
April 21, 2008

All test results contained in this engineering test report are traceable to National Institute of Standards and Technology (NIST)

6.9. OCCUPIED BANDWIDTH & EMISSION MASK [§§ 2.1049, 90.209 & 90.210]

6.9.1. Limits

Emissions shall be attenuated below the mean output power of the transmitter as follows:

Frequency Range (MHz)	Maximum Authorized BW (KHz)	Channel Spacing (KHz)	Recommended Frequency Deviation (KHz)	FCC Applicable Mask
156-174, 421-512	20.0	25	5.0	Mask B – Voice Mask C – Data
156-174, 421-512	11.25	12.5	2.5	Mask D – Voice & Data
150-174, 421-512	6	6.25	1.25	Mask E – Voice & Data

6.9.2. Method of Measurements

Refer to Section 9.4 of this report for measurement details and TIA-102.CAAA-B.

6.9.3. Test Arrangement

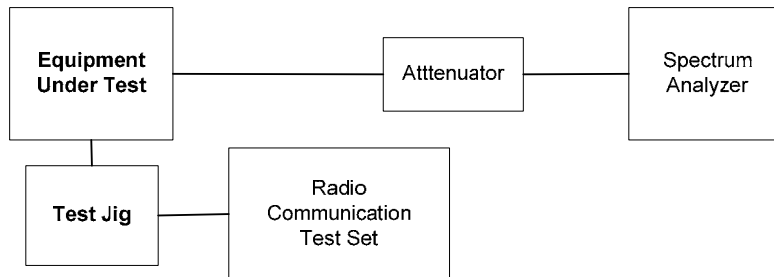

6.9.4. Test Data

6.9.4.1. 99% Occupied Bandwidth

Frequency (MHz)	Channel Spacing (KHz)	Modulation	*Measured 99% OBW at Maximum Freq. Deviation (KHz)	Maximum Authorized Bandwidth (KHz)
450.1	25	FM with 2.5 KHz sine wave signal	13.16	20.0
481.1	25	FM with 2.5 KHz sine wave signal	12.94	20.0
511.9	25	FM with 2.5 KHz sine wave signal	13.07	20.0
450.1	12.5	FM with 2.5 KHz sine wave signal	10.26	11.25
481.1	12.5	FM with 2.5 KHz sine wave signal	10.46	11.25
511.9	12.5	FM with 2.5 KHz sine wave signal	10.34	11.25
450.1	12.5	Digital	7.89	11.25
481.1	12.5	Digital	8.06	11.25
511.9	12.5	Digital	8.00	11.25
450.1	6.25	Digital	3.74	6
481.1	6.25	Digital	3.81	6
511.9	6.25	Digital	3.84	6
450.1	6.25	Analog	3.44	6
481.1	6.25	Analog	3.46	6
511.9	6.25	Analog	3.43	6

Note: 99% Occupied Bandwidth measurements were done using the built-in auto function of the analyzer.

*Refer to the following test data plots (1 through 15) for details.

ULTRATECH GROUP OF LABS

3000 Bristol Circle, Oakville, Ontario, Canada L6H 6G4
 Tel. #: 905-829-1570, Fax. #: 905-829-8050, Email: vic@ultratech-labs.com, Website: <http://www.ultratech-labs.com>

File #: ICOM-170F90
 April 21, 2008

All test results contained in this engineering test report are traceable to National Institute of Standards and Technology (NIST)

Plot # 1.:
Occupied Bandwidth
Carrier Frequency: 450.1 MHz
Channel Spacing: 25.0 KHz
Power: 50 W
Modulation: FM with 2.5 KHz sine wave signal

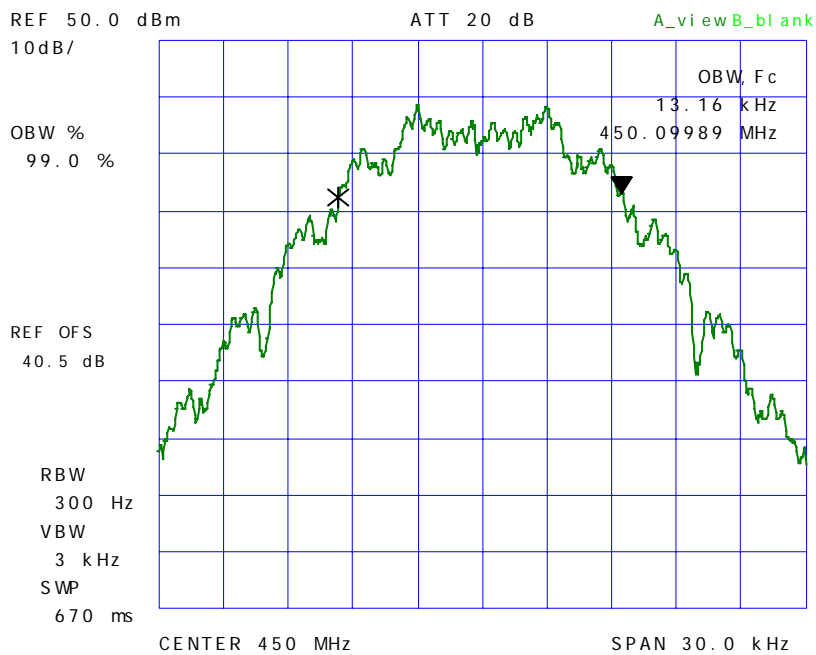

ULTRATECH GROUP OF LABS

3000 Bristol Circle, Oakville, Ontario, Canada L6H 6G4
Tel. #: 905-829-1570, Fax. #: 905-829-8050, Email: vic@ultratech-labs.com, Website: <http://www.ultratech-labs.com>

File #: ICOM-170F90
April 21, 2008

All test results contained in this engineering test report are traceable to National Institute of Standards and Technology (NIST)

Plot # 2.:
Occupied Bandwidth
Carrier Frequency: 481.1 MHz
Channel Spacing: 25.0 KHz
Power: 50 W
Modulation: FM with 2.5 KHz sine wave signal

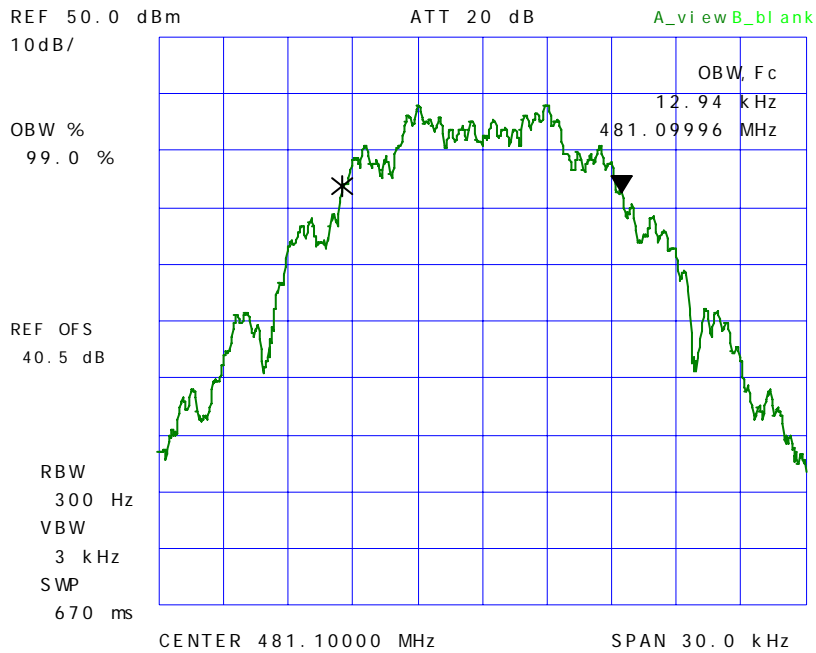

ULTRATECH GROUP OF LABS

3000 Bristol Circle, Oakville, Ontario, Canada L6H 6G4
Tel. #: 905-829-1570, Fax. #: 905-829-8050, Email: vic@ultratech-labs.com, Website: <http://www.ultratech-labs.com>

File #: ICOM-170F90
April 21, 2008

All test results contained in this engineering test report are traceable to National Institute of Standards and Technology (NIST)

Plot # 3.:
Occupied Bandwidth
Carrier Frequency: 511.9 MHz
Channel Spacing: 25.0 KHz
Power: 50 W
Modulation: FM with 2.5 KHz sine wave signal

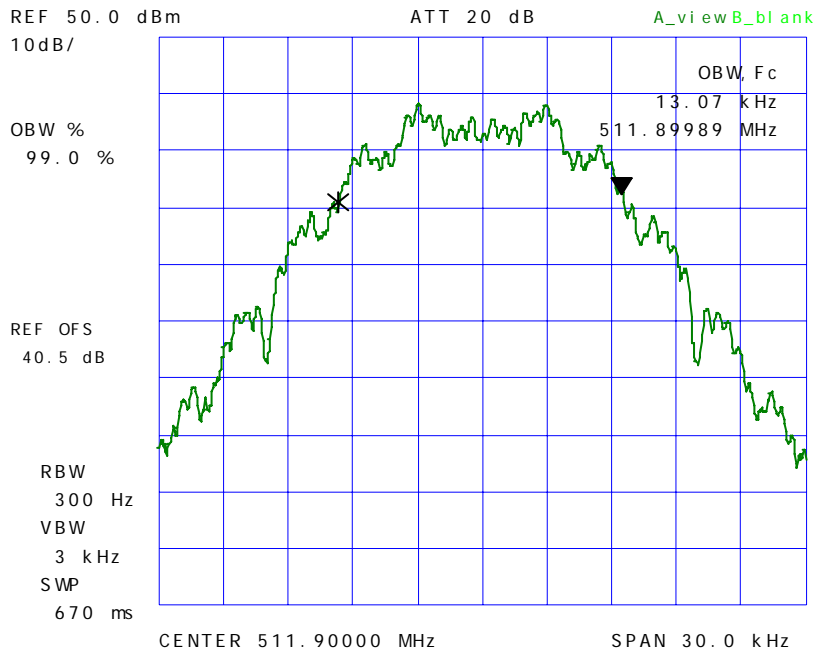

ULTRATECH GROUP OF LABS

3000 Bristol Circle, Oakville, Ontario, Canada L6H 6G4
Tel. #: 905-829-1570, Fax. #: 905-829-8050, Email: vic@ultratech-labs.com, Website: <http://www.ultratech-labs.com>

File #: ICOM-170F90
April 21, 2008

All test results contained in this engineering test report are traceable to National Institute of Standards and Technology (NIST)

Plot # 4.:
Occupied Bandwidth
Carrier Frequency: 450.1 MHz
Channel Spacing: 12.5 KHz
Power: 50 W
Modulation: FM with 2.5 KHz sine wave signal

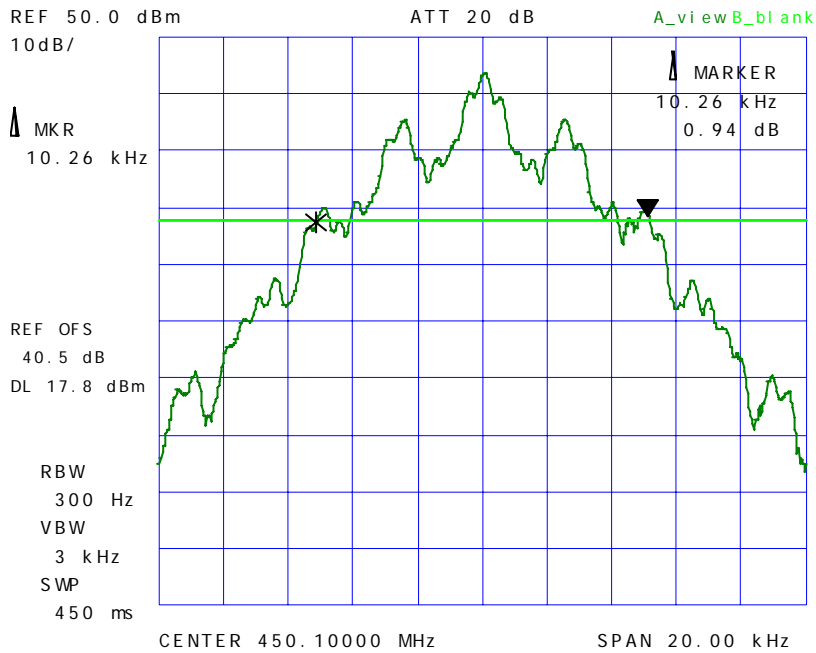

ULTRATECH GROUP OF LABS

3000 Bristol Circle, Oakville, Ontario, Canada L6H 6G4
Tel. #: 905-829-1570, Fax. #: 905-829-8050, Email: vic@ultratech-labs.com, Website: <http://www.ultratech-labs.com>

File #: ICOM-170F90
April 21, 2008

All test results contained in this engineering test report are traceable to National Institute of Standards and Technology (NIST)

Plot # 5.:
Occupied Bandwidth
Carrier Frequency: 481.1 MHz
Channel Spacing: 12.5 KHz
Power: 50 W
Modulation: FM with 2.5 KHz sine wave signal

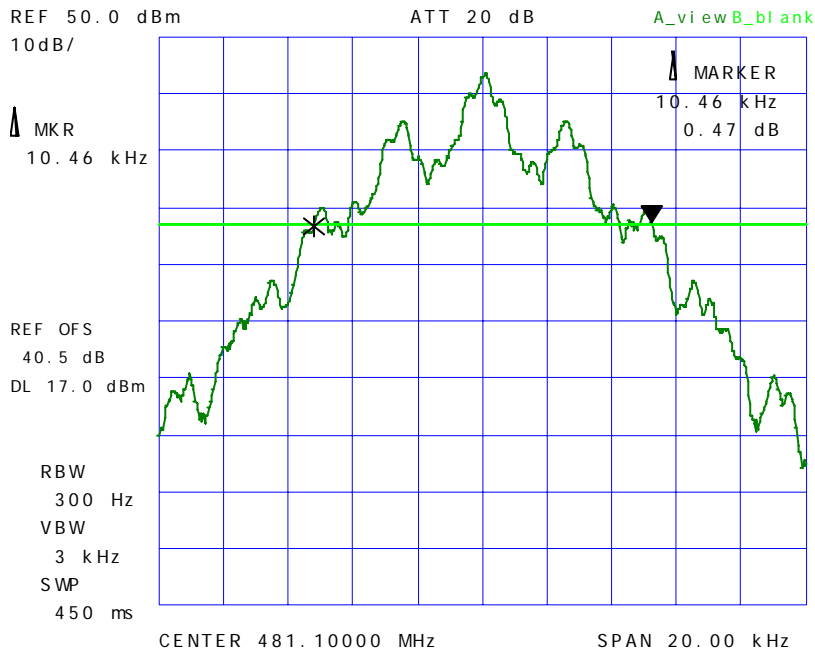

ULTRATECH GROUP OF LABS

3000 Bristol Circle, Oakville, Ontario, Canada L6H 6G4
Tel. #: 905-829-1570, Fax. #: 905-829-8050, Email: vic@ultratech-labs.com, Website: <http://www.ultratech-labs.com>

File #: ICOM-170F90
April 21, 2008

All test results contained in this engineering test report are traceable to National Institute of Standards and Technology (NIST)

Plot # 6.:
Occupied Bandwidth
Carrier Frequency: 511.9 MHz
Channel Spacing: 12.5 KHz
Power: 50 W
Modulation: FM with 2.5 KHz sine wave signal

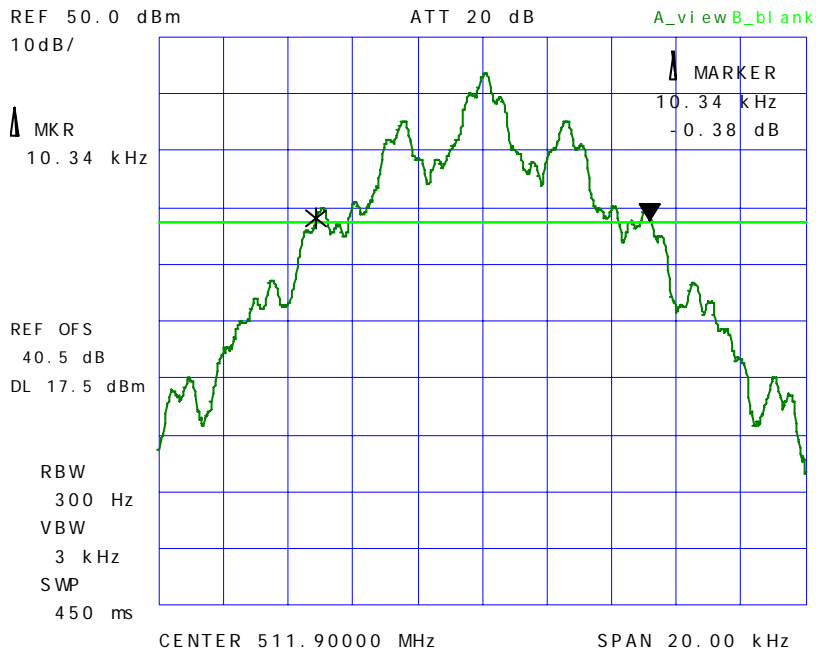

ULTRATECH GROUP OF LABS

3000 Bristol Circle, Oakville, Ontario, Canada L6H 6G4
Tel. #: 905-829-1570, Fax. #: 905-829-8050, Email: vic@ultratech-labs.com, Website: <http://www.ultratech-labs.com>

File #: ICOM-170F90
April 21, 2008

All test results contained in this engineering test report are traceable to National Institute of Standards and Technology (NIST)

Plot # 7.:
Occupied Bandwidth
Carrier Frequency: 450.1 MHz
Channel Spacing: 12.5 KHz
Power: 50 W
Modulation: Digital

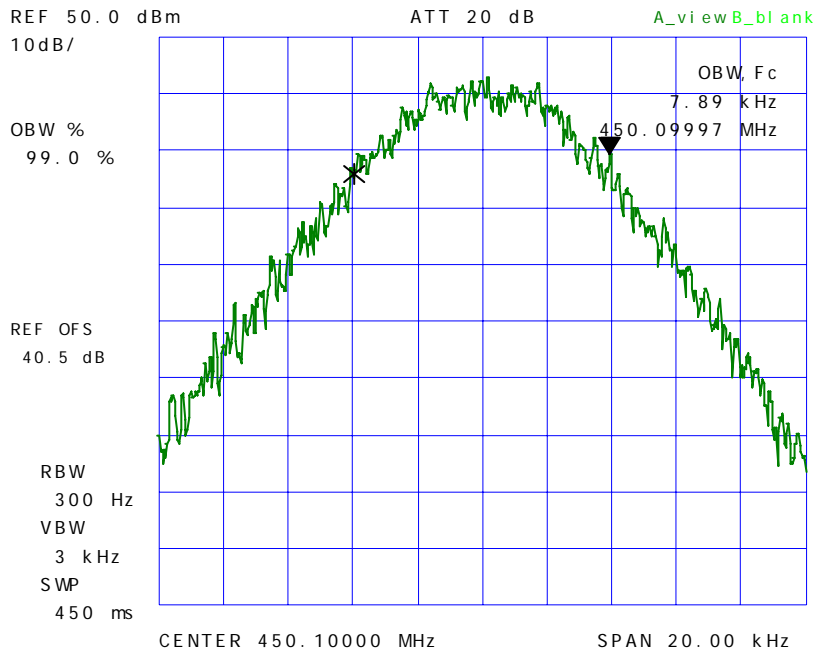

ULTRATECH GROUP OF LABS

3000 Bristol Circle, Oakville, Ontario, Canada L6H 6G4
Tel. #: 905-829-1570, Fax. #: 905-829-8050, Email: vic@ultratech-labs.com, Website: <http://www.ultratech-labs.com>

File #: ICOM-170F90
April 21, 2008

All test results contained in this engineering test report are traceable to National Institute of Standards and Technology (NIST)

Plot # 8.:
Occupied Bandwidth
Carrier Frequency: 481.1 MHz
Channel Spacing: 12.5 KHz
Power: 50 W
Modulation: Digital

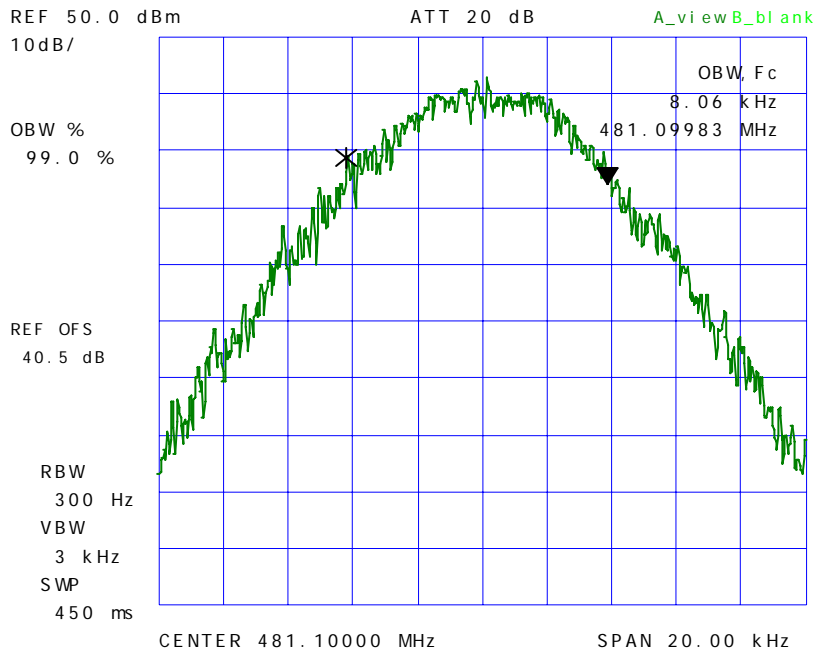

ULTRATECH GROUP OF LABS

3000 Bristol Circle, Oakville, Ontario, Canada L6H 6G4
Tel. #: 905-829-1570, Fax. #: 905-829-8050, Email: vic@ultratech-labs.com, Website: <http://www.ultratech-labs.com>

File #: ICOM-170F90
April 21, 2008

All test results contained in this engineering test report are traceable to National Institute of Standards and Technology (NIST)

Plot # 9.:
Occupied Bandwidth
Carrier Frequency: 511.9 MHz
Channel Spacing: 12.5 KHz
Power: 50 W
Modulation: Digital

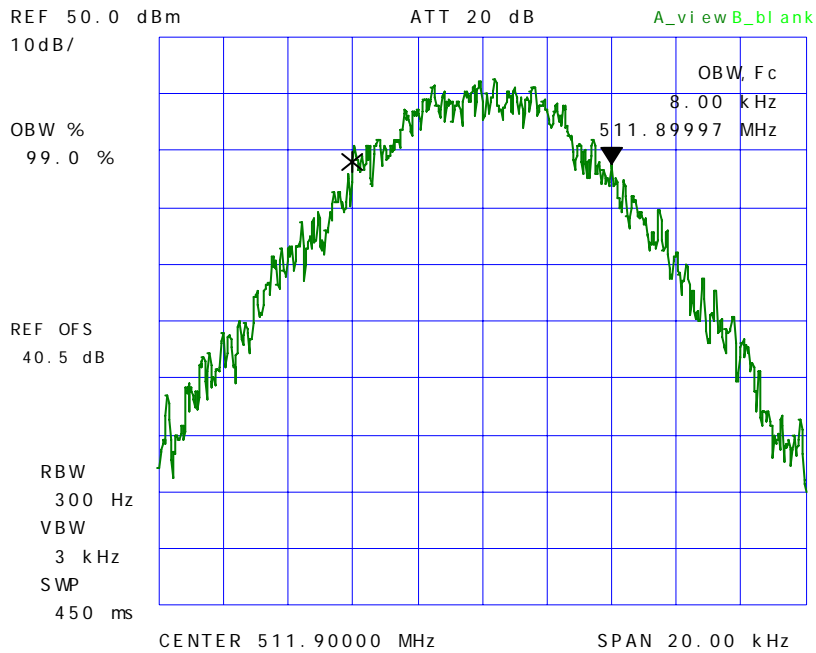

ULTRATECH GROUP OF LABS

3000 Bristol Circle, Oakville, Ontario, Canada L6H 6G4
Tel. #: 905-829-1570, Fax. #: 905-829-8050, Email: vic@ultratech-labs.com, Website: <http://www.ultratech-labs.com>

File #: ICOM-170F90
April 21, 2008

All test results contained in this engineering test report are traceable to National Institute of Standards and Technology (NIST)

Plot # 10.:
Occupied Bandwidth
Carrier Frequency: 450.1 MHz
Channel Spacing: 6.25 KHz
Power: 50 W
Modulation: Digital

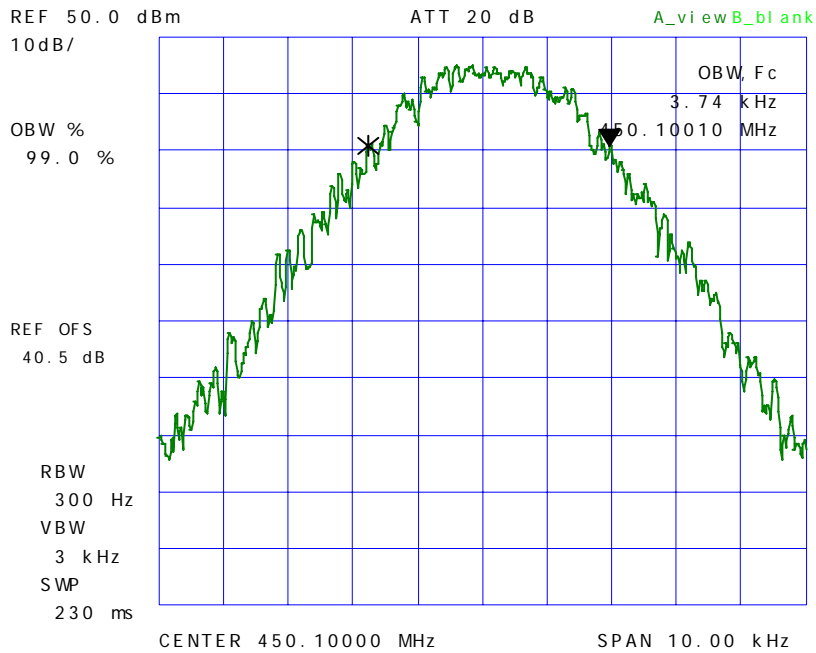

ULTRATECH GROUP OF LABS

3000 Bristol Circle, Oakville, Ontario, Canada L6H 6G4
Tel. #: 905-829-1570, Fax. #: 905-829-8050, Email: vic@ultratech-labs.com, Website: <http://www.ultratech-labs.com>

File #: ICOM-170F90
April 21, 2008

All test results contained in this engineering test report are traceable to National Institute of Standards and Technology (NIST)

Plot # 11.:
Occupied Bandwidth
Carrier Frequency: 481.1 MHz
Channel Spacing: 6.25 KHz
Power: 50 W
Modulation: Digital

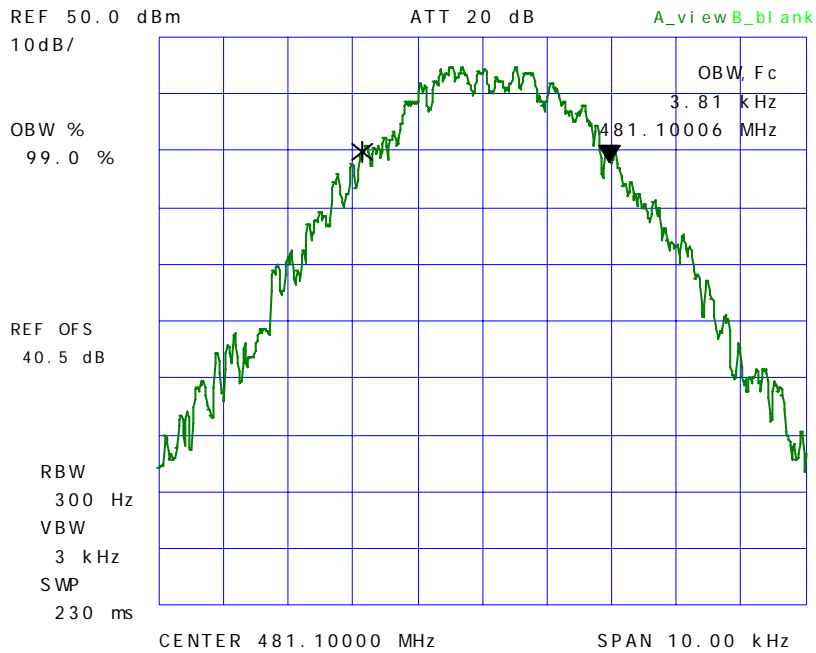

ULTRATECH GROUP OF LABS

3000 Bristol Circle, Oakville, Ontario, Canada L6H 6G4
Tel. #: 905-829-1570, Fax. #: 905-829-8050, Email: vic@ultratech-labs.com, Website: <http://www.ultratech-labs.com>

File #: ICOM-170F90
April 21, 2008

All test results contained in this engineering test report are traceable to National Institute of Standards and Technology (NIST)

Plot # 12.:
Occupied Bandwidth
Carrier Frequency: 511.9 MHz
Channel Spacing: 6.25 KHz
Power: 50 W
Modulation: Digital

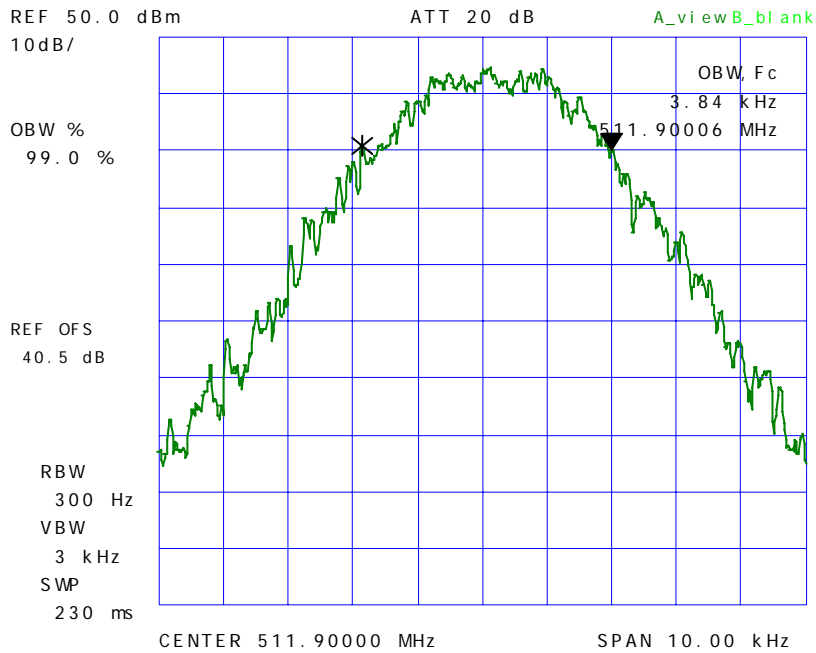

ULTRATECH GROUP OF LABS

3000 Bristol Circle, Oakville, Ontario, Canada L6H 6G4
Tel. #: 905-829-1570, Fax. #: 905-829-8050, Email: vic@ultratech-labs.com, Website: <http://www.ultratech-labs.com>

File #: ICOM-170F90
April 21, 2008

All test results contained in this engineering test report are traceable to National Institute of Standards and Technology (NIST)

Plot # 13.:
Occupied Bandwidth
Carrier Frequency: 450.1 MHz
Channel Spacing: 6.25 KHz
Power: 50 W
Modulation: Analog (CWID, AF 800 Hz, Dev. 0.6 kHz)

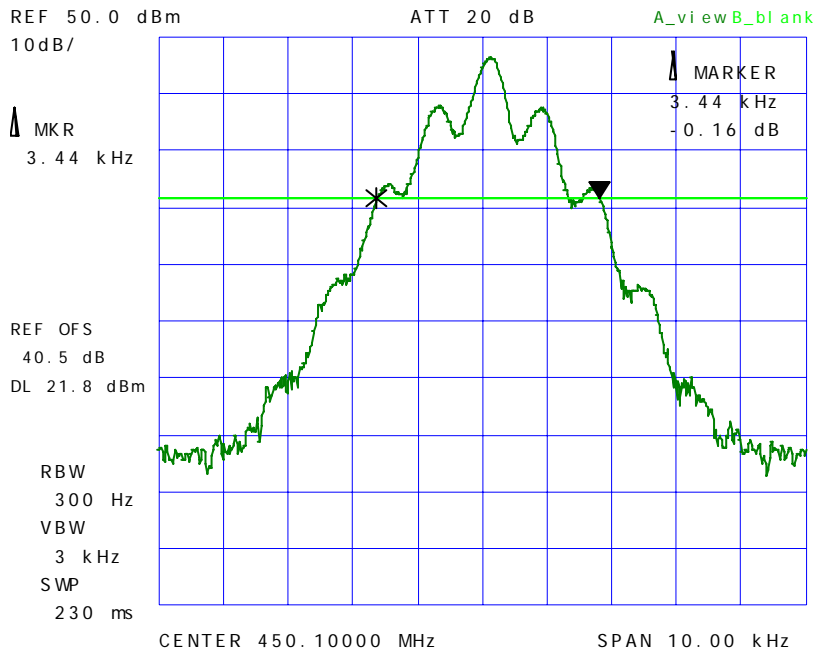

ULTRATECH GROUP OF LABS

3000 Bristol Circle, Oakville, Ontario, Canada L6H 6G4
Tel. #: 905-829-1570, Fax. #: 905-829-8050, Email: vic@ultratech-labs.com, Website: <http://www.ultratech-labs.com>

File #: ICOM-170F90
April 21, 2008

All test results contained in this engineering test report are traceable to National Institute of Standards and Technology (NIST)

Plot # 14.:
Occupied Bandwidth
Carrier Frequency: 481.1 MHz
Channel Spacing: 6.25 KHz
Power: 50 W
Modulation: Analog (CWID, AF 800 Hz, Dev. 0.6 kHz)

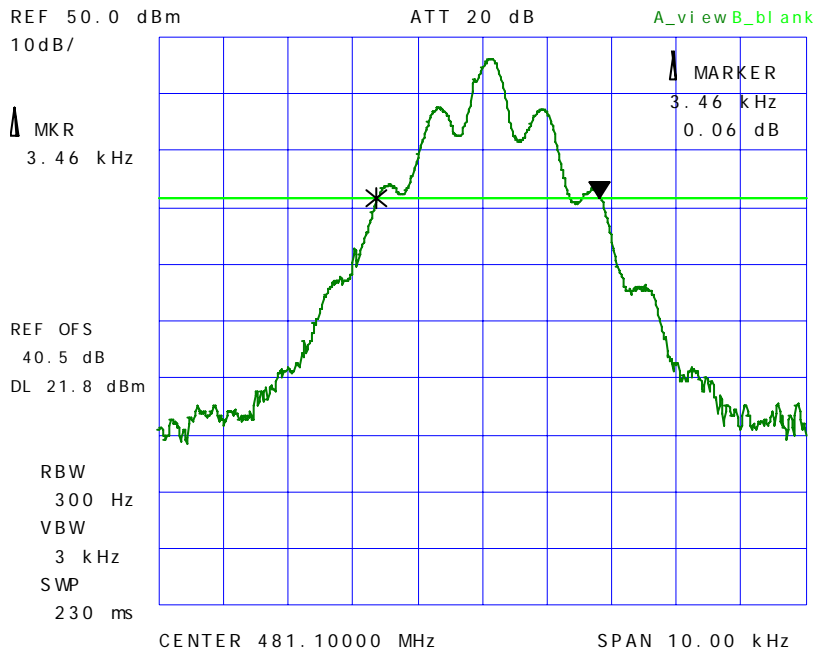

ULTRATECH GROUP OF LABS

3000 Bristol Circle, Oakville, Ontario, Canada L6H 6G4
Tel. #: 905-829-1570, Fax. #: 905-829-8050, Email: vic@ultratech-labs.com, Website: <http://www.ultratech-labs.com>

File #: ICOM-170F90
April 21, 2008

All test results contained in this engineering test report are traceable to National Institute of Standards and Technology (NIST)

Plot # 15.:
Occupied Bandwidth
Carrier Frequency: 511.9 MHz
Channel Spacing: 6.25 KHz
Power: 50 W
Modulation: Analog (CWID, AF 800 Hz, Dev. 0.6 kHz)

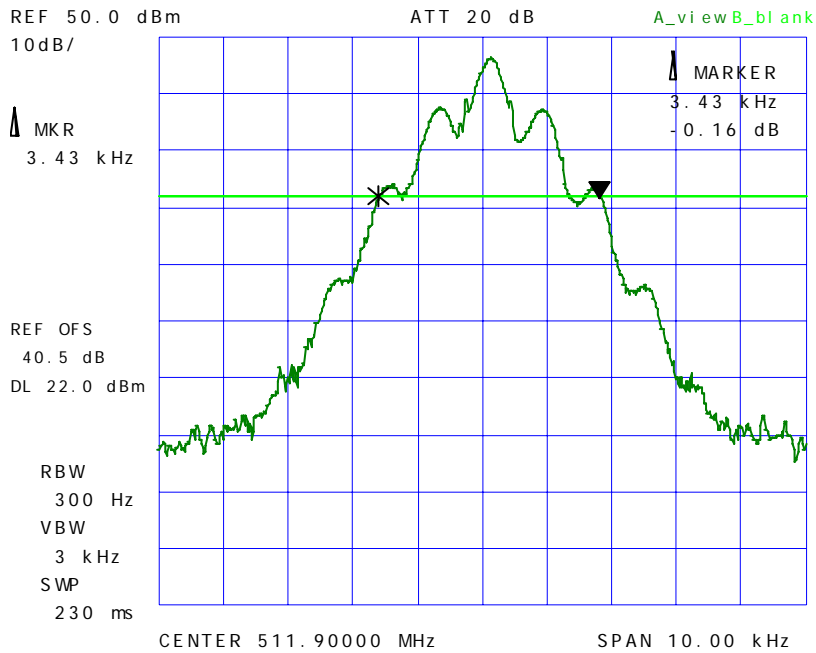

ULTRATECH GROUP OF LABS

3000 Bristol Circle, Oakville, Ontario, Canada L6H 6G4
Tel. #: 905-829-1570, Fax. #: 905-829-8050, Email: vic@ultratech-labs.com, Website: <http://www.ultratech-labs.com>

File #: ICOM-170F90
April 21, 2008

All test results contained in this engineering test report are traceable to National Institute of Standards and Technology (NIST)

6.9.4.2. Emission Masks

Conform. See the following test data plots (16 through 51) for details.

Plot # 16.:
Emission Mask B
Carrier Frequency: 450.1 MHz
Channel Spacing: 25 KHz
Power: 50 W
Modulation: FM with 2.5KHz sine wave

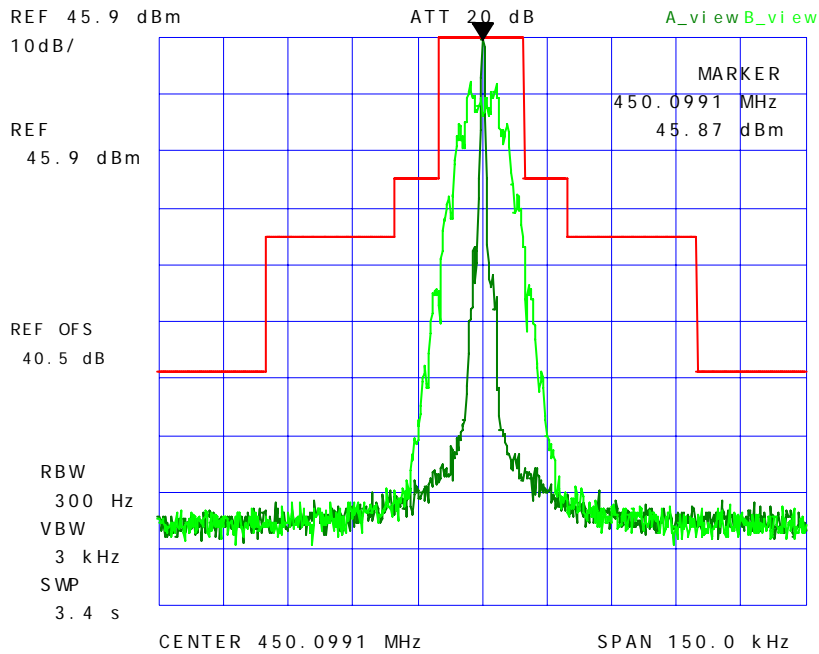

Plot # 17.:
Emission Mask B
Carrier Frequency: 481.1 MHz
Channel Spacing: 25 KHz
Power: 50 W
Modulation: FM with 2.5KHz sine wave

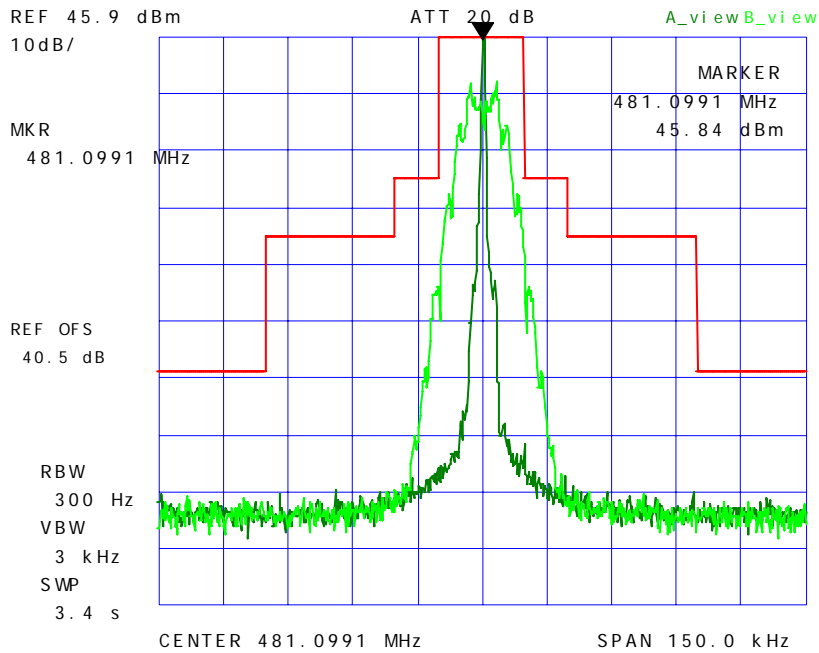

ULTRATECH GROUP OF LABS

3000 Bristol Circle, Oakville, Ontario, Canada L6H 6G4
Tel. #: 905-829-1570, Fax. #: 905-829-8050, Email: vic@ultratech-labs.com, Website: <http://www.ultratech-labs.com>

File #: ICOM-170F90
April 21, 2008

All test results contained in this engineering test report are traceable to National Institute of Standards and Technology (NIST)

Plot # 18.:
Emission Mask B
Carrier Frequency: 511.9 MHz
Channel Spacing: 25 KHz
Power: 50 W
Modulation: FM with 2.5KHz sine wave

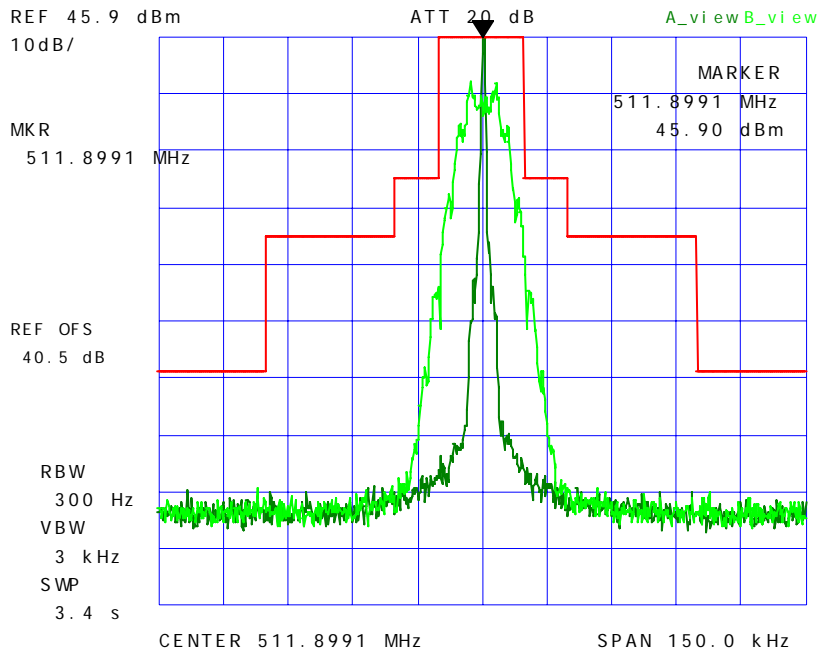

ULTRATECH GROUP OF LABS

3000 Bristol Circle, Oakville, Ontario, Canada L6H 6G4
Tel. #: 905-829-1570, Fax. #: 905-829-8050, Email: vic@ultratech-labs.com, Website: <http://www.ultratech-labs.com>

File #: ICOM-170F90
April 21, 2008

All test results contained in this engineering test report are traceable to National Institute of Standards and Technology (NIST)

Plot # 19.:
Emission Mask B
Carrier Frequency: 450.1 MHz
Channel Spacing: 25 KHz
Power: 5 W
Modulation: FM with 2.5KHz sine wave

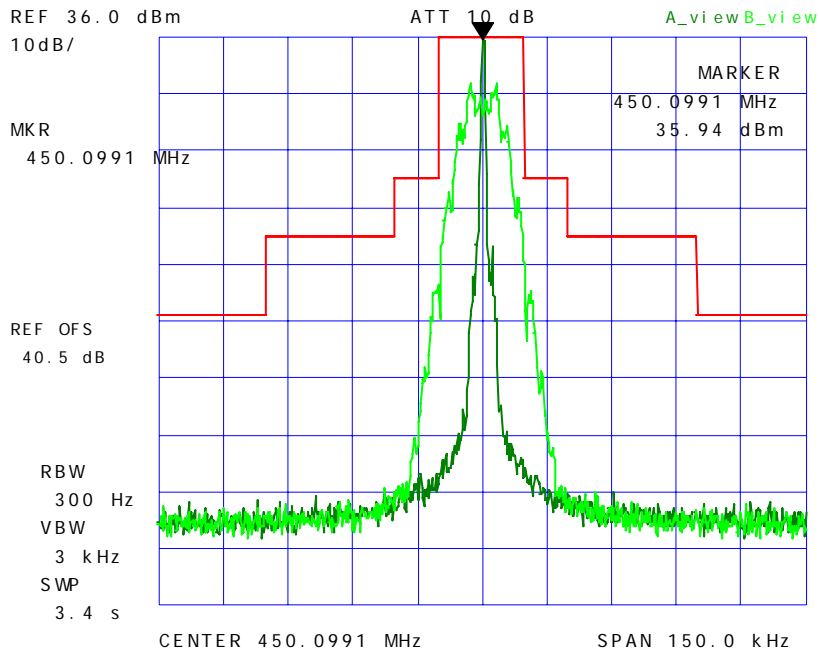

ULTRATECH GROUP OF LABS

3000 Bristol Circle, Oakville, Ontario, Canada L6H 6G4
Tel. #: 905-829-1570, Fax. #: 905-829-8050, Email: vic@ultratech-labs.com, Website: <http://www.ultratech-labs.com>

File #: ICOM-170F90
April 21, 2008

All test results contained in this engineering test report are traceable to National Institute of Standards and Technology (NIST)

Plot # 20.:
Emission Mask B
Carrier Frequency: 481.1 MHz
Channel Spacing: 25 KHz
Power: 5 W
Modulation: FM with 2.5KHz sine wave

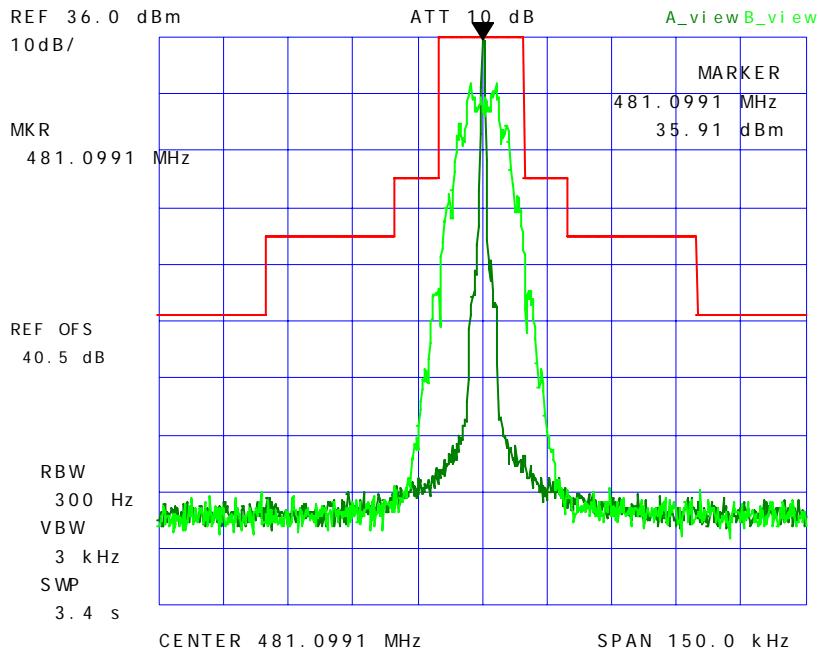

ULTRATECH GROUP OF LABS

3000 Bristol Circle, Oakville, Ontario, Canada L6H 6G4
Tel. #: 905-829-1570, Fax. #: 905-829-8050, Email: vic@ultratech-labs.com, Website: <http://www.ultratech-labs.com>

File #: ICOM-170F90
April 21, 2008

All test results contained in this engineering test report are traceable to National Institute of Standards and Technology (NIST)

Plot # 21.:
Emission Mask B
Carrier Frequency: 511.9 MHz
Channel Spacing: 25 KHz
Power: 5 W
Modulation: FM with 2.5KHz sine wave

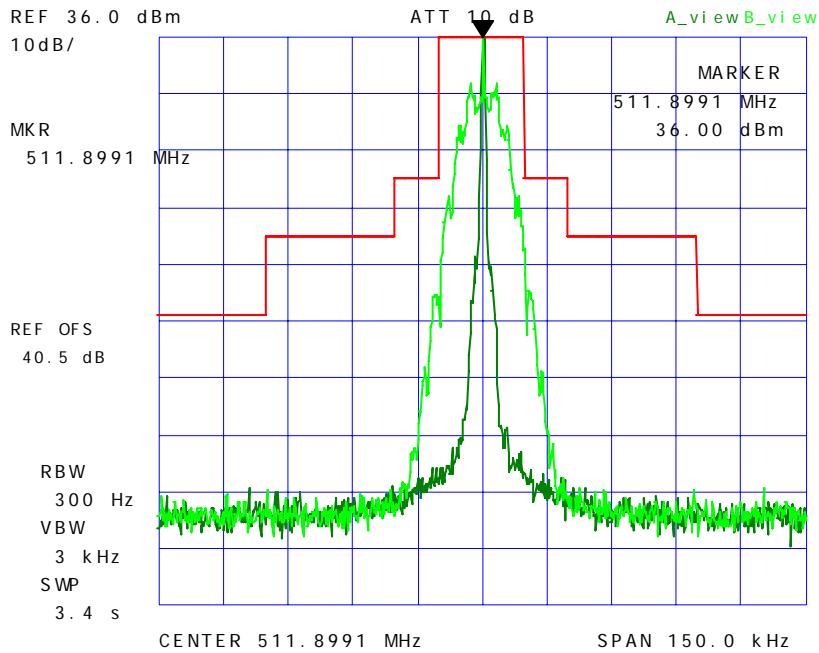

ULTRATECH GROUP OF LABS

3000 Bristol Circle, Oakville, Ontario, Canada L6H 6G4
Tel. #: 905-829-1570, Fax. #: 905-829-8050, Email: vic@ultratech-labs.com, Website: <http://www.ultratech-labs.com>

File #: ICOM-170F90
April 21, 2008

All test results contained in this engineering test report are traceable to National Institute of Standards and Technology (NIST)

Plot # 22.:
Emission Mask D
Carrier Frequency: 450.1 MHz
Channel Spacing: 12.5 KHz
Power: 50 W
Modulation: FM with 2.5KHz sine wave

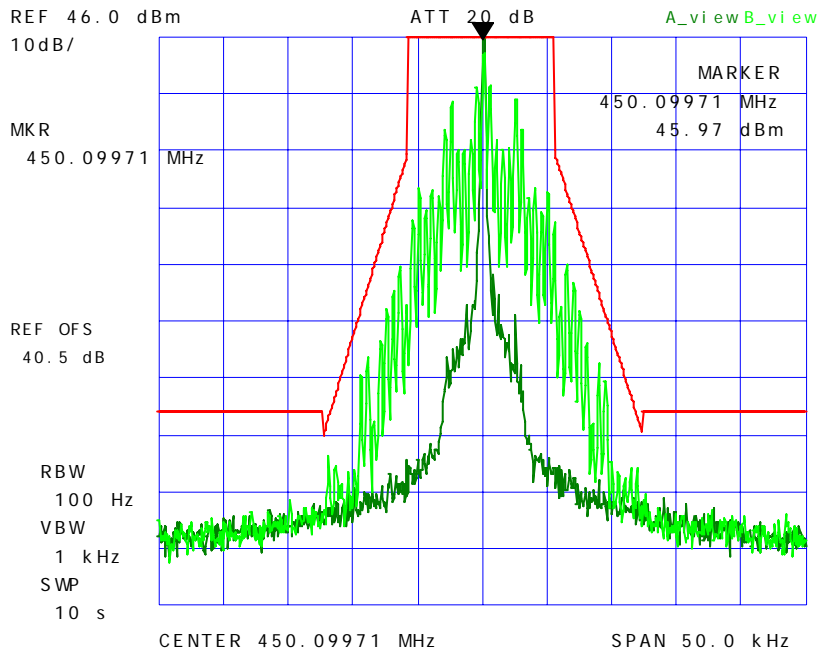

ULTRATECH GROUP OF LABS

3000 Bristol Circle, Oakville, Ontario, Canada L6H 6G4
Tel. #: 905-829-1570, Fax. #: 905-829-8050, Email: vic@ultratech-labs.com, Website: <http://www.ultratech-labs.com>

File #: ICOM-170F90
April 21, 2008

All test results contained in this engineering test report are traceable to National Institute of Standards and Technology (NIST)

Plot # 23.:
Emission Mask D
Carrier Frequency: 481.1 MHz
Channel Spacing: 12.5 KHz
Power: 50 W
Modulation: FM with 2.5KHz sine wave

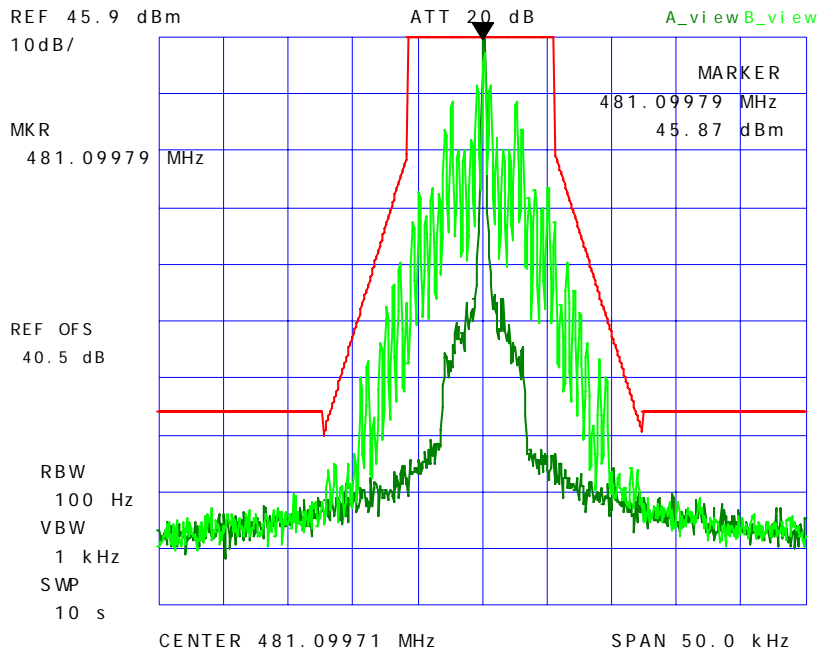

ULTRATECH GROUP OF LABS

3000 Bristol Circle, Oakville, Ontario, Canada L6H 6G4
Tel. #: 905-829-1570, Fax. #: 905-829-8050, Email: vic@ultratech-labs.com, Website: <http://www.ultratech-labs.com>

File #: ICOM-170F90
April 21, 2008

All test results contained in this engineering test report are traceable to National Institute of Standards and Technology (NIST)

Plot # 24.:
Emission Mask D
Carrier Frequency: 511.9 MHz
Channel Spacing: 12.5 KHz
Power: 50 W
Modulation: FM with 2.5KHz sine wave

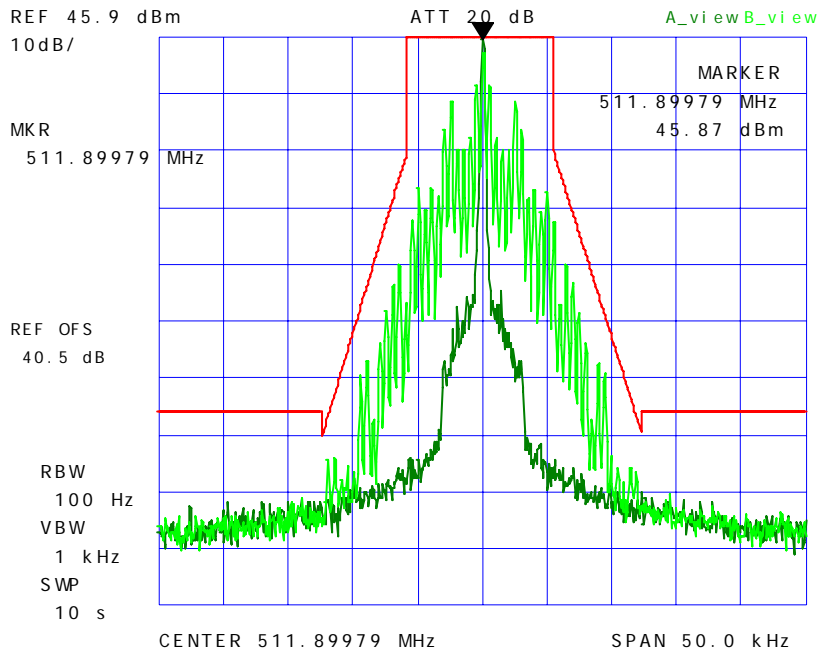

ULTRATECH GROUP OF LABS

3000 Bristol Circle, Oakville, Ontario, Canada L6H 6G4
Tel. #: 905-829-1570, Fax. #: 905-829-8050, Email: vic@ultratech-labs.com, Website: <http://www.ultratech-labs.com>

File #: ICOM-170F90
April 21, 2008

All test results contained in this engineering test report are traceable to National Institute of Standards and Technology (NIST)

Plot # 25.:
Emission Mask D
Carrier Frequency: 450.1 MHz
Channel Spacing: 12.5 KHz
Power: 5 W
Modulation: FM with 2.5KHz sine wave

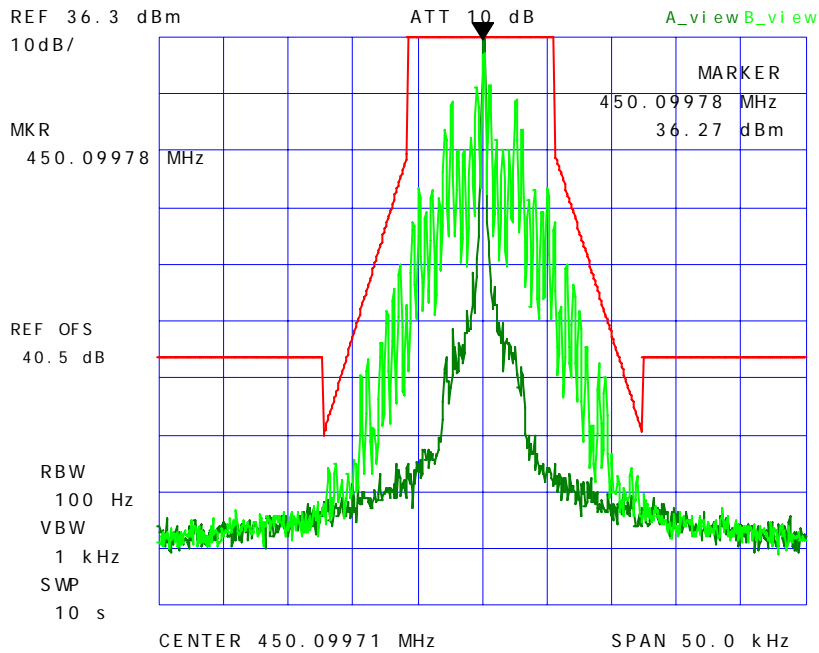

ULTRATECH GROUP OF LABS

3000 Bristol Circle, Oakville, Ontario, Canada L6H 6G4
Tel. #: 905-829-1570, Fax. #: 905-829-8050, Email: vic@ultratech-labs.com, Website: <http://www.ultratech-labs.com>

File #: ICOM-170F90
April 21, 2008

All test results contained in this engineering test report are traceable to National Institute of Standards and Technology (NIST)

Plot # 26.:
Emission Mask D
Carrier Frequency: 481.1 MHz
Channel Spacing: 12.5 KHz
Power: 5 W
Modulation: FM with 2.5KHz sine wave

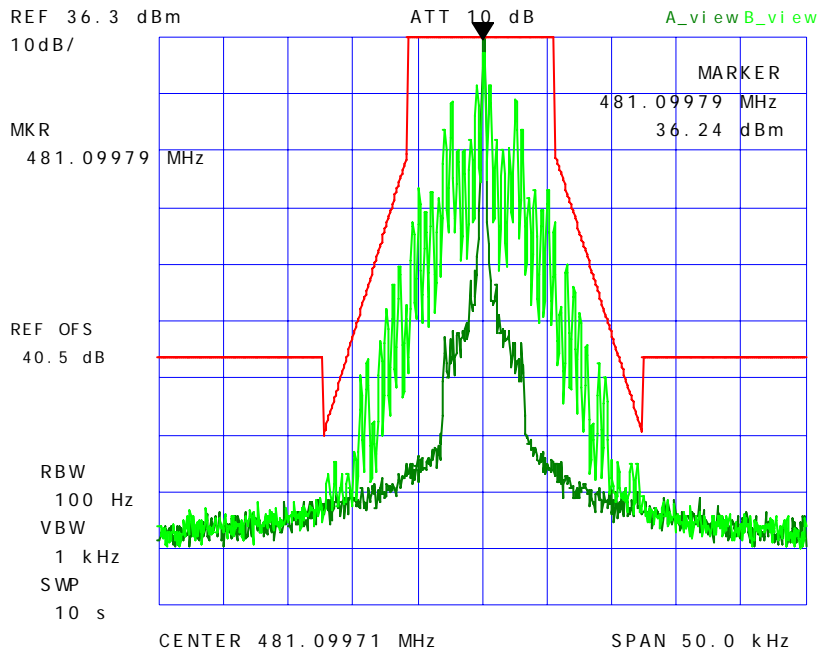

ULTRATECH GROUP OF LABS

3000 Bristol Circle, Oakville, Ontario, Canada L6H 6G4
Tel. #: 905-829-1570, Fax. #: 905-829-8050, Email: vic@ultratech-labs.com, Website: <http://www.ultratech-labs.com>

File #: ICOM-170F90
April 21, 2008

All test results contained in this engineering test report are traceable to National Institute of Standards and Technology (NIST)

Plot # 27.:
Emission Mask D
Carrier Frequency: 511.9 MHz
Channel Spacing: 12.5 KHz
Power: 5 W
Modulation: FM with 2.5KHz sine wave

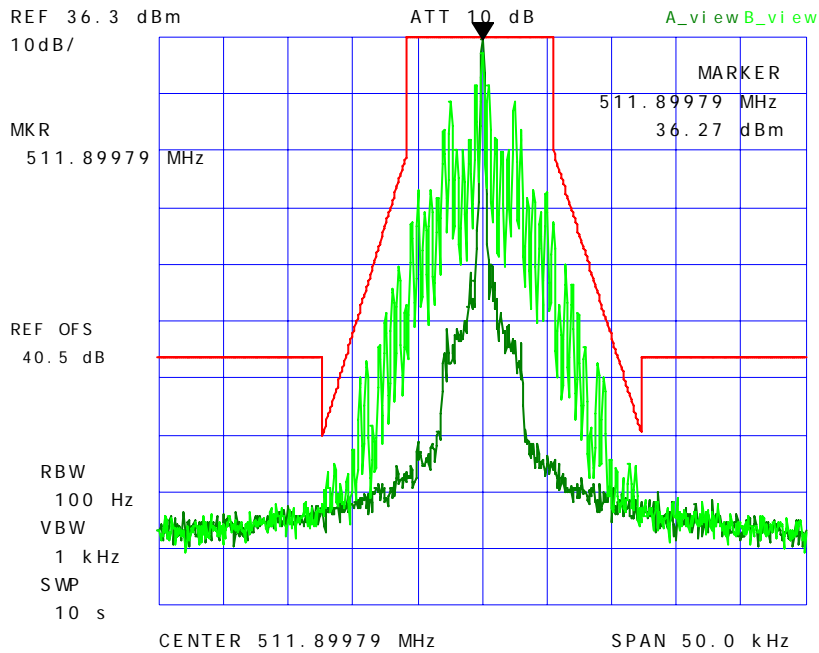

ULTRATECH GROUP OF LABS

3000 Bristol Circle, Oakville, Ontario, Canada L6H 6G4
Tel. #: 905-829-1570, Fax. #: 905-829-8050, Email: vic@ultratech-labs.com, Website: <http://www.ultratech-labs.com>

File #: ICOM-170F90
April 21, 2008

All test results contained in this engineering test report are traceable to National Institute of Standards and Technology (NIST)

Plot # 28.:
Emission Mask D
Carrier Frequency: 450.1 MHz
Channel Spacing: 12.5 KHz
Power: 50 W
Modulation: Digital

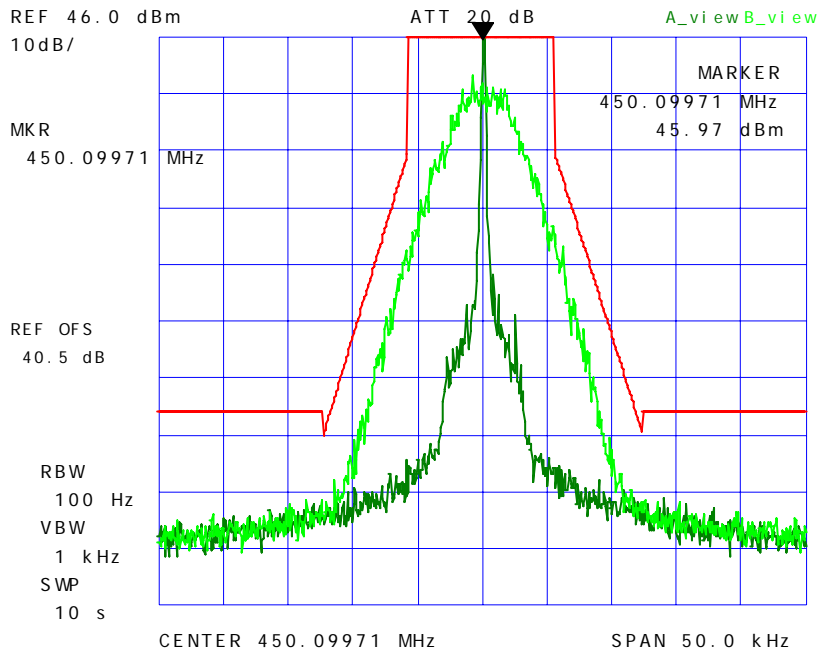

ULTRATECH GROUP OF LABS

3000 Bristol Circle, Oakville, Ontario, Canada L6H 6G4
Tel. #: 905-829-1570, Fax. #: 905-829-8050, Email: vic@ultratech-labs.com, Website: <http://www.ultratech-labs.com>

File #: ICOM-170F90
April 21, 2008

All test results contained in this engineering test report are traceable to National Institute of Standards and Technology (NIST)

Plot # 29.:
Emission Mask D
Carrier Frequency: 481.1 MHz
Channel Spacing: 12.5 KHz
Power: 50 W
Modulation: Digital

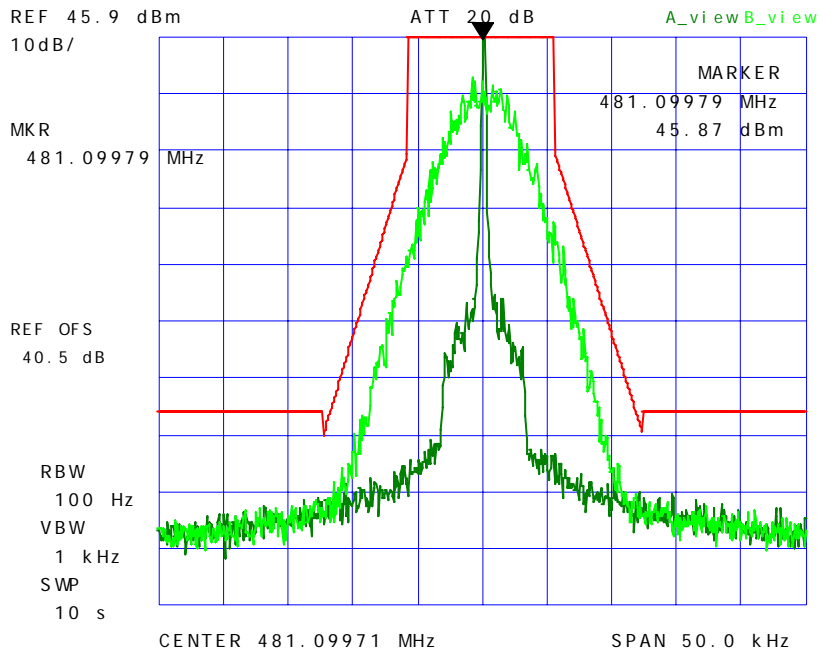

ULTRATECH GROUP OF LABS

3000 Bristol Circle, Oakville, Ontario, Canada L6H 6G4
Tel. #: 905-829-1570, Fax. #: 905-829-8050, Email: vic@ultratech-labs.com, Website: <http://www.ultratech-labs.com>

File #: ICOM-170F90
April 21, 2008

All test results contained in this engineering test report are traceable to National Institute of Standards and Technology (NIST)

Plot # 30.:
Emission Mask D
Carrier Frequency: 511.9 MHz
Channel Spacing: 12.5 KHz
Power: 50 W
Modulation: Digital

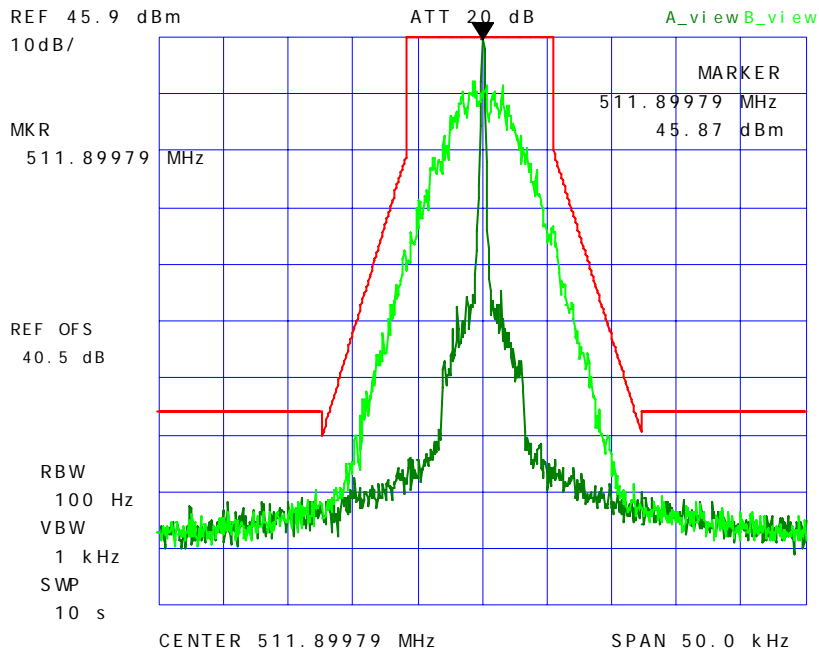

ULTRATECH GROUP OF LABS

3000 Bristol Circle, Oakville, Ontario, Canada L6H 6G4
Tel. #: 905-829-1570, Fax. #: 905-829-8050, Email: vic@ultratech-labs.com, Website: <http://www.ultratech-labs.com>

File #: ICOM-170F90
April 21, 2008

All test results contained in this engineering test report are traceable to National Institute of Standards and Technology (NIST)

Plot # 31.:
Emission Mask D
Carrier Frequency: 450.1 MHz
Channel Spacing: 12.5 KHz
Power: 5 W
Modulation: Digital

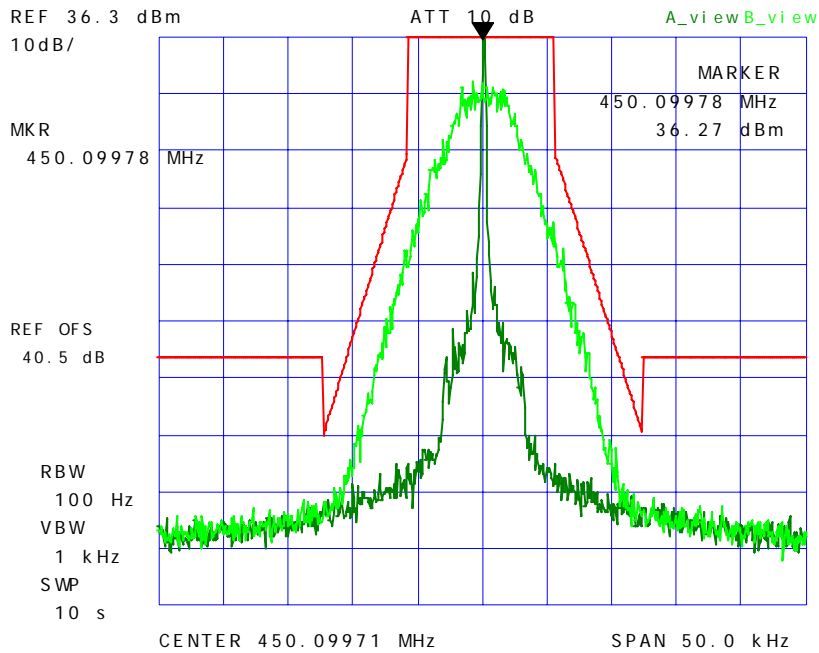

ULTRATECH GROUP OF LABS

3000 Bristol Circle, Oakville, Ontario, Canada L6H 6G4
Tel. #: 905-829-1570, Fax. #: 905-829-8050, Email: vic@ultratech-labs.com, Website: <http://www.ultratech-labs.com>

File #: ICOM-170F90
April 21, 2008

All test results contained in this engineering test report are traceable to National Institute of Standards and Technology (NIST)

Plot # 32.:
Emission Mask D
Carrier Frequency: 481.1 MHz
Channel Spacing: 12.5 KHz
Power: 5 W
Modulation: Digital

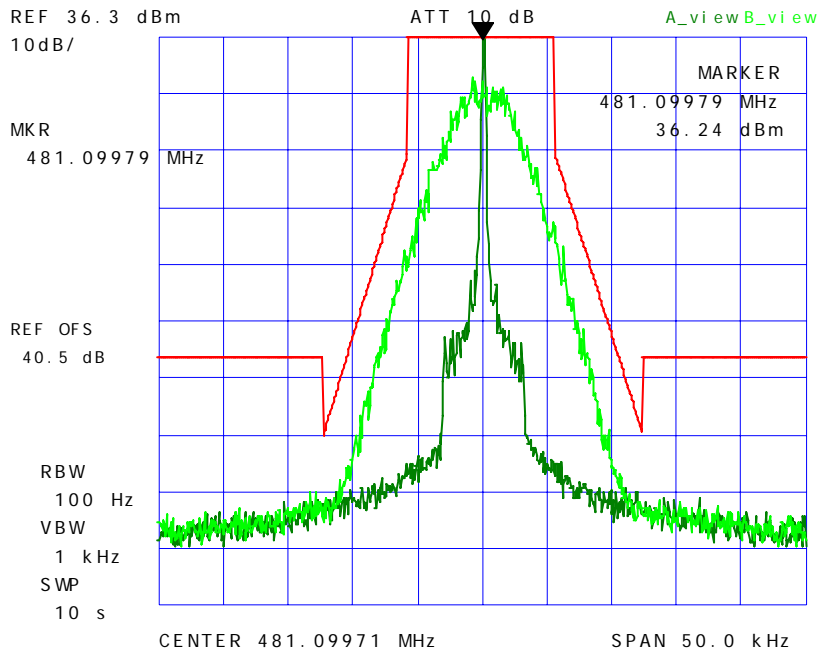

ULTRATECH GROUP OF LABS

3000 Bristol Circle, Oakville, Ontario, Canada L6H 6G4
Tel. #: 905-829-1570, Fax. #: 905-829-8050, Email: vic@ultratech-labs.com, Website: <http://www.ultratech-labs.com>

File #: ICOM-170F90
April 21, 2008

All test results contained in this engineering test report are traceable to National Institute of Standards and Technology (NIST)

Plot # 33.:
Emission Mask D
Carrier Frequency: 511.9 MHz
Channel Spacing: 12.5 KHz
Power: 5 W
Modulation: Digital

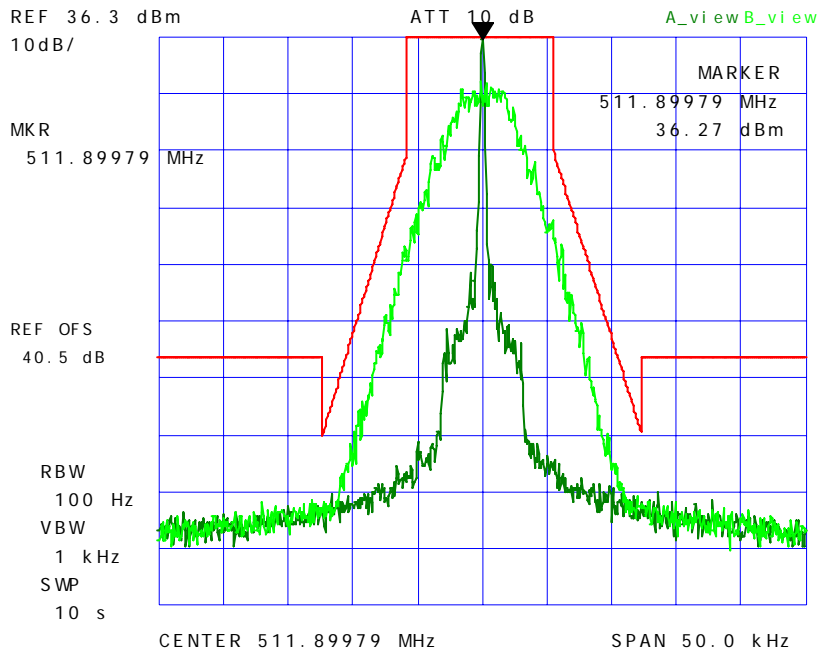

ULTRATECH GROUP OF LABS

3000 Bristol Circle, Oakville, Ontario, Canada L6H 6G4
Tel. #: 905-829-1570, Fax. #: 905-829-8050, Email: vic@ultratech-labs.com, Website: <http://www.ultratech-labs.com>

File #: ICOM-170F90
April 21, 2008

All test results contained in this engineering test report are traceable to National Institute of Standards and Technology (NIST)

Plot # 34.:
Emission Mask D
Carrier Frequency: 450.1 MHz \pm 3.125 kHz (CH19, CH20)
Channel Spacing: 12.5 KHz (aggregate of two 6.25 kHz channels)
Power: 50 W
Modulation: Digital

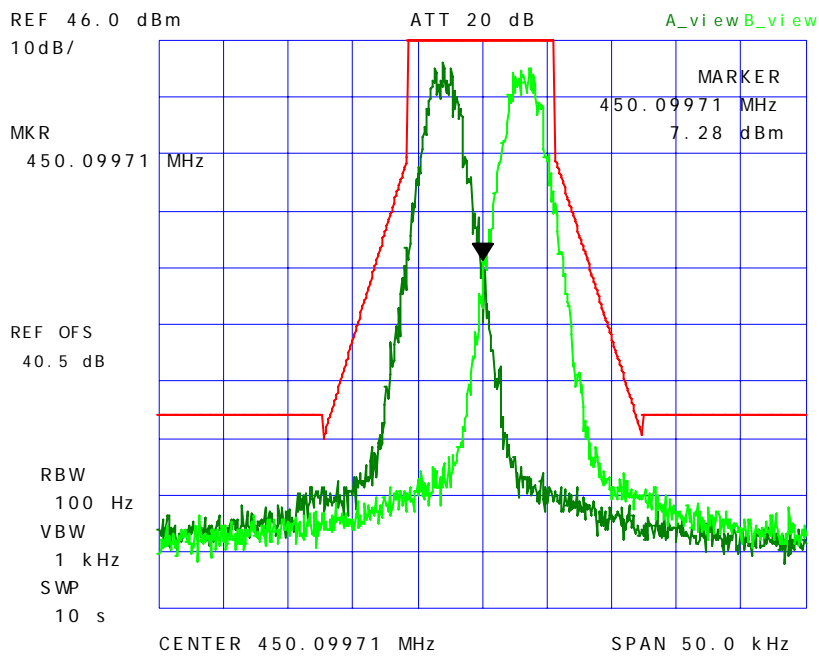

ULTRATECH GROUP OF LABS

3000 Bristol Circle, Oakville, Ontario, Canada L6H 6G4
Tel. #: 905-829-1570, Fax. #: 905-829-8050, Email: vic@ultratech-labs.com, Website: <http://www.ultratech-labs.com>

File #: ICOM-170F90
April 21, 2008

All test results contained in this engineering test report are traceable to National Institute of Standards and Technology (NIST)

Plot # 35.:
Emission Mask D
Carrier Frequency: 481.1 MHz \pm 3.125 kHz (CH21, CH22)
Channel Spacing: 12.5 KHz (aggregate of two 6.25 kHz channels)
Power: 50 W
Modulation: Digital

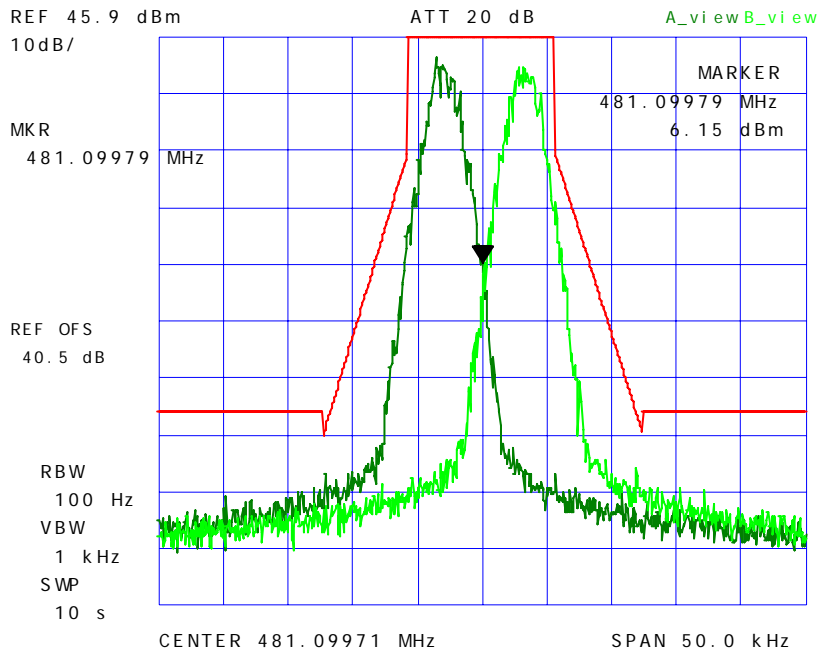

ULTRATECH GROUP OF LABS

3000 Bristol Circle, Oakville, Ontario, Canada L6H 6G4
Tel. #: 905-829-1570, Fax. #: 905-829-8050, Email: vic@ultratech-labs.com, Website: <http://www.ultratech-labs.com>

File #: ICOM-170F90
April 21, 2008

All test results contained in this engineering test report are traceable to National Institute of Standards and Technology (NIST)

Plot # 36.:
Emission Mask D
Carrier Frequency: 511.9 MHz \pm 3.125 kHz (CH23, CH24)
Channel Spacing: 12.5 KHz (aggregate of two 6.25 kHz channels)
Power: 50 W
Modulation: Digital

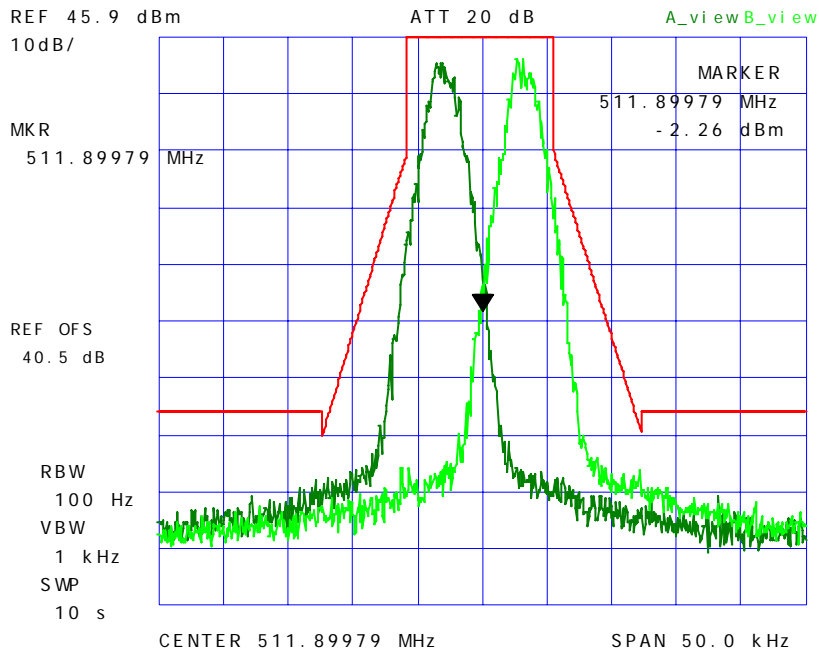

ULTRATECH GROUP OF LABS

3000 Bristol Circle, Oakville, Ontario, Canada L6H 6G4
Tel. #: 905-829-1570, Fax. #: 905-829-8050, Email: vic@ultratech-labs.com, Website: <http://www.ultratech-labs.com>

File #: ICOM-170F90
April 21, 2008

All test results contained in this engineering test report are traceable to National Institute of Standards and Technology (NIST)

Plot # 37.:
Emission Mask D
Carrier Frequency: 450.1 MHz \pm 3.125 kHz (CH25, CH26)
Channel Spacing: 12.5 KHz (aggregate of two 6.25 kHz channels)
Power: 5 W
Modulation: Digital

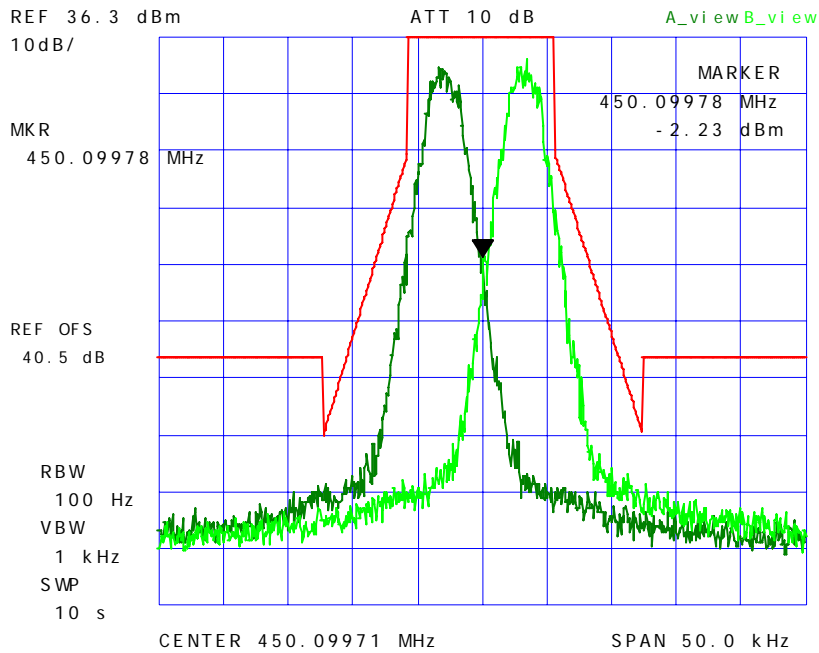

ULTRATECH GROUP OF LABS

3000 Bristol Circle, Oakville, Ontario, Canada L6H 6G4
Tel. #: 905-829-1570, Fax. #: 905-829-8050, Email: vic@ultratech-labs.com, Website: <http://www.ultratech-labs.com>

File #: ICOM-170F90
April 21, 2008

All test results contained in this engineering test report are traceable to National Institute of Standards and Technology (NIST)

Plot # 38.:
Emission Mask D
Carrier Frequency: 481.1 MHz \pm 3.125 kHz (CH27, CH28)
Channel Spacing: 12.5 KHz (aggregate of two 6.25 kHz channels)
Power: 5 W
Modulation: Digital

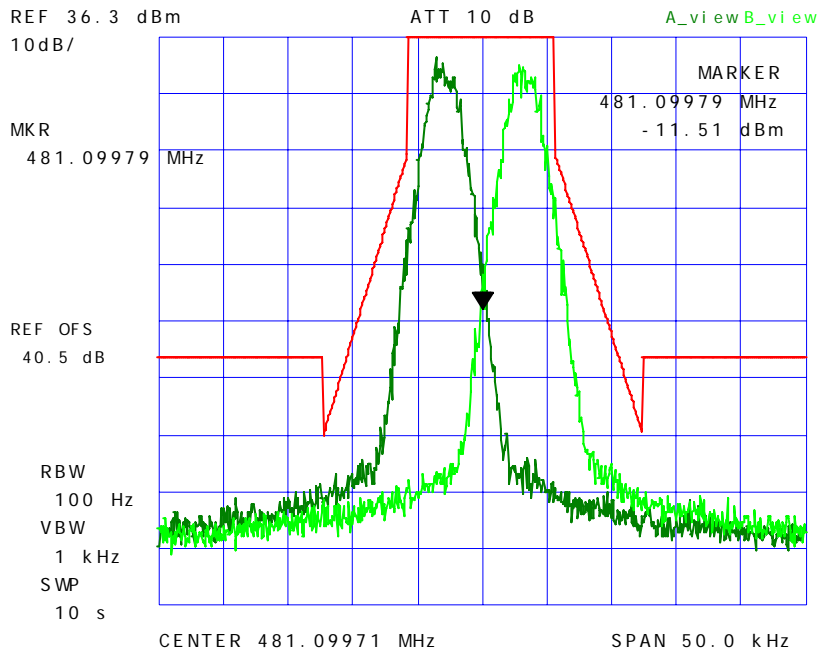

ULTRATECH GROUP OF LABS

3000 Bristol Circle, Oakville, Ontario, Canada L6H 6G4
Tel. #: 905-829-1570, Fax. #: 905-829-8050, Email: vic@ultratech-labs.com, Website: <http://www.ultratech-labs.com>

File #: ICOM-170F90
April 21, 2008

All test results contained in this engineering test report are traceable to National Institute of Standards and Technology (NIST)

Plot # 39.:
Emission Mask D
Carrier Frequency: 511.9 MHz \pm 3.125 kHz (CH29, CH30)
Channel Spacing: 12.5 KHz (aggregate of two 6.25 kHz channels)
Power: 5 W
Modulation: Digital

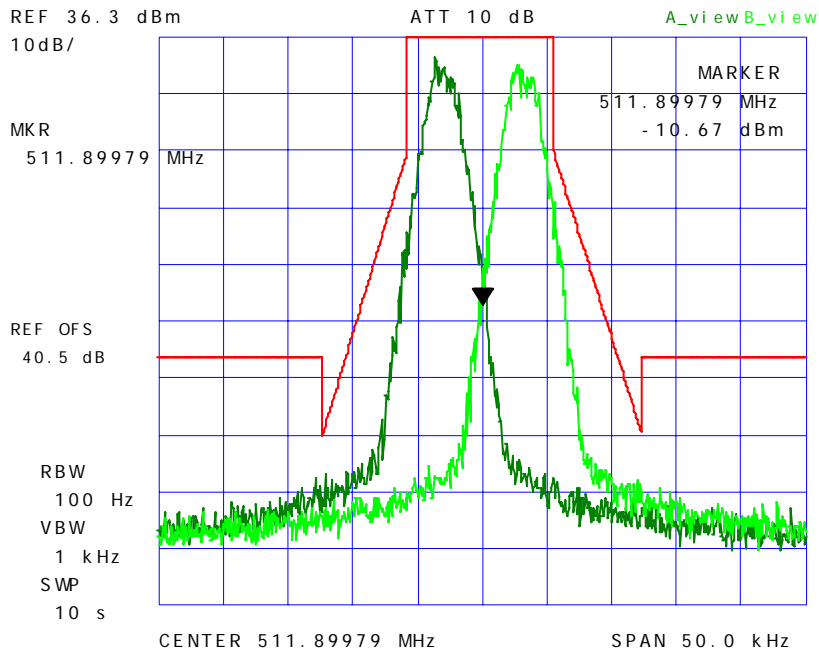

ULTRATECH GROUP OF LABS

3000 Bristol Circle, Oakville, Ontario, Canada L6H 6G4
Tel. #: 905-829-1570, Fax. #: 905-829-8050, Email: vic@ultratech-labs.com, Website: <http://www.ultratech-labs.com>

File #: ICOM-170F90
April 21, 2008

All test results contained in this engineering test report are traceable to National Institute of Standards and Technology (NIST)

Plot # 40.:
Emission Mask E
Carrier Frequency: 450.1 MHz
Channel Spacing: 6.25 KHz
Power: 50 W
Modulation: Digital

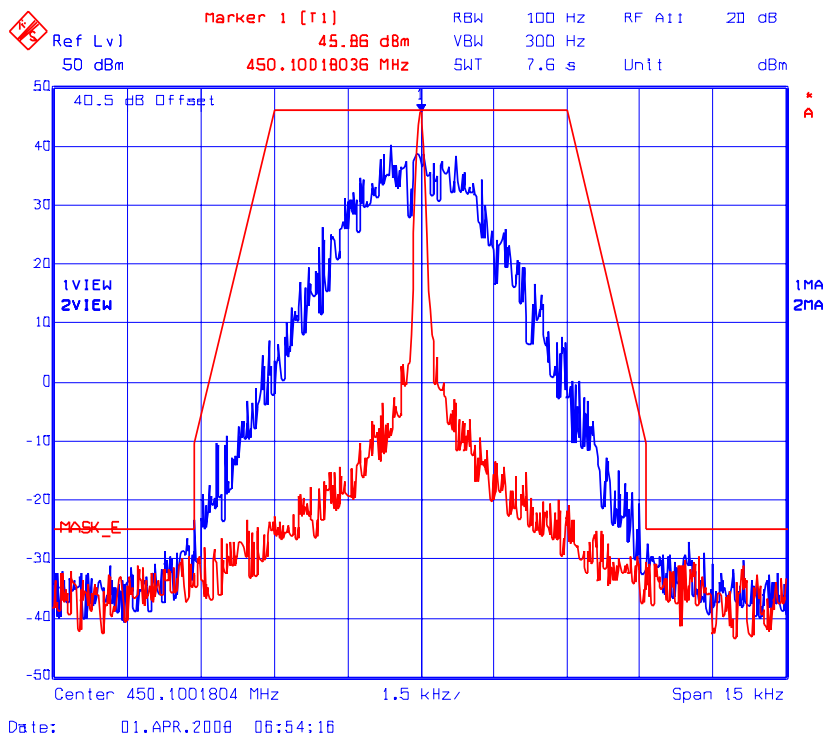

ULTRATECH GROUP OF LABS

3000 Bristol Circle, Oakville, Ontario, Canada L6H 6G4
Tel. #: 905-829-1570, Fax. #: 905-829-8050, Email: vic@ultratech-labs.com, Website: <http://www.ultratech-labs.com>

File #: ICOM-170F90
April 21, 2008

All test results contained in this engineering test report are traceable to National Institute of Standards and Technology (NIST)

Plot # 41.:
Emission Mask E
Carrier Frequency: 481.1 MHz
Channel Spacing: 6.25 KHz
Power: 50 W
Modulation: Digital

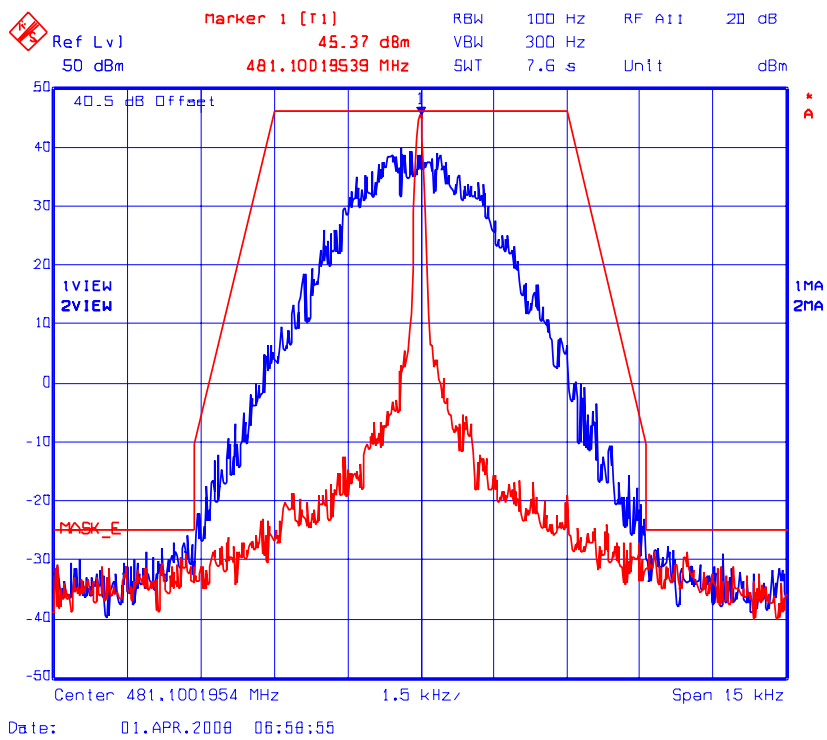

ULTRATECH GROUP OF LABS

3000 Bristol Circle, Oakville, Ontario, Canada L6H 6G4
Tel. #: 905-829-1570, Fax. #: 905-829-8050, Email: vic@ultratech-labs.com, Website: <http://www.ultratech-labs.com>

File #: ICOM-170F90
April 21, 2008

All test results contained in this engineering test report are traceable to National Institute of Standards and Technology (NIST)

Plot # 42.:
Emission Mask E
Carrier Frequency: 511.9 MHz
Channel Spacing: 6.25 KHz
Power: 50 W
Modulation: Digital

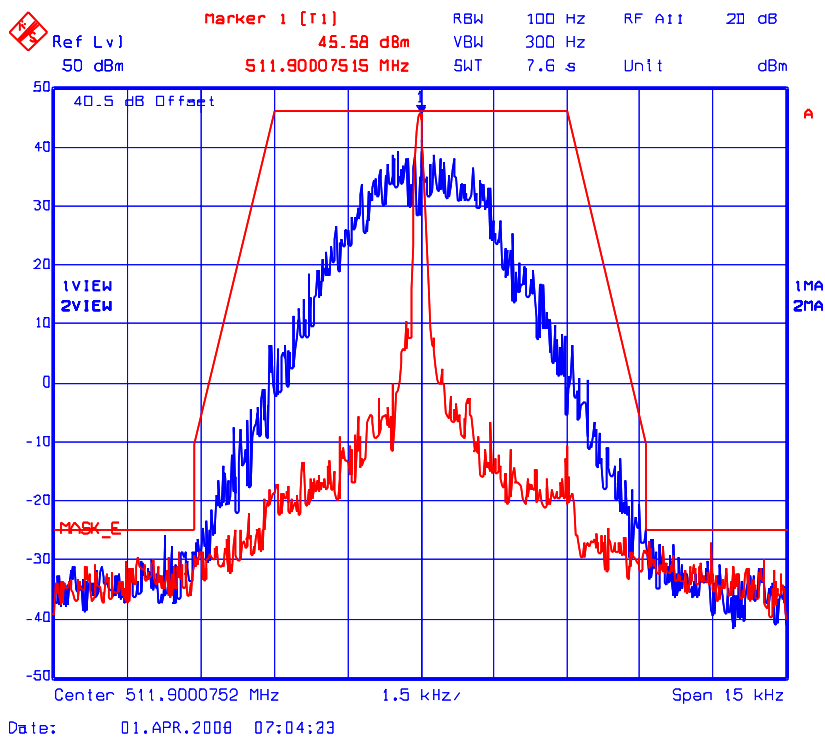

ULTRATECH GROUP OF LABS

3000 Bristol Circle, Oakville, Ontario, Canada L6H 6G4
Tel. #: 905-829-1570, Fax. #: 905-829-8050, Email: vic@ultratech-labs.com, Website: <http://www.ultratech-labs.com>

File #: ICOM-170F90
April 21, 2008

All test results contained in this engineering test report are traceable to National Institute of Standards and Technology (NIST)

Plot # 43.:
Emission Mask E
Carrier Frequency: 450.1 MHz
Channel Spacing: 6.25 KHz
Power: 5 W
Modulation: Digital

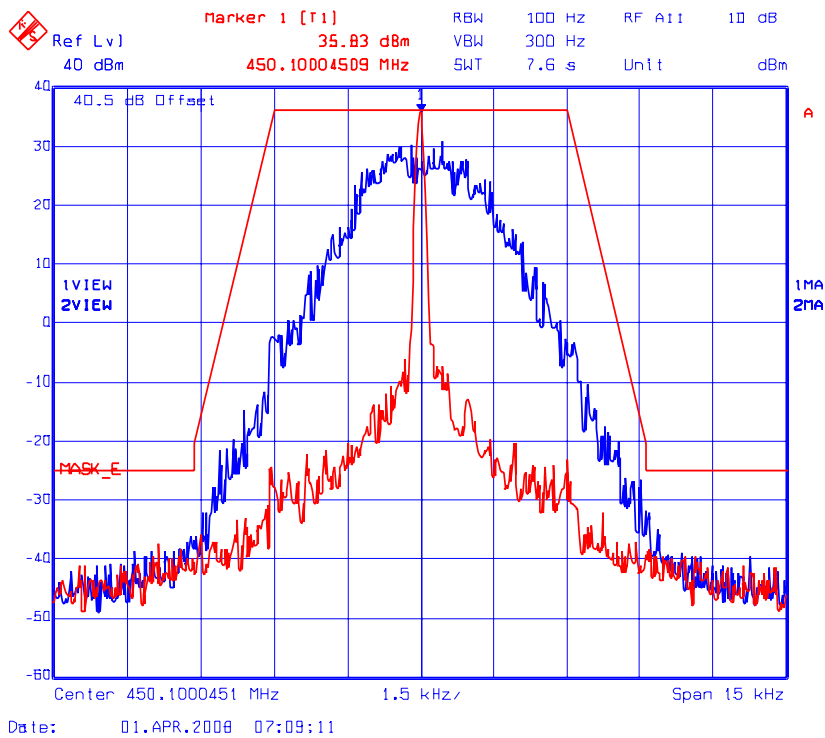

ULTRATECH GROUP OF LABS

3000 Bristol Circle, Oakville, Ontario, Canada L6H 6G4
Tel. #: 905-829-1570, Fax. #: 905-829-8050, Email: vic@ultratech-labs.com, Website: <http://www.ultratech-labs.com>

File #: ICOM-170F90
April 21, 2008

All test results contained in this engineering test report are traceable to National Institute of Standards and Technology (NIST)

Plot # 44.:
Emission Mask E
Carrier Frequency: 481.1 MHz
Channel Spacing: 6.25 KHz
Power: 5 W
Modulation: Digital

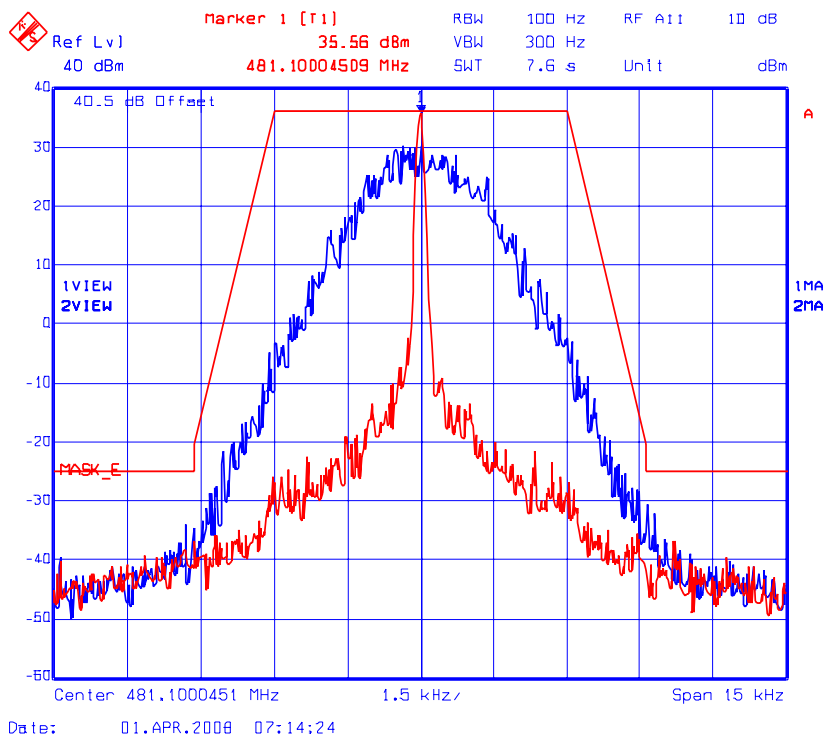

ULTRATECH GROUP OF LABS

3000 Bristol Circle, Oakville, Ontario, Canada L6H 6G4
Tel. #: 905-829-1570, Fax. #: 905-829-8050, Email: vic@ultratech-labs.com, Website: <http://www.ultratech-labs.com>

File #: ICOM-170F90
April 21, 2008

All test results contained in this engineering test report are traceable to National Institute of Standards and Technology (NIST)

Plot # 45.:
Emission Mask E
Carrier Frequency: 511.9 MHz
Channel Spacing: 6.25 KHz
Power: 5 W
Modulation: Digital

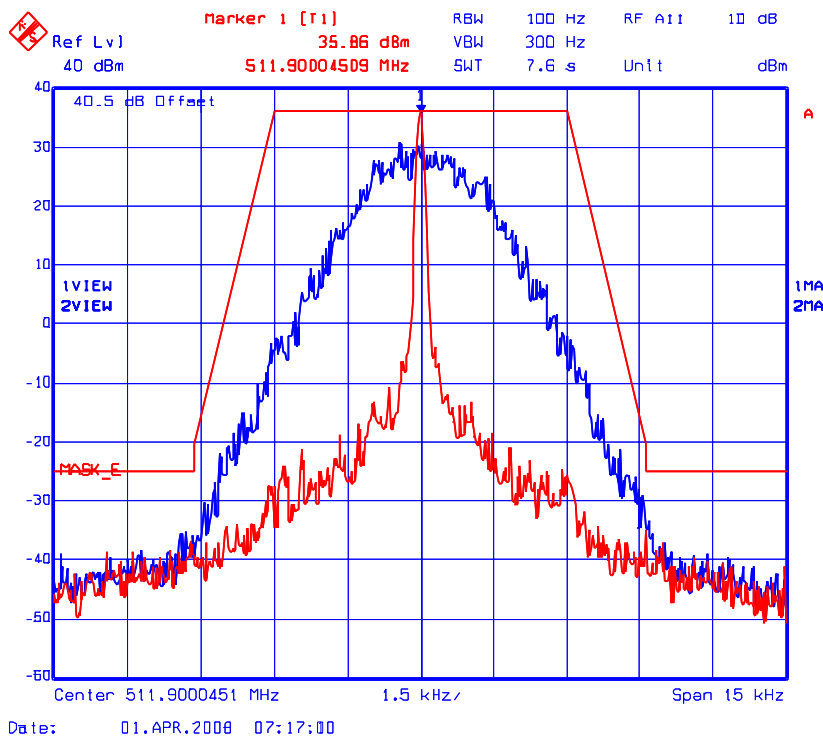

ULTRATECH GROUP OF LABS

3000 Bristol Circle, Oakville, Ontario, Canada L6H 6G4
Tel. #: 905-829-1570, Fax. #: 905-829-8050, Email: vic@ultratech-labs.com, Website: <http://www.ultratech-labs.com>

File #: ICOM-170F90
April 21, 2008

All test results contained in this engineering test report are traceable to National Institute of Standards and Technology (NIST)

Plot # 46.:
Emission Mask E
Carrier Frequency: 450.1 MHz
Channel Spacing: 6.25 KHz
Power: 50 W
Modulation: Analog

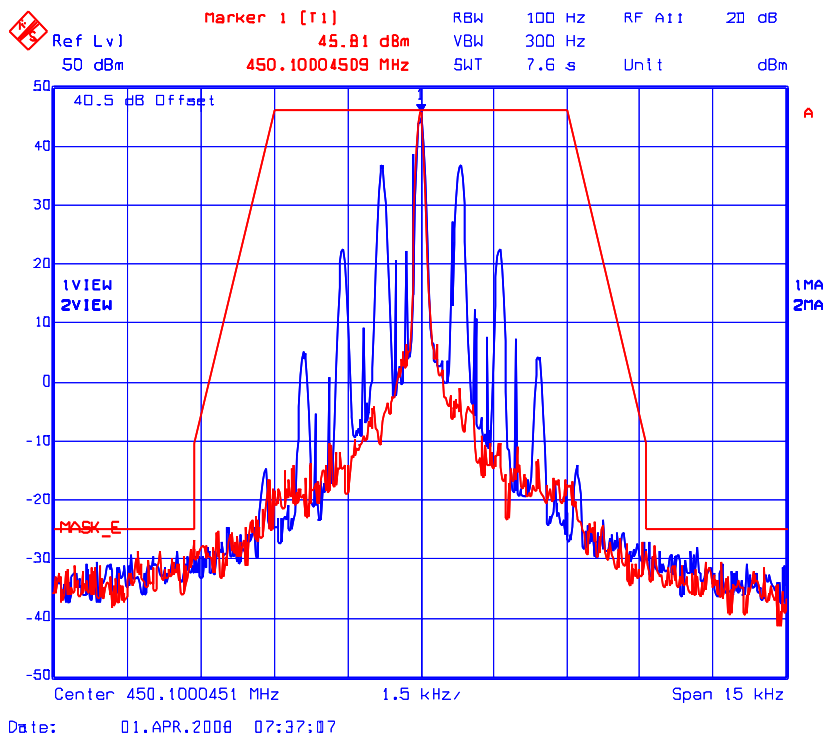

ULTRATECH GROUP OF LABS

3000 Bristol Circle, Oakville, Ontario, Canada L6H 6G4
Tel. #: 905-829-1570, Fax. #: 905-829-8050, Email: vic@ultratech-labs.com, Website: <http://www.ultratech-labs.com>

File #: ICOM-170F90
April 21, 2008

All test results contained in this engineering test report are traceable to National Institute of Standards and Technology (NIST)

Plot # 47.:
Emission Mask E
Carrier Frequency: 481.1 MHz
Channel Spacing: 6.25 KHz
Power: 50 W
Modulation: Analog

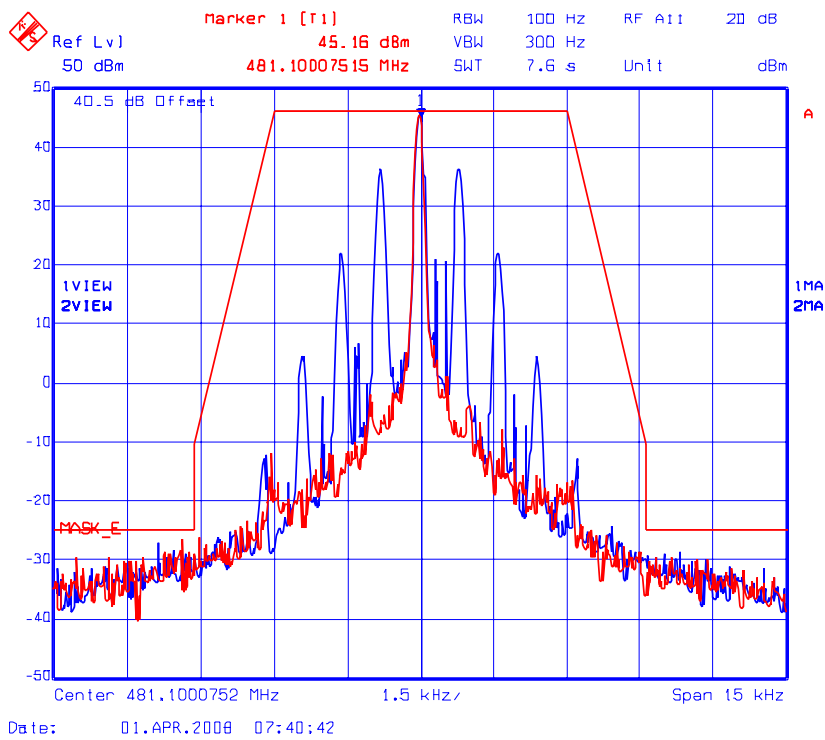

ULTRATECH GROUP OF LABS

3000 Bristol Circle, Oakville, Ontario, Canada L6H 6G4
Tel. #: 905-829-1570, Fax. #: 905-829-8050, Email: vic@ultratech-labs.com, Website: <http://www.ultratech-labs.com>

File #: ICOM-170F90
April 21, 2008

All test results contained in this engineering test report are traceable to National Institute of Standards and Technology (NIST)

Plot # 48.:
Emission Mask E
Carrier Frequency: 511.9 MHz
Channel Spacing: 6.25 KHz
Power: 50 W
Modulation: Analog

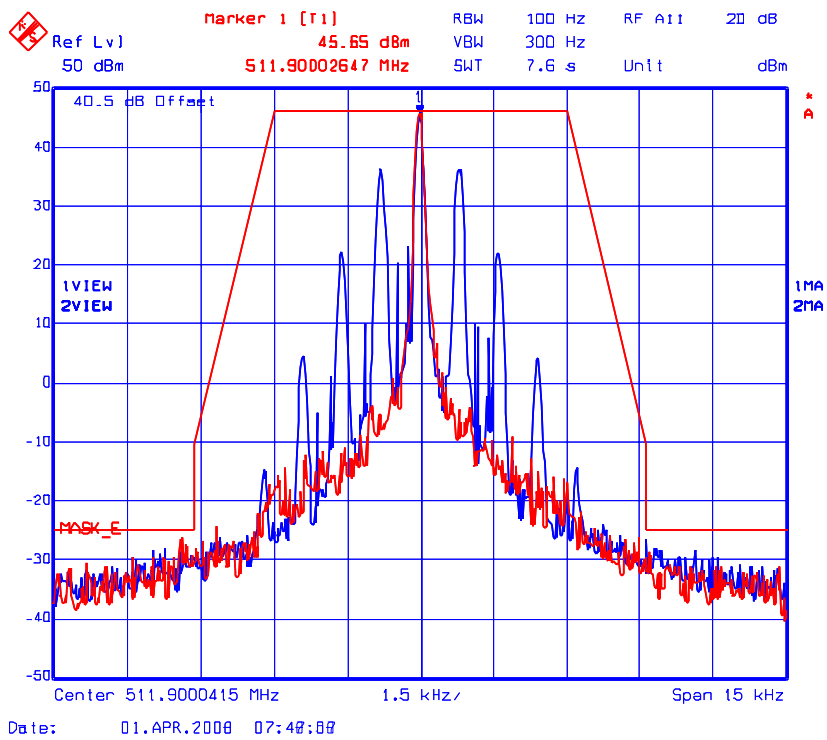

ULTRATECH GROUP OF LABS

3000 Bristol Circle, Oakville, Ontario, Canada L6H 6G4
Tel. #: 905-829-1570, Fax. #: 905-829-8050, Email: vic@ultratech-labs.com, Website: <http://www.ultratech-labs.com>

File #: ICOM-170F90
April 21, 2008

All test results contained in this engineering test report are traceable to National Institute of Standards and Technology (NIST)

Plot # 49.:
Emission Mask E
Carrier Frequency: 450.1 MHz
Channel Spacing: 6.25 KHz
Power: 5 W
Modulation: Analog

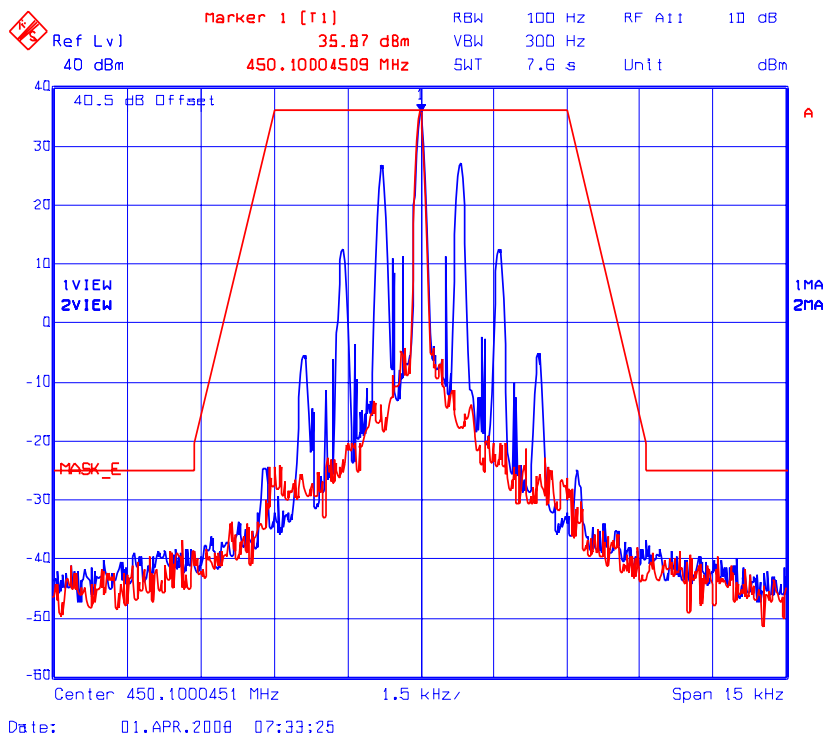

ULTRATECH GROUP OF LABS

3000 Bristol Circle, Oakville, Ontario, Canada L6H 6G4
Tel. #: 905-829-1570, Fax. #: 905-829-8050, Email: vic@ultratech-labs.com, Website: <http://www.ultratech-labs.com>

File #: ICOM-170F90
April 21, 2008

All test results contained in this engineering test report are traceable to National Institute of Standards and Technology (NIST)

Plot # 50.:
Emission Mask E
Carrier Frequency: 481.1 MHz
Channel Spacing: 6.25 KHz
Power: 5 W
Modulation: Analog

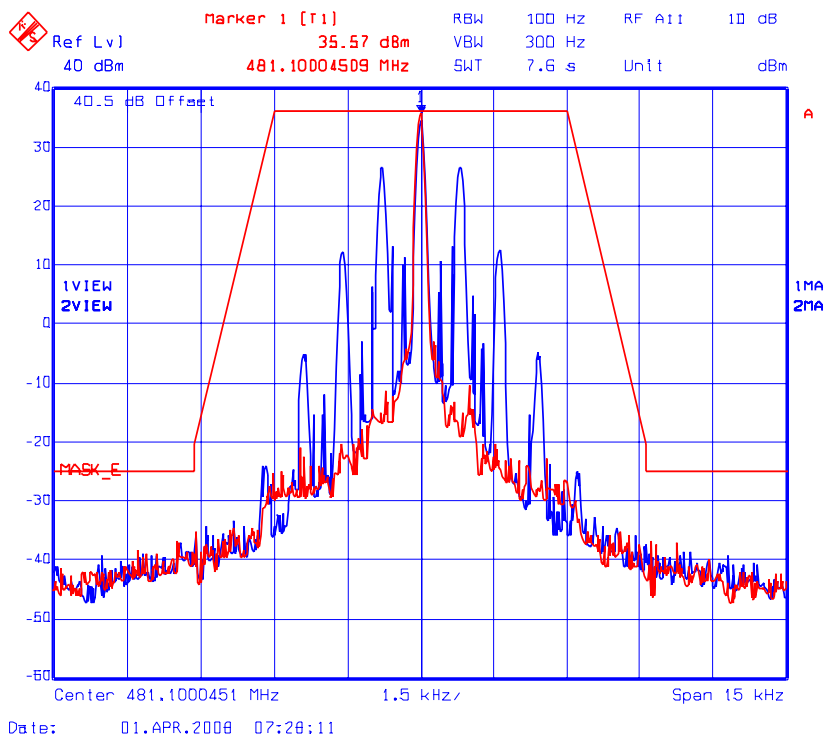

ULTRATECH GROUP OF LABS

3000 Bristol Circle, Oakville, Ontario, Canada L6H 6G4
Tel. #: 905-829-1570, Fax. #: 905-829-8050, Email: vic@ultratech-labs.com, Website: <http://www.ultratech-labs.com>

File #: ICOM-170F90
April 21, 2008

All test results contained in this engineering test report are traceable to National Institute of Standards and Technology (NIST)

Plot # 51.:
Emission Mask E
Carrier Frequency: 511.9 MHz
Channel Spacing: 6.25 KHz
Power: 5 W
Modulation: Analog

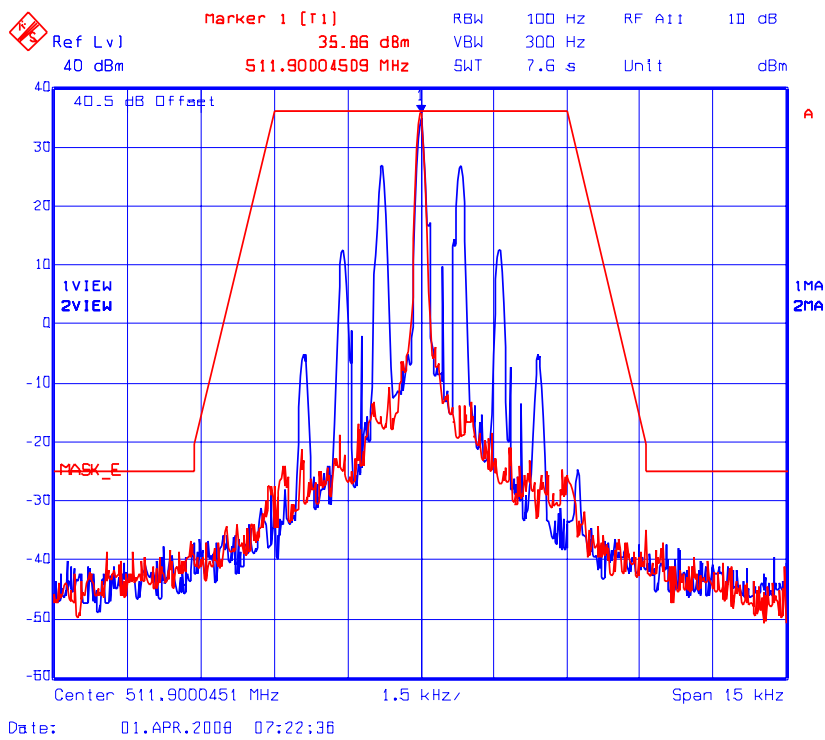

ULTRATECH GROUP OF LABS

3000 Bristol Circle, Oakville, Ontario, Canada L6H 6G4
Tel. #: 905-829-1570, Fax. #: 905-829-8050, Email: vic@ultratech-labs.com, Website: <http://www.ultratech-labs.com>

File #: ICOM-170F90
April 21, 2008

All test results contained in this engineering test report are traceable to National Institute of Standards and Technology (NIST)

6.10. TRANSMITTER ANTENNA POWER SPURIOUS/HARMONIC CONDUCTED EMISSIONS [§ 90.210]

6.10.1. Limits

Emissions shall be attenuated below the mean output power of the transmitter as follows:

FCC Rules	Frequency Range	Attenuation Limit (dBc)
90.210(b)	10 MHz to Lowest frequency of the radio to 10 th harmonic of the highest frequency of the radio	At least 43 + 10 log(P) or -13 dBm
90.210(d)	10 MHz to Lowest frequency of the radio to 10 th harmonic of the highest frequency of the radio	At least 50 + 10 log (P) dB or 70 dB, whichever is the lesser attenuation.
90.210(e)	10 MHz to Lowest frequency of the radio to 10 th harmonic of the highest frequency of the radio	At least 55 + 10 log (P) or 65 dB, whichever is the lesser attenuation.

6.10.2. Method of Measurements

Refer to Section 9.5 of this report for measurement details

6.10.3. Test Arrangement

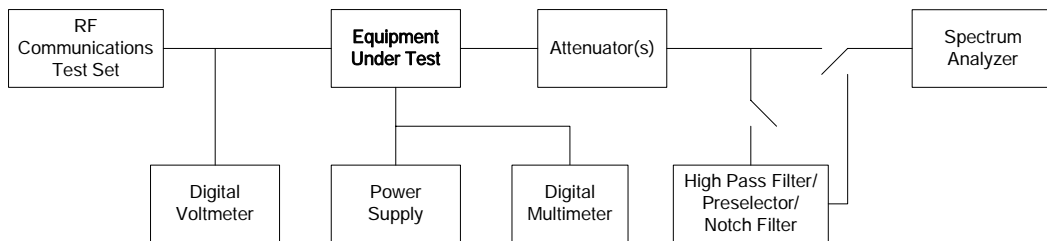

6.10.4. Test Data

Note: There was no difference in spurious/harmonic emissions on the pre-scans for different channel spacing and modulation types. Therefore, the rf spurious/harmonic emissions in this section would be performed for 6.25 KHz channel spacing and the more stringent limit of $55 + 10 \cdot \log(P)$ would be applied for worst case.

Plot # 52.:

Notch Filter Characteristics

450.1MHz, K&L 250-500MHz Tunable Bandreject Filter, P/N 3TNF-250/500-N, S/N UU041-1

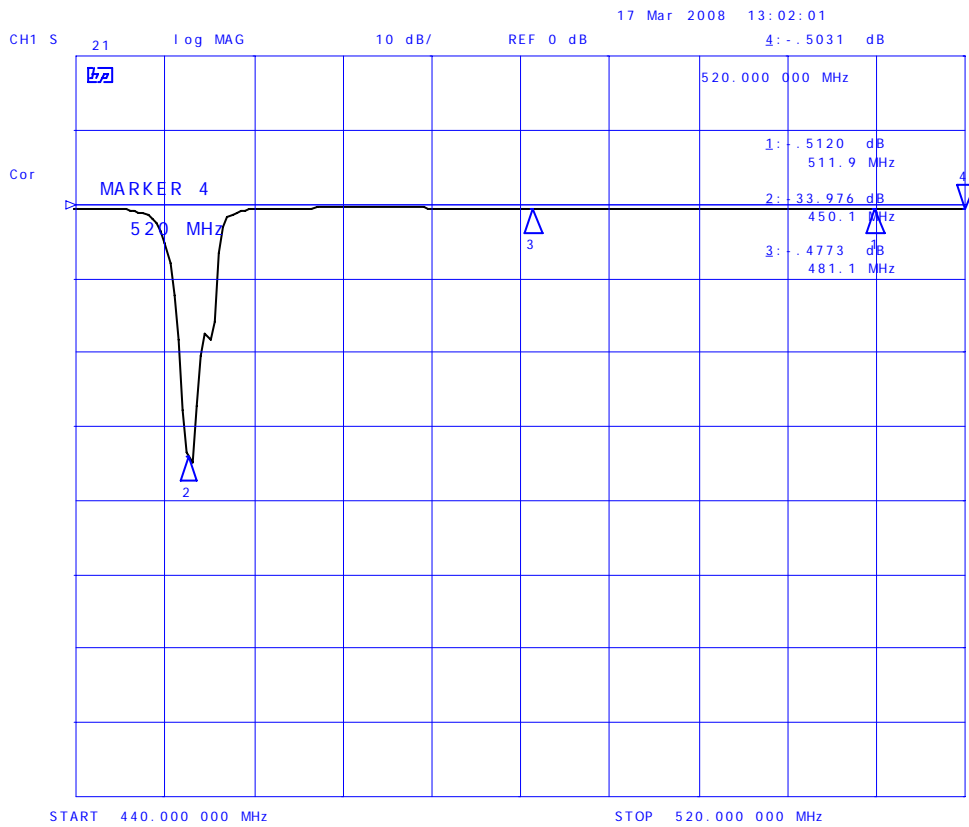

ULTRATECH GROUP OF LABS

3000 Bristol Circle, Oakville, Ontario, Canada L6H 6G4
Tel. #: 905-829-1570, Fax. #: 905-829-8050, Email: vic@ultratech-labs.com, Website: <http://www.ultratech-labs.com>

File #: ICOM-170F90
April 21, 2008

All test results contained in this engineering test report are traceable to National Institute of Standards and Technology (NIST)

Plot # 53.:
Notch Filter Characteristics
481.1MHz, K&L 250-500MHz Tunable Bandreject Filter, P/N 3TNF-250/500-N, S/N UU041-1

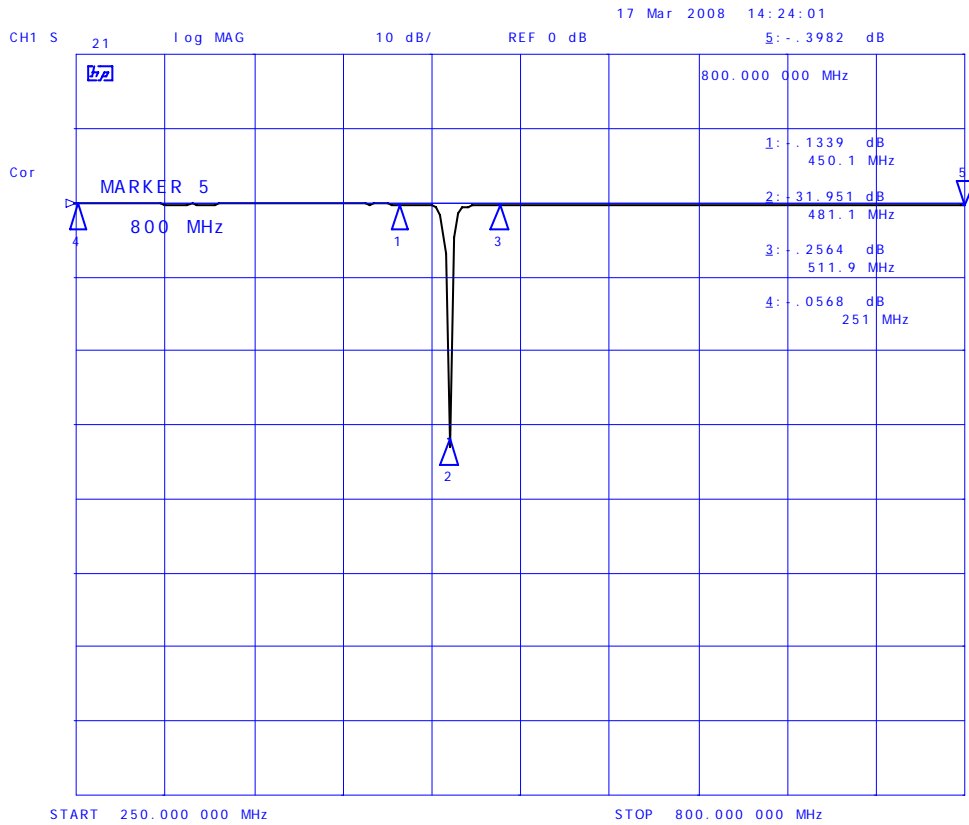

ULTRATECH GROUP OF LABS

3000 Bristol Circle, Oakville, Ontario, Canada L6H 6G4
Tel. #: 905-829-1570, Fax. #: 905-829-8050, Email: vic@ultratech-labs.com, Website: <http://www.ultratech-labs.com>

File #: ICOM-170F90
April 21, 2008

All test results contained in this engineering test report are traceable to National Institute of Standards and Technology (NIST)

Plot # 54.:
 Notch Filter Characteristics
 511.9MHz, K&L 500-1000MHz Tunable Bandreject Filter, P/N 3TNF-500/1000-N/N, S/N 470

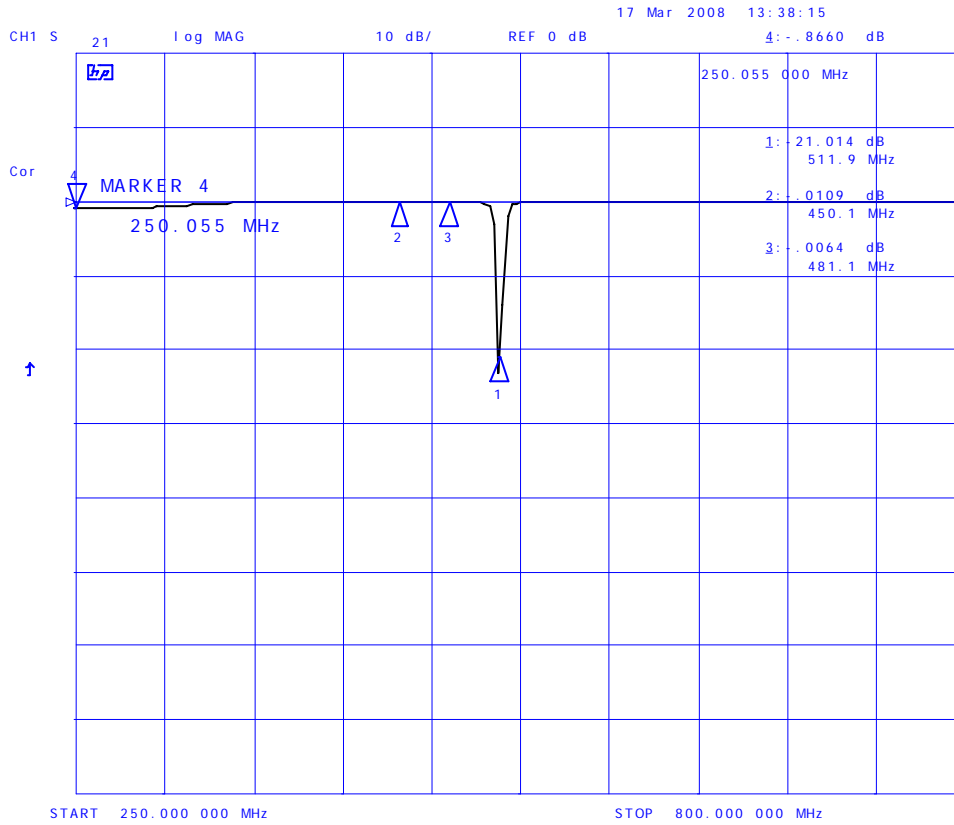

ULTRATECH GROUP OF LABS

3000 Bristol Circle, Oakville, Ontario, Canada L6H 6G4
 Tel. #: 905-829-1570, Fax. #: 905-829-8050, Email: vic@ultratech-labs.com, Website: <http://www.ultratech-labs.com>

File #: ICOM-170F90
 April 21, 2008

All test results contained in this engineering test report are traceable to National Institute of Standards and Technology (NIST)

6.10.4.1. Near Lowest Frequency (450.1 MHz)

Plot # 55.:
Spurious Emissions at Antenna Terminals
Carrier Frequency: 450.1 MHz
Channel Spacing: 6.25 KHz Power: 50 W Modulation: Digital
Comment: Advantest R3551 preselector and notch filter by-passed

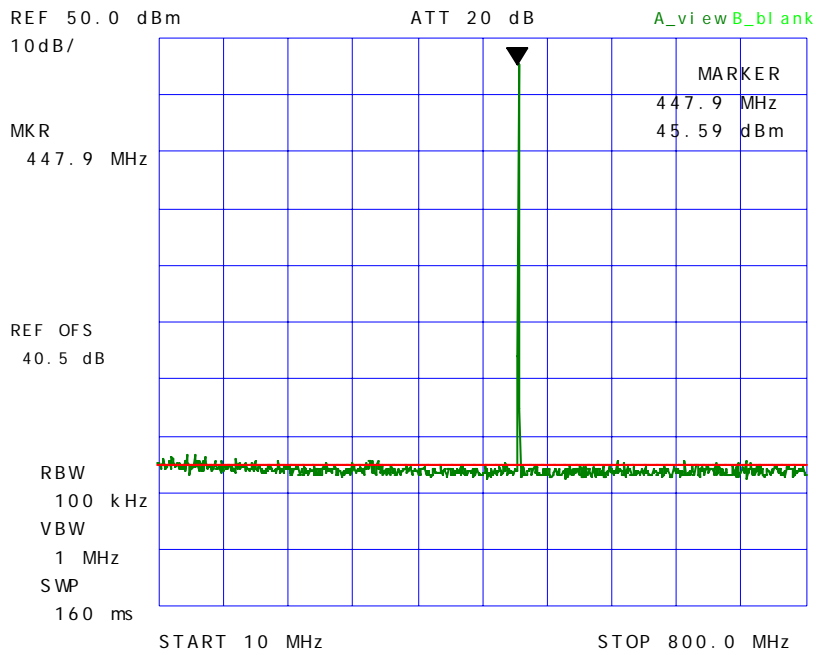

Plot # 56.:
Spurious Emissions at Antenna Terminals
Carrier Frequency: 450.1 MHz
Channel Spacing: 6.25 KHz Power: 50 W Modulation: Digital
Comment: Advantest R3551 preselector used for 10 MHz to 250 MHz band

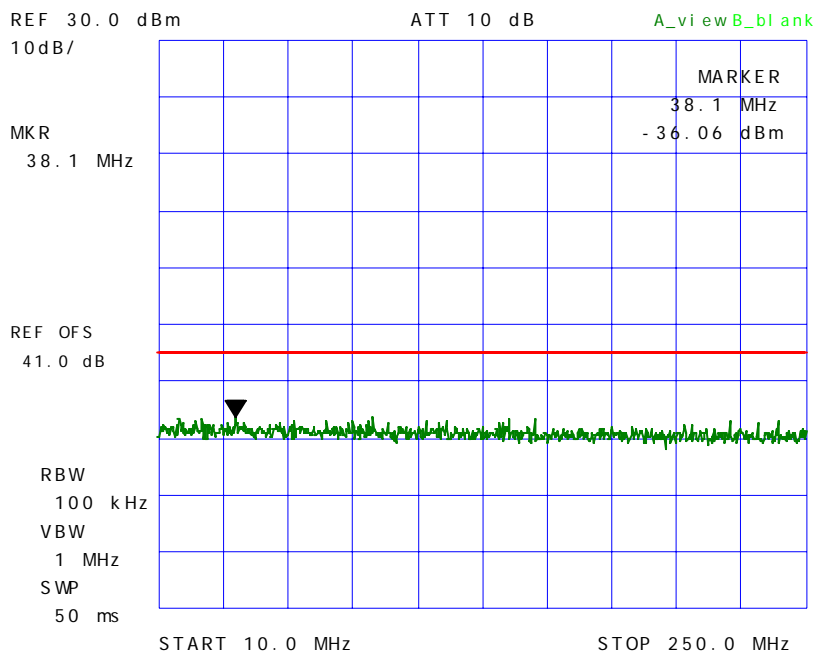

Plot # 57.:
Spurious Emissions at Antenna Terminals
Carrier Frequency: 450.1 MHz
Channel Spacing: 6.25 KHz Power: 50 W Modulation: Digital
Comment: Notch filter used for 250 MHz to 800 MHz band

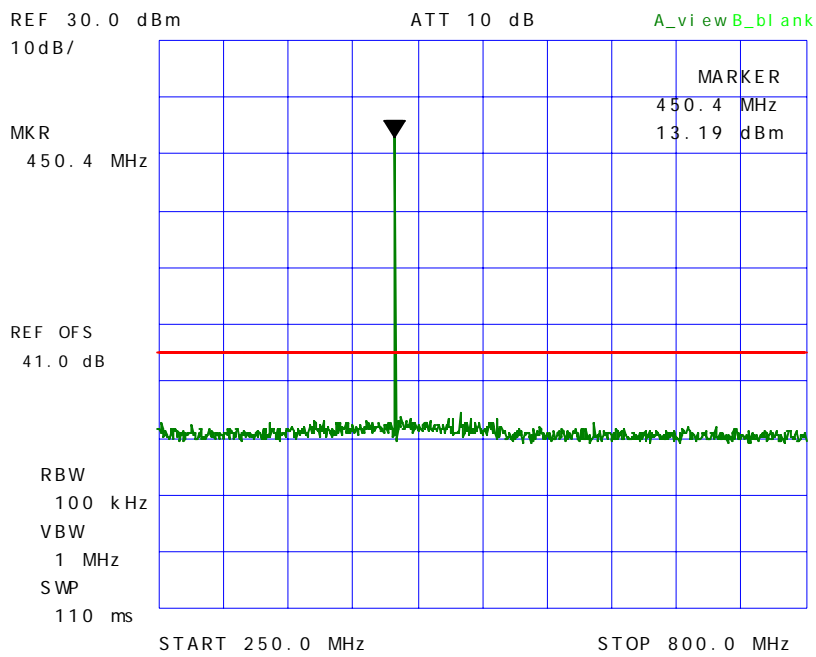

ULTRATECH GROUP OF LABS

3000 Bristol Circle, Oakville, Ontario, Canada L6H 6G4
Tel. #: 905-829-1570, Fax. #: 905-829-8050, Email: vic@ultratech-labs.com, Website: <http://www.ultratech-labs.com>

File #: ICOM-170F90
April 21, 2008

All test results contained in this engineering test report are traceable to National Institute of Standards and Technology (NIST)

Plot # 58.:
Spurious Emissions at Antenna Terminals
Carrier Frequency: 450.1 MHz
Channel Spacing: 6.25 KHz Power: 50 W Modulation: Digital
Comment: High pass filter used for frequency above 800 MHz

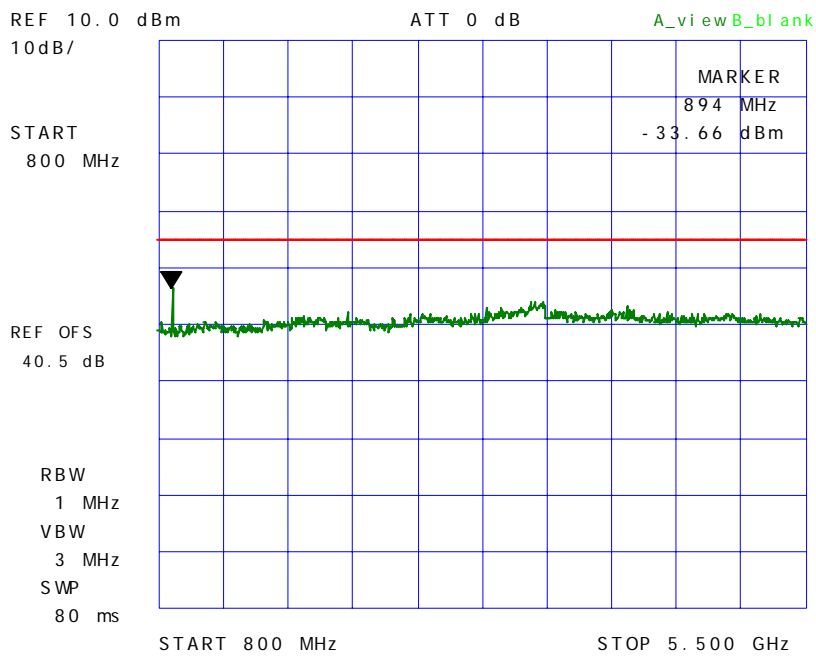

ULTRATECH GROUP OF LABS

3000 Bristol Circle, Oakville, Ontario, Canada L6H 6G4
Tel. #: 905-829-1570, Fax. #: 905-829-8050, Email: vic@ultratech-labs.com, Website: <http://www.ultratech-labs.com>

File #: ICOM-170F90
April 21, 2008

All test results contained in this engineering test report are traceable to National Institute of Standards and Technology (NIST)

Plot # 59.:
Spurious Emissions at Antenna Terminals
Carrier Frequency: 450.1 MHz
Channel Spacing: 6.25 KHz Power: 5 W Modulation: Digital

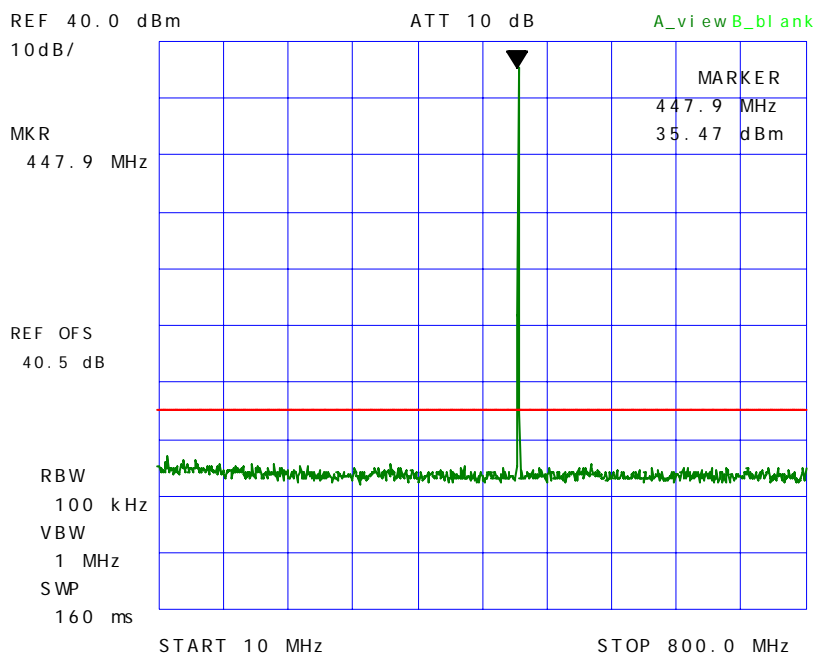

ULTRATECH GROUP OF LABS

3000 Bristol Circle, Oakville, Ontario, Canada L6H 6G4
Tel. #: 905-829-1570, Fax. #: 905-829-8050, Email: vic@ultratech-labs.com, Website: <http://www.ultratech-labs.com>

File #: ICOM-170F90
April 21, 2008

All test results contained in this engineering test report are traceable to National Institute of Standards and Technology (NIST)

Plot # 60.:
Spurious Emissions at Antenna Terminals
Carrier Frequency: 450.1 MHz
Channel Spacing: 6.25 KHz Power: 5 W Modulation: Digital

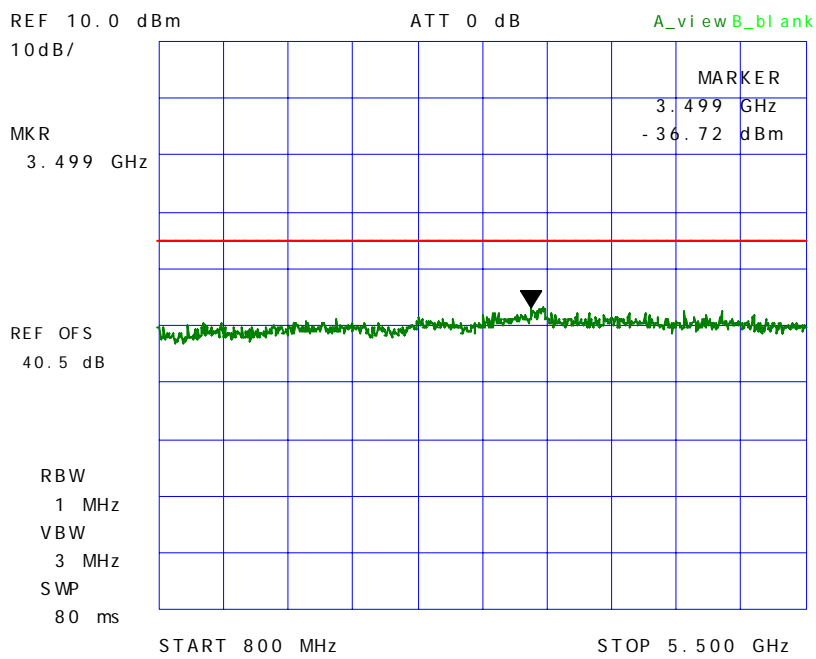

6.10.4.2. Near Middle Frequency (481.1 MHz)

Plot # 61.:
Spurious Emissions at Antenna Terminals
Carrier Frequency: 481.1 MHz
Channel Spacing: 6.25 KHz Power: 50 W Modulation: Digital
Comment: Advantest R3551 preselector and notch filter by-passed

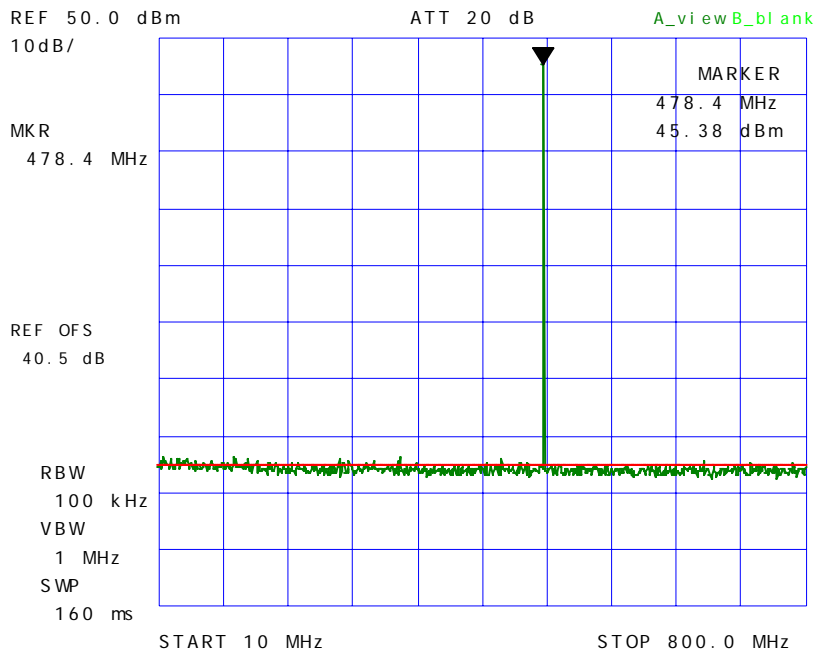

Plot # 62.:
Spurious Emissions at Antenna Terminals
Carrier Frequency: 481.1 MHz
Channel Spacing: 6.25 KHz Power: 50 W Modulation: Digital
Comment: Advantest R3551 preselector used for 10 MHz to 250 MHz band

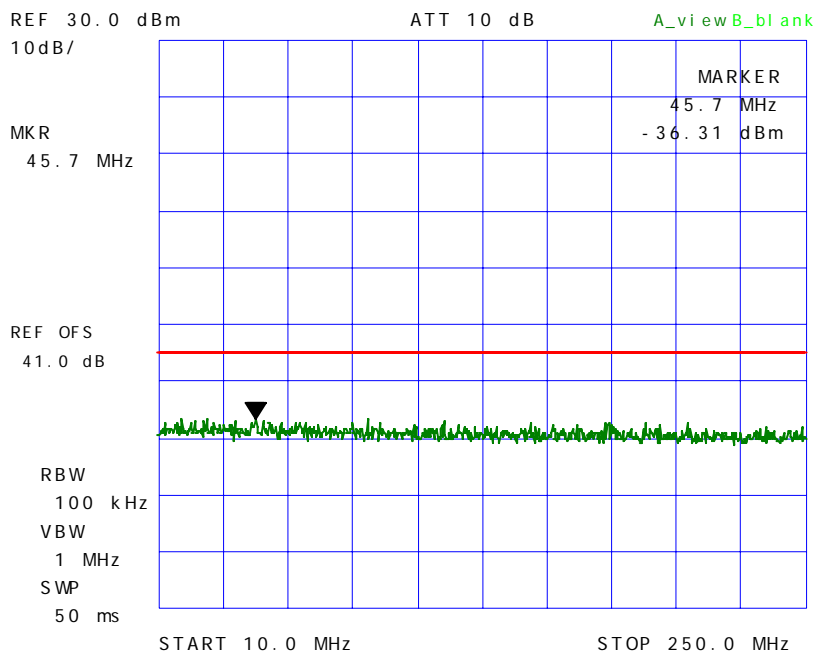

ULTRATECH GROUP OF LABS

3000 Bristol Circle, Oakville, Ontario, Canada L6H 6G4
Tel. #: 905-829-1570, Fax. #: 905-829-8050, Email: vic@ultratech-labs.com, Website: <http://www.ultratech-labs.com>

File #: ICOM-170F90
April 21, 2008

All test results contained in this engineering test report are traceable to National Institute of Standards and Technology (NIST)

Plot # 63.:
Spurious Emissions at Antenna Terminals
Carrier Frequency: 481.1 MHz
Channel Spacing: 6.25 KHz Power: 50 W Modulation: Digital
Comment: Notch filter used for 250 MHz to 800 MHz band

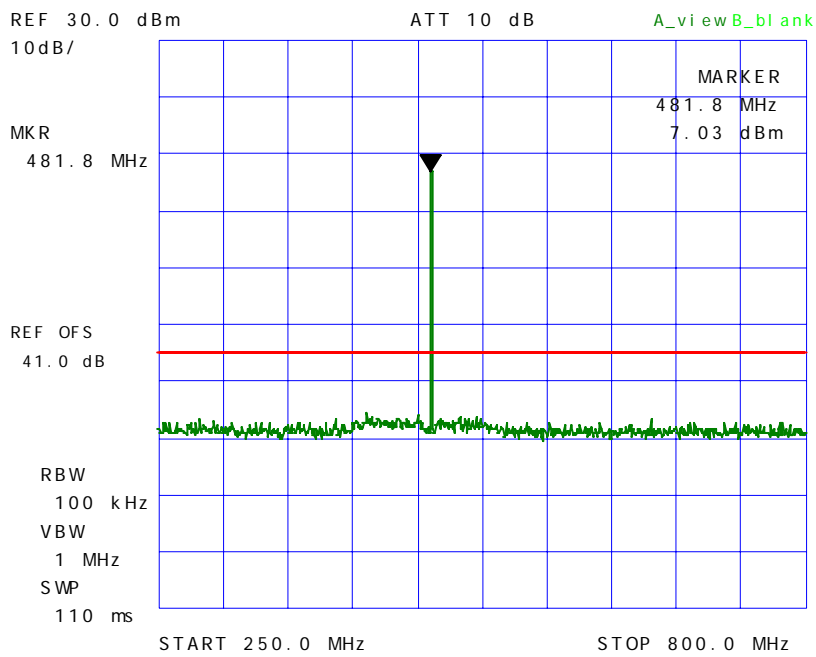

Plot # 64.:
Spurious Emissions at Antenna Terminals
Carrier Frequency: 481.1 MHz
Channel Spacing: 6.25 KHz Power: 50 W Modulation: Digital
Comment: High pass filter used for frequency above 800 MHz

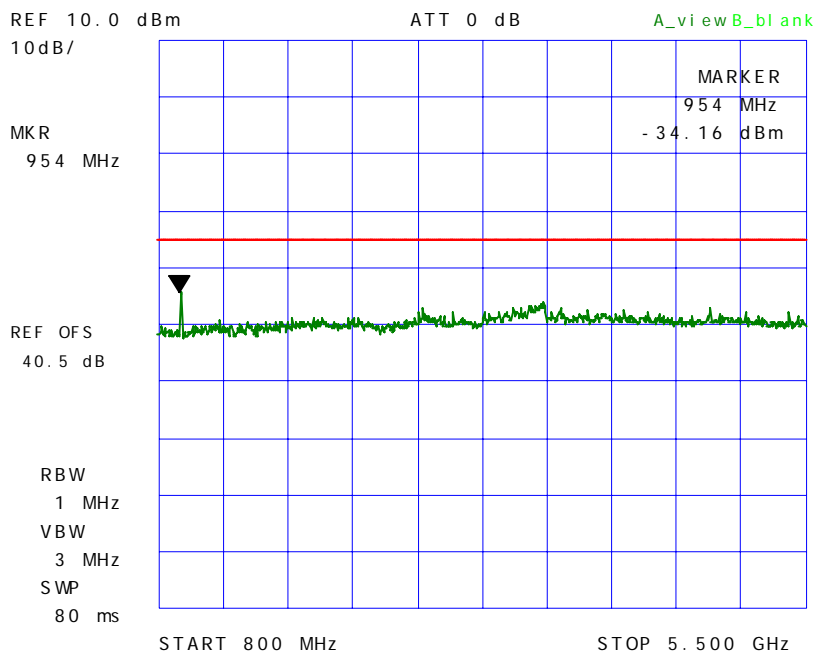

ULTRATECH GROUP OF LABS

3000 Bristol Circle, Oakville, Ontario, Canada L6H 6G4
Tel. #: 905-829-1570, Fax. #: 905-829-8050, Email: vic@ultratech-labs.com, Website: <http://www.ultratech-labs.com>

File #: ICOM-170F90
April 21, 2008

All test results contained in this engineering test report are traceable to National Institute of Standards and Technology (NIST)

Plot # 65.:
Spurious Emissions at Antenna Terminals
Carrier Frequency: 481.1 MHz
Channel Spacing: 6.25 KHz Power: 5 W Modulation: Digital

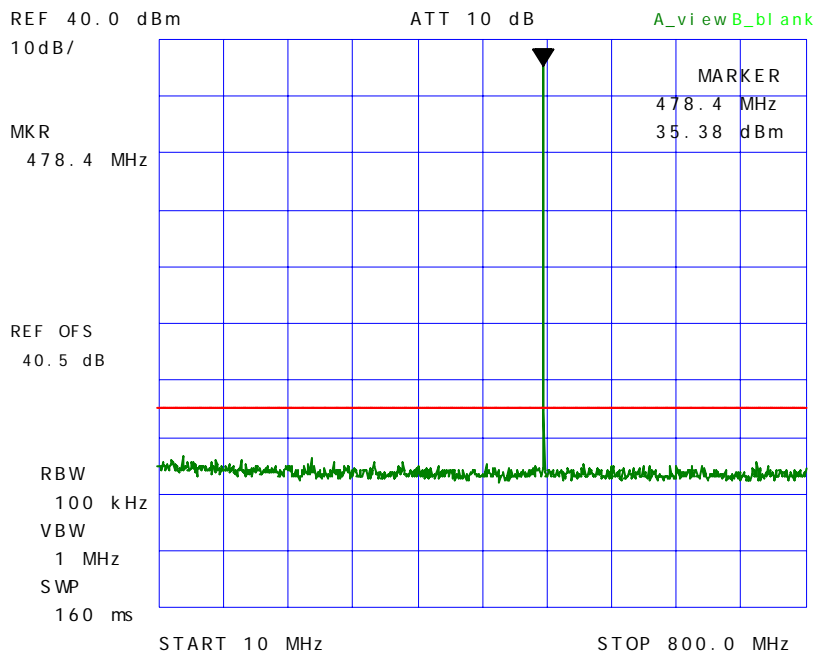

ULTRATECH GROUP OF LABS

3000 Bristol Circle, Oakville, Ontario, Canada L6H 6G4
Tel. #: 905-829-1570, Fax. #: 905-829-8050, Email: vic@ultratech-labs.com, Website: <http://www.ultratech-labs.com>

File #: ICOM-170F90
April 21, 2008

All test results contained in this engineering test report are traceable to National Institute of Standards and Technology (NIST)

Plot # 66.:
Spurious Emissions at Antenna Terminals
Carrier Frequency: 481.1 MHz
Channel Spacing: 6.25 KHz Power: 5 W Modulation: Digital

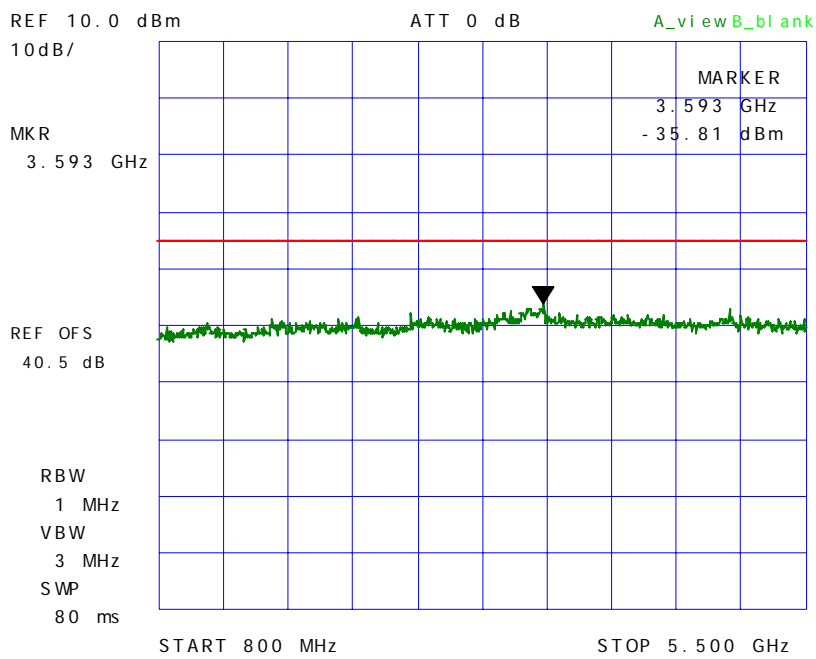

ULTRATECH GROUP OF LABS

3000 Bristol Circle, Oakville, Ontario, Canada L6H 6G4
Tel. #: 905-829-1570, Fax. #: 905-829-8050, Email: vic@ultratech-labs.com, Website: <http://www.ultratech-labs.com>

File #: ICOM-170F90
April 21, 2008

All test results contained in this engineering test report are traceable to National Institute of Standards and Technology (NIST)

6.10.4.3. Near Highest Frequency (511.9 MHz)

Plot # 67.:
Spurious Emissions at Antenna Terminals
Carrier Frequency: 511.9 MHz
Channel Spacing: 6.25 KHz Power: 50 W Modulation: Digital
Comment: Advantest R3551 preselector and notch filter by-passed

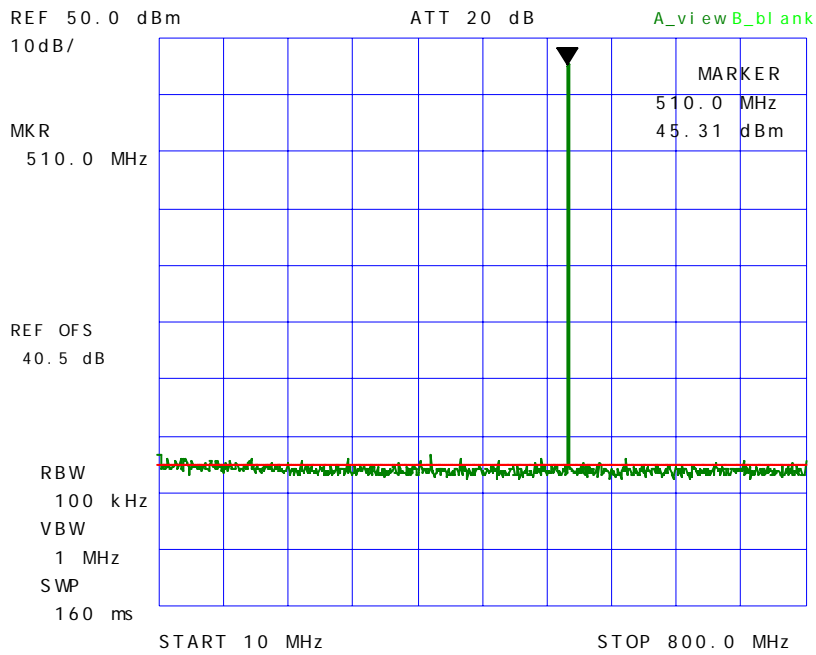

Plot # 68.:
Spurious Emissions at Antenna Terminals
Carrier Frequency: 511.9 MHz
Channel Spacing: 6.25 KHz Power: 50 W Modulation: Digital
Comment: Advantest R3551 preselector used for 10 MHz to 250 MHz band

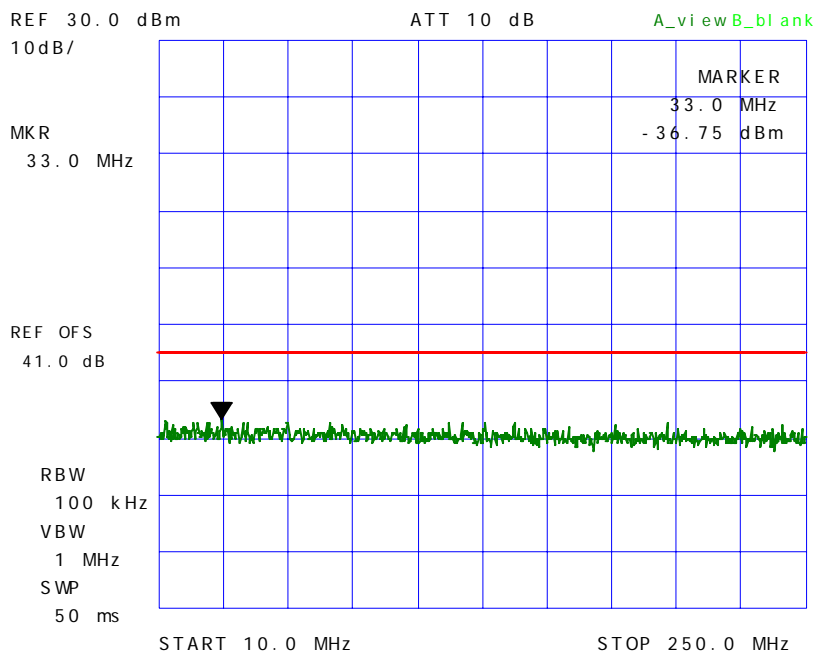

ULTRATECH GROUP OF LABS

3000 Bristol Circle, Oakville, Ontario, Canada L6H 6G4
Tel. #: 905-829-1570, Fax. #: 905-829-8050, Email: vic@ultratech-labs.com, Website: <http://www.ultratech-labs.com>

File #: ICOM-170F90
April 21, 2008

All test results contained in this engineering test report are traceable to National Institute of Standards and Technology (NIST)

Plot # 69.:
Spurious Emissions at Antenna Terminals
Carrier Frequency: 511.9 MHz
Channel Spacing: 6.25 KHz Power: 50 W Modulation: Digital
Comment: Notch filter used for 250 MHz to 800 MHz band

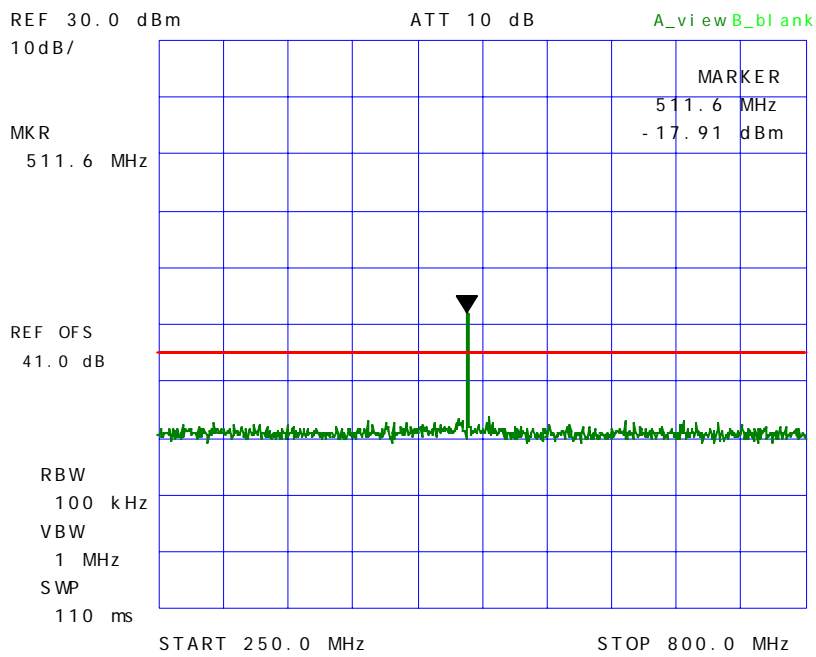

ULTRATECH GROUP OF LABS

3000 Bristol Circle, Oakville, Ontario, Canada L6H 6G4
Tel. #: 905-829-1570, Fax. #: 905-829-8050, Email: vic@ultratech-labs.com, Website: <http://www.ultratech-labs.com>

File #: ICOM-170F90
April 21, 2008

All test results contained in this engineering test report are traceable to National Institute of Standards and Technology (NIST)

Plot # 70.:
Spurious Emissions at Antenna Terminals
Carrier Frequency: 481.1 MHz
Channel Spacing: 511.9 KHz Power: 50 W Modulation: Digital
Comment: High pass filter used for frequency above 800 MHz

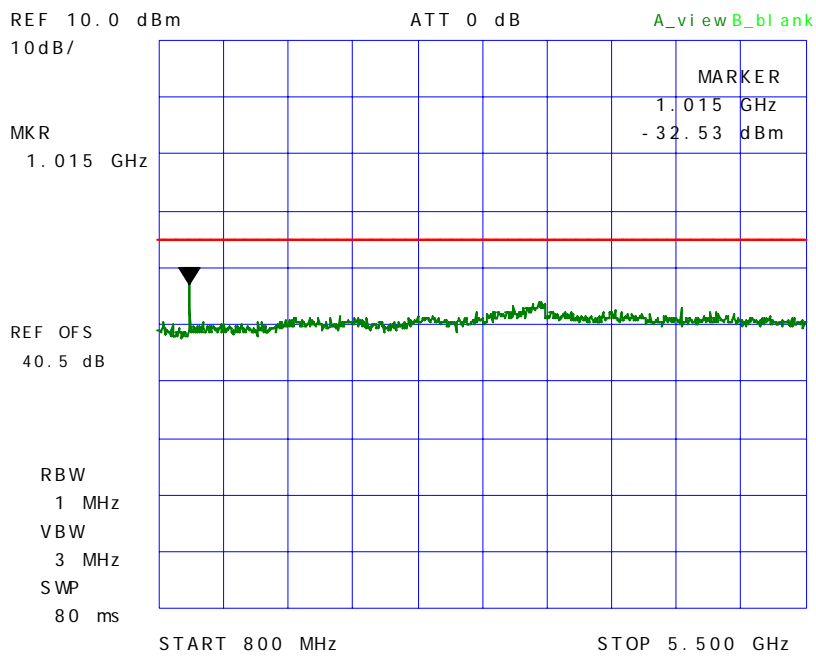

ULTRATECH GROUP OF LABS

3000 Bristol Circle, Oakville, Ontario, Canada L6H 6G4
Tel. #: 905-829-1570, Fax. #: 905-829-8050, Email: vic@ultratech-labs.com, Website: <http://www.ultratech-labs.com>

File #: ICOM-170F90
April 21, 2008

All test results contained in this engineering test report are traceable to National Institute of Standards and Technology (NIST)

Plot # 71.:
Spurious Emissions at Antenna Terminals
Carrier Frequency: 511.9 MHz
Channel Spacing: 6.25 KHz Power: 5 W Modulation: Digital

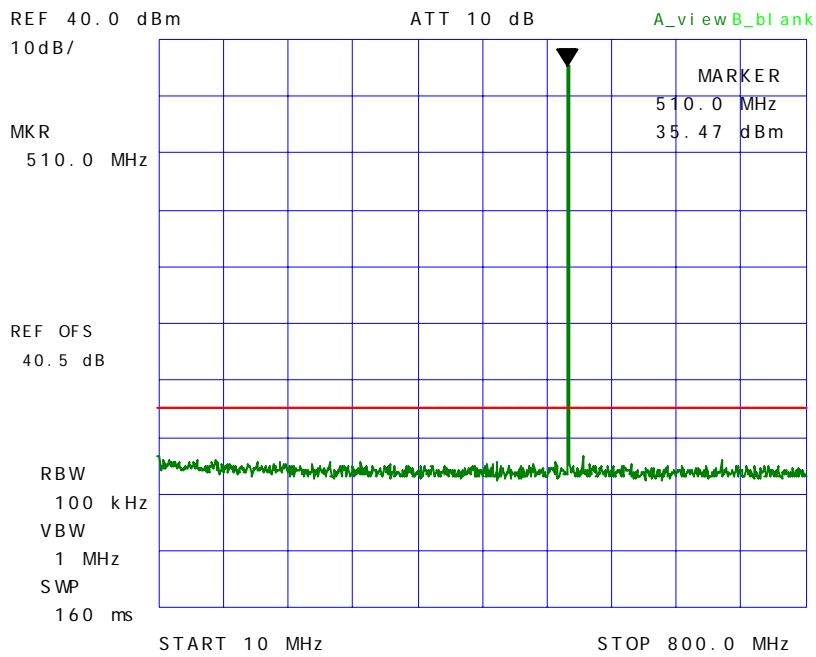

ULTRATECH GROUP OF LABS

3000 Bristol Circle, Oakville, Ontario, Canada L6H 6G4
Tel. #: 905-829-1570, Fax. #: 905-829-8050, Email: vic@ultratech-labs.com, Website: <http://www.ultratech-labs.com>

File #: ICOM-170F90
April 21, 2008

All test results contained in this engineering test report are traceable to National Institute of Standards and Technology (NIST)

Plot # 72.:
Spurious Emissions at Antenna Terminals
Carrier Frequency: 511.9MHz
Channel Spacing: 6.25 KHz Power: 5 W Modulation: Digital

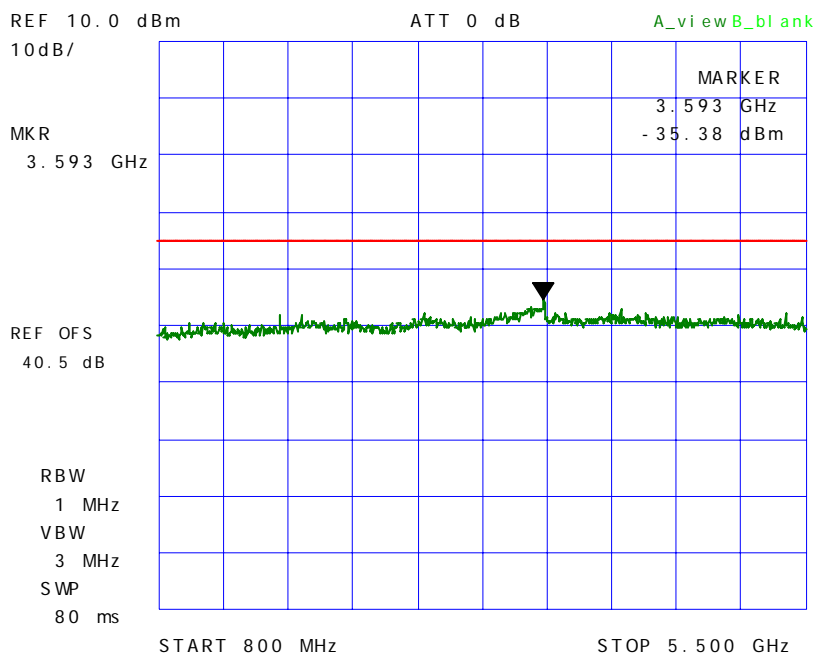

6.11. TRANSMITTER SPURIOUS/HARMONIC RADIATED EMISSIONS [§ 90.210]

6.11.1. Limits

Emissions shall be attenuated below the mean output power of the transmitter as follows:

FCC Rules	Frequency Range	Attenuation Limit (dBc)
90.210(b)	10 MHz to Lowest frequency of the radio to 10 th harmonic of the highest frequency of the radio	At least 43 + 10 log(P) or -13 dBm
90.210(d)	10 MHz to Lowest frequency of the radio to 10 th harmonic of the highest frequency of the radio	At least 50 + 10 log (P) dB or 70 dB, whichever is the lesser attenuation.
90.210(e)	10 MHz to Lowest frequency of the radio to 10 th harmonic of the highest frequency of the radio	At least 55 + 10 log (P) or 65 dB, whichever is the lesser attenuation.

6.11.2. Method of Measurements

The spurious/harmonic ERP measurements are using substitution method specified in Section 9.2 of this report.

6.11.3. Test Arrangement

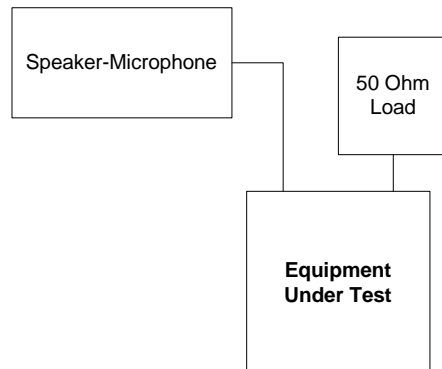

6.11.4. Test Data

Remarks:

- The RF spurious/harmonic emission characteristics for different channel spacing are indistinguishable. Therefore, the following radiated emissions were performed at 6.25 KHz channel spacing operation, and the results were compared with the more stringent limit of $55+10*\log(P \text{ in Watts})$ for the worst-case.
- The radiated emissions were performed with high power setting (50 Watts) at 3 meters distance to represents the worst-case test configuration.
- The emissions were scanned from 30 MHz to 10th harmonics; all emissions within 20 dB below the limits were recorded.

6.11.4.1. Near Lowest Frequency (450.1 MHz)

Carrier Frequency (MHz): 450.1
Power_{conducted} (dBm): 46.88
Limit (dBm): -25

Frequency (MHz)	E-Field (dBµV/m)	EMI Detector (Peak/QP)	Antenna Polarization (H/V)	ERP measured (dBm)	Limit (dBm)	Margin (dB)
450.10	--	--	--	--	--	--
450.10	--	--	--	--	--	--
900.20	47.26	Peak	V	-55.85	-25	-30.9
900.20	53.79	Peak	H	-49.32	-25	-24.3
1350.30	46.17	Peak	V	-59.78	-25	-34.8
1350.30	51.64	Peak	H	-54.31	-25	-29.3
1800.40	41.13	Peak	V	-61.24	-25	-36.2
1800.40	42.71	Peak	H	-59.66	-25	-34.7
2250.50	54.94	Peak	V	-47.02	-25	-22.0
2250.50	52.05	Peak	H	-49.91	-25	-24.9
2700.60	54.29	Peak	V	-47.53	-25	-22.5
2700.60	51.13	Peak	H	-50.69	-25	-25.7
3150.70	47.74	Peak	V	-56.86	-25	-31.9
3150.70	48.34	Peak	H	-56.26	-25	-31.3
3600.80	62.89	Peak	V	-40.78	-25	-15.8
3600.80	66.38	Peak	H	-37.29	-25	-12.3
4050.90	53.81	Peak	V	-48.97	-25	-24.0
4050.90	54.77	Peak	H	-48.01	-25	-23.0
4501.00	53.89	Peak	V	-49.67	-25	-24.7
4501.00	59.53	Peak	H	-44.03	-25	-19.0

6.11.4.2. Near Middle Frequency (481.1 MHz)

Carrier Frequency (MHz): 481.1
 Power_{conducted} (dBm): 46.74
 Limit (dBm): -25

Frequency (MHz)	E-Field (dBμV/m)	EMI Detector (Peak/QP)	Antenna Polarization (H/V)	ERP measured (dBm)	Limit (dBm)	Margin (dB)
481.10	--	--	--	--	--	--
481.10	--	--	--	--	--	--
962.20	33.60	Peak	V	-69.51	-25	-44.5
962.20	34.53	Peak	H	-68.58	-25	-43.6
1443.30	49.75	Peak	V	-56.20	-25	-31.2
1443.30	45.24	Peak	H	-60.71	-25	-35.7
1924.40	41.88	Peak	V	-60.49	-25	-35.5
1924.40	41.41	Peak	H	-60.96	-25	-36.0
2405.50	54.96	Peak	V	-47.00	-25	-22.0
2405.50	49.12	Peak	H	-52.84	-25	-27.8
2886.60	46.70	Peak	V	-55.12	-25	-30.1
2886.60	43.50	Peak	H	-58.32	-25	-33.3
3367.70	52.56	Peak	V	-52.04	-25	-27.0
3367.70	51.63	Peak	H	-52.97	-25	-28.0
3848.80	58.02	Peak	V	-45.65	-25	-20.7
3848.80	53.22	Peak	H	-50.45	-25	-25.5
4329.90	52.01	Peak	V	-50.77	-25	-25.8
4329.90	52.69	Peak	H	-50.09	-25	-25.1
4811.00	59.15	Peak	V	-44.41	-25	-19.4
4811.00	54.25	Peak	H	-49.31	-25	-24.3

6.11.4.3. Near Highest Frequency (511.9 MHz)

Carrier Frequency (MHz): 511.9
 Power_{conducted} (dBm): 46.72
 Limit (dBm): -25

Frequency (MHz)	E-Field (dBμV/m)	EMI Detector (Peak/QP)	Antenna Polarization (H/V)	ERP measured (dBm)	Limit (dBm)	Margin (dB)
511.90	--	--	--	--	--	--
511.90	--	--	--	--	--	--
1023.80	53.00	Peak	V	-50.13	-25	-25.1
1023.80	53.57	Peak	H	-49.56	-25	-24.6
1535.70	45.35	Peak	V	-57.15	-25	-32.2
1535.70	40.46	Peak	H	-62.04	-25	-37.0
2047.60	44.40	Peak	V	-58.59	-25	-33.6
2047.60	43.36	Peak	H	-59.63	-25	-34.6
2559.50	54.91	Peak	V	-48.09	-25	-23.1
2559.50	51.02	Peak	H	-51.98	-25	-27.0
3071.40	51.37	Peak	V	-49.99	-25	-25.0
3071.40	51.79	Peak	H	-49.57	-25	-24.6
3583.30	65.00	Peak	V	-36.44	-25	-11.4
3583.30	68.71	Peak	H	-32.73	-25	-7.7
4095.20	57.63	Peak	V	-44.76	-25	-19.8
4095.20	61.53	Peak	H	-40.86	-25	-15.9
4607.10	63.06	Peak	V	-42.57	-25	-17.6
4607.10	66.45	Peak	H	-39.18	-25	-14.2
5119.00	61.08	Peak	V	-41.77	-25	-16.8
5119.00	58.48	Peak	H	-44.37	-25	-19.4

6.12. TRANSIENT FREQUENCY BEHAVIOR [§ 90.214]

6.12.1. Limits

Transient frequencies must be within the maximum frequency difference limits during the time intervals indicated:

Time intervals ^{1, 2}	Maximum frequency difference ³	All equipment	
		150 to 174 MHz	421 to 512MHz
Transient Frequency Behavior for Equipment Designed to Operate on 25 KHz Channels			
t ₁ ⁴	± 25.0 KHz	5.0 ms	10.0 ms
t ₂	± 12.5 KHz	20.0 ms	25.0 ms
t ₃ ⁴	± 25.0 KHz	5.0 ms	10.0 ms
Transient Frequency Behavior for Equipment Designed to Operate on 12.5 KHz Channels			
t ₁ ⁴	± 12.5 KHz	5.0 ms	10.0 ms
t ₂	± 6.25 KHz	20.0 ms	25.0 ms
t ₃ ⁴	± 12.5 KHz	5.0 ms	10.0 ms
Transient Frequency Behavior for Equipment Designed to Operate on 6.25 KHz Channels			
t ₁ ⁴	±6.25 KHz	5.0 ms	10.0 ms
t ₂	±3.125 KHz	20.0 ms	25.0 ms
t ₃ ⁴	±6.25 KHz	5.0 ms	10.0 ms

- t_{on} is the instant when a 1 KHz test signal is completely suppressed, including any capture time due to phasing.
 t₁ is the time period immediately following t_{on}.
 t₂ is the time period immediately following t₁.
 t₃ is the time period from the instant when the transmitter is turned off until t_{off}.
 t_{off} is the instant when the 1 KHz test signal starts to rise.
- During the time from the end of t₂ to the beginning of t₃, the frequency difference must not exceed the limits specified in § 90.213.
- Difference between the actual transmitter frequency and the assigned transmitter frequency.
- If the transmitter carrier output power rating is 6 watts or less, the frequency difference during this time period may exceed the maximum frequency difference for this time period.

6.12.2. Method of Measurements

Refer to Section 9.6 of this test report and ANSI/TIA/EIA-603-B-2002, Section 2.2.19.

6.12.3. Test Arrangement

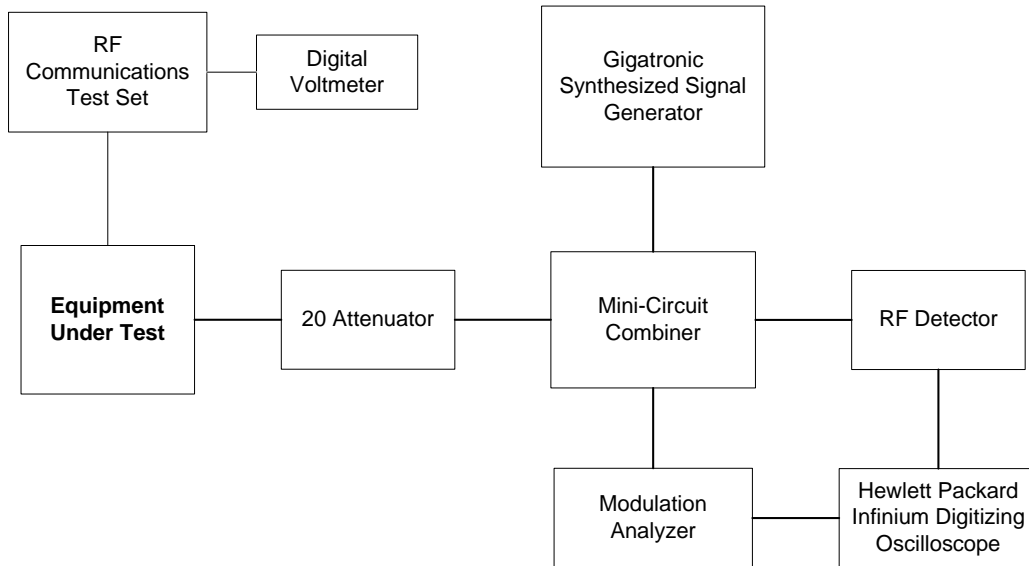

6.12.4. Test Data

6.12.4.1. Transient Frequency Behavior for 25 KHz Channel Spacing

Plot # 73.:
Transient Frequency Behavior
Carrier Frequency: 450.1 MHz
Channel Spacing: 25 KHz
Power: 50 W
Description: Switch on condition t_{on} , t_1 , and t_2

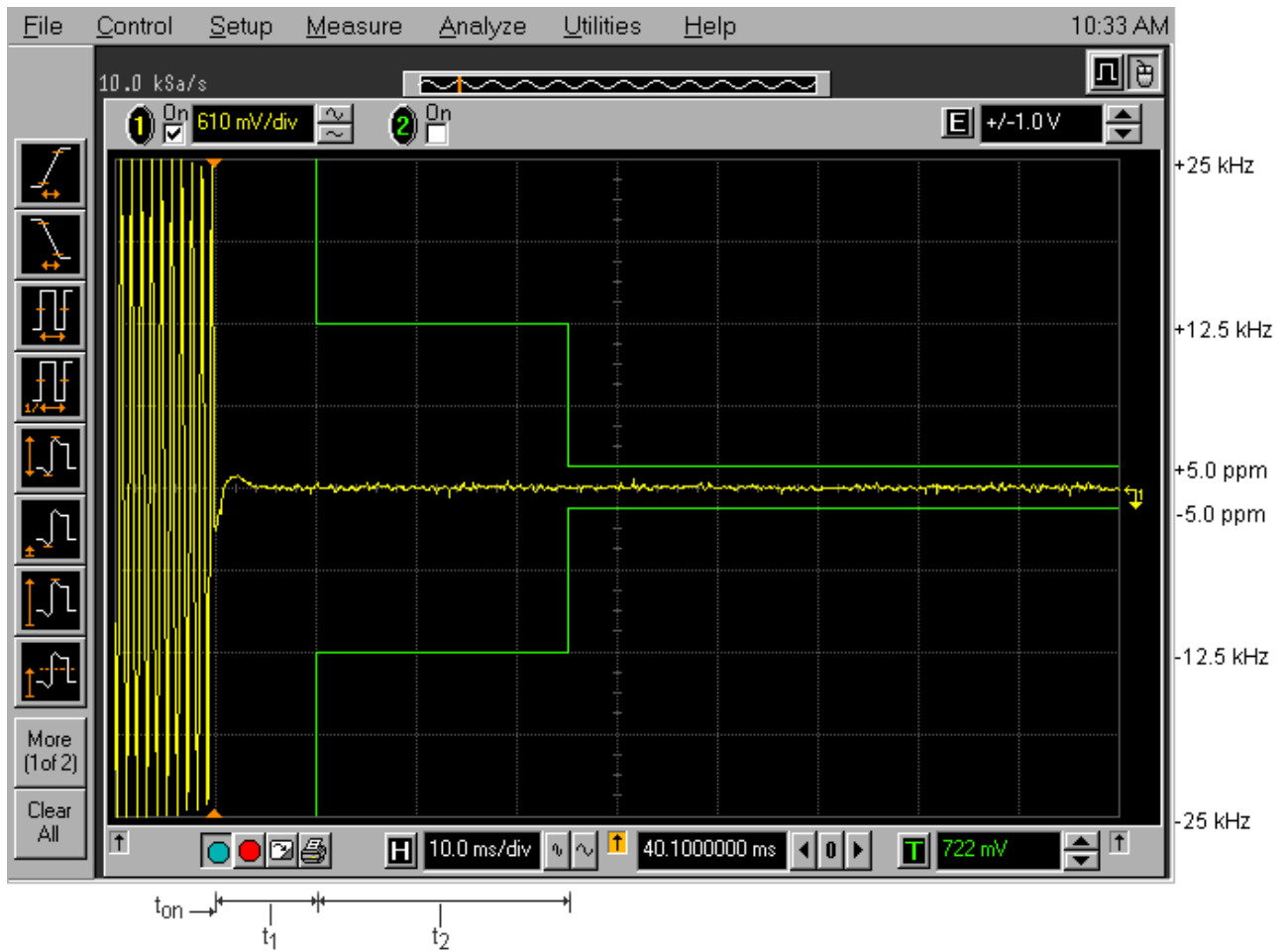

ULTRATECH GROUP OF LABS

3000 Bristol Circle, Oakville, Ontario, Canada L6H 6G4
Tel. #: 905-829-1570, Fax. #: 905-829-8050, Email: vic@ultratech-labs.com, Website: <http://www.ultratech-labs.com>

File #: ICOM-170F90
April 21, 2008

All test results contained in this engineering test report are traceable to National Institute of Standards and Technology (NIST)

Plot # 74.:
Transient Frequency Behavior
Carrier Frequency: 450.1 MHz
Channel Spacing: 25 KHz
Power: 50 W
Description: Switch off condition t_3 , t_{off}

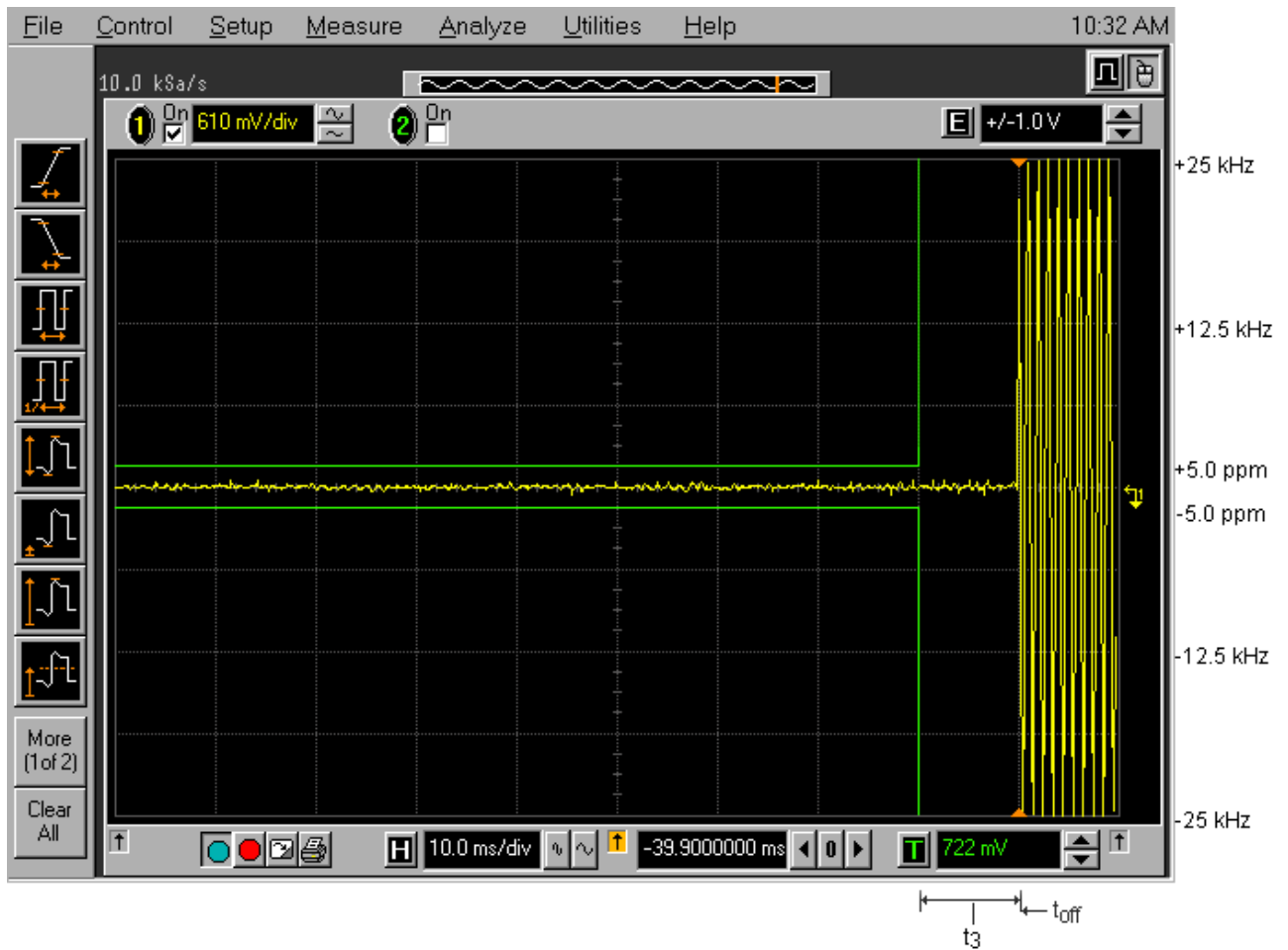

ULTRATECH GROUP OF LABS

3000 Bristol Circle, Oakville, Ontario, Canada L6H 6G4
Tel. #: 905-829-1570, Fax. #: 905-829-8050, Email: vic@ultratech-labs.com, Website: <http://www.ultratech-labs.com>

File #: ICOM-170F90
April 21, 2008

All test results contained in this engineering test report are traceable to National Institute of Standards and Technology (NIST)

6.12.4.2. Transient Frequency Behavior for 12.5 KHz Channel Spacing

Plot # 75.:
Transient Frequency Behavior
Carrier Frequency: 450.1 MHz
Channel Spacing: 12.5 KHz
Power: 50 W
Description: Switch on condition t_{on} , t_1 , and t_2

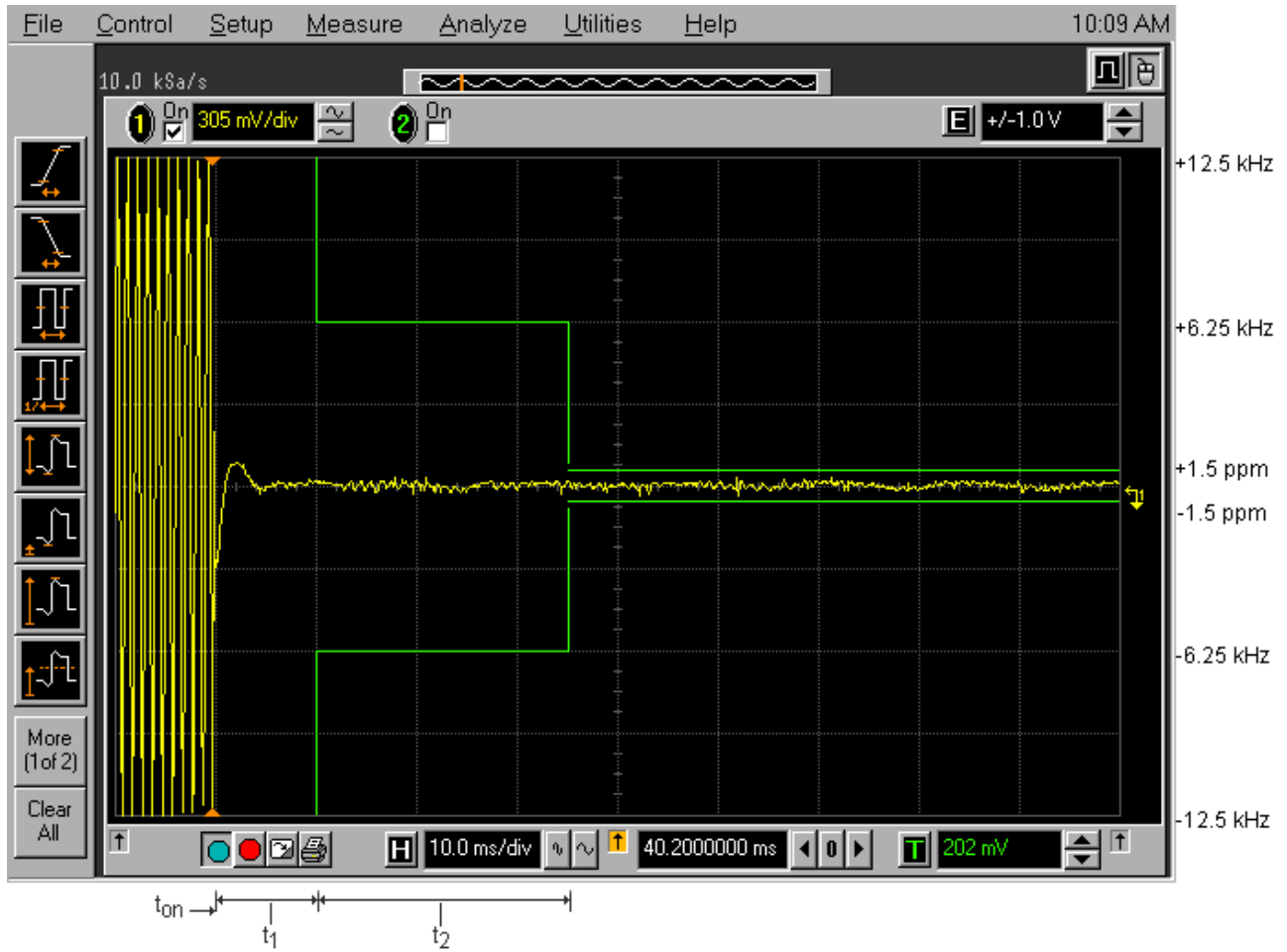

Plot # 76.:
Transient Frequency Behavior
Carrier Frequency: 450.1 MHz
Channel Spacing: 12.5 KHz
Power: 50 W
Description: Switch off condition t_3 , t_{off}

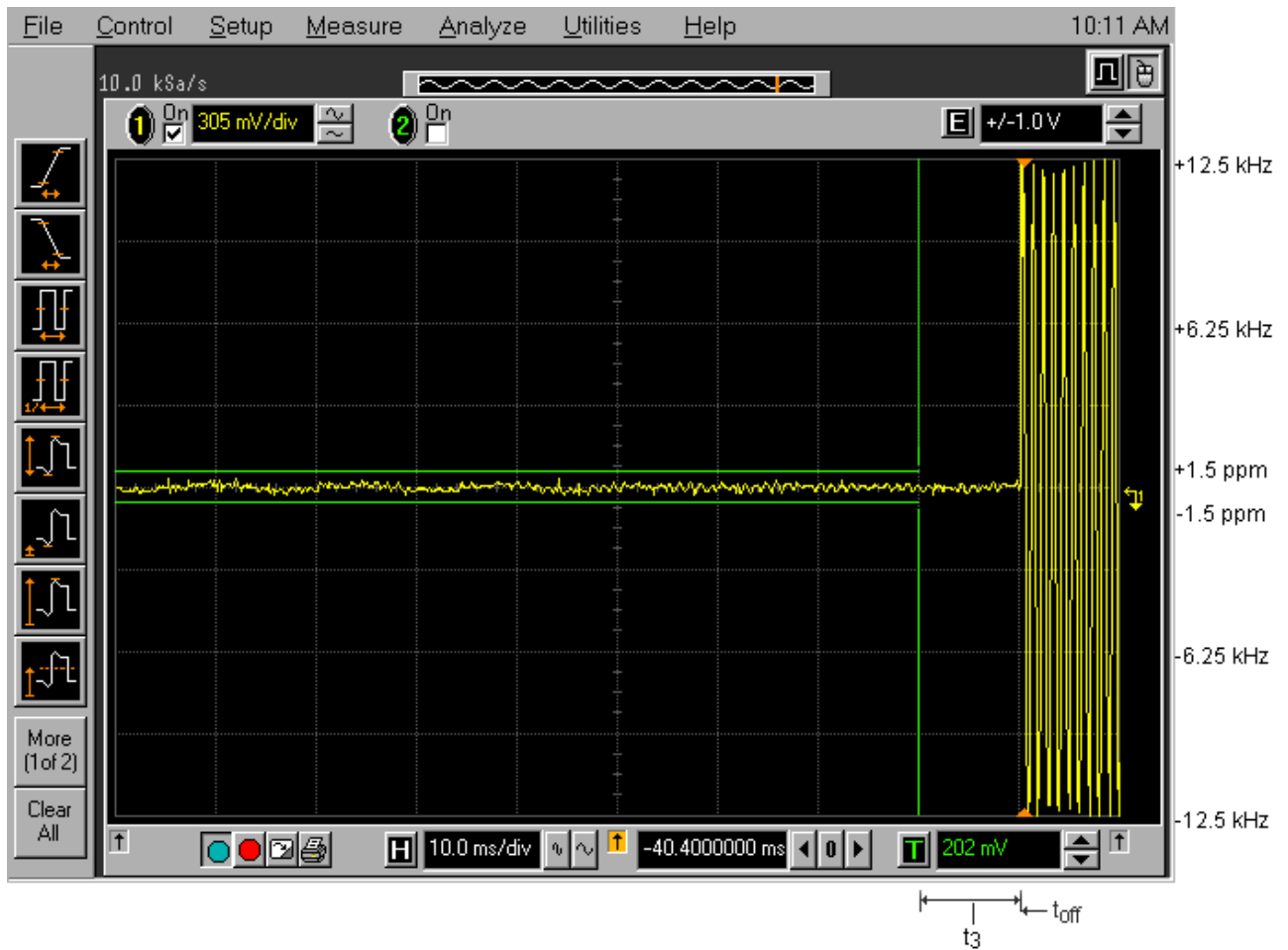

ULTRATECH GROUP OF LABS

3000 Bristol Circle, Oakville, Ontario, Canada L6H 6G4
Tel. #: 905-829-1570, Fax. #: 905-829-8050, Email: vic@ultratech-labs.com, Website: <http://www.ultratech-labs.com>

File #: ICOM-170F90
April 21, 2008

All test results contained in this engineering test report are traceable to National Institute of Standards and Technology (NIST)

6.12.4.3. Transient Frequency Behavior for 6.25 KHz Channel Spacing

Plot # 77.:
Transient Frequency Behavior
Carrier Frequency: 450.1 MHz
Channel Spacing: 6.25 KHz
Power: 50 W
Description: Switch on condition t_{on} , t_1 , and t_2

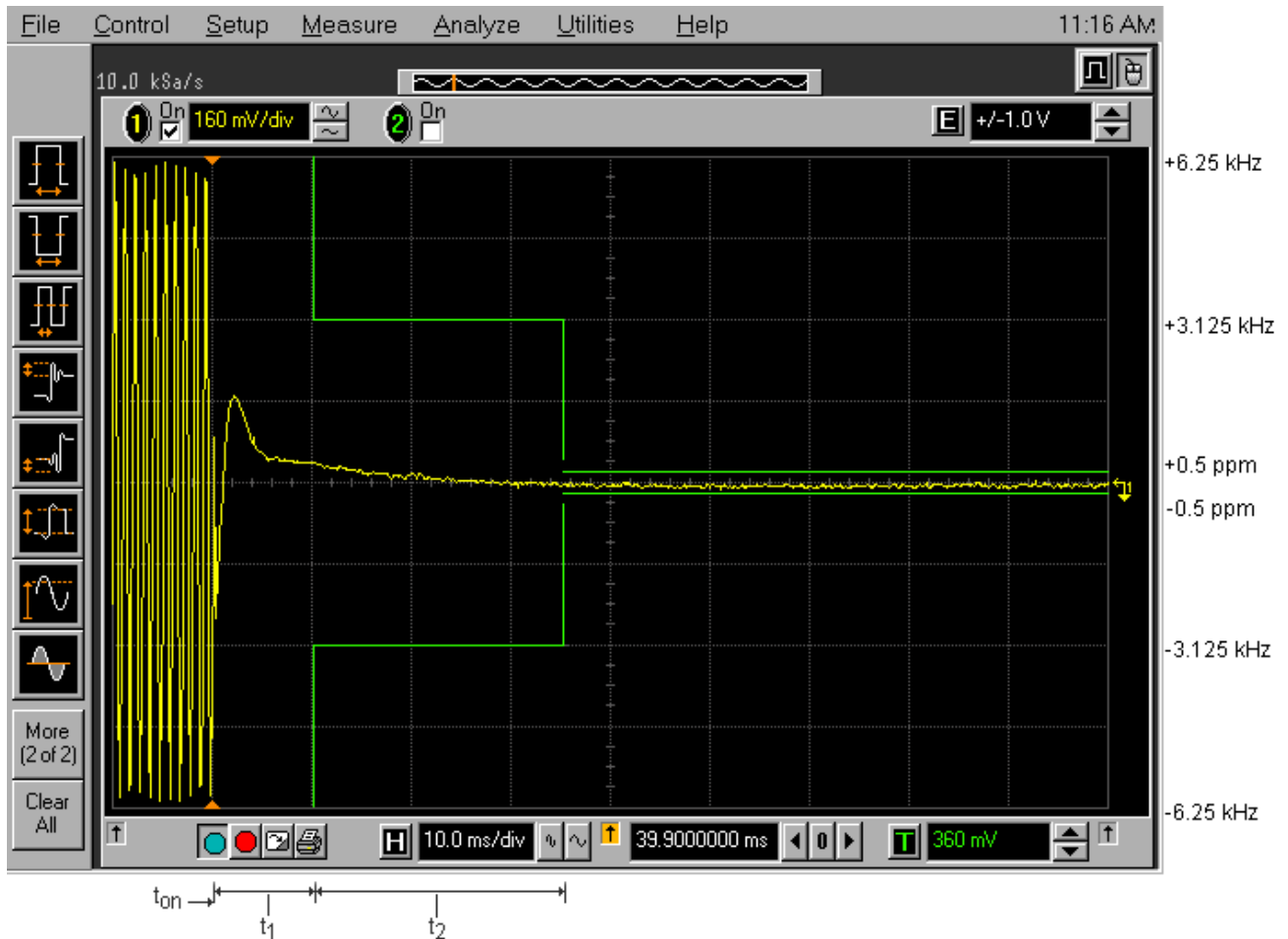

Remark: 3 kHz LP filter was selected in modulation analyzer for 6.25 kHz digital modulation.

Plot # 78.:
Transient Frequency Behavior
Carrier Frequency: 450.1 MHz
Channel Spacing: 6.25 KHz
Power: 50 W
Description: Switch off condition t_3 , t_{off}

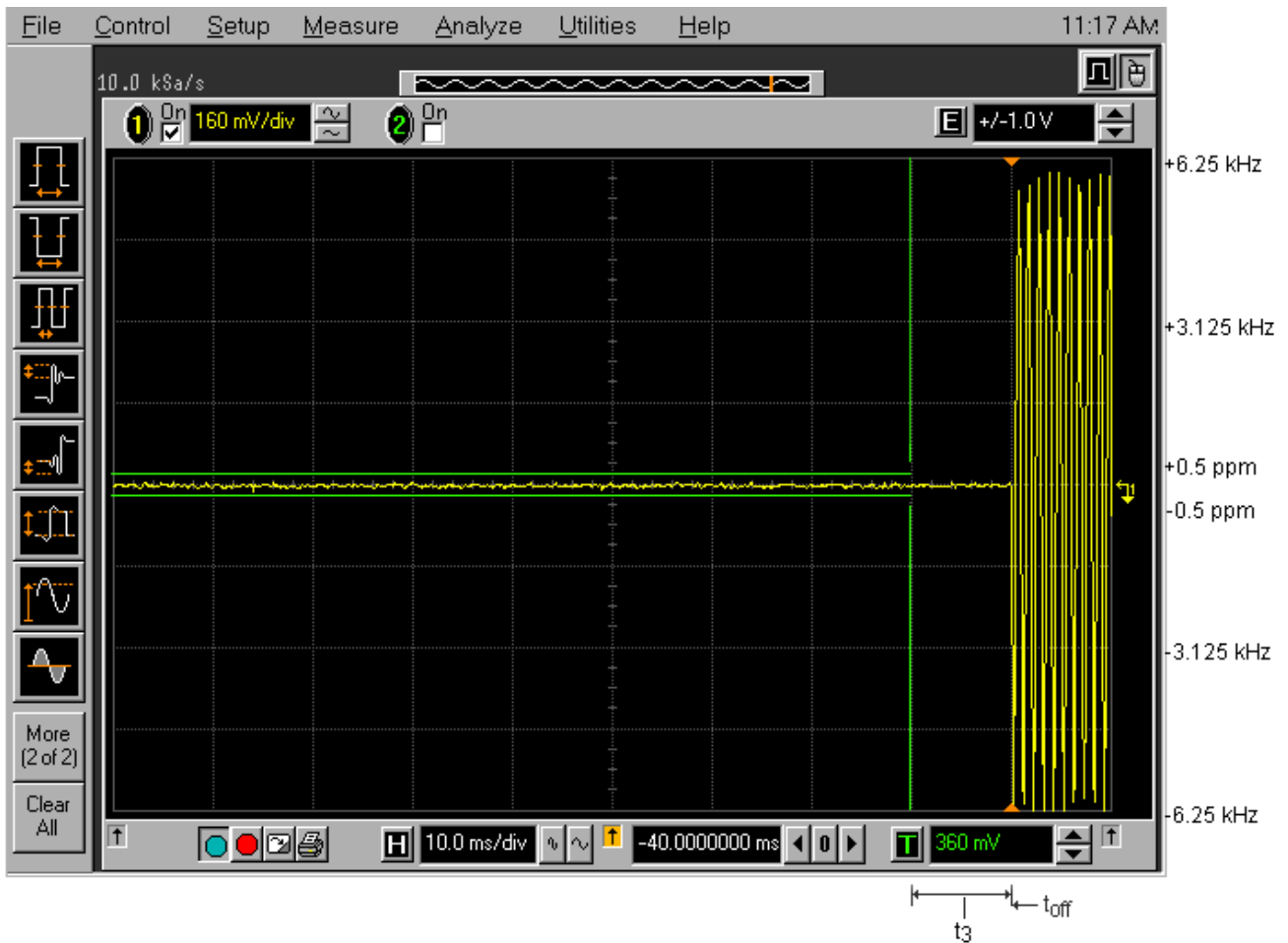

Remark: 3 kHz LP filter was selected in modulation analyzer for 6.25 kHz digital modulation.

ULTRATECH GROUP OF LABS

3000 Bristol Circle, Oakville, Ontario, Canada L6H 6G4
Tel. #: 905-829-1570, Fax. #: 905-829-8050, Email: vic@ultratech-labs.com, Website: <http://www.ultratech-labs.com>

File #: ICOM-170F90
April 21, 2008

All test results contained in this engineering test report are traceable to National Institute of Standards and Technology (NIST)

EXHIBIT 7. Test Equipments List

Test Instruments	Manufacturer	Model No.	Serial No.	Operating Range
Attenuator	Weinschel	46-20-34	BM1347	DC – 18 GHz
Attenuator	Weinschel	46-30-34	BM5354	DC – 18 GHz
BiConiLog Antenna	Emco	3142	10005	0.03 – 2 GHz
BiConiLog Antenna	ETS-Lindgren	3142B	1575	26 MHz – 2 GHz
Communication test set	Hewlett Packard	8920B	US39064699	AF SG DC – 20 kHz
EMC Analyzer	Hewlett Packard	8593EM	...	9kHz – 22 GHz
FFT (audio) EMI Receiver	Advantest	R9211E	82020336	10 mHz – 100 kHz, 1 MHz Input Impedance
High Pass Filter	Mini-Circuits	SHP-300	10427	Cut off 230 MHz
High Pass Filter	Mini-Circuits	SHP-600	19949	Cut off 560 MHz
High Pass Filter	Mini-Circuits	SHP-800	15542	Cut off 800 MHz
Horn Antenna	Emco	3155	9701-5061	1 – 18 GHz
Horn Antenna	Emco	3155	9911-5955	1 – 18 GHz
Infinium Oscilloscope	Hewlett Packard	54810A	US38380192	500 MHz, 1 GSa/s
Notch Filter	K & L	3TNF-250/500-N	UU041-1	250-500 MHz
Notch Filter	K & L	3TNF-500-1000- N/N	470	500-1000 MHz
Microwave Frequency Counter	EIP	545A	2683	10 Hz – 18 GHz
Modulation Analyzer	Hewlett Packard	8910B	3226A04606	150 kHz – 1300 MHz
Power Divider	Mini-Circuits	15542	105	1 MHz – 1 GHz
Power Meter	Hewlett Packard	437B	3.13E+09	10 kHz – 50 GHz
Power Sensor	Hewlett Packard	8481A	1150A15143	9 kHz – 26.5 GHz
Preselector	Advantest	R3551	92970002	9 kHz – 1GHz
RF Amplifier	Com-Power	PA-103		1 MHz – 1 GHz

ULTRATECH GROUP OF LABS

3000 Bristol Circle, Oakville, Ontario, Canada L6H 6G4
 Tel. #: 905-829-1570, Fax. #: 905-829-8050, Email: vic@ultratech-labs.com, Website: <http://www.ultratech-labs.com>

File #: ICOM-170F90
 April 21, 2008

All test results contained in this engineering test report are traceable to National Institute of Standards and Technology (NIST)

RF Amplifier	Hewlett Packard	84498	3008A00769	1 – 26.5 GHz
Signal Generator	Hewlett Packard	83752B	3610A00457	0.01- 20 GHz
Spectrum Analyzer	Rohde & Schwarz	FSEK20/B4/B21	834157/005	9 kHz – 40 GHz
Spectrum Analyzer	Rohde & Schwarz	FSEK30	100077	20 Hz – 40 GHz
Spectrum Analyzer	Advantest	R3271	15050203	100 Hz – 26.5 GHz
Spectrum Analyzer / EMI Receiver	Hewlett Packard	8546A	3650A00371	9 kHz – 6.5 GHz Built-in amplifier 30dB
Temperature & Humidity Chamber	Tenney	T5	9723B	-40 °C – +80 °C range

ULTRATECH GROUP OF LABS

3000 Bristol Circle, Oakville, Ontario, Canada L6H 6G4
Tel. #: 905-829-1570, Fax. #: 905-829-8050, Email: vic@ultratech-labs.com, Website: <http://www.ultratech-labs.com>

File #: ICOM-170F90
April 21, 2008

All test results contained in this engineering test report are traceable to National Institute of Standards and Technology (NIST)

EXHIBIT 8. MEASUREMENT UNCERTAINTY

The measurement uncertainties stated were calculated in accordance with the requirements of NIST Technical Note 1297 and NIS 81 (1994).

8.1. RADIATED EMISSION MEASUREMENT UNCERTAINTY

CONTRIBUTION (Radiated Emissions)	PROBABILITY DISTRIBUTION	UNCERTAINTY (\pm dB)	
		3 m	10 m
Antenna Factor Calibration	Normal (k=2)	± 1.0	± 1.0
Cable Loss Calibration	Normal (k=2)	± 0.3	± 0.5
EMI Receiver specification	Rectangular	± 1.5	± 1.5
Antenna Directivity	Rectangular	+0.5	+0.5
Antenna factor variation with height	Rectangular	± 2.0	± 0.5
Antenna phase center variation	Rectangular	0.0	± 0.2
Antenna factor frequency interpolation	Rectangular	± 0.25	± 0.25
Measurement distance variation	Rectangular	± 0.6	± 0.4
Site imperfections	Rectangular	± 2.0	± 2.0
Mismatch: Receiver VRC $\Gamma_1 = 0.2$ Antenna VRC $\Gamma_R = 0.67(\text{Bi}) 0.3 (\text{Lp})$ Uncertainty limits $20\text{Log}(1 \pm \Gamma_1 \Gamma_R)$	U-Shaped	+1.1 -1.25	± 0.5
System repeatability	Std. Deviation	± 0.5	± 0.5
Repeatability of EUT		-	-
Combined standard uncertainty	Normal	+2.19 / -2.21	+1.74 / -1.72
Expanded uncertainty U	Normal (k=2)	+4.38 / -4.42	+3.48 / -3.44

Calculation for maximum uncertainty when 3m biconical antenna including a factor of k = 2 is used:

$$U = 2u_c(y) = 2x(+2.19) = +4.38 \text{ dB} \quad \text{And} \quad U = 2u_c(y) = 2x(-2.21) = -4.42 \text{ dB}$$

EXHIBIT 9. MEASUREMENT METHODS

9.1. CONDUCTED POWER MEASUREMENTS

- The following shall be applied to the combination(s) of the radio device and its intended antenna(e).
- If the RF level is user adjustable, all measurements shall be made with the highest power level available to the user for that combination.
- The following method of measurement shall apply to both conducted and radiated measurements.
- The radiated measurements are performed at the Ultratech Calibrated Open Field Test Site.
- The measurement shall be performed using normal operation of the equipment with modulation.

Test procedure shall be as follows:

Step 1: Duty Cycle measurements if the transmitter's transmission is transient

- Using a EMI Receiver with the frequency span set to 0 Hz and the sweep time set at a suitable value to capture the envelope peaks and the duty cycle of the transmitter output signal;
- The duty cycle of the transmitter, $x = T_{x\ on} / (T_{x\ on} + T_{x\ off})$ with $0 < x < 1$, is measure and recorded in the test report. For the purpose of testing, the equipment shall be operated with a duty cycle that is equal or more than 0.1.

Step 2: Calculation of Average EIRP. See Figure 1

- The average output power of the transmitter shall be determined using a wideband, calibrated RF average power meter with the power sensor with an integration period that exceeds the repetition period of the transmitter by a factor 5 or more. The observed value shall be recorded as "A" (in dBm);
- The e.i.r.p. shall be calculated from the above measured power output "A", the observed duty cycle x, and the applicable antenna assembly gain "G" in dBi, according to the formula:

$$EIRP = A + G + 10\log(1/x)$$

{X = 1 for continuous transmission => $10\log(1/x) = 0$ dB}

Figure 1.

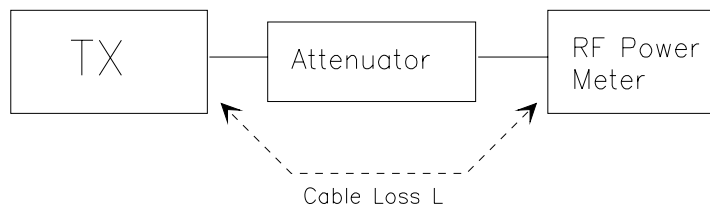

9.2. RADIATED POWER MEASUREMENTS (ERP & EIRP) USING SUBSTITUTION METHOD

9.2.1. MAXIMIZING RF EMISSION LEVEL (E-FIELD)

- (a) The measurements were performed with full rf output power and modulation.
- (b) Test was performed at listed 3m open area test site (listed with FCC, IC, ITI, NVLAP, ACA & VCCI).
- (c) The transmitter under test was placed at the specified height on a non-conducting turntable (80 cm height)
- (d) The BICONILOG antenna (20 MHz to 1 GHz) or HORN antenna (1 GHz to 18 GHz) was used for measuring.
- (e) Load an appropriate correction factors file in EMI Receiver for correcting the field strength reading level

Total Correction Factor recorded in the EMI Receiver = Cable Loss + Antenna Factor
 $E \text{ (dB}\mu\text{V/m)} = \text{Reading (dB}\mu\text{V)} + \text{Total Correction Factor (dB/m)}$

- (f) Set the EMI Receiver and #2 as follows:

Center Frequency: test frequency
Resolution BW: 100 KHz
Video BW: same
Detector Mode: positive
Average: off
Span: 3 x the signal bandwidth

- (g) The test antenna was lowered or raised from 1 to 4 meters until the maximum signal level was detected.
- (h) The transmitter was rotated through 360° about a vertical axis until a higher maximum signal was received.
- (i) The test antenna was lowered or raised again from 1 to 4 meters until a maximum was obtained. This level was recorded.
- (j) The recorded reading was corrected to the true field strength level by adding the antenna factor, cable loss and subtracting the pre-amplifier gain.
- (k) The above steps were repeated with both transmitters' antenna and test receiving antenna placed in vertical and horizontal polarization. Both readings with the antennas placed in vertical and horizontal polarization shall be recorded.
- (l) Repeat for all different test signal frequencies.

9.2.2. Measuring the EIRP of Spurious/Harmonic Emissions using Substitution Method

- (a) Set the EMI Receiver (for measuring E-Field) and Receiver #2 (for measuring EIRP) as follows:

Center Frequency: equal to the signal source
Resolution BW: 100 KHz
Video BW: VBW > RBW
Detector Mode: positive
Average: off
Span: 3 x the signal bandwidth

- (b) Load an appropriate correction factors file in EMI Receiver for correcting the field strength reading level

Total Correction Factor recorded in the EMI Receiver = Cable Loss + Antenna Factor
 $E \text{ (dBuV/m)} = \text{Reading (dBuV)} + \text{Total Correction Factor (dB/m)}$

- (c) Select the frequency and E-field levels obtained in the Section 8.2.1 for ERP/EIRP measurements.
(d) Substitute the EUT by a signal generator and one of the following transmitting antenna (substitution antenna):
 - ◆ DIPOLE antenna for frequency from 30-1000 MHz or
 - ◆ HORN antenna for frequency above 1 GHz }.(e) Mount the transmitting antenna at 1.5 meter high from the ground plane.
(f) Use one of the following antenna as a receiving antenna:
 - ◆ DIPOLE antenna for frequency from 30-1000 MHz or
 - ◆ HORN antenna for frequency above 1 GHz }.(g) If the DIPOLE antenna is used, tune it's elements to the frequency as specified in the calibration manual.
(h) Adjust both transmitting and receiving antenna in a VERTICAL polarization.
(i) Tune the EMI Receivers to the test frequency.
(j) Lower or raise the test antenna from 1 to 4 meters until the maximum signal level was detected.
(k) The transmitter was rotated through 360° about a vertical axis until a higher maximum signal was received.
(l) Lower or raise the test antenna from 1 to 4 meters until the maximum signal level was detected.
(m) Adjust input signal to the substitution antenna until an equal or a known related level to that detected from the transmitter was obtained in the test receiver.
(n) Record the power level read from the Average Power Meter and calculate the ERP/EIRP as follows:

$$P = P1 - L1 = (P2 + L2) - L1 = P3 + A + L2 - L1$$

$$EIRP = P + G1 = P3 + L2 - L1 + A + G1$$

$$ERP = EIRP - 2.15 \text{ dB}$$

$$\text{Total Correction factor in EMI Receiver \# 2} = L2 - L1 + G1$$

Where: P: Actual RF Power fed into the substitution antenna port after corrected.
P1: Power output from the signal generator
P2: Power measured at attenuator A input
P3: Power reading on the Average Power Meter
EIRP: EIRP after correction
ERP: ERP after correction

- (o) Adjust both transmitting and receiving antenna in a HORIZONTAL polarization, then repeat step (k) to (o)
(p) Repeat step (d) to (o) for different test frequency
(q) Repeat steps (c) to (j) with the substitution antenna oriented in horizontal polarization.
(r) Actual gain of the EUT's antenna is the difference of the measured EIRP and measured RF power at the RF port. Correct the antenna gain if necessary.

Figure 2

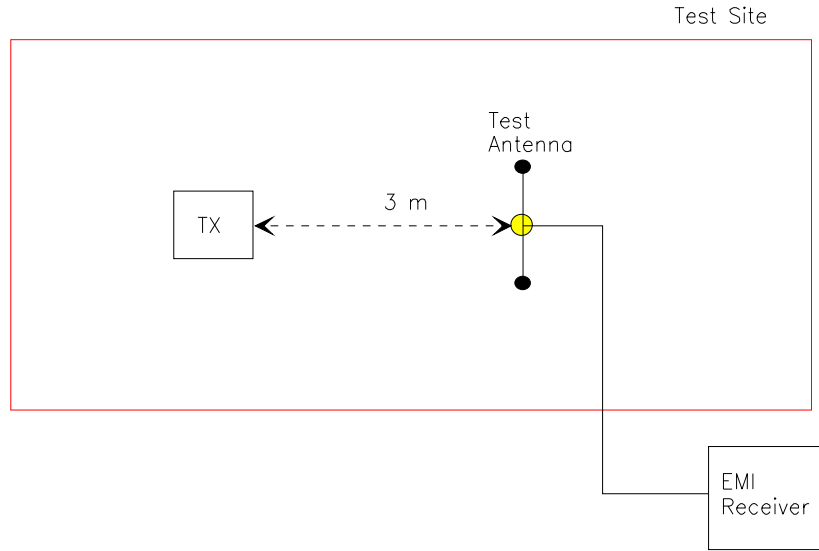
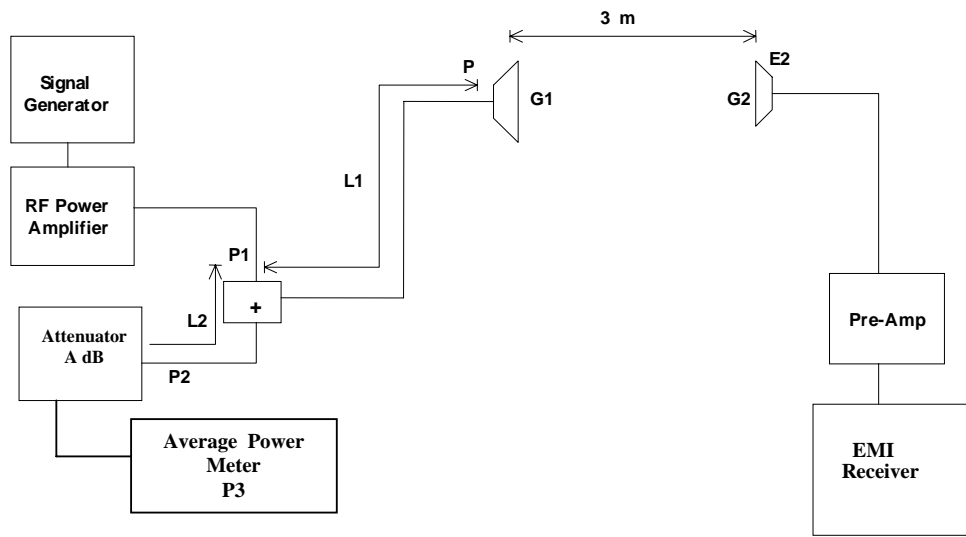

Figure 3



9.3. FREQUENCY STABILITY

Refer to FCC @ 2.1055.

- (a) The frequency stability shall be measured with variation of ambient temperature as follows: From -30 to +50 centigrade except that specified in subparagraph (2) & (3) of this paragraph.
- (b) Frequency measurements shall be made at extremes of the specified temperature range and at intervals of not more than 10 centigrade through the range. A period of time sufficient to stabilize all of the components of the oscillator circuit at each temperature level shall be allowed prior to frequency measurement. The short-term transient effects on the frequency of the transmitter due to keying (except for broadcast transmitters) and any heating element cycling normally occurring at each ambient temperature level also shall be shown. Only the portion or portions of the transmitter containing the frequency determining and stability circuitry need be subjected to the temperature variation test.
- (d) The frequency stability supply shall be measured with variation of primary supply voltage as follows:
 - (1) Vary primary supply voltage from 85 to 115 percent of the nominal value for other than hand carried battery equipment.
 - (2) For hand carried, battery powered equipment, reduce primary supply voltage to the battery operating end point which shall be specified by the manufacturer.
 - (3) The supply voltage shall be measured at the input to the cable normally provide with the equipment, or at the power supply terminals if cables are not normally provided. Effects on frequency of transmitter keying (except for broadcast transmitters) and any heating element cycling at the nominal supply voltage and at each extreme also shall be shown.
- (e) When deemed necessary, the Commission may require tests of frequency stability under conditions in addition to those specifically set out in paragraphs (a), (b), (c) and (d) of this section. (For example, measurements showing the effect of proximity to large metal objects, or of various types of antennas, may be required for portable equipment).

9.4. EMISSION MASK

Voice or Digital Modulation Through a Voice Input Port @ 2.1049(c)(i):- The transmitter was modulated by a 2.5 KHz tone signal at an input level 16 dB greater than that required to produce 50% modulation (e.g.: ± 2.5 KHz peak deviation at 1 KHz modulating frequency). The input level was established at the frequency of maximum response of the audio modulating circuit.

Digital Modulation Through a Data Input Port @ 2.1049(h):- Transmitters employing digital modulation techniques - when modulated by an input signal such that its amplitude and symbol rate represent the maximum rated conditions under which the equipment will be operated. The signal shall be applied through any filter networks, pseudo-random generators or other devices required in normal service. Additionally, the Emission Masks shall be shown for operation with any devices used for modifying the spectrum when such devices are operational at the discretion of the user.

The following EMI Receiver bandwidth shall be used for measurement of Emission Mask/Out-of-Band Emission Measurements:

- (1) For 25 KHz Channel Spacing: RBW = 300 Hz
- (2) For 12.5 KHz or 6.25 KHz Channel Spacings: RBW = 100 Hz

The all cases the Video Bandwidth shall be equal or greater than the measuring bandwidth.

9.5. SPURIOUS EMISSIONS (CONDUCTED)

With transmitter modulation characteristics described in Out-of-Band Emissions measurements @ 2.1049, the transmitter spurious and harmonic emissions were scanned. The spurious and harmonic emissions were measured with the EMI Receiver controls set as RBW = 30 KHz minimum , VBW \geq RBW and SWEEP TIME = AUTO). The transmitter was operated at a full rated power output, and modulated as follows:

FCC 47 CFR 2.1057 - Frequency spectrum to be investigated: The spectrum was investigated from the lowest radio generated in the equipment up to at least the 10th harmonic of the carrier frequency or to the highest frequency practicable in the present state of the art of measuring techniques, whichever is lower. Particular attention should be paid to harmonics and subharmonics of the carrier frequency. Radiation at the frequencies of multiplier stages should be checked. The amplitude of spurious emissions which are attenuated more than 20 dB below the permissible value need not be reported.

FCC 47 CFR 2.1051 - Spurious Emissions at Antenna Terminal: The radio frequency voltage or powers generated within the equipment and appearing on a spurious frequency shall be checked at the equipment output terminals when properly loaded with a suitable artificial antenna. Curves or equivalent data shall show the magnitude of the harmonic and other spurious emission that can be detected when the equipment is operated under the conditions specified in 2.1049 as appropriate. The magnitude of spurious emissions, which are attenuated more than 20 dB below the permissible value, need not be specified.

9.6. TRANSIENT FREQUENCY BEHAVIOR

1. Connect the transmitter under tests as shown in the above block diagram
2. Set the signal generator to the assigned frequency and modulate with a 1 KHz tone at ± 12.5 KHz deviation and its output level to be 50 dB below the transmitter rf output at the test receiver end.
3. Set the horizontal sweep rate on the storage scope to 10 milliseconds per division and adjust the display to continuously view the 1000 Hz tone from the Demodulator Output Port (DOP) of the Test Receiver. Adjust the vertical scale amplitude control of the scope to display the 1000 Hz at ± 4 divisions vertical Center at the display.
4. Adjust the scope so it will trigger on an increasing magnitude from the RF trigger signal of the transmitter under test when the transmitter was turned on. Set the controls to store the display.
5. The output at the DOP, due to the change in the ratio of the power between the signal generator input power and transmitter output power will, because of the capture effect of the test receiver, produce a change in display: For the first part of the sweep it will show the 1 KHz test signal. Then once the receiver's demodulator has been captured by the transmitter power, the display will show the frequency difference from the assigned frequency to the actual transmitter frequency versus time. The instant when the 1 KHz test signal is completely suppressed (including any capture time due to phasing) is considered to be t_{on} . The trace should be maintained within the allowed divisions during the period t_1 and t_2 .
6. During the time from the end of t_2 to the beginning of t_3 the frequency difference should not exceed the limits set by the FCC in Part 90.214 and the outlined in the Carrier Frequency Stability sections. The allowed limit is equal to FCC frequency tolerance limits specified in FCC 90.213.
7. Repeat the above steps when the transmitter was turned off for measuring t_3 .