

ENGINEERING TEST REPORT

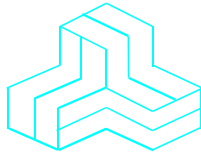

VHF Transceiver
Model No.: IC-F50V
FCC ID: AFJ306000

Applicant:

ICOM Incorporated
1-1-32, Kamiminami, Hirano-ku
Osaka
Japan, 547-0003

Tested in Accordance With

Federal Communications Commission (FCC)
47 CFR, Parts 2 and 90 (Subpart I)

UltraTech's File No.: ICOM-152F90

This Test report is Issued under the Authority of
Tri M. Luu, Professional Engineer,
Vice President of Engineering
UltraTech Group of Labs

Date: August 13, 2007



Report Prepared by: JaeWook Choi

Tested by: Wayne Wu

Issued Date: August 13, 2007

Test Dates: July 25 - 27, 2007

- *The results in this Test Report apply only to the sample(s) tested, and the sample tested is randomly selected.*
- *This report must not be used by the client to claim product endorsement by NVLAP or any agency of the US Government.*

UltraTech

3000 Bristol Circle, Oakville, Ontario, Canada, L6H 6G4

Tel.: (905) 829-1570 Fax.: (905) 829-8050

Website: www.ultratech-labs.com, Email: vic@ultratech-labs.com, Email: tri@ultratech-labs.com



0685



31040/SIT



C-1376



46390-2049



200093-0



SL2-IN-E-1119R

TABLE OF CONTENTS

| | | |
|-------------------|--|-----------|
| EXHIBIT 1. | SUBMITTAL CHECK LIST..... | 1 |
| EXHIBIT 2. | INTRODUCTION..... | 2 |
| 2.1. | SCOPE..... | 2 |
| 2.2. | RELATED SUBMITTAL(S)/GRANT(S)..... | 2 |
| 2.3. | NORMATIVE REFERENCES | 2 |
| EXHIBIT 3. | PERFORMANCE ASSESSMENT | 3 |
| 3.1. | CLIENT INFORMATION | 3 |
| 3.2. | EQUIPMENT UNDER TEST (EUT) INFORMATION | 3 |
| 3.3. | EUT'S TECHNICAL SPECIFICATIONS..... | 4 |
| 3.4. | LIST OF EUT'S PORTS | 4 |
| EXHIBIT 4. | EUT OPERATING CONDITIONS AND CONFIGURATIONS DURING TESTS..... | 5 |
| 4.1. | CLIMATE TEST CONDITIONS..... | 5 |
| 4.2. | OPERATIONAL TEST CONDITIONS & ARRANGEMENT FOR TEST SIGNALS | 5 |
| EXHIBIT 5. | SUMMARY OF TEST RESULTS..... | 6 |
| 5.1. | LOCATION OF TESTS | 6 |
| 5.2. | APPLICABILITY & SUMMARY OF EMISSION TEST RESULTS | 6 |
| 5.3. | MODIFICATIONS INCORPORATED IN THE EUT FOR COMPLIANCE PURPOSES | 6 |
| 5.4. | DEVIATION OF STANDARD TEST PROCEDURES..... | 6 |
| EXHIBIT 6. | MEASUREMENTS, EXAMINATIONS & TEST DATA FOR EMC EMISSIONS..... | 7 |
| 6.1. | TEST PROCEDURES..... | 7 |
| 6.2. | MEASUREMENT UNCERTAINTIES | 7 |
| 6.3. | MEASUREMENT EQUIPMENT USED..... | 7 |
| 6.4. | ESSENTIAL/PRIMARY FUNCTIONS AS DECLARED BY THE MANUFACTURER..... | 7 |
| 6.5. | RF POWER OUTPUT [§§ 2.1046 & 90.205]..... | 8 |
| 6.6. | FREQUENCY STABILITY [§§ 2.1055 & 90.213]..... | 9 |
| 6.7. | AUDIO FREQUENCY RESPONSE [§ 2.1047(A)]..... | 11 |
| 6.8. | MODULATION LIMITING [§§ 2.1047(B) & 90.210] | 16 |
| 6.9. | OCCUPIED BANDWIDTH & EMISSION MASK [§§ 2.1049, 90.209 & 90.210] | 21 |
| 6.10. | TRANSMITTER ANTENNA POWER SPURIOUS/HARMONIC CONDUCTED EMISSIONS [§ 90.210] | 59 |
| 6.11. | TRANSMITTER SPURIOUS/HARMONIC RADIATED EMISSIONS [§ 90.210] | 72 |
| 6.12. | TRANSIENT FREQUENCY BEHAVIOR [§ 90.214]..... | 74 |
| EXHIBIT 7. | MEASUREMENT UNCERTAINTY..... | 80 |
| 7.1. | RADIATED EMISSION MEASUREMENT UNCERTAINTY | 80 |
| EXHIBIT 8. | MEASUREMENT METHODS..... | 81 |
| 8.1. | CONDUCTED POWER MEASUREMENTS | 81 |
| 8.2. | RADIATED POWER MEASUREMENTS (ERP & EIRP) USING SUBSTITUTION METHOD | 82 |
| 8.3. | FREQUENCY STABILITY | 85 |
| 8.4. | EMISSION MASK..... | 86 |
| 8.5. | SPURIOUS EMISSIONS (CONDUCTED)..... | 86 |
| 8.6. | TRANSIENT FREQUENCY BEHAVIOR..... | 87 |

EXHIBIT 1. SUBMITTAL CHECK LIST

| Annex No. | Exhibit Type | Description of Contents | Quality Check (OK) |
|-----------|-------------------------|--|--------------------|
| -- | Test Report | <ul style="list-style-type: none"> ▪ Exhibit 1: Submittal check lists ▪ Exhibit 2: Introduction ▪ Exhibit 3: Performance Assessment ▪ Exhibit 4: EUT Operation and Configuration during Tests ▪ Exhibit 5: Summary of test Results ▪ Exhibit 6: Measurement Data ▪ Exhibit 7: Measurement Uncertainty ▪ Exhibit 8: Measurement Methods | OK |
| 1 | Test Setup Photos | Radiated Emissions Test Setup Photos | OK |
| 2 | External Photos of EUT | External EUT Photos | OK |
| 3 | Internal Photos of EUT | Internal EUT Photos | OK |
| 4 | Cover Letters | Cover Letter | OK |
| 5 | Attestation Statements | <ul style="list-style-type: none"> ▪ Letter from the Applicant to Appoint Ultratech to Act as an Agent ▪ Letter from the Applicant to Request for Confidentiality Filing ▪ Applicant Part 90 Attestation | OK |
| 6 | ID Label/Location Info | <ul style="list-style-type: none"> ▪ ID Label ▪ Location of ID Label | OK |
| 7 | Block Diagrams | Block Diagram | OK |
| 8 | Schematic Diagrams | Schematics | OK |
| 9 | Parts List/Tune Up Info | <ul style="list-style-type: none"> ▪ Parts List ▪ Adjustment for IC-F50V | OK |
| 10 | Operational Description | Circuit Description | OK |
| 11 | RF Exposure Info | N/A | OK |
| 12 | Users Manual | Instruction Manual | OK |

EXHIBIT 2. INTRODUCTION

2.1. SCOPE

| | |
|-------------------------|--|
| Reference: | FCC Parts 2 and 90 |
| Title: | Code of Federal Regulations (CFR), Title 47 Telecommunication – Parts 2 & 90 |
| Purpose of Test: | To obtain FCC Certification Authorization for Radio operating in the Frequency Band 136-174 MHz (25 KHz, 12.5 KHz and 6.25 KHz Channel Spacings). |
| Test Procedures: | Both conducted and radiated emissions measurements were conducted in accordance with TIA/EIA Standard TIA/EIA-603 (01-Nov-2002) – Land Mobile FM or PM Communications Equipment Measurement and performance Standards. |

2.2. RELATED SUBMITTAL(S)/GRANT(S)

None.

2.3. NORMATIVE REFERENCES

| Publication | Year | Title |
|----------------------------|------|---|
| FCC CFR Parts 0-19, 80-End | 2005 | Code of Federal Regulations – Telecommunication |
| ANSI C63.4 | 2004 | American National Standard for Methods of Measurement of Radio-Noise Emissions from Low-Voltage Electrical and Electronic Equipment in the Range of 9 kHz to 40 GHz |
| CISPR 16-1-1 | 2004 | Specification for Radio Disturbance and Immunity measuring apparatus and methods |
| TIA/EIA 603, Edition C | 2004 | Land Mobile FM or PM Communications Equipment Measurement and Performance Standards |

EXHIBIT 3. PERFORMANCE ASSESSMENT

3.1. CLIENT INFORMATION

| APPLICANT | |
|------------------------|---|
| Name: | ICOM Incorporated |
| Address: | 1-1-32, Kamiminami, Hirano-ku Osaka Japan, 547-0003 |
| Contact Person: | Mr. Takashi Aoki Phone #: +81-66-793-5302 Fax #: +81-66-793-0013 Email Address: export@icom.co.jp |

| MANUFACTURER | |
|------------------------|---|
| Name: | ICOM Incorporated |
| Address: | 1-1-32, Kamiminami, Hirano-ku Osaka Japan, 547-0003 |
| Contact Person: | Mr. Takashi Aoki Phone #: +81-66-793-5302 Fax #: +81-66-793-0013 Email Address: export@icom.co.jp |

3.2. EQUIPMENT UNDER TEST (EUT) INFORMATION

The following information (with the exception of the Date of Receipt) has been supplied by the applicant.

| | |
|---|---|
| Brand Name: | ICOM Incorporated |
| Product Name: | VHF Transceiver |
| Model Name or Number: | IC-F50V |
| Serial Number: | 0001 |
| Type of Equipment: | Licensed Non-Broadcast VHF Transceiver for voice and data communication |
| External Power Supply: | N/A |
| Transmitting/Receiving Antenna Type: | Non-integral |
| Primary User Functions of EUT: | Voice communication in occupational environment. |

ULTRATECH GROUP OF LABS

3000 Bristol Circle, Oakville, Ontario, Canada L6H 6G4
Tel. #: 905-829-1570, Fax. #: 905-829-8050, Email: vic@ultratech-labs.com, Website: <http://www.ultratech-labs.com>

File #: ICOM-152F90
August 13, 2007

All test results contained in this engineering test report are traceable to National Institute of Standards and Technology (NIST)

3.3. EUT'S TECHNICAL SPECIFICATIONS

| TRANSMITTER | |
|--|---|
| Equipment Type: | Portable |
| Intended Operating Environment: | Commercial, Industrial or Business |
| Power Supply Requirement: | 7.2 VDC nominal |
| RF Output Power Rating: | 5 Watts High and 1 Watt Low |
| Operating Frequency Range: | 136-174 MHz |
| RF Output Impedance: | 50 Ohms |
| Channel Spacing: | 25 KHz, 12.5 KHz |
| Occupied Bandwidth (99%): | <ul style="list-style-type: none"> • 10.88 KHz (for 25 KHz Channel Spacing) • 5.73 KHz (for 12.5 KHz Channel Spacing) |
| Emission Designation*: | 16K0F3E, 11K0F3E |
| Antenna Connector Type: | N |

* For an average case of commercial telephony, the Necessary Bandwidth is calculated as follows:

For FM Voice Modulation:

Channel Spacing = 25 KHz, D = 5 KHz max, K = 1, M = 3 KHz

$$B_n = 2M + 2DK = 2(3) + 2(5)(1) = \mathbf{16\ KHz}$$

Emission designation: 16K0F3E

Channel Spacing = 12.5 KHz, D = 2.5 KHz max, K = 1, M = 3 KHz

$$B_n = 2M + 2DK = 2(3) + 2(2.5)(1) = \mathbf{11\ KHz}$$

Emission designation: 11K0F3E

3.4. LIST OF EUT'S PORTS

| Port Number | EUT's Port Description | Number of Identical Ports | Connector Type | Cable Type (Shielded/Non-shielded) |
|-------------|------------------------|---------------------------|----------------|------------------------------------|
| 1 | Antenna Connector | 1 | N | Shield |
| 2 | SP/MIC Jack | 1 | Plug-in Jack | N/A |

EXHIBIT 4. EUT OPERATING CONDITIONS AND CONFIGURATIONS DURING TESTS

4.1. CLIMATE TEST CONDITIONS

The climate conditions of the test environment are as follows:

| | |
|---------------------|-----------------|
| Temperature: | 21°C |
| Humidity: | 51% |
| Pressure: | 102 kPa |
| Power Input Source: | 7.2 VDC Nominal |

4.2. OPERATIONAL TEST CONDITIONS & ARRANGEMENT FOR TEST SIGNALS

| | |
|----------------------------------|--|
| Operating Modes: | The transmitter was operated in a continuous transmission mode with the carrier modulated as specified in the Test Data. |
| Special Test Software: | N/A |
| Special Hardware Used: | N/A |
| Transmitter Test Antenna: | The EUT is tested with the antenna port terminated to a 50 Ohms RF Load. |

| | |
|--|---------------------------------|
| Transmitter Test Signals | |
| Frequency Band(s): | 136-174 MHz |
| Test Frequencies: (Near lowest, near middle & near highest frequencies in the frequency range of operation.) | 136.1 MHz, 155.1 MHz, 173.9 MHz |
| Transmitter Wanted Output Test Signals: | |
| Transmitter Power (measured maximum output power): | 5 Watts High & 1 Watt Low |
| Normal Test Modulation: | FM Voice |
| Modulating signal source: | External |

EXHIBIT 5. SUMMARY OF TEST RESULTS

5.1. LOCATION OF TESTS

All of the measurements described in this report were performed at Ultratech Group of Labs located in the city of Oakville, Province of Ontario, Canada.

Radiated Emissions were performed at the Ultratech's 3-10 TDK Semi-Anechoic Chamber situated in the Town of Oakville, province of Ontario. This test site been calibrated in accordance with ANSI C63.4, and found to be in compliance with the requirements of Sec. 2.948 of the FCC Rules. The descriptions and site measurement data of the Oakville 3-10 TDK Semi-Anechoic Chamber has been filed with FCC office (FCC File No.: 31040/SIT 1300B3) and Industry Canada office (Industry Canada File No.: IC2049A-2). Last Date of Site Calibration: June 20, 2006.

5.2. APPLICABILITY & SUMMARY OF EMISSION TEST RESULTS

| FCC Section(s) | Test Requirements | Applicability Yes/No) |
|---------------------------------|--|--|
| 90.205 & 2.1046 | RF Power Output | Yes |
| 1.1307, 1.1310, 2.1091 & 2.1093 | RF Exposure Limit | Yes |
| 90.213 & 2.1055 | Frequency Stability | Yes |
| 90.242(b)(8) & 2.1047(a) | Audio Frequency Response | Not applicable to new standard. However, tests are conducted under FCC's recommendation. |
| 90.210 & 2.1047(b) | Modulation Limiting | Yes |
| 90.210 & 2.1049 | Emission Limitation & Emission Mask | Yes |
| 90.210, 2.1057 & 2.1051 | Emission Limits - Spurious Emissions at Antenna Terminal | Yes |
| 90.210, 2.1057 & 2.1053 | Emission Limits - Field Strength of Spurious Emissions | Yes |
| 90.214 | Transient Frequency Behavior | Yes |

Portable VHF TRANSCEIVER, Model No.: IC-F50V, by **ICOM Incorporated** has also been tested and found to comply with **FCC Part 15, Subpart B - Radio Receivers and Class B Digital Devices**. The engineering test report has been documented and kept on file and it is available upon request.

5.3. MODIFICATIONS INCORPORATED IN THE EUT FOR COMPLIANCE PURPOSES

None.

5.4. DEVIATION OF STANDARD TEST PROCEDURES

None.

ULTRATECH GROUP OF LABS

3000 Bristol Circle, Oakville, Ontario, Canada L6H 6G4
 Tel. #: 905-829-1570, Fax. #: 905-829-8050, Email: vic@ultratech-labs.com, Website: <http://www.ultratech-labs.com>

File #: ICOM-152F90
 August 13, 2007

All test results contained in this engineering test report are traceable to National Institute of Standards and Technology (NIST)

EXHIBIT 6. MEASUREMENTS, EXAMINATIONS & TEST DATA FOR EMC EMISSIONS

6.1. TEST PROCEDURES

This section contains test results only. Details of test methods and procedures can be found in Exhibit 8 of this report

6.2. MEASUREMENT UNCERTAINTIES

The measurement uncertainties stated were calculated in accordance with requirements of UKAS Document NIS 81 with a confidence level of 95%. Please refer to Exhibit 7 for Measurement Uncertainties.

6.3. MEASUREMENT EQUIPMENT USED

The measurement equipment used complied with the requirements of the Standards referenced in the Methods & Procedures ANSI C63.4 and CISPR 16-1-1.

6.4. ESSENTIAL/PRIMARY FUNCTIONS AS DECLARED BY THE MANUFACTURER

The essential function of the EUT is to communicate to and from radios over RF link.

6.5. RF POWER OUTPUT [§§ 2.1046 & 90.205]

6.5.1. Limits

Please refer to FCC 47 CFR 90.205 for specification details.

6.5.2. Method of Measurements

Refer to Exhibit 8, Section 8.1 (Conducted) and 8.2 (Radiated) of this report for measurement details

6.5.3. Test Equipment List

| Test Instruments | Manufacturer | Model No. | Serial No. | Frequency Range |
|------------------|-----------------|-----------|------------|--------------------------------------|
| Attenuator | Weinschel Corp | 23-20-34 | BH7876 | DC – 18 GHz |
| Power Meter | Hewlett Packard | 436A | 2016A07747 | 100 KHz – 26.5 GHz, sensor dependent |
| Power Sensor | Hewlett Packard | 8481A | 2552A51276 | 10 MHz – 18 GHz |

6.5.4. Test Arrangement

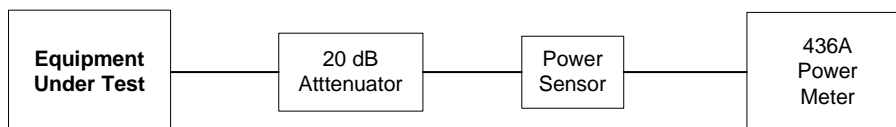

6.5.5. Test Data

| Fundamental Frequency (MHz) | Measured (Average) Power (dBm) | Power Rating (dBm) |
|-----------------------------|--------------------------------|--------------------|
| High Power Level, 5 Watts | | |
| 136.1 | 37.40 | 37 |
| 155.1 | 37.33 | 37 |
| 173.9 | 37.04 | 37 |
| Low Power Level, 1 Watt | | |
| 136.1 | 30.32 | 30 |
| 155.1 | 30.26 | 30 |
| 173.9 | 30.11 | 30 |

6.6. FREQUENCY STABILITY [§§ 2.1055 & 90.213]

6.6.1. Limits

Refer to FCC 47 CFR 90.213 for specification details.

| Frequency Range (MHz) | Channel Bandwidth (KHz) | Frequency Tolerance (ppm) | | |
|-----------------------|-------------------------|---------------------------|-----------------|-------|
| | | Fixed and Base Stations | Mobile Stations | |
| | | | > 2 W | ≤ 2 W |
| 150-174 MHz | 6.25 | 1.0 | 2.0 | 2.0 |
| | 12.5 | 2.5 | 5.0 | 5.0 |
| | 25 | 5.0 | 5.0 | 50.0* |

* Stations operating in the 154.45 to 154.49 MHz or the 173.2 to 173.4 MHz bands must have a frequency stability of 5 ppm.

6.6.2. Method of Measurements

Refer to Exhibit 8, Section 8.3 of this report for measurement details

6.6.3. Test Equipment List

| Test Instruments | Manufacturer | Model No. | Serial No. | Frequency Range |
|--------------------------------|----------------|-----------|------------|----------------------|
| Frequency Counter | EIP | 545A | 02683 | 10 Hz-18 GHz |
| Attenuator | Weinschel Corp | 48-30-34 | BM5354 | DC-18 GHz |
| Temperature & Humidity Chamber | Tenney | T5 | 9723B | -40° to +60° C range |
| Digital Multimeter | Tenma | 72-6202 | 2080027 | DC-100 KHz |
| Power Supply | Tenma | 72-6153 | -- | DC 0-20 V, 0-10A. |

6.6.4. Test Arrangement

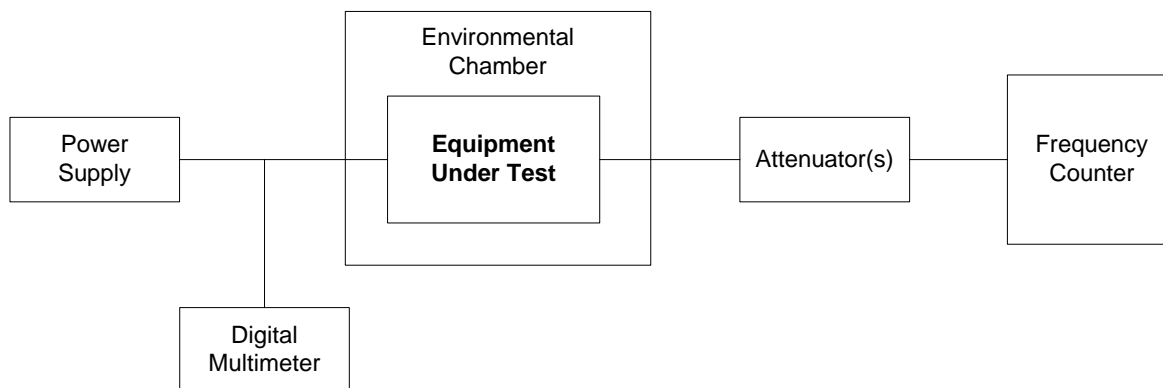

6.6.5. Test Data

| | |
|---|--|
| Product Name: Model No.: | VHF Transceiver IC-F50V |
| Center Frequency: | 136.1MHz |
| Full Power Level: | 37.4 dBm |
| Frequency Tolerance Limit: | +2.5 ppm or \pm 340 Hz |
| Max. Frequency Tolerance Measured: | 241 Hz or 1.77 ppm |
| Input Voltage Rating: | 7.2 VDC (nominal) |

| Ambient Temperature (°C) | CENTER FREQUENCY & RF POWER OUTPUT VARIATION | | |
|--------------------------|--|---|--|
| | Supply Voltage (Nominal) 7.2 Vdc | Supply Voltage (Battery End Point) 5.3 Vdc | Supply Voltage (Battery Fully Charged) 8.28 Vdc |
| | Hz | Hz | Hz |
| -30 | -68 | N/A | N/A |
| -20 | -72 | N/A | N/A |
| -10 | -75 | N/A | N/A |
| 0 | -59 | N/A | N/A |
| +10 | -25 | N/A | N/A |
| +20 | 45 | 11 | 62 |
| +30 | 93 | N/A | N/A |
| +40 | 144 | N/A | N/A |
| +50 | 171 | N/A | N/A |
| +60 | 241 | N/A | N/A |

6.7. AUDIO FREQUENCY RESPONSE [§ 2.1047(a)]

6.7.1. Limits

Recommended audio filter attenuation characteristics are given below:

| RF Band | Audio band | Minimum Attenuation Rel. to 1 KHz Attenuation |
|-------------|--------------------------|--|
| 136-174 MHz | 3 –20 KHz 20 – 30 KHz | $60 \log_{10}(f/3)$ dB where f is in KHz 50dB |

6.7.2. Method of Measurements

The rated audio input signal was applied to the input of the audio low-pass filter (or of all modulation stages) using an audio oscillator, this input signal level and its corresponding output signal were then measured and recorded using the FFT Digital Spectrum Analyzer. Tests were repeated at different audio signal frequencies from 0 to 50 KHz.

6.7.3. Test Equipment List

| Test Instruments | Manufacturer | Model No. | Serial No. | Frequency Range |
|-------------------------------|-----------------|-----------|------------|--|
| FFT (audio) Spectrum Analyzer | Advantest | R9211E | 82020336 | 10 mHz – 100 KHz, 1 MHz Input Impedance |
| RF Communications Test Set | Hewlett Packard | 8920B | US39064699 | RF 30M-1G AF DC-25KHz |
| Digital Voltmeter | Hewlett-Packard | 3456A | 2015A04523 | DC-250 KHz |
| Modulation Analyzer | Hewlett Packard | 8901B | 3226A04606 | 150 KHz-1.3 GHz |
| Digital Multimeter | Tenma | 72-6202 | 2080027 | DC-100 KHz |
| Power Supply | Tenma | 72-6153 | -- | DC 0-20 V, 0-10A. |
| Attenuator | Weinschel Corp | 23-20-34 | BM7876 | DC-18 GHz |

6.7.4. Test Arrangement

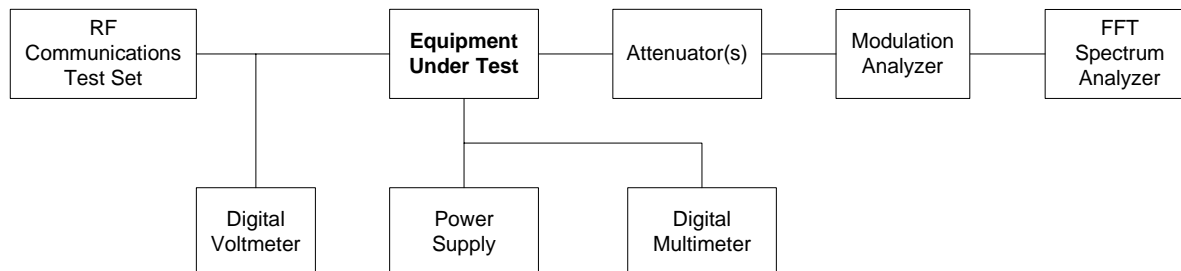

ULTRATECH GROUP OF LABS

3000 Bristol Circle, Oakville, Ontario, Canada L6H 6G4
 Tel. #: 905-829-1570, Fax. #: 905-829-8050, Email: vic@ultratech-labs.com, Website: <http://www.ultratech-labs.com>

File #: ICOM-152F90
 August 13, 2007

All test results contained in this engineering test report are traceable to National Institute of Standards and Technology (NIST)

6.7.5. Test Data

6.7.5.1. 12.5 KHz Channel Spacing, F3E, Frequency of All Modulation States*

Note: Due to the difficulty of measuring the Frequency Response of the internal low-pass filter, the Frequency Response of All Modulation States are performed to show the roll-off at 3 KHz in comparison with the recommended audio filter attenuation.

| Frequency (KHz) | Audio In (dBV) | Audio Out (dBV) | Attenuation (Out - In) (dB) | Attenuation Rel. KHz (dB) | Recommended Attenuation (dB) |
|-----------------|----------------|-----------------|-----------------------------|---------------------------|------------------------------|
| 0.1 | -37.46 | -80.00 | -42.5 | -80.3 | -- |
| 0.2 | -37.46 | -62.10 | -24.6 | -62.4 | -- |
| 0.4 | -37.46 | -8.81 | 28.7 | -9.1 | -- |
| 0.6 | -37.46 | -4.62 | 32.8 | -4.9 | -- |
| 0.8 | -37.46 | -1.81 | 35.7 | -2.1 | -- |
| 1.0 | -37.46 | 0.26 | 37.7 | 0.0 | -- |
| 1.5 | -37.46 | 1.89 | 39.4 | 1.6 | -- |
| 2.0 | -37.46 | 1.95 | 39.4 | 1.7 | -- |
| 2.5 | -37.46 | 1.08 | 38.5 | 0.8 | -- |
| 3.0 | -37.46 | -2.12 | 35.3 | -2.4 | 0 |
| 3.5 | -37.46 | -7.26 | 30.2 | -7.5 | -4 |
| 4.0 | -37.46 | -13.04 | 24.4 | -13.3 | -7 |
| 4.5 | -37.46 | -18.37 | 19.1 | -18.6 | -11 |
| 5.0 | -37.46 | -23.31 | 14.2 | -23.6 | -13 |
| 6.0 | -37.46 | -32.22 | 5.2 | -32.5 | -18 |
| 7.0 | -37.46 | -41.52 | -4.1 | -41.8 | -22 |
| 8.0 | -37.46 | -50.11 | -12.7 | -50.4 | -26 |
| 9.0 | -37.46 | -59.19 | -21.7 | -59.5 | -29 |
| 10.0 | -37.46 | -64.38 | -26.9 | -64.6 | -31 |
| 12.0 | -37.46 | -80.00 | -42.5 | -80.3 | -36 |
| 14.0 | -37.46 | -80.00 | -42.5 | -80.3 | -40 |
| 16.0 | -37.46 | -80.00 | -42.5 | -80.3 | -44 |
| 18.0 | -37.46 | -80.00 | -42.5 | -80.3 | -47 |
| 20.0 | -37.46 | -80.00 | -42.5 | -80.3 | -49 |
| 22.0 | -37.46 | -80.00 | -42.5 | -80.3 | -50 |
| 25.0 | -37.46 | -80.00 | -42.5 | -80.3 | -50 |
| 30.0 | -37.46 | -80.00 | -42.5 | -80.3 | -50 |
| 35.0 | -37.46 | -80.00 | -42.5 | -80.3 | -50 |
| 40.0 | -37.46 | -80.00 | -42.5 | -80.3 | -50 |
| 45.0 | -37.46 | -80.00 | -42.5 | -80.3 | -50 |
| 50.0 | -37.46 | -80.00 | -42.5 | -80.3 | -50 |

Audio Frequency Response
12.5 kHz Channel Spacing

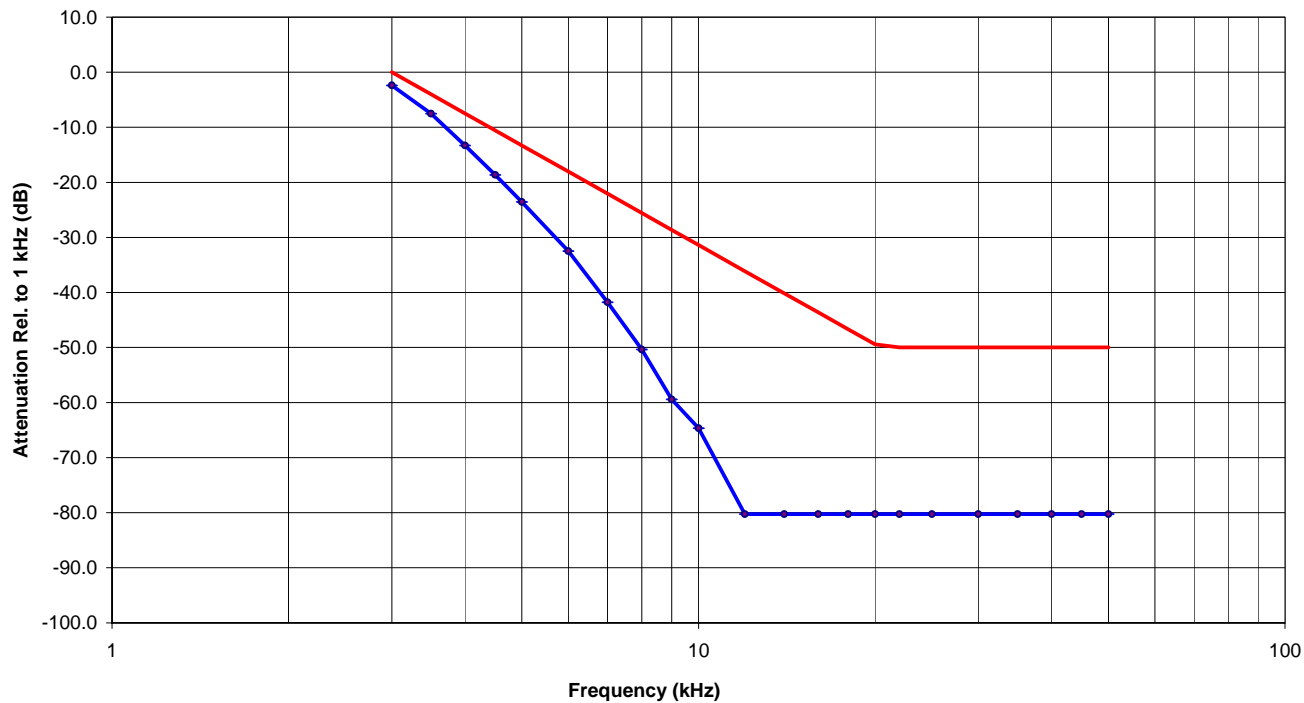

6.7.5.2. 25 KHz Channel Spacing, F3E, Frequency of All Modulation States*

Note: Due to the difficulty of measuring the Frequency Response of the internal low-pass filter, the Frequency Response of All Modulation States are performed to show the roll-off at 3 KHz in comparison with the recommended audio filter attenuation.

| Frequency (KHz) | Audio In (dBV) | Audio Out (dBV) | Attenuation (Out - In) (dB) | Attenuation Rel. KHz (dB) | Recommended Attenuation (dB) |
|-----------------|----------------|-----------------|-----------------------------|---------------------------|------------------------------|
| 0.1 | -37.20 | -80.00 | -42.8 | -86.4 | -- |
| 0.2 | -37.20 | -60.30 | -23.1 | -66.7 | -- |
| 0.4 | -37.20 | -2.73 | 34.5 | -9.1 | -- |
| 0.6 | -37.20 | 1.31 | 38.5 | -5.0 | -- |
| 0.8 | -37.20 | 4.27 | 41.5 | -2.1 | -- |
| 1.0 | -37.20 | 6.35 | 43.6 | 0.0 | -- |
| 1.5 | -37.20 | 7.78 | 45.0 | 1.4 | -- |
| 2.0 | -37.20 | 7.93 | 45.1 | 1.6 | -- |
| 2.5 | -37.20 | 7.68 | 44.9 | 1.3 | -- |
| 3.0 | -37.20 | 6.37 | 43.6 | 0.0 | 0 |
| 3.5 | -37.20 | 2.96 | 40.2 | -3.4 | -4 |
| 4.0 | -37.20 | -1.94 | 35.3 | -8.3 | -7 |
| 4.5 | -37.20 | -6.93 | 30.3 | -13.3 | -11 |
| 5.0 | -37.20 | -11.92 | 25.3 | -18.3 | -13 |
| 6.0 | -37.20 | -20.95 | 16.3 | -27.3 | -18 |
| 7.0 | -37.20 | -30.14 | 7.1 | -36.5 | -22 |
| 8.0 | -37.20 | -39.87 | -2.7 | -46.2 | -26 |
| 9.0 | -37.20 | -48.52 | -11.3 | -54.9 | -29 |
| 10.0 | -37.20 | -57.10 | -19.9 | -63.5 | -31 |
| 12.0 | -37.20 | -80.00 | -42.8 | -86.4 | -36 |
| 14.0 | -37.20 | -80.00 | -42.8 | -86.4 | -40 |
| 16.0 | -37.20 | -80.00 | -42.8 | -86.4 | -44 |
| 18.0 | -37.20 | -80.00 | -42.8 | -86.4 | -47 |
| 20.0 | -37.20 | -80.00 | -42.8 | -86.4 | -49 |
| 22.0 | -37.20 | -80.00 | -42.8 | -86.4 | -50 |
| 25.0 | -37.20 | -80.00 | -42.8 | -86.4 | -50 |
| 30.0 | -37.20 | -80.00 | -42.8 | -86.4 | -50 |
| 35.0 | -37.20 | -80.00 | -42.8 | -86.4 | -50 |
| 40.0 | -37.20 | -80.00 | -42.8 | -86.4 | -50 |
| 45.0 | -37.20 | -80.00 | -42.8 | -86.4 | -50 |
| 50.0 | -37.20 | -80.00 | -42.8 | -86.4 | -50 |

Audio Frequency Response
25 kHz Channel Spacing

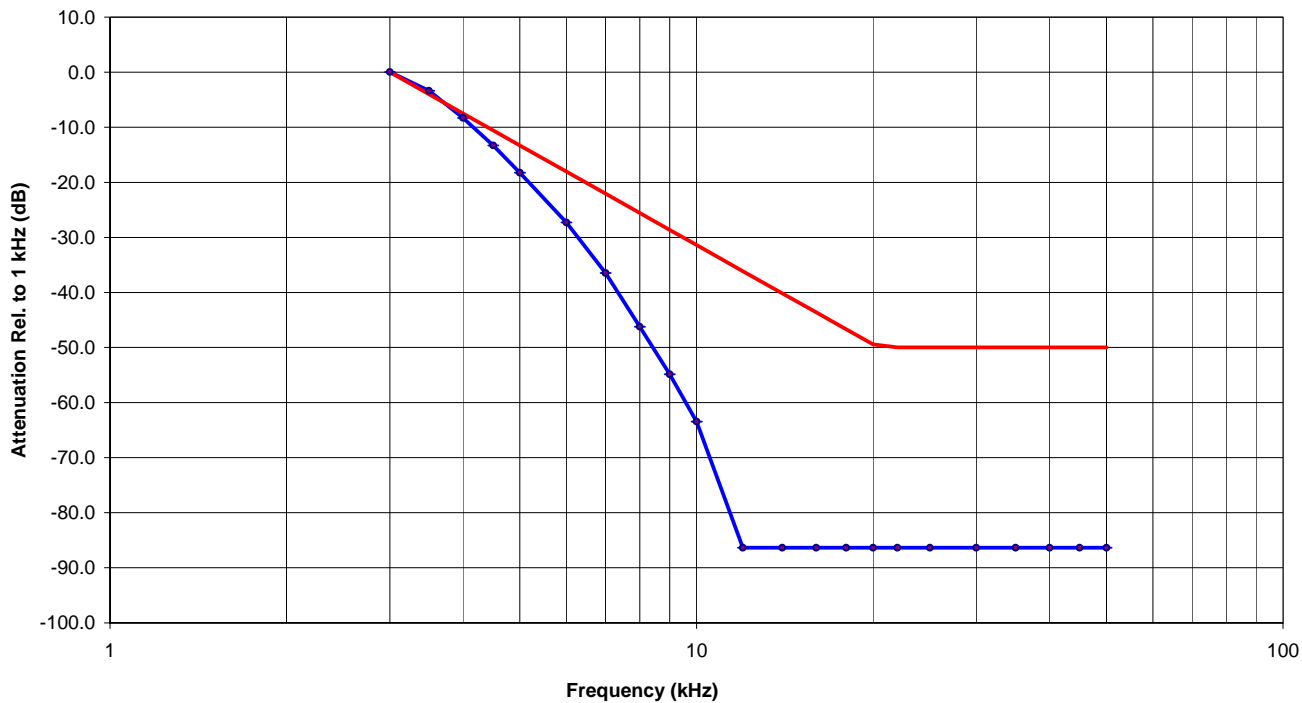

6.8. MODULATION LIMITING [§§ 2.1047(b) & 90.210]

6.8.1. Limits

Recommended frequency deviation characteristics are given below:

- 2.5 KHz for 12.5 KHz Channel Spacing System
- 5 KHz for 25 KHz Channel Spacing System

6.8.2. Method of Measurements

For Audio Transmitter: The carrier frequency deviation was measured with the tone input signal level varied from 0 Vp to audio input rating level plus 16 dB at frequencies 0.1, 0.5, 1.0, 3.0 and 5.0 KHz. The maximum deviation was recorded at each test condition.

For Data Transmitter with Maximum Frequency Deviation set by Factory: The EUT was set at maximum frequency deviation, and its peak frequency deviation was then measured using EUT's internal random data source.

6.8.3. Test Equipment List

| Test Instruments | Manufacturer | Model No. | Serial No. | Frequency Range |
|----------------------------|-----------------|-----------|------------|-----------------------|
| RF Communications Test Set | Hewlett Packard | 8920B | US39064699 | RF 30M-1G AF DC-25KHz |
| Digital Voltmeter | Hewlett-Packard | 3456A | 2015A04523 | DC-250 KHz |
| Modulation Analyzer | Hewlett Packard | 8901B | 3226A04606 | 150 KHz-1.3 GHz |
| Attenuator | Weinschel Corp | 23-20-34 | BH7876 | DC-18 GHz |
| Digital Multimeter | Tenma | 72-6202 | 2080027 | DC-100 KHz |
| Power Supply | Tenma | 72-6153 | -- | DC 0-20 V, 0-10A. |

6.8.4. Test Arrangement

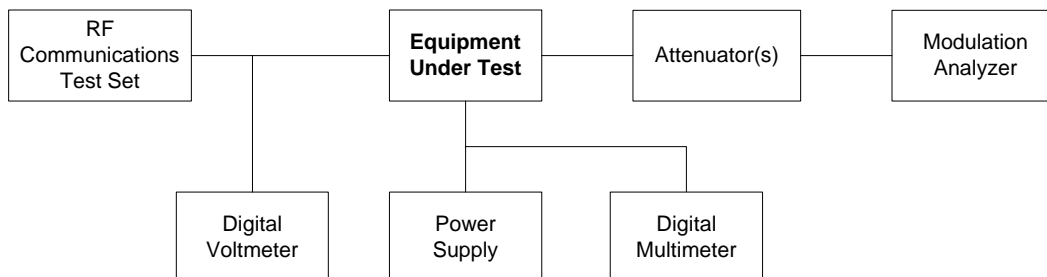

6.8.5. Test Data

6.8.5.1. Voice Modulation Limiting for 12.5 KHz Channel Spacing Operation

| MODULATING SIGNAL LEVEL (mVrms) | PEAK FREQUENCY DEVIATION (KHz) at the following modulating frequency: | | | | | MAXIMUM LIMIT (KHz) |
|--|--|---------|---------|---------|---------|-------------------------------|
| | 0.1 KHz | 0.5 KHz | 1.0 KHz | 3.0 KHz | 5.0 KHz | |
| 2 | 0.03 | 0.13 | 0.25 | 0.37 | 0.05 | 2.5 |
| 4 | 0.03 | 0.21 | 0.46 | 0.80 | 0.07 | 2.5 |
| 6 | 0.03 | 0.32 | 0.68 | 1.03 | 0.09 | 2.5 |
| 8 | 0.04 | 0.42 | 0.91 | 1.16 | 0.12 | 2.5 |
| 10 | 0.04 | 0.50 | 1.10 | 1.19 | 0.13 | 2.5 |
| 15 | 0.04 | 0.75 | 1.65 | 1.25 | 0.14 | 2.5 |
| 20 | 0.04 | 0.99 | 1.81 | 1.27 | 0.15 | 2.5 |
| 25 | 0.04 | 1.23 | 1.88 | 1.28 | 0.15 | 2.5 |
| 30 | 0.04 | 1.47 | 1.93 | 1.28 | 0.15 | 2.5 |
| 35 | 0.04 | 1.67 | 1.99 | 1.28 | 0.19 | 2.5 |
| 40 | 0.04 | 1.71 | 2.00 | 1.29 | 0.22 | 2.5 |
| 45 | 0.04 | 1.73 | 2.01 | 1.30 | 0.22 | 2.5 |
| 50 | 0.04 | 1.74 | 2.02 | 1.31 | 0.22 | 2.5 |
| 60 | 0.04 | 1.76 | 2.03 | 1.31 | 0.25 | 2.5 |
| 70 | 0.04 | 1.81 | 2.02 | 1.33 | 0.25 | 2.5 |
| 80 | 0.04 | 1.83 | 2.02 | 1.34 | 0.25 | 2.5 |
| 90 | 0.04 | 1.85 | 2.02 | 1.34 | 0.25 | 2.5 |
| 100 | 0.04 | 1.88 | 2.02 | 1.34 | 0.25 | 2.5 |
| 150 | 0.04 | 1.99 | 2.02 | 1.34 | 0.25 | 2.5 |
| 200 | 0.04 | 2.08 | 2.04 | 1.34 | 0.25 | 2.5 |
| 250 | 0.04 | 2.08 | 2.04 | 1.34 | 0.25 | 2.5 |

Voice Signal Input Level = STD MOD Level + 16 dB
= 22.54 dB(mVrms) + 16 dB
= 38.54 dB(mVrms)
= 84.55 mVrms

| Modulation Frequency (KHz) | Peak Deviation (KHz) | Maximum Limit (KHz) |
|----------------------------|----------------------|---------------------|
| 0.1 | 0.04 | 2.5 |
| 0.2 | 0.04 | 2.5 |
| 0.4 | 1.78 | 2.5 |
| 0.6 | 1.94 | 2.5 |
| 0.8 | 2.02 | 2.5 |
| 1.0 | 2.02 | 2.5 |
| 1.2 | 1.98 | 2.5 |
| 1.4 | 1.97 | 2.5 |
| 1.6 | 1.98 | 2.5 |
| 1.8 | 2.00 | 2.5 |
| 2.0 | 2.00 | 2.5 |
| 2.5 | 1.85 | 2.5 |
| 3.0 | 1.35 | 2.5 |
| 3.5 | 0.81 | 2.5 |
| 4.0 | 0.51 | 2.5 |
| 4.5 | 0.37 | 2.5 |
| 5.0 | 0.25 | 2.5 |
| 6.0 | 0.14 | 2.5 |
| 7.0 | 0.06 | 2.5 |
| 8.0 | 0.17 | 2.5 |
| 9.0 | 0.06 | 2.5 |
| 10.0 | 0.04 | 2.5 |

6.8.5.2. Voice Modulation Limiting for 25 KHz Channel Spacing Operation

| MODULATING SIGNAL LEVEL | PEAK FREQUENCY DEVIATION (KHz) at the following modulating frequency: | | | | | MAXIMUM LIMIT (KHz) |
|-------------------------------|--|---------|---------|---------|---------|---------------------------|
| | 0.1 KHz | 0.5 KHz | 1.0 KHz | 3.0 KHz | 5.0 KHz | |
| (mVrms) | | | | | | |
| 2 | 0.05 | 0.22 | 0.47 | 0.93 | 0.12 | 5 |
| 4 | 0.05 | 0.42 | 0.91 | 1.82 | 0.20 | 5 |
| 6 | 0.05 | 0.61 | 1.34 | 2.71 | 0.28 | 5 |
| 8 | 0.05 | 0.81 | 1.81 | 3.06 | 0.38 | 5 |
| 10 | 0.05 | 0.98 | 2.18 | 3.17 | 0.41 | 5 |
| 15 | 0.05 | 1.44 | 3.22 | 3.31 | 0.43 | 5 |
| 20 | 0.05 | 1.95 | 3.47 | 3.34 | 0.48 | 5 |
| 25 | 0.05 | 2.41 | 3.63 | 3.37 | 0.46 | 5 |
| 30 | 0.05 | 2.88 | 3.74 | 3.36 | 0.47 | 5 |
| 35 | 0.05 | 3.24 | 3.81 | 3.38 | 0.56 | 5 |
| 40 | 0.05 | 3.31 | 3.87 | 3.39 | 0.62 | 5 |
| 45 | 0.05 | 3.40 | 3.91 | 3.41 | 0.63 | 5 |
| 50 | 0.05 | 3.37 | 3.93 | 3.43 | 0.64 | 5 |
| 60 | 0.05 | 3.41 | 3.97 | 3.44 | 0.65 | 5 |
| 70 | 0.05 | 3.44 | 3.98 | 3.46 | 0.65 | 5 |
| 80 | 0.05 | 3.51 | 3.98 | 3.49 | 0.65 | 5 |
| 90 | 0.05 | 3.55 | 3.97 | 3.49 | 0.65 | 5 |
| 100 | 0.05 | 0.61 | 3.99 | 3.49 | 0.65 | 5 |
| 150 | 0.05 | 3.86 | 4.02 | 3.49 | 0.65 | 5 |
| 200 | 0.05 | 4.07 | 4.02 | 3.49 | 0.65 | 5 |
| 250 | 0.05 | 4.07 | 4.02 | 3.49 | 0.65 | 5 |

Voice Signal Input Level = STD MOD Level + 16 dB
= 22.80 dB(mVrms) + 16 dB
= 38.80 dB(mVrms)
= 87.07 mVrms

| Modulation Frequency (KHz) | Peak Deviation (KHz) | Maximum Limit (KHz) |
|----------------------------|----------------------|---------------------|
| 0.1 | 0.05 | 5.0 |
| 0.2 | 0.05 | 5.0 |
| 0.4 | 3.48 | 5.0 |
| 0.6 | 3.77 | 5.0 |
| 0.8 | 3.92 | 5.0 |
| 1.0 | 3.98 | 5.0 |
| 1.2 | 3.95 | 5.0 |
| 1.4 | 3.88 | 5.0 |
| 1.6 | 3.86 | 5.0 |
| 1.8 | 3.88 | 5.0 |
| 2.0 | 3.91 | 5.0 |
| 2.5 | 3.88 | 5.0 |
| 3.0 | 3.49 | 5.0 |
| 3.5 | 2.45 | 5.0 |
| 4.0 | 1.57 | 5.0 |
| 4.5 | 1.05 | 5.0 |
| 5.0 | 0.65 | 5.0 |
| 6.0 | 0.41 | 5.0 |
| 7.0 | 0.14 | 5.0 |
| 8.0 | 0.32 | 5.0 |
| 9.0 | 0.11 | 5.0 |
| 10.0 | 0.06 | 5.0 |

6.9. OCCUPIED BANDWIDTH & EMISSION MASK [§§ 2.1049, 90.209 & 90.210]

6.9.1. Limits

Emissions shall be attenuated below the mean output power of the transmitter as follows:

| Frequency Range (MHz) | Maximum Authorized BW (KHz) | Channel Spacing (KHz) | Recommended Frequency Deviation (KHz) | FCC Applicable Mask |
|-----------------------|-----------------------------|-----------------------|---------------------------------------|---------------------------------|
| 156-174 | 20.0 | 25 | 5.0 | Mask B – Voice Mask C – Data |
| 156-174 | 11.25 | 12.5 | 2.5 | Mask D – Voice & Data |
| 150-174 | 6 | 6.25 | 1.25 | Mask E – Voice & Data |

6.9.2. Method of Measurements

Refer to Exhibit 8, Section 8.4 of this report for measurement details and TIA-102.CAAA-B.

6.9.3. Test Equipment List

| Test Instruments | Manufacturer | Model No. | Serial No. | Frequency Range |
|----------------------------|-----------------|-----------|------------|-----------------------|
| RF Communications Test Set | Hewlett Packard | 8920B | US39064699 | RF 30M-1G AF DC-25KHz |
| Digital Voltmeter | Hewlett-Packard | 3456A | 2015A04523 | DC-250 KHz |
| Spectrum Analyzer | Advantest | R3271 | 15050203 | 100Hz-26.5GHz |
| Attenuator | Weinschel Corp | 23-20-34 | BH7876 | DC-18 GHz |
| Digital Multimeter | Tenma | 72-6202 | 2080027 | DC-100 KHz |
| Power Supply | Tenma | 72-6153 | -- | DC 0-20 V, 0-10A. |

6.9.4. Test Arrangement

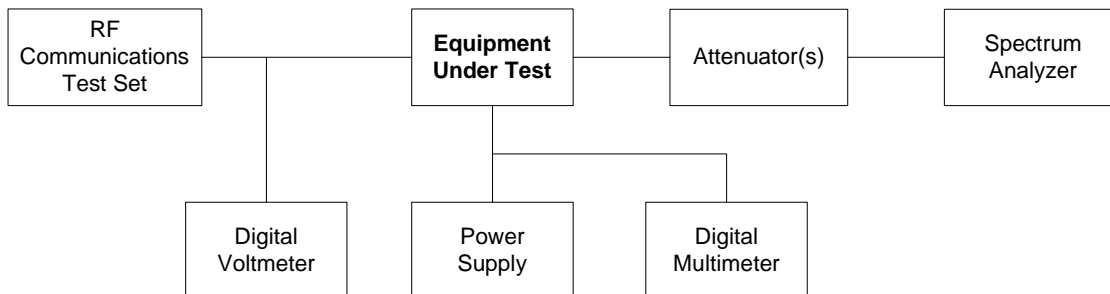

6.9.5. Test Data

6.9.5.1. 99% Occupied Bandwidth

| Frequency (MHz) | Channel Spacing (KHz) | Modulation | *Measured 99% OBW at Maximum Freq. Deviation (KHz) | Maximum Authorized Bandwidth (KHz) |
|-----------------|-----------------------|---|--|------------------------------------|
| 136.1 | 25 | FM with 2.5 KHz sine wave signal | 10.76 | 20.0 |
| 155.1 | 25 | FM with 2.5 KHz sine wave signal | 10.76 | 20.0 |
| 173.9 | 25 | FM with 2.5 KHz sine wave signal | 10.88 | 20.0 |
| 136.1 | 12.5 | FM with 2.5 KHz sine wave signal | 5.69 | 11.25 |
| 155.1 | 12.5 | FM with 2.5 KHz sine wave signal | 5.69 | 11.25 |
| 173.9 | 12.5 | FM with 2.5 KHz sine wave signal | 5.73 | 11.25 |
| 136.1 | 25 | FM with 2.5 KHz sine wave signal with Scrambler | 10.34 | 20.0 |
| 155.1 | 25 | FM with 2.5 KHz sine wave signal with Scrambler | 10.40 | 20.0 |
| 173.9 | 25 | FM with 2.5 KHz sine wave signal with Scrambler | 10.46 | 20.0 |
| 136.1 | 12.5 | FM with 2.5 KHz sine wave signal with Scrambler | 5.69 | 11.25 |
| 155.1 | 12.5 | FM with 2.5 KHz sine wave signal with Scrambler | 5.69 | 11.25 |
| 173.9 | 12.5 | FM with 2.5 KHz sine wave signal with Scrambler | 5.69 | 11.25 |

Note: 99% Occupied Bandwidth measurements were done using the built-in auto function of the analyzer.

*Refer to the following test data plots (1 through 12) for details.

Plot # 1.:
Occupied Bandwidth
Carrier Frequency: 136.1 MHz
Channel Spacing: 25.0 KHz
Power: 5 W
Modulation: FM with 2.5 KHz sine wave signal

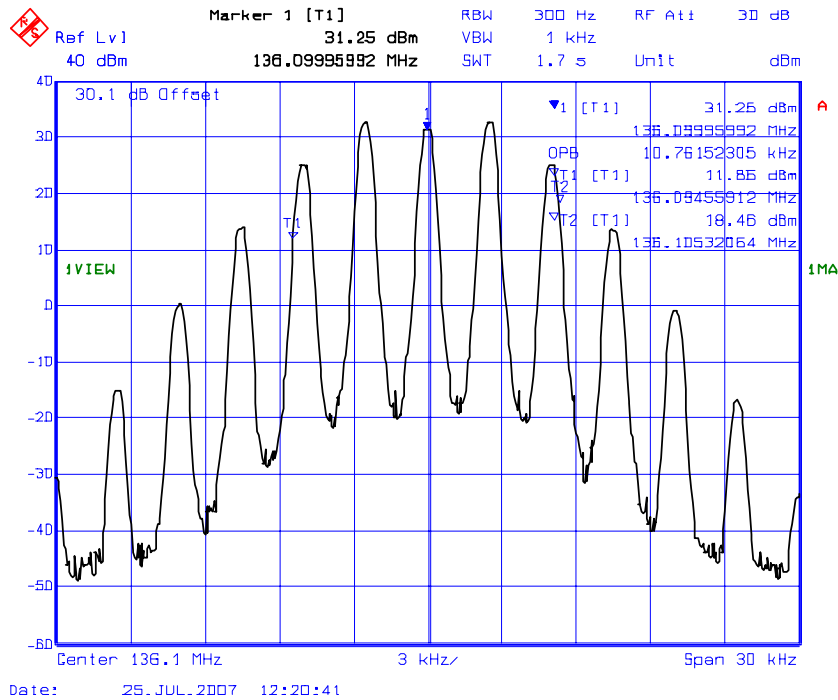

ULTRATECH GROUP OF LABS

3000 Bristol Circle, Oakville, Ontario, Canada L6H 6G4
Tel. #: 905-829-1570, Fax. #: 905-829-8050, Email: vic@ultratech-labs.com, Website: <http://www.ultratech-labs.com>

File #: ICOM-152F90
August 13, 2007

All test results contained in this engineering test report are traceable to National Institute of Standards and Technology (NIST)

Plot # 2.:
Occupied Bandwidth
Carrier Frequency: 155.1 MHz
Channel Spacing: 25.0 KHz
Power: 5 W
Modulation: FM with 2.5 KHz sine wave signal

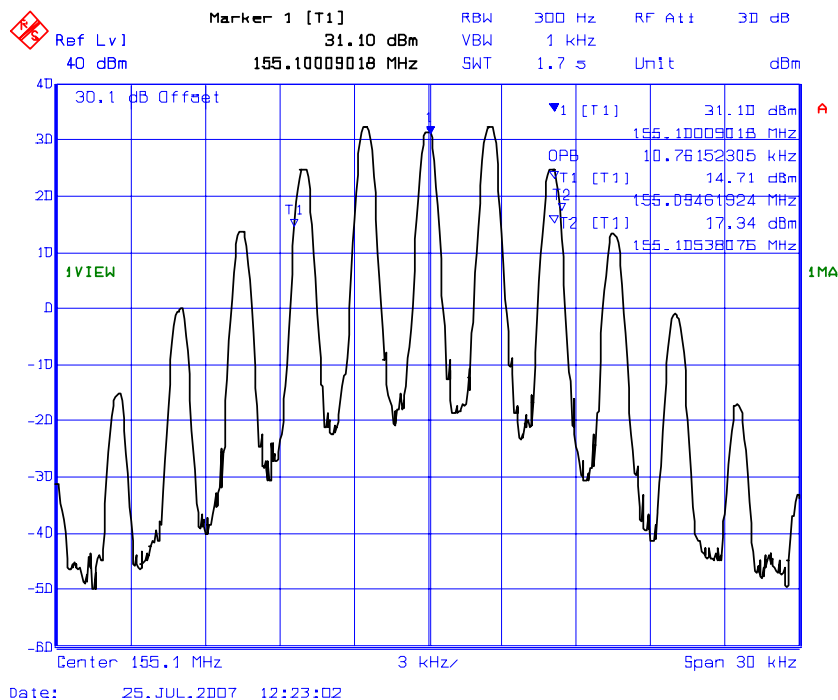

ULTRATECH GROUP OF LABS

3000 Bristol Circle, Oakville, Ontario, Canada L6H 6G4
Tel. #: 905-829-1570, Fax. #: 905-829-8050, Email: vic@ultratech-labs.com, Website: <http://www.ultratech-labs.com>

File #: ICOM-152F90

August 13, 2007

All test results contained in this engineering test report are traceable to National Institute of Standards and Technology (NIST)

Plot # 3.:
Occupied Bandwidth
Carrier Frequency: 173.9 MHz
Channel Spacing: 25.0 KHz
Power: 5 W
Modulation: FM with 2.5 KHz sine wave signal

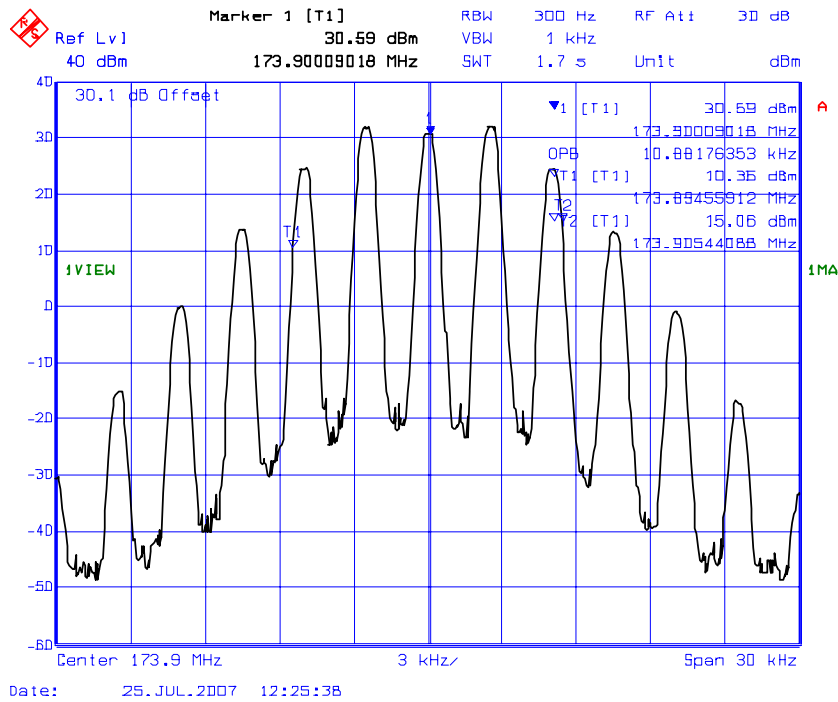

ULTRATECH GROUP OF LABS

3000 Bristol Circle, Oakville, Ontario, Canada L6H 6G4
Tel. #: 905-829-1570, Fax. #: 905-829-8050, Email: vic@ultratech-labs.com, Website: <http://www.ultratech-labs.com>

File #: ICOM-152F90

August 13, 2007

All test results contained in this engineering test report are traceable to National Institute of Standards and Technology (NIST)

Plot # 4.:
Occupied Bandwidth
Carrier Frequency: 136.1 MHz
Channel Spacing: 12.5 KHz
Power: 5 W
Modulation: FM with 2.5 KHz sine wave signal

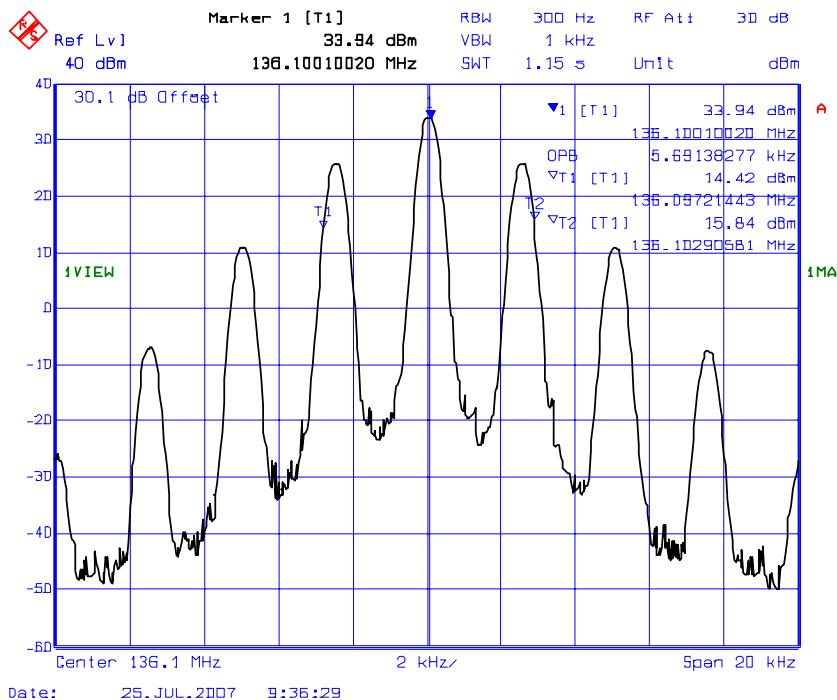

ULTRATECH GROUP OF LABS

3000 Bristol Circle, Oakville, Ontario, Canada L6H 6G4
Tel. #: 905-829-1570, Fax. #: 905-829-8050, Email: vic@ultratech-labs.com, Website: <http://www.ultratech-labs.com>

File #: ICOM-152F90

August 13, 2007

All test results contained in this engineering test report are traceable to National Institute of Standards and Technology (NIST)

Plot # 5.:
Occupied Bandwidth
Carrier Frequency: 155.1 MHz
Channel Spacing: 12.5 KHz
Power: 5 W
Modulation: FM with 2.5 KHz sine wave signal

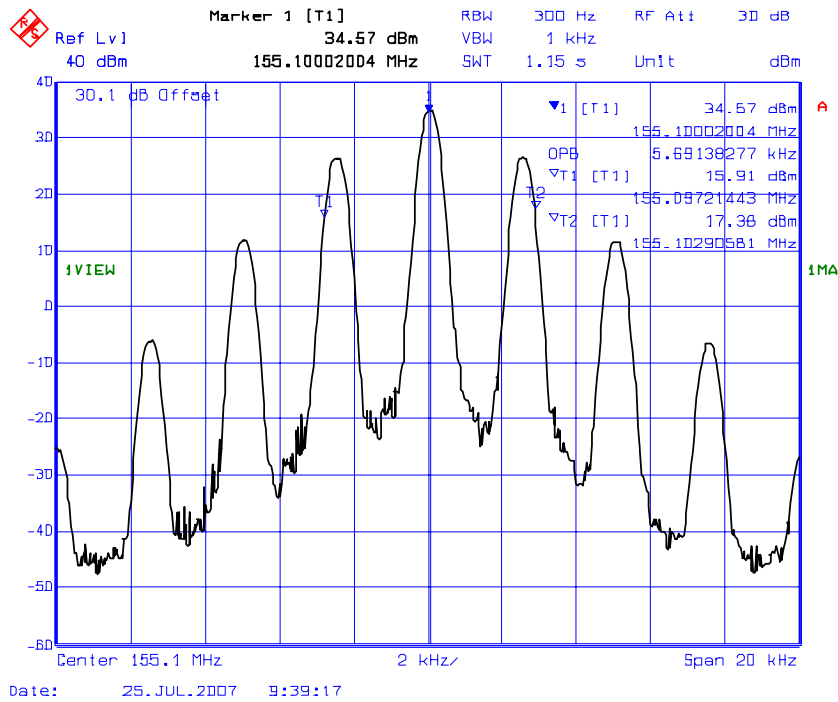

ULTRATECH GROUP OF LABS

3000 Bristol Circle, Oakville, Ontario, Canada L6H 6G4
Tel. #: 905-829-1570, Fax. #: 905-829-8050, Email: vic@ultratech-labs.com, Website: <http://www.ultratech-labs.com>

File #: ICOM-152F90

August 13, 2007

All test results contained in this engineering test report are traceable to National Institute of Standards and Technology (NIST)

Plot # 6.:
Occupied Bandwidth
Carrier Frequency: 173.9 MHz
Channel Spacing: 12.5 KHz
Power: 5 W
Modulation: FM with 2.5 KHz sine wave signal

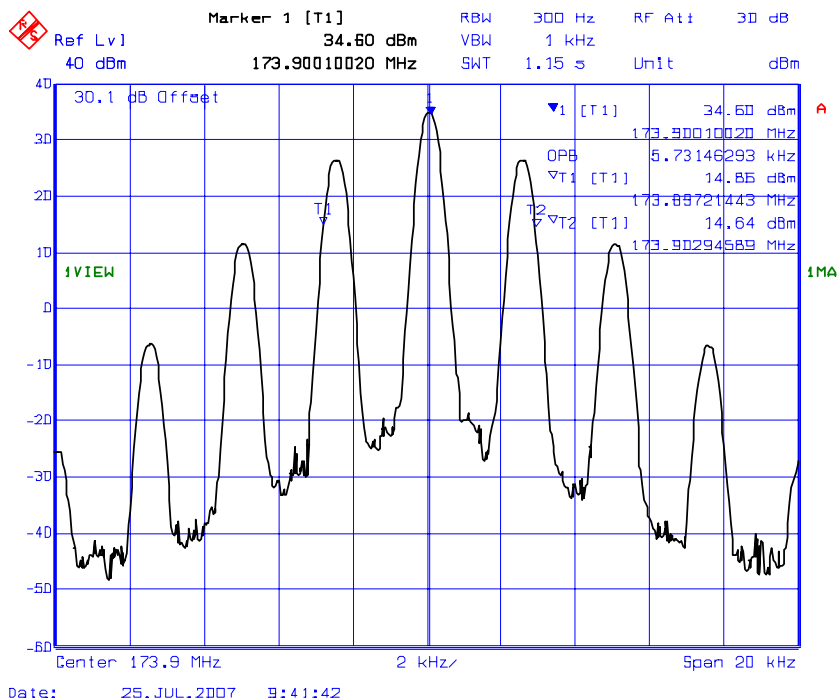

ULTRATECH GROUP OF LABS

3000 Bristol Circle, Oakville, Ontario, Canada L6H 6G4
Tel. #: 905-829-1570, Fax. #: 905-829-8050, Email: vic@ultratech-labs.com, Website: <http://www.ultratech-labs.com>

File #: ICOM-152F90

August 13, 2007

All test results contained in this engineering test report are traceable to National Institute of Standards and Technology (NIST)

Plot # 7.:
 Occupied Bandwidth
 Carrier Frequency: 136.1 MHz
 Channel Spacing: 25 KHz
 Power: 5 W
 Modulation: FM with 2.5 KHz sine wave signal with Scrambler

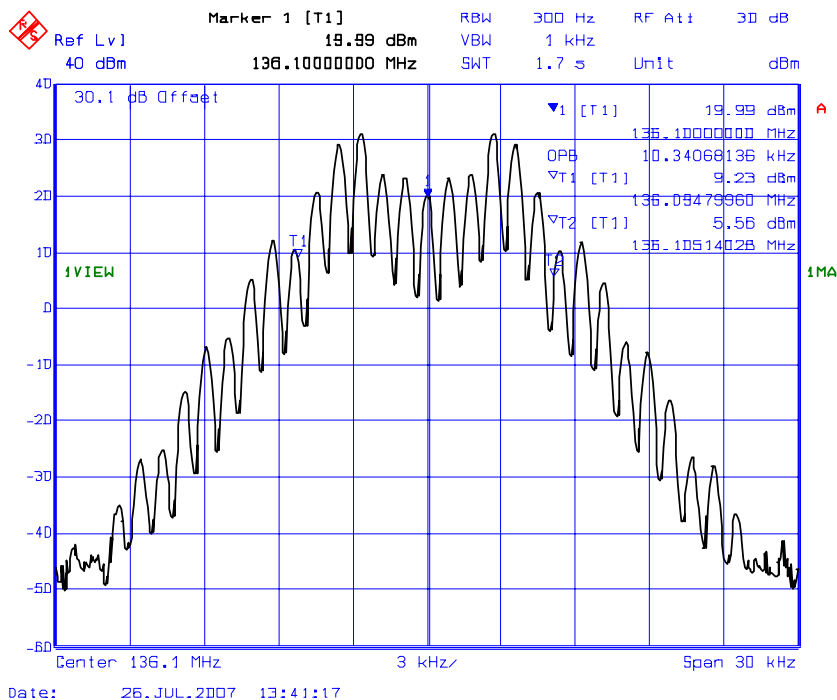

ULTRATECH GROUP OF LABS

3000 Bristol Circle, Oakville, Ontario, Canada L6H 6G4
 Tel. #: 905-829-1570, Fax. #: 905-829-8050, Email: vic@ultratech-labs.com, Website: <http://www.ultratech-labs.com>

File #: ICOM-152F90

August 13, 2007

All test results contained in this engineering test report are traceable to National Institute of Standards and Technology (NIST)

Plot # 8.:
Occupied Bandwidth
Carrier Frequency: 155.1 MHz
Channel Spacing: 25 KHz
Power: 5 W
Modulation: FM with 2.5 KHz sine wave signal with Scrambler

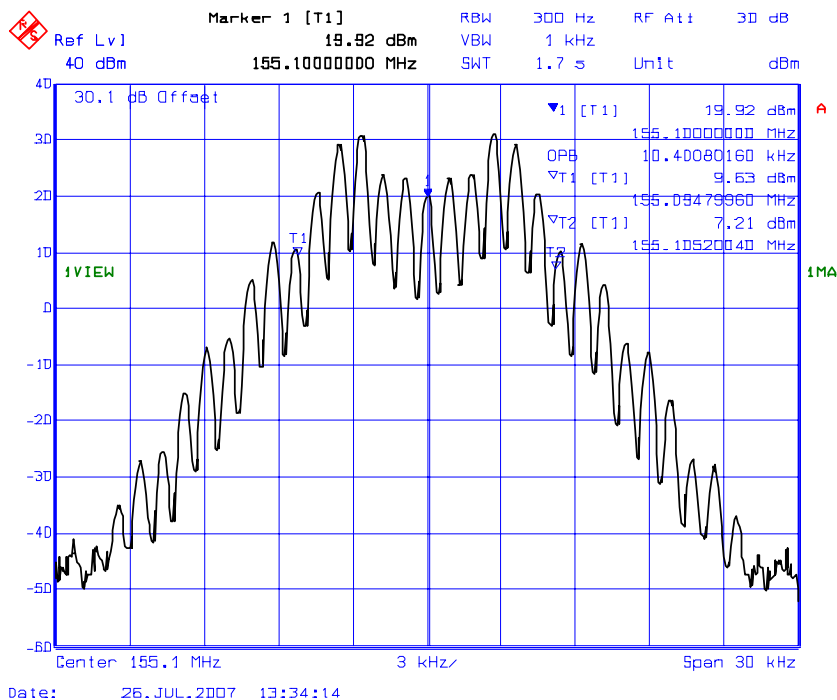

ULTRATECH GROUP OF LABS

3000 Bristol Circle, Oakville, Ontario, Canada L6H 6G4
Tel. #: 905-829-1570, Fax. #: 905-829-8050, Email: vic@ultratech-labs.com, Website: <http://www.ultratech-labs.com>

File #: ICOM-152F90

August 13, 2007

All test results contained in this engineering test report are traceable to National Institute of Standards and Technology (NIST)

Plot # 9.:
Occupied Bandwidth
Carrier Frequency: 173.9 MHz
Channel Spacing: 25 KHz
Power: 5 W
Modulation: FM with 2.5 KHz sine wave signal with Scrambler

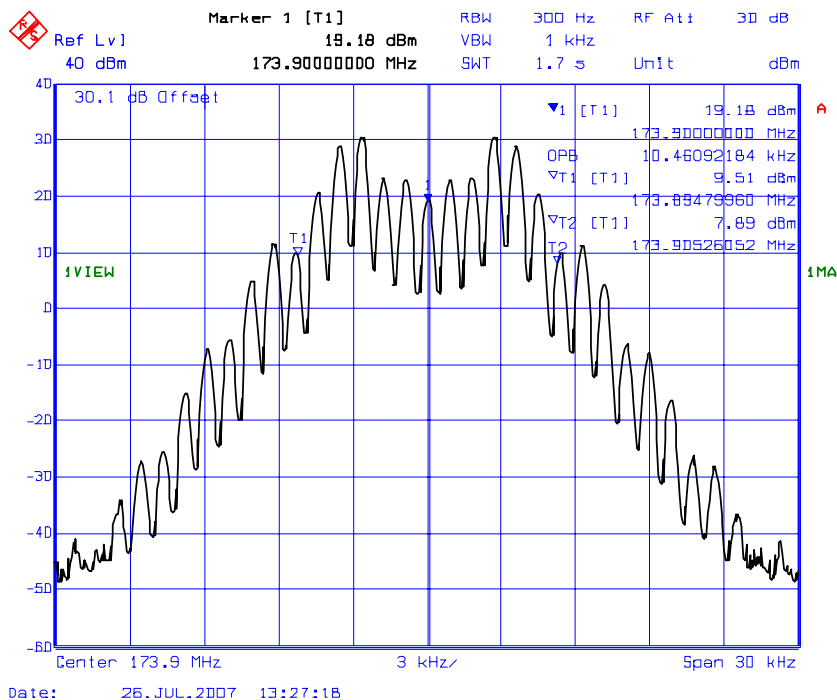

ULTRATECH GROUP OF LABS

3000 Bristol Circle, Oakville, Ontario, Canada L6H 6G4
Tel. #: 905-829-1570, Fax. #: 905-829-8050, Email: vic@ultratech-labs.com, Website: <http://www.ultratech-labs.com>

File #: ICOM-152F90

August 13, 2007

All test results contained in this engineering test report are traceable to National Institute of Standards and Technology (NIST)

Plot # 10.:
Occupied Bandwidth
Carrier Frequency: 136.1 MHz
Channel Spacing: 12.5 KHz
Power: 5 W
Modulation: FM with 2.5 KHz sine wave signal with Scrambler

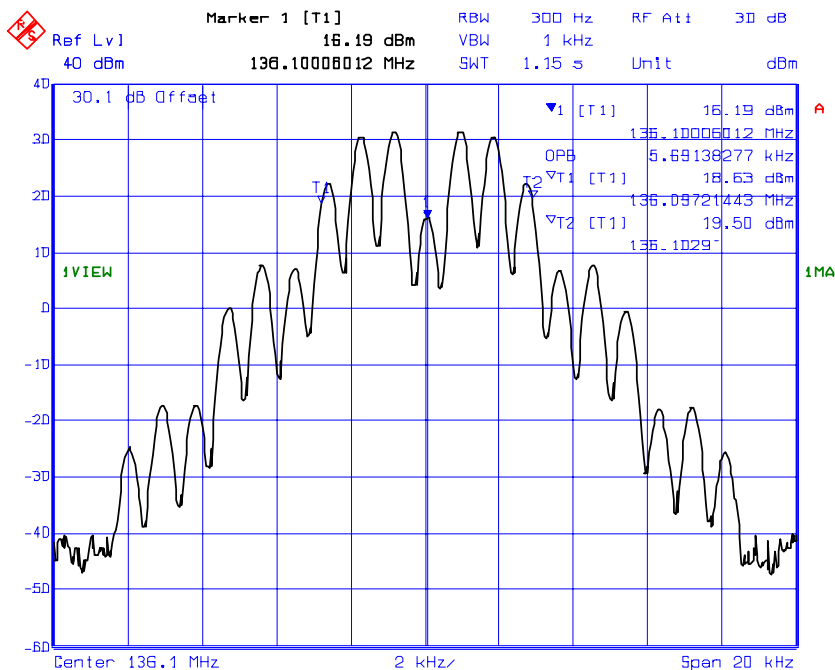

ULTRATECH GROUP OF LABS

3000 Bristol Circle, Oakville, Ontario, Canada L6H 6G4
Tel. #: 905-829-1570, Fax. #: 905-829-8050, Email: vic@ultratech-labs.com, Website: <http://www.ultratech-labs.com>

File #: ICOM-152F90

August 13, 2007

All test results contained in this engineering test report are traceable to National Institute of Standards and Technology (NIST)

Plot # 11.:
Occupied Bandwidth
Carrier Frequency: 155.1 MHz
Channel Spacing: 12.5 KHz
Power: 5 W
Modulation: FM with 2.5 KHz sine wave signal with Scrambler

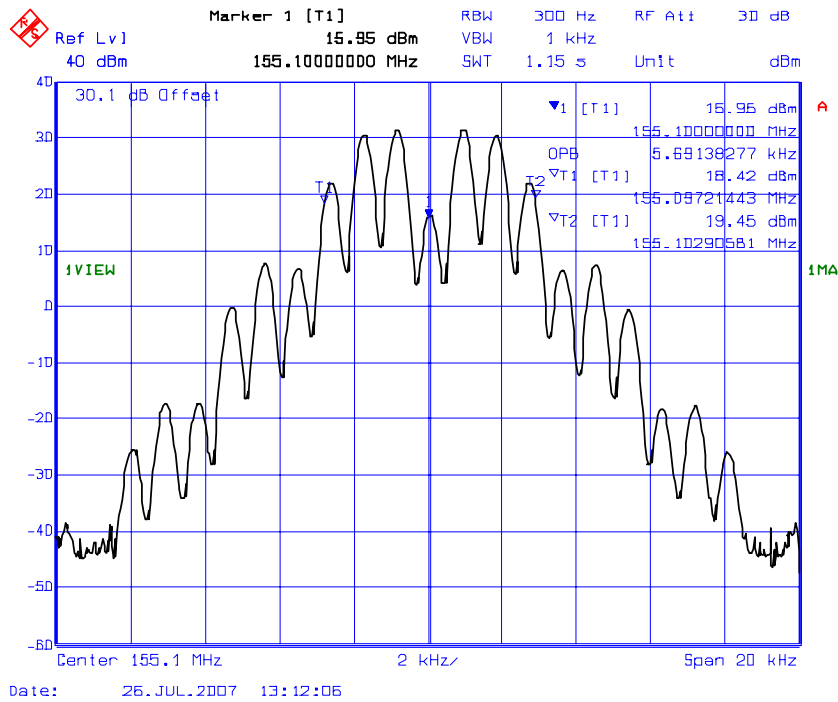

ULTRATECH GROUP OF LABS

3000 Bristol Circle, Oakville, Ontario, Canada L6H 6G4
Tel. #: 905-829-1570, Fax. #: 905-829-8050, Email: vic@ultratech-labs.com, Website: <http://www.ultratech-labs.com>

File #: ICOM-152F90

August 13, 2007

All test results contained in this engineering test report are traceable to National Institute of Standards and Technology (NIST)

Plot # 12.:
Occupied Bandwidth
Carrier Frequency: 173.9 MHz
Channel Spacing: 12.5 KHz
Power: 5 W
Modulation: FM with 2.5 KHz sine wave signal with Scrambler

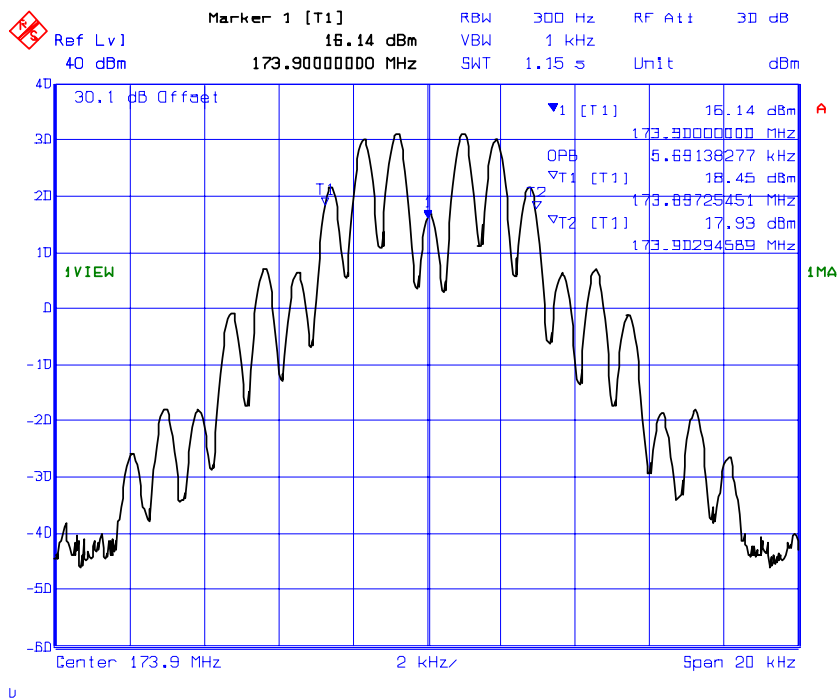

ULTRATECH GROUP OF LABS

3000 Bristol Circle, Oakville, Ontario, Canada L6H 6G4
Tel. #: 905-829-1570, Fax. #: 905-829-8050, Email: vic@ultratech-labs.com, Website: <http://www.ultratech-labs.com>

File #: ICOM-152F90

August 13, 2007

All test results contained in this engineering test report are traceable to National Institute of Standards and Technology (NIST)

6.9.5.2. Emission Masks

Conform. See the following test data plots (13 through 36) for details.

Plot # 13.:
Emission Mask B
Carrier Frequency: 136.1 MHz
Channel Spacing: 25 KHz
Power: 5 W
Modulation: FM with 2.5KHz sine wave

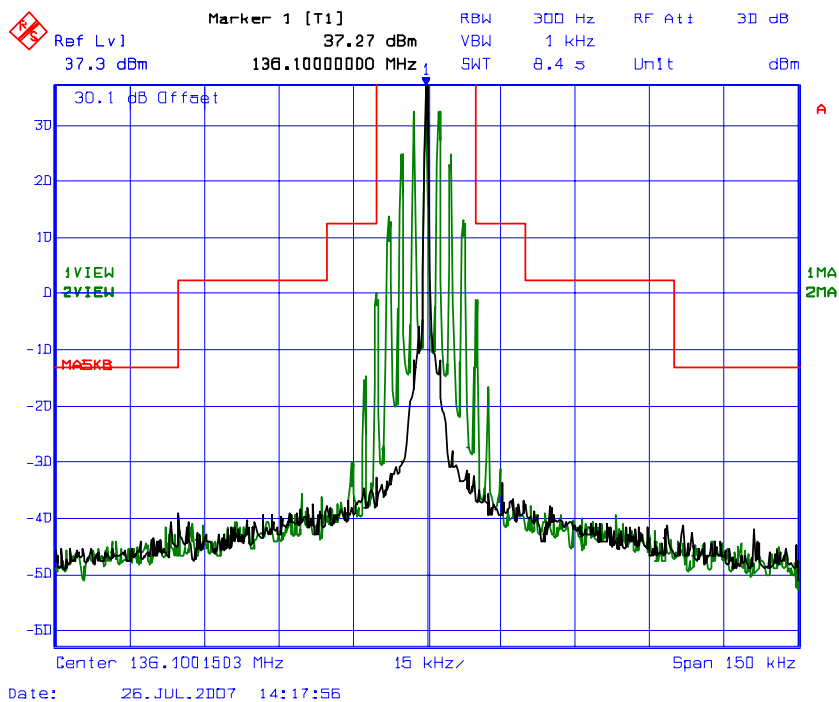

Plot # 14.:
Emission Mask B
Carrier Frequency: 155.1 MHz
Channel Spacing: 25 KHz
Power: 5 W
Modulation: FM with 2.5KHz sine wave

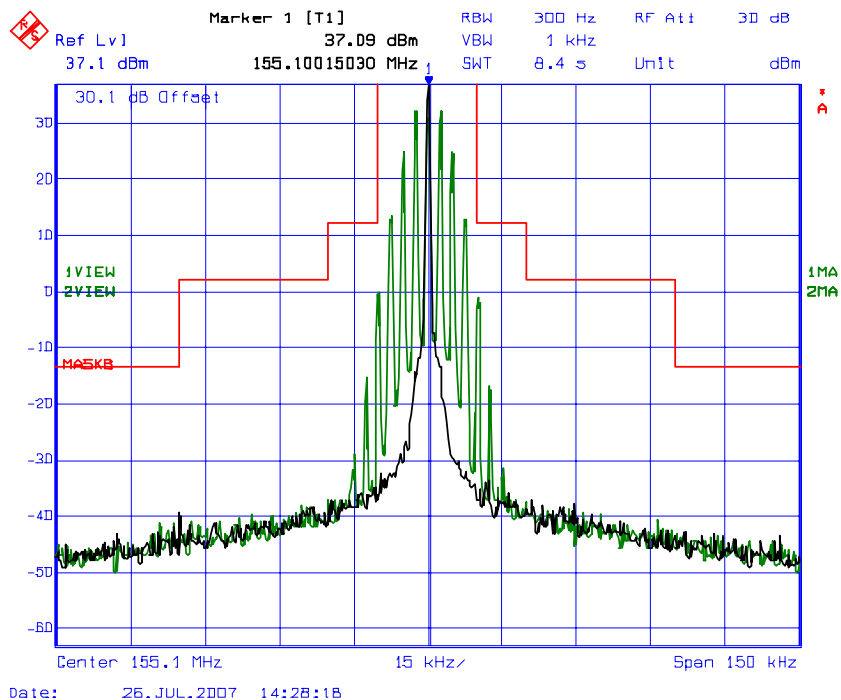

ULTRATECH GROUP OF LABS

3000 Bristol Circle, Oakville, Ontario, Canada L6H 6G4
Tel. #: 905-829-1570, Fax. #: 905-829-8050, Email: vic@ultratech-labs.com, Website: <http://www.ultratech-labs.com>

File #: ICOM-152F90

August 13, 2007

All test results contained in this engineering test report are traceable to National Institute of Standards and Technology (NIST)

Plot # 15.:
Emission Mask B
Carrier Frequency: 173.9 MHz
Channel Spacing: 25 KHz
Power: 5 W
Modulation: FM with 2.5KHz sine wave

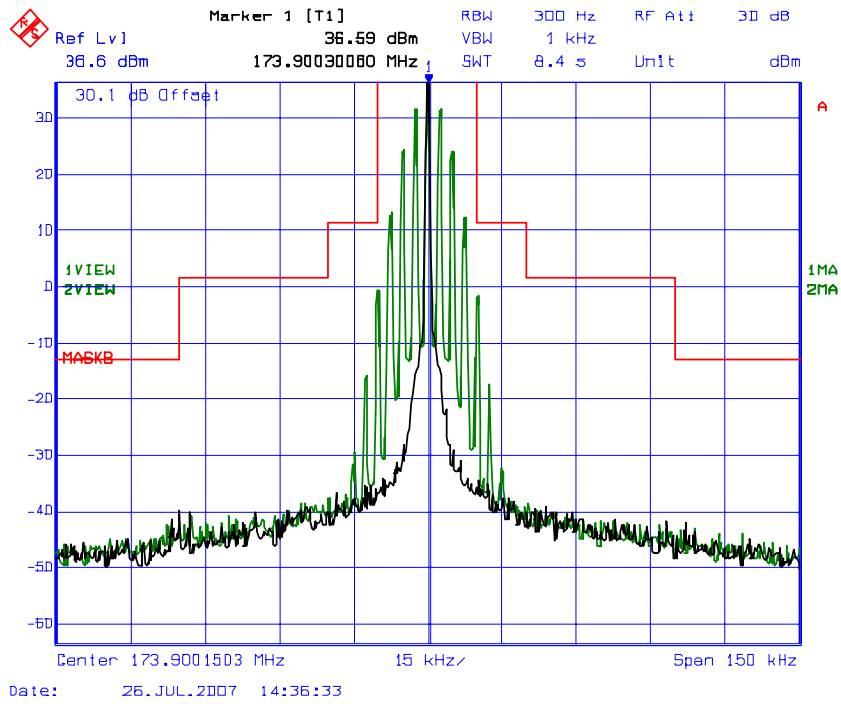

ULTRATECH GROUP OF LABS

3000 Bristol Circle, Oakville, Ontario, Canada L6H 6G4
Tel. #: 905-829-1570, Fax. #: 905-829-8050, Email: vic@ultratech-labs.com, Website: <http://www.ultratech-labs.com>

File #: ICOM-152F90

August 13, 2007

All test results contained in this engineering test report are traceable to National Institute of Standards and Technology (NIST)

Plot # 16.:
Emission Mask B
Carrier Frequency: 136.1 MHz
Channel Spacing: 25 KHz
Power: 1 W
Modulation: FM with 2.5KHz sine wave

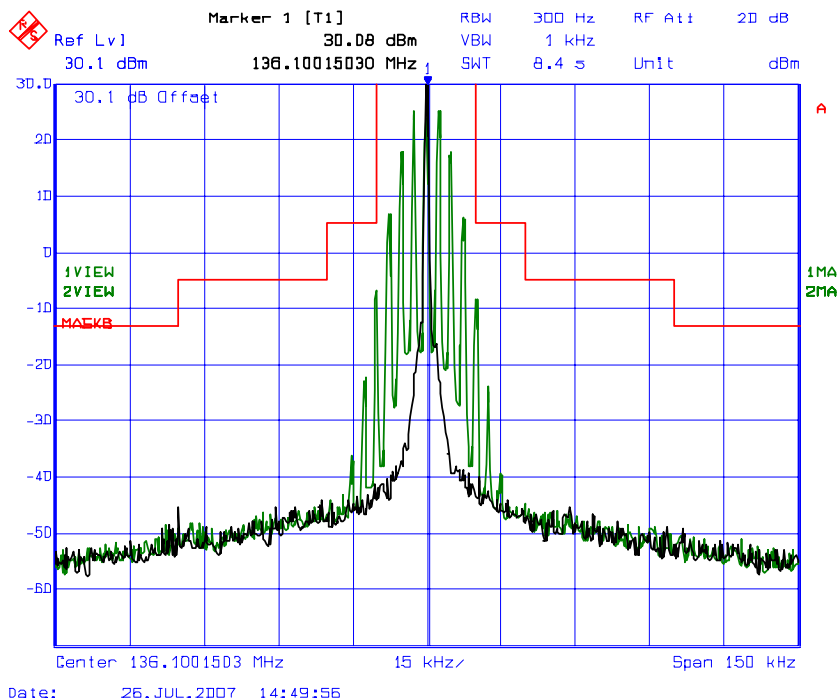

ULTRATECH GROUP OF LABS

3000 Bristol Circle, Oakville, Ontario, Canada L6H 6G4
Tel. #: 905-829-1570, Fax. #: 905-829-8050, Email: vic@ultratech-labs.com, Website: <http://www.ultratech-labs.com>

File #: ICOM-152F90

August 13, 2007

All test results contained in this engineering test report are traceable to National Institute of Standards and Technology (NIST)

Plot # 17.:
Emission Mask B
Carrier Frequency: 155.1 MHz
Channel Spacing: 25 KHz
Power: 1 W
Modulation: FM with 2.5KHz sine wave

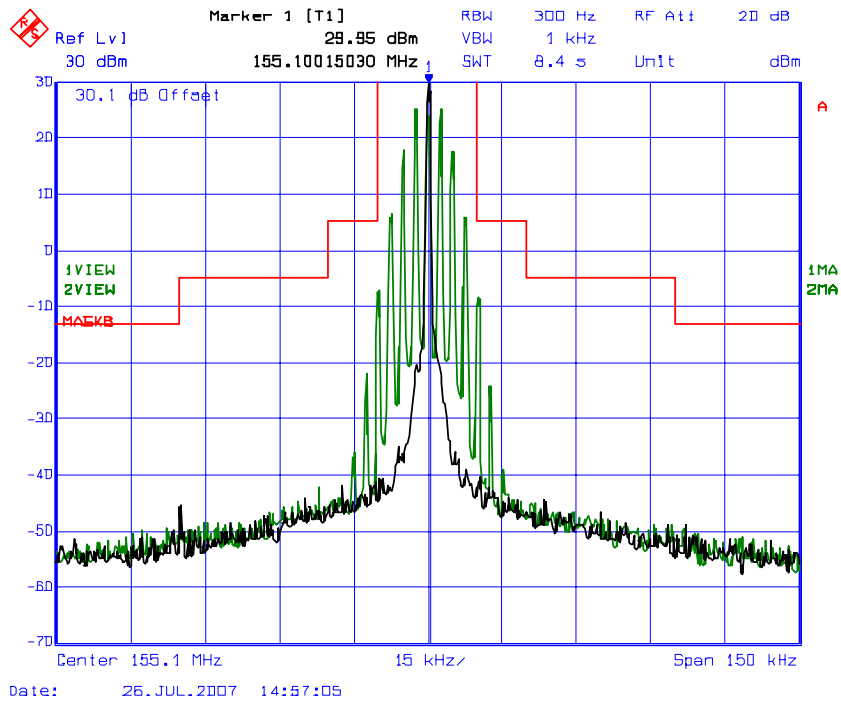

ULTRATECH GROUP OF LABS

3000 Bristol Circle, Oakville, Ontario, Canada L6H 6G4
Tel. #: 905-829-1570, Fax. #: 905-829-8050, Email: vic@ultratech-labs.com, Website: <http://www.ultratech-labs.com>

File #: ICOM-152F90

August 13, 2007

All test results contained in this engineering test report are traceable to National Institute of Standards and Technology (NIST)

Plot # 18.:
Emission Mask B
Carrier Frequency: 173.9 MHz
Channel Spacing: 25 KHz
Power: 1 W
Modulation: FM with 2.5KHz sine wave

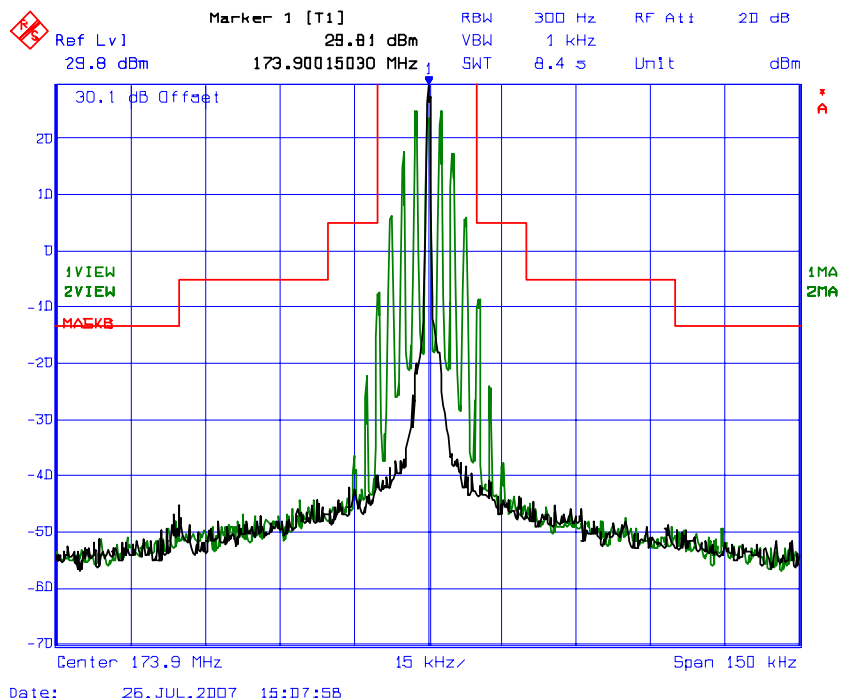

ULTRATECH GROUP OF LABS

3000 Bristol Circle, Oakville, Ontario, Canada L6H 6G4
Tel. #: 905-829-1570, Fax. #: 905-829-8050, Email: vic@ultratech-labs.com, Website: <http://www.ultratech-labs.com>

File #: ICOM-152F90

August 13, 2007

All test results contained in this engineering test report are traceable to National Institute of Standards and Technology (NIST)

Plot # 19.:
Emission Mask D
Carrier Frequency: 136.1 MHz
Channel Spacing: 12.5 KHz
Power: 5 W
Modulation: FM with 2.5KHz sine wave

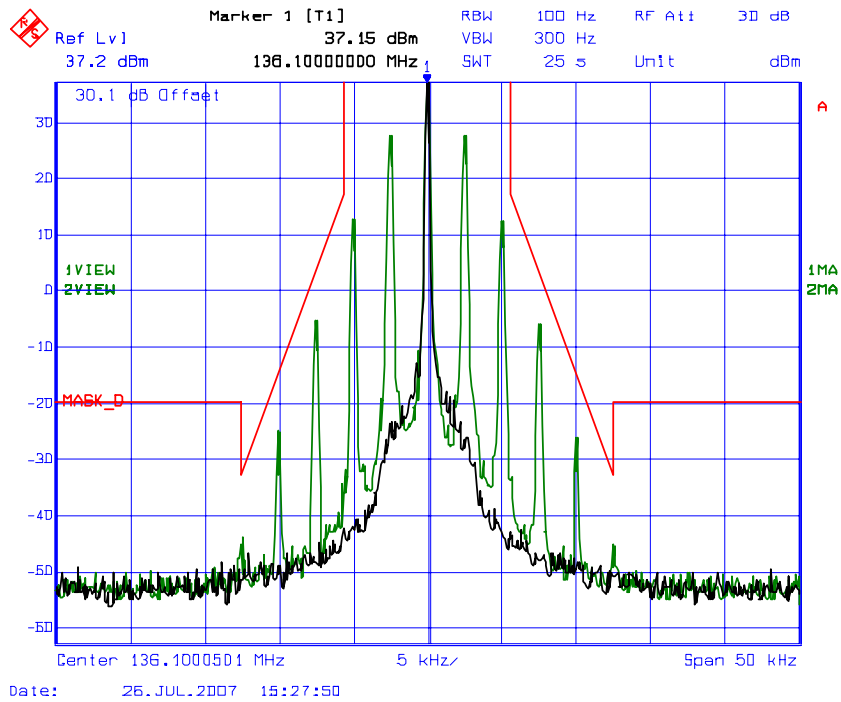

ULTRATECH GROUP OF LABS

3000 Bristol Circle, Oakville, Ontario, Canada L6H 6G4
Tel. #: 905-829-1570, Fax. #: 905-829-8050, Email: vic@ultratech-labs.com, Website: <http://www.ultratech-labs.com>

File #: ICOM-152F90

August 13, 2007

All test results contained in this engineering test report are traceable to National Institute of Standards and Technology (NIST)

Plot # 20.:
Emission Mask D
Carrier Frequency: 155.1 MHz
Channel Spacing: 12.5 KHz
Power: 5 W
Modulation: FM with 2.5KHz sine wave

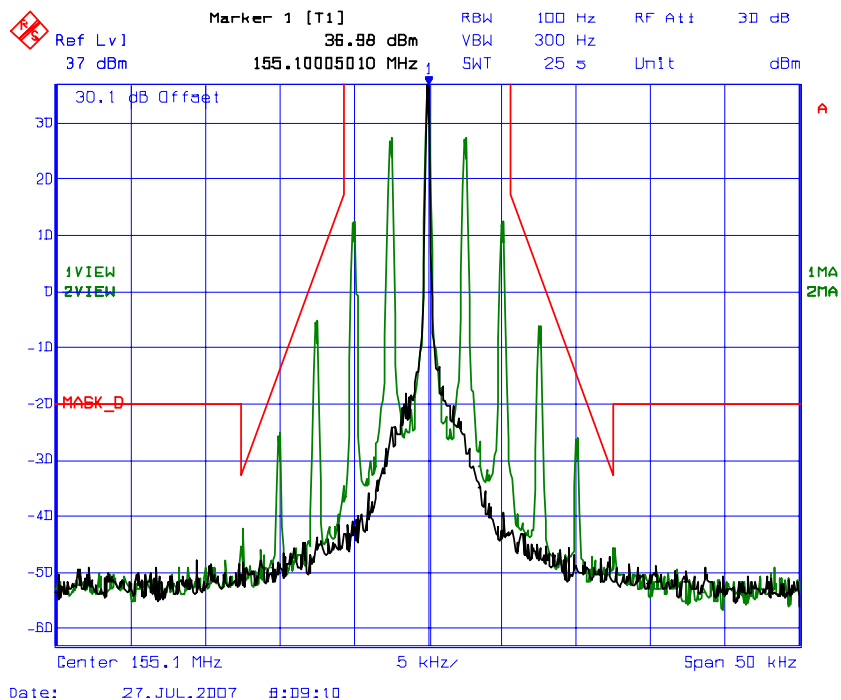

ULTRATECH GROUP OF LABS

3000 Bristol Circle, Oakville, Ontario, Canada L6H 6G4
Tel. #: 905-829-1570, Fax. #: 905-829-8050, Email: vic@ultratech-labs.com, Website: <http://www.ultratech-labs.com>

File #: ICOM-152F90

August 13, 2007

All test results contained in this engineering test report are traceable to National Institute of Standards and Technology (NIST)

Plot # 21.:
Emission Mask D
Carrier Frequency: 173.9 MHz
Channel Spacing: 12.5 KHz
Power: 5 W
Modulation: FM with 2.5KHz sine wave

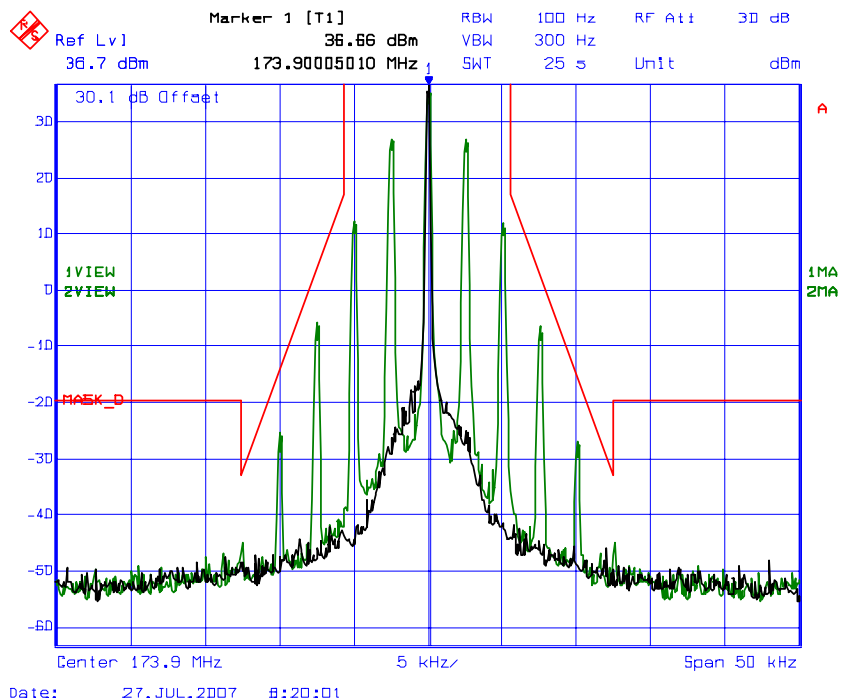

ULTRATECH GROUP OF LABS

3000 Bristol Circle, Oakville, Ontario, Canada L6H 6G4
Tel. #: 905-829-1570, Fax. #: 905-829-8050, Email: vic@ultratech-labs.com, Website: <http://www.ultratech-labs.com>

File #: ICOM-152F90

August 13, 2007

All test results contained in this engineering test report are traceable to National Institute of Standards and Technology (NIST)

Plot # 22.:
Emission Mask D
Carrier Frequency: 136.1 MHz
Channel Spacing: 12.5 KHz
Power: 1 W
Modulation: FM with 2.5KHz sine wave

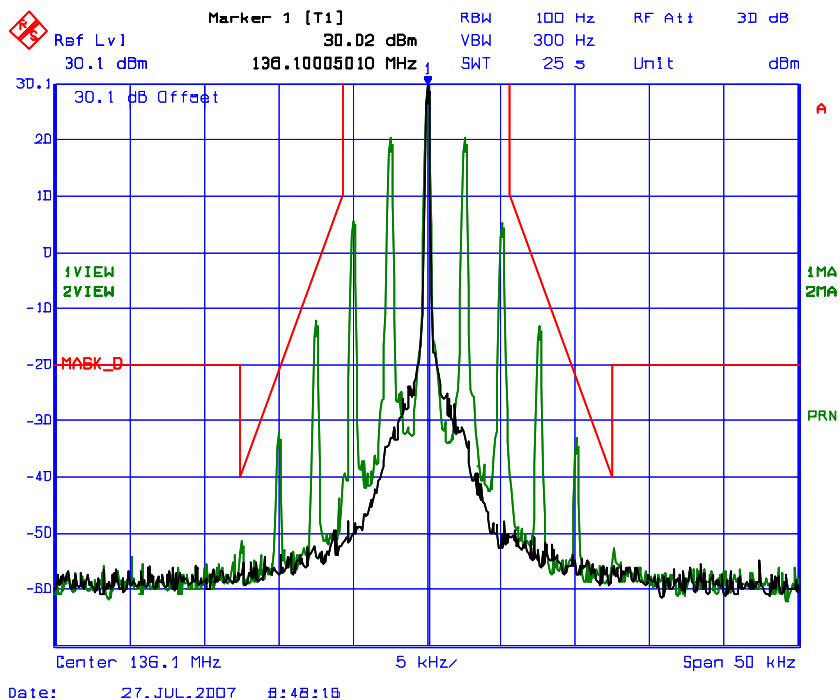

ULTRATECH GROUP OF LABS

3000 Bristol Circle, Oakville, Ontario, Canada L6H 6G4
Tel. #: 905-829-1570, Fax. #: 905-829-8050, Email: vic@ultratech-labs.com, Website: <http://www.ultratech-labs.com>

File #: ICOM-152F90

August 13, 2007

All test results contained in this engineering test report are traceable to National Institute of Standards and Technology (NIST)

Plot # 23.:
Emission Mask D
Carrier Frequency: 155.1 MHz
Channel Spacing: 12.5 KHz
Power: 1 W
Modulation: FM with 2.5KHz sine wave

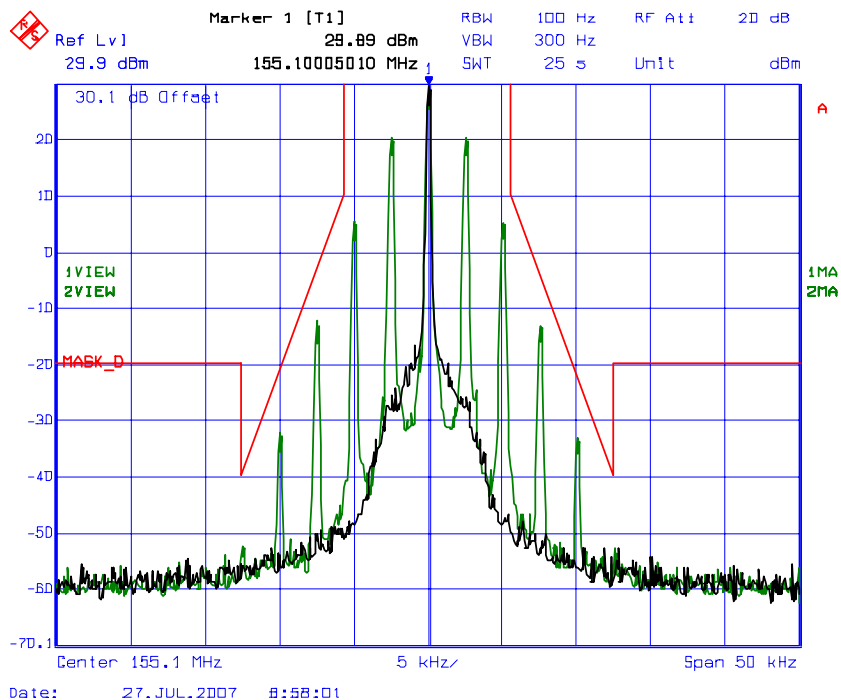

ULTRATECH GROUP OF LABS

3000 Bristol Circle, Oakville, Ontario, Canada L6H 6G4
Tel. #: 905-829-1570, Fax. #: 905-829-8050, Email: vic@ultratech-labs.com, Website: <http://www.ultratech-labs.com>

File #: ICOM-152F90

August 13, 2007

All test results contained in this engineering test report are traceable to National Institute of Standards and Technology (NIST)

Plot # 24.:
Emission Mask D
Carrier Frequency: 173.9 MHz
Channel Spacing: 12.5 KHz
Power: 1 W
Modulation: FM with 2.5KHz sine wave

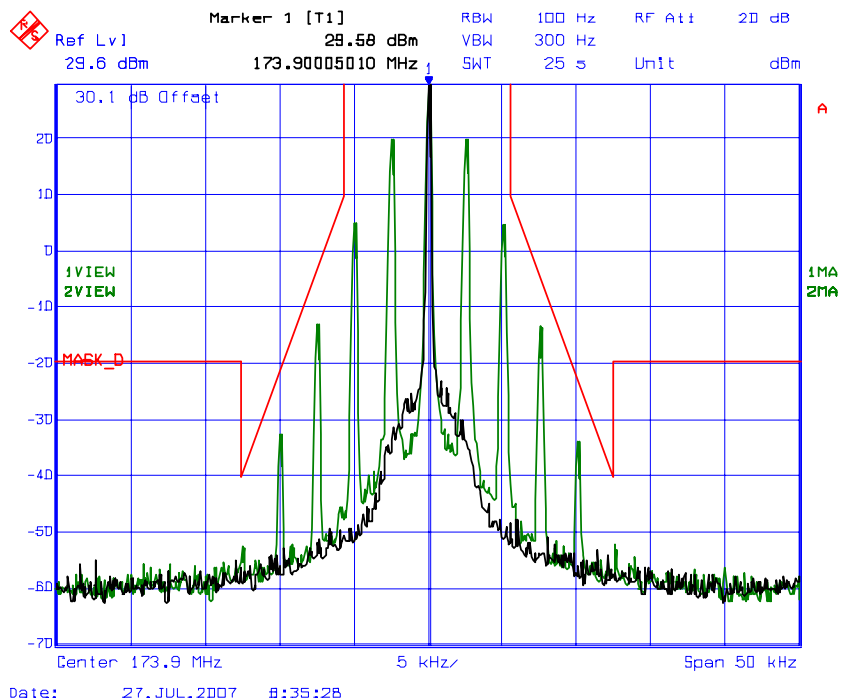

ULTRATECH GROUP OF LABS

3000 Bristol Circle, Oakville, Ontario, Canada L6H 6G4
Tel. #: 905-829-1570, Fax. #: 905-829-8050, Email: vic@ultratech-labs.com, Website: <http://www.ultratech-labs.com>

File #: ICOM-152F90

August 13, 2007

All test results contained in this engineering test report are traceable to National Institute of Standards and Technology (NIST)

Plot # 25.:
Emission Mask B
Carrier Frequency: 136.1 MHz
Channel Spacing: 25 KHz
Power: 5 W
Modulation: FM with 2.5KHz sine wave with Scrambler

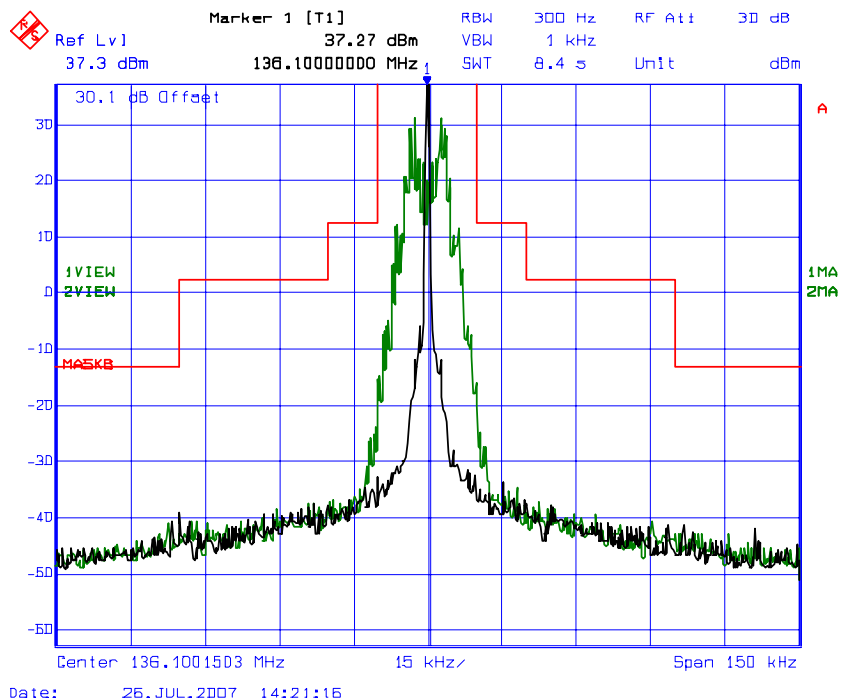

ULTRATECH GROUP OF LABS

3000 Bristol Circle, Oakville, Ontario, Canada L6H 6G4
Tel. #: 905-829-1570, Fax. #: 905-829-8050, Email: vic@ultratech-labs.com, Website: <http://www.ultratech-labs.com>

File #: ICOM-152F90

August 13, 2007

All test results contained in this engineering test report are traceable to National Institute of Standards and Technology (NIST)

Plot # 26.:
Emission Mask B
Carrier Frequency: 155.1 MHz
Channel Spacing: 25 KHz
Power: 5 W
Modulation: FM with 2.5KHz sine wave with Scrambler

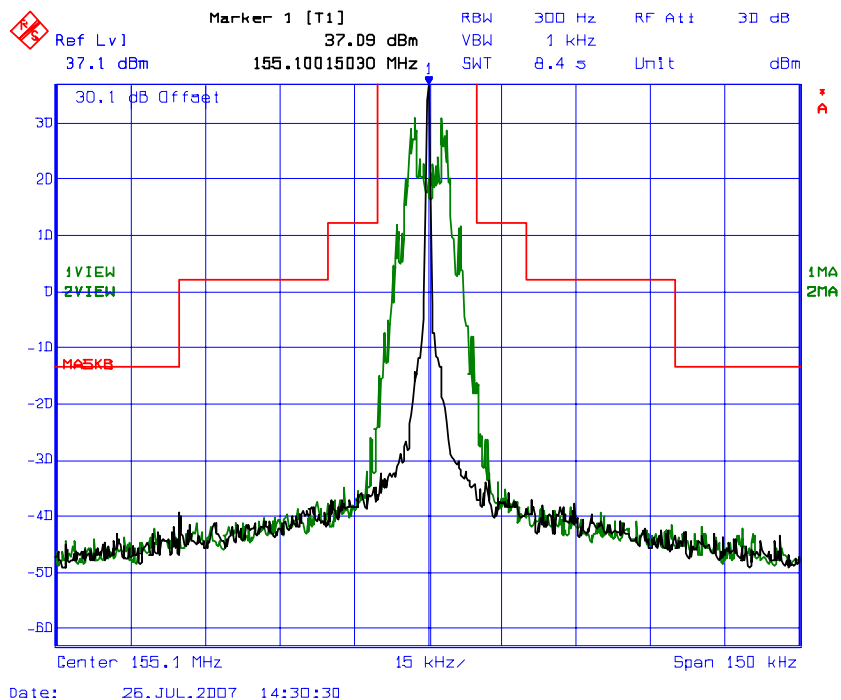

ULTRATECH GROUP OF LABS

3000 Bristol Circle, Oakville, Ontario, Canada L6H 6G4
Tel. #: 905-829-1570, Fax. #: 905-829-8050, Email: vic@ultratech-labs.com, Website: <http://www.ultratech-labs.com>

File #: ICOM-152F90

August 13, 2007

All test results contained in this engineering test report are traceable to National Institute of Standards and Technology (NIST)

Plot # 27.:
Emission Mask B
Carrier Frequency: 173.9 MHz
Channel Spacing: 25 KHz
Power: 5 W
Modulation: FM with 2.5KHz sine wave with Scrambler

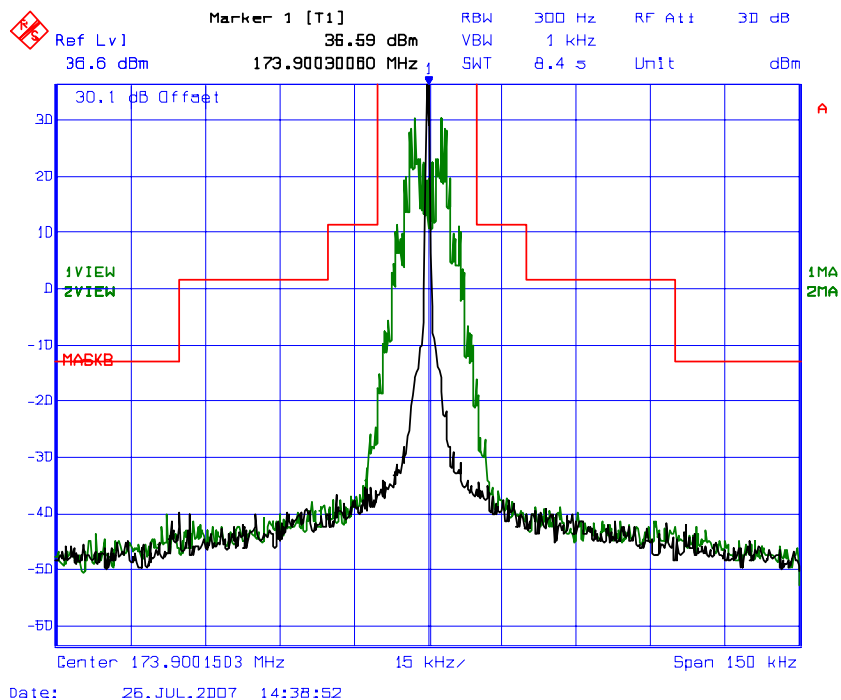

ULTRATECH GROUP OF LABS

3000 Bristol Circle, Oakville, Ontario, Canada L6H 6G4
Tel. #: 905-829-1570, Fax. #: 905-829-8050, Email: vic@ultratech-labs.com, Website: <http://www.ultratech-labs.com>

File #: ICOM-152F90

August 13, 2007

All test results contained in this engineering test report are traceable to National Institute of Standards and Technology (NIST)

Plot # 28.:
Emission Mask B
Carrier Frequency: 136.1 MHz
Channel Spacing: 25 KHz
Power: 1 W
Modulation: FM with 2.5KHz sine wave with Scrambler

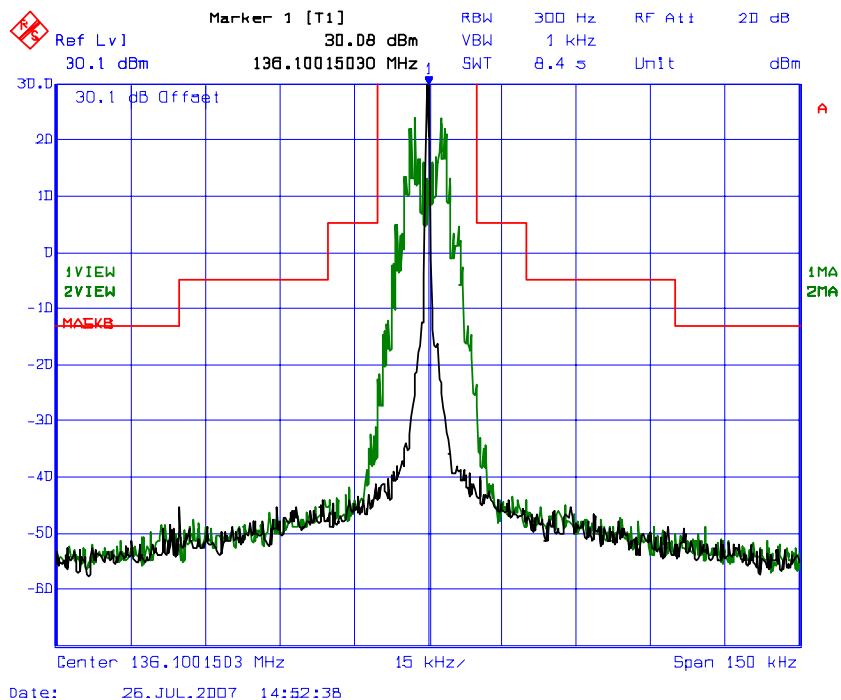

ULTRATECH GROUP OF LABS

3000 Bristol Circle, Oakville, Ontario, Canada L6H 6G4
Tel. #: 905-829-1570, Fax. #: 905-829-8050, Email: vic@ultratech-labs.com, Website: <http://www.ultratech-labs.com>

File #: ICOM-152F90

August 13, 2007

All test results contained in this engineering test report are traceable to National Institute of Standards and Technology (NIST)

Plot # 29.:
Emission Mask B
Carrier Frequency: 155.1 MHz
Channel Spacing: 25 KHz
Power: 1 W
Modulation: FM with 2.5KHz sine wave with Scrambler

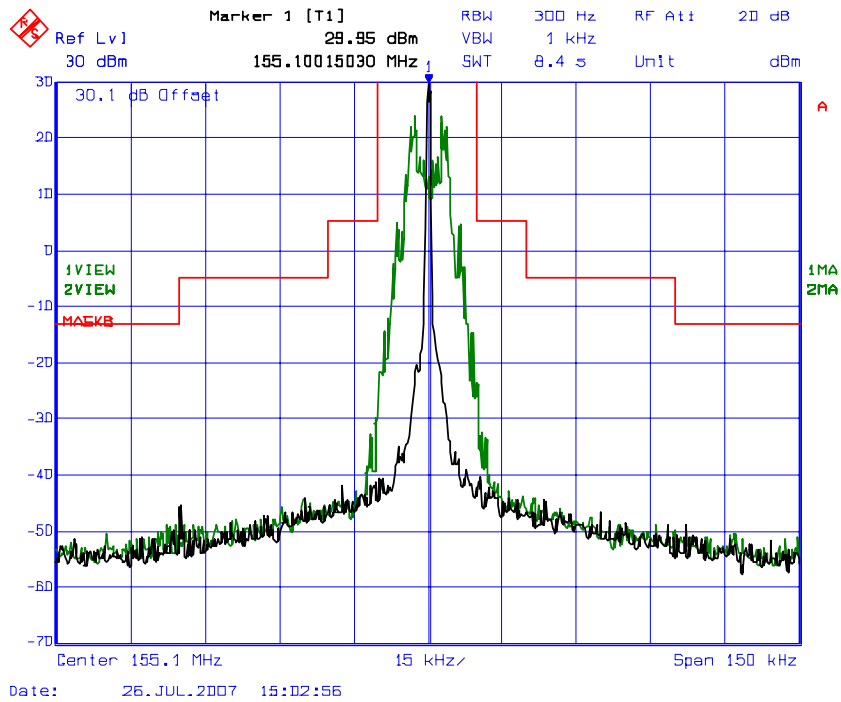

ULTRATECH GROUP OF LABS

3000 Bristol Circle, Oakville, Ontario, Canada L6H 6G4
Tel. #: 905-829-1570, Fax. #: 905-829-8050, Email: vic@ultratech-labs.com, Website: <http://www.ultratech-labs.com>

File #: ICOM-152F90
August 13, 2007

All test results contained in this engineering test report are traceable to National Institute of Standards and Technology (NIST)

Plot # 30.:
Emission Mask B
Carrier Frequency: 173.9 MHz
Channel Spacing: 25 KHz
Power: 1 W
Modulation: FM with 2.5KHz sine wave with Scrambler

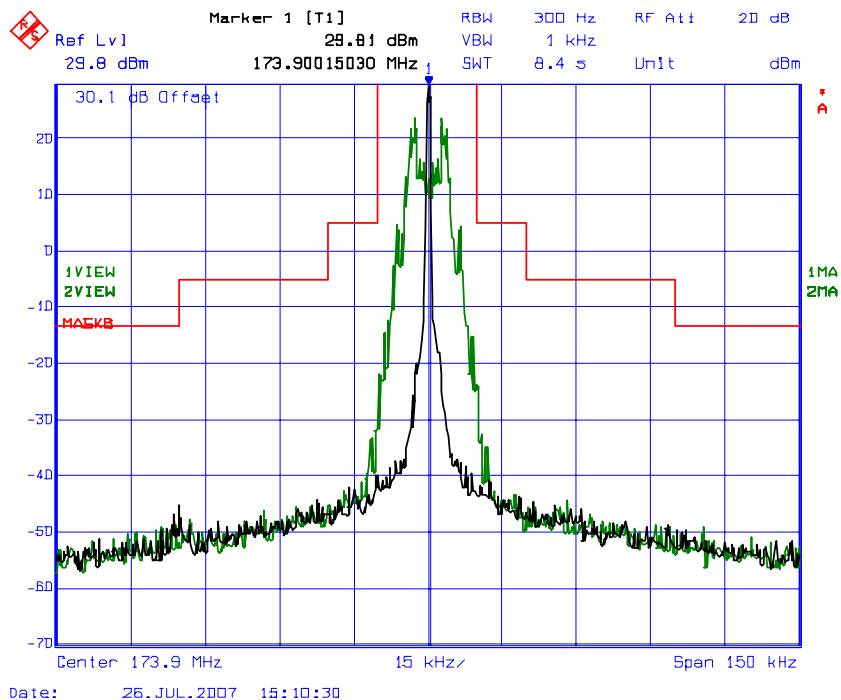

ULTRATECH GROUP OF LABS

3000 Bristol Circle, Oakville, Ontario, Canada L6H 6G4
Tel. #: 905-829-1570, Fax. #: 905-829-8050, Email: vic@ultratech-labs.com, Website: <http://www.ultratech-labs.com>

File #: ICOM-152F90

August 13, 2007

All test results contained in this engineering test report are traceable to National Institute of Standards and Technology (NIST)

Plot # 31.:
Emission Mask D
Carrier Frequency: 136.1 MHz
Channel Spacing: 12.5 KHz
Power: 5 W
Modulation: FM with 2.5KHz sine wave with Scrambler

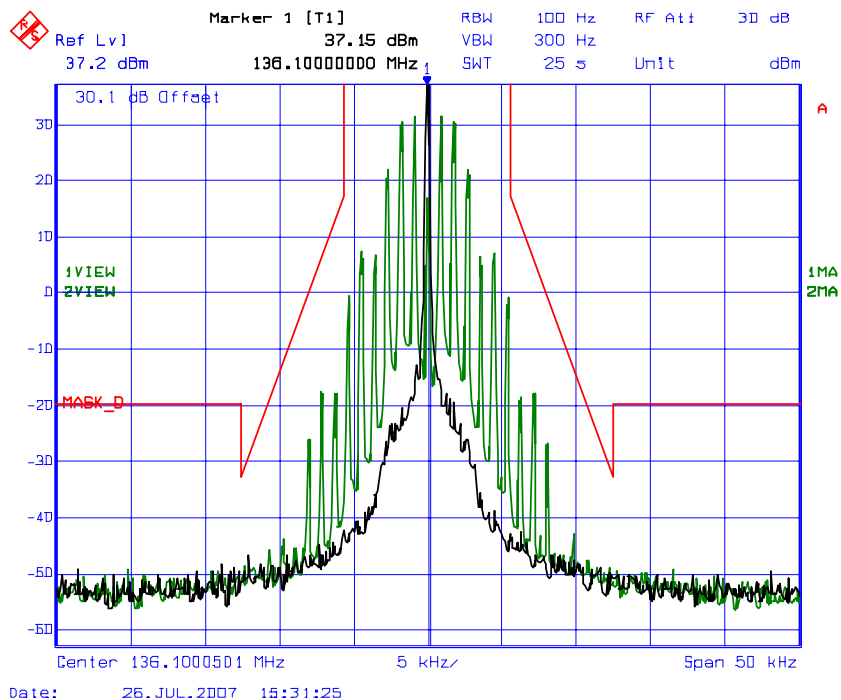

ULTRATECH GROUP OF LABS

3000 Bristol Circle, Oakville, Ontario, Canada L6H 6G4
Tel. #: 905-829-1570, Fax. #: 905-829-8050, Email: vic@ultratech-labs.com, Website: <http://www.ultratech-labs.com>

File #: ICOM-152F90

August 13, 2007

All test results contained in this engineering test report are traceable to National Institute of Standards and Technology (NIST)

Plot # 32.:
Emission Mask D
Carrier Frequency: 155.1 MHz
Channel Spacing: 12.5 KHz
Power: 5 W
Modulation: FM with 2.5KHz sine wave with Scrambler

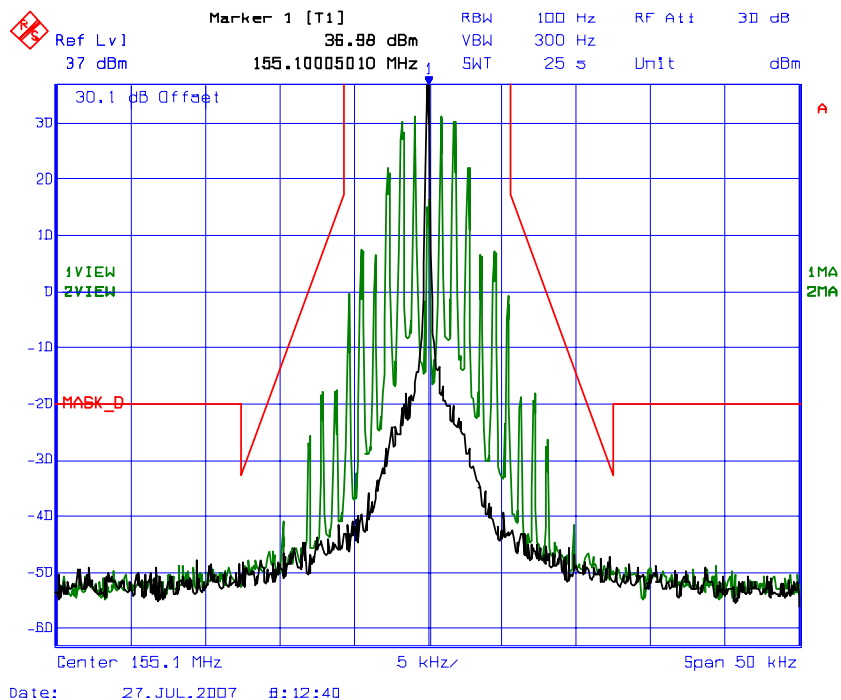

ULTRATECH GROUP OF LABS

3000 Bristol Circle, Oakville, Ontario, Canada L6H 6G4
Tel. #: 905-829-1570, Fax. #: 905-829-8050, Email: vic@ultratech-labs.com, Website: <http://www.ultratech-labs.com>

File #: ICOM-152F90

August 13, 2007

All test results contained in this engineering test report are traceable to National Institute of Standards and Technology (NIST)

Plot # 33.:
Emission Mask D
Carrier Frequency: 173.9 MHz
Channel Spacing: 12.5 KHz
Power: 5 W
Modulation: FM with 2.5KHz sine wave with Scrambler

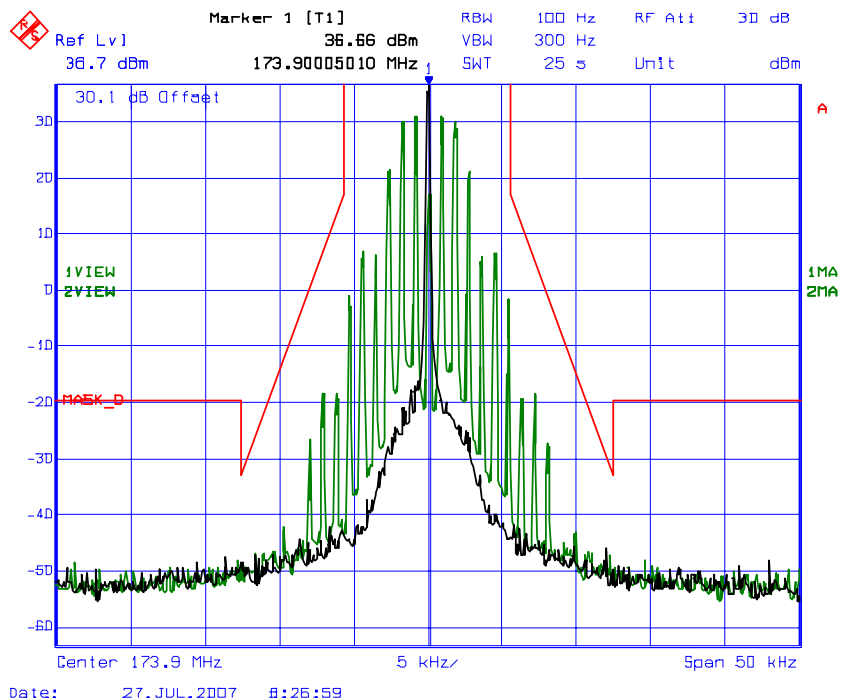

ULTRATECH GROUP OF LABS

3000 Bristol Circle, Oakville, Ontario, Canada L6H 6G4
Tel. #: 905-829-1570, Fax. #: 905-829-8050, Email: vic@ultratech-labs.com, Website: <http://www.ultratech-labs.com>

File #: ICOM-152F90

August 13, 2007

All test results contained in this engineering test report are traceable to National Institute of Standards and Technology (NIST)

Plot # 34.:
Emission Mask D
Carrier Frequency: 136.1 MHz
Channel Spacing: 12.5 KHz
Power: 1 W
Modulation: FM with 2.5KHz sine wave with Scrambler

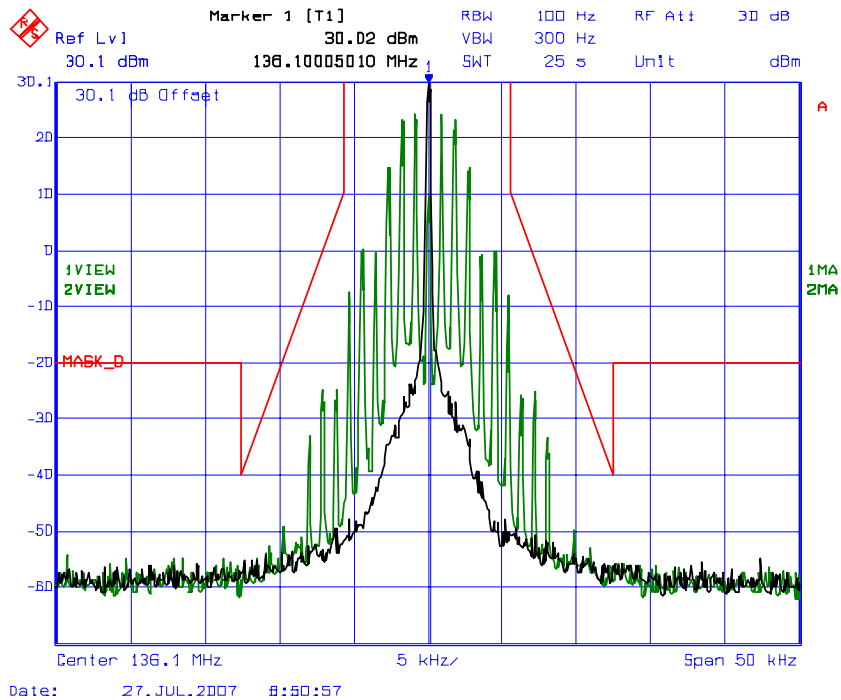

ULTRATECH GROUP OF LABS

3000 Bristol Circle, Oakville, Ontario, Canada L6H 6G4
Tel. #: 905-829-1570, Fax. #: 905-829-8050, Email: vic@ultratech-labs.com, Website: <http://www.ultratech-labs.com>

File #: ICOM-152F90

August 13, 2007

All test results contained in this engineering test report are traceable to National Institute of Standards and Technology (NIST)

Plot # 35.:
Emission Mask D
Carrier Frequency: 155.1 MHz
Channel Spacing: 12.5 KHz
Power: 1 W
Modulation: FM with 2.5KHz sine wave with Scrambler

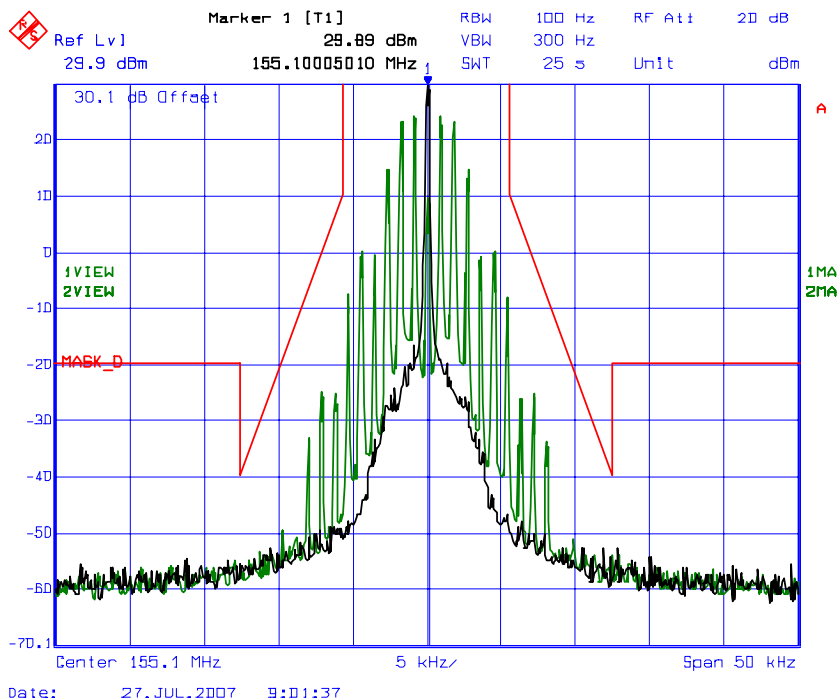

ULTRATECH GROUP OF LABS

3000 Bristol Circle, Oakville, Ontario, Canada L6H 6G4
Tel. #: 905-829-1570, Fax. #: 905-829-8050, Email: vic@ultratech-labs.com, Website: <http://www.ultratech-labs.com>

File #: ICOM-152F90

August 13, 2007

All test results contained in this engineering test report are traceable to National Institute of Standards and Technology (NIST)

Plot # 36.:
Emission Mask D
Carrier Frequency: 173.9 MHz
Channel Spacing: 12.5 KHz
Power: 1 W
Modulation: FM with 2.5KHz sine wave with Scrambler

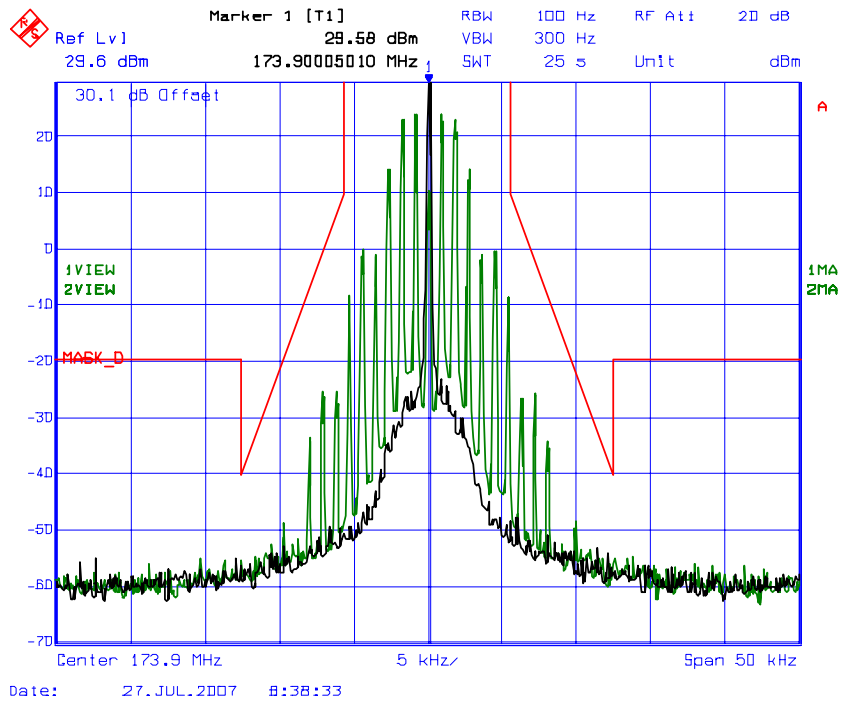

ULTRATECH GROUP OF LABS

3000 Bristol Circle, Oakville, Ontario, Canada L6H 6G4
Tel. #: 905-829-1570, Fax. #: 905-829-8050, Email: vic@ultratech-labs.com, Website: <http://www.ultratech-labs.com>

File #: ICOM-152F90

August 13, 2007

All test results contained in this engineering test report are traceable to National Institute of Standards and Technology (NIST)

6.10. TRANSMITTER ANTENNA POWER SPURIOUS/HARMONIC CONDUCTED EMISSIONS [§ 90.210]

6.10.1. Limits

Emissions shall be attenuated below the mean output power of the transmitter as follows:

| FCC Rules | Frequency Range | Attenuation Limit (dBc) |
|-----------|--|--|
| 90.210(b) | 10 MHz to Lowest frequency of the radio to 10 th harmonic of the highest frequency of the radio | At least 43 + 10 log(P) or -13 dBm |
| 90.210(d) | 10 MHz to Lowest frequency of the radio to 10 th harmonic of the highest frequency of the radio | At least 50 + 10 log (P) dB or 70 dB, whichever is the lesser attenuation. |
| 90.210(e) | 10 MHz to Lowest frequency of the radio to 10 th harmonic of the highest frequency of the radio | At least 55 + 10 log (P) or 65 dB, whichever is the lesser attenuation. |

6.10.2. Method of Measurements

Refer to Exhibit 8 Section 8.5 of this report for measurement details

6.10.3. Test Equipment List

| Test Instruments | Manufacturer | Model No. | Serial No. | Frequency Range |
|----------------------------|-----------------|-----------|------------|------------------------------|
| RF Communications Test Set | Hewlett Packard | 8920B | US39064699 | RF 30M-1G AF DC-25KHz |
| Digital Voltmeter | Hewlett-Packard | 3456A | 2015A04523 | DC-250 KHz |
| Spectrum Analyzer | Advantest | R3271 | 15050203 | 100Hz-26.5GHz |
| Attenuator | Weinschel Corp | 23-20-34 | BH7876 | DC-18 GHz |
| Digital Multimeter | Tenma | 72-6202 | 2080027 | DC-100 KHz |
| Power Supply | Tenma | 72-6153 | -- | DC 0-20 V, 0-10A. |
| High Pass Filter | Mini-Circuits | SHP-800 | -- | Cut-off Frequency at 750 MHz |

6.10.4. Test Arrangement

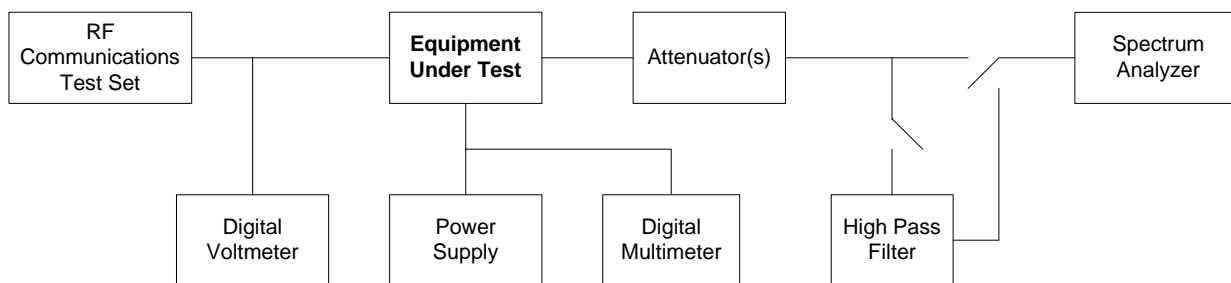

ULTRATECH GROUP OF LABS

3000 Bristol Circle, Oakville, Ontario, Canada L6H 6G4
 Tel. #: 905-829-1570, Fax. #: 905-829-8050, Email: vic@ultratech-labs.com, Website: <http://www.ultratech-labs.com>

File #: ICOM-152F90
 August 13, 2007

All test results contained in this engineering test report are traceable to National Institute of Standards and Technology (NIST)

6.10.5. Test Data

Note: There was no difference in spurious/harmonic emissions on the pre-scans for different channel spacing and modulation types. Therefore, the rf spurious/harmonic emissions in this section would be performed for 12.5 KHz channel spacing and the more stringent limit of $50 + 10 \cdot \log(P)$ would be applied for worst case.

6.10.5.1. Near Lowest Frequency (136.1 MHz)

Carrier Frequency (MHz): 136.1
Power (dBm): 37.40
Limit (dBc): 57.40

All emissions found were more than 20 dB below the permissible limits.

Plot # 37.:
Spurious Emissions at Antenna Terminals
Carrier Frequency: 136.1 MHz
Channel Spacing: 12.5 KHz
Power: 5 W
Modulation: FM with 2.5 KHz sine wave signal

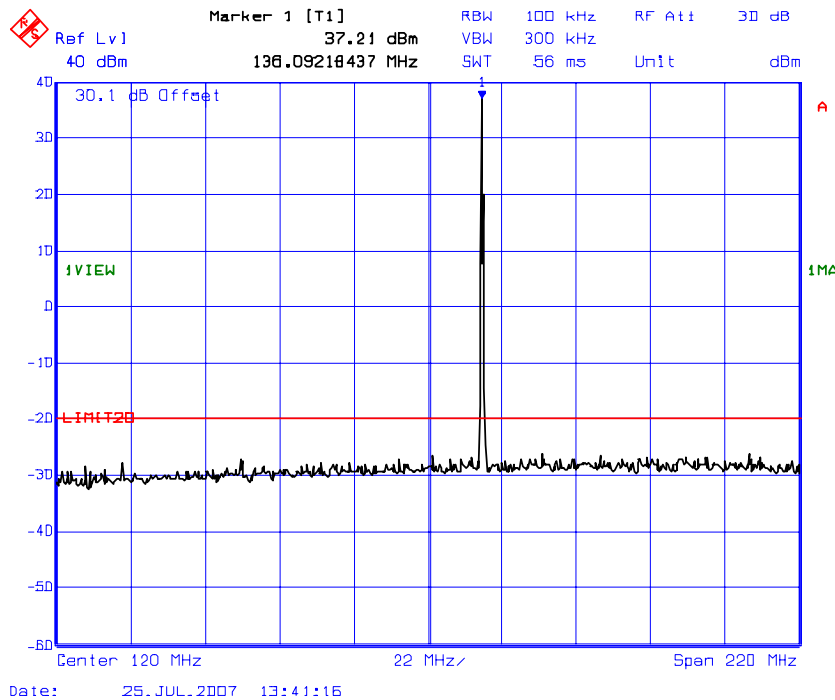

ULTRATECH GROUP OF LABS

3000 Bristol Circle, Oakville, Ontario, Canada L6H 6G4
Tel. #: 905-829-1570, Fax. #: 905-829-8050, Email: vic@ultratech-labs.com, Website: <http://www.ultratech-labs.com>

File #: ICOM-152F90
August 13, 2007

All test results contained in this engineering test report are traceable to National Institute of Standards and Technology (NIST)

Plot # 38.:
Spurious Emissions at Antenna Terminals
Carrier Frequency: 136.1 MHz
Channel Spacing: 12.5 KHz
Power: 5 W
Modulation: FM with 2.5 KHz sine wave signal

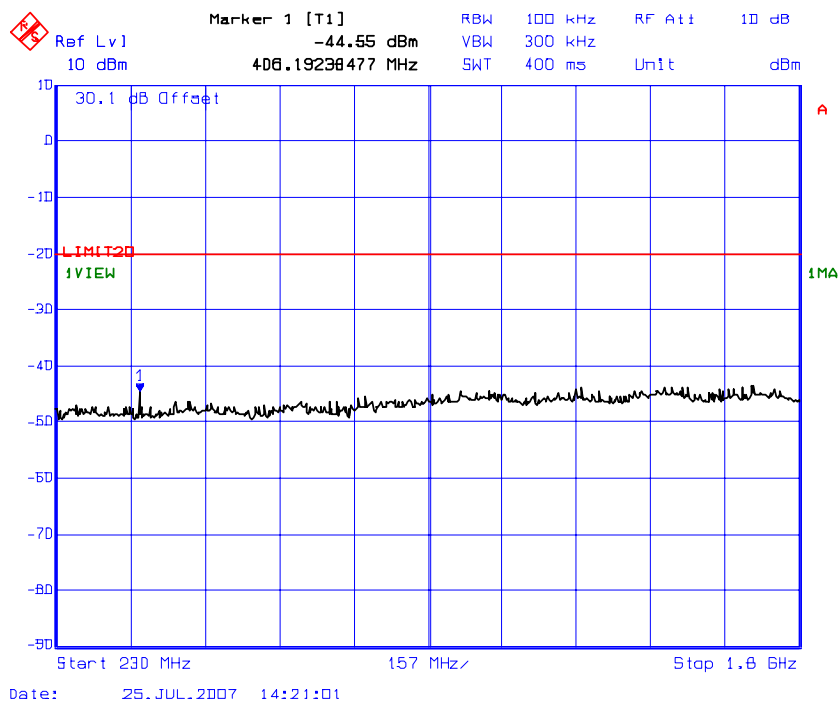

ULTRATECH GROUP OF LABS

3000 Bristol Circle, Oakville, Ontario, Canada L6H 6G4
Tel. #: 905-829-1570, Fax. #: 905-829-8050, Email: vic@ultratech-labs.com, Website: <http://www.ultratech-labs.com>

File #: ICOM-152F90

August 13, 2007

All test results contained in this engineering test report are traceable to National Institute of Standards and Technology (NIST)

Carrier Frequency (MHz): 136.1
Power (dBm): 30.32
Limit (dBc): 50.32

All emissions found were more than 20 dB below the permissible limits.

Plot # 39.:
Spurious Emissions at Antenna Terminals
Carrier Frequency: 136.1 MHz
Channel Spacing: 12.5 KHz
Power: 1 W
Modulation: FM with 2.5 KHz sine wave signal

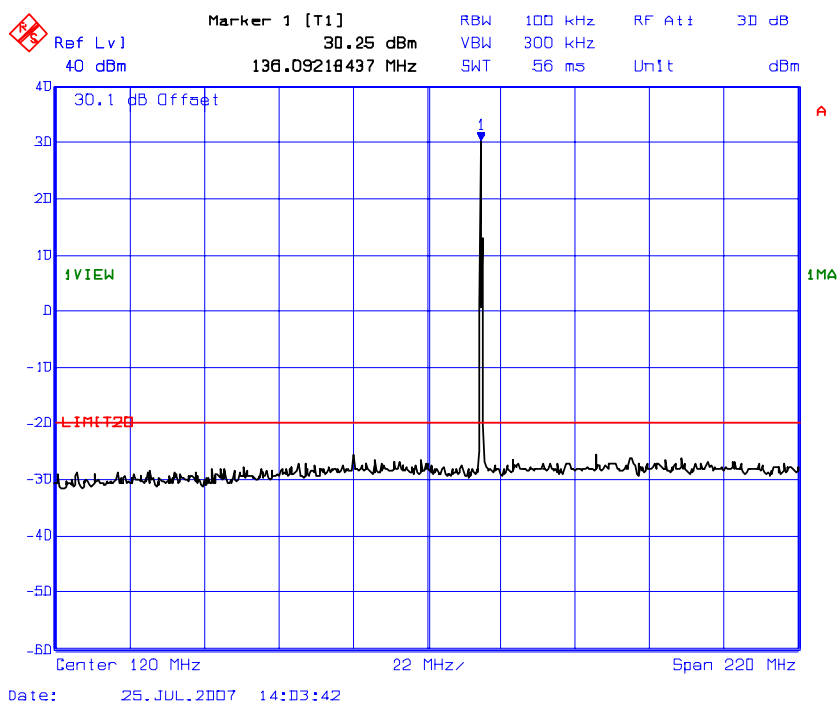

ULTRATECH GROUP OF LABS

3000 Bristol Circle, Oakville, Ontario, Canada L6H 6G4
Tel. #: 905-829-1570, Fax. #: 905-829-8050, Email: vic@ultratech-labs.com, Website: <http://www.ultratech-labs.com>

File #: ICOM-152F90

August 13, 2007

All test results contained in this engineering test report are traceable to National Institute of Standards and Technology (NIST)

Plot # 40.:
Spurious Emissions at Antenna Terminals
Carrier Frequency: 136.1 MHz
Channel Spacing: 12.5 KHz
Power: 1 W
Modulation: FM with 2.5 KHz sine wave signal

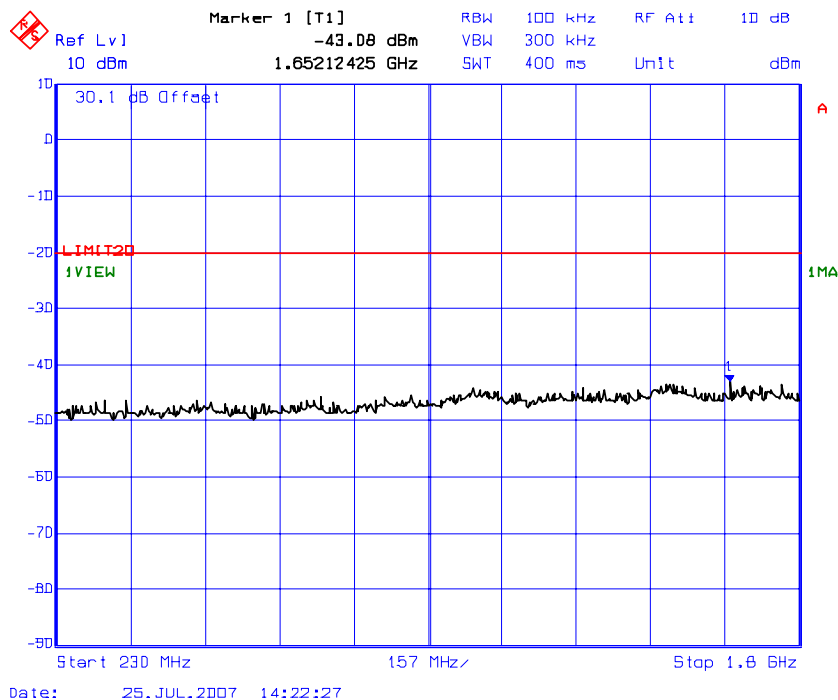

ULTRATECH GROUP OF LABS

3000 Bristol Circle, Oakville, Ontario, Canada L6H 6G4
Tel. #: 905-829-1570, Fax. #: 905-829-8050, Email: vic@ultratech-labs.com, Website: <http://www.ultratech-labs.com>

File #: ICOM-152F90
August 13, 2007

All test results contained in this engineering test report are traceable to National Institute of Standards and Technology (NIST)

6.10.5.2. Near Middle Frequency (155.1 MHz)

Carrier Frequency (MHz): 155.1
Power (dBm): 37.33
Limit (dBc): 57.33

All emissions found were more than 20 dB below the permissible limits.

Plot # 41.:
Spurious Emissions at Antenna Terminals
Carrier Frequency: 155.1 MHz
Channel Spacing: 12.5 KHz
Power: 5 W
Modulation: FM with 2.5 KHz sine wave signal

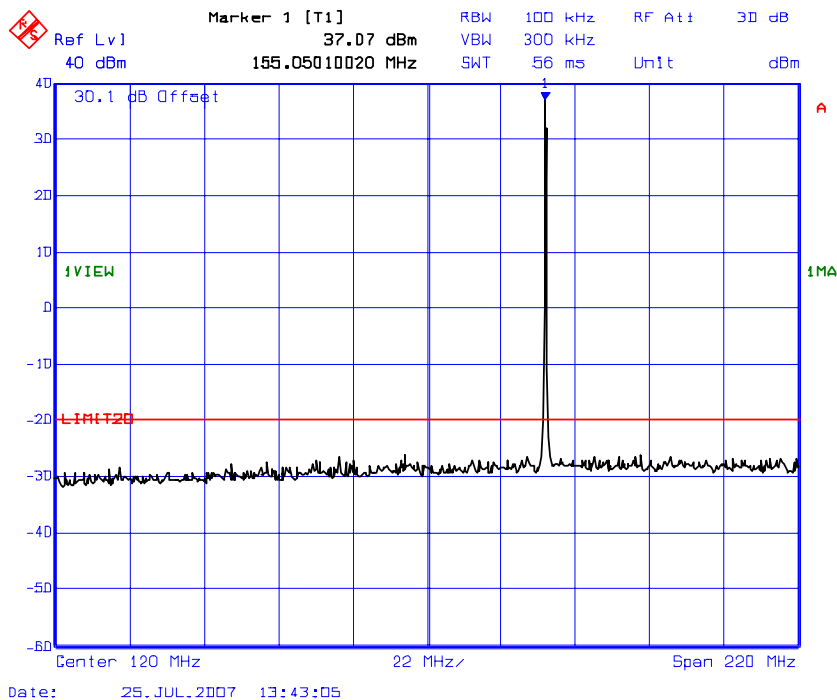

ULTRATECH GROUP OF LABS

3000 Bristol Circle, Oakville, Ontario, Canada L6H 6G4
Tel. #: 905-829-1570, Fax. #: 905-829-8050, Email: vic@ultratech-labs.com, Website: <http://www.ultratech-labs.com>

File #: ICOM-152F90
August 13, 2007

All test results contained in this engineering test report are traceable to National Institute of Standards and Technology (NIST)

Plot # 42.:
Spurious Emissions at Antenna Terminals
Carrier Frequency: 155.1 MHz
Channel Spacing: 12.5 KHz
Power: 5 W
Modulation: FM with 2.5 KHz sine wave signal

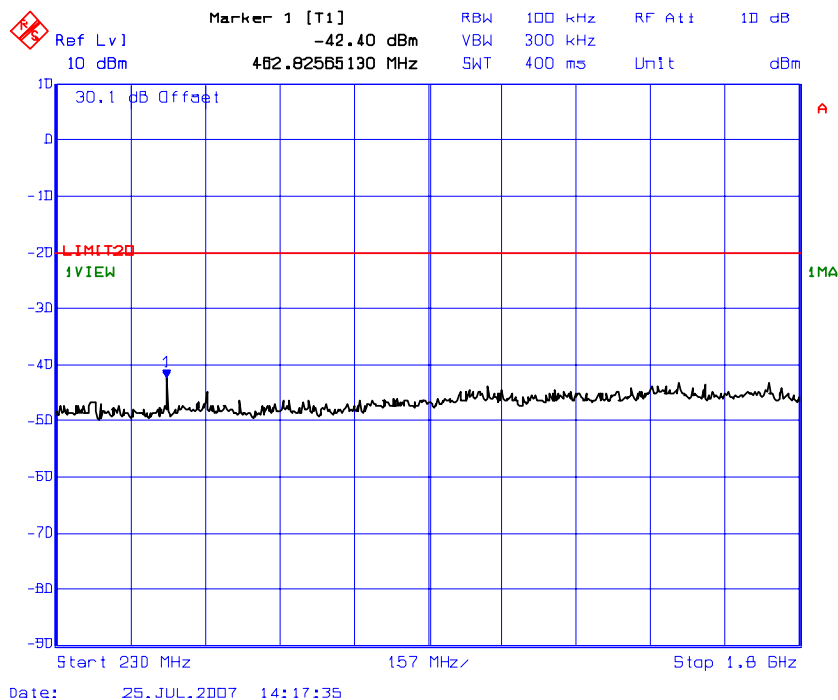

Carrier Frequency (MHz): 155.1
Power (dBm): 30.26
Limit (dBc): 50.26

All emissions found were more than 20 dB below the permissible limits.

Plot # 43.:
Spurious Emissions at Antenna Terminals
Carrier Frequency: 155.1 MHz
Channel Spacing: 12.5 KHz
Power: 1 W
Modulation: FM with 2.5 KHz sine wave signal

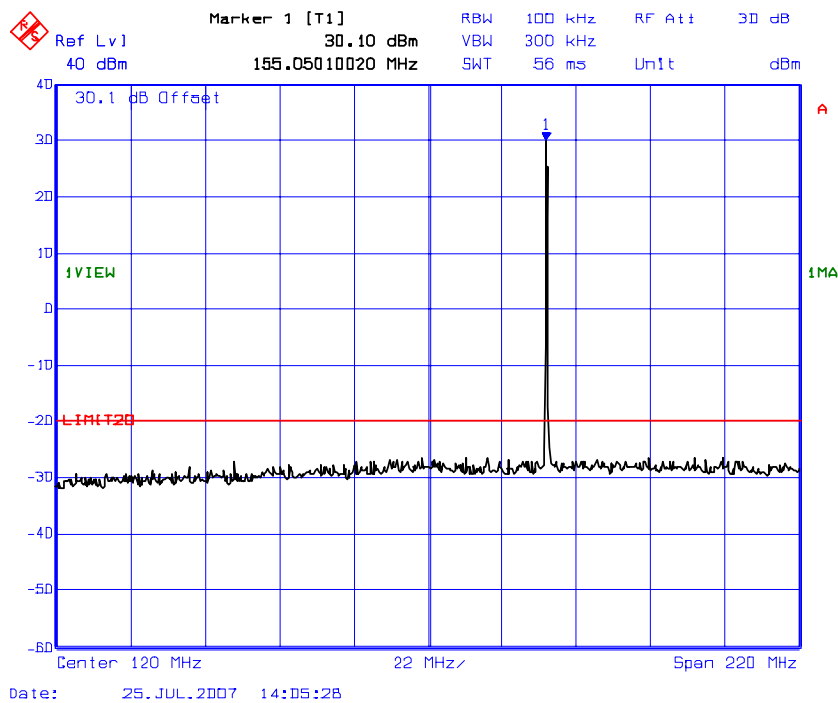

ULTRATECH GROUP OF LABS

3000 Bristol Circle, Oakville, Ontario, Canada L6H 6G4
Tel. #: 905-829-1570, Fax. #: 905-829-8050, Email: vic@ultratech-labs.com, Website: <http://www.ultratech-labs.com>

File #: ICOM-152F90
August 13, 2007

All test results contained in this engineering test report are traceable to National Institute of Standards and Technology (NIST)

Plot # 44.:
Spurious Emissions at Antenna Terminals
Carrier Frequency: 155.1 MHz
Channel Spacing: 12.5 KHz
Power: 1 W
Modulation: FM with 2.5 KHz sine wave signal

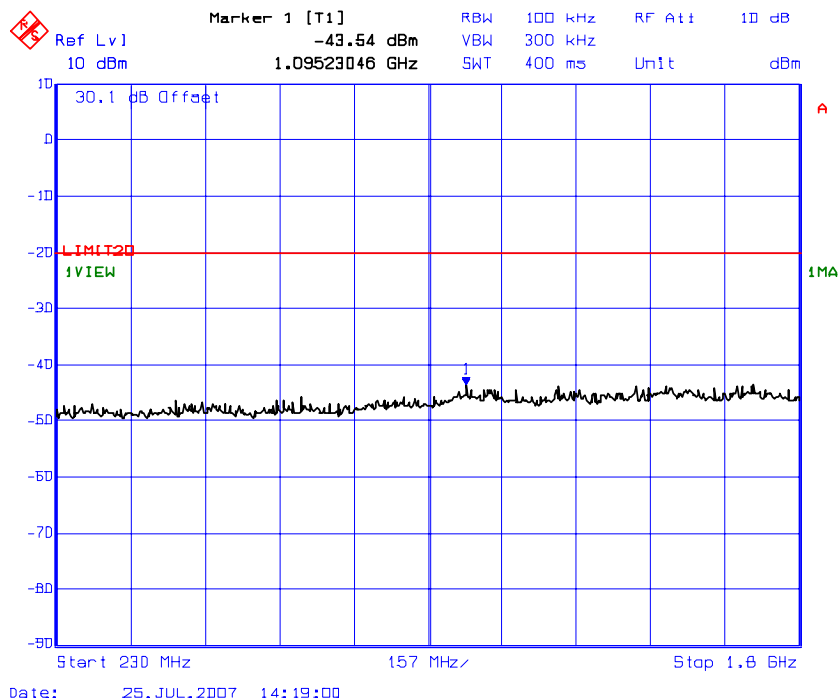

ULTRATECH GROUP OF LABS

3000 Bristol Circle, Oakville, Ontario, Canada L6H 6G4
Tel. #: 905-829-1570, Fax. #: 905-829-8050, Email: vic@ultratech-labs.com, Website: <http://www.ultratech-labs.com>

File #: ICOM-152F90

August 13, 2007

All test results contained in this engineering test report are traceable to National Institute of Standards and Technology (NIST)

6.10.5.3. Near Highest Frequency (173.9 MHz)

Carrier Frequency (MHz): 173.9
Power (dBm): 37.04
Limit (dBc): 57.04

All emissions found were more than 20 dB below the permissible limits.

Plot # 45.:
Spurious Emissions at Antenna Terminals
Carrier Frequency: 173.9 MHz
Channel Spacing: 12.5 KHz
Power: 5 W
Modulation: FM with 2.5 KHz sine wave signal

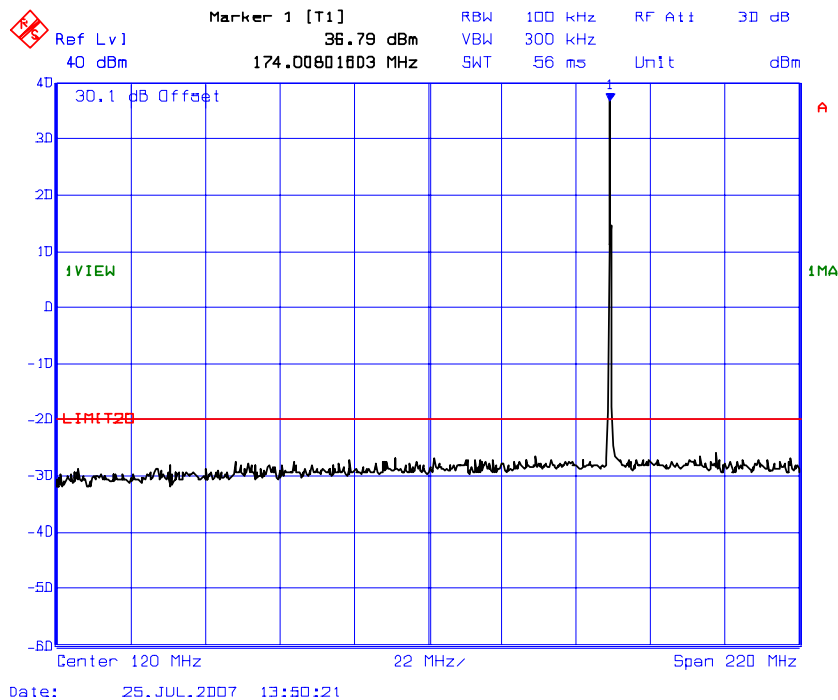

ULTRATECH GROUP OF LABS

3000 Bristol Circle, Oakville, Ontario, Canada L6H 6G4
Tel. #: 905-829-1570, Fax. #: 905-829-8050, Email: vic@ultratech-labs.com, Website: <http://www.ultratech-labs.com>

File #: ICOM-152F90

August 13, 2007

All test results contained in this engineering test report are traceable to National Institute of Standards and Technology (NIST)

Plot # 46.:
Spurious Emissions at Antenna Terminals
Carrier Frequency: 173.9 MHz
Channel Spacing: 12.5 KHz
Power: 5 W
Modulation: FM with 2.5 KHz sine wave signal

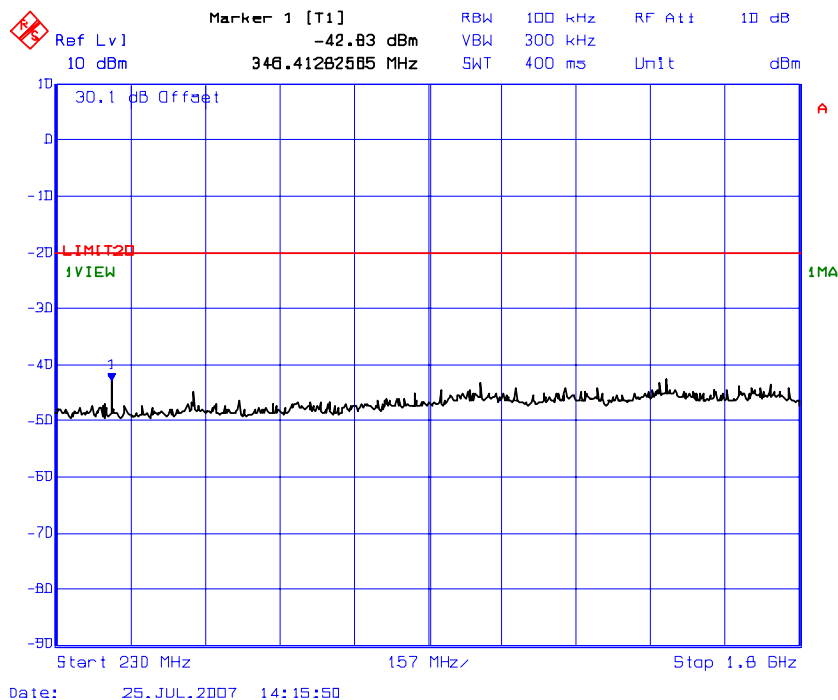

ULTRATECH GROUP OF LABS

3000 Bristol Circle, Oakville, Ontario, Canada L6H 6G4
Tel. #: 905-829-1570, Fax. #: 905-829-8050, Email: vic@ultratech-labs.com, Website: <http://www.ultratech-labs.com>

File #: ICOM-152F90

August 13, 2007

All test results contained in this engineering test report are traceable to National Institute of Standards and Technology (NIST)

Carrier Frequency (MHz): 173.9
Power (dBm): 30.11
Limit (dBc): 50.11

All emissions found were more than 20 dB below the permissible limits.

Plot # 47.:
Spurious Emissions at Antenna Terminals
Carrier Frequency: 173.9 MHz
Channel Spacing: 12.5 KHz
Power: 1 W
Modulation: FM with 2.5 KHz sine wave signal

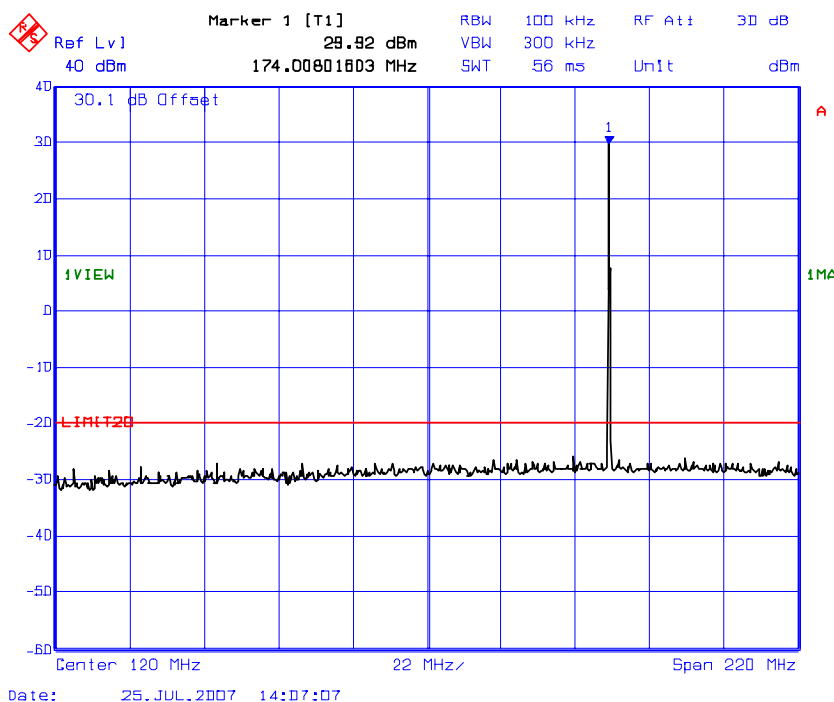

ULTRATECH GROUP OF LABS

3000 Bristol Circle, Oakville, Ontario, Canada L6H 6G4
Tel. #: 905-829-1570, Fax. #: 905-829-8050, Email: vic@ultratech-labs.com, Website: <http://www.ultratech-labs.com>

File #: ICOM-152F90
August 13, 2007

All test results contained in this engineering test report are traceable to National Institute of Standards and Technology (NIST)

Plot # 48.:
Spurious Emissions at Antenna Terminals
Carrier Frequency: 173.9 MHz
Channel Spacing: 12.5 KHz
Power: 1 W
Modulation: FM with 2.5 KHz sine wave signal

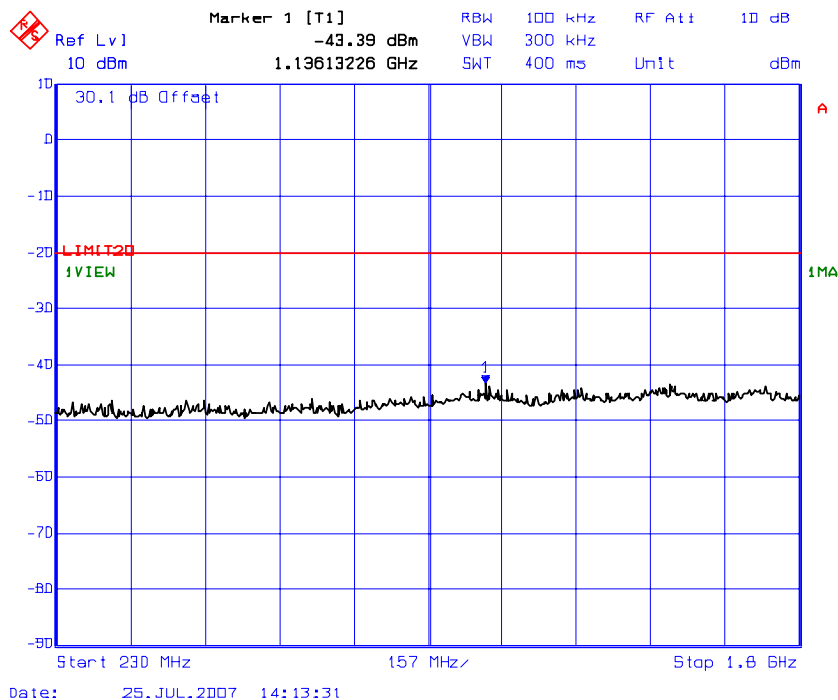

ULTRATECH GROUP OF LABS

3000 Bristol Circle, Oakville, Ontario, Canada L6H 6G4
Tel. #: 905-829-1570, Fax. #: 905-829-8050, Email: vic@ultratech-labs.com, Website: <http://www.ultratech-labs.com>

File #: ICOM-152F90

August 13, 2007

All test results contained in this engineering test report are traceable to National Institute of Standards and Technology (NIST)

6.11. TRANSMITTER SPURIOUS/HARMONIC RADIATED EMISSIONS [§ 90.210]

6.11.1. Limits

Emissions shall be attenuated below the mean output power of the transmitter as follows:

| FCC Rules | Frequency Range | Attenuation Limit (dBc) |
|-----------|--|--|
| 90.210(b) | 10 MHz to Lowest frequency of the radio to 10 th harmonic of the highest frequency of the radio | At least 43 + 10 log(P) or -13 dBm |
| 90.210(d) | 10 MHz to Lowest frequency of the radio to 10 th harmonic of the highest frequency of the radio | At least 50 + 10 log (P) dB or 70 dB, whichever is the lesser attenuation. |
| 90.210(e) | 10 MHz to Lowest frequency of the radio to 10 th harmonic of the highest frequency of the radio | At least 55 + 10 log (P) or 65 dB, whichever is the lesser attenuation. |

6.11.2. Method of Measurements

The spurious/harmonic ERP measurements are using substitution method specified in Exhibit 8, Section 8.2 of this report and its value in dBc is calculated as follows:

- (1) If the transmitter's antenna is an integral part of the EUT, the ERP is measured using substitution method.
- (2) If the transmitter's antenna is non-integral and diverse, the lowest ERP of the carrier with 0 dBi antenna gain is used for calculation of the spurious/harmonic emissions in dBc:
Lowest ERP of the carrier = EIRP – 2.15 dB = P_c + G - 2.15 dB = P_c dBm (conducted) + 0 dBi – 2.15 dB
- (3) Spurious /harmonic emissions levels expressed in dBc (dB below carrier) are as follows:

$$\text{ERP of spurious/harmonic (dBc)} = \text{ERP of carrier (dBm)} - \text{ERP of spurious/harmonic emission (dBm)}$$

6.11.3. Test Equipment List

| Test Instruments | Manufacturer | Model No. | Serial No. | Frequency Range |
|---------------------|-----------------|---------------|------------|------------------------------------|
| Spectrum Analyzer | Rohde&Schwarz | FSEK20/B4/B21 | 834157/005 | 9 KHz to 40 GHz |
| RF Amplifier | Com-Power | PA-102 | | 1 MHz to 1 GHz, 30 dB gain nominal |
| Microwave Amplifier | Hewlett Packard | HP 8449B | 3008A00769 | 1 GHz to 26.5 GHz, 30 dB nominal |
| Biconilog Antenna | EMCO | 3142 | 10005 | 30 MHz to 2 GHz |
| Dipole Antenna | EMCO | 3121C | 8907-434 | 30 GHz – 1 GHz |
| Dipole Antenna | EMCO | 3121C | 8907-440 | 30 GHz – 1 GHz |
| Horn Antenna | EMCO | 3155 | 9701-5061 | 1 GHz – 18 GHz |
| Horn Antenna | EMCO | 3155 | 9911-5955 | 1 GHz – 18 GHz |
| RF Signal Generator | Hewlett Packard | HP 83752B | 3610A00457 | 0.01 – 20 GHz |

6.11.4. Test Data

Remarks:

- The RF spurious/harmonic emission characteristics for different channel spacing are indistinguishable. Therefore, the following radiated emissions were performed at 12.5 KHz channel spacing operation, and the results were compared with the more stringent limit of $50+10*\log(P \text{ in Watts})$ for the worst-case.
- The radiated emissions were performed with high power setting (5 Watts) at 3 meters distance to represent the worst-case test configuration.
- The emissions were scanned from 30 MHz to 2.0 GHz; all emissions within 20 dB below the limits were recorded.

6.11.4.1. Near Lowest Frequency (136.1 MHz)

| | |
|---------------------------------|-------|
| Carrier Frequency (MHz): | 136.1 |
| Power (dBm): | 46.96 |
| Limit (dBc): | 71.96 |

All emissions found were more than 20 dB below the permissible limits.

6.11.4.2. Near Middle Frequency (155.1 MHz)

| | |
|---------------------------------|-------|
| Carrier Frequency (MHz): | 155.1 |
| Power (dBm): | 46.94 |
| Limit (dBc): | 71.94 |

All emissions found were more than 20 dB below the permissible limits.

6.11.4.3. Near Highest Frequency (173.9 MHz)

| | |
|---------------------------------|-------|
| Carrier Frequency (MHz): | 173.9 |
| Power (dBm): | 46.83 |
| Limit (dBc): | 71.83 |

All emissions found were more than 20 dB below the permissible limits.

6.12. TRANSIENT FREQUENCY BEHAVIOR [§ 90.214]

6.12.1. Limits

Transient frequencies must be within the maximum frequency difference limits during the time intervals indicated:

| Time intervals ^{1, 2} | Maximum frequency difference ³ | All equipment | |
|---|---|----------------|---------------|
| | | 150 to 174 MHz | 421 to 512MHz |
| Transient Frequency Behavior for Equipment Designed to Operate on 25 KHz Channels | | | |
| t ₁ ⁴ | ± 25.0 KHz | 5.0 ms | 10.0 ms |
| t ₂ | ± 12.5 KHz | 20.0 ms | 25.0 ms |
| t ₃ ⁴ | ± 25.0 KHz | 5.0 ms | 10.0 ms |
| Transient Frequency Behavior for Equipment Designed to Operate on 12.5 KHz Channels | | | |
| t ₁ ⁴ | ± 12.5 KHz | 5.0 ms | 10.0 ms |
| t ₂ | ± 6.25 KHz | 20.0 ms | 25.0 ms |
| t ₃ ⁴ | ± 12.5 KHz | 5.0 ms | 10.0 ms |
| Transient Frequency Behavior for Equipment Designed to Operate on 6.25 KHz Channels | | | |
| t ₁ ⁴ | ±6.25 KHz | 5.0 ms | 10.0 ms |
| t ₂ | ±3.125 KHz | 20.0 ms | 25.0 ms |
| t ₃ ⁴ | ±6.25 KHz | 5.0 ms | 10.0 ms |

- t_{on} is the instant when a 1 KHz test signal is completely suppressed, including any capture time due to phasing.
t₁ is the time period immediately following t_{on}.
t₂ is the time period immediately following t₁.
t₃ is the time period from the instant when the transmitter is turned off until t_{off}.
t_{off} is the instant when the 1 KHz test signal starts to rise.
- During the time from the end of t₂ to the beginning of t₃, the frequency difference must not exceed the limits specified in § 90.213.
- Difference between the actual transmitter frequency and the assigned transmitter frequency.
- If the transmitter carrier output power rating is 6 watts or less, the frequency difference during this time period may exceed the maximum frequency difference for this time period.

6.12.2. Method of Measurements

Refer to Exhibit 8, Section 8.6 of this test report and ANSI/TIA/EIA-603-B-2002, Section 2.2.19.

6.12.3. Test Equipment List

| Test Instruments | Manufacturer | Model No. | Serial No. | Frequency Range |
|----------------------------------|-----------------|-----------|------------|-----------------------|
| RF Communications Test Set | Hewlett Packard | 8920B | US39064699 | RF 30M-1G AF DC-25KHz |
| RF Synthesized Signal Generator | Gigatronic | 6061A | 5130408 | 10 KHz – 1050 MHz |
| Combiner | Mini-Circuit | ZFSC-3-4 | 15542 | 1 MHz – 1000 MHz |
| Infinium Digitizing Oscilloscope | Hewlett Packard | 54810A | US38380192 | DC - 500 MHz |
| RF Detector | Narda | 503A-03 | 0105 | 10 MHz – 18 GHz |
| Attenuator | Weinschel Corp | 23-20-34 | BH7876 | DC – 18 GHz |
| Modulation Analyzer | Hewlett Packard | 8901B | 3226A04606 | 150 KHz – 1300 MHz |
| Digital Voltmeter | Hewlett-Packard | 3456A | 2015A04523 | DC-250 KHz |

6.12.4. Test Arrangement

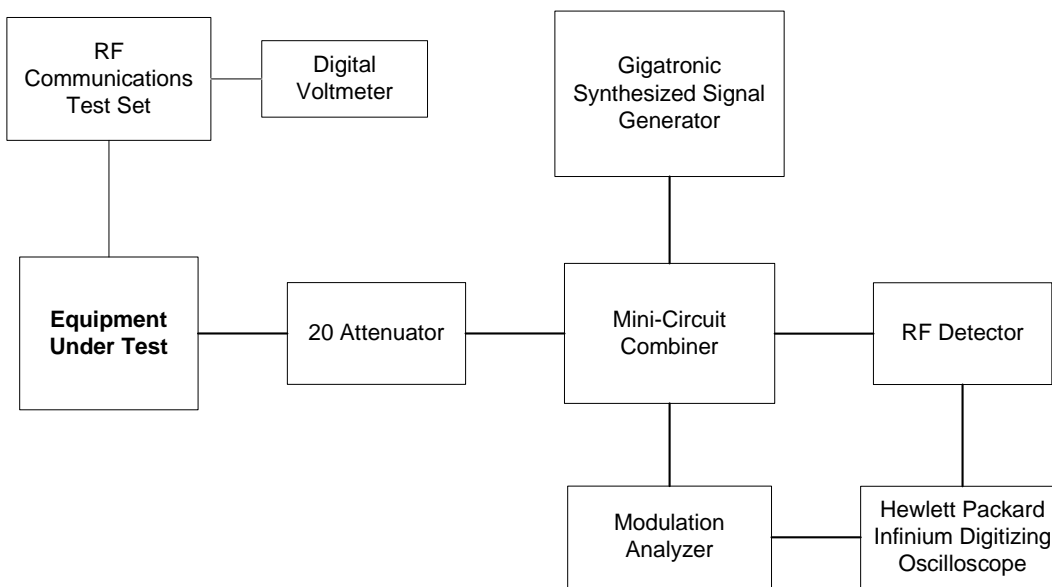

6.12.5. Test Data

6.12.5.1. Transient Frequency Behavior for 25 KHz Channel Spacing

Plot # 49:
Transient Frequency Behavior
Carrier Frequency: 136.1 MHz
Channel Spacing: 25 KHz
Power: 5 W
Description: Switch on condition t_{on} , t_1 , and t_2



Plot # 50.:
Transient Frequency Behavior
Carrier Frequency: 136.1 MHz
Channel Spacing: 25 KHz
Power: 5 W
Description: Switch off condition t_3 , t_{off}

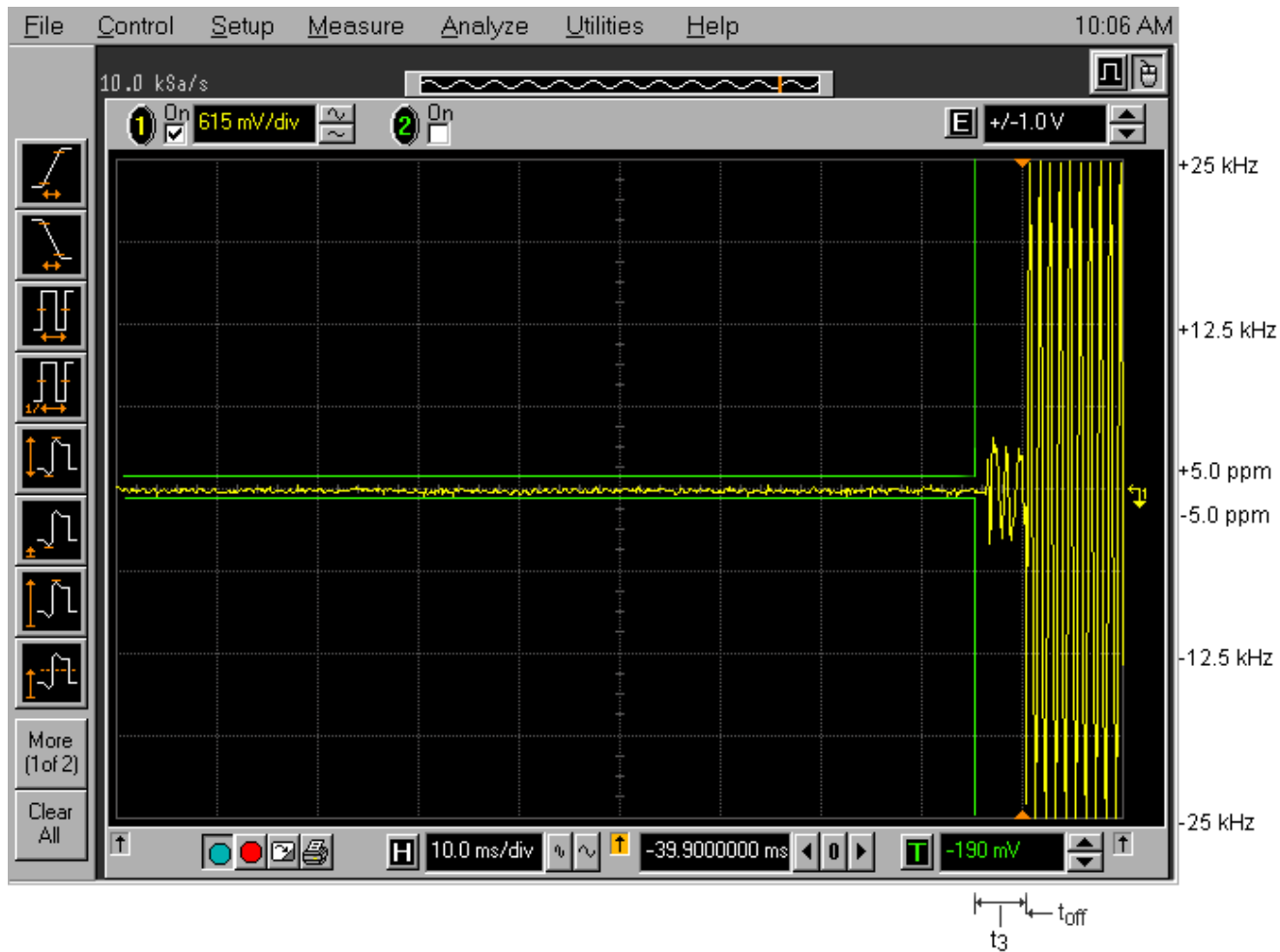

ULTRATECH GROUP OF LABS

3000 Bristol Circle, Oakville, Ontario, Canada L6H 6G4
Tel. #: 905-829-1570, Fax. #: 905-829-8050, Email: vic@ultratech-labs.com, Website: <http://www.ultratech-labs.com>

File #: ICOM-152F90
August 13, 2007

All test results contained in this engineering test report are traceable to National Institute of Standards and Technology (NIST)

6.12.5.2. Transient Frequency Behavior for 12.5 KHz Channel Spacing

Plot # 51.:
Transient Frequency Behavior
Carrier Frequency: 136.1 MHz
Channel Spacing: 12.5 KHz
Power: 5 W
Description: Switch on condition t_{on} , t_1 , and t_2

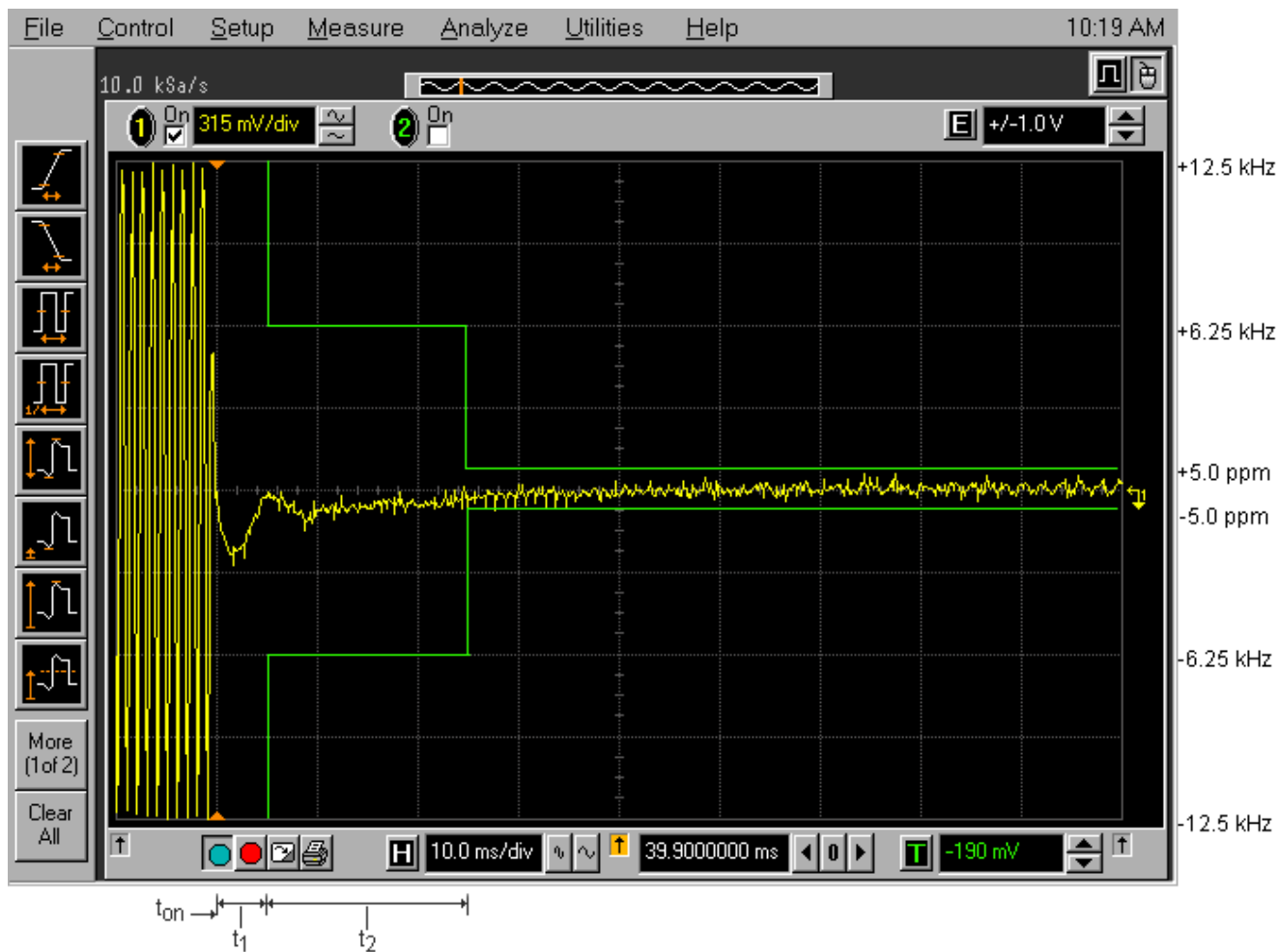

Plot # 52.:
Transient Frequency Behavior
Carrier Frequency: 136.1 MHz
Channel Spacing: 12.5 KHz
Power: 5 W
Description: Switch off condition t_3 , t_{off}

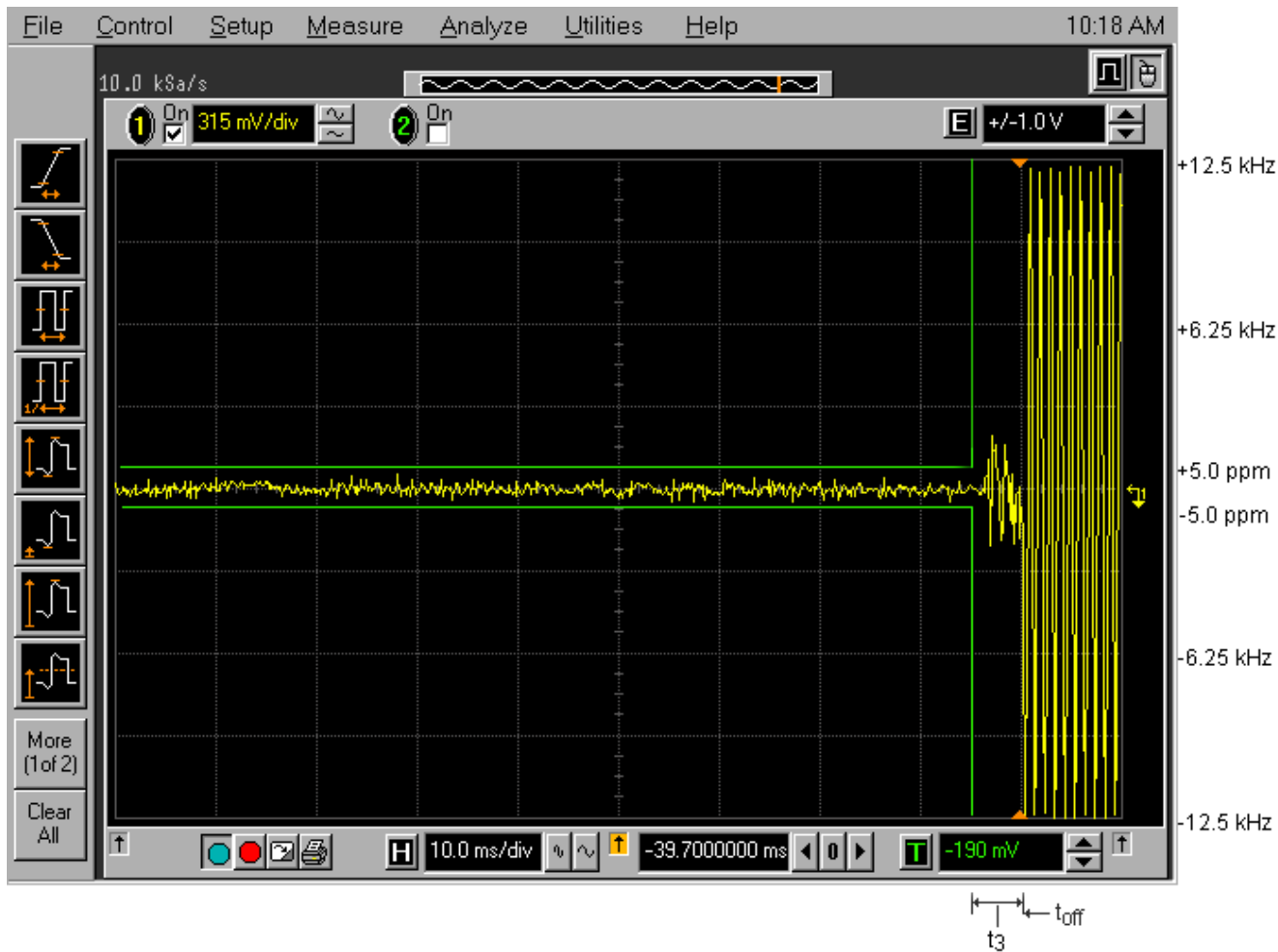

ULTRATECH GROUP OF LABS

3000 Bristol Circle, Oakville, Ontario, Canada L6H 6G4
Tel. #: 905-829-1570, Fax. #: 905-829-8050, Email: vic@ultratech-labs.com, Website: <http://www.ultratech-labs.com>

File #: ICOM-152F90
August 13, 2007

All test results contained in this engineering test report are traceable to National Institute of Standards and Technology (NIST)

EXHIBIT 7. MEASUREMENT UNCERTAINTY

The measurement uncertainties stated were calculated in accordance with the requirements of NIST Technical Note 1297 and NIS 81 (1994).

7.1. RADIATED EMISSION MEASUREMENT UNCERTAINTY

| CONTRIBUTION (Radiated Emissions) | PROBABILITY DISTRIBUTION | UNCERTAINTY (+ dB) | |
|---|-----------------------------|--------------------|---------------|
| | | 3 m | 10 m |
| Antenna Factor Calibration | Normal (k=2) | ± 1.0 | ± 1.0 |
| Cable Loss Calibration | Normal (k=2) | ± 0.3 | ± 0.5 |
| EMI Receiver specification | Rectangular | ± 1.5 | ± 1.5 |
| Antenna Directivity | Rectangular | +0.5 | +0.5 |
| Antenna factor variation with height | Rectangular | ± 2.0 | ± 0.5 |
| Antenna phase center variation | Rectangular | 0.0 | ± 0.2 |
| Antenna factor frequency interpolation | Rectangular | ± 0.25 | ± 0.25 |
| Measurement distance variation | Rectangular | ± 0.6 | ± 0.4 |
| Site imperfections | Rectangular | ± 2.0 | ± 2.0 |
| Mismatch: Receiver VRC $\Gamma_1 = 0.2$ Antenna VRC $\Gamma_R = 0.67(Bi) 0.3 (Lp)$ Uncertainty limits $20\text{Log}(1 \pm \Gamma_1 \Gamma_R)$ | U-Shaped | +1.1 -1.25 | ± 0.5 |
| System repeatability | Std. Deviation | ± 0.5 | ± 0.5 |
| Repeatability of EUT | | - | - |
| Combined standard uncertainty | Normal | +2.19 / -2.21 | +1.74 / -1.72 |
| Expanded uncertainty U | Normal (k=2) | +4.38 / -4.42 | +3.48 / -3.44 |

Calculation for maximum uncertainty when 3m biconical antenna including a factor of k = 2 is used:

$$U = 2u_c(y) = 2x(+2.19) = +4.38 \text{ dB} \quad \text{And} \quad U = 2u_c(y) = 2x(-2.21) = -4.42 \text{ dB}$$

EXHIBIT 8. MEASUREMENT METHODS

8.1. CONDUCTED POWER MEASUREMENTS

- The following shall be applied to the combination(s) of the radio device and its intended antenna(e).
- If the RF level is user adjustable, all measurements shall be made with the highest power level available to the user for that combination.
- The following method of measurement shall apply to both conducted and radiated measurements.
- The radiated measurements are performed at the Ultratech Calibrated Open Field Test Site.
- The measurement shall be performed using normal operation of the equipment with modulation.

Test procedure shall be as follows:

Step 1: Duty Cycle measurements if the transmitter's transmission is transient

- Using a EMI Receiver with the frequency span set to 0 Hz and the sweep time set at a suitable value to capture the envelope peaks and the duty cycle of the transmitter output signal;
- The duty cycle of the transmitter, $x = T_x \text{ on} / (T_x \text{ on} + T_x \text{ off})$ with $0 < x < 1$, is measure and recorded in the test report. For the purpose of testing, the equipment shall be operated with a duty cycle that is equal or more than 0.1.

Step 2: Calculation of Average EIRP. See Figure 1

- The average output power of the transmitter shall be determined using a wideband, calibrated RF average power meter with the power sensor with an integration period that exceeds the repetition period of the transmitter by a factor 5 or more. The observed value shall be recorded as "A" (in dBm);
- The e.i.r.p. shall be calculated from the above measured power output "A", the observed duty cycle x, and the applicable antenna assembly gain "G" in dBi, according to the formula:

$$\text{EIRP} = \text{A} + \text{G} + 10\log(1/x)$$

{X = 1 for continuous transmission => $10\log(1/x) = 0 \text{ dB}$ }

Figure 1.

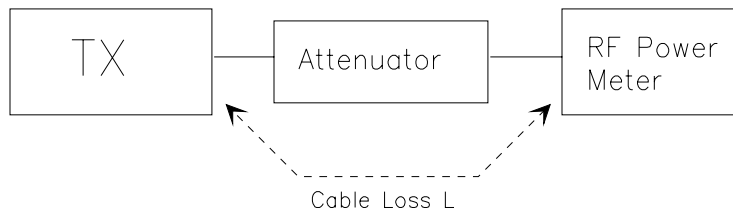

8.2. RADIATED POWER MEASUREMENTS (ERP & EIRP) USING SUBSTITUTION METHOD

8.2.1. MAXIMIZING RF EMISSION LEVEL (E-FIELD)

- (a) The measurements were performed with full rf output power and modulation.
- (b) Test was performed at listed 3m open area test site (listed with FCC, IC, ITI, NVLAP, ACA & VCCI).
- (c) The transmitter under test was placed at the specified height on a non-conducting turntable (80 cm height)
- (d) The BICONILOG antenna (20 MHz to 1 GHz) or HORN antenna (1 GHz to 18 GHz) was used for measuring.
- (e) Load an appropriate correction factors file in EMI Receiver for correcting the field strength reading level

Total Correction Factor recorded in the EMI Receiver = Cable Loss + Antenna Factor
 $E \text{ (dB}\mu\text{V/m)} = \text{Reading (dB}\mu\text{V)} + \text{Total Correction Factor (dB/m)}$

- (f) Set the EMI Receiver and #2 as follows:

Center Frequency: test frequency
Resolution BW: 100 KHz
Video BW: same
Detector Mode: positive
Average: off
Span: 3 x the signal bandwidth

- (g) The test antenna was lowered or raised from 1 to 4 meters until the maximum signal level was detected.
- (h) The transmitter was rotated through 360° about a vertical axis until a higher maximum signal was received.
- (i) The test antenna was lowered or raised again from 1 to 4 meters until a maximum was obtained. This level was recorded.
- (j) The recorded reading was corrected to the true field strength level by adding the antenna factor, cable loss and subtracting the pre-amplifier gain.
- (k) The above steps were repeated with both transmitters' antenna and test receiving antenna placed in vertical and horizontal polarization. Both readings with the antennas placed in vertical and horizontal polarization shall be recorded.
- (l) Repeat for all different test signal frequencies.

8.2.2. Measuring the EIRP of Spurious/Harmonic Emissions using Substitution Method

- (a) Set the EMI Receiver (for measuring E-Field) and Receiver #2 (for measuring EIRP) as follows:

Center Frequency: equal to the signal source
Resolution BW: 100 KHz
Video BW: VBW > RBW
Detector Mode: positive
Average: off
Span: 3 x the signal bandwidth

- (b) Load an appropriate correction factors file in EMI Receiver for correcting the field strength reading level

Total Correction Factor recorded in the EMI Receiver = Cable Loss + Antenna Factor
 $E \text{ (dBuV/m)} = \text{Reading (dBuV)} + \text{Total Correction Factor (dB/m)}$

- (c) Select the frequency and E-field levels obtained in the Section 8.2.1 for ERP/EIRP measurements.
(d) Substitute the EUT by a signal generator and one of the following transmitting antenna (substitution antenna):
 - ◆ DIPOLE antenna for frequency from 30-1000 MHz or
 - ◆ HORN antenna for frequency above 1 GHz }.(e) Mount the transmitting antenna at 1.5 meter high from the ground plane.
(f) Use one of the following antenna as a receiving antenna:
 - ◆ DIPOLE antenna for frequency from 30-1000 MHz or
 - ◆ HORN antenna for frequency above 1 GHz }.(g) If the DIPOLE antenna is used, tune it's elements to the frequency as specified in the calibration manual.
(h) Adjust both transmitting and receiving antenna in a VERTICAL polarization.
(i) Tune the EMI Receivers to the test frequency.
(j) Lower or raise the test antenna from 1 to 4 meters until the maximum signal level was detected.
(k) The transmitter was rotated through 360° about a vertical axis until a higher maximum signal was received.
(l) Lower or raise the test antenna from 1 to 4 meters until the maximum signal level was detected.
(m) Adjust input signal to the substitution antenna until an equal or a known related level to that detected from the transmitter was obtained in the test receiver.
(n) Record the power level read from the Average Power Meter and calculate the ERP/EIRP as follows:

$$P = P1 - L1 = (P2 + L2) - L1 = P3 + A + L2 - L1$$

$$EIRP = P + G1 = P3 + L2 - L1 + A + G1$$

$$ERP = EIRP - 2.15 \text{ dB}$$

$$\text{Total Correction factor in EMI Receiver \# 2} = L2 - L1 + G1$$

Where: P: Actual RF Power fed into the substitution antenna port after corrected.
P1: Power output from the signal generator
P2: Power measured at attenuator A input
P3: Power reading on the Average Power Meter
EIRP: EIRP after correction
ERP: ERP after correction

- (o) Adjust both transmitting and receiving antenna in a HORIZONTAL polarization, then repeat step (k) to (o)
(p) Repeat step (d) to (o) for different test frequency
(q) Repeat steps (c) to (j) with the substitution antenna oriented in horizontal polarization.
(r) Actual gain of the EUT's antenna is the difference of the measured EIRP and measured RF power at the RF port. Correct the antenna gain if necessary.

Figure 2

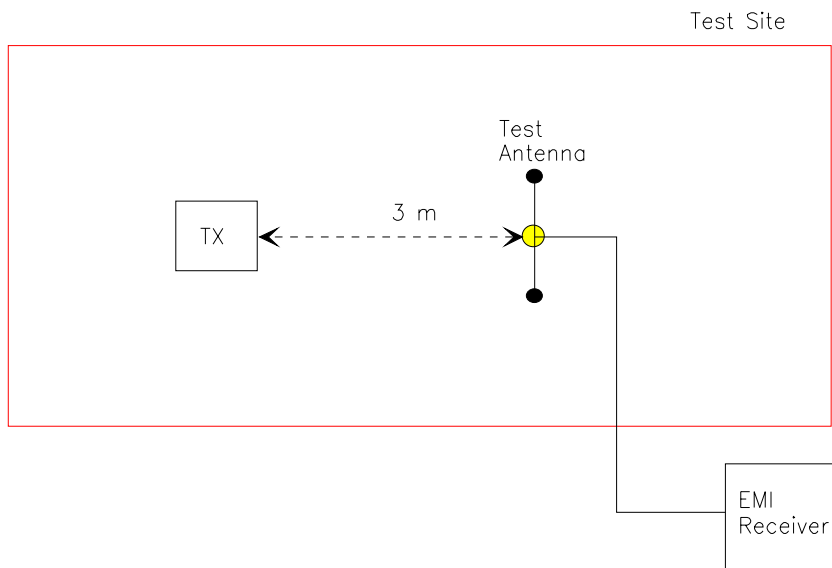
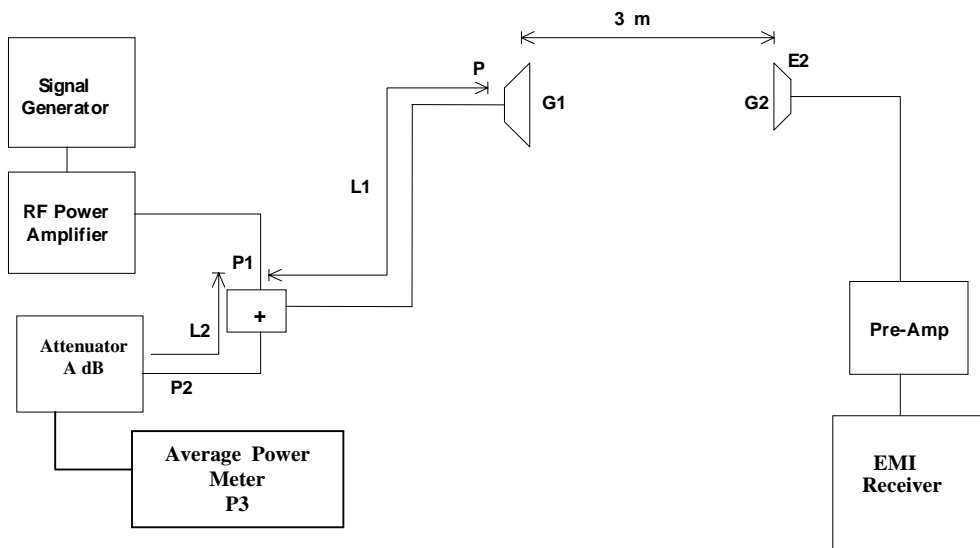

Figure 3



8.3. FREQUENCY STABILITY

Refer to FCC @ 2.1055.

- (a) The frequency stability shall be measured with variation of ambient temperature as follows: From -30 to +50 centigrade except that specified in subparagraph (2) & (3) of this paragraph.
- (b) Frequency measurements shall be made at extremes of the specified temperature range and at intervals of not more than 10 centigrade through the range. A period of time sufficient to stabilize all of the components of the oscillator circuit at each temperature level shall be allowed prior to frequency measurement. The short-term transient effects on the frequency of the transmitter due to keying (except for broadcast transmitters) and any heating element cycling normally occurring at each ambient temperature level also shall be shown. Only the portion or portions of the transmitter containing the frequency determining and stability circuitry need be subjected to the temperature variation test.
- (d) The frequency stability supply shall be measured with variation of primary supply voltage as follows:
 - (1) Vary primary supply voltage from 85 to 115 percent of the nominal value for other than hand carried battery equipment.
 - (2) For hand carried, battery powered equipment, reduce primary supply voltage to the battery operating end point which shall be specified by the manufacturer.
 - (3) The supply voltage shall be measured at the input to the cable normally provide with the equipment, or at the power supply terminals if cables are not normally provided. Effects on frequency of transmitter keying (except for broadcast transmitters) and any heating element cycling at the nominal supply voltage and at each extreme also shall be shown.
- (e) When deemed necessary, the Commission may require tests of frequency stability under conditions in addition to those specifically set out in paragraphs (a), (b), (c) and (d) of this section. (For example, measurements showing the effect of proximity to large metal objects, or of various types of antennas, may be required for portable equipment).

8.4. EMISSION MASK

Voice or Digital Modulation Through a Voice Input Port @ 2.1049(c)(i):- The transmitter was modulated by a 2.5 KHz tone signal at an input level 16 dB greater than that required to produce 50% modulation (e.g.: ± 2.5 KHz peak deviation at 1 KHz modulating frequency). The input level was established at the frequency of maximum response of the audio modulating circuit.

Digital Modulation Through a Data Input Port @ 2.1049(h):- Transmitters employing digital modulation techniques - when modulated by an input signal such that its amplitude and symbol rate represent the maximum rated conditions under which the equipment will be operated. The signal shall be applied through any filter networks, pseudo-random generators or other devices required in normal service. Additionally, the Emission Masks shall be shown for operation with any devices used for modifying the spectrum when such devices are operational at the discretion of the user.

The following EMI Receiver bandwidth shall be used for measurement of Emission Mask/Out-of-Band Emission Measurements:

- (1) For 25 KHz Channel Spacing: RBW = 300 Hz
- (2) For 12.5 KHz or 6.25 KHz Channel Spacings: RBW = 100 Hz

The all cases the Video Bandwidth shall be equal or greater than the measuring bandwidth.

8.5. SPURIOUS EMISSIONS (CONDUCTED)

With transmitter modulation characteristics described in Out-of-Band Emissions measurements @ 2.1049, the transmitter spurious and harmonic emissions were scanned. The spurious and harmonic emissions were measured with the EMI Receiver controls set as RBW = 30 KHz minimum , VBW \geq RBW and SWEEP TIME = AUTO). The transmitter was operated at a full rated power output, and modulated as follows:

FCC 47 CFR 2.1057 - Frequency spectrum to be investigated: The spectrum was investigated from the lowest radio generated in the equipment up to at least the 10th harmonic of the carrier frequency or to the highest frequency practicable in the present state of the art of measuring techniques, whichever is lower. Particular attention should be paid to harmonics and subharmonics of the carrier frequency. Radiation at the frequencies of multiplier stages should be checked. The amplitude of spurious emissions which are attenuated more than 20 dB below the permissible value need not be reported.

FCC 47 CFR 2.1051 - Spurious Emissions at Antenna Terminal: The radio frequency voltage or powers generated within the equipment and appearing on a spurious frequency shall be checked at the equipment output terminals when properly loaded with a suitable artificial antenna. Curves or equivalent data shall show the magnitude of the harmonic and other spurious emission that can be detected when the equipment is operated under the conditions specified in 2.1049 as appropriate. The magnitude of spurious emissions, which are attenuated more than 20 dB below the permissible value, need not be specified.

8.6. TRANSIENT FREQUENCY BEHAVIOR

1. Connect the transmitter under tests as shown in the above block diagram
2. Set the signal generator to the assigned frequency and modulate with a 1 KHz tone at ± 12.5 KHz deviation and its output level to be 50 dB below the transmitter rf output at the test receiver end.
3. Set the horizontal sweep rate on the storage scope to 10 milliseconds per division and adjust the display to continuously view the 1000 Hz tone from the Demodulator Output Port (DOP) of the Test Receiver. Adjust the vertical scale amplitude control of the scope to display the 1000 Hz at ± 4 divisions vertical Center at the display.
4. Adjust the scope so it will trigger on an increasing magnitude from the RF trigger signal of the transmitter under test when the transmitter was turned on. Set the controls to store the display.
5. The output at the DOP, due to the change in the ratio of the power between the signal generator input power and transmitter output power will, because of the capture effect of the test receiver, produce a change in display: For the first part of the sweep it will show the 1 KHz test signal. Then once the receiver's demodulator has been captured by the transmitter power, the display will show the frequency difference from the assigned frequency to the actual transmitter frequency versus time. The instant when the 1 KHz test signal is completely suppressed (including any capture time due to phasing) is considered to be t_{on} . The trace should be maintained within the allowed divisions during the period t_1 and t_2 .
6. During the time from the end of t_2 to the beginning of t_3 the frequency difference should not exceed the limits set by the FCC in Part 90.214 and the outlined in the Carrier Frequency Stability sections. The allowed limit is equal to FCC frequency tolerance limits specified in FCC 90.213.
7. Repeat the above steps when the transmitter was turned off for measuring t_3 .