



INSTRUCTION MANUAL

DUAL BAND FM TRANSCEIVER

IC-2820H

This device complies with Part 15 of the FCC rules. Operation is subject to the following two conditions: (1) This device may not cause harmful interference, and (2) this device must accept any interference received, including interference that may cause undesired operation.



Icom Inc.

FOREWORD

Thank you for purchasing this Icom product. The IC-2820H VHF/UHF FM TRANSCEIVER is designed and built with Icom's superior technology and craftsmanship. With proper care, this product should provide you with years of trouble-free operation.

We want to take a couple of moments of your time to thank you for making your IC-2820H your radio of choice, and hope you agree with Icom's philosophy of "technology first." Many hours of research and development went into the design of your IC-2820H.

◆ FEATURES

- *Diversity reception is ready*
- *DV (Digital Voice) with GPS operation capabilities* (Optional UT-123 is required)
- *V/V, U/U simultaneous receive capability*
- *Independent controls for each left and right bands*
- *Separate controller for flexible installation*
- *Remote control microphone standard*

IMPORTANT

READ ALL INSTRUCTIONS carefully and completely before using the transceiver.

SAVE THIS INSTRUCTION MANUAL— This instruction manual contains important operating instructions for the IC-2820H.

EXPLICIT DEFINITIONS

WORD	DEFINITION
⚠ WARNING!	Personal injury, fire hazard or electric shock may occur.
CAUTION	Equipment damage may occur.
NOTE	Recommended for optimum use. No risk of personal injury, fire or electric shock.

Icom, Icom Inc. and the ICOM logo are registered trademarks of Icom Incorporated (Japan) in the United States, the United Kingdom, Germany, France, Spain, Russia and/or other countries.

PRECAUTIONS

⚠ WARNING RF EXPOSURE! This device emits Radio Frequency (RF) energy. Extreme caution should be observed when operating this device. If you have any questions regarding RF exposure and safety standards please refer to the Federal Communications Commission Office of Engineering and Technology's report on Evaluating Compliance with FCC Guidelines for Human Radio frequency Electromagnetic Fields (OET Bulletin 65).

⚠ WARNING! NEVER connect the transceiver to an AC outlet. This may pose a fire hazard or result in an electric shock.

⚠ WARNING! NEVER operate the transceiver while driving a vehicle. Safe driving requires your full attention—anything less may result in an accident.

NEVER connect the transceiver to a power source of more than 16 V DC. This will damage the transceiver.

NEVER connect the transceiver to a power source using reverse polarity. This will damage the transceiver.

NEVER cut the DC power cable between the DC plug and fuse holder. If an incorrect connection is made after cutting, the transceiver may be damaged.

NEVER expose the transceiver to rain, snow or any liquids. The transceiver may be damaged.

NEVER operate or touch the transceiver with wet hands. This may result in an electric shock or damage the transceiver.

NEVER place the transceiver where normal operation of the vehicle may be hindered or where it could cause bodily injury.

NEVER let objects impede the operation of the cooling fan on the rear panel.

DO NOT push the PTT when not actually desiring to transmit.

DO NOT allow children to play with any radio equipment containing a transmitter.

During mobile operation, **DO NOT** operate the transceiver without running the vehicle's engine. When the transceiver's power is ON and your vehicle's engine is OFF, the vehicle's battery will soon become exhausted.

AVOID using or placing the transceiver in direct sunlight or in areas with temperatures below -10°C or above $+60^{\circ}\text{C}$.

BE CAREFUL! The transceiver will become hot when operating it continuously for long periods.

AVOID setting the transceiver in a place without adequate ventilation. Heat dissipation may be affected, and the transceiver may be damaged.

AVOID the use of chemical agents such as benzine or alcohol when cleaning, as they can damage the transceiver's surfaces.

USE Icom microphones only (supplied or optional). Other manufacturer's microphones have different pin assignments and may damage the transceiver if attached.

For U.S.A. only

CAUTION: Changes or modifications to this device, not expressly approved by Icom Inc., could void your authority to operate this device under FCC regulations.

SUPPLIED ACCESSORIES

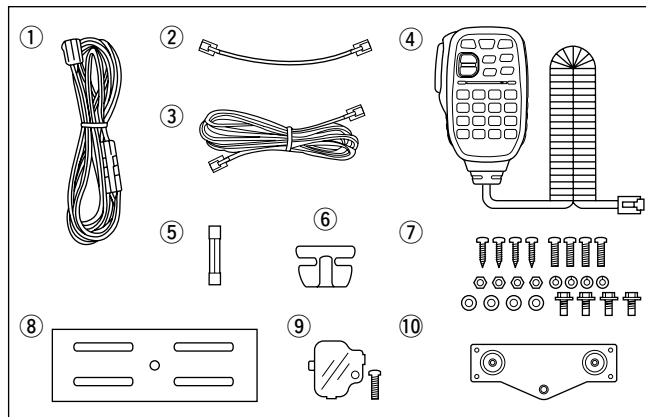

① DC power cable (3 m)	1
② Controller cable (10 cm ^t ; 3.9 in ^t)	1
③ Separation cable (3.4 m ^t ; 11.2 ft ^t)	1
④ Microphone (HM-133)*	1
⑤ Fuse (20 A)	1
⑥ Microphone hanger	1
⑦ Mounting screws, nuts and washers	1 set
⑧ Mobile mounting bracket	1
⑨ Microphone connector plate with screw	1 set
⑩ Remote controller bracket	1

*HM-154 HAND MICROPHONE may be supplied with some versions.

^tApprox.

TABLE OF CONTENTS

FOREWORD	i
IMPORTANT	i
EXPLICIT DEFINITIONS	i
PRECAUTIONS	ii
SUPPLIED ACCESSORIES	iii
TABLE OF CONTENTS	iii
QUICK REFERENCE GUIDE	I–XII
■ Installation	I
■ Your first contact	VIII
■ Repeater operation	X
■ Programming memory channels	XI
1 PANEL DESCRIPTION	1–10
■ Front panel—controller	1
■ Function display	3
■ Main unit	5
■ Microphone (HM-133)	7
■ Microphone keypad	8
■ Optional microphones (HM-118N/TN/TAN)	10
2 SETTING A FREQUENCY	11–15
■ Preparation	11
■ Using the tuning dial	13
■ Using the [▲]/[▼] keys	13
■ Using the keypad	13
■ Tuning step selection	14
■ Lock functions	15
3 BASIC OPERATION	16–21
■ Receiving	16
■ Monitor function	16
■ Squelch attenuator	17
■ V/V, U/U simultaneous receive (Para-watch)	18
■ Sub band mute/sub band busy beep	19
■ Transmitting	20

■ Selecting output power	20	9 DTMF MEMORY ENCODER	48–51
■ One-touch PTT function	21	■ Programming a DTMF code	48
■ Audio mute function	21	■ Transmitting a DTMF code	50
4 REPEATER OPERATION	22–28	■ DTMF speed	51
■ General	22	10 POCKET BEEP AND TONE SQUELCH	52–55
■ Accessing a repeater	23	■ Pocket beep operation	52
■ Subaudible tones	25	■ Tone/DTCS squelch operation	54
■ Offset frequency	27	■ Tone scan	55
■ Auto repeater (USA version only)	28	11 OTHER FUNCTIONS	56–72
5 MEMORY OPERATION	29–37	■ Set mode	56
■ General description	29	■ Initial set mode	60
■ Memory channel selection	29	■ AM/FM narrow mode	64
■ Programming a memory channel	30	■ Weather channel operation (USA version only)	65
■ Transferring memory contents	32	■ Microphone keys	66
■ Memory clearing	34	■ Partial reset	67
■ Memory bank selection	35	■ All reset	67
■ Memory bank setting	36	■ Data cloning	68
■ Transferring bank contents	37	■ Packet operation	69
6 CALL CHANNEL OPERATION	38–39	12 MAINTENANCE	73–74
■ Call channel selection	38	■ Troubleshooting	73
■ Call channel transferring	38	■ Fuse replacement	74
■ Programming a call channel	39	13 SPECIFICATIONS AND OPTIONS	75–76
7 SCAN OPERATION	40–45	■ Specifications	75
■ Scan types	40	■ Options	76
■ Scan start/stop	41	14 MODE ARRANGEMENT	77–78
■ Scan edges programming	42		
■ Skip channel setting	44		
■ Scan resume condition	45		
8 PRIORITY WATCH	46–47		
■ Priority watch types	46		
■ Priority watch operation	47		

QUICK REFERENCE GUIDE

■ Installation

◇ Precaution— magnets

△ CAUTION

Magnets are used for the controller's attachment to the main unit.

NEVER hold the whole unit by the controller only when carrying the transceiver. Carry the transceiver holding the main unit. If held by the controller, the main unit may drop off and may result in injury to the person carrying it or damage the transceiver.

NEVER attach the controller on the main unit's top cover, particularly around the internal speaker grill. It may cause the contents of the CPU and memory device could be deleted.

NEVER put the controller near a clock, television set (CRT type), magnetic compass and any magnetic/IC cards, credit cards, etc. It may cause the product to malfunction, and the content of the magnetic card could be deleted.

Please note that the controller may drop off when a high impact or vibration is applied.

◇ Installation methods

• *Single body installation*

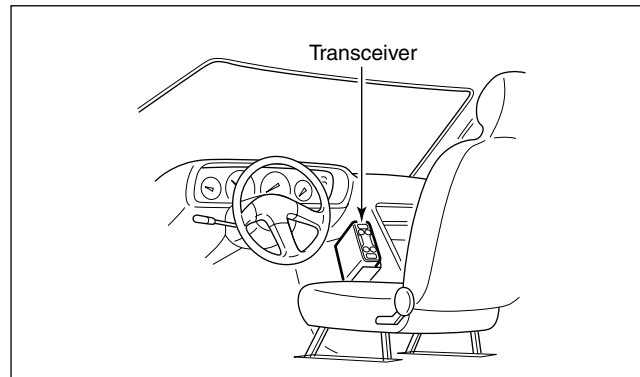

- The supplied mounting bracket can be used for the main unit installation.

• **Remote installation**

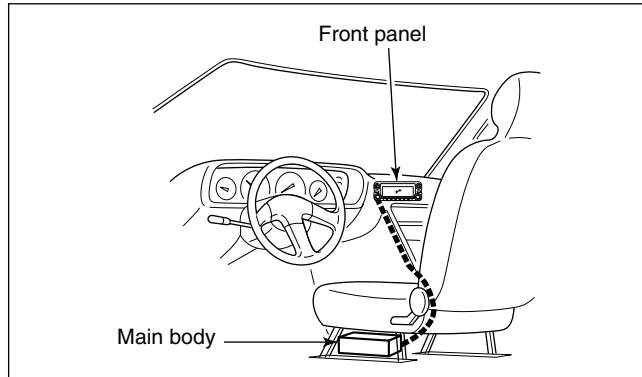

- The supplied remote controller bracket and separation cable can be used for installation.
- Optional **OPC-1156 SEPARATION CABLE (3.5 m; 11.5 ft)** is available for extend the separation cable.
- Optional **OPC-440 MICROPHONE CABLE (5.0 m; 16.4 ft)** and **OPC-647 (2.5 m; 8.2 ft)** are available to extend the microphone cable.
- Optional **OPC-441 SPEAKER CABLE (5.0 m; 16.4 ft)** is available to extend the speaker cable.

◇ **Location**

Select a location which can support the weight of the transceiver and does not interfere with driving. We recommend the locations shown in the diagram below.

NEVER place the transceiver or remote controller where normal operation of the vehicle may be hindered or where it could cause bodily injury.

NEVER place the transceiver or remote controller where air bag deployment may be obstructed.

DO NOT place the transceiver or remote controller where hot or cold air blows directly onto it.

AVOID placing the transceiver or remote controller in direct sunlight.

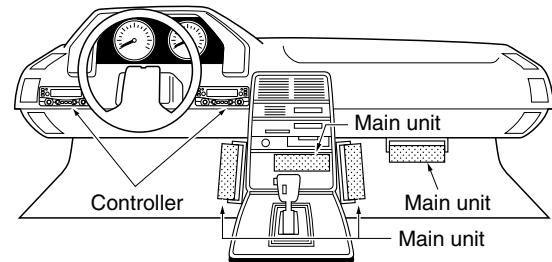

QUICK REFERENCE GUIDE

◆ Using the mounting bracket

- ① Drill 4 holes where the mounting bracket is to be installed.
 - Approx. 5.5–6 mm (1/4") when using nuts; approx. 2–3 mm (1/8") when using self-tapping screws.
- ② Insert the supplied screws, nuts and washers through the mounting bracket and tighten.
- ③ Adjust the angle for your suitable position.

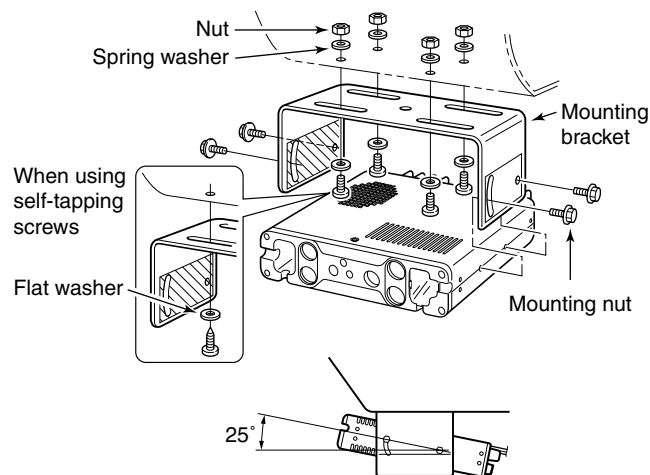

◆ Controller/Separation cable connection

Two connection cables, controller cable (10 cm; 3.9 in) for single body installation and separation cable (3.4 m; 11.2 ft) for remote installation, are supplied with the IC-2820H.

Connect the controller and the main unit using with the supplied connection cable as follows.

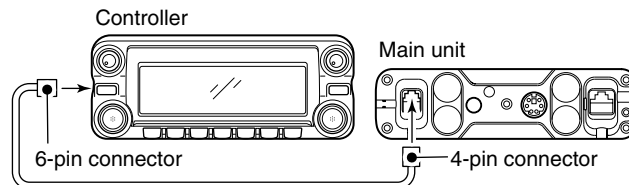

IMPORTANT!— number of pin

Number of pin, between both side connectors of the connection cable are different— one side is 6-pin, other side is 4-pin. You should connect the 6-pin connector to the main unit, and the 4-pin connector to the controller.

◇ **Microphone connection**

A microphone connector is available on the main unit front panel. Connect the supplied microphone connector as illustrated below.

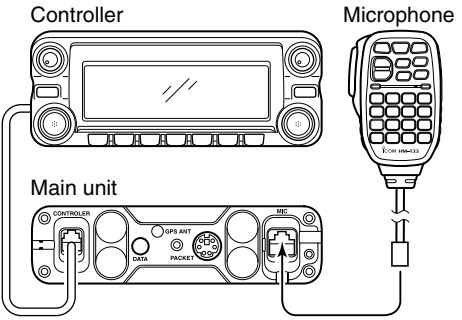

Attach the supplied microphone connector plate after the microphone connection, otherwise the controller will easily be dropped off when the microphone cable is pulled during single body installation.

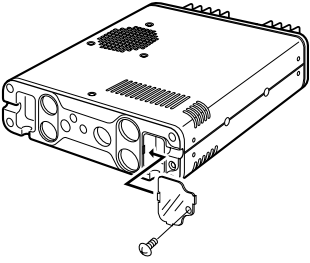

◇ **Controller's attachment**

You can attach the controller of the IC-2820H in one of 2 methods.

• **Example 1**

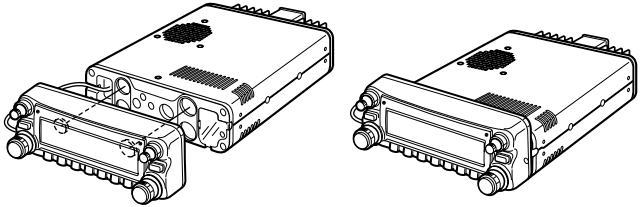

• **Example 2**

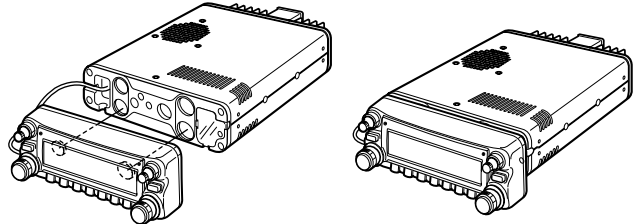

Quick reference guide

QUICK REFERENCE GUIDE

◆ Remote installation

The supplied remote controller bracket is used for remote installation.

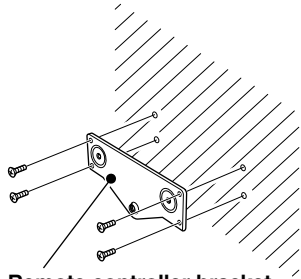

Remote controller bracket

- Attach the remote controller bracket onto a flat surface using with 4 self-tapping screws (2.6 mm(d)), or double-sticky tape, etc., as at left, then attach remote controller to the bracket

Hint!

The supplied remote controller bracket may fits to a mounting angle, such as for car TV set as below. Ask your car accessory shop, if desired.

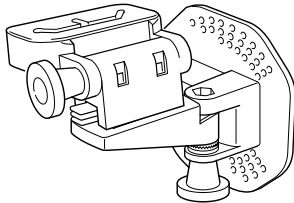

◆ Battery connection

- ⚠ **WARNING NEVER** remove the fuse holders from the DC power cable.
- ⚠ **NEVER** connect the transceiver directly to a 24 V battery.
- ⚠ **DO NOT** use the cigarette lighter socket for power connections. (See p. ?? for details)

Attach a rubber grommet when passing the DC power cable through a metal plate to prevent a short circuit.

• CONNECTING TO A DC POWER SOURCE

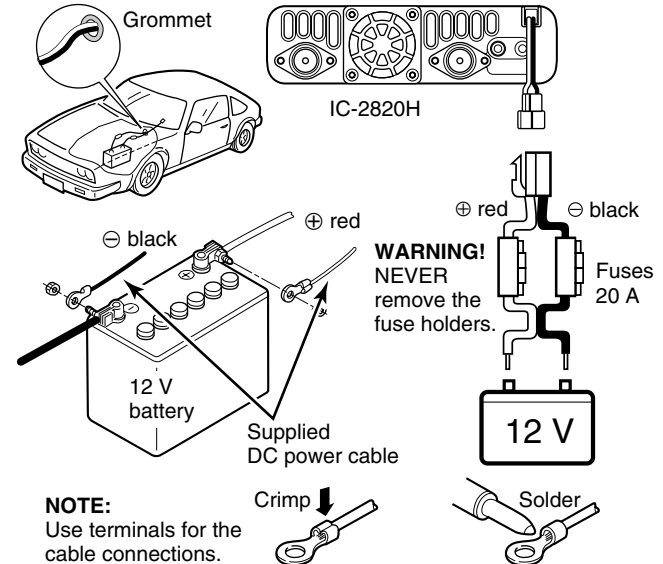

NOTE:
Use terminals for the cable connections.

◇ **DC power supply connection**

Use a 13.8 V DC power supply with at least 15 A capacity.

Make sure the ground terminal of the DC power supply is grounded.

• **CONNECTING TO A DC POWER SUPPLY**

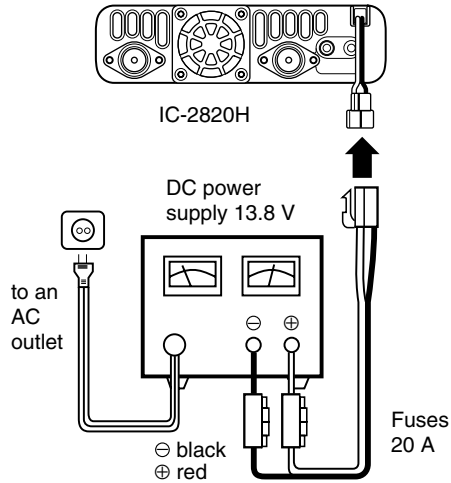

See p. ?? for fuse replacement.

QUICK REFERENCE GUIDE

◇ Antenna installation

• Antenna location

To obtain maximum performance from the transceiver, select a high-quality antenna and mount it in a good location. It is not necessary to use radials on a magnetic mount (“mag mount”) antenna.

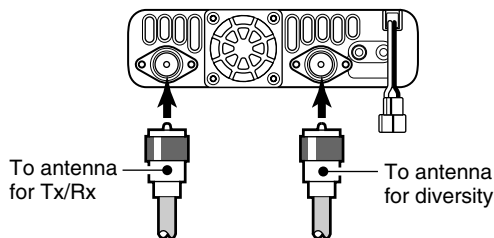
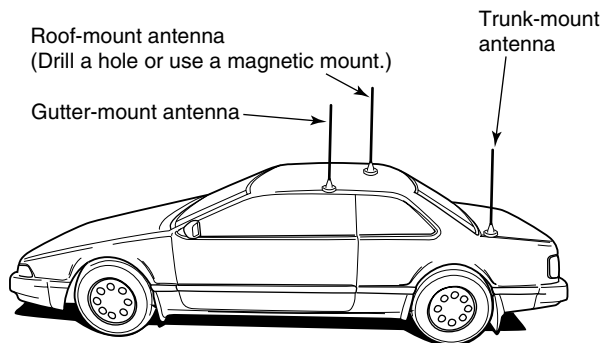

• Antenna connector

The antenna uses a PL-259 connector.

• PL-259 CONNECTOR

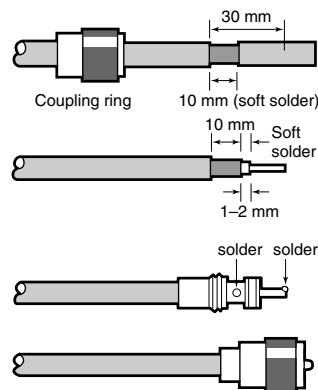

① Slide the coupling ring down. Strip the cable jacket and soft solder.

② Strip the cable as shown at left. Soft solder the center conductor.

③ Slide the connector body on and solder it.

④ Screw the coupling ring onto the connector body.
(10 mm ≈ 3/8 in)

/// **NOTE:** There are many publications covering proper antennas and their installation. Check with your local dealer for more information and recommendations.

■ Your first contact

Now that you have your IC-2820H installed in your car or shack, you are probably excited to get on the air. We would like to take you through a few basic operation steps to make your first “On The Air” an enjoyable experience.

1. Turning ON the transceiver

Before powering up your IC-2820H, you may want to make sure the audio volume and squelch level controls are set in 9–10 o'clock positions.

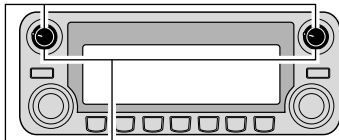

Set both [VOL] and [SQL] controls to 9–10 o'clock positions.

Although you have purchased a brand new transceiver, some settings may be changed from the factory defaults because of the QC process. Resetting the CPU is necessary to start from factory default.

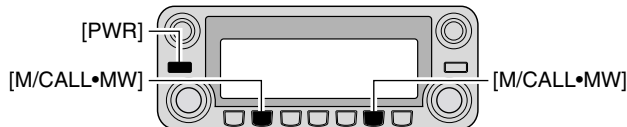

While pushing both [M/CALL•MW], turn power ON.

➔ While pushing both band's [M/CALL•MW], push and hold [PWR] for 1 sec. to reset the CPU.

2. Selecting the main band

The IC-2820H displays 2 frequencies on left and right bands simultaneously. However, transmission, some keys and microphone's operation are accepted for the main band only.

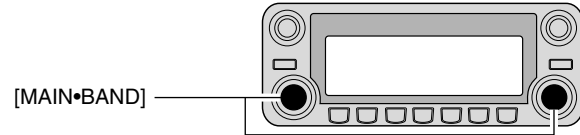

➔ Push the desired band's (left or right) [MAIN•BAND] to select the main band.

- “MAIN” appears for the main band.

Using the HM-133

You can select the main band from the HM-133.

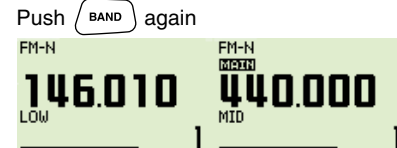
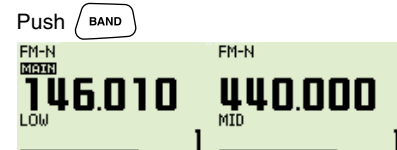

QUICK REFERENCE GUIDE

3. Selecting the operating frequency band

The IC-2820H has 2 m and 70 cm bands for each left and right band. The operating band can be exchanged between them, and the same bands, V/V and U/U settings are also possible.

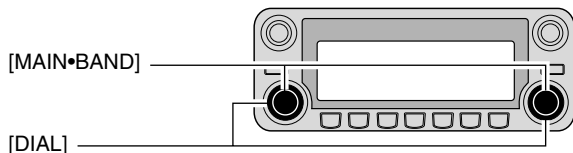

Frequency band initial is displayed.

- ➔ Push and hold the desired band's (left or right) **[MAIN•BAND]** for 1 sec. then rotate the appropriate band's **[DIAL]**.
 - Push the **[MAIN•BAND]** momentarily to return to frequency indication.

4. Tune the frequency

The tuning dial will allow you to dial in the frequency you want to operate. Pages ?? and ?? will instruct you on how to set the tuning speed.

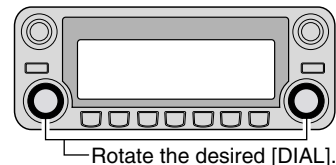

Using the HM-133

You can directly enter the frequency with the HM-133 keypad for the main band.

[EXAMPLE]: Setting frequency to 145.3625 MHz.

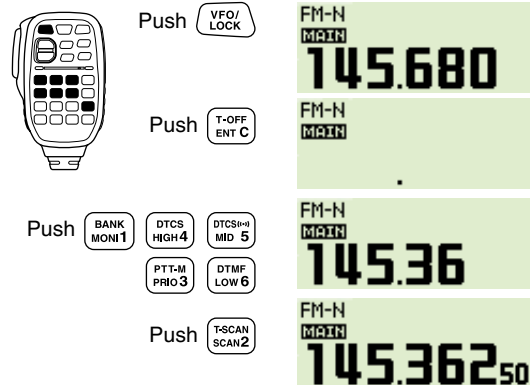

■ Repeater operation

1. Setting duplex

Push desired band's **[MAIN•BAND]** to select the main band.
Push **[DUP•MONI]** once or twice to select minus duplex or plus duplex.

- The USA version has an auto repeater function, therefore, setting duplex is not required.

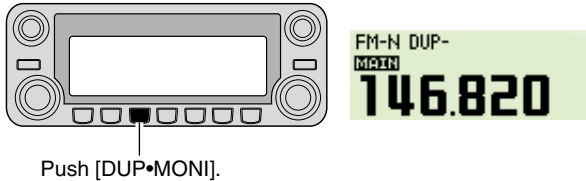

2. Repeater tone

Push **[TONE•DTMF]** several times until "TONE" appears, if the repeater requires a subaudible tone to be accessed.

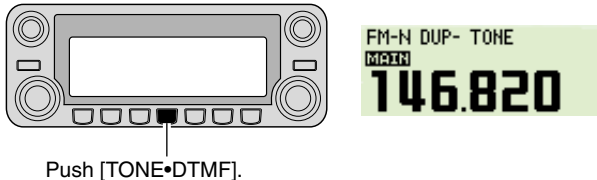

Using the HM-133

Plus or minus duplex selection and the repeater tone setting can be made easily via HM-133.

Push **[DUP- 7(TONE)]** for minus duplex; **[DUP+ 8(TSQL (••))]** for plus duplex selection, push **[FUNC]** then **[DUP- 7(TONE)]** to turn the repeater tone ON.

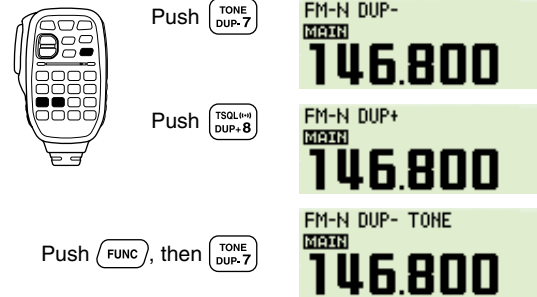

QUICK REFERENCE GUIDE

■ Programming memory channels

The IC-2820H has a total of 522 memory channels (including 20 scan edges and 2 call channels) for storing often used operating frequency, repeater settings, etc.

Any memory channel can be recalled from either left or right band.

1. Setting a frequency

In VFO mode, set the desired operating frequency with repeater, tone and tuning steps, etc.

- Push the desired band's [V/MHz•SCAN] to select VFO.
- Rotate the same band's [DIAL] to set the desired frequency.
 - Set other data, such as repeater tone, duplex information, tuning step), if desired.

2. Selecting a memory channel

Push and hold the same band's [M/CALL•MW] for 1 sec., then rotate the same band's [DIAL] to select the desired memory channel.

- “[MR]” indicator and memory channel number blink.

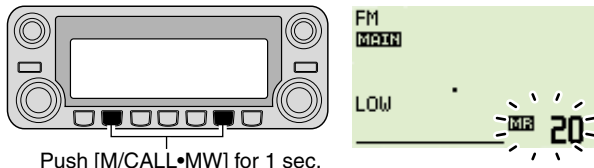

3. Writing a memory channel

Push and hold the same band's [M/CALL•MW] for 1 sec. to program.

- 3 beeps sound
- Return to VFO mode automatically after the program.
- Memory channel number automatically increases when continuing to push the [M/CALL•MW] after programming.

Using the HM-133

- ① Push [MR/CALL] to select memory mode.
- ② Push [ENT C(T-OFF)] first, then enter the desired memory channel via the keypad.
- ③ Push [VFO/LOCK] to select VFO mode, then set the desired operating frequency, including offset direction, tone settings, etc.
 - Push [VFO/LOCK] to select VFO.
 - Push [ENT C(T-OFF)] first, then enter the desired operating frequency via the keypad.
 - Set other data, such as repeater tone, duplex information, tuning step, if necessary.
- ④ Push [FUNC] then push and hold [CLR A(MW)] for 1 sec. to program.



Push ,

then .

- 3 beeps sound
 - Memory channel number automatically increases when continuing to push [CLR A(MW)] after programming.
-

1

PANEL DESCRIPTION

■ Front panel— controller

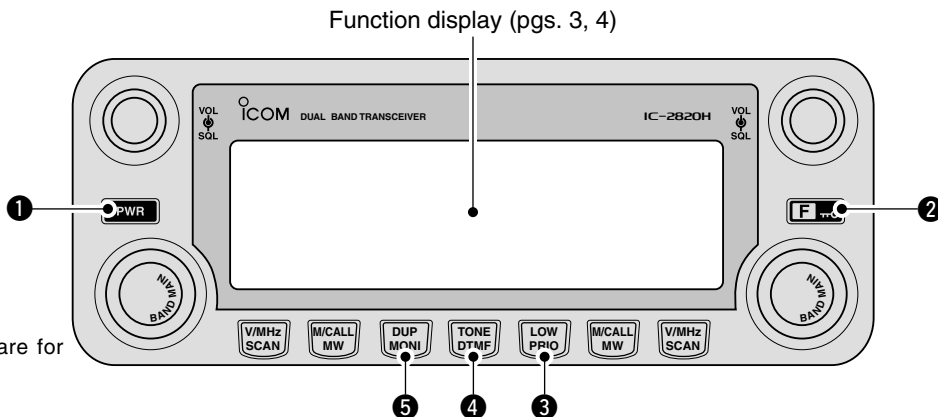

*The keys ② to ⑤ are for the MAIN band only.

① POWER KEY [PWR]

Push and hold for 1 sec. to turn power ON and OFF.

② FUNCTION•LOCK KEY [F]

- ➔ Push to display the function guide. (p. ??)
- ➔ Push and hold for 1 sec. to turn the lock function ON and OFF. (p. ??)

③ OUTPUT POWER•PRIORITY KEY [LOW•PRIO]

- ➔ Each push changes the output power selection. (p. ??)
- ➔ Push and hold for 1 sec. to start a priority watch. (p. ??)

④ TONE•DTMF KEY [TONE•DTMF]

- ➔ Each push selects a tone function. (pgs. ??, ??)
 - TONE, TSQL, TSQL-R, DTCS, DTCS-R, DSQ, DSQ, CSQ, CSQ or tone function OFF can be selected.
- ➔ Push and hold for 1 sec. to enter DTMF set mode. (p. ??)

⑤ DUPLEX•MONITOR KEY [DUP•MONI]

- ➔ Push to select DUP-, DUP+ and simplex (no indications) operation. (p. ??)
- ➔ Push and hold for 1 sec. to turn the monitor function ON and OFF. (p. ??)

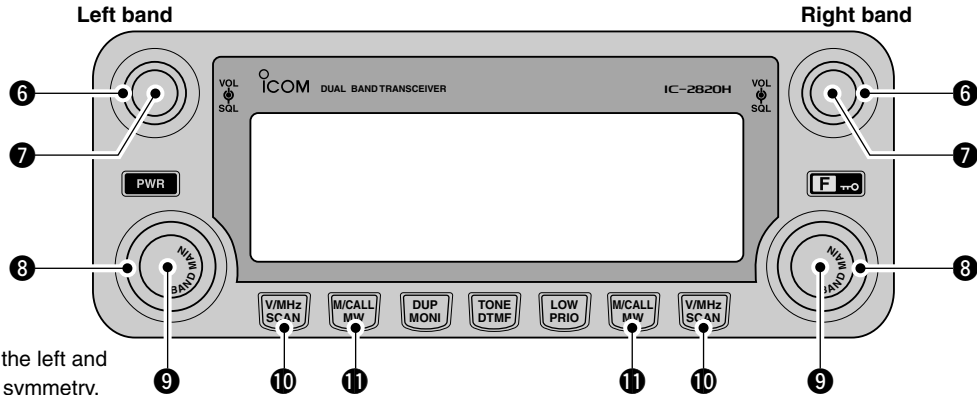

*The same controls for both the left and right bands are arranged in symmetry.

6 SQUELCH CONTROL [SQL]

- Varies the squelch level for left and right band. (p. ??)
- The RF attenuator activates and increases the attenuation when rotated clockwise to the center position and further. (p. ??)

7 VOLUME CONTROL [VOL] (p. ??)

Adjusts the audio level for left or right band.

8 TUNING DIAL [DIAL]

Selects the operating frequency (p. ??), memory channel (p. ??), the setting of the set mode item and the scanning direction (p. ??) for left or right band.

9 MAIN•BAND KEY [MAIN•BAND]

- Push to select the main band. (p. ??)
- Push and hold for 1 sec. to enter band selection mode. (p. ??)

10 VFO/MHz TUNING•SCAN KEY [V/MHz•SCAN]

- Push to select from VFO mode and 1 MHz (or 10 MHz for some versions) tuning. (p. ??)
- Push and hold for 1 sec. to enter scan type selection mode. (p. ??)
- Cancels a scan when pushed during scan.

11 MEMORY/CALL•MEMORY WRITE KEY [M/CALL•MW]

- Push to select and toggle memory, call and weather channel* modes. (pgs. ??, ??, ??, ??)
- *Weather channels available for USA versions only.
- Push and hold for 1 sec. to enter select memory write mode for memory channel programming. (pgs. ??, ??, ??)

1 PANEL DESCRIPTION

■ Function display

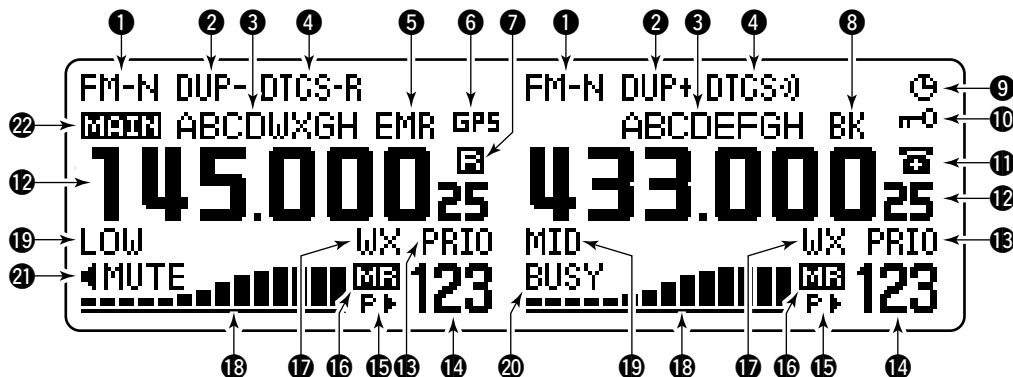

*The same indications for both the left and right bands are arranged.

① OPERATING MODE INDICATOR (p. ??)

Shows the selected operating mode.

- FM, FM-N, AM, AM-N and DV* are available, depending on operating band.

*Available only when the optional UT-123 is installed.

② DUPLEX INDICATORS (p. ??)

“DUP+” appears when plus duplex, “DUP-” appears when minus duplex (repeater) operation is selected.

③ NAME INDICATOR

During memory mode operation, the programmed memory or memory bank name is displayed.

④ TONE INDICATOR

➔ During FM mode operation:

- “TONE” appears while the repeater tone is in use. (p. ??)
- “TSQL” appears while the tone squelch function is in use. (p. ??)
- “TSQL-R” appears while the reverse tone squelch function is in use. (p. ??)
- “DTCS” appears while the DTCS squelch function is in use. (p. ??)
- “DTCS-R” appears while the reverse DTCS squelch function is in use. (p. ??)

- During DV* (Digital) mode operation:
 - “DSQL” appears while the digital call sign squelch function is in use. (p. ??)
 - “CSQL” appears while the digital code squelch function is in use. (p. ??)
- “” appears with the “TSQL,” “DTCS,” “DSQL”* or “CSQL”* indicator while the pocket beep function is in use. (pgs. ??, ??)
 - *Available only when the optional UT-123 is installed.

5 EMR MODE INDICATOR

- Appears when the EMR mode* operation is in use.
*Available only when the optional UT-123 is installed.

6 GPS INDICATOR

- Appears while GPS function* is in use. (p. ??)
*Available only when the optional UT-123 is installed.

7 SUB BAND REMOTE CONTROL INDICATOR (p. ??)

- Appears when the sub band remote control function is in use.

8 BREAK-IN INDICATOR

- Appears when the break-in* operation is in use.
*Available only when the optional UT-123 is installed.

9 AUTO POWER OFF INDICATOR

- Appears when the auto power OFF function is in use.

10 KEY LOCK INDICATOR

- Appears when the key lock function is activated. (p. ??)

11 DTMF INDICATOR

- Appears while DTMF memory function is in use. (p. ??)

12 FREQUENCY READOUT

- Shows the operating frequency, set mode contents, etc.
• Frequency decimal point blinks while scanning. (p. ??)

13 PRIORITY INDICATOR

- Appears while priority watch is activated, blinks while priority watch is paused. (p. ??)

14 MEMORY CHANNEL NUMBER INDICATORS

- Shows the selected memory channel number. (p. ??)
- Shows the selected bank initial. (p. ??)
- “C” appears when the call channel is selected. (p. ??)

15 SKIP INDICATOR (p. ??)

- “▶” appears when the displayed memory channel is specified as a skip channel.
- “P▶” appears when the displayed frequency is specified as a program skip frequency.

16 MEMORY INDICATOR (pgs. ??, ??)

- Appears when memory mode is selected.

17 WEATHER CHANNEL INDICATOR (p. ??)

- “WX” appears when the weather channel is selected.
*Available with the USA version only.

18 S/R/F INDICATORS

- Shows the relative signal strength while receiving signals. (p. ??)
- Shows the output power level while transmitting. (p. ??)

1 PANEL DESCRIPTION

■ Function display— continued

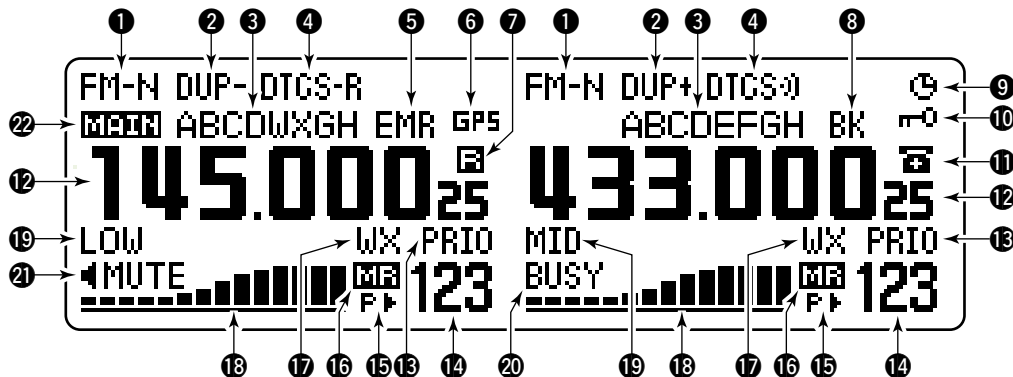

*The same indications for both the left and right bands are arranged.

19 OUTPUT POWER INDICATORS

“LOW” appears when low output power; “MID” appears when middle output power, “HI” appears when high output power is selected.

20 BUSY INDICATOR

- Appears when a signal is being received or the squelch is open. (p. ??)
- Blinks while the monitor function is activated. (p. ??)

21 AUDIO MUTE INDICATOR

Appears when the audio mute (p. ??) or sub band mute (p. ??) function is in use.

22 MAIN INDICATOR (p. ??)

Indicates the main band for transmit and function control.

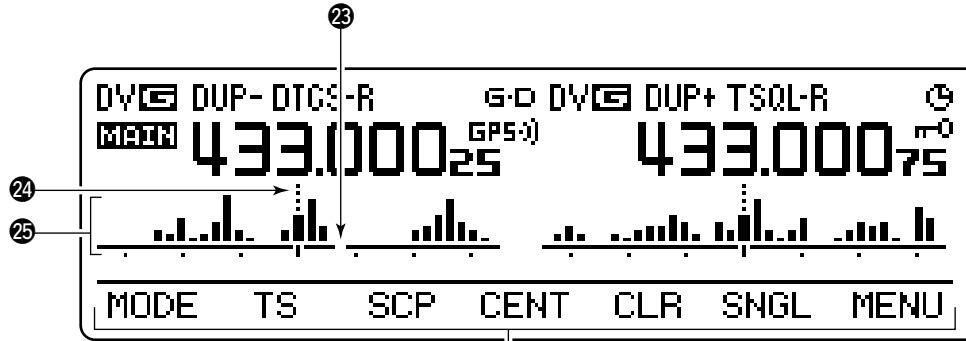

Function guide indications (pgs. ??-??)

- 23 FREQUENCY MARKER (p. ??)**
Shows the selected frequency in the band scope.
- 24 CENTER FREQUENCY MARKER**
Shows the center frequency of the band scope.
- 25 BAND SCOPE INDICATOR**
When the band scope function is in use, shows the band conditions.

1 PANEL DESCRIPTION

■ Function guide indications

The function guide indications allow you to simplifying a wide variety of function operation

◇ Function guide

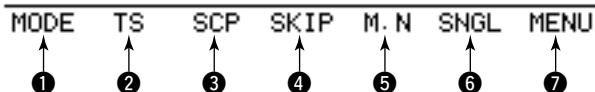

① MODE KEY [MODE](V/MHz•SCAN) (p. ??)

Push to select an operating mode from FM, FM-N, AM, AM-N and DV* in main band.

*Available only when the optional UT-123 is installed.

② TUNING STEP KEY [TS](M/CALL•MW) (p. ??)

Push to display the tuning step selection mode.

- 5.0,* 6.25,* 10, 12.5, 15,* 20, 25, 30 and 50 kHz steps are available.

*Not selectable in 900 MHz band.

③ BAND SCOPE KEY [SCP](DUP•MONI) (p. ??)

➔ Push to display the simple band scope and sweeps 1 time.

➔ Push and hold for 1 sec. to display the simple band scope and sweeps continuously.

- Push [SCP](DUP•MONI) momentarily to cancel the sweep.

④ SCAN SKIP KEY [SKIP](TONE•DTMF) (p. ??)

During in memory mode, push to select the scan skip condition for the selected memory channel.

- “▶” appears when memory skip, “P▶” appears when program skip selection.

⑤ MEMORY NAME INDICATION KEY [M.N](LOW•PRIO)

(p. ??)

Push select the memory name indication condition.

- Memory name, frequency and OFF selections are available.

⑥ SINGLE WATCH KEY [SNGL](M/CALL•MW) (p. ??)

Push select the single watch mode.

- Push [DUAL](M/CALL•MW)(for right band) to select the dual watch mode.

⑦ MENU MODE KEY [MENU](V/MHz•SCAN) (p. ??)

Push select the menu mode indication.

◇ Function guide 2

/// The function guide 2 indications appear only when the optional UT-123 is installed and DV mode is selected.

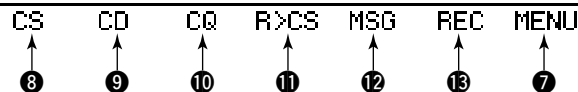

⑧ CALL SIGN SELECT KEY [CS](V/MHz•SCAN) (p. ??)

Push to display the call sign selection screen.

⑨ RECEIVED CALL SIGN RECORD KEY

[CD](M/CALL•MW) (p. ??)

Push to display the received call sign record screen.

⑩ CQ KEY [CQ](DUP•MONI) (p. ??)

Push to set “CQCQCQ” as the station call sign for the call.

- 11 CALL SIGN SET KEY [R>CS](TONE•DTMF)** (p. ??)
Push to copy and set the previously received station call sign as the station call sign for the call.
- 12 DV MESSAGE KEY [MSG](LOW•PRIO)** (p. ??)
Push to display the DV message screen.
- 13 VOICE MEMORY KEY [REC](V/MHz•SCAN)** (p. ??)
Push to display the DV voice memory record screen.

◇ Function guide 3*

/// The function guide 3 indications appear only when the optional UT-123 is installed.

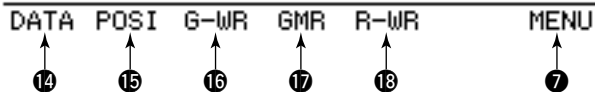

- 14 DATA KEY [DATA](V/MHz•SCAN)** (p. ??)
Push to toggle the GPS data communication ON and OFF.
• “G•D” appears when the GPS data communication is set to ON.
- 15 POSITION INFORMATION KEY [POSI](M/CALL•MW)**
(p. ??)
Push to display the position information screen.
- 16 GPS DATA STORE KEY [G-WR](DUP•MONI)** (p. ??)
Push and hold for 1 sec. to store the received position information.

- 17 GPS MEMORY RECALL KEY [GMR](TONE•DTMF)**
(p. ??)
Push to select the GPS memory screen to display the stored position information.
- 18 DV MESSAGE KEY [MSG](LOW•PRIO)** (p. ??)
Push to display the DV message screen.

1 PANEL DESCRIPTION

■ Main unit

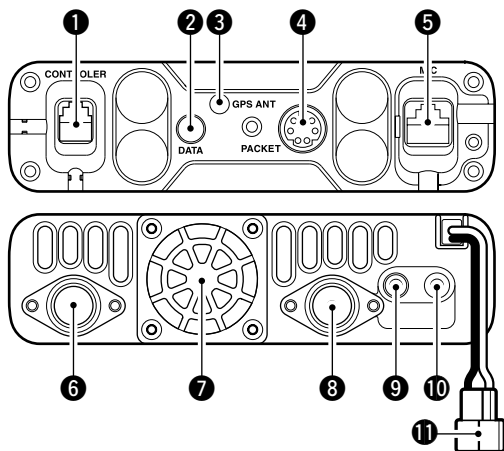

1 CONTROLLER CONNECTOR [CONTROLLER] (p. V)
Connects the controller unit with the supplied cable.

2 DATA JACK [DATA]
Connect to a PC via optional data communication cable OPC-1529 for slow-speed data communication in DV* mode operation.

*Available only when the optional UT-123 is installed.

3 GPS ANTENNA SOCKET [GPS ANT] (p. V)
Connects the GPS antenna supplied with the optional UT-123.

4 PACKET JACKS [PACKET] (p. V)
Connect a TNC (Terminal Node Controller), etc. for data communications. The receiver can support 9600 bps packet communication (AFSK).

5 MICROPHONE CONNECTOR [MIC]
Connects the supplied or an optional microphone.

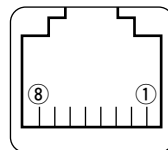

- ① +8 V DC output (Max. 10 mA)
- ② Channel up/down
- ③ 8 V control IN
- ④ PTT
- ⑤ GND (microphone ground)
- ⑥ MIC (microphone input)
- ⑦ GND
- ⑧ Data IN

6 ANTENNA CONNECTOR [ANT1]
Connects a 50 Ω antenna with a PL-259 connector and a 50 Ω coaxial cable for transmission and reception.

ANTENNA INFORMATION

For radio communications, the antenna is of critical importance, to maximize your output power and receiver sensitivity. The transceiver accepts a 50 Ω antenna and less than 1:1.5 of Voltage Standing Wave Ratio (VSWR). High SWR values not only may damage the transceiver but also lead to TVI or BCI problems.

7 COOLING FAN

Rotates while transmitting.
 Also rotates while receiving depending on the setting in set mode. (p. ??)

8 ANTENNA CONNECTOR [ANT2]

Connects a 50 Ω antenna with a PL-259 connector and a 50 Ω coaxial cable for diversity reception.

9 EXTERNAL SPEAKER JACK 1 [SP-1]

Connects an 8 Ω speaker. Outputs both left and right bands audio when no external speaker is connected to [SP-2]. See the table below for details.

- Audio output power is more than 2.4 W.

10 EXTERNAL SPEAKER JACK 2 [SP-2]

Connects an 8 Ω speaker. Outputs right band's audio only.

- Audio output power is more than 2.4 W.

11 POWER RECEPTACLE [DC13.8V]

Accepts 13.8 V DC ±15% with the supplied DC power cable.

 **NOTE: DO NOT** use a cigarette lighter socket as a power source when operating in a vehicle. The plug may cause voltage drops and ignition noise may be superimposed onto transmit or receive audio.

• Speaker information

Connected speaker	Left band audio	Right band audio
No external speakers	Internal speaker (mixed audio)	
[SP-1] only	External speaker (mixed audio)	
[SP-2] only	Internal speaker	External speaker
2 external speakers	External speaker via [SP-1]	External speaker via [SP-2]

1 PANEL DESCRIPTION

Microphone (HM-133*)

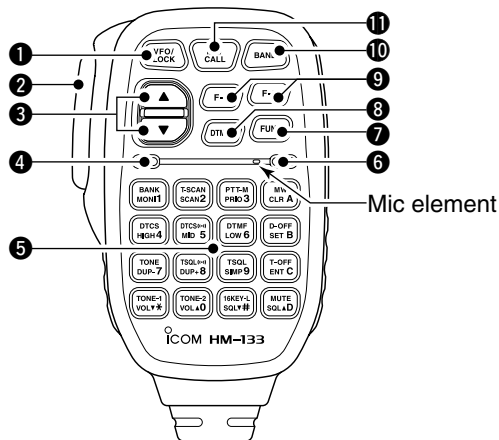

1 VFO/LOCK KEY [VFO/LOCK]

- ➔ Push to select VFO mode. (p. 12)
- ➔ Push and hold for 1 sec. to turn the lock function ON and OFF. (p. 15)

2 PTT SWITCH

- ➔ Push and hold to transmit; release to receive.
- ➔ Switches between transmitting and receiving while the one-touch PTT function is in use. (p. 21)

3 UP/DOWN KEYS [▲]/[▼]

- ➔ Push either key to change operating frequency, memory channel, set mode setting, etc. (pgs. 13, 29, 56)

- ➔ Push and hold either key for 1 sec. to start scanning. (p. 41)

4 ACTIVITY INDICATOR

- ➔ Lights red while any key, except [FUNC] and [DTMF-S], is pushed, or while transmitting.
- ➔ Lights green while the one-touch PTT function is in use.

5 KEYPAD (pgs. 8, 9)

6 FUNCTION INDICATOR

- ➔ Lights orange while [FUNC] is activated—indicates the secondary function of keys can be accessed.
- ➔ Lights green when [DTMF-S] is activated—DTMF signals can be transmitted with the keypad.

7 2nd FUNCTION KEY [FUNC]

8 DTMF SELECT KEY [DTMF-S] (p. 50)

9 FUNCTION KEYS [F-1]/[F-2] (p. 66)

- Program and recall your desired transceiver conditions.

10 BAND KEY [BAND] (p. 11)

- Push to select main band between left and right bands.













11 MEMORY/CALL KEY [MR/CALL]

- ➔ Push to select memory mode. (p. 12)
- ➔ Push and hold for 1 sec. to select call channel. (p. 38)









✓ Important!

All keys on the microphone function for the main band only.

■ Microphone keypad

KEY	FUNCTION	SECONDARY FUNCTION ( +key)	OTHER FUNCTIONS
	Switches between opening and closing the squelch. (p. 16)	In VFO mode enters operating band selecting condition. (p. 12) In memory mode enters bank selecting condition. (p. 35)	After pushing  : Transmits the appropriate DTMF code. (pgs. 26, 50) When the DTMF memory encoder is activated, push [0] to [9] to transmit the appropriate DTMF memory contents . (p. 50)
	Starts and stops scanning. (p. 41)	Starts and stops tone scanning. (p. 55)	
	Starts and stops priority watch. (p. 47)	Turns the one-touch PTT function ON and OFF. (p. 21)	
	Selects high output power. (p. 20)	Turns the DTCS squelch ON. (p. 53)	
	Selects mid. output power. (p. 20)	Turns the DTCS pocket beep function ON. (p. 53)	
	Selects low output power (p. 20)	Turns the DTMF memory encoder function ON. (p. 49)	
	Selects minus duplex operation. (p. 24)	Turns the subaudible tone encoder ON. (p. 24)	
	Selects plus duplex operation. (p. 24)	Turns the CTCSS pocket beep function ON. (p. 53)	
	Selects simplex operation. (p. 24)	Turns the tone squelch function ON. (p. 53)	
	Increases audio output level. (p. 16)	Sends a 1750 Hz tone signal while pushing and holding. (p. 26)	

1 PANEL DESCRIPTION

KEY	FUNCTION	SECONDARY FUNCTION ( +key)	OTHER FUNCTIONS
	<ul style="list-style-type: none"> ➤ Cancels frequency entry. (p. 13) ➤ Cancels the scan or priority watch. (pgs. 41, 47) ➤ Exit set mode. (p. 56) 	<ul style="list-style-type: none"> ➤ Selects a memory channel for programming. (p. 31) ➤ Advances the memory channel number when continuously pushed after programming is completed. (p. 31) 	After pushing  : Transmits the appropriate DTMF code. (pgs. 26, 50)
	<ul style="list-style-type: none"> ➤ Enters set mode (p. 56) ➤ Advances the set mode selection order after entering set mode. (p. 56) 	DTMF memory encoder function OFF. (p. 50)	
	<ul style="list-style-type: none"> ➤ Sets the keypad for numeral input. (p. 13) ➤ Reverses the set mode selection order after entering set mode. (p. 56) 	Turns the subaudible tone encoder, pocket beep or CTCSS/DTCS tone squelch OFF. (pgs. 24, 53)	
	Adjusts the squelch level increments. (p. 16)	Mutes the audio. (p. 21) • Mute function is released when any operation is performed.	
	Decreases audio output level. (p. 16)	Sends a 1750 Hz tone signal for 0.5 sec. (p. 26)	
	Adjusts the squelch level decrement. (p. 16)	Locks the digit keys on the keypad (including the A to D, # and * keys. (p. 15)	

■ Optional Microphone (HM-154)

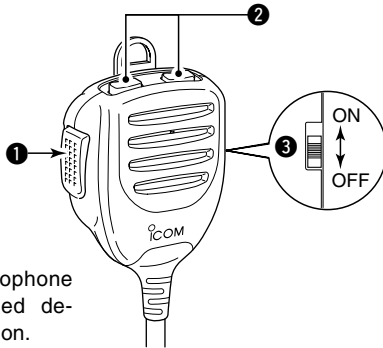

*A different microphone may be supplied depending on version.

❶ PTT SWITCH

Push and hold to transmit; release to receive.

❷ UP/DOWN KEYS [UP]/[DN]

- Push either key to change operating frequency, memory channel, set mode setting, etc. (pgs. 13, 29, 56)
- Push and hold either key for 1 sec. to start scanning. (p. 41)

❸ UP/DN LOCK SWITCH

Slide to toggle [UP]/[DN] keys function ON and OFF.

■ Preparation

◇ Turning power ON/OFF

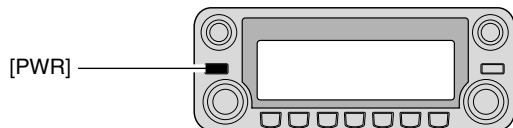

- ➔ Push and hold **[PWR]** for 1 sec. to turn power ON and OFF.

◇ MAIN band

The IC-2820H can receive 144 MHz and 430(440) MHz band signals simultaneously. To activate all functions access or to change frequency via the microphone, you must designate one band as the main band. The transceiver transmits a signal on the main band only.

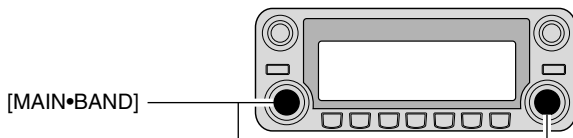

- ➔ Push the desired band's **[MAIN•BAND]** to select the main band.
- “**MAIN**” indicates the main band.



- ➔ Push **[BAND]** to toggle the main band between left and right bands.

◇ Operating frequency band selection

In the default condition, or after resetting the CPU, 2 m band is assigned in the left band, 70 cm band is assigned in the right band. However, the 2 m band can also be assigned into the right, and 70 cm band can also be assigned into the left band.

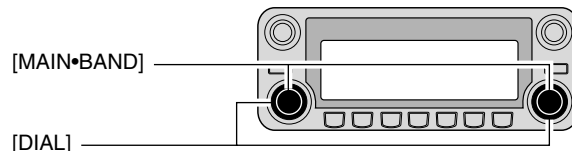

Frequency band initial is displayed.

- ① Push and hold the desired band's **[MAIN•BAND]** for 1 sec.
 - Frequency band initial appears.
- ② Rotate the same band's **[DIAL]** to select the desired frequency band.
 - Pushing **[▲]/[▼]** on the microphone also selects the band.
- ③ Push the **[MAIN•BAND]** to return to frequency indication in the selected frequency band.



Note that in this manual, sections beginning with a microphone icon (as at left), designate operation via the HM-133 microphone.



- 1 Push [BAND] to select main band.
- 2 Push and hold [BAND] for 1 sec. to enter frequency band selecting condition.
 - The frequency band is displayed.



- 3 Push [▲]/[▼] to select the desired frequency band.
- 4 Push [CLR A(MW)] to exit the condition, and return to frequency indication.

✓ **About extra frequency bands**
 — USA and General versions only

In addition to the 2 m and 70 cm ham bands, the IC-2820H USA and General versions have extra frequency bands for each left and right bands as follow.

See the specifications for the available frequency bands for details.

*The frequency band initials are default indication only. Once the op-

Frequency band initial*	Left band	Right band
127	✓	✓
136	✓	✓
146	✓	✓
220	✓	—
375	✓	✓
440	✓	✓
500	✓	✓
900	—	✓

erating frequency is set in the band, the initial indication will be changed.

✓: Available, —: Not available

◇ **VFO and memory modes**

The transceiver has 2 basic operating modes: VFO mode and memory mode. Select VFO mode first to set an operating frequency.

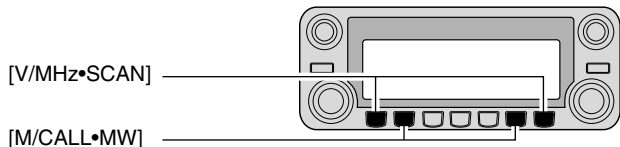

VFO mode is selected. "MR" indicator appears when memory mode is selected.

- Push the desired band's [V/MHz•SCAN] to select VFO mode.
 - When VFO mode is already selected, the digit below 10 MHz (the digit below 1 MHz or 100 kHz disappear depending on versions) disappear. In this case, push [V/MHz•SCAN] again (or twice or 3 times depending on version).
- Push [M/CALL•MW] to select memory mode.
 - "MR" indicator appears when memory mode is selected.



- Push [VFO/LOCK] to select VFO mode.
- Push [MR/CALL] to select memory mode.
 - The microphone controls the main band only. Push [BAND] to toggle the main band, then push [VFO/LOCK] or [MR/CALL], if necessary.

2 SETTING A FREQUENCY

■ Using the tuning dial

- ① Rotate the desired band's **[DIAL]** to set the frequency.
 - If VFO mode is not selected, push the same band's **[V/MHz•SCAN]** to select VFO mode.
 - The frequency changes in the selected tuning steps. (p. ??)

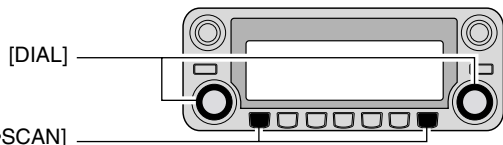

- ② To change the frequency in 1 MHz (10 MHz for some versions) steps, push **[V/MHz•SCAN]**, then rotate **[DIAL]**.
 - Pushing and holding **[V/MHz•SCAN]** for 1 sec. starts scan function. If scan starts, push **[V/MHz•SCAN]** again to cancel it.

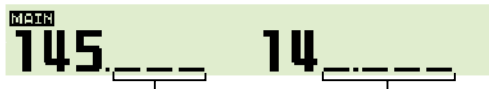

While 1 MHz tuning step is selected, the digit below 100kHz disappear.

While 10 MHz tuning step is selected, the digit below 1 MHz disappear.

■ Using the **[▲]/[▼]** keys



- ➔ Push **[▲]** or **[▼]** to select the desired frequency.
 - Push **[BAND]** to select the desired band (left or right) as the main band in advance.
 - Pushing and holding **[▲]/[▼]** for 1 sec. activates a scan. If scan starts, push **[▲]/[▼]** or **[CLR A(MW)]** to cancel it.

■ Using the keypad

The frequency can be directly set via numeral keys on the microphone.



- ① Push **[BAND]** to select the desired band (left or right) as the main band.
 - Push **[VFO/LOCK]** to select VFO mode, if necessary.
- ② Push **[ENT C(T-OFF)]** to activate the keypad for digit input.
- ③ Push 6 keys to input a frequency.
 - When a digit is mistakenly input, push **[ENT C(T-OFF)]** to clear the input, then repeat input from the 1st digit.
 - Pushing **[CLR A(MW)]** clears input digits and retrieves the frequency.

[EXAMPLE]: Setting frequency to 145.3625 MHz.

Push **[VFO/LOCK]**



Push **[T-OFF ENT C]**



Push **[BANK MON1]** **[DTCS HIGH4]** **[STCS MD 5]**



[PTT-A PRO3] **[DTMF LOW 6]**

Push **[SCAN SCAN]**



■ Tuning step selection

Tuning steps are the minimum frequency change increments when you rotate **[DIAL]** or push **[▲]/[▼]** on the microphone. Independent tuning step for the left and right, as well as each frequency bands can be set for individual tuning convenience. The following tuning steps are available.

- 5 kHz* • 6.25 kHz* • 10 kHz • 12.5 kHz
- 15 kHz* • 20 kHz • 25 kHz • 30 kHz
- 50 kHz

*Not selectable in 900 MHz band.

NOTE: For convenience, select a tuning step that matches the frequency intervals of repeaters in your area.

- ① Push the desired band's **[MAIN•BAND]** to select the main band.
 - Push the same band's **[V/MHz•SCAN]** to select VFO mode, if necessary.
- ② Push **[F•↔•O]** to display the function guide.

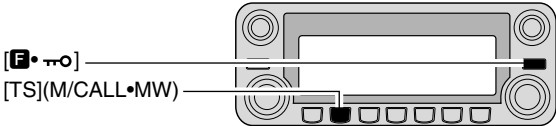

- ③ Push **[TS](M/CALL•MW)** (Left band's) to enter tuning step set mode.



- ④ Rotate the same band's **[DIAL]** to select the desired tuning step.
- ⑤ Push **[F•↔•O]** to exit tuning step set mode.

2 SETTING A FREQUENCY

■ Lock functions

To prevent accidental frequency changes and unnecessary function access, use the lock function. The transceiver has 2 different lock functions.

◇ Frequency lock

This function locks dials and keys electronically and can be used together with the microphone lock function.

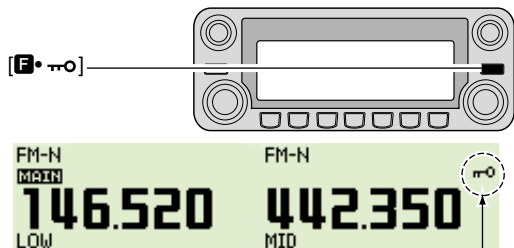

“**LOCK**” appear while the lock function is activated.

➔ Push and hold **[F]** for 1 sec. to turn the lock function ON and OFF.

- **[PTT]**, **[DUP•MONI]** (monitor function only), **[VOL]**, **[SQL]** and **[MAIN•BAND]** (main band selection only) can be used while the channel lock function is in use. Also, TONE-1, TONE-2, DTMF tones or DTMF memory contents can be transmitted from the microphone.



➔ Push and hold **[VFO/LOCK]** for 1 sec. to turn the lock function ON and OFF.

◇ Microphone keypad lock

This function locks the microphone keypad.



➔ Push **[FUNC]** then **[SQL▼D(16KEY-L)]** to turn the microphone keypad lock function ON and OFF.

- **[PTT]**, **[VFO/LOCK]**, **[MR/CALL]**, **[BAND]**, **[▲]**, **[▼]**, **[F-1]**, **[F-2]**, **[DTMF-S]** and **[FUNC]** on the microphone can be used.
- All keys on the transceiver can be used.
- The keypad lock function is released when the power is turned OFF then ON again.

■ Receiving

- ① Set the audio level for the main band.
 - ➔ Push the desired band's [MAIN•BAND].
 - ➔ Push and hold [DUP•MONI] for 1 sec. to open the squelch.
 - ➔ Rotate the main band's [VOL] to adjust the audio level.
 - ➔ Push the [DUP•MONI] to close the squelch.
- ② Set the squelch level.
 - ➔ Rotate the main band's [SQL] fully counterclockwise in advance, then rotate the [SQL] clockwise until the noise just disappears.
 - When interference due to strong signals is received, rotate the [SQL] clockwise again for attenuator operation. (p. 17)
- ③ Set the operating frequency in the main band. (pgs. 11–13)
- ④ When receiving a signal on the set frequency, squelch opens and the transceiver emits audio.



Appears when receiving a signal.

- “BUSY” appears and the S/R/F indicator shows the relative signal strength for the received signal.

✓CONVENIENT!

The main band's audio and squelch level can also be adjusted with [VOL▲(TONE-1)]/[VOL▼0(TONE-2)] and [SQL▲D(MUTE)]/[SQL▼#(16KEY-L)], respectively.

- “VOL” for audio or “SQL” for squelch appears during set.

SQL▲▼
D/#
VOL▲▼
*/0

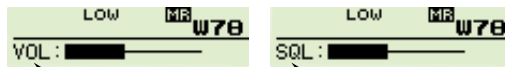

Show set level.

■ Transmitting

CAUTION: Transmitting without an antenna will damage the transceiver.

NOTE: To prevent interference, listen on the channel before transmitting by pushing and holding [DUP•MONI] for 1 sec., or [MONI 1(BANK)] on the microphone.

- ① Select the main band. (p. 11)
- ② Set the operating frequency. (pgs. 11–13)
 - Select output power if desired. See section at right for details.
- ③ Push and hold [PTT] to transmit.
 - “TX” appears.
 - The S/R/F indicator shows the output power selection.
 - A one-touch PTT function is available. See p. ?? for details.
 - “#MUTE” appears on the sub band screen according to the selected frequency band.
- ④ Speak into the microphone using your normal voice level.
 - DO NOT hold the microphone too close to your mouth or speak too loudly. This may distort the signal.
- ⑤ Release [PTT] to return to receive.

IMPORTANT! (for 50 W transmission):



The IC-2820H is equipped with protection circuit to protect the power amplifier circuit from high SWR (Standing Wave Ratio) and temperature. When a high SWR antenna or no antenna is connected, or when the transceiver temperature becomes extremely high, the transceiver reduces transmit output power to 15 W (approx.) automatically.

3 BASIC OPERATION

■ Selecting output power

The transceiver has 3 output power levels to suit your operating requirements. Low output powers during short-distance communications may reduce the possibility of interference to other stations and will reduce current consumption.

➔ Push [**LOW•PRIO**] several times to select the output power.

S/RF INDICATOR	POWER OUTPUT	
	VHF/UHF	Taiwan
High: 	50 W/50 W	25 W
Mid: 	15 W*/15 W*	15 W*
Low: 	5 W*/5 W*	5 W*

*approx.

- The output power can be changed while transmitting.

The microphone can also be used to select output power.

➔ Push [**HIGH 4(DTCS)**] for high output power; [**MID 5(DTCS ((•)))**] for middle output power; and [**LOW 6(DTMF)**] for low output power.

- The output power can be changed via the microphone during receive only.



■ Operating mode selection

Operating modes are determined by the modulation of the radio signals. The transceiver has total 5 operating modes (FM, FM-N, AM, AM-N and DV modes). The mode selection is stored independently for each band and memory channel.

Typically, AM mode is used for the air band (118–136.995 MHz).

- ① Push [**F•---**] to display the function guide.
 - ② Push [**MODE(V/MHz•SCAN)**] (Left band's) several times to select the desired operating mode from FM, FM-N, AM, AM-N and DV.*
- *DV mode is available only when the optional UT-123 is installed.

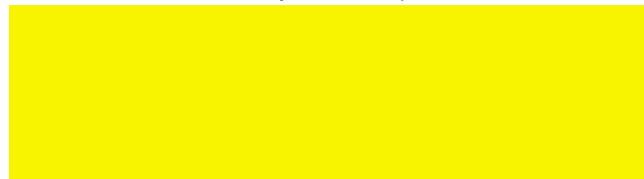

■ Squelch attenuator

The transceiver has an RF attenuator related to the squelch level setting. Approx. 10 dB attenuation is obtained at maximum setting.

The squelch attenuator allows you to set a minimum signal level needed to open the squelch. The attenuator function can be deactivated in set mode.

- ➔ Rotate **[SQL]** clockwise past the 12 o'clock position to activate the squelch attenuator.
 - Attenuation level can be adjusted up to **10 dB (approx.)** between 12 o'clock and fully clockwise position.

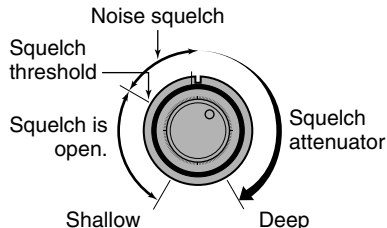

NOTE: The squelch attenuator functions even when the monitor function is in use. Thus set the **[SQL]** control within 10 to 12 o'clock position is recommended when using the monitor function.

◇ Squelch attenuator setting

- ① Push **[F•→○]** to display the function guide.
- ② Push **[MENU](V/MHz•SCAN)** (Right band's) to enter MENU screen.

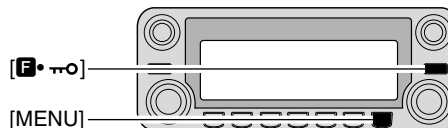

- ③ Rotate the main band's **[DIAL]** to select "SET MODE," then push **[MAIN•BAND]** to enter set mode.
- ④ Rotate **[DIAL]** to select "AUTO ATT" then push **[MAIN•BAND]**.
- ⑤ Rotate **[DIAL]** to turn the squelch attenuator function ON and OFF, then push **[MAIN•BAND]**
 - Select "OFF" to deactivate the squelch attenuator function.

MENU	SQL DELAY	SHORT	↕
	MIC SENS LEVEL	HIGH	
SET MODE	AUTO ATT	ON	
	ALC	OFF	□
09/12	DIVERSITY	OFF	↕
		BACK	

- ⑥ Push **[BACK](V/MHz•SCAN)** (Right bnd's) 2 times to exit set mode.

3 BASIC OPERATION

■ V/V, U/U simultaneous receive (Para-watch)

The IC-2820H can simultaneously receive two signals on the same band, such as 144 MHz band, using the para-watch function.

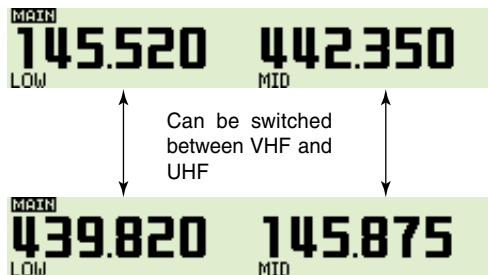

[Example]

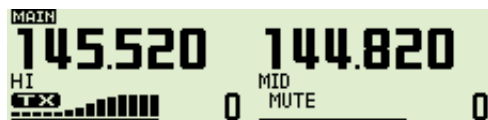

- ① Push and hold either the left or right band's **[MAIN•BAND]** for 1 sec. to select the frequency band selecting condition.
- ② Rotate the same band's **[DIAL]** to select the desired frequency band.
- ③ Push the **[MAIN•BAND]** to return to frequency indication.
- ④ Set the desired frequency.
- ⑤ Repeat the steps ① to ④ for the other band (left or right).

To activate the para-watch function from the HM-133, enter the desired frequencies for each the left and right bands using the direct frequency input capability via the keypad; or perform the following operation.



- ① Push **[BAND]** to select the desired band (left or right) as the main band.
 - Push **[VFO/LOCK]** to select VFO mode, if necessary.
- ② Push **[ENT C(T-OFF)]** to activate the keypad for digit input.
- ③ Push 6 keys to input a frequency.
 - When a digit is mistakenly input, push **[ENT C(T-OFF)]** to clear the input, then repeat input from the 1st digit.
- ④ Push **[VFO/LOCK]** to change main band, then repeat the steps ① to ③ for the other band.

NOTE:

- Memory channels are common for the left and right band.
- Transmitting during the para-watch operation is possible. However, the sub band's reception is deactivated during transmit as shown in the example at left.

■ Sub band mute/busy beep

The sub band mute function automatically cuts out sub band audio signals when both main and sub band signals are received simultaneously.

While operating on the main band, a beep sounds to inform you that a signal was received on the sub band.

- ① Push **[F•↔•O]** to display the function guide.
- ② Push **[MENU](V/MHz•SCAN)** (Right band's) to enter MENU screen.

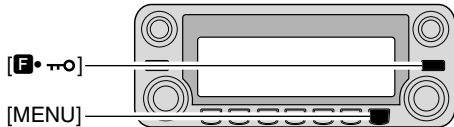

- ③ Rotate **[DIAL]** to select “SOUNDS” then push **[MAIN•BAND]**.
- ④ Rotate **[DIAL]** to select “SUB BAND MUTE” or “SUB BAND BEEP” then push **[MAIN•BAND]**.
- ⑤ Rotate **[DIAL]** to turn the sub band mute or sub band beep function ON and OFF then push **[MAIN•BAND]**.
 - Select “OFF” to deactivate the squelch attenuator function.
- ⑥ Push **[BACK](V/MHz•SCAN)** (Right bnd's) 2 times to exit set mode.

■ Monitor function

This function is used to listen to weak signals without disturbing the squelch setting.

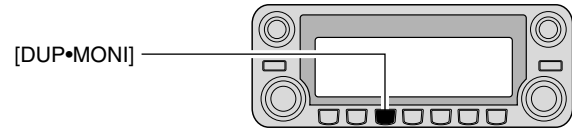

- ➔ After pushing **[MAIN•BAND]**, push and hold **[DUP•MONI]** for 1 sec. to open the squelch.
 - “BUSY” blinks.
 - Push **[DUP•MONI]** again to cancel the function.



- ➔ Push **[MONI 1(BANK)]** to open the squelch.
 - Push **[BAND]** to select the desired band (left or right) as the main band in advance.
 - Push **[MONI 1(BANK)]** again to cancel the function.

NOTE: When the **[SQL]** adjustment is set too far clockwise, (12–5 o'clock position) the squelch attenuator is activated. To monitor weak signals on the operating frequency, deactivate the squelch attenuator function. See pg. ?? for details.

■ Single band operation

◇ Single band/Dualwatch operation

Dualwatch operation monitors two frequencies simultaneously. The IC-2820H has two independent receiver circuits: left band, and right band (available frequencies, operating mode and functions are different depending on bands).

Single band operation is useful when only one frequency is being watched.

- ① Push [**F**•**---**•**o**] to display the function guide.
- ② Push [**SNGL**](**M/CALL**•**MW**) (Right band's) to select the single band operation mode.
 - Both left and right band's [**DIAL**], [**MAIN**•**BAND**], [**VOL**], [**SQ**], [**V/MHz**•**SCAN**] and [**M/CALL**•**MW**] can be used for operation.



- ③ Push [**F**•**---**•**o**] to display the function guide, then push [**DUAL**](**M/CALL**•**MW**) (Right band's) to return to dual watch operation mode.

◇ Diversity operation

The diversity receiving compares the receiving signal strength from two different antennas, ANT1 and ANT2, and automatically selects the strongest signal. This feature is useful when you are listening in a moving vehicle or the transmitting station itself is moving. Diversity receiving is available in 127 MHz, 136 MHz, 146 MHz, 375 MHz, 440 MHz and 500 MHz bands only.

- ① Push [**F**•**---**•**o**] to display the function guide.
- ② Push [**MENU**](**V/MHz**•**SCAN**) (Right band's) to enter MENU screen.
- ③ Rotate [**DIAL**] to select "SET MODE" then push [**MAIN**•**BAND**] to enter set mode.
- ④ Rotate [**DIAL**] to select "DIVERSITY" then push [**MAIN**•**BAND**].
- ⑤ Rotate [**DIAL**] to select ON, then push [**MAIN**•**BAND**].

MENU	MIC SENS LEVEL	HIGH	^
	AUTO ATT	ON	
	ALC	OFF	
SET MODE	DIVERSITY	ON	▢
11/12	GPS	ON	▾
			BACK

- ⑥ Push [**BACK**](**V/MHz**•**SCAN**) (Right band's) to exit set mode.

When the diversity operation is in use, connect the same grade antenna, connected to [ANT1], should be connected to [ANT2].

During single band operation with the diversity function ON, the diversity indicator appears as below.



While [ANT2] is selected;



While [ANT2] is selected;

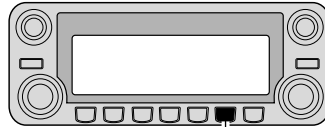

[M/CALL•MW]

Diversity indicator appears.



With the squelch open in FM mode while receiving a weak signal, diversity receiving does not work properly.

One-touch PTT function

The PTT switch can be operated as a one-touch PTT switch (each push toggles between transmit/receive). Using this function you can transmit without pushing and holding the PTT switch.

To prevent accidental, continuous transmissions with this function, the transceiver has a time-out timer. See p. ?? for details.



- 1 Push [FUNC] then [PRIO 3(PTT-M)] to turn the one-touch PTT function ON.
 - The activity indicator lights green.
- 2 Push [PTT] to transmit and push again to receive.
 - A beep sounds when transmission is started and a long beep sounds when returning to receive.
- 3 Push [FUNC] then [PRIO 3(PTT-M)] to turn the one-touch PTT function OFF.
 - The activity indicator goes out.

3 BASIC OPERATION

■ Audio mute function

This function temporarily mutes the audio without disturbing the volume setting. (microphone only)



➔ Push [FUNC] then [SQL▲ D(MUTE)] to mute audio signals.

- The “#MUTE” indicators appear.
- Push [CLR A(MW)] (or any other key) to cancel the function.

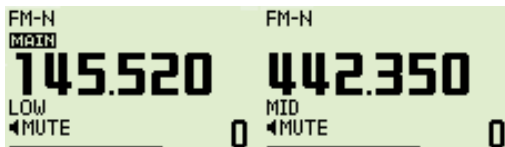

“#MUTE” indicators appear

■ Band scope

The band scope function allows you to visually check a specified frequency range around the center frequency.

/// **About the sweep steps:** The specified tuning step in each frequency band (in VFO mode) or programmed tuning step (in memory mode) is used during sweep.

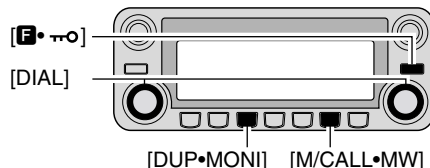
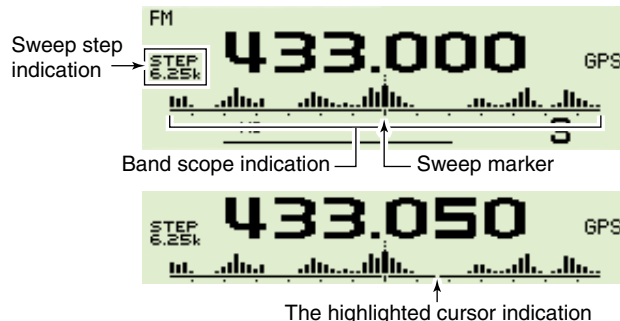

◇ Single sweep

- ① Set the desired frequency as band scope center frequency.
- ② Push **[F•T•O]** to display the function guide.
- ③ Push **[SCP](DUP•MONI)** to start a single sweep.
 - 1 short beep sounds.
 - Signal conditions (strengths) appear starting from the lower edge of the range.
- ④ Rotate **[DIAL]** to set the highlighted cursor to the desired signal and set the frequency of the signal.
- ⑤ Push **[F•T•O]** to display the function guide, then push **[CLR](LOW•PRIO)** to clear the band scope indication.

◇ Continuous sweep

- ① Set the desired frequency as band scope center frequency.
- ② Push **[F•T•O]** to display the function guide.
- ③ Push and hold **[SCP](DUP•MONI)** for 1 sec. to start continuous sweep.
 - 1 short and 1 long beeps sound.
 - Signal conditions (strengths) appear starting from the center of the range.
- ④ To stop sweeping, push **[F•T•O]** to display the function guide, then push **[SCP](DUP•MONI)**.
- ⑤ Push **[F•T•O]** to display the function guide, then push **[CLR](LOW•PRIO)** to clear the band scope indication.

/// The receive audio during sweeping can be muted in sounds set mode. See page 102 for details.

◇ Monitoring a signal

If you find a signal that you want to monitor during/after sweep, you can monitor the signal with the following operation.

- ① Push **[F•T•O]** to display the function guide, then push **[SCP](DUP•MONI)** to cancel the continuous sweep, if necessary.
- ② Rotate **[DIAL]** to tune into the desired signal.
- ③ Push **[CENT](TONE•DTMF)** to return to the center frequency.

■ General

Repeaters allow you to extend the operational range of your radio because a repeater has much higher output power than the typical transceiver.

Normally, a repeater has independent frequencies for each receiver and transmitter. A subaudible tone may also be required to access a repeater.

Reference amateur radio hand books and local ham magazines for details of local repeaters such as repeater input/output frequencies and locations.

Repeater example;

Receives the 444.540 MHz signal and the detected audio signals are transmitted on 449.540 MHz simultaneously.

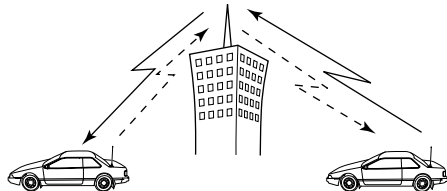

Station A:
Tx: 444.540 MHz
Rx: 449.540 MHz

Station B:
Tx: 444.540 MHz
Rx: 449.540 MHz

• Repeater operation flow chart

Step 1:

Set the desired band to operate the repeater.

Step 2:

Set the desired receive frequency (repeater output frequency).

Step 3:

Set the duplex (shifting) direction (- duplex or +duplex).
- Set the offset frequency (shifting value), if required.

Step 4:

Set the subaudible tone (repeater tone) encoder function ON.
- Set the subaudible tone frequency, if required.

- The IC-2820H USA version has the auto repeater function. Thus the steps 3 and 4 may not be necessary, depending on the setting.
- Repeater settings can be stored into a memory channel.

■ Accessing a repeater

- ① Set the receive frequency (repeater output frequency) on the main band. (pgs. ??-??)
- ② Push **[DUP•MONI]** one or two times, to select minus duplex or plus duplex.
 - “DUP-” or “DUP+” appears to indicate the transmit frequency for minus shift or plus shift, respectively.
 - When the auto repeater function is turned ON (available for the USA version only), steps ② and ③ are not necessary. (p. ??)

“DUP-” or “DUP+” appear

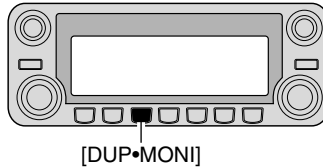

- ③ Push **[TONE•DTMF]** several times to turn ON the subaudible tone encoder, according to repeater requirements.
 - “TONE” appears
 - 88.5 Hz is set as the default; refer to p. ?? for tone frequency settings.
 - When the repeater requires a different tone system, see p. ??.

“TONE” appear

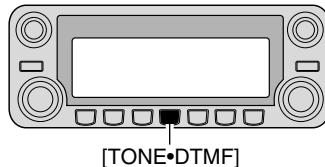
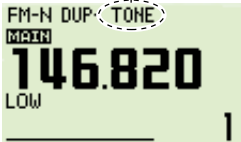

- ④ Push and hold **[PTT]** to transmit.
 - The displayed frequency automatically changes to the transmit frequency (repeater input frequency).
 - If “OFF” appears, confirm that the offset frequency (p. ??) is set correctly.
- ⑤ Release **[PTT]** to receive.



While receiving

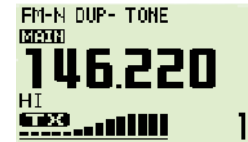

While transmitting

- ⑥ Push **[DUP•MONI]** to check whether the other station's transmit signal can be received directly.
- ⑦ To return to simplex operation, push **[DUP•MONI]** once or twice, to clear the “DUP-” or “DUP+” indicator.
- ⑧ To turn OFF the subaudible tone encoder, push **[TONE•DTMF]** several times until no tone indicators appear.

4 REPEATER OPERATION



- 1 Set the receive frequency (repeater output frequency) on the main band. (pgs. 11–13)
- 2 Push [DUP- 7(TONE)] to select minus duplex; push [DUP+ 8(TSQL (·)))] to select plus duplex.

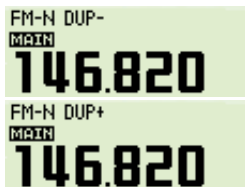
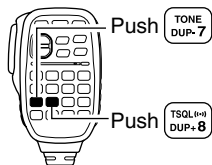

- 3 Push [FUNC] then [DUP- 7(TONE)] to turn ON the subaudible tone encoder according to repeater requirements.
 - Refer to p. 25 for the tone frequency setting.
 - When the repeater requires a different tone system, see p. 26.

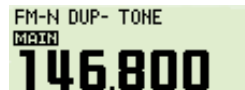
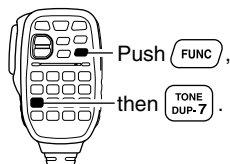

- 4 Push and hold [PTT] to transmit.
- 5 Release [PTT] to receive.
- 6 Push [MONI 1(BANK)] to check whether the other station's transmit signal can be received directly.



- 7 Push [SIMP 9(TSQL)] to return to simplex operation.
 - “DUP” or “DUP-” indicator disappears.
- 8 To turn OFF the subaudible tone encoder, push [FUNC] then [ENT C(T-OFF)].

■ Subaudible tones (Encoder function)

◇ Subaudible tones

- ① Select the main band, mode/channel you wish to set the subaudible tones to, such as VFO mode or memory/call channel.
- ② Push **[F•••o]** to display the function guide.
- ③ Push **[MENU](V/MHz•SCAN)** (Right band's) to enter MENU screen.
- ④ Rotate **[DIAL]** to select "DUP/TONE..." then push **[MAIN•BAND]**.
- ⑤ Rotate **[DIAL]** to select "REPEATER TONE" then push **[MAIN•BAND]**.
- ⑥ Rotate **[DIAL]** to select and set the desired subaudible frequency, then push **[MAIN•BAND]**.

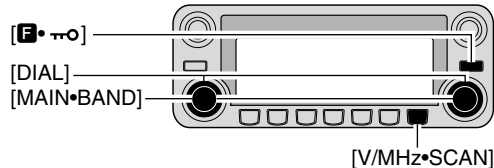

- ⑦ Push **[BACK](V/MHz•SCAN)** (Right band's) twice to exit DUP/TONE set mode.

NOTE: The subaudible tone encoder frequency can be set in a memory/call channel temporarily. However, the set frequency is cleared once another memory channel or VFO mode is selected. To store the tone frequency permanently, overwrite the channel information.



- ① Set the main band, mode/channel you wish to set the subaudible tones to, such as VFO mode or memory/call channel.
 - The subaudible tone frequency is independently programmed into each mode or channel.
- ② Push **[SET B(D-OFF)]** to enter MENU screen.
- ③ Push **[▲]** or **[▼]** to select "DUP/TONE..." then push **[SET B(D-OFF)]**.
- ④ Push **[▲]** or **[▼]** to select "REPEATER TONE" then push **[SET B(D-OFF)]**.
- ⑤ Push **[▲]** or **[▼]** to select the desired subaudible tone frequency then push **[SET B(D-OFF)]**.

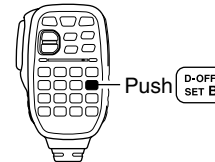

- ⑥ Push **[CLR A(MW)]** to return VFO mode.

• Subaudible tone frequency list

(unit: Hz)

67.0	79.7	94.8	110.9	131.8	156.7	171.3	186.2	203.5	229.1
69.3	82.5	97.4	114.8	136.5	159.8	173.8	189.9	206.5	233.6
71.9	85.4	100.0	118.8	141.3	162.2	177.3	192.8	210.7	241.8
74.4	88.5	103.5	123.0	146.2	165.5	179.9	196.6	218.1	250.3
77.0	91.5	107.2	127.3	151.4	167.9	183.5	199.5	225.7	254.1

4 REPEATER OPERATION

◇ DTMF tones



➔ Push [DTMF-S], then push the keys of the desired DTMF digits.

- The function indicator lights green.
- 0–9, A–D, *(E) and #(F) are available.
- When “☎” is displayed, cancel the DTMF memory encoder in advance. (p. 50)
- Push [DTMF-S] again to return the keypad to normal function control.

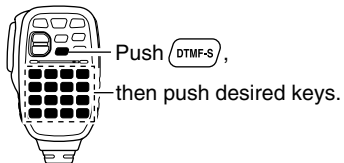

✓ For your convenient!

The transceiver has 16 DTMF memory channels for autopatch operation. See p. 48 for details.

◇ 1750 Hz tone

The microphone has 1750 Hz tone capability, used for ring tone when calling, etc.



- 1 Push [FUNC].
 - The function indicator lights orange.
- 2 Push [*(TONE-1)] to transmit a 1750 Hz tone call signal for 0.5 sec.; push and hold [0(TONE-2)] to transmit a 1750 Hz tone call signal for an arbitrary period.
 - The function indicator goes out automatically.

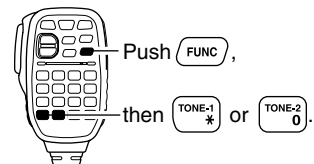

■ Offset frequency

When communicating through a repeater, the transmit frequency is shifted from the receive frequency by an amount determined by the offset frequency.

Independent offset frequencies can be set for each operating frequency band.

- ① Push **[MAIN•BAND]** to select the desired band (left or right) as the main band.
- ② Select the desired mode/channel you wish to set the offset frequency to, such as VFO mode or memory/call channel.
- ④ Push **[F•↔]** to display the function guide then push **[MENU](V/MHz•SCAN)** (Right band's) to enter MENU screen.
- ⑤ Rotate the **[DIAL]** to select “DUP/TONE...”, then push **[MAIN•BAND]**.

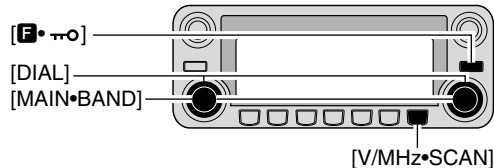

- ⑥ Rotate the **[DIAL]** to select “OFFSET FREQ” item, then push **[MAIN•BAND]**.
- ⑦ Rotate the main band's **[DIAL]** to set the desired offset frequency.
- ⑧ Push **[BACK](V/MHz•SCAN)** (Right band's) twice to exit DUP/TONE set mode.



- ① Push **[BAND]** to select the desired band (left or right) as the main band.
 - Enter the desired frequency via the keypad if necessary.
- ② Select the desired mode/channel you wish to set the offset frequency to, such as VFO mode or memory/call channel.
 - The offset frequency can be independently programmed into each mode or channel.
- ③ Push **[SET B(D-OFF)]** to enter MENU screen.
- ④ Push **[▲]** or **[▼]** to select “DUP/TONE...” then push **[SET B(D-OFF)]**.
- ④ Push **[▲]** or **[▼]** to select “OFFSET FREQ” then push **[SET B(D-OFF)]**.
- ⑤ Push **[▲]** or **[▼]** to set the desired offset.
 - Direct frequency entry from the keypad is not possible.
- ⑥ Push **[CLR A(MW)]** to exit set mode.

NOTE: The offset frequency can be set in a memory/call channel temporarily. However, the set frequency is cleared once another memory channel or VFO mode is selected. To store the offset frequency permanently, overwrite the channel information.

4 REPEATER OPERATION

■ Auto repeater

The U.S.A. and Korean versions automatically use standard repeater settings (duplex ON/OFF, duplex direction, tone encoder ON/OFF) when the operating frequency falls within or outside of the general repeater output frequency range. The offset and repeater tone frequencies are not changed by the auto repeater function, reset these frequencies, if necessary.

◇ Frequency range and offset direction

• U.S.A. version

FREQUENCY RANGE	SHIFT DIRECTION
145.200–145.495 MHz 146.610–146.995 MHz	“DUP-” appears
147.000–147.395 MHz	“DUP+” appears
442.000–444.995 MHz	“DUP+” appears
447.000–449.995 MHz	“DUP-” appears

• Korean version

FREQUENCY RANGE	SHIFT DIRECTION
439.000–440.000 MHz	“DUP-” appears

U.S.A./KOREAN versions only

- ① Push [**F**••••] to display the function guide.
- ② Push [**MENU**](V/MHz•SCAN) (Right band's) to enter MENU screen.
- ③ Rotate [**DIAL**] to select “SET MODE” then push [**MAIN**•BAND].
- ④ Rotate [**DIAL**] to select “AUTO REPEATER” then push [**MAIN**•BAND].
- ⑤ Rotate [**DIAL**] to select the auto repeater setting.
[U.S.A. version]:
 - “ON1” : Activates duplex only. (default)
 - “ON2” : Activates duplex and tone.
 - “OFF” : Auto repeater function is turned OFF.[Korean version]:
 - “ON” : Activates duplex and tone. (default)
 - “OFF” : Auto repeater function is turned OFF.
- ⑥ Push [**BACK**](V/MHz•SCAN) (Right band's) twice to exit from set mode.

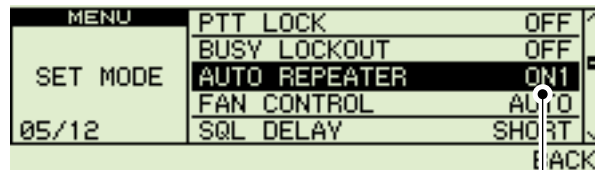

Auto Repeater set: ON1
(USA version)

■ General description

The transceiver has 522 memory channels including 20 scan edge memory channels (10 pairs), and 2 call channels. Each of these channels can be individually programmed with operating frequency (pgs. ??-??), duplex direction (p. ??) and offset (p. ??), subaudible tone encoder or tone squelch and its tone frequency (pgs. ??, ??, ??, ??) and skip information* (p. ??). In addition, a total of 26 memory banks, A to Z, are available for usage by group, etc.

*except for scan edge memory channels.

■ Memory channel selection

◇ Using the tuning dial

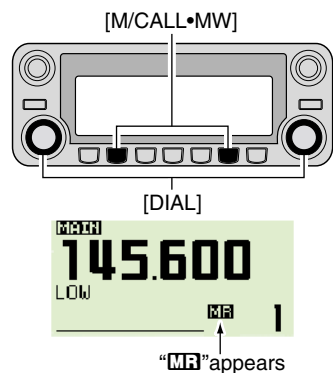

- 1 Push the desired band's **[M/CALL•MW]** several times to select memory mode.
 - "MR" indicator appear
- 2 Rotate the same band's **[DIAL]** to select the desired memory channel.
 - Programmed memory channels only can be selected.

◇ Using the [▲]/[▼] keys



- 1 Push **[BAND]** to select the desired band as the main band.
- 2 Push **[MR/CALL]** to select memory mode.
- 3 Push **[▲]** or **[▼]** to select and set the desired memory channel.
 - Pushing and holding **[▲]/[▼]** for 1 sec. activates a scan.
 - If scan is activated, push **[▲]/[▼]** again or push **[CLR A(MW)]** to stop it.

◇ Using the keypad



- 1 Push **[BAND]** to select the desired band as the main band.
- 2 Push **[MR/CALL]** to select memory mode.
- 3 Push **[ENT C(T-OFF)]** to activate the keypad for numeral input.
- 4 Push 3 appropriate digit keys to input a channel number.
 - Blank channel can be selected.
 - Push only 1 appropriate digit key, **[VOL▲ 0(TONE-2)]** to **[SIMP 9(16-KEY-L)]** then push **[*(TONE-1)]** or **[SQL▼ #(16KEY-L)]** to select scan edge channels. "*" and "#" can be used for "A" and "b" respectively.

■ Programming a memory channel

VFO settings, including MENU group's contents such as sub-audible tone frequency, offset, can be programmed into a memory channel.

- ① Set the desired frequency in the desired band (left or right).
 - ➔ Push the desired band's [V/MHz•SCAN] to select VFO mode.
 - ➔ Set the frequency using the same band's [DIAL].
 - ➔ Set other data (e.g. tone frequency, duplex information, etc.) if required.
- ② Push and hold the same band's [M/CALL•MW] for 1 sec.
 - 2 beeps sound
 - "MR" indicator and the memory channel number blink.

- ③ Rotate the [DIAL] to select the memory channel to be programmed.
 - Memory channels not yet programmed are blank.
- ④ Push and hold the same band's [M/CALL•MW] for 1 sec. to program.
 - 3 beeps sound
 - Memory channel number automatically increases when continuing to push [M/CALL•MW] after programming.

✓ CONVENIENT

Memory programming can be performed in versatile ways e.g. memory channel to the same (or different) memory channel, memory channel to the call channel, etc.

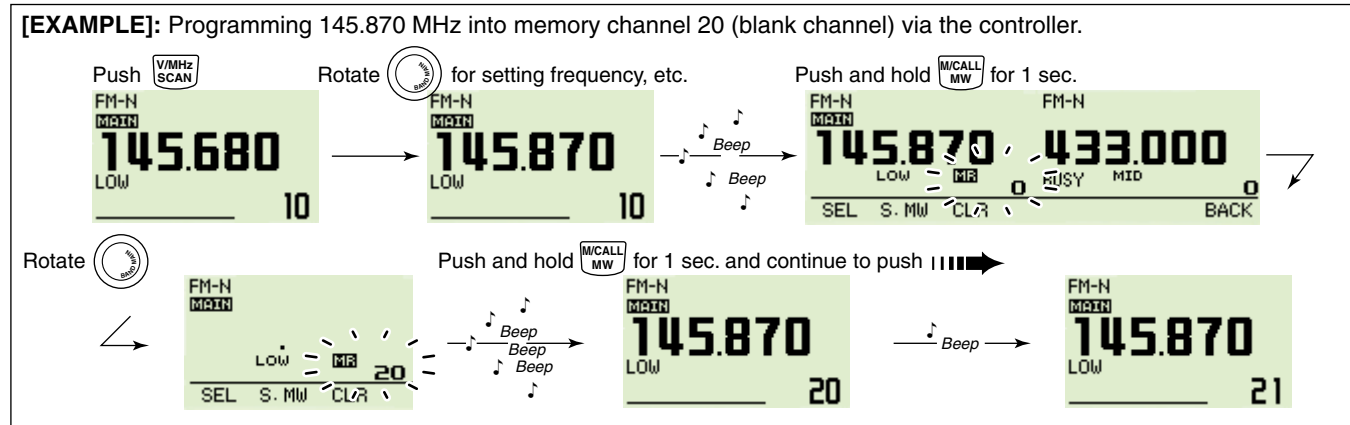

5 MEMORY OPERATION

◆ Programming a memory channel via the microphone



The microphone can also be used to program memory channels.

- 1 Set the desired frequency in VFO mode.
 - ➔ Push [VFO/LOCK] to select VFO mode.
 - ➔ Set the frequency using the keypad.
 - ➔ Set other data (e.g. offset frequency, duplex direction, sub-audible tone encoder ON/OFF and its frequency), if necessary.
- 2 Push [MR/CALL] to enter memory mode.
- 3 Push [ENT C(T-OFF)], then set the desired memory channel using the keypad.
- 4 Push [VFO/LOCK] to select VFO mode.
- 5 Push [FUNC] then push and hold [CLR A(MW)] for 1 sec. to program.
 - ➔ 3 beeps may sound and the VFO contents (including the subaudible tone frequency, etc.) are programmed.
 - ➔ Memory channel number increases when continuing to push [CLR A(MW)] after programming.

[EXAMPLE]: Programming 145.870 MHz into memory channel 20 (blank channel) via the microphone.

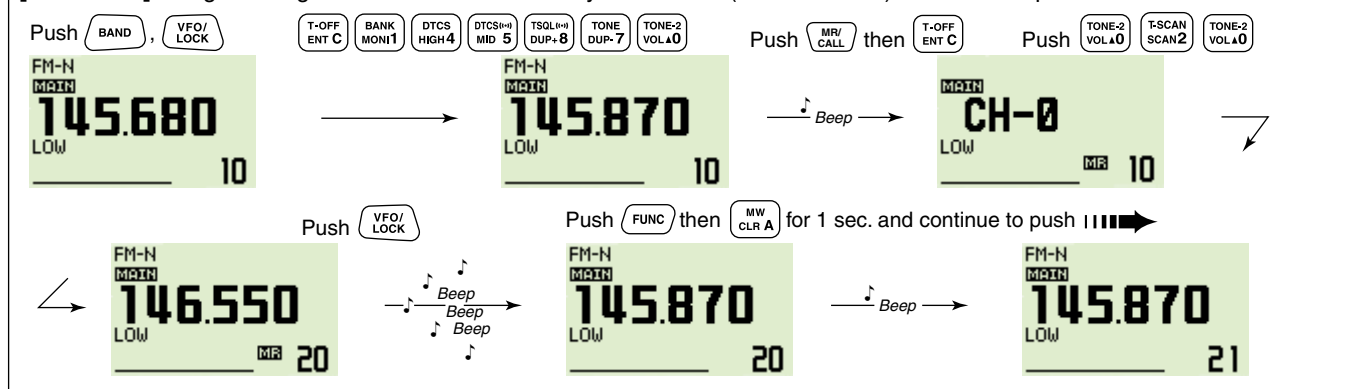

■ Memory bank selection

The IC-2820H has a total of 26 banks (A to Z). All memory channels, regular, scan edges and call channels are assigned into the desired bank for easy memory management.

- ① Push the desired band's **[M/CALL•MW]** several times to select memory mode, if desired.
- ② Push and hold the same band's **[MAIN•BAND]** for 1 sec.
 - The memory channel number blinks.
- ③ Rotate the same band's **[DIAL]** to select the desired bank, A to Z.
 - Banks that have no programmed contents are skipped.
- ④ Push the **[MAIN•BAND]** to set the bank group.
 - Bank initial and bank channel stop blinking.
- ⑤ Rotate the same band's **[DIAL]** to select the bank channel.
- ⑥ To return to regular memory mode, push and hold the **[MAIN•BAND]** for 1 sec. then rotate the **[DIAL]** to select memory channel number indication.

Enter the memory bank condition mode.

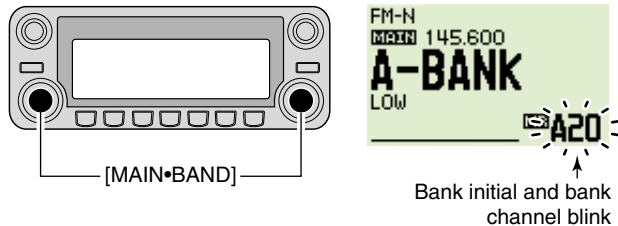

- ① Push **[MR/CALL]** to select memory mode, if desired.

- ② Push **[FUNC]** then **[MONI 1(BANK)]** to select memory bank condition.

Or, push and hold **[BAND]** for 1 sec. to select memory bank condition.

- Memory channel blinks

- ③ Push **[▲]/[▼]** to select the desired bank, A to Z.
 - Only programmed memory bank can be selected.

- ④ Push **[CLR A(MW)]** to set the bank.

Or, push **[BAND]** to set the bank.

- Bank initial and bank channel stops blinking.

- ⑤ Push **[▲]/[▼]** to select the desired contents in the bank.

• No channel numbers are displayed for memory bank operation.

- ⑥ To return to regular memory condition, push **[FUNC]**, **[MONI 1(BANK)]** then push **[▲]/[▼]** to select memory channel number indication.

Or, push and hold **[BAND]** for 1 sec., then push **[▲]/[▼]** to select memory channel number indication.



5 MEMORY OPERATION

■ Memory bank setting

- ① Push the desired band's **[M/CALL•MW]** several times to select memory mode, then rotate the same band's **[DIAL]** to select the desired memory channel.
- ② Push and hold the same band's **[M/CALL•MW]** for 1 sec.
 - “**MR**” and memory number indication blinks.
- ③ Push **[SEL](V/MHz•SCAN)** (Left band's) several times to select “BANK” setting stand-by condition.
 - “**MR**” indicator blinks.
- ④ Push **[EDIT](M/CALL•MW)** (Right band's) to edit.
 - “**MR**” and 1st digit blink.

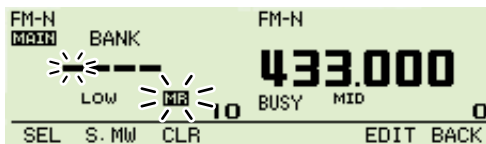

- ⑤ Rotate the same band's **[DIAL]** to select the desired bank group.
 - A to Z bank groups available.
- ⑥ Push **[>](M/CALL•MW)** (Left band's) then rotate **[DIAL]** to select the desired bank channel.
 - “**MR**” and last 2 digits blink.

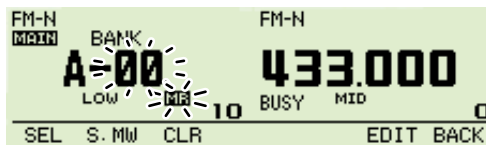

- ⑦ Push **[BACK](V/MHz•SCAN)** (Right band's) to set the bank initial and channel number.
 - “**MR**” indicator blinks.
- ⑧ Push and hold **[S.MW](M/CALL•MW)** (Left band's) for 1 sec. to overwrite the memory channel to store the memory bank settings.
- ⑨ Repeat steps ① to ⑧ to set another memory channel into the same or another bank.

■ Programming memory/bank/scan name

Each memory channel can be programmed with an alphanumeric channel name for easy recognition and can be indicated independently by channel. Names can be a maximum of 8 characters— see the table right below for available characters.

- ① Select the desired memory channel to be programmed.
 - ➔ Push **[M/CALL•MW]** several times to select memory mode, then rotate the same band's **[DIAL]** to select the desired memory channel.
- ② Push and hold the same band's **[M/CALL•MW]** for 1 sec. to enter select memory write mode.
 - “**MB**” indicator and the memory channel number blink.
- ③ Push **[SEL](V/MHz•SCAN)** (Left band's) several times to select programming the name conditions.
 - “BANK” : The memory bank
 - “B NAME” : The bank name (appears only when the selected memory bank is edited into a bank)
 - “M NAME” : The memory name
 - “S NAME” : The scan name (appears only when a scan edge channel is selected)
 - Frequency readouts disappear.
- ④ Push **[EDIT](M/CALL•MW)** (Right band's) to edit.
 - “**MB**” indicator and cursor blinks.
- ⑤ Rotate the same band's **[DIAL]** to select the desired character.
 - The selected character blinks.
 - Push **[Aa](TONE•DTMF)** to turn the character group from alphabetical characters capital letters or lower case letters.

- Push **[12](M/CALL•MW)** (Right band's) to turn the character group from numbers or symbols.
 - Push **[>](M/CALL•MW)** (Left band's) to move the cursor right; push **[<](V/MHz•SCAN)** (Left band's) to move the cursor left.
 - Push **[CLR](DUP/MONI)** to clear the selected character.
- ⑥ Repeat steps ③ and ⑤ until the desired channel name is programmed.
 - ⑦ Push **[BACK](V/MHz•SCAN)** (Right band's) to set the name.
 - ⑧ Push and hold **[S.MW](M/CALL•MW)** (Right band's) for 1 sec. to overwrite the memory channel to store the memory name.

NOTE: Only one bank name can be programmed into each bank. Therefore, the previously programmed bank name will be displayed when bank name indication is selected. Also, the programmed bank name is assigned for the other bank channels automatically.

◇ Available characters

ABCDEFGHIJKLMNOPQRSTUVWXYZ
abcdefghijklmnopqrstuvwxyz
0123456789
(Space)! " # \$ % & ' () * + , -
. / : ; < = > ? @ [\] ^ _ ` { } ~

5 MEMORY OPERATION

[EXAMPLE]: Programming the bank name “AIR” into the scan edge channel 3A.

Memory mode
 FM-N
 MAIN 745.870
 LOW MR 10
 Push **[M/CALL MW]** (Main band's) to select memory mode.

Rotate **[DIAL]** (Main band's) to select scan edge channel 3A.
 AM
 MAIN 127.500
 LOW MR 3A
 Rotate **[DIAL]** (Main band's) to select scan edge channel 3A.

Push and hold **[M/CALL MW]** (Main band's) for 1 sec. to enter select memory write condition.
 Select memory write mode
 FM-N FM-N
 MAIN 127.500 433.000
 LOW MR 3A BUSY MID 0
 SEL S. MW CLR BACK

Bank name edit mode
 FM-N B NAME FM-N
 MAIN 433.000
 LOW MR 3A BUSY MID 0
 SEL S. MW CLR EDIT BACK
 Push **[SEL V/MHz SCAN]** (Main band's) several times to select “B NAME”.

Push **[M/CALL MW]** (Right band's) to enter bank name edit mode.
 EDIT
 M/CALL MW
 Rotate **[DIAL]** (Main band's) to select “A”, then push **[M/CALL MW]**.

Enter “I” and “R” with **[DIAL]** (Main band's) and **[M/CALL MW]** (Left band's), then push **[SEL V/MHz SCAN]** (Right band's) to select memory write mode.
 FM-N B NAME FM-N
 MAIN AIR 433.000
 LOW MR 3A BUSY MID 0
 SEL S. MW CLR BACK

Push and hold **[M/CALL MW]** (Left band's) for 1 sec. to program.

*Select “M NAME” or “S NAME” when programming the memory name or the scan name, respectively.

◆ To indicate the channel name

The channel name indication can be set independently for each memory channel.

- ① Select the desired memory channel in the main band.
 - ➔ Push the same band's **[M/CALL•MW]** several times to select memory mode, then rotate the same band's **[DIAL]** to select the desired memory channel.
 - “MR” and memory channel number appear.
- ② Push **[F••••]** to display the function guide.

- ③ Push **[M.N](LOW•PRIO)** several times to select “MEMORY,” “FREQ” or OFF.
 - When “MEMORY” is selected, the programmed memory name is indicated above frequency indication; when “FREQ” is selected, the programmed memory name is indicated at the frequency indication and the programmed frequency is indicated above the memory name.
- ④ Push **[F••••]** twice to exit the function guide.

NOTE: When no memory name is programmed, the stored frequency is displayed.

■ Transferring memory contents

This function transfers a memory channel's contents to VFO (or another memory/call channel). This is useful when searching for signals around a memory channel frequency and for recalling the offset frequency, subaudible tone frequency etc.

◇ Memory/call↔VFO

- ① Select the desired band's (left or right) memory or call channel.
 - ➔ Push the desired band's [M/CALL•MW] several times to select memory mode or call channel, then rotate the same band's [DIAL] to select the desired memory or call channel.
- ② Push and hold [M/CALL•MW] for 1 sec. to transfer the selected memory/call channel contents to the VFO.
 - VFO mode is selected automatically.

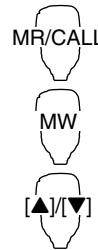

- ① Push [BAND] to select the desired band as the main band, if necessary.
- ② Select the memory/call channel to be transferred.
 - ➔ Push [MR/CALL] to select memory mode, then select the desired memory channel via [▲]/[▼] or keypad.
 - ➔ Push and hold [MR/CALL] for 1 sec. then push [▲]/[▼] to select the call channel.
- ③ Push [FUNC], then push and hold [CLR A(MW)] for 1 sec. to transfer the selected memory/call channel contents to the VFO.
 - VFO mode is selected automatically.

[EXAMPLE]: Transferring memory channel 30 contents to VFO.

Front panel operation:

Push to select memory mode. Rotate for selecting memory channel. Push and hold (same band's) for 1 sec.

HM-133 operation:

Push to select memory mode. Select memory channel. Push then push and hold for 1 sec.

5 MEMORY OPERATION

◇ Memory/call↔call/memory

- ① Select the memory/call channel to be transferred.
 - ➔ Push the desired band's **[M/CALL•MW]** several times to select memory mode or call channel, then rotate the same band's **[DIAL]** to select the desired memory or call channel.
- ② Push and hold the same band's **[M/CALL•MW]** for 1 sec.
 - “**MR**” indicator and the memory channel number blink, and shows VFO conditions.
- ③ Rotate the same band's **[DIAL]** to select the target memory channel.
 - “C1” or “C2” blinks when the call channel is selected.
 - Scan edge channels, 1A/1b, 2A/2b, 3A/3b, 4A/4B, 5A/5b can also be selected.
- ④ Push and hold the **[S.MW](M/CALL•MW)** (Left band's) for 1 sec. to transfer the selected memory/call channel contents to the target memory.
 - The targeted memory and transferred contents are indicated.

[EXAMPLE]: Transferring memory channel 30 contents to channel 31.

Select the memory channel,
then push and hold  for 1sec.

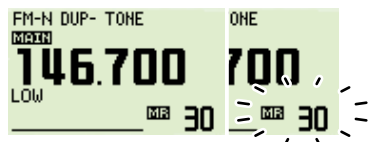

Select the target channel.

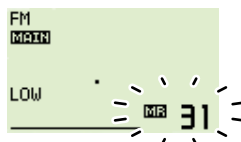

Push and hold  for 1 sec.

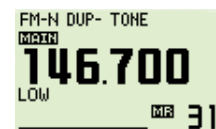

Memory clearing

Contents of programmed memories can be cleared (blanked), if desired.

- ① Push **[V/MHz•SCAN]** to select VFO mode in the desired band (left or right).
- ② Push and hold the same band's **[M/CALL•MW]** for 1sec.
 - “**MR**” indicator and the memory channel number blink.
- ③ Rotate **[DIAL]** to select the memory channel to be cleared.
- ④ Push and hold **[CLR](DUP•MONI)** for 1sec. to clear.
 - 3 beeps sound, then the frequency is cleared.
 - “**MR**” indicator and the channel number blink continuously.
 - When clearing the call channel, the current VFO conditions are re-programmed into the call channel automatically.

- ⑤ Push **[BACK](V/MHz•SCAN)** (Right band's) to return to VFO mode.

NOTE: Be careful!— the contents of cleared memories **CANNOT** be recalled.

[EXAMPLE]: Clearing memory channel 20.

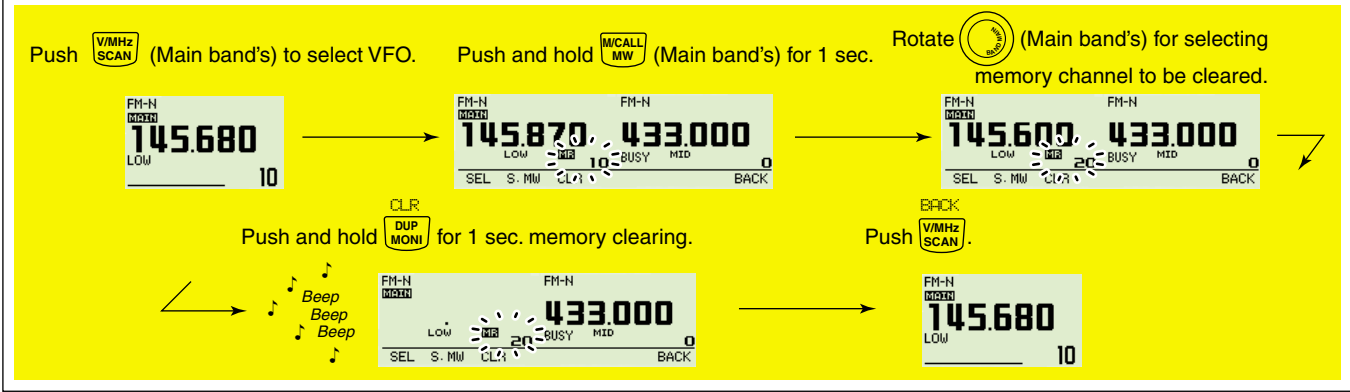

5 MEMORY OPERATION

■ Erasing/transferring bank contents

Contents of programmed memory banks can be cleared or transferred to another bank.

INFORMATION: Even if the memory bank contents are cleared, the memory channel contents still remain programmed.

- ① Select the desired bank contents to be transferred or erased from the band (left or right).
 - ➔ Push the desired band's **[M/CALL•MW]** several times to select memory mode.
 - ➔ Push and hold the same band's **[MAIN•BAND]** for 1 sec. then rotate the same band's **[DIAL]** to select the desired memory bank.
 - Bank initial and bank channel stops blinking.
 - ➔ Push the **[MAIN•BAND]** to select the bank then rotate the **[DIAL]** to select the desired bank channel.
 - Bank initial and bank channel stops blinking.
- ② Push and hold the same band's **[M/CALL•MW]** for 1 sec.
 - “**MR**” indicator and the memory channel number blink

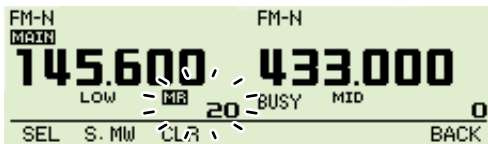

- ③ Push **[SEL](V/MHz•SCAN)** (Left band's) several times to select bank, then push **[EDIT](M/CALL•MW)** (Right band's).

- ④ Rotate **[DIAL]** to select the desired bank initial (A to Z) to transfer.
 - Select no indication, “---,” when erasing the contents from the bank.
- ⑤ Push **[>](M/CALL•MW)** (Left band's) then rotate the same band's **[DIAL]** to select a bank channel, if desired.
- ⑥ Push **[BACK](V/MHz•SCAN)** (Right band's) to back the select memory write mode.
- ⑦ Push and hold **[S.MW](M/CALL•MW)** (Left band's) for 1 sec. to be transferred or erased.
- ⑧ Repeat steps ① to ⑤ for transferring or erasing an another banks contents.

Call channel selection

Call channel is pre-programmed memory channel that can be accessed by simply pushing call channel button.

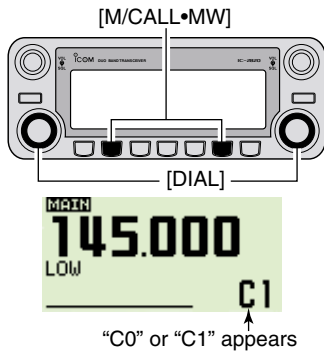

- ➔ Push **[M/CALL•MW]** several times to select the call channel mode then rotate the same band's **[DIAL]** to select the desired call channel.
 - “C0” or “C1” appears instead of memory channel number indication.
 - Push the **[M/CALL•MW]** several times to select memory mode, or push the same band's **[V/MHz•SCAN]** to select VFO mode.



- ➔ Push and hold **[MR/CALL]** for 1 sec. to select the call channel mode then push **[▲]/[▼]** to select the desired call channel in the main band.
 - Push **[MR/CALL]** to select memory mode, or push **[VFO/LOCK]** to select VFO mode.

✓ INFORMATION

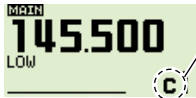

When the VFO mode is selected from the call channel, a small “c” appears instead of memory channel number.

Call channel transferring

◇ Call⇨VFO/Memory

- ① Push the desired band's **[M/CALL•MW]** several times to select cal channel mode, then rotate the same band's **[DIAL]** to select the desired call channel.
 - “C0” or “C1” appears.
- ② Push the **[M/CALL•MW]** for 1 sec., then rotate the **[DIAL]** to select the memory channel to transfer the contents to.
 - “**[MR]**” indicator and memory channel number blink.
 - To transfer to the VFO mode, select VFO indication with the **[DIAL]**.
- ③ Push the **[M/CALL•MW]** for 1 sec. to transfer the contents.

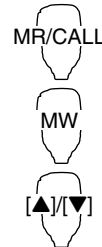

- ① Push **[MR/CALL]** for 1 sec. then push **[▲]/[▼]** to select the desired call channel in the main band.
- ② Push **[FUNC]**, then **[CLR A(MW)]** for 1 sec. to transfer the contents.
 - To transfer to the VFO only.

6 CALL CHANNEL OPERATION

■ Programming a call channel



Operating frequency, duplex information, subaudible tone information (tone encoder or tone squelch ON/OFF and its frequency) can be programmed into the call channel.

- ① Set the desired frequency in VFO mode.
 - ➔ Push the desired band's [V/MHz•SCAN] to select VFO mode.
 - ➔ Set the frequency using the same band's [DIAL].
 - ➔ Set other data as desired.
- ② Push the same band's [M/CALL•MW] for 1 sec.
- ③ Rotate the [DIAL] to select the desired call channel.
 - "[MR]" indicator and "C0" or "C1" blink.

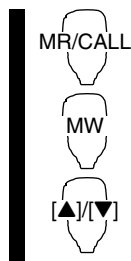
- ④ Push the [M/CALL•MW] for 1 sec. to program.
 - 3 beeps sound and the unit returns to VFO mode automatically.

- 
- ① Push and hold [MR/CALL] for 1 sec. to select call channel mode.
 - ➔ Push [▲] or [▼] to select desired call channel.
 - ② Push [VFO/LOCK] to select VFO mode.
 - ➔ Set the frequency.
 - ③ Push [FUNC] then [CLR A(MW)] for 1 sec. to program.
 - 3 beeps sound.

[EXAMPLE]: Programming 145.120 MHz into the call channel 1 via the microphone.

Push and hold  for 1 sec. to select call channel mode. Push  to select the call channel "C1". Push  to select VFO mode.

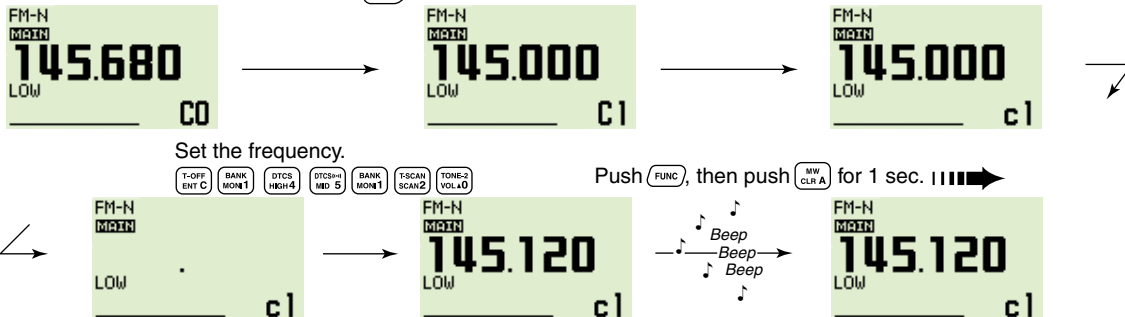

Scan types

Scanning searches for signals automatically and makes it easier to locate new stations for contact or listening purposes.

There are 7 scan types and 4 resume conditions to suit your operating needs.

FULL SCAN (p. ??)

Repeatedly scans all frequencies over the entire band.

Some frequency ranges are not scanned according to the frequency coverage of the transceiver's version.

SELECTED BAND SCAN (p. ??)

Repeatedly scans all frequencies over the entire selected band.

PROGRAMMED SCAN (p. ??)

Repeatedly scans between two user-programmed frequencies. Used for checking for frequencies within a specified range such as repeater output frequencies, etc.

MEMORY (SKIP) SCAN (p. ??)

Repeatedly scans memory channels except those set as skip channel. Skip channels can be turned ON and OFF in function guide.

ALL/SELECTED BANK SCAN (p. ??)

Repeatedly scans all bank channels or selected bank channels. The skip scan is also available.

FREQUENCY/MEMORY SKIP FUNCTION (p. ??)

Skips unwanted frequencies or channels that inconveniently stop scanning. This function can be turned ON and OFF by pushing and holding [SKIP](5) in either VFO or memory mode.

7 SCAN OPERATION

■ Scan start/stop

◇ Preparation

Scan resume condition (p. ??); program the scan edges (pgs. ??, ??); program 2 or more memory channels (pgs. ??, ??); set skip settings, if desired (p. ??).

◇ Operation

- 1 Select VFO mode for full/programmed scan with **[V/MHz•SCAN]**; or memory mode for memory scan with **[M/CALL•MW]** in the desired band.
 - Select the desired bank with the same band's **[MAIN•BAND]** for bank scan.
- 2 Set the squelch to the point where noise is just muted.
- 3 Push and hold **[V/MHz•SCAN]** for 1 sec. to start the scan.
 - To change the scanning direction, rotate the same band's **[DIAL]**.
 - The memory channel readout blinks the scan type as follows:
- 4 Push **[E•→○]** to switch the full and programmed scan (P1 to P9), if VFO is selected in step 1.
- 5 To stop the scan, push the **[V/MHz•SCAN]** in the desired band.

• During full scan



Rotate **[DIAL]** to select "ALL" (full) or programmed scan (P1 to P9) in sequence.

• During programmed scan



Indicates scan edge channels.

- P1 stands for 1A/1B

• During memory scan



• During bank scan



Indicates bank initial.



- 1 Push **[VFO/LOCK]** to select VFO mode for full/programmed scan; push **[MR/CALL]** to select memory mode for memory scan, in the main band.
 - Push **[FUNC]** then **[MONI 1(BANK)]** to select a bank for bank scan.
- 2 Push **[SQL▲ D(MUTE)]** or **[SQL▼ #(16KEY-L)]** to set the squelch to the point where noise is just muted.
- 3 Push **[SCAN 2(T-SCAN)]** to start the scan.
 - Push **[▲]** or **[▼]** for 1 sec. also starts the scan.
- 4 Push **[SET B(D-OFF)]** to switch the full and programmed scan (P1, P2, P3, P4 and P5), if VFO is selected in step 1.
- 5 To stop the scan push **[SCAN 2(T-SCAN)]** or **[CLR A(MW)]**.

■ Scan edges programming

Scan edges can be programmed in the same manner as memory channels. Scan edges are programmed into scan edges, 1A/1B to 9A/9B, in memory channels.

- ① Set the edge frequency of the desired frequency range in VFO mode:
 - ➔ Set the frequency using the desired band's [DIAL].
 - ➔ Set other data (e.g. repeater settings, etc.) if desired.
- ② Push the same band's [M/CALL•MW] for 1 sec.
- ③ Rotate the [DIAL] to select one of scan edge channel, 1A to 9A.

- ④ Push the [M/CALL•MW] for 1 sec. to program.
 - 3 beeps sound and VFO is automatically selected.
 - Scan edge 1B to 9B is automatically selected when continuing to push the [M/CALL•MW] after programming.
- ⑤ To program a frequency for the other pair of scan edges, 1B to 9B, repeat steps ① and ④.
 - If the same frequency is programmed into a pair of scan edges, programmed scan will not function.

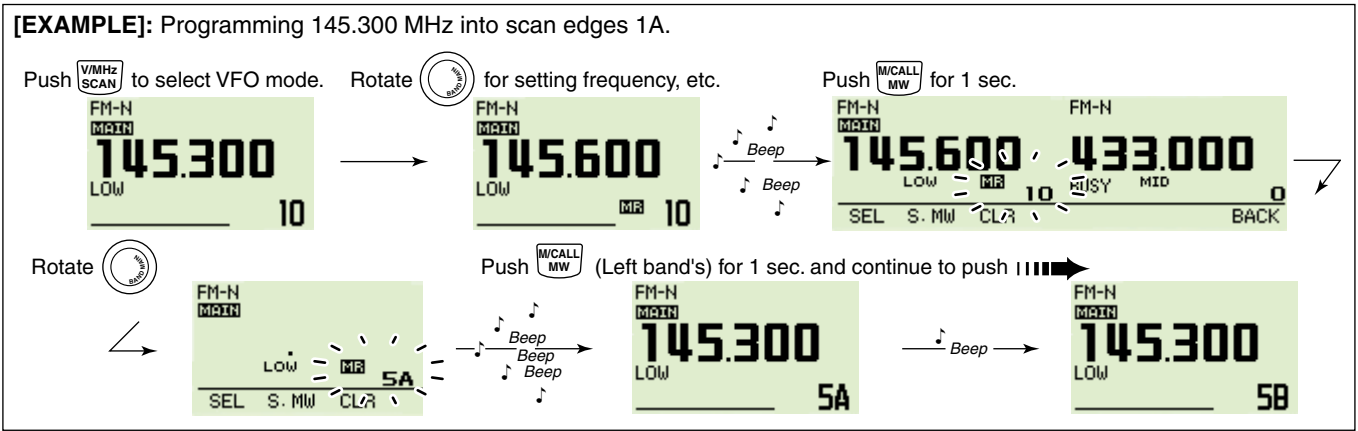

7 SCAN OPERATION

◇ Programming scan edges via microphone



- 1 Set the desired frequency in VFO mode.
 - ➔ Push [VFO/LOCK] to select VFO mode.
 - ➔ Set the frequency via the keypad or [▲]/[▼].
- 2 Push [FUNC] then [CLR A(MW)] momentarily.
- 3 Push [▲] or [▼] to select scan edge channels, 1A to 9A.
- 4 Push [FUNC], then push [CLR A(MW)] for 1 sec. to program.
 - 3 beeps sound and VFO is automatically selected.
 - Memory channel number advances to the next scan edge channel, 1B to 9B when continuing to push [CLR A(MW)] after programming.
- 5 To program a frequency for the other scan edge channels, repeat steps 1 to 4.

[EXAMPLE]: Programming 145.800 MHz into scan edge 1b.

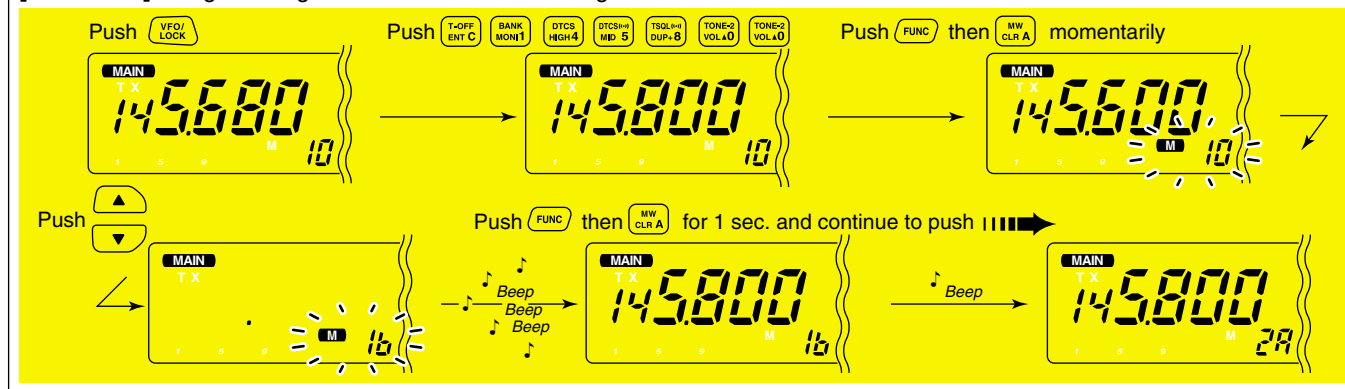

■ Skip channel setting

The memory skip function speeds up scanning by checking only those memory channels not set as skip channels. Set skip channels as follows.

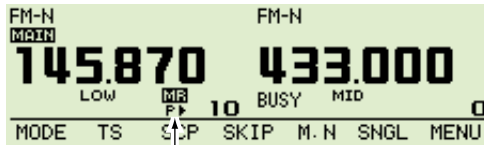

Skip appears

- ① Select a memory channel in the desired MAIN band:
 - Push the desired MAIN band's **[M/CALL•MW]** to select memory mode.
 - Rotate the same band's **[DIAL]** to select the desired channel to be a skip channel.
- ② Push **[F•T-O]** to display the function guide.
- ③ Push **[TONE•DTMF]** to select the skip condition from “▶,” “P▶” or “OFF” for the selected channel.
 - “▶”(SKIP) : The channel is skipped during memory or bank scan.
 - “P▶”(PSKIP) : The channel is skipped during memory/bank scan and the programmed scan.
 - “_”(OFF) : The channel is scanned during any scan.
- ④ Push **[F•T-O]** to exit the function guide.



- ① Select a memory channel.
 - Select memory mode by pushing **[MR/CALL]**.
 - Push **[▲]** or **[▼]** to select the desired channel to be a skip channel.
 - Direct memory channel selection is also available.
- ② Push **[SET B(D-OFF)]** to enter set mode.
- ③ Push **[SET B(D-OFF)]** or **[ENT C(T-OFF)]** several times until “CHS” appears as shown at left.
- ④ Push **[▲]** or **[▼]** to set or cancel the skip setting.
 - See item ④ at left for skip indicator details.
- ⑤ Push **[CLR A(MW)]** to exit set mode.

■ Scan resume condition

The scan resume condition can be selected as timer or pause scan. The selected resume condition is also used for priority watch. (p. ??)

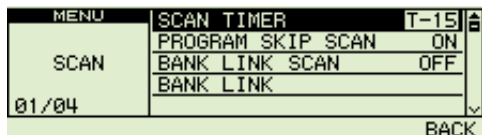

The display shows that the scan will resume 15 sec. after it stops.

- ① Push **[MAIN•BAND]** to select the desired band (left or right) as the main band.
- ② Push **[F•T-O]** to display the function guide.
- ③ Push **[V/MHz•SCAN]** (Right band's) to enter MENU screen.
- ③ Rotate the **[DIAL]** to select the "SCAN" mode, then push **[MAIN•BAND]**.
- ④ Rotate the **[DIAL]** to select the "SCAN TIMER", then push **[MAIN•BAND]**.
- ④ Rotate the **[DIAL]** to set the desired timer:
 - "T-5" : Scan pauses 5 sec. while receiving a signal.
 - "T-10" : Scan pauses 10 sec. while receiving a signal.
 - "T-15" : Scan pauses 15 sec. while receiving a signal.
 - "P-2" : Scan pauses until the signal disappears and then resumes 2 sec. later.
- ⑤ Push **[F•T-O]** to exit MENU mode.



- ① Push **[BAND]** to select the desired band (left or right) as the main band.
- ② Push **[SET B(D-OFF)]** to enter set mode.
- ③ Push **[SET B(D-OFF)]** or **[ENT C(T-OFF)]** several times until "Sct" or "SCP" appears as shown at left.
- ④ Push **[▲]** or **[▼]** to select the scan resume condition.
 - See item ④ at left for scan resume condition details.
- ⑤ Push **[CLR A(MW)]** to exit set mode.

■ Priority watch types

Priority watch checks for signals on a VFO frequency every 5 sec. while operating in memory mode. The transceiver has 3 priority watch types to suit your needs. You can also transmit on the VFO frequency while the priority watch operates.

The watch resumes according to the selected scan resume condition. See previous page for details.

NOTES:

- ▶ If the pocket beep function is activated, the transceiver automatically selects the tone squelch function when priority watch starts.

MEMORY CHANNEL WATCH

While operating on a VFO frequency, priority watch checks for a signal on the selected memory channel every 5 sec.

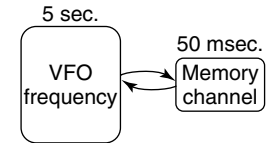

MEMORY SCAN WATCH

While operating on a VFO frequency, priority watch checks for signals on each memory channel in sequence.

- The memory skip function is useful to speed up the scan.

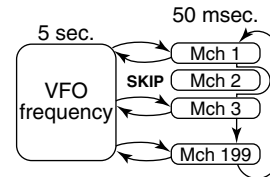

CALL CHANNEL WATCH

While operating on a VFO frequency, priority watch checks for signals on the call channel every 5 sec.

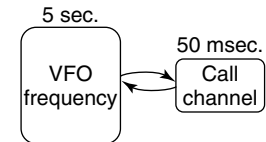

Priority watch operation

① Select VFO mode; then, set an operating frequency in the desired MAIN band (left or right).

② Set the watching channel(s).

For memory channel watch:

Select the desired memory channel.

For memory scan watch:

Select memory mode; then, push the same band's [V/MHz•SCAN] for 1 sec. to start memory scan.

For call channel watch:

Select the desired call channel by pushing the same band's [M/CALL•MW] once or twice, then rotate the [DIAL].

③ Push and hold [LOW•PRIO] for 1 sec. to start the watch.

- The transceiver checks the memory or call channel every 5 sec.
- The watch resumes according to the selected scan resume condition. (p. ??)

④ Push and hold [LOW•PRIO] for 1 sec. to stop the watch.



① Select VFO mode; then, set the desired frequency.

② Set the watching channel(s).

For memory channel watch:

Push [MR/CALL] then [▲] or [▼] to select the desired memory channel.

For memory scan watch:

Push [MR/CALL], then push [SCAN 2] to start the memory scan.

For call channel watch:

Push [MR/CALL] for 1 sec. then push [▲] or [▼] to select the call channel.

③ Push [PRIO 3(PTT-M)] to start the watch.

- The transceiver checks the memory or call channel every 5 sec.
- The watch resumes according to the selected scan resume condition. (p. 45)
- To resume the watch manually when paused, push [PRIO 3(PTT-M)] or [CLR A(MW)].

④ To stop the watch, push [CLR A(MW)] once (or twice while watch is paused).

■ Programming a DTMF code

DTMF tones are used for autopatching, controlling other equipment, etc. The transceiver has 16 DTMF memory channels (d0–d#) for storage of often-used DTMF codes of up to 24 digits.

- ① Push **[TONE•DTMF]** for 1 sec..
 - Select the main band in advance, by pushing the desired band's **[MAIN•BAND]**, if necessary.
- ② Rotate **[DIAL]** to select the “AUTO TX”, then push **[MAIN•BAND]**.
- ③ Rotate the **[DIAL]** to select the ON, then push **[MAIN•BAND]**.
 - “☎” appears in place of the main band's display.

- ④ Rotate the **[DIAL]** to select the “DTMF memory”.
- ⑤ Push **[MAIN•BAND]** to enter the DTMF memory programming condition.
 - Rotate **[DIAL]** to select the desired DTMF channel.
- ⑥ Push **[V/MHz•SCAN]** (left band).
- ⑦ Rotate the **[DIAL]** to select the desired code.
- ⑧ Push **[M/CALL•MW]** (left band) to select the next digit.
 - Pushing **[V/MHz•SCAN]** (left band) move the cursor backward.
- ⑨ Repeat the steps ⑤ and ⑥ to set the desired DTMF tone sequence.
- ⑩ Push **[V/MHz•SCAN]** (Right band's) twice to exit DTMF memory programming condition.

[EXAMPLE]: Programming “5428AB453” into DTMF memory channel “d4.”

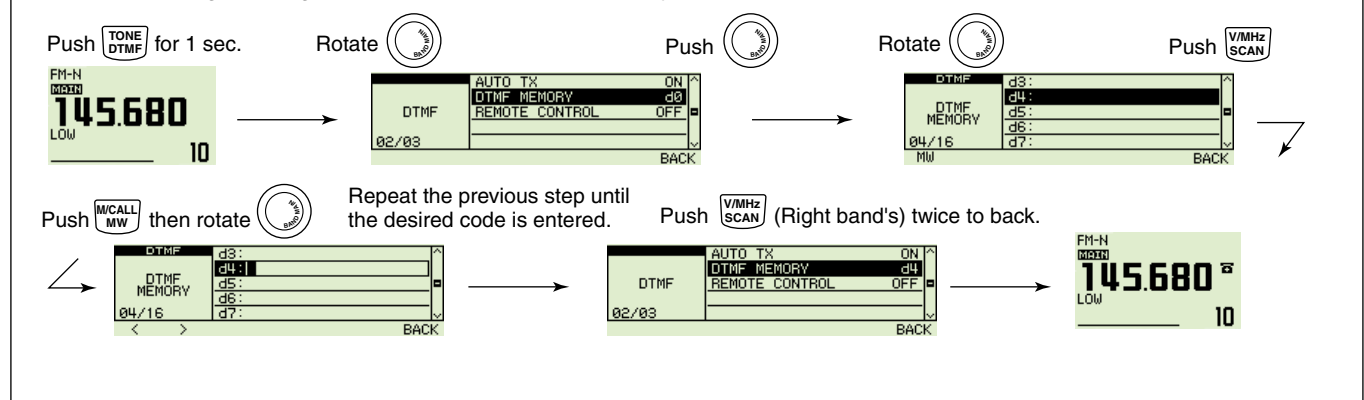

9 DTMF MEMORY ENCODER

◇ Programming a DTMF code— via microphone



- 1 Push [FUNC] then [Low 6(DTMF)] to turn the DTMF encoder ON.
 - “d” appears in place of the main band’s 100 MHz digit.
- 2 Push [SET B(D-OFF)] to enter the DTMF memory programming condition.
- 3 Push [▲] or [▼] to select the desired DTMF memory channel.
- 4 Push the desired digit keys.
 - When the first digit is input, previous memory contents are cleared automatically.
 - “E” stands for “*” and “F” stands for “#.”
 - Push [▲]/[▼] and repeat this step if you make a mistake.
 - The S/R/F indicator shows the digit group. The indication increases every 6 digits.

- 5 Push [VFO/LOCK] to exit the programming condition.
 - The [CLR A(MW)] key cannot be used to exit. If pushed, code “A” is input. Reprogram in such a case.

[EXAMPLE]: Programming “5428A6” into DTMF memory channel “d4.”

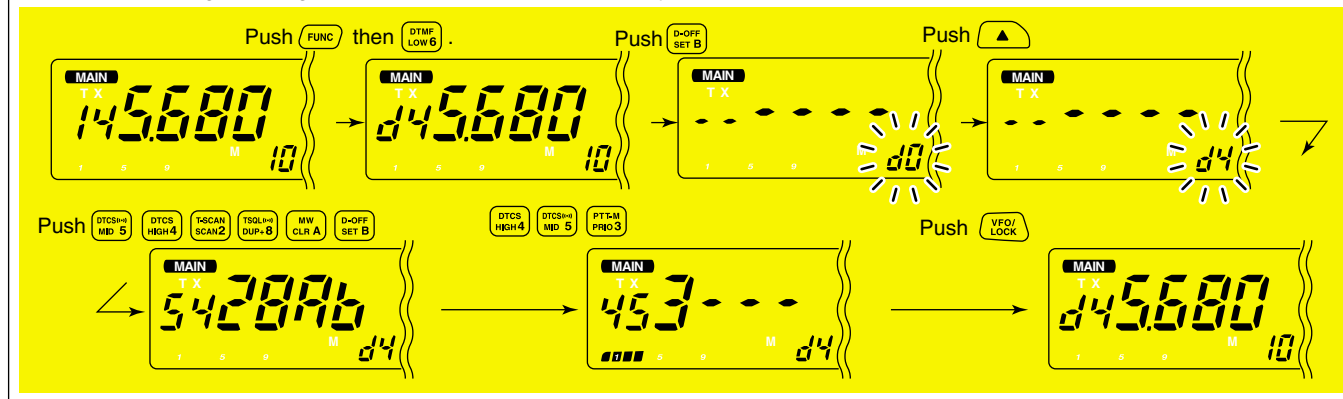

■ Transmitting a DTMF code

◇ Automatic transmission (DTMF memory)

- ① Push and hold [TONE•DTMF] for 1 sec. to turn the “AUTO TX” ON.
 - “d” appears in place of the main band’s display.
- ② Rotate [DIAL] to select the “DTMF MEMORY,” then push [MAIN•BAND] to enter DTMF memory programming condition.
- ③ Rotate [DIAL] to select the desired DTMF memory channel then push [MAIN•BAND].
- ④ Push [V/MHz•SCAN] (Right band’s) to return VFO mode.
- ⑤ Push [PTT] to transmit the selected DTMF memory content.
- ⑥ Push and hold [TONE•DTMF] for 1 sec. , then turn the “AUTO TX” OFF to cancel the DTMF encoder.
 - When the DTMF encoder is turned ON continuously, each push of the PTT transmits the previously selected DTMF code.



- ① Push [FUNC] then [LOW 6(DTMF)] to turn the DTMF memory encoder ON.
 - “d” appears in place of the main band’s 100 MHz digit.
- ② Push [SET B(D-OFF)] to enter the DTMF memory programming condition.
- ③ Push [▲] or [▼] to select the desired channel.
- ④ Push [PTT] to transmit the selected memory.
 - Exit the programming condition automatically.
 - Each push of [PTT] transmits the DTMF code.
- ⑤ Push [FUNC] then [SET B(D-OFF)] to cancel the DTMF memory encoder.
 - When the DTMF encoder is turned ON continuously, each push of the PTT transmits the previously selected DTMF code.

◇ Transmitting a DTMF memory directly



- ① Push [FUNC] then [LOW 6(DTMF)] to turn the DTMF memory encoder ON.
 - “d” appears in place of the main band’s 100 MHz digit.
 - ② Push [DTMF-S] to turn the DTMF memory direct selection ON.
 - The function indicator (microphone) lights green.
 - ③ Push the desired DTMF channel.
 - “0” to “9” and “A” to “D” are available for DTMF memory channels.
 - The selected DTMF code is automatically transmitted without pushing PTT.
- NOTE:** When no DTMF code programmed channel number is pushed, it transmits the relative DTMF code as the manual transmission described in the next page.
- ④ Push [DTMF-S] again to deactivate the DTMF memory direct selection.
 - ⑤ Push [FUNC] then [SET B(D-OFF)] to cancel the DTMF memory encoder.

◇ Manual transmission



- ① Deactivate the DTMF memory encoder by pushing [FUNC] then [SET B(D-OFF)].
- ② Push [DTMF-S] to turn the DTMF direct selection ON.
 - The function indicator (microphone) lights green.
- ③ Push one of “0” to “9” and “A” to “F” keys momentarily, then push the desired DTMF keys, 0–9 and A to F.
 - A: [CLR A(MW)] B: [SET B(D-OFF)],
 - C: [ENT C(T-OFF)] D: [SQL▲ D(MUTE)],
 - E: [* (TONE-1)] F: [SQL▼ # (16KEY-L)]
 - Automatically transmits without pushing PTT.
 - The first code, one of “A” to “F,” is not transmitted. DTMF code transmission starts from the 2nd code.
- ④ Push [DTMF-S] again to deactivate the DTMF direct selection.

■ DTMF speed

The rate at which DTMF memories send individual DTMF characters can be set to accommodate operating needs.

- ① Push [] to display the function guide.
- ② Push [V/MHz•SCAN] (Right band's) to enter MENU screen.
- ③ Rotate [DIAL] to select “DUP/TONE,” then push [MAIN BAND].
- ④ Rotate [DIAL] to select “DTMF SPEED,” then push [MAIN BAND].
- ⑤ Rotate the main band's [DIAL] to select the desired speed as shown in the table below, then push [MAIN BAND].
- ⑥ Push [] to exit MENU screen.
cps=characters/sec

DISPLAY	INTERVAL	SPEED
100	100 msec.	5.0 cps
200	200 msec.	2.5 cps
300	300 msec.	1.6 cps
500	500 msec.	1.0 cps

■ Tone frequency and DTCS code

◇ Subaudible (repeater) tone

Some repeaters require subaudible tones to be accessed. Subaudible tones are superimposed over your normal signal and must be set in advance. (P ??)

◇ Tone, DTCS, Digital code and Digital call sign squelches

The tone squelch (CTCSS), DTCS squelch, digital code squelch or digital call sign squelch opens only when receiving a signal containing a matching subaudible tone, DTCS code, Digital code or Digital call sign squelch respectively. You can silently wait for calls from group members using the same tone or code. Separate tone frequencies can be set for repeater and tone squelch/pocket beep operation.

◇ Pocket beep

These functions use subaudible tones or DTCS codes for calling and can be used as a “common pager” to inform you that someone has called while you were away from the transceiver.

10 DTMF MEMORY ENCODER

◇ Setting tone squelch

- ① Push [**F**•••○] to display the function guide.
- ② Push [**V/MHz•SCAN**] (Right band's) to enter MENU screen, then rotate main band's [**DIAL**] to select "DUP/TONE" set mode.
- ③ Push [**MAIN•BAND**], then rotate [**DIAL**] to select "CTCSS TONE."
- ④ Push [**MAIN•BAND**], then rotate [**DIAL**] to select the desired CTCSS tone frequency.
 - Each operating band and each memory channel have independent settings.
 - See page ?? for available tone frequencies table.
- ⑤ Push [**V/MHz•SCAN**] (Right band's) to return to "DUP/TONE" set mode, or push [**F**•••○] to return to frequency indication.

MENU	OFFSET FREQ	0.60000	▲
DUP/TONE	REPEATER TONE	88.5	
	CTCSS TONE	88.5	
	DTCS CODE	023	■
	DTCS POLARITY	BOTH N	▼
03/09			BACK

Tone squelch frequency setting

◇ Setting DTCS code for DTCS squelch or beep

- ① Push [**F**•••○] to display the function guide.
- ② Push [**V/MHz•SCAN**] (Right band's) to enter MENU screen, then rotate main band's [**DIAL**] to select "DUP/TONE" set mode.
- ③ Push [**MAIN•BAND**], then rotate [**DIAL**] to select "DTCS CODE."
- ④ Push [**MAIN•BAND**], then rotate [**DIAL**] to select the desired DTCS code.
 - Each operating band and each memory channel have independent settings.
 - See page ?? for available DTCS code table.
- ⑤ Push [**V/MHz•SCAN**] (Right band's) to return to "DUP/TONE" set mode, or push [**F**•••○] to return to frequency indication.

MENU	OFFSET FREQ	0.60000	▲
DUP/TONE	REPEATER TONE	88.5	
	CTCSS TONE	88.5	
	DTCS CODE	023	■
	DTCS POLARITY	BOTH N	▼
04/09			BACK

DTCS code setting

/// DTCS mode can be selected in "DTCS POLARITY" menu.
/// (p. ??)

The optional UT-123

■ Digital code and digital call sign setting

◇ Setting digital code for digital code squelch or beep

- ① Push [**F**•**---**•**0**] to display the function guide, push the left band's [**V/MHz**•**SCAN**] (Right band's) several times to select DV mode.
- ② Push [**V/MHz**•**SCAN**] to enter MENU screen, then rotate main band's [**DIAL**] to select "DV SET MODE."
- ③ Push [**MAIN**•**BAND**], then rotate [**DIAL**] to select "DIGITAL CODE."
- ④ Push [**MAIN**•**BAND**], then rotate [**DIAL**] to select the desired digital code. (0-99)
 - Each operating band and each memory channel have independent settings.

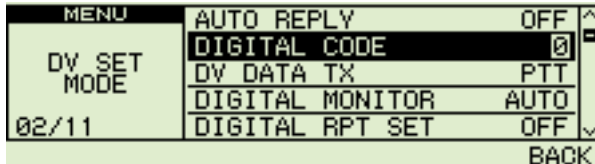

Digital code setting

- ⑤ Push [**V/MHz**•**SCAN**] (Right band's) to return to "DUP/TONE" set mode, or push [**F**•**---**•**0**] to return to frequency indication.

◇ Setting the YOUR and MY call signs for digital call sign squelch or beep

See page ?? for DV MODE OPERATION.

CAUTION! Use digital code squelch when operating with more than 3 stations. Because the digital call sign squelch function recognizes "MY CALL SIGN," the digital call sign squelch function can be used when operating with only one station.

NOTE:

- The tone/DTCS code squelch opens sometimes when other stations communicate with adjacent tone frequency or DTCS code.

■ Tone/DTCS squelch operation

The tone or DTCS squelch opens only when receiving a signal with the same pre-programmed subaudible tone or DTCS code, respectively.

- ① Set the operating frequency in the main band.
- ② Program the CTCSS tone frequency or DTCS code in “DUP/TONE” set mode.
 - See p. ?? for programming details.
- ③ Push **[TONE•DTMF]** several times until “T SQL” or “DTCS” appears in the main band’s display.
- ④ When a signal with the matched tone is received, the squelch opens and the signal can be heard.
 - When the received signal includes an unmatched tone, the squelch does not open. However, the S/RF indicator shows the received signal strength.
 - To open the squelch manually, push and hold **[DUP•MONI]**.
- ⑤ Operate the transceiver in the normal way (push [PTT] to transmit; release [PTT] to receive).
- ⑥ To cancel the tone squelch, push **[TONE•DTMF]** several times until “T SQL” or “DTCS” disappears.



- ① Set the operating frequency.
- ② Program the CTCSS tone frequency or DTCS code in set mode.
 - See p. 53 for programming details.
- ③ Push [FUNC] then [SIMP 9(TSQL)] or [HIGH 4(DTCS)] to turn the tone squelch or DTCS squelch ON.
- ④ When a signal with the matched tone is received, the squelch opens and the signal can be heard.
 - When the received signal includes an unmatched tone, the squelch does not open. However, the S/RF indicator shows the received signal strength.
 - To open the squelch manually, push [MONI 1(BANK)].
- ⑤ Operate the transceiver in the normal way (push [PTT] to transmit; release [PTT] to receive).
- ⑥ To cancel the tone squelch, push [FUNC] then [ENT C(T-OFF)].
 - “T SQL” or “DTCS” disappears

NOTE: The DTCS squelch operation on sub band will not be performed during DTCS transmission, due to the same encoder/decoder circuit is used for both main and sub bands. And the tone squelch operation on sub band may not be performed correctly during DTCS transmission.

■ Digital code/digital call sign squelch

The optional UT-123

- ① Set the desired operating frequency on DV mode, Digital code and MY CALL SIGN.
- ② Push **[TONE•DTMF]** several times to activate the digital code or digital call sign squelch. (DSQL or CSQL)
 - Digital call sign squelch “DSQL,” Digital call sign beep “DSQL”
”, Digital code squelch “CSQL,” Digital code beep “CSQL.”” and no tone operation are activated in order.
- ③ Operate the transceiver in the normal way.
- ④ When the received signal includes a matching call sign/code, the squelch opens and the signal can be heard.
 - When the received signal’s call sign/code does not match, digital call sign/digital code squelch does not open, however, the MUTE indicator shows signal strength.

Digital call sign pocket beep



Digital code pocket beep



Digital call sign squelch



Digital code squelch



■ Pocket beep operation

- ① Set the desired operating frequency and the desired operating mode.
- ② Set the desired CTCSS tone, DTCS code, Digital call sign or Digital code.
- ③ Push **[TONE•DTMF]** several times to select “T SQL” or “DTCS” appears.
 - When DV mode operation, push **[TONE•DTMF]** several times to select “DSQL” or “CSQL” appears.
- ④ When a signal with the correct tone, code, digital call sign or digital code is received, the transceiver emits beep tones for 30 sec. and blinks “.”
- ⑤ Push **[PTT]** to answer or push **[MAIN•BAND]** to stop the beeps and blinking.

Pocket beep

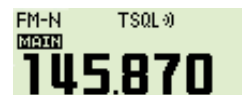

DTCS beep



Digital call sign pocket beep



Digital code pocket beep

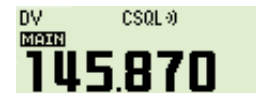

10 DTMF MEMORY ENCODER



- 1 Set the operating frequency.
- 2 Program the CTCSS tone frequency or DTCS code in set mode.
 - ➔ Push [SET B(D-OFF)] to enter set mode.
 - ➔ Push [SET B(D-OFF)] or [ENT C(T-OFF)] several times until "Ct" for tone squelch or "dt" for DTCS squelch appears.
 - "T SQL" blinks when tone squelch ("Ct"), or "DTCS" blinks when DTCS squelch ("dt") is selected.
 - ➔ Push [▲]/[▼] to select the desired tone frequency or DTCS code.
 - ➔ Push [SET B(D-OFF)] to select "dtP" then push [▲]/[▼] to select the DTCS polarity.
 - ➔ Push [CLR A(MW)] to exit set mode.
- 3 Push [FUNC] then push [DUP+ 8(TSQL ((.)))] or [MID 5(DTCS ((.)))] to turn ON the pocket beep with tone squelch or DTCS squelch, respectively.
- 4 When a signal with the matched tone is received, the transceiver emits beep tones for 30 sec. and blinks "((.))."
- 5 Push [PTT] to answer or push [CLR A(MW)] to stop the beeps and blinking.
 - "((.))" disappears and cancels the pocket beep function automatically.
- 6 To cancel the tone squelch or DTCS squelch function, push [FUNC] then [ENT C(T-OFF)].
 - "T SQL" or "DTCS" disappears

■ DTCS polarity setting

- 1 Push [F•---○] to display the function guide.
- 2 Push [V/MHz•SCAN] (Right band's) to enter MENU screen, then rotate main band's [DIAL] to select "DUP/TONE" set mode.
- 3 Push [MAIN•BAND], then rotate [DIAL] to select "DTCS POLARITY."
- 4 Push [MAIN•BAND], rotate [DIAL] to select the desired DTCS polarity mode.
 - BOTH N: Normal phase is used for both TX and RX. (Default)
 - TN-RR : Normal phase is used for TX; Reverse phase for RX.
 - TR-RN : Reverse phase is used for TX; Normal phase for RX.
 - BOTH R: Reverse phase is used for both TX and RX.

MENU	OFFSET FREQ	0.60000	▲
	REPEATER TONE	88.5	
DUP/TONE	CTCSS TONE	88.5	
	DTCS CODE	023	■
05/09	DTCS POLARITY	BOTH N	▼
		BACK	

DTCS polarity setting

- 5 Push [V/MHz•SCAN] (Right band's) to return to "DUP/TONE" set mode, or push [F•---○] to return to frequency indication.

■ Tone scan

By monitoring a signal that is being operated with pocket beep, tone or DTCS squelch function, you can determine the tone frequency or DTCS code necessary to open a squelch.

- ① Set the desired operating frequency or memory channel to be checked for a tone frequency or code in the main band.
- ② Push **[TONE•DTMF]** several times to select the tone type, tone squelch or DTCS, to be scanned.
 - Either “T SQL” or “DTCS” appears
- ③ Push the main band's **[V/MHz•SCAN]** for 1 sec. to start the tone scan.
 - To change the scanning direction, rotate **[DIAL]**.

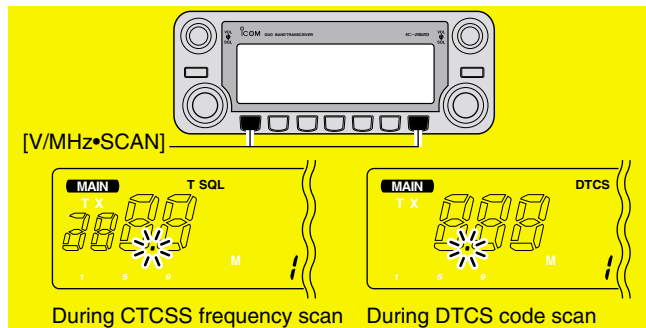

NOTE: The decoded tone frequency is programmed temporarily when a memory or call channel is selected. However, this will be cleared when the memory/call channel is re-selected.

- ④ When the CTCSS tone frequency or 3-digit DTCS code is matched, the squelch opens and the tone frequency is temporarily programmed into the selected condition such as memory or call channel.
 - The tone scan pauses when a CTCSS tone frequency or 3-digit DTCS code is detected.
 - The decoded CTCSS tone frequency or 3-digit DTCS code is used for the tone encoder or tone encoder/decoder depending on the selected tone condition or type in step ②.
 - “T SQL” : CTCSS tone encoder/decoder
 - “DTCS” : DTCS tone encoder/decoder
- ⑤ Push **[V/MHz•SCAN]** to stop the scan.



- ① Set the frequency or memory channel to be checked for a tone frequency.
- ② Selects the tone type to be scanned.
 - Push **[FUNC]** then push; **[SIMP 9(TSQL)]** for tone squelch; **[HIGH 4(DTCS)]** for DTCS squelch.
- ③ Push **[FUNC]** then **[SCAN 2(T-SCAN)]** to start the tone scan.
- ④ When the tone frequency is matched, the squelch opens and the tone frequency is programmed into the selected mode such as memory or call channel.
- ⑤ Push **[CLR A(MW)]** to stop the scan.

11 PAGER/CODE SQUELCH

■ Pager function

This function uses DTMF codes for paging and can be used as a “message pager” to confirm you of a caller’s identification even when you leave the transceiver temporarily unattended.

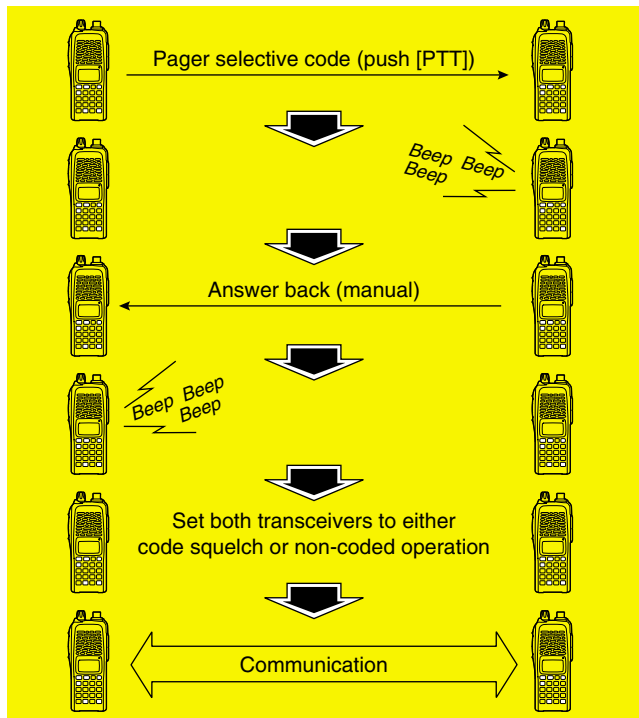

■ Code programming

◇ Before programming

The pager and code squelch functions require ID codes and a group code. These codes are 3-digit DTMF codes and must be written into the code channels before operation.

- ① Decide the ID code of each transceiver and a group code for your group.
- ② Decide whether you want to return to normal operation or code squelch operation after a connection is made.
- ③ Program the ID code, group code and transmit codes (other station’s codes) as below.

◇ Code channel assignment

ID OR GROUP CODE	CODE CHANNEL NUMBER	“RECEIVE ACCEPT” OR “RECEIVE INHIBIT”
Your ID code	0	“Receive accept” only
Other parties’ ID code	1–6	“Receive inhibit” should be programmed in each channel.
Group code	One of 1–6	“Receive accept” must be programmed in one channel.
Memory space*	P	“Receive inhibit” only.

*Channel CP automatically memorizes an ID code when receiving a pager call. The contents in channel CP cannot be changed manually.

◆ Code programming

Your ID code **MUST** be programmed into code channel C0. Up to 6 transmit codes (codes that you transmit) are programmable into code channels, C1 to C5, if required.

- ① Push **[F•---]** to display the function guide.
- ② Push **[V/MHz•SCAN]** (Right band's) to enter MENU screen.
 - Rotate **[DIAL]** to select “DUP/TONE”, then push the main band's **[MAIN•BAND]**.
- ③ Rotate **[DIAL]** to select “PGR CODE”, then push the **[MAIN•BAND]**.
- ④ Rotate **[DIAL]** to select code channel C0.
 - “C0” is your ID code and “C1” to “C5” are transmit codes.
 - Each transceiver should have a different ID code.
- ⑤ Push the **[MAIN•BAND]**, then rotate **[DIAL]** to select the desired 3-digit ID code (default: 000) via the keypad.
 - Push **[M/CALL•MW]** (Left band's) to move the cursor right; push **[V/MHz•SCAN]** (Left band's) to move the cursor left.

- ⑥ Rotate **[DIAL]** to select a transmit code channel from C1 to C5, then push the **[MAIN•BAND]**.
- ⑦ Enter the desired 3-digit transmit code via the keypad.
 - Push **[M/CALL•MW]** (Left band's) to move the cursor right; push **[V/MHz•SCAN]** (Left band's) to move the cursor left.
- ⑧ Push **[V/MHz•SCAN]** (Left band) to set the channel to “receive inhibit” or “receive accept” ON and OFF.
 - When “receive inhibit” is set, “SKIP” appears.
 - Code channel C0 cannot be set as “receive inhibit.”
 - See the table for “receive accept” and “receive inhibit” details (p. SKIP channel).

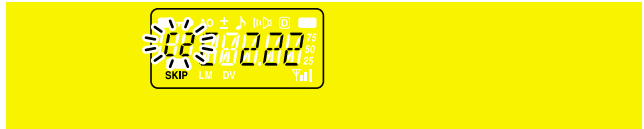

- ⑨ Repeat steps ⑥ and ⑧ to set additional transmit code channels, if desired.
- ⑩ Push **[F•---]** to exit MENU screen.

- **Receive accept/receive inhibit**
 - “Receive accept” (“SKIP” indicator does not appear) accepts pager calls when the transceiver receives a signal with a code the same as that in the code channel.
 - “Receive inhibit” (“SKIP” indicator appears) ignores calls even when the transceiver receives a code the same as that in the code channel. Transmit codes should therefore be programmed for “receive inhibit,” otherwise the transceiver will not reject unnecessary calls.

■ Pager operation

◇ Calling a specific station

- ① Program the pager code channel in advance (p. 39).
- ② Set the operating frequency.
 - Set the volume and squelch to the desired level as in normal operation.
- ① Push [**F**•**---**•**0**] to display the function guide, then enter the MENU screen.
- ③ Push [**MAIN**•**BAND**] to select “DUP/TONE”, then select the “PGR/C-SQL”.
- ③ Rotate [**DIAL**] to set the “PGR”, then push [**MAIN**•**BAND**].
 - “PGR” indicator appear in normal frequency mode.

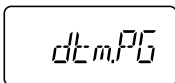

- ④ Select the desired 3-digit transmit code channel:
 - ➔ Enter “PGR CODE” (the pager code selection mode) in “DUP/TONE” set mode.
 - ➔ Rotate [**DIAL**] to select the desired pager code channel.
 - ➔ Push [**F**•**---**•**0**] to return to previous mode.
- ⑤ Push [**PTT**] to transmit the pager code.
- ⑥ Wait for an answer back.
 - When the transceiver receives an answer back code, the function display shows the other member’s ID or group code.

- ⑦ After confirming a connection, push [**MAIN**•**BAND**] to enter the “PGR/C-SQL” set mode, then rotate [**DIAL**] to select the code squelch operation “C-SQL,” or non-selective calling system “OFF.”
 - DO NOT push any digit keys while code channels C0 to C5 are displayed, otherwise code channel contents will be changed.
- ⑧ Communicate with the other party as normal: push [**PTT**] to transmit; release to receive.

◇ Waiting for a call from a specific station

- ① Set the operating frequency.
- ② Enter “PGR/C-SQL” set item in “DUP/TONE” set mode.
 - ➔ Rotate [**DIAL**] to select “PGR” if “C-SQL” or “OFF” appears.
 - ➔ Push [**F**•**---**•**0**] to return to previous mode.
 - “PGR” indication appear.
- ③ Wait for a call.
 - When receiving a call, the caller’s ID or group code appears as shown at next page.
 - DO NOT push any digit keys while code channels C0 to C5 are displayed, otherwise code channel contents will be changed.
- ④ Push [**PTT**] to send an answer back call and display the operating frequency.
- ⑤ After confirming a connection, enter “PGR/C-SQL” set item, then rotate [**DIAL**] to select the code squelch operation “C-SQL,” or non-selective calling system “OFF.”

• **PERSONAL CALLS**

This display appears when you are called with your ID code and the calling station's ID code is 123.

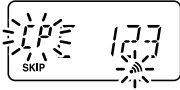

"CP" and "123" blink.

• **GROUP CALLS**

This display appears when you are called with the group code, 888, and 888 has been programmed into code channel C5.

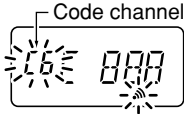

• **ERROR INFORMATION**

When the transceiver receives an incomplete code, "E" and previously received code appear.

Previously received code.

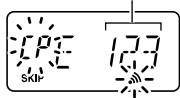

During channel number indication (described on page 16)

To use these functions in channel number indication, the pager/code squelch setting must be programmed with other memory contents before selecting channel number indication.

■ Code squelch

When using code squelch you will only receive calls from stations which know your ID or group code. A 3-digit code is sent each time [PTT] is pushed in order to open the receiving station's code squelch prior to voice transmission.

- ① Set the operating frequency.
 - Set the volume and squelch to the desired level as in normal operation.
- ② Push [F•TONE] to display the function guide.
- ② Enter "PGR/C-SQL" set item in "DUP/TONE" set mode, then push [MAIN•BAND].
 - Rotate [DIAL] to select "C-SQL," if "PGR" or "OFF" appears.
- ② Enter "PGR CODE" set item in "DUP/TONE" set mode, then push [MAIN•BAND].
- ③ Select the desired transmit code channel:
 - Rotate [DIAL] to select the desired code channel.
 - Push [F•TONE] to return to previous mode.
 - "C-SQL." indication apper.

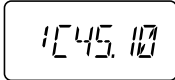

- ④ Operate the transceiver in the normal way (push [PTT] to transmit; release [PTT] to receive).
- ⑤ To cancel the code squelch, Enter "PGR/C-SQL" set item, then rotate [DIAL] to select "OFF"
 - 100 MHz digit shows "1" when the function is cancelled.

12 EXTERNAL DTMF REMOTE

External DTMF remote function can be remotely controlled using DTMF signals on the sub band. To operate external DTMF remote, a 144MHz or 430(440) MHz transceiver with a DTMF encoder is required.

- ① Set the sub band frequency to receive a control signal (DTMF code).
 - The optional tone squelch function can be used for the sub band to increase remote control reliability.(p. Tone squelch)
- ② Enter “DUP/TONE” into MENU screen.
- ③ Program a 3-digit password into “PGR CODE” the sub band’s code channel 5, if desired.(p. ??)
 - The initial value of code channel 5 is “000 (default); receive accept.” If you do not require the password, set the channel as “receive inhibit.”
- ④ Select the main band by pushing a tuning dial, then set the desired frequency for operation.
- ⑤ Push and hold **[TONE•DTMF]**, then rotate **[DIAL]** to select “REMOTE CONTROL” turn ON appears to select standby for the remote control.
- ⑥ Push **[MAIN•BAND]**, then rotate **[DIAL]** to select ON
 - “” indicator appear
- ⑦ Set the operating frequency of the controller transceiver equal to the sub band frequency of the IC-2820H.
 - Make sure a tone frequency is set when using the optional tone squelch function with the IC-2820H.
 - The external DTMF remote does not accept a control signal on the main band frequency.

- ⑧ From the controller transceiver, transmit the DTMF code as follows:

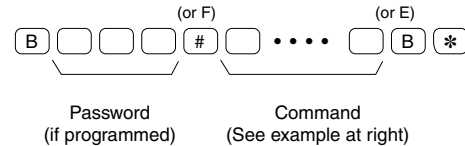

- ⑨ To cancel standby for the remote control, push and hold **[TONE•DTMF]**.
 - “” disappears.
 - Pushing **[FUNC]** then **[SET B(D-OFF)]** also cancels standby for the remote control.

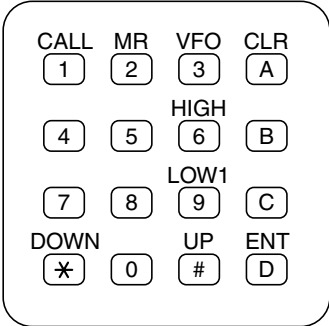

DTMF KEYPAD

[EXAMPLE]

144.750 MHz (3) (D) (1) (4) (4) (7) (5)
 VFO [ENT] 100 10 1 MHz 100 10
 mode MHz MHz kHz kHz

Memory channel 15 (2) (D) (1) (5)
 VFO [ENT] 2 digits
 mode

Scratch pad (1) (*) (*)
 memory 2 Call [DOWN] [DOWN]
 channel

- /// Note for the [ENT] key
- When the entered frequency is outside of the frequency coverage, the input digits will be cleared.
 - To adjust the frequency less than 10 kHz or to select a scan edge memory channel (1A, 1B), use the [UP] or [DOWN] key.

[EXAMPLE]: Setting the operating frequency to 145.8125 MHz (when the VHF tuning step is 12.5 kHz).

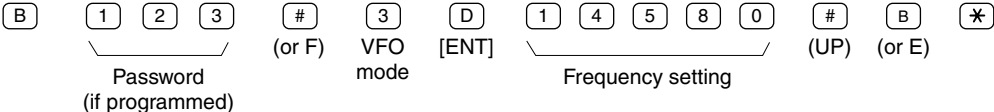

Although [DIAL] and [↵](5) are used for description in this section, [▲](2)/[▼](8) and [▶](6) are available instead of [DIAL] and [↵](5).

■ Digital mode operation

The IC-91A*/91AD can be operated in digital voice mode and low-speed data operation for both transmit and receive. It can also be connected to a GPS receiver (compatible with an RS-232 output/NMEA format/4800 bps) and transmit/receive position data.

*The optional UT-121 is required for the IC-91A.

■ Call sign programming

Four types of call sign memories are available; your own call sign “MY CALL SIGN,” other station call sign “YOUR CALL SIGN,” repeater call sign “RPT1 CALL SIGN” and “RPT2 CALL SIGN.” “MY CALL SIGN” can store up to 6 call signs, “YOUR CALL SIGN” can store up to 60 call signs and “RPT1/2 CALL SIGN” can store up to 60 call signs, and each call sign can be programmed with up to 8 characters.

◆ Your own call sign programming

Your own call sign must be programmed for both digital voice and low-speed data communications (including GPS transmission).

- ① Select B band as the main band. (p. 14)
- ② Enter “MY” in call sign set mode.

<MENU screen> ⇄ <CALL SIGN> ⇄ <MY>
(Push [MENU/LOCK]) (Rotate [DIAL][†], then push [↵](5)[†].)

- MY CALL SIGN screen is displayed.

```

MY CALL SIGN
=>M01

< : SET      ▲▼ : SEL
< : BACK    > : EDIT
                CLR : CLR
  
```

- ③ Rotate [DIAL][†] to select the desired call sign memory, “M01” to “M06.”
- ④ Push [▶](6) to enter call sign programming mode.
 - The 1st digit blinks.

```

MY CALL SIGN
=>M01      AB
  ●
  ●
  ●
  ●
  ●
  ●
< : SET      CLR : CLR
▲▼ : SEL    A/a : CHAR
▶ : CUR
  
```

- ⑤ Rotate [DIAL][†] to select the desired character or code.
 - Push [A/a](3) to change the character group from “AB” (alphabetical characters; capital letters), “12” (numbers) and “/” (symbols) in sequence.

⑥ Push **[▶](6)** to select 2nd digit, then rotate **[DIAL]†** to select the desired character or code.

- Push **[▶](6)** to move the cursor right; push **[◀](4)** to move the cursor left.
- 2nd digit blinks (1st digit stops blinking).



⑦ Repeat the steps ⑤ and ⑥ to enter your own call sign.

- Up to a 8-digit of call sign can be set.
- If an un-necessary character is entered, push **[▶](6)** or **[◀](4)** to select the character, then push **[CLR](1)** to erase the selected character, or push and hold **[CLR](1)** for 1 sec. to erase all characters following the cursor.
- When programming a note (Up to a 4-digit for operating radio type or area, etc.), go to step ⑧, otherwise go to step ⑩.

⑧ Push **[▶](6)** several times to set the cursor beside “” indication.

⑨ Repeat steps ⑤ to ⑥ to program the desired 4-character note.

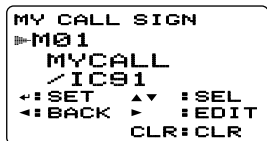

⑩ Push **[↵](5)** to store the programmed call sign with note and returns to MY CALL SIGN screen.

⑪ Push **[MENU/LOCK]** to return to frequency indication.

13 DV MODE OPERATION (Optional UT-123 is required)

◆ Station call sign programming

Station call sign must be programmed for the specified station call as well as repeater operation in both digital voice and low-speed data communications.

- ① Select B band as the main band. (p. 14)
- ② Enter "UR" in call sign set mode.

◀MENU screen▶ ⇄ ▶CALL SIGN▶ ⇄ ▶CUR▶
(Push [MENU/LOCK]) (Rotate [DIAL]†, then push [↵](5)†.)

- YOUR CALL SIGN screen is displayed.

```
YOUR CALL SIGN
▶U
CQCQCQ
◀:SET CLR:CLR
◀:BACK ▶:EDIT
CLR:CLR
```

- ③ Rotate [DIAL]† to select the desired call sign memory, "U01" to "U60."
- ④ Push [▶](6) to enter call sign programming mode.
 - The 1st digit blinks.

```
YOUR CALL SIGN
▶U01
AB
◀:SET CLR:CLR
◀:SEL A/a:CHAR
◀:CUR 0:CQ
```

- ⑤ Rotate [DIAL]† to select the desired character or code.
 - Push [A/a](3) to change the character group from "AB" (alphabetical characters; capital letters), "12" (numbers) and "/" (symbols) in sequence.

- ⑥ Push [▶](6) to select 2nd digit, then rotate [DIAL]† to select the desired character or code.
 - Push [▶](6) to move the cursor right; push [◀](4) to move the cursor left.
 - 2nd digit blinks (1st digit stops blinking).

```
YOUR CALL SIGN
▶U01
AB
◀:SET CLR:CLR
◀:SEL A/a:CHAR
◀:CUR 0:CQ
```

- ⑦ Repeat the steps ⑤ and ⑥ to enter the desired station call sign.
 - Up to an 8-digit of call sign can be set.
 - If an un-necessary character is entered, push [▶](6) or [◀](4) to select the character, then push [CLR](1) to erase the selected character, or push and hold [CLR](1) for 1 sec. to erase all characters following the cursor.

```
YOUR CALL SIGN
▶U01
STATION1
◀:SET CLR:CLR
◀:BACK ▶:EDIT
CLR:CLR
```

- ⑧ Push [↵](5) to store the programmed call sign and returns to YOUR CALL SIGN screen.
- ⑨ Push [MENU/LOCK] to return to frequency indication.

 **NOTE:** During the call sign programming mode (④ to ⑦), push **[CQ](0)** to set “CQCQCQ,” and push **[CQ](0)** again to return to the previously stored call sign.

✓ For your information

The IC-91A/91AD has call sign edit record function.

When editing a call sign stored in a call sign memory, regular memory or call channel, the default setting is to store the edited call sign into a blank channel automatically. (“FULL” is displayed when all call sign memory is programmed.)

The edited call sign can be over-written when the setting of the EDIT RECORD is set to OFF or SELECT. (p. 95)

However, you must manually over-write a programmed call sign in regular memory and call channels. (Temporary operation without over-writing is possible.)

13 DV MODE OPERATION (Optional UT-123 is required)

■ Digital voice mode operation

- ① Set the desired frequency in B band. (pgs. 14, 18)
 - Select output power, if desired. (p. 24)
- ② Select DV mode. (p. 21)
- ③ Set your own call sign for DV operation as follows.
 - 1 Enter “MY” in call sign set mode.

◀MENU screen▶ ⇄ ▶CALL SIGN▶ ⇄ ▶MY▶
(Push [MENU/LOCK]) (Rotate [DIAL]†, then push [↵](5)†.)

- 2 Rotate [DIAL]† to select the desired your own call sign channel (if you have programmed several call signs) then push [↵](5) to set the call sign and return to CALL SIGN screen.
 - See page 34 for your own call sign programming details.

```
CALL SIGN
▼UR:
R1:
R2: NOT USE*
MY: MYCALL
/IC91
```

- 4 Set the desired call sign as described in “When calling the desired station (p. 39)” or “When sending a CQ (p. 39).”
- 5 Push and hold [PTT] to transmit and speak into the microphone at normal voice level.
 - Tx/Rx indicator lights red and the RF meter shows the output power.
- 6 Release [PTT] to return to receive.
 - The other station call sign will be received.
 - Received call signs can be stored into the received call record automatically. See page 93 for details.

NOTE: The digital mode operation is vastly different from FM mode. One of the differences is in digital mode the squelch does not function as in FM mode. Changing the squelch setting will not open it to hear the hiss of “White Noise.” It only activates for digital squelch functions such as CSQL (Digital code squelch) or DSQL (Digital call sign squelch).

◇ When calling the desired station

Continued instruction from step 2 on page 38.

- 3 Rotate **[DIAL]**† to select “UR,” then push **[↵](5)**†.
 - YOUR CALL SIGN screen is displayed.
- 4 Rotate **[DIAL]**† to select the call sign channel in which desired station’s call sign is programmed.
 - See page 36 for station call sign programming details.
- 5 Push **[↵](5)** to set the station’s call sign and return to CALL SIGN screen.

```
CALL SIGN
▶UR: STATION1
R1:
R2: NOT USE*
MY: MYCALL
  /IC91
```

- 6 Push **[MENU/LOCK]** to return to frequency indication.
- 7 Perform the instruction steps 5 and 6 on page 38.

◇ When sending a CQ

Continued instruction from step 2 on page 38.

- 3 Rotate **[DIAL]**† to select “UR,” then push **[↵](5)**†.
 - YOUR CALL SIGN screen is displayed.
- 4 Rotate **[DIAL]**† to select the call sign channel in which “CQCQCQ” is programmed.
 - Or, select “U” then push **[▶](6)** and **[CQ](0)** in sequence to set “CQCQCQ.”
- 5 Push **[↵](5)** to set “CQCQCQ” as the call sign and return to CALL SIGN screen.

```
CALL SIGN
▶UR: CQCQCQ
R1:
R2: NOT USE*
MY: MYCALL
  /IC91
```

- 6 Push **[MENU/LOCK]** to return to frequency indication.
- 7 Perform the instruction step 5 and 6 on page 38.

13 DV MODE OPERATION (Optional UT-123 is required)

■ About D-STAR system

In the D-STAR system, repeater linking via a 10 GHz band backbone and internet network (gateway connection) capabilities are available. This system provides you with much wider coverage range during digital voice mode operation.

• D-STAR system outline

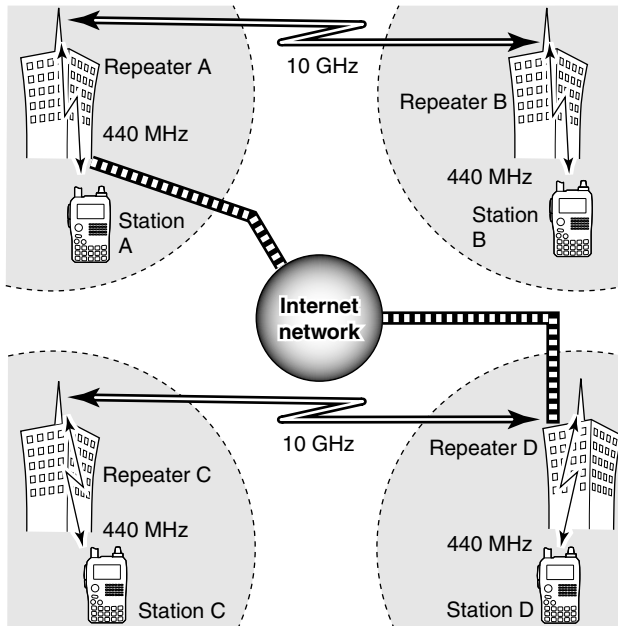

For current repeater operation, stations that are communicating must both be in the same repeater's operating area. However, in the D-STAR system as in the illustration at left, the repeaters can be linked via the system repeaters (with a 10 GHz signal). Thus stations A and B can communicate even though they are in different repeater operating areas.

Also, the D-STAR system repeaters are connectable through the internet— gateway connection capability.

For example, when station B uses the gateway connection station B can communicate with the station C!

By using the gateway connection, long distance communication like DX operation may be possible with 144 or 440 MHz digital voice!

In the D-STAR system, an independent repeater's operating area is called an Area and a group that of linked repeaters via a 10 GHz backbone is called a Zone.

■ Digital repeater operation

Repeater call signs must be programmed for repeater operation in both digital voice and low-speed data communications.

◇ Repeater call sign programming

- ① Select B band as the main band. (p. 14)
- ② Enter “R1” or “R2” in call sign set mode.

◀MENU screen▶ ⇄ ▶CALL SIGN▶ ⇄ ▶R1▶/▶R2▶
(Push [MENU/LOCK]) (Rotate [DIAL]†, then push [↵](5)†.)

- RPT1 or RPT2 CALL SIGN screen is displayed.
- ③ Rotate [DIAL]† to select the desired call sign memory, “R01” to “R60.”
 - ④ Push [▶](6) to enter call sign programming mode.
 - The 1st digit blinks.
 - ⑤ Rotate [DIAL]† to select the desired character or code.
 - Push [A/a](3) to change the character group from “AB” (alphabetical characters; capital letters), “12” (numbers) and “P” (symbols) in sequence.
 - Set “P” at the 1st digit then set the desired area repeater’s call sign (in a different zone) for CQ call (“P” stands for “CQCQCQ”) in a different zone operation. (p. 44)
 - ⑥ Push [▶](6) to select 2nd digit, then rotate [DIAL]† to select the desired character or code.
 - Push [▶](6) to move the cursor right; push [◀](4) to move the cursor left.
 - 2nd digit blinks (1st digit stops blinking).

- ⑦ Repeat the steps ⑤ and ⑥ to enter the desired repeater call sign.
 - Up to an 8-digit of call sign can be set.
 - Push [7] when setting with the gateway connection if the selected repeater has gateway capability. (The gateway connection can be set in RPT1 only when “NOT USE*” is set to RPT2.)
 - If an un-necessary character is entered, push [▶](6) or [◀](4) to select the character, then push [CLR](1) to erase the selected character, or push and hold [CLR](1) for 1 sec. to all characters following the cursor.

```

RPT1 CALL SIGN
▶R01
  RPT1AA G
◀:SET      ▲▼:SEL
◀:BACK    ▶:EDIT
          CLR:CLR
  
```

- ⑧ Push [↵](5) to store the programmed call sign and returns to RPT1 or RPT2 CALL SIGN screen.
- ⑨ Push [MENU/LOCK] to return to frequency indication.

13 DV MODE OPERATION (Optional UT-123 is required)

◆ Repeater operation in the same zone

- ① Set the desired repeater's frequency, offset and shift direction in B band. (pgs. 18, 31)
 - Select DV mode in advance. (p. 21)
- ② Set your own call sign. (p. 38)
 - See p. 34 for your own call sign programming.
- ③ Set the desired station call sign. (p. 39)
 - See p. 36 for station call sign programming.
- ④ Set the repeater's call sign as follows;
 - ① Enter "R1" in call sign set mode.

◀MENU screen▶ ⇄ ▶CALL SIGN▶ ⇄ ▶R1▶
(Push [MENU/LOCK]) (Rotate [DIAL]†, then push [↵](5)†.)

- ② Rotate [DIAL]† to select the nearest repeater's call sign.
- ③ Push [↵](5) to set the call sign for "R1."
 - Return to CALL SIGN screen.
- ④ Rotate [DIAL]† to select "R2" then push [↵](5)†.
 - RPT2 CALL SIGN screen is displayed.
- ⑤ Rotate [DIAL]† to select the desired repeater's (in the same zone) call sign.
 - Select "NOT USE*" when not operating RPT2.
- ⑥ Push [↵](5) to set the call sign for "R2."
 - Return to CALL SIGN screen.

```
CALL SIGN
▶UR: CQCQCQ
R1: RPT1AA
R2: NOT USE*
MY: MYCALL
/IC91
```

- ⑦ Push [MENU/LOCK] to return to frequency indication.

• Setting example 1

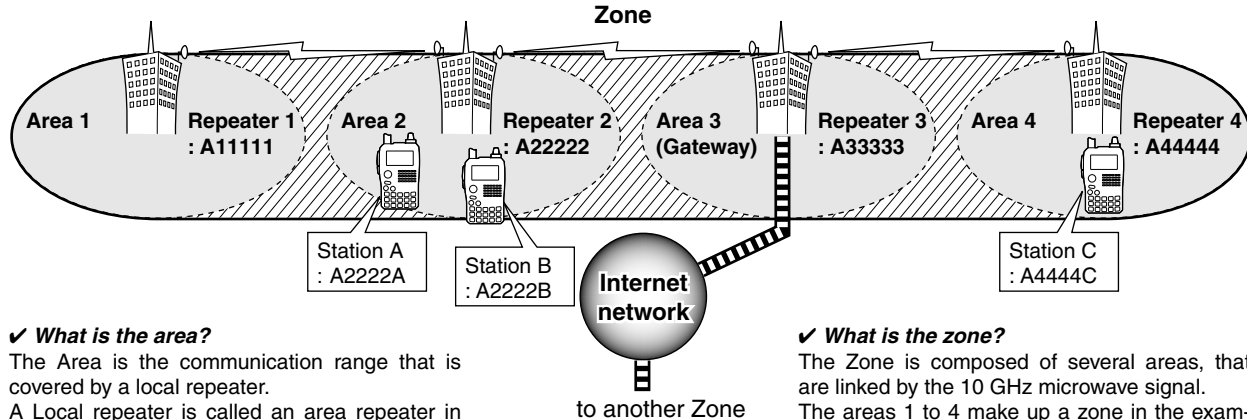

✓ **What is the area?**

The Area is the communication range that is covered by a local repeater. A Local repeater is called an area repeater in the D-STAR system.

✓ **What is the zone?**

The Zone is composed of several areas, that are linked by the 10 GHz microwave signal. The areas 1 to 4 make up a zone in the example above.

The setting when Station A is calling Station B

UR : A2222B
 R1 : A22222
 R2 : NOT USEQ
 MY : A2222A

The setting when Station A is making a CQ call in area 1

UR : CQCQCQ
 R1 : A22222
 R2 : A11111
 MY : A2222A

The setting when Station A is calling Station C

UR : A4444C
 R1 : A22222
 R2 : A44444
 MY : A2222A

13 DV MODE OPERATION (Optional UT-123 is required)

◆ Repeater operation into another zone

- ① Set the desired repeater's frequency, offset and shift direction in B band. (pgs. 18, 31)
 - Select DV mode in advance.
- ② Set your own call sign. (p. 38)
 - See p. 34 for your own call sign programming.
- ③ Set the desired station call sign. (p. 39)
 - **When making a CQ call**
Set the desired repeater's (in a different zone) call sign with a "/" symbol at the 1st digit, for the area in which you want to make a CQ call, into "UR."
 - See p. 36 for station call sign programming.
- ④ Set the repeater's call sign as follows;
 - ① Enter "R1" in call sign set mode.

◀MENU screen▶ ⇄ ▶CALL SIGN▶ ⇄ ▶R1▶
(Push [MENU/LOCK]) (Rotate [DIAL]†, then push [↵](5)†.)

- ② Rotate [DIAL]† to select the nearest repeater's call sign.
 - If the nearest repeater is gateway repeater, select the repeater's call sign with "G" setting at the 8th digit.
- ③ Push [↵](5) to set the call sign for "R1."
 - Return to CALL SIGN screen.
- ④ Rotate [DIAL]† to select "R2" then push [↵](5)†.
- ⑤ Rotate [DIAL]† to select the gateway repeater's (in the same zone) call sign.
 - The call sign should have "G" setting at the 8th digit.
 - When gateway repeater call sign is set in "R1," select "NOT USE*" for "R2" setting.

- ⑥ Push [↵](5) to set the call sign for "R2."
 - Return to CALL SIGN screen.

```
CALL SIGN
▶UR: CQCQCQ
R1: RPT1AA
R2: NOT USE*
MY: MYCALL
/IC91
```

- ⑦ Push [MENU/LOCK] to return to frequency indication.
- ⑤ Push [PTT] to transmit; release to receive.

• Setting example 2

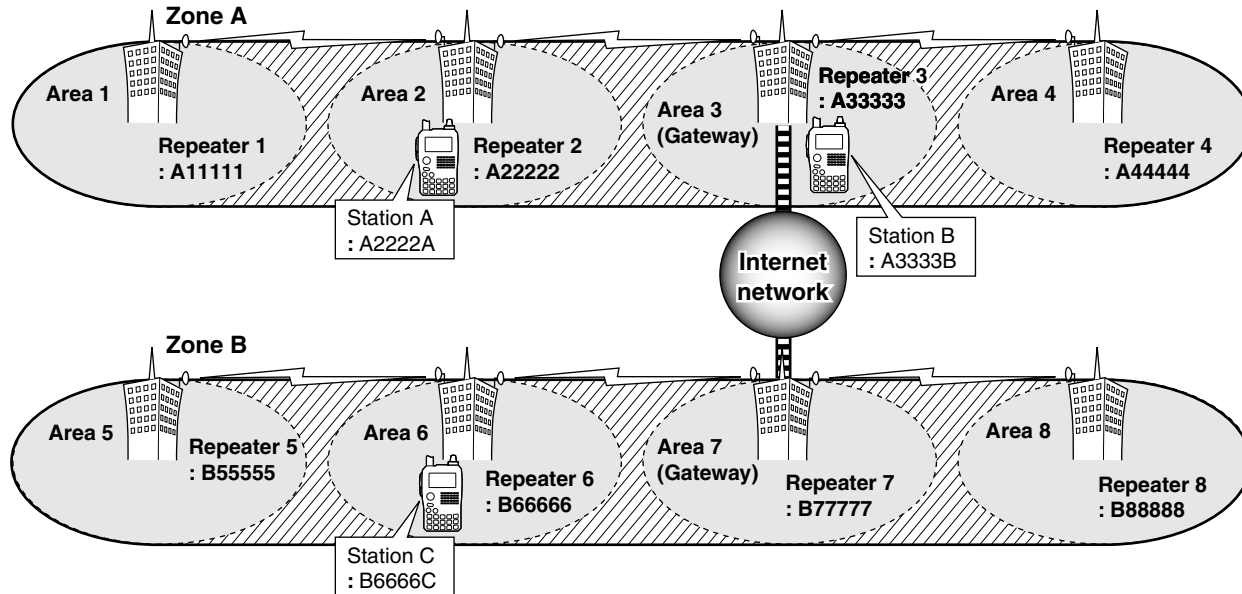

The setting when Station A is calling Station C

UR : B6666C
 R1 : A22222
 R2 : A33333 G
 MY : A2222A

The setting when Station A is making a CQ call in area 8

UR : /B88888
 R1 : A22222
 R2 : A33333 G
 MY : A2222A

The setting when Station B is calling Station C

UR : B6666C
 R1 : A33333 G
 R2 : NOT USE*
 MY : A3333B

13 DV MODE OPERATION (Optional UT-123 is required)

■ Received call sign

When a call is received in DV mode, the calling station and the repeater call signs being used can be stored into the received call record. The stored call signs are viewable in the following manner.

Up to 20 calls can be recorded.

◇ Desired call record indication

① Enter RX call sign set mode.

⟨MENU screen⟩ ⇄ ⟨RX CALL SIGN⟩
(Push [MENU/LOCK]) (Rotate [DIAL][†], then push [↵](5)[†].)

• RX CALL SIGN screen is displayed.

② Rotate [DIAL][†] to select the desired record channel.

③ To confirm the received call, push [↵](5) several times to select the desired call sign from CALLER, CALLED, RXRPT1 and RXRPT2.

CALLER : The station call sign that made a call.

CALLED : The station call sign called by the caller.

RXRPT1 : The repeater call sign used by the caller station.

RXRPT2 : The repeater call sign linked from RXRPT1.

④ Push [MENU/LOCK] to return to frequency indication.

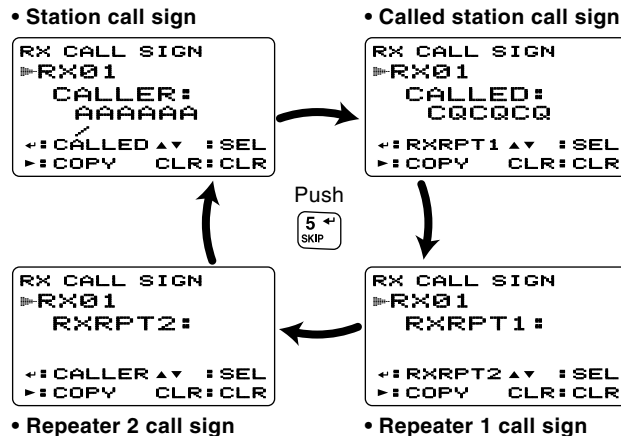

NOTE: When a call is received in DV mode when the power save function is activated, the call sign may not be received correctly.

This is normal, not a malfunction, because of header of the call sign cannot be detected during power save.

Turn the power save function OFF (p. 115) if you want to receive a call sign correctly even in stand-by condition.

✓ For your information

When receiving a call, the received station call sign is automatically displayed and scrolled in sequence at the bottom line of the function display.

This can be turned OFF in display set mode. (p.100)

◇ One-touch reply using the call record

The stored call signs in the call record can be used to the call.

- ① After receiving a call, push and hold [RX→CS](CALL) for 1 sec.
Or, while pushing and holding [RX→CS](CALL), rotate [DIAL] to select the desired call sign record.

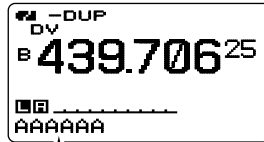

The received call sign is displayed while pushing and holding [CALL/RX→CS] when [DIAL] is rotated while [CALL/RX→CS] is pushed.

- Set your own call sign (MY) in advance. (p. 34)
 - The call sign stored in “CALLER” is stored as “UR,” “RXRPT1” is stored as “R2” and “RXRPT2” is stored as “R1.”
 - Error beeps sound when a call sign is received incorrectly, and no call sign is set in this case.
- ② Push [PTT] to transmit; release to receive.

Important!

Setting call signs with the “One-touch reply using the call record” operation as at left are for temporary operation only. Therefore, the set call signs will be overwritten when another call record is used to set call signs.

- Never saved into a call sign memory.

If you want to save the set call signs, see “Copying the call record contents into call sign memory” (p. 50) for details.

✓ For your information

When a call specifying your call sign is received, the call signs of the calling station and the repeater it is using can be used for operation automatically.

- When “RX call sign auto write” (p. 93) is set to “AUTO,” the station call sign in “CALLER” is set to “UR” automatically.
- When “Repeater call sign auto write” (p. 93) is set to “AUTO,” the stored station call sign in “RXRPT1” is stored as “R2” and “RXRPT2” is stored as “R1” automatically.

■ Copying the call sign

◇ Copying the call sign memory contents

This function is convenient when or modifying a part of the current call sign.

NOTE: Make sure that the “EDIT RECORD” item in DV set mode is set to “AUTO” or “SELECT” in advance. (p. 95)

① During DV mode operation, enter call sign set mode.

⟨MENU screen⟩ ⇄ ⟨CALL SIGN⟩
(Push [MENU/LOCK]) (Rotate [DIAL]†, then push [↵](5)†.)

- CALL SIGN screen is displayed.
- ② Rotate [DIAL]† to select “UR,” “R1” or “R2” as desired, then push [↵](5)†.
- ③ Rotate [DIAL]† to select the desired call sign channel to be copied.
 - U01–U60 and R01–R60 are available.

• When “AUTO” is set to “EDIT RECORD” item

- ④ Push [▶](6) to select the call sign programming mode.
- A blank channel is selected automatically.
 - The 1st digit of the selected call sign blinks.

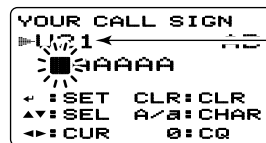

A blank channel number blinks.

- ⑤ Edit or modify the selected call sign as described in “◇ Station call sign programming” (p. 36) or “◇ Repeater call sign programming” (p. 41).
- ⑥ Push [↵](5) to store the edited/modified call sign into the selected blank channel.

NOTE: The message “FULL” is displayed when no blank channel is available in station or repeater call sign memory.

Select the desired call sign channel number as described in step ⑦ of “• When “SELECT” is set to “EDIT RECORD” item” at right-hand page in this case.

• **When “SELECT” is set to “EDIT RECORD” item**

- ④ Push [▶](6) to select the call sign programming mode.
 - The 1st digit of the selected call sign blinks.
- ⑤ Edit or modify the selected call sign as described in “◊ Station call sign programming” (p. 36) or “◊ Repeater call sign programming” (p. 41).
- ⑥ Push [↵](5).
 - Call sign channel number blinks.

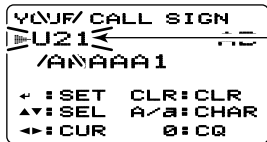

Call sign channel number blinks.

- ⑦ Rotate [DIAL]† to select the desired call sign channel to store.
- ⑧ Push [↵](5) to store the edited/modified call sign into the selected channel.

13 DV MODE OPERATION (Optional UT-123 is required)

◇ Copying the call record contents into call sign memory

This is a way to copying the call record contents (“CALLER,” “RXRPT1” and “RXRPT2”) into call sign memory (“UR,” “R1” and “R2”) at the same time or individually.

- ① Perform the steps ① to ③ of “◇ Desired call record indication” (p. 46) to select the desired call record or call sign.
- ② Push **[▶](6)** to select copy select mode.
 - COPY SELECT screen is displayed.

```
COPY SELECT
RX01
▶ALL
◀◀:BACK  ▲▲:SEL
▶:LIST   C:CURR
```

- ③ Rotate **[DIAL]†** to select the desired call sign to be copied from “ALL,” “RXRPT1” and “RXRPT2.”
 - “ALL” selection won’t appear when either station or repeater call sign memory has no blank channel.

• When “ALL” is selected

- Push **[▶](6)** to copy the selected record’s contents into the appropriate call sign memory.
 - Returns to RX CALL SIGN screen automatically.

• When “CALLER,” “RXRPT1” or “RXRPT2” is selected

- ① Push **[▶](6)** then rotate **[DIAL]†** to select the desired condition of call sign memory channel selection to be copied to from “AUTO” and “LIST SEL.”
 - “AUTO” selection won’t appear when the appropriate call sign memory has no blank channel.
 - Go to step ④ when “AUTO” is selected.

```
COPY SELECT
RX01
▶AUTO
LIST SEL
◀◀:BACK  ▲▲:SEL
▶:LIST
```

- ② Push **[▶](6)**, then select the desired call sign memory channel to copy to with **[DIAL]**.
- ③ Push **[▶](6)** to copy the call sign into the selected call sign memory.
 - Returns to RX CALL SIGN screen automatically.
- ④ Push **[MENU/LOCK]** to return to frequency indication.

■ Break-in communication

The break-in function allows you to break into a conversation, where the two original stations are communicating with call sign squelch enabled.

- ① While receiving an another station's communication, push and hold **[RX→CS](CALL)** for 1 sec. to set the communicating station's call sign.
 - When a call sign has not been received correctly, error beeps sound and no call sign is set. Receive the call sign of a communicating signal again, or set the call sign manually.
- ② Push and hold **[BK](9)** for 1 sec. to turn the break-in function ON.
 - "BK" appears.

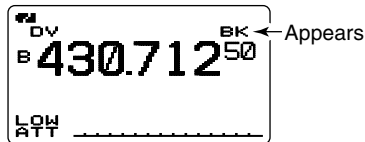

- ③ When both stations are in standby, push **[PTT]** to transmit a break-in call.
 - The programmed call sign station receives the break-in call as well as your call sign.
- ④ Wait for the reply call from the station who receives the break-in call.
- ⑤ After receiving the reply call, communicate normally.
- ⑥ To cancel the break-in, push and hold **[BK](9)** for 1 sec. to turn OFF.

• How to use the break-in?

While operating with the call sign squelch (p. 110), the squelch never opens (no audio sounds) even if a call is received, unless your own call sign ("MY") is specified.

However, when the call including the "BK ON" signal (break-in call) is received, the squelch will open and audio sounds even if the call is specified for another station.

• Station C calling to Station A with "BK OFF"

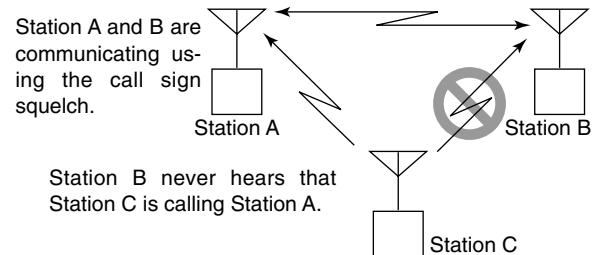

• Station C calling to Station A with "BK ON"

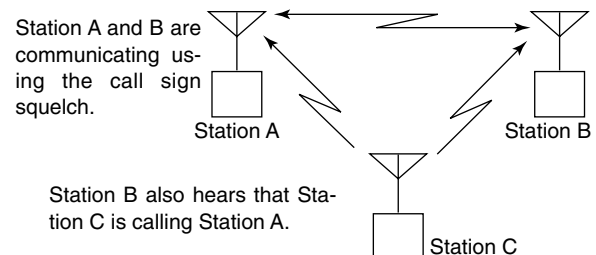

13 DV MODE OPERATION (Optional UT-123 is required)

■ Message operation

◇ TX message programming

TX messages are available for up to 5 channels and each channel can be programmed with a message of up to 20 characters. Available characters are **0** to **9**, **A** to **Z** (capital letters), **a** to **z** (lower case letters), some symbols and space.

① Enter "TX MESSAGE" in message/position set mode.

◀MENU screen▶ ⇄ ◀MESSAGE/POSITION▶ ⇄ ◀TX MESSAGE▶
(Push [MENU/LOCK]) (Rotate [DIAL]†, then push [↵](5)†.)

- TX MESSAGE screen is displayed.

② Rotate [DIAL]† to select the desired transmit message channel.

- Ch01 to Ch05 and OFF are available.
- Previously message is displayed if programmed.

③ Push [▶](6) to select the message edit condition.

- The 1st digit of the message blinks.



④ Rotate [DIAL]† to select the desired character or symbol.

- Push [A/a](3) to change the character group from "AB" (alphabetical characters; capital letters), "ab" (alphabetical characters; lower case letters), "12" (numbers) and "!" (symbols) in sequence.
- If an un-necessary character is entered, push [▶](6) or [◀](4) to select the character, then push [CLR](1) to erase the selected character, or push and hold [CLR](1) for 1 sec. to erase all characters following the cursor.

⑤ Push [▶](6) to select 2nd digit, then rotate [DIAL]† to select the desired character or code.

- Push [▶](6) to move the cursor right; push [◀](4) to move the cursor left.
- 2nd digit blinks (1st digit stops blinking).

⑥ Repeat the steps ④ and ⑤ to enter the desired message.

- Up to 20-character messages can be set.



⑦ Push [↵](5) to store the message.

⑧ Push [MENU/LOCK] to return to frequency indication.

◇ Message Transmission

Select the message transmission function ON (Ch01–05) and OFF. When a message channel is selected, the transceiver transmits a text message (pre-programmed). (default: OFF)

- ① Set the operating frequency, call signs and other settings, such as repeater, as desired in B band.
- ② Perform the steps ① to ③ in “◇ TX message programming” as at left.
- ③ Rotate **[DIAL]**† to select the desired message channel.
 - “Ch01” to “Ch05” available.
 - See left-hand pages for message programming.
- ④ Push **[J](5)** to set the message for transmission.
- ⑤ Push **[PTT]** to transmit the selected message.
 - The message is transmitted each time [PTT] is pushed.
 - The message is transmitted each 30 sec. automatically during continuous transmission.
- ⑥ Release **[PTT]** to return to receive.
- ⑦ When the reply call with a message is received, the call sign and the message scrolls at the bottom of the function display.



Scrolls the received message.

✓ For your information

The automatic received call sign and/or message indication can be turned OFF in display set mode, if desired.

- RX CALL SIGN (p. 100)
- RX MESSAGE (p. 101)

NOTE: Only 1 message can be stored in the IC-91A/91AD. The received message is cleared by turning power OFF, or overwritten when another message is received.

A transmitted message that includes lower case characters from the IC-91A/91AD may not be decoded and displayed correctly by the ID-800H, IC-V82/U82, etc.

13 DV MODE OPERATION (Optional UT-123 is required)

◇ RX message indication

The received message can also be checked in DV set mode.

- ① Select “RX MESSAGE” in message/position set mode.

⟨MENU screen⟩ ⇨ ⟨MESSAGE/POSITION⟩ ⇨ ⟨RX MESSAGE⟩
(Push [MENU/LOCK]) (Rotate [DIAL][†], then push [↵](5)[†].)

- The received message is displayed in RX MESSAGE screen.

```
RX MESSAGE
▶MESSAGE:

Hello!

◀◀BACK ▶▶CALLER
```

- ② Rotate [DIAL] or push [▼](8) to display the station call sign.

```
RX MESSAGE
▶CALLER:

BBBBBB
/

◀◀BACK ▲▶MSG
```

- ③ Push [↵](5) or [◀](4) to return to MESSAGE/POSITION screen.
- ④ Push [MENU/LOCK] to return to frequency indication.

■ Automatic reply function

The automatic reply function replies to calls by a station that specified your call sign.

Two methods of replying are available— one is making a reply call with your own call sign, and other one is making a reply call with reply voice audio that has been recorded in DV voice memory.

◇ Automatic reply function setting

- ① Enter “AUTO REPLY” in DV set mode. (p. 92)

⟨MENU screen⟩ ⇨ ⟨DV SET MODE⟩ ⇨ ⟨AUTO REPLY⟩
(Push [MENU/LOCK]) (Rotate [DIAL][†], then push [↵](5)[†].)

- AUTO REPLY screen is displayed.
- ② Rotate [DIAL][†] to select the desired reply condition.
 - OFF** : Deactivate the automatic reply function. (default)
 - ON** : Reply to the call with your own call sign.
 - VOICE** : Reply to the call with the recorded voice memory.

```
AUTO REPLY
▶OFF
ON
VOICE
```

- ③ Push [↵](5).
 - Returns to DV SET MODE screen automatically.
- ④ Push [MENU/LOCK] to return to frequency indication.

◇ Voice memory recording for automatic reply

IMPORTANT!

Deactivate the dualwatch function and set minimum [VOL] level when recording the DV voice memo. Otherwise received audio or unwanted noise from A band is also recorded into the voice memory.

- ① Select DV mode in B band, and deactivate the priority watch (p. 83) and weather alert function (p. 114) if activated.
- ② Enter "REPLY VOICE" in DV voice memo set mode.

◀MENU screen▶ ⇄ ◀DV VOICE MEMO▶ ⇄ ◀REPLY VOICE▶
 (Push [MENU/LOCK]) (Rotate [DIAL]†, then push [↵](5)†.)

- REPLY VOICE screen is displayed.

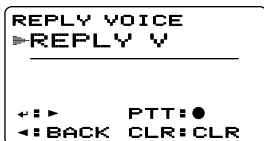

- ③ While pushing and holding [PTT], speak into the microphone.
 - Up to 10 seconds of message is recordable.
 - The recording stops after 10 second or when [PTT] is released.
- ④ Push [◀](4) to return to DV VOICE MEMO screen.
- ⑤ Push [MENU/LOCK] to return to frequency indication.

◇ Play-back or erase the voice memory

- ① Push [MENU/LOCK] to select menu mode indication.
- ② Rotate [DIAL]† to select "DV VOICE MEMO," then push [↵](5)†.
- ③ Rotate [DIAL]† to select "REPLY VOICE," then push [↵](5)†.
 - REPLY VOICE screen is displayed.
- ④ To play-back the recorded voice memory, push [↵](5).
 - Push [↵](5) again to pause, push [▶](6) to cancel the play-back.
- ⑤ To erase the recorded voice memory, push and hold [CLR](1) for 1 sec.

13 DV MODE OPERATION (Optional UT-123 is required)

■ EMR communication

The EMR communication mode is available for digital mode operation. In the EMR communication mode, no call sign setting is necessary. When an EMR communication mode signal is received, the audio (voice) will be heard at the specified level even the volume setting level is set to minimum level, or digital call sign/digital code squelch is in use.

- ① Set the desired frequency in 144 or 440 MHz band then push and hold **[EMR](.)** until 3 short and 1 long beeps sound to turn the EMR setting ON.
 - "EMR" appears

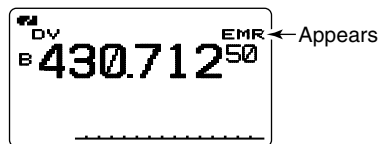

- ② Operate the transceiver normal way.
- ③ To cancel the EMR communication mode, push and hold **[EMR](.)** for 1 sec. to turn OFF.

■ Low-speed data communication

In addition to the digital voice communication, low-speed data communication is available.

The optional OPC-1529R DATA COMMUNICATION CABLE and serial data communication software (purchase locally) are required in addition.

The optional RS-91 REMOTE CONTROL SOFTWARE (OPC-1529R supplied) also includes a low-speed data communication capability.

NOTE: Turn OFF the GPS mode (p. 58) in advance to operate the low-speed data communication.

◇ Connection

Connect the transceiver to your PC using with the optional OPC-1529R as illustrated below.

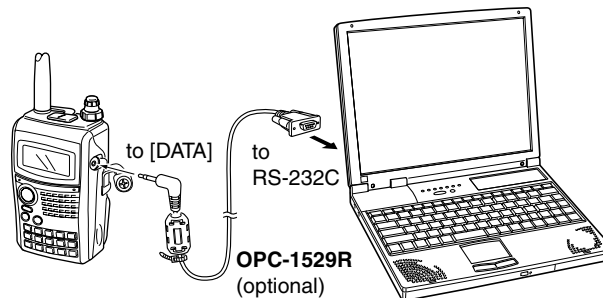

◇ Low-speed data communication application setting

Configure the low-speed data communication application as follows.

- Port : The same COM port number as IC-91A/91AD's
- Baud rate : 38.4 kbps (fixed value)
- Data : 8 bit
- Parity : None
- Stop : 1 bit
- Flow control : Xon/Xoff

◇ Low-speed data communication operation

NOTE: Confirm that in AUTO, the computer controls when [PTT] is activated to send data and the user doesn't have to operate the radio.

- ① Set your own, station call signs, etc. as described in "■ Digital voice mode operation" (p. 38) and "■ Digital repeater operation" (p. 41).
- ② Refer to the instructions of the low-speed data communication application.
- ③ To transmit data
 - With your voice audio, push and hold [PTT] to transmit while sending data from the PC. Release [PTT] to receive.
 - Under computer control, see Transmission condition setting at right.

◇ Transmission condition setting

- ① Enter "DV DATA TX" in DV set mode. (p. 92)

◀MENU screen▶ ⇄ ◀DV SET MODE▶ ⇄ ◀DV DATA TX▶
(Push [MENU/LOCK]) (Rotate [DIAL]†, then push [↵](5)†.)

- ② Rotate [DIAL]† to select "PTT" or "AUTO."
- ③ Push [↵](5) (or [←](4)) to return to DV set mode, and push [MENU/LOCK] to return to frequency indication.

13 DV MODE OPERATION (Optional UT-123 is required)

■ GPS operation

During GPS mode operation, a GPS receiver (RS-232C output/NMEA format) can be connected to the **[DATA]** socket of the IC-91A/91AD to indicate the current position (Latitude and Longitude). The position data is transmitted with your voice signals at the same time.

In addition, the GPS message transmission is also available for the GPS mode operation.

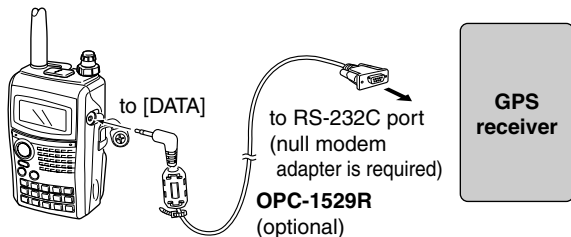

◇ Sentence formatter setting

① Enter “GPS MODE” in DV set mode. (p. 94)

⟨MENU screen⟩ ⇔ ⟨DV SET MODE⟩ ⇔ ⟨GPS MODE⟩
(Push **[MENU/LOCK]**) (Rotate **[DIAL]**†, then push **[↵](5)**†.)

• GPS MODE screen is displayed.

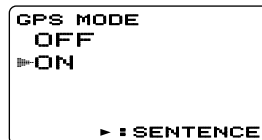

② Rotate **[DIAL]**† to select “ON.”

③ Push **[↵](5)**† to select GPS SENTENCE screen.

④ Rotate **[DIAL]**† to select the desired GPS sentence, then push **[↵](5)**.

• A total 5 sentences, RMC, GGA, GLL, GSA and VTG are available.

⑤ Rotate **[DIAL]**† to turn the sentence usage ON and OFF.

⑥ Push **[↵](5)** (or **[◀](4)**) to return to GPS SENTENCE screen.

⑦ Repeat the steps ④ to ⑥ to set another GPS sentence usage.

• Up to 3 GPS sentences are usable at the same time.

⑧ Push **[MENU/LOCK]** to return to frequency indication.

◆ GPS message programming

① Enter “GPS” in message/position set mode.

◀MENU screen> ⇨ ▶MESSAGE/POSITION> ⇨ ▶GPS>
(Push [MENU/LOCK]) (Rotate [DIAL]†, then push [↵](5)†.)

- GPS MESSAGE screen is displayed.

② Push [▶](6) to select the message edit condition.

- The 1st digit of the message blinks.



③ Rotate [DIAL]† to select the desired character or symbol.

- Push [A/a](3) to change the character group from “AB” (alphabetical characters; capital letters), “ab” (alphabetical characters; lower case letters), “12” (numbers) and “!” (symbols) in sequence.

④ Push [▶](6) to select 2nd digit, then rotate [DIAL]† to select the desired character or code.

- Push [▶](6) to move the cursor right; push [◀](4) to move the cursor left.
- 2nd digit blinks (1st digit stops blinking).

⑤ Repeat the steps ④ and ⑤ to enter the desired message.

- Up to 20-character messages can be set.



⑥ Push [↵](5) to store the message.

⑦ Push [MENU/LOCK] to return to frequency indication.

13 DV MODE OPERATION (Optional UT-123 is required)

◇ GPS message automatic transmission

① Enter "GPS AUTO TX" in DV set mode. (p. 95)

◀MENU screen▶ ⇄ ▶DV SET MODE▶ ⇄ ▶GPS AUTO TX▶
(Push [MENU/LOCK]) (Rotate [DIAL][†], then push [↵](5)[†].)

- GPS AUTO RX screen is displayed.

```
GPS AUTO TX
▶OFF
5SEC
10SEC
30SEC
1MIN
```

② Rotate [DIAL][†] to select the desired position data transmitting interval from 5 sec., 10 sec., 30 sec., 1 min., 3 min., 5 min., 10 min., 30 min. and OFF.

- The position data is transmitted only when [PTT] is pushed with OFF setting, the data is transmitted automatically once every 5 sec., 10 sec., 30 sec., 1 min., 3 min., 5 min., 10 min. and 30 min. when the appropriate setting is selected.
- The GPS message is also transmitted if programmed.

③ Push [↵](5) (or [◀](4)) to return to DV SET MODE screen.

④ Push [MENU/LOCK] to return to frequency indication.

▨ **NOTE:** Your own call sign ("MY") should be set to activate the GPS automatic transmission.

◇ Position indication

① Enter "POSITION" in message/position set mode.

◀MENU screen▶ ⇄ ▶MESSAGE/POSITION▶ ⇄ ▶POSITION▶
(Push [MENU/LOCK]) (Rotate [DIAL][†], then push [↵](5)[†].)

- GPS POSITION screen is displayed.

```
GPS POSITION
▶MY POSITION

34.56.789 N
123.45.678 E
◀◀ BACK ▶▶ RX POS
```

② Rotate [DIAL][†] to select the received position data indication.

③ Push [↵](5) (or [◀](4)) to return to MESSAGE/POSITION screen.

④ Push [MENU/LOCK] to return to frequency indication.

◇ Received GPS message indication

① Enter "RX GPS" in message/position set mode.

◀MENU screen▶ → ◀MESSAGE/POSITION▶ → ◀RX GPS▶
(Push [MENU/LOCK]) (Rotate [DIAL]†, then push [↵](5)†.)

- RX GPS MESSAGE screen is displayed.

```
RX GPS MESSAGE
▶DATA:

  Call from
  Osaka!

◀◀ BACK
```

- ② Push [↵](5) (or [◀](4)) to return to MESSAGE/POSITION screen.
- ③ Push [MENU/LOCK] to return to frequency indication.

13 DV MODE OPERATION (Optional UT-123 is required)

■ Other functions for DV mode

◇ DV voice memory

The IC-91A/91AD has a DV voice memory that records a total 30 second (approx.) of received audio.

The DV voice memory is divided into 2 tracks, 15 seconds each in a track, as the default setting.

◆ Recording received audio

- ① Select DV mode in B band, and deactivate the priority watch (p. 83) and weather alert function (p. 114) if activated.
- ② While receiving a DV signal, push **[REC]**.

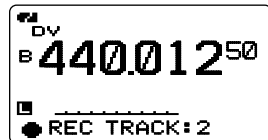

- ③ Rotate **[DIAL]** to select the desired track.
 - “*” is displayed beside the track number when the selected track has been recorded.
- ④ Push **[REC]** to start recording.
 - Track counter (bar meter) is displayed during record.
 - The recording is paused automatically when the DV signal is interrupted or when the DV audio signal cannot be received correctly. Re-starts the recording when the DV audio signal is received correctly.
- ⑤ Push **[REC]** again to stop recording.
 - The recording stops automatically when the track becomes full.

operation

◆ Track size setting

The track size can be changed with the following instruction.

- ① Enter “TRACK SIZE” in DV voice memo set mode.

◀MENU screen> ⇨ <DV VOICE MEMO> ⇨ <TRACK SIZE>
(Push **[MENU/LOCK]**) (Rotate **[DIAL]**†, then push **[↵](5)**†.)

- TRACK SIZE screen is displayed

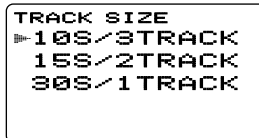

- ② Rotate **[DIAL]**† to select the desired track size.
 - 10S/3TRACK** : Makes 3 tracks and 10 seconds audio can be recorded in each track.
 - 15S/2TRACK** : Makes 2 tracks and 15 seconds audio can be recorded in each track.
 - 30S/1TRACK** : Makes 1 track only and 30 seconds audio can be recorded in a track.
- ③ Push **[↵](5)** (or **[◀](4)**) to return to DV VOICE MEMO screen.
- ④ Push **[MENU/LOCK]** to return to frequency indication.

◆ Playing-back and erasing the recorded audio

- ① Select DV mode in B band, and deactivate the priority watch (p. 83) and weather alert function (p. 114) if activated.
- ② Enter "TRACK" in DV voice memo set mode.

⟨MENU screen⟩ ⇄ ⟨DV VOICE MEMO⟩ ⇄ ⟨TRACK⟩
(Push [MENU/LOCK]) (Rotate [DIAL]†, then push [↵](5)†.)

- TRACK screen is displayed

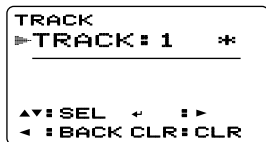

- ③ Rotate [DIAL]† to select the desired audio track to be play-back or erased.
 - "*" is displayed beside the track number when the selected track has been recorded.
- ④ Push [↵](5) to play-back the recorded audio.
 - Push [↵](5) again to pause, push [▶](6) to stop play-back.
- ⑤ Push and hold [CLR](1) for 1 sec. to erase the recorded audio.
- ⑥ Push [◀](4) to return to DV VOICE MEMO screen.
- ⑦ Push [MENU/LOCK] to return to frequency indication.

◇ DV automatic detect

The "DV" mode indicator blinks when a non-DV signal is received during DV mode operation.

The IC-91A/91AD DV automatic detection monitors in FM mode when other than DV mode signal is received.

- ① Enter "AUTO DETECT" in DV set mode. (p. 95)

⟨MENU screen⟩ ⇄ ⟨DV SET MODE⟩ ⇄ ⟨AUTO DETECT⟩
(Push [MENU/LOCK]) (Rotate [DIAL]†, then push [↵](5)†.)

- ② Rotate [DIAL]† to turn the DV automatic detect function ON and OFF.

OFF : "DV" mode indicator blinks, however the transceiver receives in DV mode even if non-DV mode signals are received.

ON : "DV" mode indicator blinks and the transceiver monitors the signal in FM mode.

- ③ Push [↵](5) (or [◀](4)) to return to DV SET MODE screen
- ④ Push [MENU/LOCK] to return to frequency indication.

NOTE: The received FM audio may be distorted when receiving an FM signal with DV automatic detect function.

14 OTHER FUNCTIONS

■ General

MENU screen is used for programming infrequently changed values or conditions of functions.

• Entering MENU screen and operation

- ① Push [**F**•**→**•**○**] to display the function guide.
- ② Push [**V/MHz**•**SCAN**] (Right band's) to enter MENU screen.
- ③ Rotate the [**DIAL**] to select the desired menu group, then push [**MAIN**•**BAND**].
- ④ Rotate the main band's [**DIAL**] to select the desired item, then push [**MAIN**•**BAND**].
- ⑤ Rotate the [**DIAL**] to select the desired condition or value, then push [**MAIN**•**BAND**].
- ⑥ Push [**F**•**→**•**○**] to return to frequency indication or push [**V/MHz**•**SCAN**] (Right band's) to return the back screen.



- ① Push [**BAND**] to select the main band.
- ② Push [**SET B(D-OFF)**] to enter set mode.
- ③ Push [**SET B(D-OFF)**] or [**ENT C(T-OFF)**] to select the desired item.
- ④ Push [**▲**] or [**▼**] to select the condition or value.
- ⑤ Push [**CLR A(MW)**] to exit set mode.

■ Menu list

MENU	REF.	MENU	REF.
CALL SIGN†	—	DUP/TONE...	p. 94
RX CALL SIGN†	—	DISPLAY	p. 94
DV MESSAGE†	—	SOUNDS	p. 94
DV VOICE MEMO†	—	DV GPS	p. 94
SET MODE	p. 93	PACKET	p. 94
DV SET MODE	p. 93	GPS SET MODE	p. 94
SCAN	p. 93		

†Refer to the chapter 11 for details.

■ Items list

◇ CALL SIGN†

ITEMS	REF.	ITEMS	REF.
YOUR CALL SIGN	—	MY CALL SIGN	—
RPT CALL SIGN	—		—

◇ RX CALL SIGN†

ITEMS	REF.	ITEMS	REF.
RX01: /	—	⋮	—
RX02: /	—	RX19: /	—
⋮	—	RX20: /	—

◇ DV MESSAGE†

ITEMS	REF.	ITEMS	REF.
TX MESSAGE	—	RX MESSAGE	—

◇ DV VOICE MEMO†

ITEMS	REF.	ITEMS	REF.
TRACK	—	TRACK SIZE	—
REPLY VOICE	—		

†Refer to the chapter 11 for details.

◇ SET MODE

ITEMS	REF.	ITEMS	REF.
TIME-OUT TIMER	p. 92	SQL DELAY	p. 94
AUTO POWER OFF	p. 92	MIC SENS LEVEL	p. 94
PTT LOCK	p. 92	AUTO ATT	p. 94
BUSY LOCKOUT	p. 93	ALC	p. 94
AUTO REPEATER	p. 93	DIVERSITY	p. 94
FAN CONTROL	p. 93		

◇ DV SET MODE

ITEMS	REF.	ITEMS	REF.
AUTO REPLY	p. 92	RXRPT WRITE	p. 94
DIGITAL CODE	p. 92	DV AUTO DETECT	p. 94
DV DATA TX	p. 92	EDIT RECORD	p. 94
DIGITAL MONITOR	p. 93	EMR	p. 94
DIGITAL RPT SET	p. 93	BK	p. 94
RXCALL WRITE	p. 93		

◇ SCAN

ITEMS	REF.	ITEMS	REF.
SCAN TIMER	p. 92	BANK LINK SCAN	p. 94
PROGRAM SKIP SCAN	p. 92	BANK LINK	p. 94

14 OTHER FUNCTIONS

◇ DUP/TONE

ITEMS	REF.	ITEMS	REF.
OFFSET FREQ	p. 92	WX ALERT	p. 94
REPEATER TONE	p. 92	PGR/CSQL	p. 94
CTCSS TONE	p. 92	PGR/ CODE	p. 94
DTCS CODE	p. 93	DTMF SPEED	p. 94
DTCS POLARITY	p. 93		

◇ DISPLAY

ITEMS	REF.	ITEMS	REF.
BACKLIGHT	p. 92	OPENING CALL S	p. 94
DIMMER	p. 92	SCAN NAME	p. 94
AUTO DIMMER	p. 92	RX CALL SIGN	p. 94
LCD CONTRAST	p. 93	TX CALL SIGN	p. 94
OPENING LOGO	p. 93	RX MESSAGE	p. 94

◇ SOUNDS

ITEMS	REF.	ITEMS	REF.
KEY-TOUCH BEEP	p. 92	SUB BAND MUTE	p. 94
BEEP LEVEL	p. 92	SUB BAND BEEP	p. 94
SCOPE AF OUTPUT	p. 92	STANDBY BEEP	p. 94

◇ DV GPS

ITEMS	REF.	ITEMS	REF.
GPS SENTENCE	p. 92	GPS TX	p. 94
GPS MESSAGE	p. 92	GPS AUTO TX	p. 94
RX GPS MESSAGE	p. 92		

◇ PACKET

ITEMS	REF.	ITEMS	REF.
PACKET BPS	p. 92	PACKET BAND	p. 94

◇ GPS SET MODE

ITEMS	REF.	ITEMS	REF.
GPS SPEED	p. 92	GPS DATUM	p. 94
LINEAR MEASURE	p. 92	POS AREA1	p. 94
UTC OFFSET	p. 92	POS AREA2	p. 94

14 OTHER FUNCTIONS

■ SET MODE items

◇ Time-out timer

To prevent accidental prolonged transmission, etc., the transceiver has a time-out timer. This function cuts a transmission OFF after 1, 3 or 5 min. of continuous transmission. This timer can be cancelled.

- OFF : The time-out timer is turned OFF. (default)
- 1, 3, 5 MIN : The transmission is cut OFF after the set period elapses.

◇ Auto power OFF

The transceiver can be set to automatically turn OFF after a specified period with a beep when no key operations are performed.

30 min, 60 min, 120 min and OFF (default) can be specified. The specified period is retained even when the transceiver is turned OFF by the auto power OFF function. To cancel the function, select "OFF" in this set mode.

◇ PTT lock

Turns the PTT lock function ON and OFF(default.)
Transmission with [PTT] is inhibited when ON is selected to prevent accidental transmission, etc.

◇ Busy lockout

Turns the busy lockout function ON and OFF(default.)
This function inhibits transmission while receiving a signal or when the squelch is open

◇ Auto repeater

U.S.A./KOREAN versions only

The auto repeater function automatically turns ON or OFF the duplex operation and tone encoder. The offset and repeater tone is not changed by the auto repeater function. Reset these frequencies, if necessary.

U.S.A. version:

- OFF : The auto repeater function is turned OFF.
- RPT1 : Activates for duplex only. (default)
- RPT2 : Activates for duplex and tone.

Korean version:

- OFF : Deactivates the function.
- ON : Activates duplex and tone. (default)

◇ Fan control

Selects the cooling fan control condition from AUTO, HI, MID and LOW.

- AUTO: The fan rotates during transmit and for 2 min. after transmission.(default)
- HI : The high power fan continuously rotates.
- MID : The middle power fan continuously rotates.
- LOW : The low power.fan continuously rotates.

◇ Squelch delay

Selects squelch delay from short and long to prevent repeated opening and closing of the squelch during reception of the same signal.

- Short : Short squelch delay. (default)
- Long : Long squelch delay

◇ Mic sens level

Selects the microphone sensitivity from HIGH (default) and LOW to suit your preference.

◇ Auto ATT

The attenuator prevents distortion of a desired signal by very strong RF signals near the desired frequency or when very strong electric fields, such as from a broadcasting station, are present at your location.

Select the attenuator function ON (default) and OFF.

◇ ALC

Sets the ALC (automatic Level Control) function ON and OFF (default)

The ALC function reduces the microphone again automatically when the transmission audio is distorted.

◇ Diversity

Turns the diversity function ON and OFF(default.)

■ DV SET MODE items

The following items are selectable by optional UT-123 is installed into the IC-2820H.

◇ Auto reply

This function replies to an individual station call even you are away from the transceiver.

After a manual transmission (pushing **[PTT]**), the Auto Reply setting returns to OFF automatically.

- OFF : No reply is performed even a call is received. (default)
- ON : Sets caller's call sign and reply to the call with the set own call sign automatically.

◇ Digital code

Sets the desired digital code for digital code squelch operation. Total of 100 codes (0–99) are available. (default: 0)

◇ DV data TX

During low-speed data operation, auto data transmission function is available. This function transmits when data has been input from PC via the **[DATA]** jack. (default: PTT)

14 OTHER FUNCTIONS

◆ Digital monitor

Sets the desired monitoring mode during DV MODE OPERATION (Optional UT-123 is required) from “Auto,” “Digital” and “Analog.”

- **AUTO** : The transceiver sets monitoring mode to FM and DV according to the received signal. (default)
- **DIGITAL** : Monitors in DV mode.
- **ANALOG** : Monitors in FM mode.

◆ Digital repeater setting

When accessing a digital repeater with a call sign different than is programmed, the repeater call sign can be stored into “RPT1” and/or “RPT2” automatically by reading the repeater’s transmission. The stored repeater’s call sign can be re-called when selecting the repeater call sign. (default: ON)

◆ RX call sign auto write

When an individual station call is received, the calling station call sign can be automatically set in “UR.” (default: OFF)

◆ Repeater call sign auto write

When accessing a repeater with a call sign different than is programmed, the repeater call sign can be set into “RPT1” and or “RPT2” automatically by reading the repeater’s transmission. (default: OFF)

▨ The transceiver sets the received repeater call sign for operation. Therefore, when a different call sign is set for operation, the previously set repeater call sign will be lost.

◆ DV auto detect

When a signal other than DV mode is received during DV mode operation, the transceiver has capability of automatic FM mode selection.

- **OFF** : Operating mode is fixed in DV. (default)
- **ON** : The transceiver automatically selects FM mode for temporary operation.

◆ Call sign edit record

Selects the call sign programming when the call sign is edited or corrected with the pre-programmed call sign.

- **OFF** : The edited or corrected call sign is overwritten.
- **SELECT** : The edited or corrected call sign is programmed into the selected call sign memory.
- **AUTO** : The edited or corrected call sign is programmed into a blank channel automatically. (default)

◇ EMR communication

Turns the EMR communication mode ON and OFF. (default)

◇ Break-in communication

Turns the break-in communication mode ON and OFF. (default)

■ SCAN items

◇ Scan timer

Selects scan resume timer from T-15, T-10 (default), T-5 and P-2.

- T-15/10/5 : Scan pauses for 15/10/5 sec., then resumes.
- P-2 : Pause on a signal until signal disappears, then resumes 2 sec. after the signal disappears.

◇ Program skip scan

Sets channel skip setting from ON (default) and OFF for memory skip scan operation.

This item appears when set mode is accessed from memory mode only.

◇ Bank link scan

Sets the memory bank link function ON (default) and OFF. The link function provides continuous bank scan, scanning all contents in the selected banks during bank scan.

• Bank link setting

- ① Enter MENU screen in function guide.
- ② Rotate the main band's [DIAL] to select "SCAN" set mode, then push [MAIN•BAND].
- ③ Rotate the [DIAL] to select "BANK LINK", then push [MAIN•BAND] to enter bank setting.
- ④ Rotate the [DIAL] to select the desired bank initial, then push [MAIN•BAND].
- ⑤ Rotate [DIAL] to turn ON (default) and OFF, then push [MAIN•BAND].
- ⑥ Rotate [DIAL] to select next bank and repeat steps ④ to ⑤, or push [F•---] to exit scan set mode.

14 OTHER FUNCTIONS

■ DUP/ TONE items

◇ Offset frequency

Sets the duplex offset frequency within 0 to 159.995 MHz range. During duplex (repeater) operation, transmit frequency shifts the set frequency. (default value may differ depending on operating frequency band and versions)

◇ Repeater tone

Sets subaudible tone frequency (encoder only) for repeater operation. Total of 50 tone frequencies (67.0–254.1 Hz) are available. (default: 88.5 Hz)

◇ CTCSS tone

Sets subaudible tone frequency (both encoder and decoder) for tone squelch operation. Total of 50 tone frequencies (67.0–254.1 Hz) are available. (default: 88.5 Hz)

• Available subaudible tone frequencies

67.0	79.7	94.8	110.9	131.8	156.7	171.3	186.2	203.5	229.1
69.3	82.5	97.4	114.8	136.5	159.8	173.8	189.9	206.5	233.6
71.9	85.4	100.0	118.8	141.3	162.2	177.3	192.8	210.7	241.8
74.4	88.5	103.5	123.0	146.2	165.5	179.9	196.6	218.1	250.3
77.0	91.5	107.2	127.3	151.4	167.9	183.5	199.5	225.7	254.1

◇ DTCS code

Sets DTCS code (both encoder and decoder) for DTCS squelch operation. Total of 104 codes are available.

(default: 023)

• Available DTCS codes

023	054	125	165	245	274	356	445	506	627	732
025	065	131	172	246	306	364	446	516	631	734
026	071	132	174	251	311	365	452	523	632	743
031	072	134	205	252	315	371	454	526	654	754
032	073	143	212	255	325	411	455	532	662	
036	074	145	223	261	331	412	462	546	664	
043	114	152	225	263	332	413	464	565	703	
047	115	155	226	265	343	423	465	606	712	
051	116	156	243	266	346	431	466	612	723	
053	122	162	244	271	351	432	503	624	731	

◇ DTCS polarity

Sets DTCS polarities for transmission and reception from “BOTH N,” “TN-RR,” “TR-RN” and “BOTH R”

(default: BOTH N)

◇ Weather alert function

U.S.A. version only

Turns weather alert function ON and OFF.

See.P??? detale.

◇ PGR/C-SQL

Sets DTCS polarities for transmission and reception from “BOTH N,” “TN-RR,” “TR-RN” and “BOTH R”

(default: BOTH N)

◇ PGR/CODE

Sets DTCS polarities for transmission and reception from “BOTH N,” “TN-RR,” “TR-RN” and “BOTH R”
(default: BOTH N)

◇ DTMF speed

The rate at which DTMF memories send individual DTMF characters can be set to accommodate operating needs.

- 100 : 100 msec. interval; 5.0 cps speed (default)
- 200 : 200 msec. interval; 2.5 cps speed
- 300 : 300 msec. interval; 1.6 cps speed
- 500 : 500 msec. interval; 1.0 cps speed

■ DISPLAY items**◇ Back light**

Adjust to suit back color conditions. The levels change led to green. led (Left) → yellow green → green (Right)
(default: yellow green)

◇ Display dimmer

Adjust to suit back lighting conditions.
The levels 1 (dark) to 8 (bright: default) are available.

◇ Auto dimmer

Turns the auto dimmer function OFF, AUTO-OFF, AUTO-D1 to AUTO-D7.

- OFF : Opening logo is displayed at power ON. (default)
- AUTO-OFF : Opening logo indication is skipped.
- AUTO-D1 to D7 : Opening logo indication is skipped.

◇ LCD contrast

The contrast of the LCD can be selected from 16 levels.
• 1 (Low contrast) to 16 (High contrast) (default: 8)

◇ Opening logo

The opening logo indication (Icom logo and transceiver name) that is displayed at power ON can be skipped, if desired.

- ON : Opening logo is displayed at power ON. (default)
- OFF : Opening logo indication is skipped.

14 OTHER FUNCTIONS

◆ Opening call sign

📡 **Available only when the UT-123 is installed.**

The set your own call sign, programmed in my call sign, can be displayed at power ON. (default: OFF)

◆ Scan name

The programmed scan or bank name is displayed during the scan type selection.

- ON : The programmed scan or bank name is displayed. (default)
- OFF : The programmed scan or bank name is not displayed.

◆ RX Call Sign Display

📡 **Available only when the UT-123 is installed.**

When a call is received, the calling station call sign can be indicated automatically. (default: OFF)

◆ TX Call Sign Display

📡 **Available only when the UT-123 is installed.**

Selects call sign display function from YOUR, MY and OFF. When this setting is set to YOUR or MY, the transceiver automatically indicates the set station or your own call sign at digital mode transmission. (default: YOUR)

◆ RX message Display

📡 **Available only when the UT-123 is installed.**

Sets auto received message display function AUTO and OFF. When this setting is set to AUTO, the transceiver automatically indicates and scrolls the received message. (default: AUTO)

■ SOUND items

◇ Key-touch beep

The key-touch beep can be turned OFF for silent operation. (default: ON)

◇ Beep level

Adjusts the key-touch beep tone level to the desired level from 9 levels.

- 1 (Minimum level) to 9 (Maximum level) (default: 5)

/// The key-touch beep function must be set to ON to have a beep tone.

◇ Scope AF output

Select the audio output function capability during sweep with band scope function.

- ON : The received audio sounds during sweep. (default)
- OFF : No audio sounds during sweep.

◇ Sub band mute

Turns the sub band mute function capability ON and OFF (default).

◇ Sub band beep

Turns the sub band busy beep function capability ON and OFF. (default)

◇ Standby Beep

☞ Available only when the UT-123 is installed.

Turns the beep emission capability ON and OFF when the communicating station finishes transmitting or the receive signal disappears while in the DV MODE OPERATION (Optional UT-123 is required). (default: ON)

■ DV GPS items

◇ GPS sentence

- ① Enter the MENU screen in the function guide.
- ② Rotate the main band's **[DIAL]** to select "DV GPS," then push the main band's **[MAIN•BAND]** to enter the sentence formatter selection.
- ③ Rotate **[DIAL]** to select the desired sentence formatter.
 - RMC, GGA, GLL, GSA and VTG are selectable.
- ④ Push **[MAIN•BAND]** to enter the desired sentence formatter selection.
- ⑤ Rotate **[DIAL]** to select the setting, then push **[MAIN•BAND]**.
- ⑥ Rotate **[DIAL]** to select next sentence and repeat steps ③ to ⑤, or push **[F•T•O]** to return to frequency indication.
 - Only three sentence formatters can be activated at same time.

◇ GPS message

See P?? to the chapter 13 for details.

◇ RX GPS message

Selects the data transmission speed for packet operation from 1200 bps (default) and 9600 bps.

◇ GPS TX

GPS transmission function select "ENABLE" or "DISABLE."
(default: ENABLE)

◇ GPS auto TX

Selects the desired interval for automatic position transmission function from 5, 10, 30 second, 1, 3, 5, 10 and 30 minutes.
(default: OFF)

■ PACKET items

◇ Packet BPS

Selects the data transmission speed for packet operation from 1200 bps (default) and 9600 bps.

◇ Packet operation band

Selects the packet operation band from main, right and left.

- MAIN : The main band is used for packet operation.
- L(Left)/R(Right) : The selected left or right band can only be operated for packet.

■ GPS SET MODE items

◇ GPS SPEED

Selects the data transmission speed for packet operation from 4800 bps (default) and 9600 bps.

◇ LINEAR MEASURE

Linear measure function select "m" (default) or "ft/ml."

◇ COMPASS

Compass function select "ARROWHEAD" (default), "NORTH REF", "SOUTH REF."

◇ UTC OFFSET

Selects the UTC offset -12:00 to +12:00. Turn every 5 minutes. (default: 0:00)

◇ GPS DATUM

Selects the GPS datum 0 (default) to 224.

◇ POS AREA1

Selects the data transmission speed for packet operation from 1200 bps (default) and 9600 bps.

◇ POS AREA2

Position area2 select "AUTO" (default), "FAR", "NEAR."

Weather channel operation

U.S.A. version only

Weather channel selection

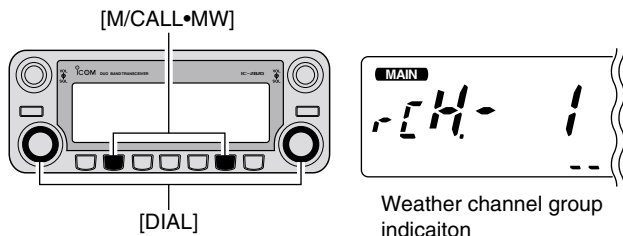

- ① Push the desired band's [M/CALL•MW] several times to select weather channel group.
- ② Rotate the same band's [DIAL] to select the desired weather channel.
- ③ Push the [M/CALL•MW] to select memory mode, or push the main band's [V/MHz•SCAN] to select VFO mode.

Weather alert function

NOAA broadcast stations transmit weather alert tones before important weather announcements. When the weather alert function is turned ON, the selected weather channel is monitored each 5 sec. for the announcement. When the alert signal is detected, the "AL.t" and the WX channel are displayed alternately and sounds a beep tone until the transceiver is operated. The previously selected (used) weather channel is checked periodically during standby or while scanning.

- ① Select the desired weather channel.
- ② Turn the weather alert function ON in set mode.
 - ➔ Push [F•TONE] to enter set mode.
 - ➔ Push [F•TONE] or [LOW•PRIO] to select the weather alert item, then rotate the [DIAL] to set ON.
 - ➔ Push [TONE•DTMF] to exit set mode.
- ③ Sets the desired stand-by condition.
 - Selects VFO, memory or call channel.
 - Scan or priority watch operation can also be selected.
- ④ When the alert is detected, a beep sounds and the following indication will be displayed.

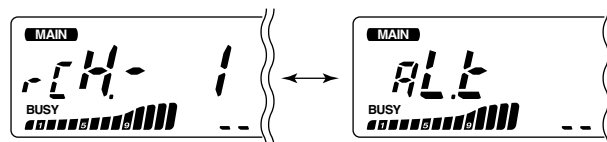

Shows above indications alternately.

- ⑤ Turn the weather alert function OFF in "DUP/TONE" set mode.
- ⚠ **NOTE:** While receiving a signal (on a frequency other than the weather alert ON frequency), the receiving signal or audio will be interrupted momentarily every 5 sec. (approx.) in case the alert function is turned ON. This symptom is caused by the WX alert function. To cancel these symptoms, set the weather alert item OFF in "DUP/TONE" set mode.

■ Microphone keys

The supplied HM-133's (optional for some versions) [F-1] and [F-2] keys memorize the transceiver conditions.

The [UP]/[DN] keys of the standard or an optional microphone (other than the HM-133) can be assigned functions like the function keys on the transceiver's front panel.

◇ [UP]/[DN] keys on a microphones (other than HM-133)

AT POWER ON

The following functions are assigned to the [UP]/[DN] keys on the other microphones (HM-118N/TAN, etc.) when first applying power.

• Default setting

[UP] : channel up; push and hold to start scan, push again to stop scan.

[DN] : channel down; push and hold to start scan, push again to stop scan.

➔ Assigning a function

- ① Turn the power OFF.
- ② While pushing the desired key on the transceiver and one of either [UP]/[DN] keys on the microphone, turn the power ON.
 - The function is programmed into the key.

➔ Clearing an assignment

- ① Turn the power OFF.
- ② While pushing the desired [UP] or [DN] key on the microphone, turn the power ON.

◇ [F-1]/[F-2] keys on HM-133

The following conditions in the main band or both left and right bands can be memorized into [F-1] and [F-2] keys, independently.

- Operating frequency
- Repeater setting (offset direction and frequency, tone ON/OFF and frequency)
- Tone/DTCS squelch (ON/OFF, frequency/code and polarity)
- Transmit output power selection
- Tuning step
- Operating mode selection (FM/AM)
- Set mode settings*
- Initial set mode settings*

*Only when storing both bands conditions

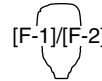

- ➔ **Programming the both bands condition**
After setting the desired contents of each condition in the both bands, push [FUNC] then push [F-1]/[F-2] for 1 sec.
 - 3 beeps sound.

- ➔ **Recalling the both bands condition**
Push [FUNC] then [F-1]/[F-2] momentarily.

- ➔ **Programming the main band condition**
Set the desired contents of each condition in the main band, then push [F-1]/[F-2] for 1 sec.
 - 3 beeps sound.

- ➔ **Recalling the main band condition**
Push [F-1]/[F-2] momentarily.

14 OTHER FUNCTIONS

■ ALL reset

AT POWER ON

The function display may occasionally display erroneous information (e.g. when first applying power). This may be caused externally by static electricity or by other factors.

If this problem occurs, turn power OFF. After waiting a few seconds, turn power ON again. If the problem persists, perform the following procedure.

- Partial resetting is also available. See left for details.

/// IMPORTANT!:

Resetting the transceiver **CLEARs** all memory information and initializes all values in the transceiver.

- ➔ While pushing both band's **[M/CALL•MW]**, turn the power ON to reset the CPU.

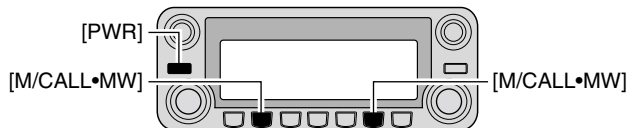

While pushing both **[M/CALL•MW]**, turn power ON.

■ Partial reset

AT POWER ON

If you want to initialize the operating conditions (VFO frequency, VFO settings, menu group's contents) without clearing the memory contents, a partial resetting function is available for the transceiver left and right bands independently.

- ➔ While pushing desired band's **[V/MHz•SCAN]**, turn the power ON to partially reset the desired band (left or right).

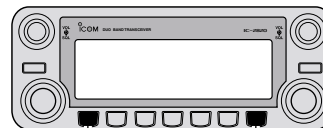

Left band partial reset.

Right band partial reset.

✓ Hint!

When pushing both **[V/MHz•SCAN]** and turning the power ON, partially reset both bands at the same time.

■ Data cloning

AT POWER ON

Cloning allows you to quickly and easily transfer the programmed contents from one transceiver to another; or, data from a personal computer to a transceiver using the optional CS-2820 CLONING SOFTWARE.

◇ Cloning between transceivers

- 1 Connect the OPC-474 cloning cable to the [SP-2] jack of the master and sub-transceivers.
 - The master transceiver is used to send data to the sub-transceiver.

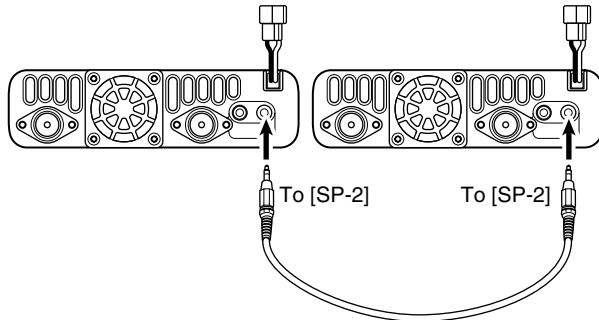

- 2 While pushing left band's **[M/CALL•MW]**, turn power ON to enter cloning mode (master transceiver only— power on only for sub-transceiver).
 - “CLOnE” appears and the transceivers enter the clone standby condition.

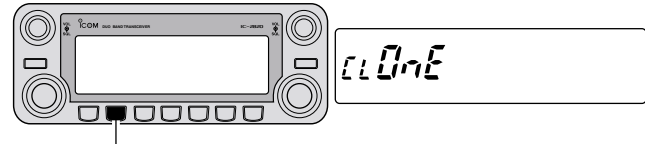

While pushing left band's **[M/CALL•MW]**, turn power ON.

- 3 Push the same **[M/CALL•MW]** on the master transceiver.
 - “CLOnE OUt” appears in the master transceiver's display and the S/Rf indicators show that data is being transferred to the sub-transceiver.
 - “CLOnE In” appears automatically in the sub-transceiver's display and the S/Rf indicators show that data is being received from the master transceiver.

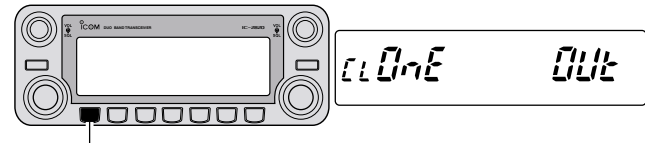

Pushing left band's **[M/CALL•MW]** start cloning.

- 4 When cloning is finished, turn power OFF, then ON to exit cloning mode.

14 OTHER FUNCTIONS

◇ Cloning using a personal computer

Data can be cloned to and from a personal computer (Microsoft® Windows® 98/2000/Me/XP) using the optional CS-2820 CLONING SOFTWARE and the optional cloning cable OPC-478U (USB type) or OPC-478 (RS-232C type). Consult the CS-2820 CLONING SOFTWARE HELP file for details.

◇ Cloning error

NOTE: DO NOT push any key on the sub-transceiver during cloning. This will cause a cloning error.

When the display as below appears, a cloning error has occurred.



In such a case, both transceivers automatically return to the clone standby condition and cloning must be repeated.

■ Packet operation

◇ Data speed

For packet operation, the transceiver can be set to one of two data speeds: 1200 bps (default) or 9600 bps.

- ① While pushing [E•T•O] turn power ON to enter initial set mode.
- ② Push [E•T•O] or [LOW•PRIO] to select the 'bPS' item.
- ③ Rotate the left band [DIAL] to select the desired data speed.



- ④ Push [PWR] to exit initial set mode.

For 1200 bps operation—

- Disconnect the microphone plug from the microphone connector during data transmission, otherwise the data signal and voice signal are simultaneously transmitted.

For 9600 bps operation—

- When the transceiver is set for 9600 bps data transmission in set mode, the microphone signal is automatically cut. Therefore, it is not necessary to disconnect the microphone plug from the connector in this case.
- When pushing [PTT] during data transmission, data transmission is interrupted and voice signals have priority.

◇ DATA JACK PIN ASSIGNMENT

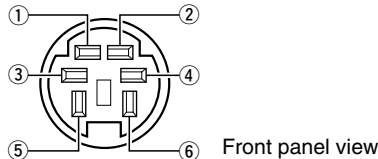

- ① DATA IN
Input terminal for data transmit. See p. ?? for details on how to toggle data speed between 1200 (AFSK) and 9600 bps (G3RUH, GMSK).
- ② GND
Common ground for DATA IN, DATA OUT and AF OUT.
- ③ PTT P
PTT terminal for packet operation only. Connect ground to transmit data.
- ④ DATA OUT
Data out terminal for 9600 bps operation only.
- ⑤ AF OUT
Data out terminal for 1200 bps operation only.
- ⑥ P SQL
Becomes high (+5 V) when the transceiver receives a signal which opens the squelch.
 - To avoid unnecessary TNC transmission, connect squelch to the TNC to inhibit transmission when receiving signals.
 - Keep audio output at a normal level, otherwise a “P SQL” signal will not be output.

◇ 1200 bps packet operation

- ① Connect the transceiver and a TNC as illustrated below.

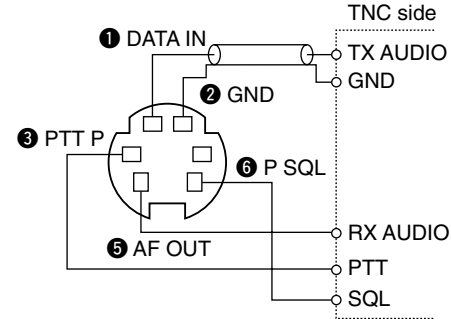

- ② Set the TNC for transmit.
- ③ Set transmit delay on the TNC to 30–50.
- ④ Adjust the TNC frequency deviation if necessary.

- **When using a deviation meter:**

Adjust the output of the TNC so that frequency deviation is in the range ± 3 to ± 4 kHz.

- **When NOT using a deviation meter:**

A receiver or transceiver is needed to monitor the transmission—compare the received audio output level when receiving a TNC modulated signal with high level voice signals using the microphone. Then adjust the TNC modulated signal to a lower level than the voice modulated signal.

14 OTHER FUNCTIONS

- Read the instructions supplied with your TNC carefully before attempting packet operation with the transceiver.
- Pin ⑤ AF OUT is for 1200 bps operation only. This pin cannot be used for 9600 bps operation.
- Over modulation may degrade signal quality. If you find that many transmissions are failing, re-adjust the modulation level.

◇ 9600 bps high speed packet operation

The transceiver supports 2 modes of 9600 bps packet operation: G3RUH and GMSK.

- ① Connect the transceiver and a TNC as illustrated below.

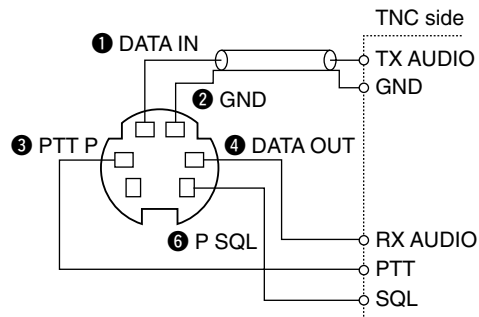

- ② G3RUH mode can handle 16 kinds of modulated wave forms in order to maintain a communication link.
- ③ Set transmit delay on the TNC to 30–50.
- ④ Adjust the TNC frequency deviation if necessary (see page at right).

- When using the PTT P terminal for packet operation, no voice signals are transmitted from the microphone.
- When pushing [PTT] during data transmission, data transmission is interrupted and the voice signal takes priority.
- Read the instructions supplied with your TNC carefully before attempting packet operation with the transceiver.
- Pin ④ DATA OUT is for 9600 bps operation only. This pin cannot be used for 1200 bps operation.

◇ Adjusting the transmit signal output from the TNC

When setting data transmission speed to 9600 bps, the data signal coming from the TNC is applied exclusively to the internal limiter circuitry to automatically maintain band width.

NEVER apply data levels from the TNC of over 0.6 V p-p, otherwise the transceiver will not be able to maintain the band width and may possibly interfere with other stations.

1. When using a level meter or synchroscope, adjust the TX audio output level (DATA IN level) from the TNC as follows.

0.4 V p-p (0.2 V rms)	: recommended level
0.2 V p-p–0.5 V p-p (0.1–0.25 V rms)	: acceptable level

2. When NOT using a measuring device.

- ① Connect the transceiver to a TNC.
- ② Enter a test mode (“CAL”, etc.) on the TNC, then transmit some test data.
- ③ *When the transceiver fails to transmit the test data or transmits sporadically (TX indicator doesn’t appear or flashes):*
 - Decrease the TNC output level until the transmit indicator lights continuously.

When transmission is not successful even though the TX indicator lights continuously:

 - Increase the TNC output level.

13 MAINTENANCE

■ Troubleshooting

If your transceiver seems to be malfunctioning, please check the following points before sending it to a service center.

PROBLEM	POSSIBLE CAUSE	SOLUTION	REF.
Does not turn on.	<ul style="list-style-type: none">• Power connector has a poor contact.• Polarity of the power connection is reversed. • Blown fuse.	<ul style="list-style-type: none">• Check the connector pins.• Re-connect the power cable observing the proper polarity. Replace the fuse if damaged.• Check the cause, then replace the fuse.	— pgs. VI, 74 p. 74
No sound comes from the speaker.	<ul style="list-style-type: none">• Volume is too low.• The audio mute function is activated.• Squelch is set too high.• A selective call or squelch function is activated such as pocket beep or tone squelch.	<ul style="list-style-type: none">• Rotate [VOL] clockwise.• Push any key to deactivate it.• Set the squelch level to the threshold.• Turn the appropriate function OFF.	p. 16 p. 21 p. 16 pgs. 52, 53, 54
Sensitivity is low and only strong signals are audible.	<ul style="list-style-type: none">• Antenna feedline or the antenna connector has a poor contact or is short circuited.• Squelch attenuator function is activated.	<ul style="list-style-type: none">• Check, and if necessary, replace the feedline or solder the antenna connector again.• Set [SQL] between 10–12 o'clock position.	p. VII p. 17
No contact possible with another station.	<ul style="list-style-type: none">• The other station is using tone squelch.• The transceiver is set to duplex.	<ul style="list-style-type: none">• Turn the tone squelch function ON.• Set to simplex.	p. 54 p. 23
Repeater cannot be accessed.	<ul style="list-style-type: none">• Wrong offset frequency is programmed.• Wrong subaudible tone frequency is programmed.	<ul style="list-style-type: none">• Correct the offset frequency.• Correct the subaudible tone frequency.	p. 27 p. 25
Frequency cannot be set.	<ul style="list-style-type: none">• The frequency lock function is activated.• Priority watch is paused on the watching frequency.	<ul style="list-style-type: none">• Turn the function OFF.• Push [LOW•PRIO] for 1 sec. to cancel the watch.	p. 15 p. 47
Frequency cannot be set via the microphone.	<ul style="list-style-type: none">• The frequency lock function is activated.• The microphone keypad lock function is activated.• Priority watch is paused on the watching frequency.	<ul style="list-style-type: none">• Turn the function OFF• Push [FUNC] then [sq]▼#(16KEY-L) to deactivate the microphone keypad lock function.• Push [LOW•PRIO] for 1 sec. to cancel the watch.	p. 15 p. 15 p. 47

PROBLEM	POSSIBLE CAUSE	SOLUTION	REF.
Some memory channels cannot be selected via the tuning dial.	<ul style="list-style-type: none"> The memory channel number has not yet been programmed. 	<ul style="list-style-type: none"> Select the channel via the microphone keypad to check whether the channel has been programmed or not. 	—
Scan does not operate.	<ul style="list-style-type: none"> The squelch is open. Only 1 memory channel is programmed or other channels are set as skip channels. Priority watch is activated. 	<ul style="list-style-type: none"> Set the squelch to the threshold point. Program other memory channels or cancel the memory skip function in the desired channels. Cancel the watch. 	p. 16 pgs. 30, 31, 44 p. 47
Transmission is automatically cut off.	<ul style="list-style-type: none"> Time-out timer is activated. 	<ul style="list-style-type: none"> Set the timer to OFF. 	p. 61
Transmission continues even when the PTT is released.	<ul style="list-style-type: none"> One-touch PTT function is activated. 	<ul style="list-style-type: none"> Turn the function OFF. 	p. 21
The function display shows erroneous information.	<ul style="list-style-type: none"> The CPU is malfunctioning. 	<ul style="list-style-type: none"> Reset the CPU. 	p. 67

■ Fuse replacement

If the fuse blows or the transceiver stops functioning, find the source of the problem if possible, and replace the damaged fuse with a new, rated one (FGB 20 A) as shown at right.

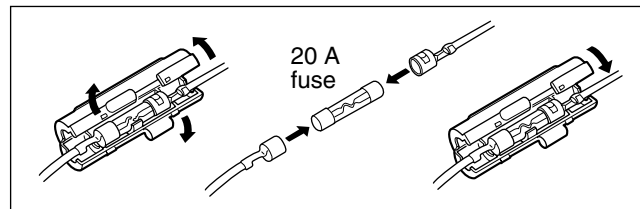

14 SPECIFICATIONS AND OPTIONS

■ Specifications

◇ GENERAL

• Frequency coverage : (unit: MHz)

Version	Left Band	Right Band
USA, General	Rx: 118–549.995* ¹ Tx: 144–148, 430–450* ²	Rx: 118–173.995* ¹ , 375–549.995* ³ 810–999.99* ⁴ Tx: 144–148, 430–450* ²
Australia	Tx/Rx: 144–148, 430–440	
Taiwan	Tx/Rx: 144–146, 430–432	
Korea	Tx/Rx: 144–146, 430–440	

*¹Guaranteed: 144–148 MHz range only.; *²Guaranteed: 440–450 MHz range for the USA, 430–440 MHz for the General version; *³Not guaranteed; *⁴824.010 to 848.990 and 869.010 to 893.990 MHz ranges are inhibited for USA version and not guaranteed.

- Type of emission : FM, AM (Receive only), DV (optional UT-123 is required)
- Number of memory channels : 522 (incl. 20 scan edges and 2 calls)
- Frequency resolution : 5, 6.25, 10, 12.5, 15, 20, 25, 30, 50 kHz
- Operating temperature range : –10°C to +60°C; +14°F to +140°F
- Frequency stability : ±2.5 ppm (–10°C to +60°C)
- Power supply requirement : 13.8 V DC ±15%
- Current drain (at 13.8 V DC: approx.):

Transmit	at 50 W	13 A
Receive	standby	1.2 A
(simultaneous receive)	max. audio	1.8 A
- Antenna connector : SO-239 (50 Ω)×2 (Tx/Rx and Diversity)
- Dimensions (proj. not included) :

Main Unit	150(W) × 40(H) × 187.7(D) mm 5 ²⁹ / ₃₂ (W) × 1 ⁹ / ₁₆ (H) × 7 ¹³ / ₃₂ (D) in
Remote controller	150(W) × 58(H) × 31.5(D) mm 5 ²⁹ / ₃₂ (W) × 2 ⁹ / ₃₂ (H) × 1 ¹ / ₄ (D) in
- Weight (approx.) :

Main unit (incl. separation cable)	1.5 kg; 3 lb 5 oz
Remote controller	210 g; 7.4 oz

◇ TRANSMITTER

- Modulation system : Variable reactance frequency modulation
- Output power : 50/15/5 W* (approx.)
*25/15/5 W only for the Taiwan version.
- Max. frequency deviation : ±5.0 kHz (wide)
±2.5 kHz (narrow)
- Spurious emissions : Less than –60 dB
- Microphone connector : 8-pin modular (600 Ω)

◇ RECEIVER

- Receive system : Double-conversion superheterodyne
- Intermediate frequencies :

Left band	1st: 38.85 MHz, 2nd: 450 kHz
Right band	1st: 46.35 MHz, 2nd: 455 kHz
- Sensitivity (amateur bands only):

FM (12 dB SINAD)	Less than 0.18 μV
DV (BER 1%) (optional UT-123 is required)	Less than 0.35 μV
- Squelch sensitivity[†] (threshold) : Less than 0.13 μV
- Selectivity[†] (typical) :

Wide	More than 10 kHz/6 dB Less than 30 kHz/60 dB
Narrow	More than 6 kHz/6 dB Less than 20 kHz/60 dB
DV (optional UT-123 is required)	More than 50 dB
- Spurious and image rejection[†] : More than 60 dB
*More than 55 dB for UHF on left band.
- AF output power[†] (at 13.8 V DC) : More than 2.4 W at 10% distortion with an 8 Ω load
- Ext. speaker connectors : 3-conductor 3.5 (d) mm (1/8")/8 Ω

[†]Guaranteed 144–148 MHz and 430–440 or 440–450 MHz ranges only.

All stated specifications are subject to change without notice or obligation.

• Sensitivity (for RX bands; for your reference only):

Frequency range	Left band (µV)	Right band (µV)
118–159.995 MHz	0.32/1.0	
160–173.995 MHz	0.56/—	0.56/—
174–179.995 MHz	0.56/—	N/A
180–219.995 MHz	5.6/—	N/A
220–224.995 MHz	0.56/1.8	N/A
225–349.995 MHz	5.6/18	N/A
350–359.995 MHz	0.56/1.8	N/A
360–374.995 MHz	5.6/18	N/A
375–399.995 MHz	0.56/1.8	
400–499.995 MHz	0.32/—	
500–549.995 MHz	0.56/—	
810–879.990 MHz	N/A	0.79 (1.4 for USA)/—
880–999.990 MHz	N/A	1.8 (3.2 for USA)/—

Options

HM-133 REMOTE-CONTROL MICROPHONE

Remote control microphone with key backlight. Same as that supplied with the transceiver.

HM-154 HAND MICROPHONE

OPC-589 ADAPTER CABLE

For using a

OPC-1663/OPC-1712 SEPARATION CABLES

A ferrite core is supplied with the OPC-1155 for the USA version.

Same as that supplied with the transceiver. 3.5 m (11.5 ft)

OPC-1529R DATA COMMUNICATION CABLE

Allows you to slow-speed data communication in DV mode and data cloning operation.

OPC-440/OPC-647 MIC EXTENSION CABLES

OPC-440: 5.0 m (16.4 ft); OPC-647: 2.5 m (8.2 ft)

OPC-441 SPEAKER EXTENSION CABLE

5.0 m (16.4 ft)

SP-10 EXTERNAL SPEAKERS

For all-round mobile operation. Cable length: 1.5 m; 4.9 ft

OPC-347/1132 DC POWER CABLES

OPC-347: 7.0 m (23 ft)

OPC-1132: 3.0 m (9.8 ft) Same as that supplied with the transceiver.

CS-2820 CLONING SOFTWARE

Provides quick and easy programming items, such as memory channels, set mode contents for local repeater frequencies, via PC's RS-232C terminal using with the data communication cable, OPC-1529R. USB type cloning cable, OPC-478U, also available.

OPC-474 CLONING CABLE

Used for data cloning between transceivers.

15 MODE ARRANGEMENT

Count on us!

A-6124D-1EX
Printed in Japan
© 2006 Icom Inc.

Icom Inc.
1-1-32 Kamiminami, Hirano-ku, Osaka 547-0003, Japan