



## INSTRUCTION MANUAL

VHF TRANSCEIVERS

**IC-F3031S**  
**IC-F3033S**  
**IC-F3036S**

UHF TRANSCEIVERS

**IC-F4031S**  
**IC-F4033S**  
**IC-F4036S**

This device complies with Part 15 of the FCC Rules. Operation is subject to the condition that this device does not cause harmful interference.

**Icom Inc.**

**MDC 1200**  
**Compatible**



The photo shows the VHF transceiver

---

## IMPORTANT

---

**READ ALL INSTRUCTIONS** carefully and completely before using the transceiver.

**SAVE THIS INSTRUCTION MANUAL** — This instruction manual contains important operating instructions for the **IC-F3031S, IC-F3033S, IC-F3036S VHF TRANSCEIVERS** and the **IC-F4031S, IC-F4033S, IC-F4036S UHF TRANSCEIVERS**.

This instruction manual includes some functions which are usable only when they are pre-programmed by your dealer. Ask your dealer for details.

***For Canada:***

This device complies with RSS-310 of Industry Canada. Operation is subject to the condition that this device does not cause harmful interference.

Cet appareil est conforme au CNR-310 d'Industrie Canada. Son exploitation est autorisée sous réserve que l'appareil ne cause pas de brouillage préjudiciable.

Icom, Icom Inc. and the Icom logo are registered trademarks of Icom Incorporated (Japan) in Japan, the United States, the United Kingdom, Germany, France, Spain, Russia and/or other countries.

---

## EXPLICIT DEFINITIONS

---

WORD	DEFINITION
<b>⚠ DANGER!</b>	Personal death, serious injury or an explosion may occur.
<b>⚠ WARNING!</b>	Personal injury, fire hazard or electric shock may occur.
<b>CAUTION</b>	Equipment damage may occur.
<b>NOTE</b>	If disregarded, inconvenience only. No risk of personal injury, fire or electric shock.

---

## PRECAUTIONS

---

⚠ **DANGER! NEVER** short the terminals of the battery pack.

⚠ **DANGER!** Use and charge only specified Icom battery packs with Icom radios or Icom chargers. Only Icom battery packs are tested and approved for use with Icom radios or charged with Icom chargers. Using third-party or counterfeit battery packs or chargers may cause smoke, fire, or cause the battery to burst.

⚠ **WARNING! NEVER** hold the transceiver so that the antenna is very close to, or touching exposed parts of the body, especially the face or eyes, while transmitting. The transceiver will perform best if the microphone is 5 to 10 cm (2 to 4 inches) away from the lips and the transceiver is vertical.

⚠ **WARNING! NEVER** operate the transceiver with a headset or other audio accessories at high volume levels. Hearing experts advise against continuous high volume operation. If you experience a ringing in your ears, reduce the volume level or discontinue use.

⚠ **WARNING! NEVER** operate the transceiver while driving a vehicle. Safe driving requires your full attention—anything less may result in an accident.

**CAUTION: MAKE SURE** the flexible antenna, battery pack and jack cover are securely attached to the transceiver, and that the antenna and battery pack are dry before attachment. Exposing the inside of the transceiver to dust or water will result in serious damage to the transceiver.

**DO NOT** operate the transceiver near unshielded electrical blasting caps or in an explosive atmosphere.

**DO NOT** push [PTT] when not actually intending to transmit.

**DO NOT** use or place the transceiver in direct sunlight or in areas with temperatures below  $-30^{\circ}\text{C}$  ( $-22^{\circ}\text{F}$ ) or above  $+60^{\circ}\text{C}$  ( $+140^{\circ}\text{F}$ ).

The basic operations, transmission and reception of the transceiver are guaranteed within the specified operating temperature range. However, the LCD display may not be operate correctly, or show an indication in the case of long hours of operation, or after being placed in extremely cold areas.

**DO NOT** modify the transceiver. The transceiver warranty does not cover any problems caused by unauthorized modification.

**DO NOT** use harsh solvents such as benzine or alcohol when cleaning, as they will damage the transceiver surfaces.

**BE CAREFUL!** The transceiver will become hot when operating it continuously for long periods of time.

---

## PRECAUTIONS (Continued)

---

**BE CAREFUL!** The IC-F3031S, IC-F3033S, IC-F3036S, IC-F4031S, IC-F4033S and IC-F4036S meet IP67\* requirements for dust-tight and waterproof protection. However, once the transceiver has been dropped, dust-tight and waterproof protection cannot be guaranteed because of possible damage to the transceiver's case or the waterproof seal.

\* Only when the jack cover or the optional HM-168LWP is attached.

Even when the transceiver power is OFF, a slight current still flows in the circuits. Remove the battery pack or batteries from the transceiver when not using it for a long time. Otherwise, the installed battery pack or batteries will become exhausted, and will need to be recharged or replaced.

**MAKE SURE** to turn the transceiver power OFF before connecting the supplied/optional equipment.

***For U.S.A. only:***

**CAUTION:** Changes or modifications to this transceiver, not expressly approved by Icom Inc., could void your authority to operate this transceiver under FCC regulations.

---

## FCC INFORMATION

---

**• FOR CLASS A UNINTENTIONAL RADIATORS:**

This equipment has been tested and found to comply with the limits for a Class A digital device, pursuant to part 15 of the FCC Rules. These limits are designed to provide reasonable protection against harmful interference when the equipment is operated in a commercial environment. This equipment generates, uses and can radiate radio frequency energy and, if not installed and used in accordance with the instruction manual, may cause harmful interference to radio communications. Operation of this equipment in a residential area is likely to cause harmful interference in which case the user will be required to correct the interference at his own expense.

---

# TABLE OF CONTENTS

---

IMPORTANT .....	i	<b>4 BATTERY CHARGING .....</b>	<b>15–19</b>
EXPLICIT DEFINITIONS .....	i	■ Caution .....	15
PRECAUTIONS .....	ii	■ Optional battery chargers .....	17
FCC INFORMATION .....	iii	<b>5 OPTIONAL SWIVEL BELT CLIP .....</b>	<b>20–21</b>
TABLE OF CONTENTS .....	iv	■ MB-93 contents .....	20
<b>1 ACCESSORIES .....</b>	<b>1–2</b>	■ Attaching .....	20
■ Supplied accessories .....	1	■ Detaching .....	21
■ Accessory attachments .....	1	<b>6 SPEAKER MICROPHONE .....</b>	<b>22</b>
<b>2 PANEL DESCRIPTION .....</b>	<b>3–7</b>	■ Optional HM-168LWP description .....	22
■ Front panel .....	3	■ Attachment .....	22
■ Function display .....	4	<b>7 OPTIONS .....</b>	<b>23–24</b>
■ Programmable function keys .....	5	<b>8 SAFETY TRAINING INFORMATION .....</b>	<b>25–26</b>
<b>3 BASIC OPERATION .....</b>	<b>8–14</b>		
■ Turning power ON .....	8		
■ Channel selection .....	9		
■ Call procedure .....	9		
■ Receiving and transmitting .....	10		
■ User set mode .....	12		
■ Emergency Call .....	12		
■ Priority A channel selection .....	13		
■ Man Down Emergency Call .....	13		
■ Stun function .....	13		
■ Scrambler function .....	13		
■ MDC 1200 system operation .....	14		

## ■ Supplied accessories

/// **NOTE:** Some accessories are not supplied with depending on versions.

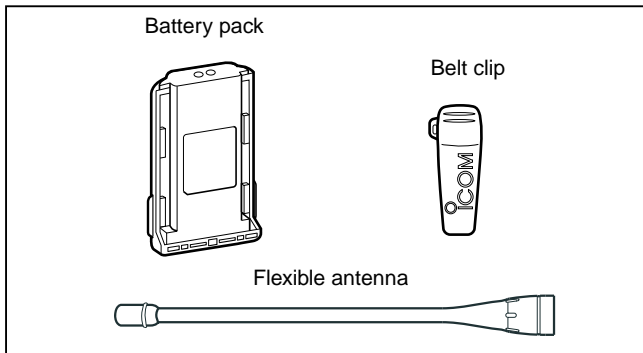

## ■ Accessory attachments

### ◇ Flexible antenna

Connect the supplied flexible antenna to the antenna connector.

#### /// **CAUTION:**

- **NEVER** carry the transceiver by holding the antenna.
- **DO NOT** connect the antenna other than listed on page 24.
- Transmitting without an antenna may damage the transceiver.

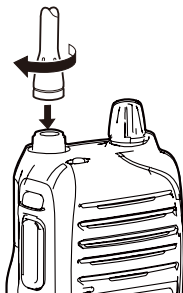

### ◇ Battery pack

#### *To attach the battery pack:*

Slide the battery pack in the direction of the arrow (1) until the battery release button makes a 'click' sound.

/// **NOTE:** Push on the bottom of the pack to make sure the release button is firmly locked.

#### *To release the battery pack:*

Slide the battery release button in the direction of the arrow (2) as shown below. The battery pack is then released.

/// **NEVER** release or attach the battery pack when the transceiver is wet or soiled. This may result water or dust getting into the transceiver/battery pack and may result in the transceiver being damaged.

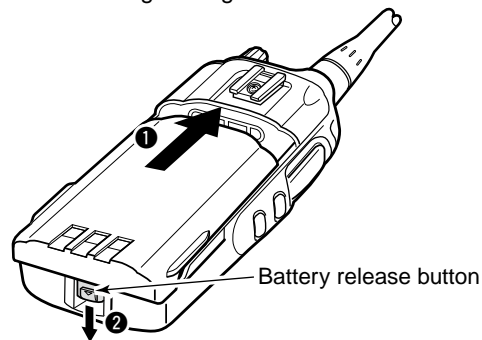

/// **NOTE:** Keep the battery terminals clean. It's a good idea to regularly clean them.

### ◇ Belt clip

#### *To attach the belt clip:*

- ① Release the battery pack if it is attached.
- ② Slide the belt clip in the direction of the arrow until the belt clip is locked and makes a 'click' sound.

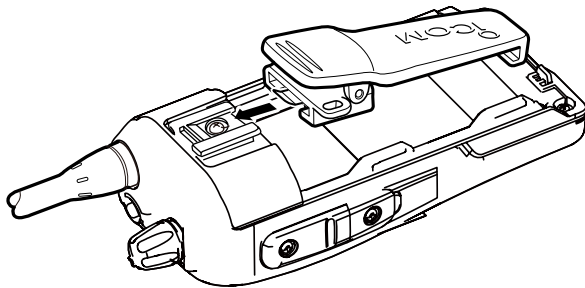

#### *To detach the belt clip:*

- ① Release the battery pack if it is attached.
- ② Pinch the clip (1), and slide the belt clip in the direction of the arrow (2).

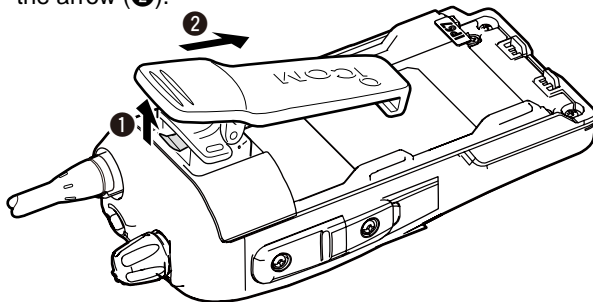

### ◇ Jack cover

#### *To attach the jack cover:*

- ① Attach the jack cover to the [MIC/SP] jack.
- ② Tighten the screws.

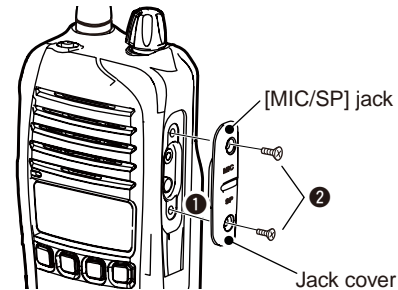

#### CAUTION:

- Attach the jack cover when the optional speaker-microphone is not used.
- Use the supplied screws only.

#### *To detach the jack cover:*

- ① Unscrew the screws using a phillips screwdriver.
- ② Detach the jack cover for the speaker-microphone connection.

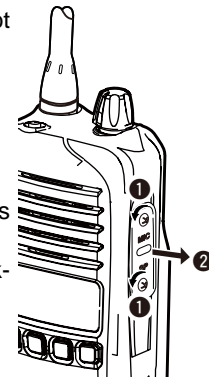

## ■ Front panel

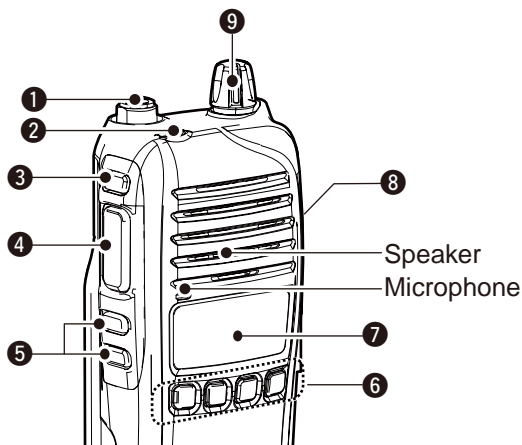

### 1 ANTENNA CONNECTOR

Connects the supplied antenna.

### 2 DEALER-PROGRAMMABLE KEY [Emer]

Desired function can be programmed by your dealer. (p. 7)

### 3 DEALER-PROGRAMMABLE KEY [Side1]

Desired function can be programmed by your dealer. (p. 5)

### 4 PTT SWITCH [PTT]

Push and hold to transmit; release to receive.

### 5 DEALER-PROGRAMMABLE KEYS [Side2]/[Side3]

Desired functions can be programmed independently by your dealer. (p. 5)

### 6 DEALER-PROGRAMMABLE KEYS [P0] to [P3]

Desired functions can be programmed independently by your dealer. (p. 5)

### 7 FUNCTION DISPLAY (p. 4)

Displays a variety of information such as an operating channel number/name, 2-tone code, DTMF numbers, selected function and so on.

### 8 EXTERNAL MICROPHONE/SPEAKER JACK

Connect an optional speaker-microphone.

**NOTE:** Connect or disconnect the optional equipment after the transceiver is turned OFF.

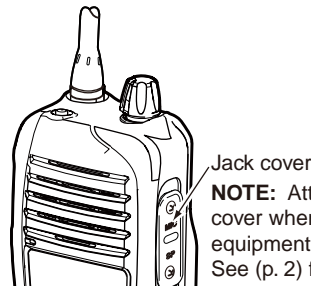

**NOTE:** Attach the jack cover when the optional equipment is not used. See (p. 2) for details.

### 9 VOLUME CONTROL [VOL]

Rotate to turn the power ON/OFF and adjusts the audio level.



## ■ Function display

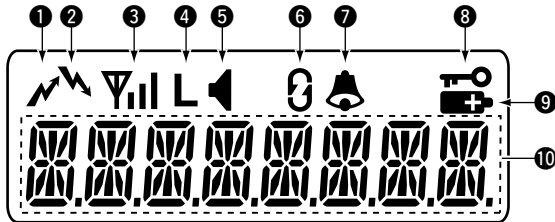

### ❶ TRANSMIT INDICATOR

Appears while transmitting.

### ❷ BUSY INDICATOR

Appears while the channel is busy.

### ❸ SIGNAL STRENGTH INDICATOR

Indicates relative signal strength level.

### ❹ LOW POWER INDICATOR

Appears when low output power is selected.

- When the battery power decreases to a specified level, low power is selected automatically.

### ❺ AUDIBLE INDICATOR

- ➔ Appears when the channel is in the 'audible' (unmute) condition.
- ➔ Appears when the specified 2-tone code is received.

### ❻ SCRAMBLER INDICATOR

Appears when the voice scrambler function is activated.

### ❼ BELL INDICATOR

Appears or blinks when the specific 2-tone code is received, according to the pre-programming.

### ❽ KEY LOCK INDICATOR

Appears during the key lock function is ON.

### ❾ BATTERY INDICATOR

Appears or blinks when the battery power decreases to a specified level.

### ❿ ALPHANUMERIC DISPLAY

Displays an operating channel number, channel name, Set mode contents, DTMF code, etc.

---

## 2 PANEL DESCRIPTION

### ■ Programmable function keys

The following functions can be assigned to **[Emer]**, **[Side1]**, **[Side2]**, **[Side3]**, **[P0]**, **[P1]**, **[P2]** and **[P3]** programmable function keys.

Consult your Icom dealer or system operator for details concerning your transceivers programming.

If the programmable function names are bracketed in the following explanations, the specific key is used to activate the function depends on the programming.

#### **CH UP AND DOWN KEYS**

- Push to select an operating channel.
- Push to select a transmit code channel after pushing [TX Code CH Select].
- Push to select a DTMF channel after pushing [DTMF Audial].
- Push to select a scan group after pushing and holding [Scan A Start/Stop]/[Scan B Start/Stop] for 1 second.

#### **SIREN KEY**

Push to emit a siren.

#### **ZONE KEY**

Push this key, then push [CH Up] or [CH Down] to select the desired zone.

 **What is “zone”?**— The desired channels are assigned into a zone according to the intended use for grouping. For example, ‘Staff A’ and ‘Staff B’ are assigned into a “Business” zone, and ‘John’ and ‘Cindy’ are assigned into a “Private” zone.

#### **SCAN A KEY**

- This key’s operation depends on the Power ON Scan setting.

**When the power ON scan function is turned OFF;**

Push to start and cancel scanning operation. In case of transmission during scan, scanning will be cancelled.

**When the power ON scan function is turned ON;**

Push to pause scanning, then resumes scanning after passing a specified time period. In case of transmission during scan, scanning will be cancelled.

- Push and hold this key for 1 second to indicate the scan group, then push [CH Up] or [CH Down] to select the desired group.

#### **SCAN B KEY**

- Push to start and cancel scanning operation. In case of transmission during scan, scanning will be paused. Then resumes scanning after passing a specified time period.
- Push and hold this key for 1 second to indicate the scan group, then push [CH Up] or [CH Down] to select the desired group.

#### **PRIO A/B KEYS**

- Push to select Priority A or Priority B channel.
- Push and hold [Prio A (Rewrite)] or [Prio B (Rewrite)] for 1 second to reassign the operating channel to Priority A or Priority B channel.

**SCAN ADD/DEL (TAG) KEY**

- Push to add a channel to, or delete it from the current scan list.
  - When a channel is added to the current scan list, the display shows "SCAN ON." When a channel is deleted from the current scan list, the display shows "SCAN OFF." After showing "SCAN ON" or "SCAN OFF," the display shows the current scan list text.
- You can add a channel to, or delete it from the scan list after selecting the list.
  1. Hold down for 1 second to display the current scan list, and then push [CH Up] or [CH Down] to select a desired list.
  2. Push this key to add a channel to, or delete it from the selected list.
  3. Hold down this key for 1 second to exit the scan list selection mode.
- Push this key while a scan is paused on a channel, except for primary or secondary channel, and then the channel is deleted from the scan list.
  - Depending on the setting, the deleted channel is added to the scan list again after the scan is cancelled. (Nuisance Delete function)

**C. TONE CH ENT KEY**

Push to select the continuous tone channel using [CH Up]/[CH Down] to change the tone frequency/code setting. The selected channel remains set as the continuous tone channel until another channel is designated as such.

**MR-CH 1/2/3/4 KEYS**

Push to select memory channels 1 to 4 in the operating zone directly.

**MONI KEY**

Mute and release the CTCSS (DTCS) or 2-tone squelch mute. Open any squelch/deactivate any mute while pushing and holding this key.

**LOCK KEY**

- Push and hold for 1 second to electronically lock all programmable keys except the following: [Call] (incl. Call A and Call B), [Moni], [Emergency], [Surveillance], [Siren], [Lone Worker] and [OPT 1/2/3].
- Push and hold for 1 second again to turn the lock function OFF.

**HIGH/LOW KEY**

Push to select the transmit output power temporarily or permanently, depending on the presetting.

- Ask your dealer for the output power level for each selection.

**OPT MOMENTARY KEYS**

Controls the output signal level of the optional ports in the optional unit connector while pushing and holding this key.

**OPT OUT KEYS**

Push to control the output signal level of the optional ports in the optional unit connector.

**SCRAMBLER FUNCTION**

Push to toggle the voice scrambler function ON and OFF.

---

## 2 PANEL DESCRIPTION

### **TALK AROUND KEY**

Push to turn the talk around function ON and OFF.

- The talk around function equalizes the transmit frequency to the receive frequency for transceiver-to-transceiver communication.

### **WIDE/NARROW KEY**

Push to toggle the IF bandwidth between wide and narrow.

### **DTMF AUTODIAL KEY**

- ➔ Push to enter the DTMF channel selection mode. Then select the desired DTMF channel using [CH Up]/[CH Down].
- ➔ After selecting the desired DTMF channel, push this key to transmit the DTMF code.

### **RE-DIAL KEY**

Push to transmit the last-transmitted DTMF code.

### **CALL KEYS**

Push to transmit a 2-tone.

- Call transmission is necessary before you call another station depending on your signaling system.
- [Call A] and/or [Call B] may be available when your system employs selective 'Individual/Group' calls. Ask your dealer which call is assigned to each key.

### **LONE WORKER KEY**

Push to turn the Lone Worker function ON or OFF.

- If the Lone Worker function is activated, the Emergency function is automatically turned ON after the specified time period has passed with no operation is performed.

### **TX CODE CHANNEL UP/DOWN KEYS**

Push to select a TX code channel directly.

### **EMERGENCY KEY**

Push and hold to transmit the emergency call.

- The transceiver can transmit the emergency call silently or audibly depending on the presetting. Ask your dealer for details.
- When the emergency call transmits with beeps, the emergency text is displayed on the LCD if programmed.
- If you want to cancel the emergency call, push and hold the key again before transmitting the call.
- The emergency call is transmitted one time only or repeatedly until receiving a control code, depending on the presetting.

### **SURVEILLANCE KEY**

Push to turn the surveillance function ON or OFF.

When this function is turned ON, the beep is not emitted and the LCD backlight does not light when a signal is received or a key is pushed, etc.

### **TX CODE CHANNEL SELECT KEY**

Push to enter the ID code channel selection mode directly. Then set the desired channel using [CH Up]/[CH Down]. (p. 11)

### **USER SET MODE KEY**

- ➔ Push and hold for 1 second to enter user set mode.
  - During in the user set mode, push this key to select an item that is enabled by your dealer, and change the value or condition by pushing [CH Up] or [CH Down].
- ➔ Push and hold this key for 1 second again to exit user set mode.

User set mode is also available via the 'Power ON function.' Refer to page 8 also.

## ■ Turning power ON

/// Prior to using the transceiver for the first time, the battery pack must be fully charged for optimum life and operation. (p. 17)

- ① Rotate [VOL] to turn the power ON.
- ② If the transceiver is programmed for a start up password, input the digit codes as directed by your dealer.
  - 10-keypad can be used for password input depending on version:
  - The keys in the table below can be used for password input:
  - The transceiver detects numbers in the same block as identical. Therefore "01234" and "56789" are the same.

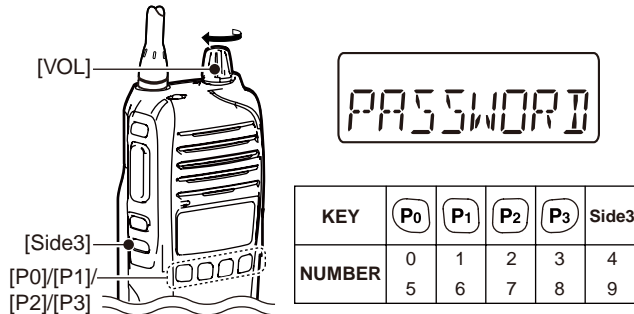

- ③ When the "PASSWORD" indication does not clear after inputting 4 digits, the input code number may be incorrect. Turn the power off and start over in this case.

## ◇ Battery type selection

The battery type must be selected according to the attaching battery type when turning the transceiver ON. Ask your dealer for details.

- ① Turn the power OFF.
- ② While pushing and holding [Emer] and [PTT], turn the power ON with rotating [VOL] to toggle the attaching battery type.
  - After the display appears, release [Emer] and [PTT].
  - "DRY BATT" is displayed for about 3 seconds then "L" appears when the battery case operation is selected. In this case, the transmit output power is low.
  - "LI-ION" is displayed for about 3 seconds when the Lithium-ion battery operation is selected.

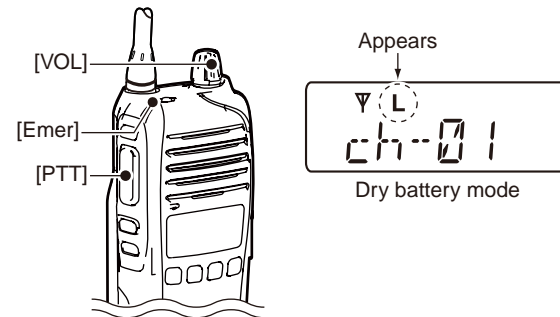

## 3 BASIC OPERATION

### ■ Channel selection

Several types of channel selections are available. Methods may differ according to your system set up.

#### **NON-ZONE TYPE:**

Push [CH Up] or [CH Down] to select the desired operating channel, in sequence; or, push one of [MR-CH 1] to [MR-CH 4] keys to select a channel directly.

#### **ZONE TYPE:**

Push [Zone], then push [CH Up] or [CH Down] to select the desired zone.

#### **AUTOMATIC SCAN TYPE:**

Channel setting is not necessary for this type. When turning power ON, the transceiver automatically starts scanning. Scanning stops when receiving a call.

### ■ Call procedure

When your system employs tone signaling (excluding CTCSS and DTCS), the call procedure may be necessary prior to voice transmission. The tone signaling employed may be a selective calling system which allows you to call specific station(s) and prevent unwanted stations from contacting you.

- ① Select the desired TX code channel or 2-tone code according to your System Operator's instructions.
  - This may not be necessary depending on programming.
  - Refer to page 13 for selection.
- ② Push the call key (assigned to one of the dealer programmable keys: [Emer], [Side1], [Side2], [Side3], [P0], [P1], [P2] and [P3]) or [PTT].
- ③ After transmitting a 2-tone code, the remainder of your communication can be carried out in the normal fashion.

*Selective calling*

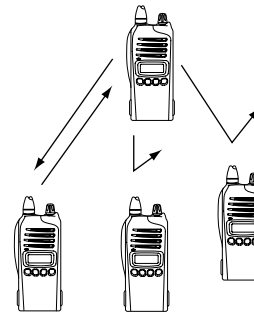

*Non-selective calling*

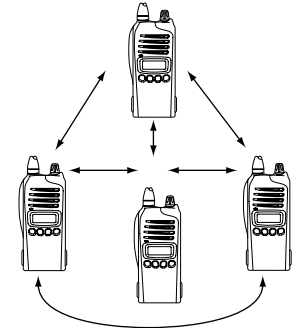

## ■ Receiving and transmitting

**CAUTION:** Transmitting without an antenna may damage the transceiver. See page 1 for accessory attachments.

### Receiving:

- ① Rotate [VOL] to turn the power ON.
- ② Push [CH Up] or [CH Down] to select the conventional system channel, in sequence.
- ③ When receiving a call, adjust the audio output level to a comfortable listening level.

**NOTE:** When a matched RX code signal is received, audio from the microphone is automatically transmitted for a specified time period.\*

\* Depending on the presetting. Ask your dealer for details.

### Transmitting:

Wait for the channel to become clear to avoid interference.

- ① Push [Call] when initiating a call from your side.
  - Coded audio may be heard from the transceiver, then “

**IMPORTANT:** To maximize the readability of your signal;

1. Pause briefly after pushing [PTT].
2. Hold the microphone 5 to 10 cm (2 to 4 inches) from your mouth, then speak into the microphone at a normal voice level.

## ◇ Transmitting notes

### • Transmit inhibit function

The transceiver has several inhibit functions which restrict transmission under the following conditions:

- The channel is in mute condition ('Inaudible' condition; “

### • Time-out timer

After continuous transmission for the pre-programmed time period, the time-out timer is activated, causing the transceiver to stop transmitting.

### • Penalty timer

Once the time-out timer is activated, transmission is further inhibited for a period determined by the penalty timer.

### • PTTID call

The transceiver sends the ID code (DTMF or digital ANI) automatically when [PTT] is pushed (beginning of transmission) and released (end of transmission) depends on the setting.

---

## 3 BASIC OPERATION

### ◇ TX code channel selection

If the transceiver has [TX Code CH Select] assigned to it, the indication can be toggled between the operating channel number (or name) and TX code channel number (or name). When the TX code channel number (or name) is displayed, [CH Up] or [CH Down] selects the TX code channel.

#### **USING [TX CODE CH SELECT] KEY:**

- ① Push [TX Code CH Select]— a TX code channel number (or name) appears.
- ② Push [CH Up] or [CH Down] to select the desired TX code channel.
  - Push [TX Code CH Select] again to return to the operating channel number indication.
- ③ Push [Call] to transmit the selected TX code.

#### **USING [TX CODE CH UP]/[TX CODE CH DOWN] KEY:**

If the transceiver has [TX Code CH Up] or [TX Code CH Down] assignment, the programmed TX code channel can be selected directly when pushed.

### ◇ DTMF transmission

If the transceiver has [DTMF Autodial] assigned to it, the automatic DTMF transmission function is available. Up to 8 DTMF channels are available.

#### **TO SELECT A TX CODE:**

- ① Push [DTMF Autodial]— a DTMF channel appears.
- ② Push [CH Up] or [CH Down] to select the desired DTMF channel.
- ③ Push [DTMF Autodial] to transmit the DTMF code in the selected DTMF channel.



## ■ User set mode

User set mode is accessed at power ON and allows you to set seldom-changed settings. In this case you can “customize” the transceiver operation to suit your preferences and operating style.

### **Entering the user set mode:**

- ① While pushing and holding [Side2] and [Side3], rotate [VOL] to turn the power ON. Then, push and hold [P0] for 1 second to enter user set mode.
- ② Push [P0] several times to select the appropriate item. Then push [CH Up] or [CH Down] to set the desired level/condition.
  - Available set mode functions are **Backlight, Beep, Beep Level, SQL Level, Mic Gain, Battery Voltage, Signal Moni and Lone Worker.**
- ③ Rotate [VOL] to turn the power OFF to exit user set mode.

/// **NOTE:** User set mode is also available via a programmable function key. Refer to “USER SET MODE KEY.” (p. 7)

## ■ Emergency Call

When [Emergency] is pushed for the specified time period\*, the emergency signal is transmitted once, or repeatedly, on the specified emergency channel.

A repeat emergency signal is automatically transmitted until the transceiver receives an acknowledgement signal, or you turn the transceiver power OFF.

When no emergency channel is specified, the signal is transmitted on the previously selected channel.

If you want to cancel the emergency call, hold down [Emergency] again before transmitting the call.

If your transceiver is programmed for Silent operation, you can transmit an Emergency call without the beep sounding and the LED indicator lighting.

/// **IMPORTANT:** It is recommended to set an emergency channel individually to provide the certain emergency call operation.

\* Depending on the presetting. Ask your dealer for details.

### ◇ NOTES

Depending on the presetting, the following functions are automatically activated. Ask your dealer for details.

#### • Auto TX function

After the emergency call transmission, audio from the microphone is automatically transmitted for a specified time period.\*

#### • Auto RX function

After the emergency call transmission, the transceiver stands by in the audible mode for the specified time period.\*

---

## 3 BASIC OPERATION

### ■ Priority A channel selection

Depending on the presetting, the Priority A channel is selected each time the transceiver power is turned ON.

### ■ Man Down Emergency Call

This function requires the optional UT-124R MAN DOWN UNIT. When the transceiver has been left in a horizontal position for the specified time period\*, the transceiver enters the emergency mode, and then the countdown starts.

After the specified time period\* has passed, an emergency call is automatically transmitted once, or repeatedly.

If the transceiver is placed in a vertical position before the first transmission, the transceiver exits the emergency mode and the emergency call is cancelled.

 **IMPORTANT:** It is recommended to set an emergency channel individually to provide the certain emergency call operation.

\* Depending on the presetting. Ask your dealer for details.

### ■ Stun function

When the specified ID, set as a stun ID or kill ID, is received, the stun function is activated.

When the stun ID is received, the transceiver becomes unusable. Entering of the password (p. 8) or receiving a specified ID, set as a revive ID, is necessary to operate the transceiver again in this case.

When the kill ID is received, the transceiver switches to the cloning required condition. Cloning the transceiver is necessary to operate the transceiver again in this case.

Stun function is also available with the MDC 1200 signaling system. (p. 14)

### ■ Scrambler function

The voice scrambler function provides private communication between stations. The optional Rolling or Non-rolling type can be available.

- ① Push [Scrambler] to turn the scrambler function ON.
  - “G” appears.
- ② Push [Scrambler] again to turn the scrambler function OFF.
  - “G” disappears.

## ■ MDC 1200 system operation

The MDC 1200 signaling system enhances your transceiver's capabilities. It allows PTT ID\*, Emergency signaling, and receiving Radio Check. Also, the dispatcher can stun and revive transceivers on the system.

\* When [PTT] is pushed and/or released, the transceiver transmits your station ID.

### ◇ Transmitting an Emergency Call

The MDC 1200 system's Emergency feature can be accessed using the [Emergency] key (p. 7). The transceiver will send an Emergency MDC 1200 system command once, or repeatedly for a programmed number of times until it receives the acknowledgement signal.

The emergency call can be transmitted without a beep sound depending on how the emergency function is programmed. Ask your dealer for details.

### ◇ Receiving an Emergency Call

- ① When an emergency call is received;
  - Beeps sound.
  - The calling station alias and "EMG EMG" are displayed alternately.

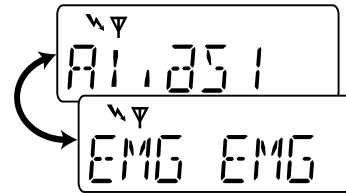

- ② Turn power OFF, change the channel, push [PTT] for replying the call, etc. to stop the beep and display indication.

### ◇ Receiving a Stun and Revive

The dispatcher can send MDC 1200 system signals that will stun or revive your transceiver. If a Stun command is received that matches your station ID, the transceiver will display "SORRY" (default) and you can not receive or transmit. When a Revive command is received that matches your station ID, normal operation is restored.

## ■ Caution

Misuse of Lithium-ion batteries may result in the following hazards: smoke, fire, or the battery may rupture. Misuse can also cause damage to the battery or degradation of battery performance.

⚠ **DANGER!** Use and charge only specified Icom battery packs with Icom radios or Icom charger. Only Icom battery packs are tested and approved for use and charge with Icom radios or Icom charger. Using third-party or counterfeit battery packs or charger may cause smoke, fire, or cause the battery to burst.

### Battery caution

⚠ **DANGER! DO NOT** hammer or otherwise impact the battery. Do not use the battery if it has been severely impacted or dropped, or if the battery has been subjected to heavy pressure. Battery damage may not be visible on the outside of the case. Even if the surface of the battery does not show cracks or any other damage, the cells inside the battery may rupture or catch fire.

⚠ **DANGER! NEVER** use or leave battery packs in areas with temperatures above +60°C (+140°F). High temperature buildup in the battery, such as could occur near fires or stoves, inside a sun heated car, or in direct sunlight may cause the battery to rupture or catch fire. Excessive temperatures may also degrade battery performance or shorten battery life.

⚠ **DANGER! DO NOT** expose the battery to rain, snow, seawater, or any other liquids. Never charge or use a wet battery. If the battery gets wet, be sure to wipe it dry before using.

⚠ **DANGER! NEVER** incinerate used battery packs since internal battery gas may cause them to rupture, or may cause an explosion.

⚠ **DANGER! NEVER** solder the battery terminals or NEVER modify the battery pack. This may cause heat generation, and the battery may rupture, emit smoke or catch fire.

⚠ **DANGER!** Use the battery only with the transceiver for which it is specified. Never use a battery with any other equipment, or for any purpose that is not specified in this instruction manual.

⚠ **DANGER!** If fluid from inside the battery gets in your eyes, blindness can result. Rinse your eyes with clean water, without rubbing them, and see a doctor immediately.

⚠ **WARNING!** Immediately stop using the battery if it emits an abnormal odor, heats up, or is discolored or deformed. If any of these conditions occur, contact your Icom dealer or distributor.

⚠ **WARNING!** Immediately wash, using clean water, any part of the body that comes into contact with fluid from inside the battery.

⚠ **WARNING! NEVER** put the battery in a microwave oven, high-pressure container, or in an induction heating cooker. This could cause a fire, overheating, or cause the battery to rupture.

**CAUTION:** Always use the battery within the specified temperature range,  $-20^{\circ}\text{C}$  to  $+60^{\circ}\text{C}$  ( $-4^{\circ}\text{F}$  to  $+140^{\circ}\text{F}$ ). Using the battery out of its specified temperature range will reduce the battery's performance and battery life.

**CAUTION:** Shorter battery life could occur if the battery is left fully charged, completely discharged, or in an excessive temperature environment (above  $+50^{\circ}\text{C}$ ;  $+122^{\circ}\text{F}$ ) for an extended period of time. If the battery must be left unused for a long time, it must be detached from the radio after discharging. You may use the battery until the remaining capacity is about half, then keep it safely in a cool dry place with the temperature range as below:

$-20^{\circ}\text{C}$  to  $+50^{\circ}\text{C}$  ( $-4^{\circ}\text{F}$  to  $+122^{\circ}\text{F}$ ) (within a month)

$-20^{\circ}\text{C}$  to  $+35^{\circ}\text{C}$  ( $-4^{\circ}\text{F}$  to  $+95^{\circ}\text{F}$ ) (within three months)

### ◇ Charging caution

⚠ **DANGER! NEVER** charge the battery pack in areas with extremely high temperatures, such as near fires or stoves, inside a sun heated car, or in direct sunlight. In such environments, the safety/protection circuit in the battery will activate, causing the battery to stop charging.

⚠ **WARNING! NEVER** charge or leave the battery in the battery charger beyond the specified time for charging. If the battery is not completely charged by the specified time, stop charging and remove the battery from the battery charger. Continuing to charge the battery beyond the specified time limit may cause a fire, overheating, or the battery may rupture.

⚠ **WARNING! NEVER** insert the transceiver (battery attached to the transceiver) into the charger if it is wet or soiled. This could corrode the battery charger terminals or damage the charger. The charger is not waterproof.

**CAUTION: NEVER** charge the battery outside of the specified temperature range: BC-160 and BC-171 ( $0^{\circ}\text{C}$  to  $+45^{\circ}\text{C}$ ;  $+32^{\circ}\text{F}$  to  $+113^{\circ}\text{F}$ ). BC-119N and BC121N ( $+10^{\circ}\text{C}$  to  $+40^{\circ}\text{C}$ ;  $+50^{\circ}\text{F}$  to  $+104^{\circ}\text{F}$ ). Icom recommends charging the battery at  $+20^{\circ}\text{C}$  ( $+68^{\circ}\text{F}$ ). The battery may heat up or rupture if charged out of the specified temperature range. Additionally, battery performance or battery life may be reduced.

## 4 BATTERY CHARGING

### ■ Optional battery chargers

#### ◇ Rapid charging with the BC-160

The optional BC-160 provides rapid charging of the Li-ion battery pack.

- An AC adapter (may be supplied with BC-160 depending on version) or the DC power cable (OPC-515L/CP-23L) is additionally required.

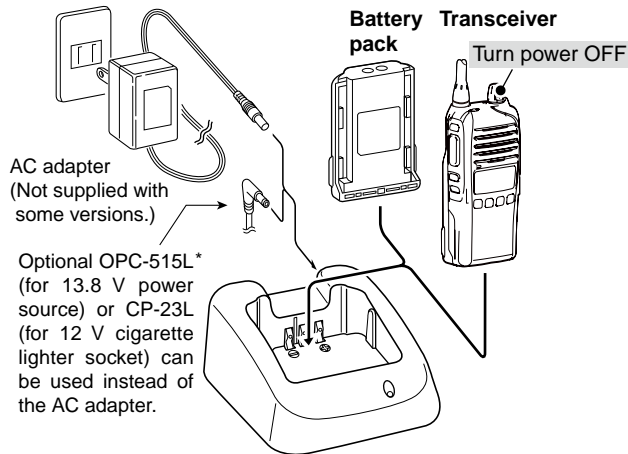

/// **\*CAUTION: NEVER** connect the OPC-515L to a power source using reverse polarity. This will ruin the battery charger.  
/// White line: ⊕ Black line: ⊖

#### ◇ Regular charging with the BC-171

The optional BC-171 provides regular charging of the Li-ion battery pack.

- An AC adapter (may be supplied with BC-171 depending on version) or the DC power cable (OPC-515L/CP-23L) is additionally required.

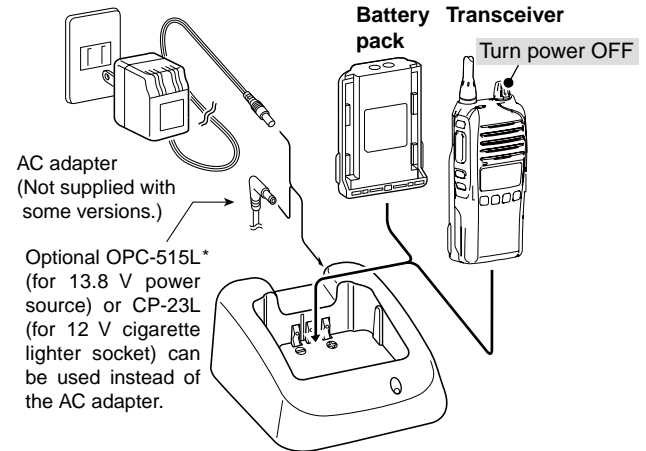

/// **\*CAUTION: NEVER** connect the OPC-515L to a power source using reverse polarity. This will ruin the battery charger.  
/// White line: ⊕ Black line: ⊖

◇ **AD-106 installation**

The AD-106 CHARGER ADAPTER must be installed into the BC-119N or BC-121N before battery charging.

- Connect the AD-106 CHARGER ADAPTER and the BC-119N/BC-121N as below, then install the AD-106 into the holder space of the BC-119N or BC-121N with the supplied screws.

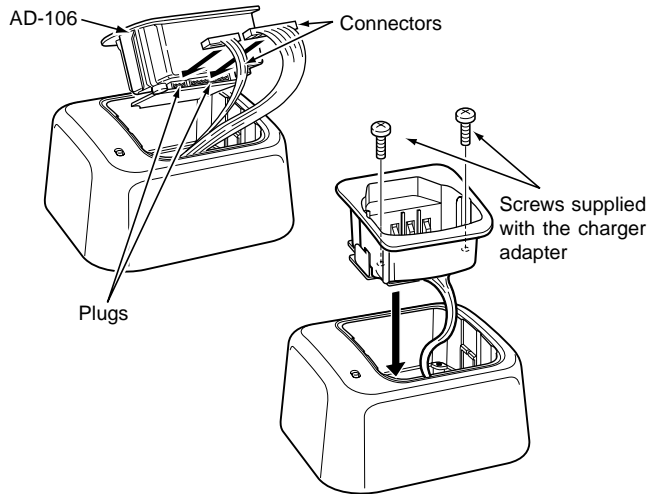

\* This illustration is described with the BC-119N.

◇ **Rapid charging with the BC-119N+AD-106**

The optional BC-119N provides rapid charging of the Li-ion battery pack. The following items are additionally required.

- AD-106 charger adapter
- An AC adapter (may be supplied with BC-119N depending on version) or the DC power cable (OPC-515L/CP-23L).

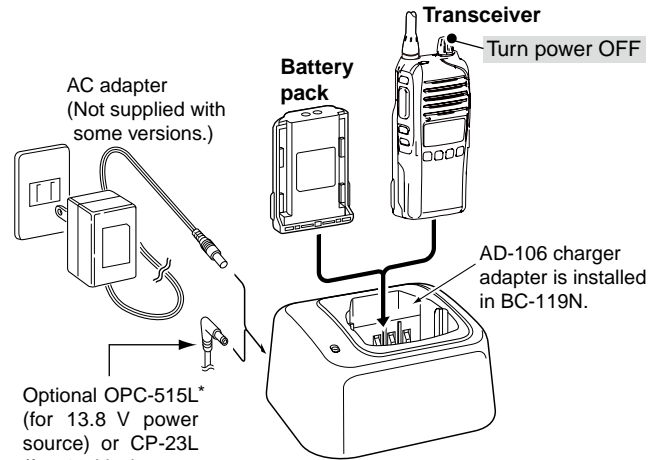

Optional OPC-515L\* (for 13.8 V power source) or CP-23L (for 12 V cigarette lighter socket) can be used instead of the AC adapter.

/// **\*CAUTION: NEVER** connect the OPC-515L to a power source using reverse polarity. This will ruin the battery charger.  
 /// White line: ⊕ Black line: ⊖

## 4 BATTERY CHARGING

### ◇ Rapid charging with the BC-121N+AD-106

The optional BC-121N allows up to 6 Li-ion battery packs to be charged simultaneously. The following items are additionally required.

- Six AD-106 charger adapters
- An optional AC adapter or the DC power cable (OPC-656)

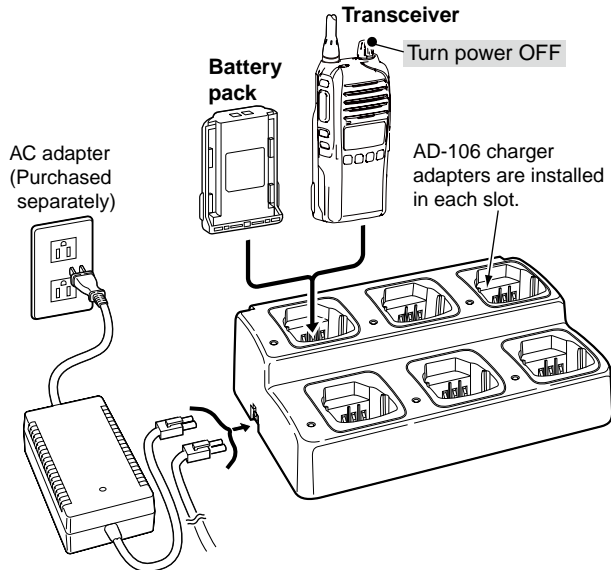

DC power cable (OPC-656)  
(Connect with the DC power supply; 13.8 V/at least 7 A)

\*About the OPC-656  
Red line : ⊕ Black line : ⊖

### /// IMPORTANT: Battery charging caution

Ensure the guide tabs on the battery pack are correctly aligned with the guide rails inside the charger adapter.  
(This illustration is described with the BC-160.)

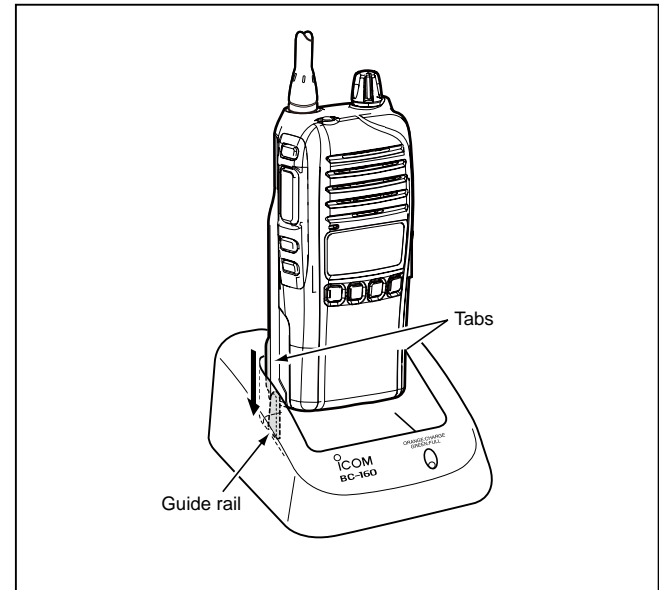



## ■ MB-93 contents

- |                   | Qty. |
|-------------------|------|
| ① Belt clip ..... | 1    |
| ② Base clip ..... | 1    |

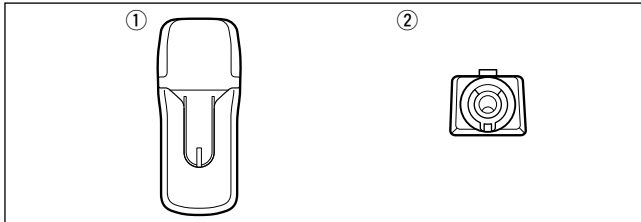

## ■ Attaching

- ① Release the battery pack if it is attached. (p. 2)
- ② Slide the base clip in the direction of the arrow until the base clip is locked and makes a 'click' sound.

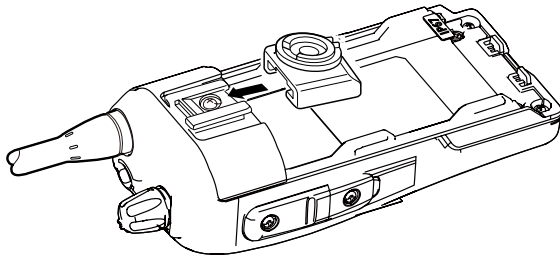

- ③ Attach the battery pack. (p. 2)

- ④ Clip the belt clip to a part of your belt. And insert the transceiver into the belt clip until the base clip inserted fully into the groove.

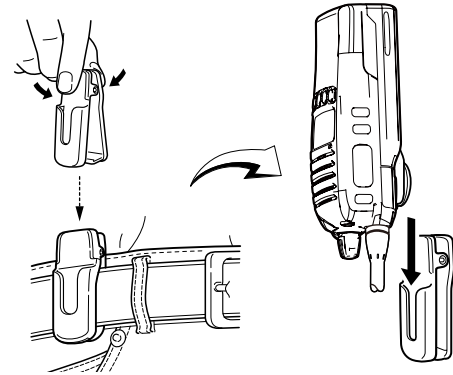

- ⑤ Once the transceiver is locked in place, it swivels as illustrated below.

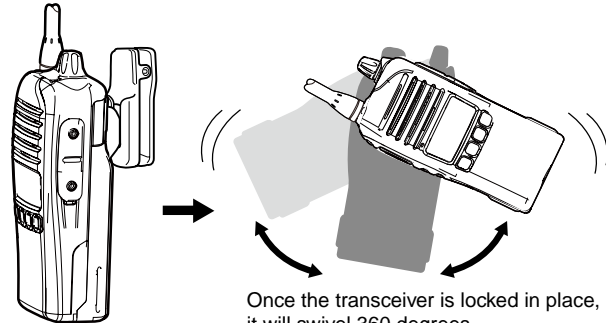

Once the transceiver is locked in place, it will swivel 360 degrees.

## 5 OPTIONAL SWIVEL BELT CLIP

### ■ Detaching

- ① Turn the transceiver upside down in the direction of the arrow and pull out from the belt clip.

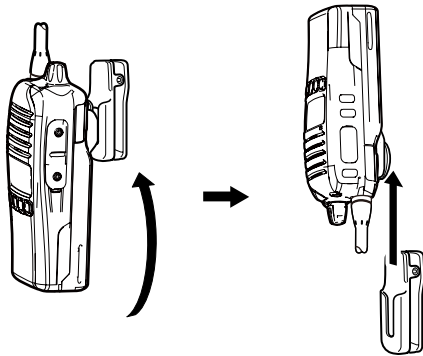

- ② Release the battery pack if it is attached. (p. 2)
- ③ Pinch the clip (①), and slide the base clip in the direction of the arrow (②).

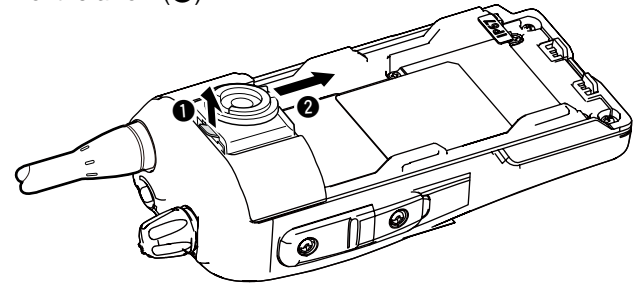

**CAUTION:**  
**HOLD THE TRANSCEIVER TIGHTLY, WHEN HANGING OR DETACHING THE TRANSCEIVER FROM THE BELT CLIP.**  
Otherwise the transceiver may not be attached to the holder or swivel properly if the transceiver is accidentally dropped and the base clip is scratched or damaged.

## Optional HM-168LWP description

### Alligator type clip

To attach the speaker-mic. to your shirt or collar, etc.

### PTT switch

Transmits while pushed  
Receives while released

### Microphone

### Speaker

Turn the transceiver power OFF when connecting the HM-168LWP.

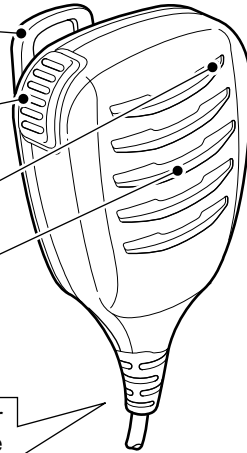

## Attachment

Attach the connector of the speaker-microphone into the [SP MIC] jack on the transceiver and tighten the screws with fingers.

**NOTE:** Use only your fingers instead of tools to tighten the screws.

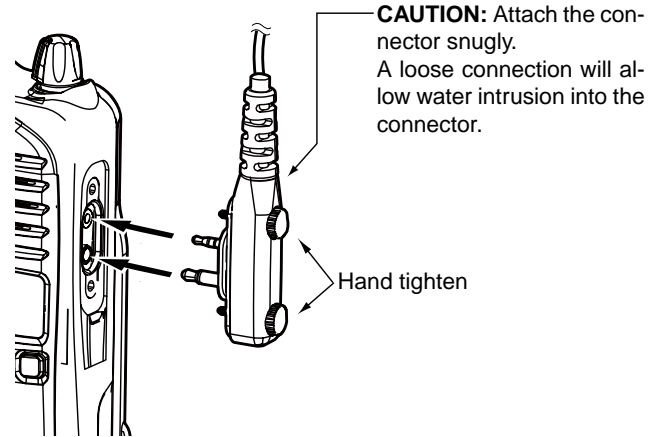

**IMPORTANT:** Keep the [SP MIC] jack cover attached to the transceiver when the speaker-microphone is not in use.

**NEVER** immerse the connector in water. If the connector becomes wet, be sure to dry it BEFORE attaching it to the transceiver.

**NOTE:** The microphone is located as shown in the diagram above. To maximize the readability of your transmitted signal (voice), hold the microphone approximately 5 to 10 cm (2 to 4 inches) from your mouth, and speak in a normal voice level.

### ◇ BATTERY PACK

Battery pack	Voltage	Capacity	Battery life*1
<b>BP-232WP</b>	7.4 V	2250 mAh (min.) 2300 mAh (typ.)	17.5 hrs.

\*1 When the power save function is turned ON, and the operating periods are calculated under the following conditions;

TX : RX : standby = 5 : 5 : 90

\*2 Operating period depends on the alkaline cells used.

### ◇ CHARGERS

• **BC-119N** DESKTOP CHARGER + **AD-106** CHARGER ADAPTER + **BC-145S** AC ADAPTER

For rapid charging of battery packs. An AC adapter is supplied with the charger depending on versions.

Charging time: approximately 3 hours when BP-232WP is attached.

• **BC-121N** MULTI-CHARGER + **AD-106** CHARGER ADAPTER (6 pcs.) + **BC-157S** AC ADAPTER

For rapid charging of up to 6 battery packs (six AD-106's are required) simultaneously. An AC adapter should be purchased separately.

Charging time: approximately 3 hours when BP-232WP is attached.

• **BC-160** DESKTOP CHARGER + **BC-145S** AC ADAPTER

For rapid charging of battery packs. An AC adapter is supplied with the charger depending on versions.

Charging time: approximately 3 hours when BP-232WP is attached.

• **BC-171** DESKTOP CHARGER + **BC-147S** AC ADAPTER

An AC adapter is supplied with the charger depending on versions.

Charging time: approximately 10 hours when BC-232WP is attached.

### ◇ DC CABLES

• **CP-23L** CIGARETTE LIGHTER CABLE

Allows charging of the battery pack through a 12 V cigarette lighter socket. (For BC-160/BC-171/BC-119N)

• **OPC-515L/OPC-656** DC POWER CABLES

Allows charging of the battery pack using a 13.8 V power source instead of the AC adapter.

OPC-515L: For BC-160/BC-171/BC-119N

OPC-656 : For BC-121N

### ◇ BELT CLIPS

• **MB-93** SWIVEL BELT CLIP

• **MB-94** BELT CLIP

Exclusive alligator-type belt clip. The same as supplied with the transceiver.

• **MB-96N/96F** LEATHER BELT HANGER

◇ **OPTIONAL UNITS**

- **UT-96R** 5 TONE UNIT
- **UT-108R** DTMF DECODER UNIT  
Provides pager and code squelch capabilities.
- **UT-109R /UT-110R\*** VOICE SCRAMBLER UNITS  
Non-rolling type (UT-109R)/Rolling type (UT-110R)\* voice scrambler unit provides higher communication security.  
\*You can use the UT-110R as Non-rolling type.
- **UT-124R** MAN DOWN UNIT  
Provides measure of safety when working in a hazardous environment, etc.

◇ **OTHER OPTIONS**

- **HM-168LWP** SPEAKER-MICROPHONE  
Combination speaker-microphone that provides convenient operation while hanging the transceiver from your belt.
- **FA-SC25V/FA-SC55V/  
FA-SC25U/FA-SC57U/FA-SC72U/  
FA-SC62V/FA-SC63V** ANTENNAS  
FA-SC25V: 136–150 MHz      FA-SC55V: 150–174 MHz  
FA-SC25U: 400–430 MHz      FA-SC57U: 430–470 MHz  
FA-SC72U: 470–520 MHz      FA-SC62V: 150–160 MHz  
FA-SC63V: 155–165 MHz
- **FA-SC56VS/FA-SC57VS/FA-SC73US** STUBBY ANTENNAS  
FA-SC56VS: 150–162 MHz      FA-SC57VS: 160–174 MHz  
FA-SC73US: 450–490 MHz
- **FA-SC61VC/FA-SC61UC** CUT ANTENNAS  
FA-SC61VC: 136–174 MHz      FA-SC61UC: 380–520 MHz

Some options may not be available in some countries. Ask your dealer for details.

Approved Icom optional equipment is designed for optimal performance when used with an Icom transceiver. Icom is not responsible for the destruction or damage to an Icom transceiver in the event the Icom transceiver is used with equipment that is not manufactured or approved by Icom.



Your Icom radio generates RF electromagnetic energy during transmit mode. This radio is designed for and classified as “Occupational Use Only”, meaning it must be used only during the course of employment by individuals aware of the hazards, and the ways to minimize such hazards. This radio is NOT intended for use by the “General Population” in an uncontrolled environment. This radio has been tested and complies with the FCC RF exposure limits for “Occupational Use Only”. In addition, your Icom radio complies with the following Standards and Guidelines with regard to RF energy and electromagnetic energy levels and evaluation of such levels for exposure to humans:

- FCC OET Bulletin 65 Edition 97-01 Supplement C, Evaluating Compliance with FCC Guidelines for Human Exposure to Radio Frequency Electromagnetic Fields.
- American National Standards Institute (C95.1-1992), IEEE Standard for Safety Levels with Respect to Human Exposure to Radio Frequency Electromagnetic Fields, 3 kHz to 300 GHz.
- American National Standards Institute (C95.3-1992), IEEE Recommended Practice for the Measurement of Potentially Hazardous Electromagnetic Fields— RF and Microwave.
- The following accessories are authorized for use with this product. Use of accessories other than those specified may result in RF exposure levels exceeding the FCC requirements for wireless RF exposure.; Belt Clip (MB-93, MB-94 and MB-96N/F), Rechargeable Li-ion Battery Pack (BP-232WP) and Speaker-microphone (HM-168LWP).



**To ensure that your exposure to RF electromagnetic energy is within the FCC allowable limits for occupational use, always adhere to the following guidelines:**

- **DO NOT** operate the radio without a proper antenna attached, as this may damaged the radio and may also cause you to exceed FCC RF exposure limits. A proper antenna is the antenna supplied with this radio by the manufacturer or antenna specifically authorized by the manufacturer for use with this radio.
- **DO NOT** transmit for more than 50% of total radio use time (“50% duty cycle”). Transmitting more than 50% of the time can cause FCC RF exposure compliance requirements to be exceeded. The radio is transmitting when the TX indicator lights red. You can cause the radio to transmit by pressing the “PTT” switch.
- **ALWAYS keep** the antenna at least 2.5 cm (1 inch) away from the body when transmitting and only use the Icom belt-clips listed on page 23 when attaching the radio to your belt, etc., to ensure FCC RF exposure compliance requirements are not exceeded. To provide the recipients of your transmission the best sound quality, hold the antenna at least 5 cm (2 inches) from your mouth, and slightly off to one side.

The information listed above provides the user with the information needed to make him or her aware of RF exposure, and what to do to assure that this radio operates with the FCC RF exposure limits of this radio.

#### **Electromagnetic Interference/Compatibility**

During transmissions, your Icom radio generates RF energy that can possibly cause interference with other devices or systems. To avoid such interference, turn off the radio in areas where signs are posted to do so. **DO NOT** operate the transmitter in areas that are sensitive to electromagnetic radiation such as hospitals, aircraft, and blasting sites.

#### **Occupational/Controlled Use**

The radio transmitter is used in situations in which persons are exposed as consequence of their employment provided those persons are fully aware of the potential for exposure and can exercise control over their exposure.

**AVERTISSEMENT**

Votre radio Icom produit une énergie électromagnétique de radiofréquences (RF), en mode de transmission. Cette radio est conçue pour un «usage professionnel seulement» et classée comme tel, ce qui signifie qu'elle doit être utilisée uniquement dans le cadre d'un travail par des personnes conscientes des dangers et des mesures visant à minimiser ces dangers. Elle N'EST PAS conçue pour une «utilisation grand public», dans un environnement non contrôlé.

Cet appareil a été évalué et jugé conforme, aux limites d'exposition aux RF de la FCC, pour une «utilisation grand public». En outre, votre radio Icom satisfait les normes et directives qui suivent en matière de niveaux d'énergie et d'énergie électromagnétique de RF et d'évaluation de tels niveaux en ce qui concerne l'exposition humaine:

- Supplément C, édition 97-01, du Bulletin OET n° 65 de la FCC, «Evaluating Compliance with FCC Guidelines for Human Exposure to Radio Frequency Electromagnetic Fields».
- Norme de l'American National Standards Institute (ANSI): IEEE C95.1-1992 sur les niveaux de sécurité compatibles avec l'exposition humaine aux champs électromagnétiques de radiofréquences (3 kHz à 300 GHz).
- Norme de l'ANSI: IEEE C95.3-1992 sur la méthode d'évaluation recommandée du champ magnétique potentiellement dangereux des radiofréquences et des micro-ondes.
- Les accessoires illustrés à la p. 23-24 sont approuvés pour une utilisation avec ce produit. L'utilisation d'accessoires autres que ceux précisés peut entraîner des niveaux d'exposition aux RF supérieures aux limites établies par la FCC en matière d'exposition aux RF sans fil.

**MISE EN GARDE**

**Afin de vous assurer que votre exposition à une énergie électromagnétique de RF se situe dans les limites permises par la FCC pour une utilisation grand public, veuillez en tout temps respecter les directives suivantes:**

- **NE PAS** faire fonctionner la radio sans qu'une antenne appropriée y soit fixée, car ceci risque d'endommager la radio et causer une exposition supérieure aux limites établies par la FCC. L'antenne appropriée est celle qui est fournie avec cette radio par le fabricant ou une antenne spécialement autorisée par le fabricant pour être utilisée avec cette radio.
- **NE PAS** émettre pendant plus de 50 % du temps total d'utilisation de l'appareil («50 % du facteur d'utilisation»). La notion «50% du facteur d'utilisation» s'applique également au mode VOX/PTT. Émettre pendant plus de 50 % du temps total d'utilisation peut causer une exposition aux RF supérieure aux limites établies par la FCC. Lorsque le voyant DEL rouge s'allume, cette radio est en train d'émettre. La radio émettra si vous appuyez sur le bouton du microphone.
- **TOUJOURS tenir** l'antenne éloignée d'au moins 2,5 cm de votre corps au moment d'émettre et utiliser uniquement l'attache pour ceinture Icom illustrée à la p. 23, lorsque vous attachez la radio à votre ceinture, ou à autre chose, de façon à vous assurer de ne pas provoquer une exposition aux RF supérieure aux limites fixées par la FCC. Pour offrir à vos interlocuteurs la meilleure qualité de transmission possible, tenez l'antenne à au moins 5 cm de votre bouche et légèrement de côté.

Les renseignements ci-dessus fournissent à l'utilisateur toute l'information nécessaire sur l'exposition aux RF et sur ce qu'il faut faire pour assurer que cette radio fonctionne en respectant les limites d'exposition aux RF établies par la FCC.

**Interférence électromagnétique et compatibilité**

En mode de transmission, votre radio Icom produit de l'énergie de RF qui peut provoquer des interférences avec d'autres appareils ou systèmes. Pour éviter de telles interférences, mettez la radio hors tension dans les secteurs où une signalisation l'exige. **NE PAS** faire fonctionner l'émetteur dans des secteurs sensibles au rayonnement électromagnétique tels que les hôpitaux, les aéroports et les sites de dynamitage.

**Usage professionnel/contrôlé**

Ce radio émetteur est utilisé dans des cas où des personnes sont exposées en raison de leur travail, pourvu qu'elles soient conscientes du risque d'exposition et qu'elles puissent exercer un contrôle sur cette exposition.

**Count on us!**

A-6995D-1EX  
Printed in Japan  
© 2012 Icom Inc.

Printed on recycled paper with soy ink.

**Icom Inc.**

1-1-32 Kamiminami, Hirano-ku, Osaka 547-0003, Japan