



## INSTRUCTION MANUAL

# VHF MARINE TRANSCEIVER IC-M504



Icom Inc.

---

## FOREWORD

---

Thank you for purchasing this Icom product. The IC-M504 VHF MARINE TRANSCEIVER is designed and built with Icom's state of the art technology and craftsmanship. With proper care, this product should provide you with years of trouble-free operation.

We want to take a couple of moments of your time to thank you for making the IC-M504 your radio of choice, and hope you agree with Icom's philosophy of "technology first." Many hours of research and development went into the design of your IC-M504.

### ◇ **FEATURES**

- *Simple operation with large keys*
- *Easy to hear speaker*
- *Built-in DSC meets ITU Class D requirement*
- *Rugged waterproof construction*
- *Optional COMMANDMIC (HM-157/HM-162) are available*

Icom, Icom Inc. and the ICOM logo are registered trademarks of Icom Incorporated (Japan) in the United States, the United Kingdom, Germany, France, Spain, Russia and/or other countries.

COMMANDMIC II and COMMANDMIC III is a trademark of Icom Incorporated (Japan) in the United States.

---

## IMPORTANT

---

**READ ALL INSTRUCTIONS** carefully and completely before using the transceiver.

**SAVE THIS INSTRUCTION MANUAL** — This instruction manual contains important operating instructions for the IC-M504.

---

## EXPLICIT DEFINITIONS

---

WORD	DEFINITION
⚠ <b>WARNING!</b>	Personal injury, fire hazard or electric shock may occur.
<b>CAUTION</b>	Equipment damage may occur.
<b>NOTE</b>	Recommended for optimum use. No risk of personal injury, fire or electric shock.

**CLEAN THE TRANSCEIVER AND MICROPHONE THOROUGHLY WITH FRESH WATER** after exposure to water including salt water, otherwise, the keys and switch may become inoperable due to salt crystallization.

---

## IN CASE OF EMERGENCY

---

If your vessel requires assistance, contact other vessels and the Coast Guard by sending a Distress call on Channel 16.

### ***USING CHANNEL 16***

#### **DISTRESS CALL PROCEDURE**

1. "MAYDAY MAYDAY MAYDAY."
2. "THIS IS ....." (name of vessel).
3. Say your call sign or other indication of the vessel (AND 9-digit DSC ID if you have one).
4. "LOCATED AT ....." (your position).
5. State the nature of the distress and assistance required.
6. Give any other information which might facilitate the rescue.

Or, transmit your Distress call using digital selective calling on Channel 70.

### ***USING DIGITAL SELECTIVE CALLING (Ch 70)***

#### **DISTRESS CALL PROCEDURE**

1. While lifting up the key cover, push and hold **[DISTRESS]** for 5 sec. until you hear 5 short beeps change to one long beep.
2. Wait for an acknowledgment on Channel 70 from a coast station.
  - After the acknowledgement is received, Channel 16 is automatically selected.
3. Push and hold **[PTT]**, then transmit the appropriate information as listed above.

---

## NOTE

---

**A WARNING STICKER** is supplied with the transceiver. To comply with FCC regulations, this sticker must be affixed in such a location as to be readily seen from the operating controls of the radio as in the diagram below. Make sure the chosen location is clean and dry before applying the sticker.

### EXAMPLE

---

## RADIO OPERATOR WARNING

---



Icom requires the radio operator to meet the FCC Requirements for Radio Frequency Exposure. An omnidirectional antenna with gain not greater than 9 dBi must be mounted a minimum of 5 meters (measured from the lowest point of the antenna) vertically above the main deck and

all possible personnel. This is the minimum safe separation distance estimated to meet all RF exposure compliance requirements. This 5 meter distance is based on the FCC Safe Maximum Permissible Exposure (MPE) distance of 3 meters added to the height of an adult (2 meters) and is appropriate for all vessels.

For watercraft without suitable structures, the antenna must be mounted so as to maintain a minimum of 1 meter vertically between the antenna, (measured from the lowest point of the antenna), to the heads of all persons AND all persons must stay outside of the 3 meter MPE radius.

Do not transmit with radio and antenna when persons are within the MPE radius of the antenna, unless such persons (such as driver or radio operator) are shielded from antenna field by a grounded metallic barrier. The MPE Radius is the minimum distance from the antenna axis that person should maintain in order to avoid RF exposure higher than the allowable MPE level set by FCC.

**FAILURE TO OBSERVE THESE LIMITS MAY ALLOW THOSE WITHIN THE MPE RADIUS TO EXPERIENCE RF RADIATION ABSORPTION WHICH EXCEEDS THE FCC MAXIMUM PERMISSIBLE EXPOSURE (MPE) LIMIT. IT IS THE RESPONSIBILITY OF THE RADIO OPERATOR TO ENSURE THAT THE MAXIMUM PERMISSIBLE EXPOSURE LIMITS ARE OBSERVED AT ALL TIMES DURING RADIO TRANSMISSION. THE RADIO OPERATOR IS TO ENSURE THAT NO BYSTANDERS COME WITHIN THE RADIUS OF THE MAXIMUM PERMISSIBLE EXPOSURE LIMITS.**

### **Determining MPE Radius**

**THE MAXIMUM PERMISSIBLE EXPOSURE (MPE) RADIUS HAS BEEN ESTIMATED TO BE A RADIUS OF ABOUT 3M PER OET BULLETIN 65 OF THE FCC. THIS ESTIMATE IS MADE ASSUMING THE MAXIMUM POWER OF THE RADIO AND ANTENNAS WITH A MAXIMUM GAIN OF 9dBi ARE USED FOR A SHIP MOUNTED SYSTEM.**

---

# TABLE OF CONTENTS

---

FOREWORD .....	i	■ Position and time programming .....	21
IMPORTANT .....	i	■ Position and time indication .....	22
EXPLICIT DEFINITIONS .....	i	■ Distress call .....	23
IN CASE OF EMERGENCY .....	ii	■ Transmitting DSC calls .....	26
NOTE .....	ii	■ Receiving DSC calls .....	41
RADIO OPERATOR WARNING .....	iii	■ Received messages .....	45
TABLE OF CONTENTS .....	iv	■ DSC Set mode .....	47
PRECAUTIONS .....	v	<b>7 OTHER FUNCTIONS .....</b>	<b>50–54</b>
<b>1 OPERATING RULES .....</b>	<b>1</b>	■ Intercom operation .....	50
<b>2 PANEL DESCRIPTION .....</b>	<b>2–5</b>	■ RX Speaker function .....	51
■ Front panel .....	2	■ Hailer operation .....	52
■ Function display .....	4	■ Automatic foghorn function .....	53
■ Microphone .....	5	<b>8 SET MODE .....</b>	<b>55–57</b>
<b>3 BASIC OPERATION .....</b>	<b>6–11</b>	■ Set mode programming .....	55
■ Channel selection .....	6	■ Set mode items .....	55
■ Receiving and transmitting .....	8	<b>9 CONNECTIONS AND MAINTENANCE .....</b>	<b>58–64</b>
■ Call channel programming .....	9	■ Connections .....	58
■ Channel comments .....	10	■ Supplied accessories .....	59
■ Microphone Lock function .....	10	■ Antenna .....	59
■ Display backlight .....	10	■ Fuse replacement .....	59
■ Optional voice scrambler operation .....	11	■ Mounting the transceiver .....	60
<b>4 SCAN OPERATION .....</b>	<b>12–13</b>	■ MB-75 installation .....	61
■ Scan types .....	12	■ UT-98/UT-112 installation .....	62
■ Setting TAG channels .....	13	■ HM-157/HM-162 installation .....	63
■ Starting a scan .....	13	<b>10 TROUBLESHOOTING .....</b>	<b>67</b>
<b>5 DUALWATCH/TRI-WATCH .....</b>	<b>14</b>	<b>11 SPECIFICATIONS AND OPTIONS .....</b>	<b>68</b>
■ Description .....	14	■ Specifications .....	68
■ Operation .....	14	■ Options .....	69
<b>6 DSC OPERATION .....</b>	<b>15–49</b>	<b>12 CHANNEL LIST .....</b>	<b>70</b>
■ MMSI code programming .....	15	<b>TEMPLATE</b>	
■ MMSI code check .....	16		
■ DSC address ID .....	17		

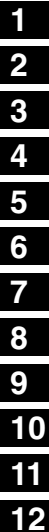

---

## PRECAUTIONS

---

**⚠ WARNING! NEVER** connect the transceiver to an AC outlet. This may pose a fire hazard or result in an electric shock.

**CAUTION:** Changes or modifications to this device, not expressly approved by Icom Inc., could void your authority to operate this device under FCC regulations.

**NEVER** connect the transceiver to a power source of more than 16 V DC or use reverse polarity. This will ruin the transceiver.

**NEVER** cut the DC power cable between the DC plug at the back of the transceiver and fuse holder. If an incorrect connection is made after cutting, the transceiver may be damaged.

**NEVER** place the transceiver where normal operation of the vessel may be hindered or where it could cause bodily injury.

**KEEP** the transceiver at least 3.3 ft (1 m) away from the ship's navigation compass.

**DO NOT** use or place the transceiver in areas with temperatures below  $-4^{\circ}\text{F}$  ( $-20^{\circ}\text{C}$ ) or above  $+140^{\circ}\text{F}$  ( $+60^{\circ}\text{C}$ ) or, in areas subject to direct sunlight, such as the dashboard.

**AVOID** the use of chemical agents such as benzine or alcohol when cleaning, as they may damage the transceiver surfaces. If the transceiver becomes dusty or dirty, wipe it clean with a soft, dry cloth.

**BE CAREFUL!** The transceiver rear panel will become hot when operating continuously for long periods. Place the transceiver in a secure place to avoid inadvertent use by children.

**BE CAREFUL!** The transceiver and optional HM-162 COMMANDMIC III™/HM-157 COMMANDMIC II™ employ waterproof construction, which corresponds to IPX8 of the international standard IEC 60529 (2001). However, once the transceiver or microphone has been dropped, waterproofing cannot be guaranteed due to the fact that the case may be cracked, or the waterproof seal damaged, etc.

## ◇ PRIORITIES

- Read all rules and regulations pertaining to priorities and keep an up-to-date copy handy. Safety and Distress calls take priority over all others.
- You must monitor Channel 16 when you are not operating on another channel.
- False or fraudulent distress signals are prohibited and punishable by law.

## ◇ PRIVACY

- Information overheard but not intended for you cannot lawfully be used in any way.
- Indecent or profane language is prohibited.

## ◇ RADIO LICENSES

### (1) SHIP STATION LICENSE

You must have a current radio station license before using the transceiver. It is unlawful to operate a ship station which is not licensed.

Inquire through your dealer or the appropriate government agency for a Ship-Radiotelephone license application. This government-issued license states the call sign which is your craft's identification for radio purposes.

### (2) OPERATOR'S LICENSE

A Restricted Radiotelephone Operator Permit is the license most often held by small vessel radio operators when a radio is not required for safety purposes.

The Restricted Radiotelephone Operator Permit must be posted or kept with the operator. Only a licensed radio operator may operate a transceiver.

However, non-licensed individuals may talk over a transceiver if a licensed operator starts, supervises, ends the call and makes the necessary log entries.

Keep a copy of the current government rules and regulations handy.

### **Radio license for boaters (U.S.A. only)**

The Telecommunications Act of 1996 permits recreational boaters to have and use a VHF marine radio, EPIRB, and marine radar without having an FCC ship station license. Boaters traveling on international voyages, having an HF single sideband radiotelephone or marine satellite terminal, or required to carry a marine radio under any other regulation must still carry an FCC ship station license. For further information, see the FCC Ship Radio Stations Fact Sheet.

## ■ Front panel

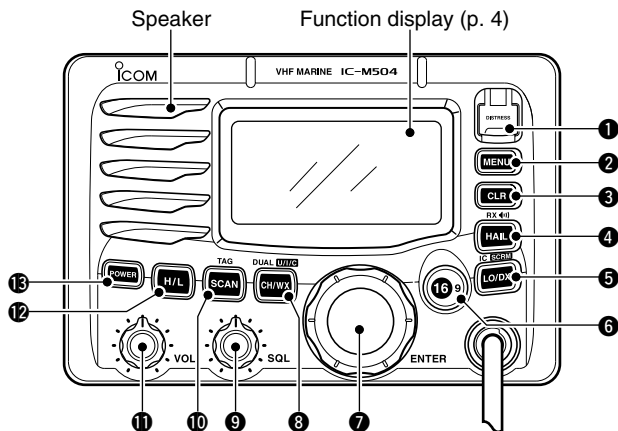

### 1 DISTRESS KEY [DISTRESS]

Push for 5 sec. to transmit a Distress call. (p. 23)

### 2 DSC MENU KEY [MENU]

Push to toggle the DSC menu appear or disappear. (p. 15)

### 3 CLEAR KEY [CLR]

Push to cancel the entered function, exit Set mode. (p. 55)

### 4 HAIL/RX SPEAKER KEY [HAIL•RX 400]

- ➔ Push to turn the hailer mode ON or OFF. (p. 52)
- ➔ Push and hold for 1 sec. to turn the RX Speaker mode ON or OFF. (p. 51)
- ➔ While pushing and holding [H/L], push to turn the auto foghorn function ON. (p. 54)

### 5 ATTENUATOR/INTERCOM KEY [LO/DX•IC•SCRM]

- ➔ Push to turn the Attenuator function ON or OFF. (p. 8)
- “LOC” appears when the Attenuator function is turned ON.
- ➔ Push and hold for 1 sec. to activate an optional Intercom function. (p. 50)
- ➔ Push and hold to calls the optional command microphone while in Intercom mode. (p. 50)
- ➔ While pushing and holding [H/L], push to turn the voice scrambler function ON or OFF. (p. 11)

### 6 CHANNEL 16/CALL CHANNEL KEY [16•9]

- ➔ Push to select Channel 16. (p. 6)
- ➔ Push and hold for 1 sec. to select Call channel. (p. 6)
- “CALL” appears when Call channel is selected.
- ➔ Push and hold for 3 sec. to enter Call channel programming condition when Call channel is selected. (p. 9)
- ➔ While pushing and holding [H/L], push to enter the channel comment programming condition. (p. 10)
- ➔ Advance the cursor while in the channel comment programming condition. (p. 10)
- ➔ While turning power ON, push to enter Set mode. (p. 55)



**7 CHANNEL SELECTOR [DIAL•ENTER]**

- ➔ Rotate to select the operating channels, Set mode settings, etc. (pgs. 6, 7, 55)
- ➔ While pushing and holding **[H/L]**, rotate to adjust the brightness of the LCD and key backlight. (p. 10)
- ➔ Push to enter the input channel comment, selected item, etc. (pgs. 10, 55)
- ➔ Rotate to check TAG channels, changes scanning direction or resumes the scan manually during scan. (p. 13)
- ➔ While pushing and holding **[PA•RX ◀<sup>10</sup>]**, rotate to adjust the audio level in RX Speaker mode. (p. 51)

**8 CHANNEL/WEATHER CHANNEL KEY [CH/WX•DUAL•U/I/C]**

- ➔ Selects and toggles the regular channel and Weather channel when pushed momentarily. (p. 7)
- ➔ Push and hold for 1 sec. to start Dualwatch or Tri-watch. (p. 14)
- ➔ Push to stop Dualwatch or Tri-watch when either is activated. (p. 14)
- ➔ Move the cursor backward while in the channel comment programming condition. (p. 10)
- ➔ While pushing and holding **[H/L]**, push to select one of three channel groups in sequence. (p. 7)
  - U.S.A., International and Canadian channels are available.

**9 SQUELCH CONTROL [SQL]**

Rotate to set the squelch threshold level. (p. 8)

**10 SCAN KEY [SCAN•TAG] (p. 13)**

- ➔ Push to start and stop Normal or Priority scan.
- ➔ Push and hold for 1 sec. to set or clear the displayed channel as a TAG (scanned) channel.
- ➔ While pushing and holding **[H/L]**, push for 3 sec. to clear or set all TAG channels in the selected channel group.

**11 VOLUME CONTROL [VOL] (p. 8)**

Rotate to adjust the audio level.

**12 TRANSMIT POWER KEY [H/L]**

- ➔ Push to toggle the power high or low. (p. 8)
  - Some channels are set to low power only.
- ➔ While pushing this key, some keys perform secondary functions.

**13 POWER KEY [POWER] (p. 8)**

- ➔ Push to turn power ON.
- ➔ Push and hold for 1 sec. to turn power OFF.

## 2 PANEL DESCRIPTION

### ■ Function display

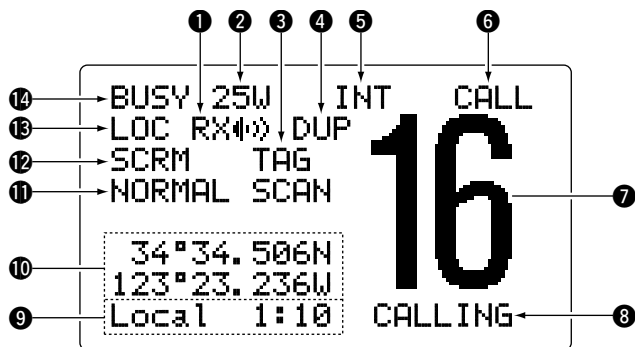

- 1 RX SPEAKER INDICATOR** (p. 51)  
Appears during the RX Speaker mode.
- 2 POWER INDICATOR** (p. 8)
  - “25W” appears when high power is selected.
  - “1W” appears when low power is selected.
- 3 TAG CHANNEL INDICATOR** (p. 13)  
Appears when a TAG channel is selected.
- 4 DUPLEX INDICATOR** (p. 7)  
Appears when a duplex channel is selected.
- 5 CHANNEL GROUP INDICATOR** (p. 7)  
Indicates whether an U.S.A. “USA,” International “INT,” Canadian “CAN” or weather “WX” channel is in use.

- 6 CALL CHANNEL INDICATOR** (p. 9)  
Appears when the call channel is selected.
- 7 CHANNEL NUMBER READOUT**
  - Indicates the selected operating channel number.
    - “A” appears when a simplex channel is selected. (p. 7)
- 8 CHANNEL COMMENT INDICATOR**  
Channel comment appears if programmed. (p. 10)
- 9 TIME ZONE INDICATOR**
  - Shows the current time data when a GPS receiver is connected.
    - “??” may blink every 2 sec. instead of current time data when the GPS current time data is invalid.
    - “??” may blink every 2 sec. instead of current time data 4 hours after the time data is input manually, up until 23.5 hours have past.
  - “Local” appears when the offset time data is set. (p. 47)
  - “No Time” appears when no GPS receiver is connected and no time data is input manually.

**10 POSITION INDICATOR**

- ➔ Shows the GPS position data.
  - “??” may blink every 2 sec. instead of position data when the GPS position data is invalid. In such a case, the last position data is held for up to 23.5 hours.
  - “??” may blink every 2 sec. instead of position data 4 hours after the position data is input manually, up until 23.5 hours have past.
- ➔ “No Position” appears when no GPS receiver is connected and no position data is input manually.

**11 SCAN INDICATOR**

- ➔ “PRI-SCAN 16” appears during Priority scan; “NORMAL SCAN” appears during Normal scan. (p. 13)
- ➔ “DUAL 16” appears during Dualwatch; “TRI 16” appears during Tri-watch. (p. 14)

**12 SCRAMBLER INDICATOR** (p. 11)

Appears when the voice scrambler function is activated. (only when the optional scrambler unit is installed.)

**13 LOCAL INDICATOR** (p. 8)

Appears when the Attenuator function is turned ON.

**14 BUSY/TRANSMIT INDICATOR** (p. 8)

- ➔ “BUSY” appears when receiving a signal or when the squelch opens.
- ➔ “TX” appears while transmitting.

**Microphone**

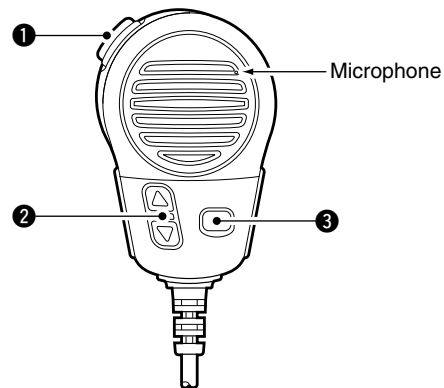

**1 PTT SWITCH [PTT]**

Push and hold to transmit; release to receive. (p. 8)

**2 CHANNEL UP/DOWN KEYS [▲]/[▼]**

- ➔ Push either key to change the operating memory channel, Set mode settings, etc. (pgs. 6, 7, 55)
- ➔ Checks TAG channels, changes scanning direction or resumes the scan manually during scan. (p. 13)

**3 TRANSMIT POWER KEY [HI/LO]**

- ➔ Toggles power high and low when pushed. (p. 8)
  - Some channels are set to low power only.
- ➔ While pushing and holding [HI/LO], turn power ON to toggle the Microphone Lock function ON and OFF. (p. 10)

## ■ Channel selection

### ◇ Channel 16

Channel 16 is the distress and safety channel. It is used for establishing initial contact with another station and for emergency communications. Channel 16 is monitored during both Dualwatch and Tri-watch. While standing by, you must monitor Channel 16.

- Push **[16•9]** momentarily to select Channel 16.
- Push **[CH/WX•DUAL•U//C]** to return to the condition before selecting Channel 16, or rotate **[DIAL]** to select an operating channel.

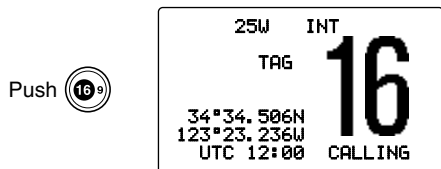

### ◇ Channel 9 (Call channel)

Each regular channel group has a separate leisure-use call channel. The call channel is monitored during Tri-watch. The call channels can be programmed (p. 9) and are used to store your most often used channel in each channel group for quick recall.

- Push **[16•9]** for 1 sec. to select the call channel of the selected channel group.
  - “CALL” and call channel number appear.
  - Each channel group may have an independent call channel after programming a call channel. (p. 9)
- Push **[CH/WX•DUAL•U//C]** to return to the condition before selecting call channel, or rotate **[DIAL]** to select an operating channel.

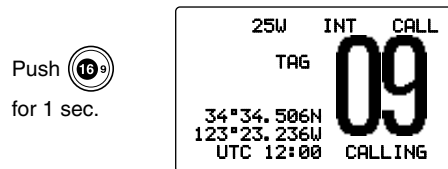

◆ **U.S.A., international and Canadian channels**

The IC-M504 is pre-programmed with 57 U.S.A., 57 international and 61 Canadian channels. These channel groups may be specified for the operating area.

- ① Push **[CH/WX•DUAL•U//C]** to select a regular channel.
  - If a weather channel appears, push **[CH/WX•DUAL•U//C]** again.
- ② While pushing and holding **[H/L]**, push **[CH/WX•DUAL•U//C]** to change the channel group, if necessary.
  - U.S.A., International and Canadian channel groups can be selected in sequence.
- ③ Rotate **[DIAL]** to select a channel.
  - “DUP” appears for duplex channels.
  - “A” appears when a simplex channel is selected.

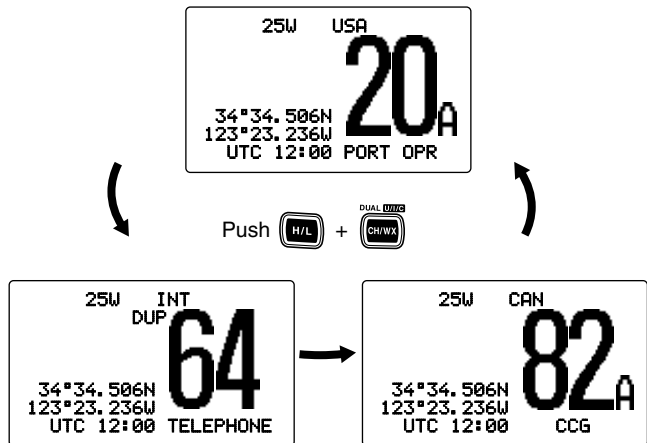

◆ **Weather channels**

The IC-M504 has 10 weather channels. These are used for monitoring broadcasts from NOAA (National Oceanographic and Atmospheric Administration.)

The transceiver can detect a weather alert tone on the selected weather channel while receiving the channel, during standby on a regular channel or while scanning. (p. 56)

- ① Push **[CH/WX•DUAL•U//C]** once or twice to select a weather channel.
  - “WX” appears when a weather channel is selected.
  - “WX ALERT” appears when the Weather Alert function is in use. (p. 56)
- ② Rotate **[DIAL]** to select a channel.

Push  once or twice

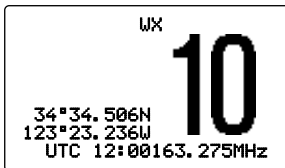

When weather alert is OFF.

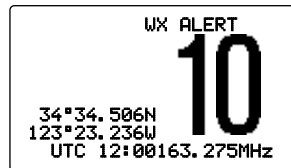

When weather alert is ON.

### 3 BASIC OPERATION

## ■ Receiving and transmitting

**CAUTION:** Transmitting without an antenna may damage the transceiver.

- ① Push **[POWER]** to turn power ON.
- ② Set the audio and squelch levels.
  - Rotate **[SQL]** fully counterclockwise in advance.
  - Rotate **[VOL]** to adjust the audio output level.
  - Rotate **[SQL]** clockwise until the noise disappears.
- ③ While pushing and holding **[H/L]**, push **[CH/WX•DUAL•U//C]** to change the channel group. (p. 7)
- ④ Rotate **[DIAL]** to select the desired channel. (pgs. 6, 7)
  - When receiving a signal, “**BUSY**” appears and audio is emitted from the speaker.
  - Further adjustment of **[VOL]** may be necessary.
- ⑤ Push **[LO/DX•IC•SCRM]** to turn the receive Attenuator function ON or OFF, if necessary.
  - “**LOC**” appears when the receive Attenuator function is in use.
- ⑥ Push **[H/L]** to select the output power if necessary.
  - “**25W**” or “**1W**” appears when high or low power is selected, respectively.
  - Choose low power for short range communications, choose high power for longer distance communications.
  - Some channels are for low power only.
- ⑦ Push and hold **[PTT]** to transmit, then speak into the microphone.
  - “**TX**” appears.
  - Channel 70 cannot be used for transmission other than DSC.
- ⑧ Release **[PTT]** to receive.

Simplex channels, 3, 21, 23, 61, 64, 81, 82 and 83 **CANNOT** be lawfully used by the general public in U.S.A. waters.

**IMPORTANT:** To maximize the readability of your transmitted signal, pause a few sec. after pushing **[PTT]**, hold the microphone 2 to 4 inches (5 to 10 cm) from your mouth and speak into the microphone at a normal voice level.

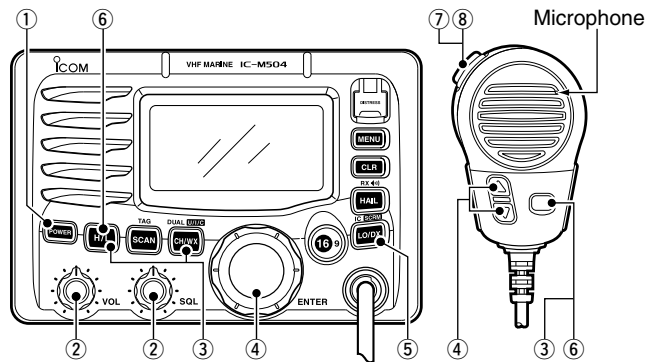

## ■ Call channel programming

Call channel is used to select Channel 9 (default), however, you can program the call channel with your most often-used channels in each channel group for quick recall.

- ① While pushing and holding [H/L], push [CH/WX•DUAL•U/C] one or more times to select the desired channel group (U.S.A., International or Canada) to be programmed.
- ② Push [16•9] for 1 sec. to select the call channel of the selected channel group.
  - “CALL” and call channel number appear.
- ③ Push [16•9] again for 3 sec. (until a long beep changes to 2 short beeps) to enter the call channel programming condition.
  - Channel number starts blinking.

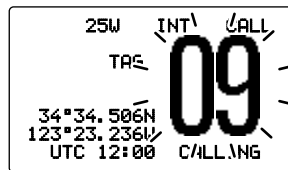
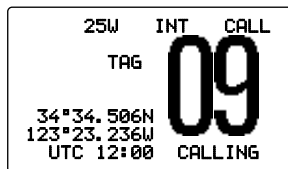
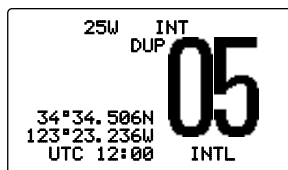

- ④ Rotate [DIAL] to select the desired channel.

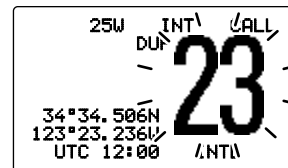

- ⑤ Push [16•9] to program the displayed channel as the call channel.
  - Push [CLR] to cancel.
  - The channel number stops blinking.

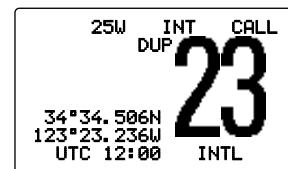

### 3 BASIC OPERATION

## ■ Channel comments

Memory channels can be labelled with alphanumeric comments of up to 10 characters each for easy channel recognition.

Capital letters, small letters, 0 to 9, some symbols (– . /) and space can be used.

- ① Select the desired channel.
  - Cancel Dualwatch, Tri-watch or Scan in advance.
- ② While pushing and holding **[H/L]**, push **[16•9]** to edit the channel comment.
  - A cursor and the first character start blinking alternately.
- ③ Select the desired character by rotating **[DIAL]**.
  - Push **[16•9]** or **[CH/WX•DUAL•U//C]** to move the cursor forward or backward, respectively.
- ④ Repeat step ③ to input all characters.
- ⑤ Push **[DIAL•ENTER]** to input and set the comment.
  - Push **[CLR]** to cancel.
  - The cursor and the character stop blinking.
- ⑥ Repeat steps ① to ⑤ to program other channel comments, if desired.

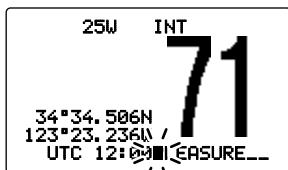

## ■ Microphone Lock function

The Microphone Lock function electrically locks **[▲]/[▼]** and **[HI/LO]** keys on the supplied microphone. This prevents accidental channel changes and function access.

- ➔ While pushing and holding **[HI/LO]** on the microphone, turn power ON to toggle the Lock function ON and OFF.

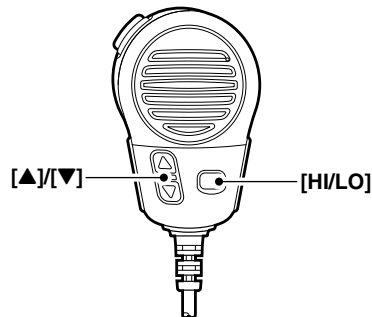

## ■ Display backlight

The function display and keys can be backlit for better visibility under low light conditions.

- ➔ While pushing and holding **[H/L]**, rotate **[DIAL]** to adjust the brightness of the LCD and key backlight.
  - The backlight is adjustable in 7 levels and OFF.



## ■ Optional voice scrambler operation

### ◆ Activating the scrambler

The optional voice scrambler provides private communications. In order to receive or send scrambled transmissions you must first activate the scrambler function. To activate the function, an optional scrambler unit is necessary. See pgs. 57, 62 for setting the scrambler unit. Ask your dealer for details.

/// The scrambler function automatically turns OFF when Channel 16 or 70 is selected.

- ① Rotate **[DIAL]** to select an operating channel other than Channel 16 and 70.
- ② While pushing and holding **[H/L]**, push **[LO/DX•IC•SCRM]** to turn the optional scrambler function ON.
  - “SCRM” appears.
- ③ To turn the scrambler function OFF, repeat step ②.
  - “SCRM” disappears.

### ◆ Programming scrambler codes

There are 32 codes (1 to 32) or 128 codes (0 to 127)\* available for programming when the optional scrambler unit is installed. In order to understand one another, all transceivers in your group must have the same scramble code. This function may not be available depending on dealer setting.

\*Depends on the installed scrambler unit.

- ① Turn power OFF.
- ② While pushing **[16•9]**, turn power ON to enter set mode.
- ③ After the display appears, release **[16•9]**.
- ④ Rotate **[DIAL]** to select the “**Scrambler Code**,” push **[DIAL•ENTER]**.
- ⑤ Rotate **[DIAL]** to select the desired scrambler code.
- ⑥ Push **[DIAL•ENTER]** to set and exit the scrambler code item.
- ⑦ Push **[CLR]**, or rotate **[DIAL]** to select “**Exit**,” push **[DIAL•ENTER]** to exit set mode.

**[Example]:** Programming scrambler code 5.

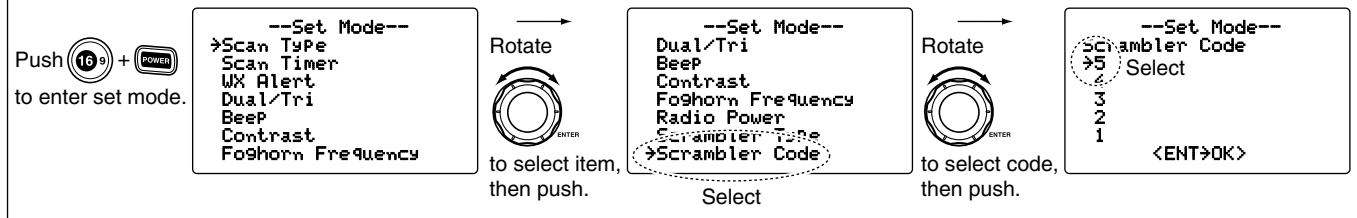

## ■ Scan types

Scanning is an efficient way to locate signals quickly over a wide frequency range. The transceiver has Priority scan and Normal scan.

When the Weather Alert function is turned ON, the previously selected (last used) weather channel is also checked while scanning. (p. 56)

### PRIORITY SCAN

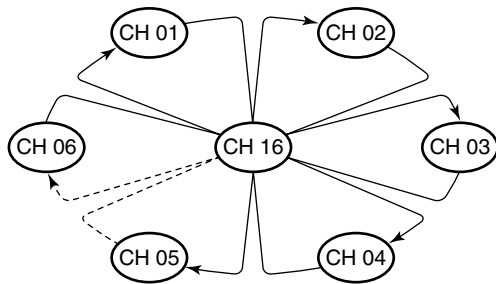

Priority scan searches through all TAG channels in sequence while monitoring Channel 16. When a signal is detected on Channel 16, scan pauses until the signal disappears; when a signal is detected on a channel other than Channel 16, scan becomes Dualwatch until the signal disappears.

Set the TAG channels (scanned channel) before scanning. Clear the TAG channels which inconveniently stop scanning, such as those for digital communication use. (Refer to right page for details.)

/// Choose Priority or Normal scan in Set mode. (p. 55)

### NORMAL SCAN

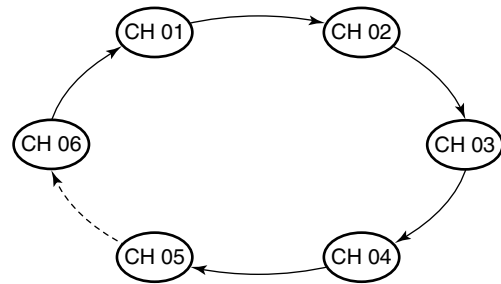

Normal scan, like Priority scan, searches through all TAG channels in sequence. However, unlike Priority scan, Channel 16 is not checked unless Channel 16 is set as a TAG channel.

## ■ Setting TAG channels

For more efficient scanning, add the desired channels as TAG channels or clear the TAG for unwanted channels.

Channels that are not tagged will be skipped during scanning. TAG channels can be assigned to each channel group (USA, INT, CAN) independently.

- ① While pushing and holding [H/L], push [CH/WX•DUAL•U/I/C] to select the desired channel group (USA, INT or CAN.)
- ② Select the desired channel to be set as a TAG channel.
- ③ Push [SCAN•TAG] for 1 sec. to set the displayed channel as a TAG channel.
  - “TAG” appears in the display.
- ④ To cancel the TAG channel setting, repeat step ③.
  - “TAG” disappears.

### ✓ Clearing (or setting) all tagged channels

While pushing and holding [H/L], push [SCAN•TAG] for 3 sec. (until a long beep changes to 2 short beeps) to clear all TAG channels setting in the channel group.

- Repeat above procedure to set all TAG channels.

## ■ Starting a scan

Set scan type (Priority or Normal scan) and scan resume timer in advance, using Set mode. (p. 55)

- ① While pushing and holding [H/L], push [CH/WX•DUAL•U/I/C] to select the desired channel group (USA, INT, CAN) if desired.
- ② Set TAG channels as described at left.
- ③ Make sure the squelch is closed to start a scan.
- ④ Push [SCAN•TAG] to start Priority or Normal scan.
  - “PRI-SCAN 16” appears at the channel comment indicator during Priority scan.
  - “NORMAL SCAN” appears at the channel comment indicator during Normal scan.
  - When a signal is detected, scan pauses until the signal disappears or resumes after pausing 5 sec. according to Set mode setting. (Channel 16 is still monitored during Priority scan.)
  - Rotate [DIAL] to check the scanning TAG channels, to change the scanning direction or resume the scan manually.
  - A beep tone sounds and “16” blinks at the channel comment indicator when a signal is received on Channel 16 during Priority scan.

[Example]: Starting a normal scan.

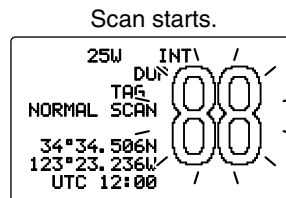
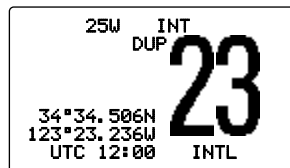

When a signal is received

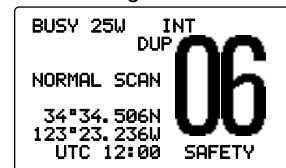

## ■ Description

Dualwatch monitors Channel 16 while you are receiving another channel; Tri-watch monitors Channel 16 and the call channel while receiving another channel. Dualwatch/Tri-watch is convenient for monitoring Channel 16 when you are operating on another channel.

### DUALWATCH/TRI-WATCH SIMULATION



- If a signal is received on Channel 16, Dualwatch/Tri-watch pauses on Channel 16 until the signal disappears.
- If a signal is received on the call channel during Tri-watch, Tri-watch becomes Dualwatch until the signal disappears.
- To transmit on the selected channel during Dualwatch/Tri-watch, push and hold [PTT].

## ■ Operation

- ① Select Dualwatch or Tri-watch in Set mode. (p. 56)
- ② Rotate [DIAL] to select the desired operating channel.
- ③ Push [CH/WX•DUAL•U/I/C] for 1 sec. to start Dualwatch or Tri-watch.
  - “DUAL 16” appears during Dualwatch; “TRI 16” appears during Tri-watch.
  - A beep tone sounds when a signal is received on Channel 16.
- ④ To cancel Dualwatch/Tri-watch, push [CH/WX•DUAL•U/I/C] again.

### [Example]: Operating Tri-watch on INT Channel 25

Tri-watch starts.

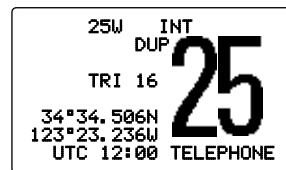

Signal is received on call channel.



Tri-watch resumes after the signal disappears.

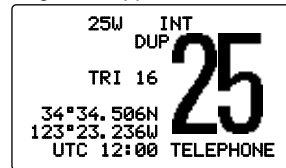

Signal received on Channel 16 takes priority.

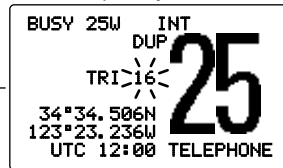

## ■ MMSI code programming

The 9-digit MMSI (Maritime Mobile Service Identity: DSC self ID) code can be programmed at power ON.

/// This code programming can be performed only twice.

- ① Turn power OFF.
- ② While pushing **[MENU]**, turn power ON to enter MMSI code programming condition.
- ③ After the display appears, release **[MENU]**.
- ④ Push **[MENU]** again to enter the DSC menu.
- ⑤ Rotate **[DIAL]** to select "Set up," push **[DIAL•ENTER]**.

```

--DSC Menu--
Select Item
Position Input
Received Calls
>Set up
Exit
    
```

- ⑥ Rotate **[DIAL]** to select "MMSI Check," push **[DIAL•ENTER]**.

```

--DSC Menu--
Set up
Add:INDU ID
Add:Group ID
DEL:INDU ID
DEL:Group ID
Offset Time
>MMSI Check
    
```

- ⑦ Rotate **[DIAL]** to set the specific 9-digit MMSI code.
  - Push **[16•9]** or **[CH/WX•DUAL•U//C]** to move the cursor forward or backward, respectively.
  - Push **[CLR]** to cancel and exit the condition to the set up menu.

```

--DSC Menu--
MMSI Check
-----
<CLR>Exit / ENT>OK>
    
```

- ⑧ After input the 9-digit code, push **[DIAL•ENTER]** to set the code.
  - Returns to the set up menu.
- ⑨ Push **[CLR]** or rotate **[DIAL]** to select "Exit," push **[DIAL•ENTER]**.
  - Returns to the DSC menu.
  - Repeat again to return to the normal operation condition.

## 6 DSC OPERATION

### ■ MMSI code check

The 9-digit MMSI (DSC self ID) code can be checked.

- ① Push **[MENU]** to enter the DSC menu.
- ② Rotate **[DIAL]** to select "Set up," push **[DIAL•ENTER]**.

```
      --DSC Menu--  
Select Item  
Position Report  
Polling Request  
Received Calls  
Distress Setting  
→Set up  
Exit
```

- ③ Rotate **[DIAL]** to select "MMSI Check," push **[DIAL•ENTER]**.

```
      --DSC Menu--  
Set up  
DEL:Group ID  
Offset Time  
→MMSI Check  
Auto ACK  
NMEA Output  
Exit
```

- ④ Check the 9-digit MMSI (DSC self ID) code.

```
      --DSC Menu--  
MMSI Check  
123456789
```

```
<CLR→Exit>
```

- ⑤ Push **[CLR]** or rotate **[DIAL]** to select "Exit," push **[DIAL•ENTER]**.
  - Returns to the DSC menu.
  - Repeat again to return to the normal operation condition.

## ■ DSC address ID

A total of 100 DSC address IDs can be programmed and named with up to 10 characters.

### ◆ Programming Individual ID

- ① Push [MENU] to enter the DSC menu.
- ② Rotate [DIAL] to select "Set up," push [DIAL•ENTER].

```

--DSC Menu--
Select Item
Position Report
Polling Request
Received Calls
Distress Setting
->Set up
Exit
  
```

- ③ Rotate [DIAL] to select "Add: INDU ID," push [DIAL•ENTER].

```

--DSC Menu--
Set up
->Add: INDU ID
Add: Group ID
DEL: INDU ID
DEL: Group ID
Offset Time
MMSI Check
  
```

- ④ Rotate [DIAL] to set the individual ID and ID name.
  - Push [16•9] or [CH/WX•DUAL•U/I/C] to move the cursor forward or backward, respectively.
  - Push [CLR] to cancel and exit the condition to the set up menu.
  - "Full ID" appears when 100 DSC address IDs are already set.
  - After inputting the 9-digit ID code, push [DIAL•ENTER] or [16•9] to set up a 10-character ID name.

```

--DSC Menu--
Add: Individual ID
Input 9 digits
-█-----
Input name
-----
<CLR>Exit / ENT>OK>
  
```

- ⑤ After inputting, push [DIAL•ENTER] to program.
- ⑥ Push [CLR] or rotate [DIAL] to select "Exit," push [DIAL•ENTER].
  - Returns to the DSC menu.
  - Repeat again to return to the normal operation condition.

## 6 DSC OPERATION

### ◆ Deleting Individual ID

- ① Push **[MENU]** to enter the DSC menu.
- ② Rotate **[DIAL]** to select “Set uP,” push **[DIAL•ENTER]**.

```
--DSC Menu--
Select Item
Position Report
Polling Request
Received Calls
Distress Setting
→Set uP
Exit
```

- ③ Rotate **[DIAL]** to select “DEL:INDV ID,” push **[DIAL•ENTER]**.

- When no address ID is programmed, “No ID” is displayed. Push **[CLR]** to exit the condition.

```
--DSC Menu--
Set uP
Add:INDV ID
Add:Group ID
→DEL:INDV ID
DEL:Group ID
Offset Time
MMSI Check
```

- ④ Rotate **[DIAL]** to select the desired ID name for deleting.

```
--DSC Menu--
Select ID
John
Paul
→George
Michael

<CLR>Exit / ENT→OK>
```

- ⑤ Push **[DIAL•ENTER]** to delete the address ID and returns to the set up menu.
- ⑥ Push **[CLR]** or rotate **[DIAL]** to select “Exit,” push **[DIAL•ENTER]**.
  - Returns to the DSC menu.
  - Repeat again to return to the normal operation condition.



### ◆ Programming Group ID

- ① Push [MENU] to enter the DSC menu.
- ② Rotate [DIAL] to select "Set up," push [DIAL•ENTER].

```

--DSC Menu--
Select Item
Position Report
Polling Request
Received Calls
Distress Setting
>Set up
Exit
  
```

- ③ Rotate [DIAL] to select "Add: Group ID," push [DIAL•ENTER].

```

--DSC Menu--
Set up
Add:INDU ID
>Add:Group ID
DEL:INDU ID
DEL:Group ID
Offset Time
MMSI Check
  
```

- ④ Rotate [DIAL] to set the group ID and ID name.
  - Push [16•9] or [CH/WX•DUAL•U/I/C] to move the cursor forward or backward, respectively.
  - Push [CLR] to cancel and exit the condition to the set up menu.
  - "Full ID" appears when 100 DSC address IDs are already set.
  - After inputting the 8-digit ID code, push [DIAL•ENTER] or [16•9] to set up a 10-character ID name.
  - 1st digit '0' is fixed for a group ID.

```

--DSC Menu--
Add:Group ID
Input 8 digits
  █
Input name
-----
<CLR>Exit / ENT>OK>
  
```

- ⑤ After inputting, push [DIAL•ENTER] to program.
- ⑥ Push [CLR] or rotate [DIAL] to select "Exit," push [DIAL•ENTER].
  - Returns to the DSC menu.
  - Repeat again to return to the normal operation condition.

## 6 DSC OPERATION

### ◆ Deleting Group ID

- ① Push **[MENU]** to enter the DSC menu.
- ② Rotate **[DIAL]** to select "Set uP," push **[DIAL•ENTER]**.

```
--DSC Menu--
Select Item
Position Report
Polling Request
Received Calls
Distress Setting
→Set uP
Exit
```

- ③ Rotate **[DIAL]** to select "DEL:Group ID," push **[DIAL•ENTER]**.

- When no address ID is programmed, "No ID" is displayed.  
Push **[CLR]** to exit the condition.

```
--DSC Menu--
Set uP
Add:INDU ID
Add:Group ID
DEL:INDU ID
→DEL:Group ID
Offset Time
MMSI Check
```

- ④ Rotate **[DIAL]** to select the desired ID name for deleting.

```
--DSC Menu--
Select ID
Icom
Group A
→Group B
Group C

<CLR>Exit / ENT→OK>
```

- ⑤ Push **[DIAL•ENTER]** to delete the group ID and returns to the set up menu.
- ⑥ Push **[CLR]** or rotate **[DIAL]** to select "Exit," push **[DIAL•ENTER]**.
  - Returns to the DSC menu.
  - Repeat again to return to the normal operation condition.

## ■ Position and time programming

A distress call should include the ship's position and time data. If no GPS is connected, your position and UTC (Universal Time Coordinated) time should be input manually. They are included automatically when a GPS receiver (NMEA0183 ver. 2.0 or 3.01) is connected.

- ① Push **[MENU]** to enter the DSC menu.
- ② Rotate **[DIAL]** to select "Position Input," and push **[DIAL•ENTER]**.

```

--DSC Menu--
Select Item
>Position Input
  Individual Call
  Group Call
  All Ships Call
  Position Request
  Position Report
  
```

- ③ The position information appears. Set your position (latitude and longitude) data with rotating **[DIAL]**.
  - Push **[16•9]** or **[CH/WX•DUAL•U//C]** to move the cursor forward or backward, respectively.
  - Rotate **[DIAL]** to edit N; North latitude or S; South latitude when the cursor is on the 'N' or 'S' position, and W; West longitude or E; East longitude when the cursor is on the 'W' or 'E' position.
  - Push **[CLR]** for 1 sec. to clear the latitude/longitude data.
  - Push **[CLR]** to cancel and exit the condition to the DSC menu.

```

--DSC Menu--
Input Position
Latitude
> 00.000N Null
Longitude
  00.000W Null
<CLR 1sec>Null Data>
<CLR>Exit / ENT>OK>
  
```

- ④ After setting the position data, push **[DIAL•ENTER]** to set the time information appears. Set the current UTC time with rotating **[DIAL]**, then push **[DIAL•ENTER]**.
  - Push **[16•9]** or **[CH/WX•DUAL•U//C]** to move the cursor forward or backward, respectively.
  - Push **[CLR]** for 1 sec. to clear the UTC time data.
  - Push **[CLR]** to cancel and exit the condition to the DSC menu.

```

--DSC Menu--
Input UTC Time
> 00.00.00 Null
  
```

```

<CLR 1sec>Null Data>
<CLR>Exit / ENT>OK>
  
```

## 6 DSC OPERATION

⑤ Push [CLR] or rotate [DIAL] to select “Exit,” push [DIAL•ENTER].

- Returns to the DSC menu.
- Repeat again to return to the normal operation condition.

/// Manually programmed position data will be held for 23.5 hours only.

## ■ Position and time indication

When a GPS receiver (NMEA0183 ver. 2.0 or 3.01) is connected, the transceiver displays the current position and time. When no GPS receiver is connected, the transceiver displays the manually entered position and time.

A GPS receiver appropriate for the IC-M504 is not supplied from Icom. A GPS receiver with NMEA0183 ver. 2.0 or 3.01 format is required for position and time indication. Ask your dealer about suitable GPS receivers.

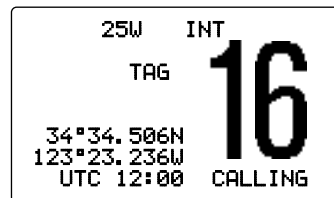

- /// ➔ When connecting GPS receiver is compatible with several sentence formatters, the order of input precedence is 'RMC,' 'GGA,' 'GNS' and 'GLL.'
- /// ➔ When sentence formatter 'RMC' is received, time indication includes a date and UTC time only.
- /// ➔ “??” may blink instead of position and time indications when the GPS data is invalid, or has not been manually updated after 4 hours.

## ■ Distress call

A distress call should be transmitted, if in the opinion of the Master, the ship or a person is in distress and requires immediate assistance.

**NEVER USE THE DISTRESS CALL WHEN YOUR SHIP OR A PERSON IS NOT IN AN EMERGENCY. A DISTRESS CALL CAN BE USED ONLY WHEN IMMEDIATE HELP IS NEEDED.**

### ◆ Simple call

- ① Confirm no distress call is being received.
- ② While lifting up the key cover, push **[DISTRESS]** for 5 sec. to transmit the distress call.
  - Emergency channel (Channel 70) is automatically selected and the distress call is transmitted.
  - When no GPS is connected, input your position and UTC time, if possible.
  - While pushing **[DISTRESS]**, the key backlighting is blinking.

Distress Call  
Push for 5 sec.

- ③ After transmitting the distress call, the transceiver waits for an acknowledgment call on Channel 70.
  - The distress call is automatically transmitted every 3.5 to 4.5 minutes.
  - After 2 sec., the transceiver is set to Channel 16 automatically.

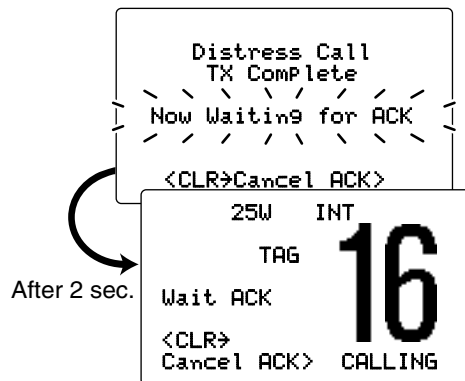

- ④ After receiving the acknowledgment, reply using the microphone.

25W INT

TAG 16

Received  
DistressACK  
<Osaka Bay  
<CLR>  
Beep Off> CALLING

## 6 DSC OPERATION

- ➔ A distress alert contains (default);
  - Nature of distress : Undesignated distress
  - Position data : GPS or manual input position data held for 23.5 hrs or until the power is turned OFF.
- ➔ The distress call is repeated every 3.5–4.5 min., until receiving an 'acknowledgement.'
- ➔ Push **[CLR]** to cancel the 'Call repeat' mode.
- ➔ "???" may blink instead of position and time indications when the GPS data is invalid, or has not been manually updated after 4 hours.

### ◆ Regular call

The nature of the distress call should be included in the distress call.

- ① Push **[MENU]** to enter the DSC menu.
- ② Rotate **[DIAL]** to select "Distress Setting," and push **[DIAL•ENTER]**.

```
--DSC Menu--
Select Item
All Ships Call
Position Request
Position Report
Polling Request
Received Calls
→Distress Setting
```

- ③ Rotate **[DIAL]** to select the nature of the distress, push **[DIAL•ENTER]**.
  - 'Undesignated,' 'Explosion,' 'Flooding,' 'Collision,' 'Grounding,' 'Capsizing,' 'Sinking,' 'Adrift (Disable adrift),' 'Abandoning (Abandoning ship),' 'Piracy (Piracy attack)' and 'MOB (Man overboard)' are available.
  - The selected nature of the distress is stored for 10 minutes.

```
--DSC Menu--
Select Nature
Undesignated
→Explosion
Flooding
Collision

<CLR>Exit / ENT→OK>
```

When a GPS receiver (NMEA0183 ver. 2.0 or 3.01) is connected, next steps ④, ⑤ (Current position/time programming) do not appear. Go to step ⑥.

- ④ The position information appears. Set your position (latitude and longitude) data with rotating **[DIAL]**.
- Push **[16•9]** or **[CH/WX•DUAL•U/I/C]** to move the cursor forward or backward, respectively.
  - Rotate **[DIAL]** to edit N; North latitude or S; South latitude when the cursor is on the 'N' or 'S' position, and W; West longitude or E; East longitude when the cursor is on the 'W' or 'E' position.
  - Push **[CLR]** for 1 sec. to clear the latitude/longitude data.
  - Push **[CLR]** to cancel and exit the condition to the DSC menu.

```

--DSC Menu--
InPut Position
Lat/itude
>█-----N      Null
Lon/ititude
  █-----W      Null
<CLR 1sec>Null Data>
<CLR>Exit / ENT>OK>

```

- ⑤ After setting the position data, push **[DIAL•ENTER]** to set the time information appears. Set the current UTC time with rotating **[DIAL]**, then push **[DIAL•ENTER]**.
- Push **[16•9]** or **[CH/WX•DUAL•U/I/C]** to move the cursor forward or backward, respectively.
  - Push **[CLR]** for 1 sec. to clear the UTC time data.
  - Push **[CLR]** to cancel and exit the condition to the DSC menu.

```

--DSC Menu--
InPut UTC Time
      █----- Null
<CLR 1sec>Null Data>
<CLR>Exit / ENT>OK>

```

- ⑥ Push **[DISTRESS]** for 5 sec. to transmit the distress call.
- While pushing **[DISTRESS]**, the key backlighting is blinking.
- ⑦ After transmitting the distress call, the transceiver waits for an acknowledgment call on Channel 70.
- The distress call is automatically transmitted every 3.5 to 4.5 min.
  - After 2 sec., the transceiver is set to Channel 16 automatically.

```

Distress Call
TX Complete
Now Waiting for ACK
<CLR>Cancel ACK>

```

After 2 sec.

```

25W INT
TAG
Wait ACK
<CLR>
Cancel ACK> CALLING

```

## 6 DSC OPERATION

- ⑧ After receiving the acknowledgment, reply using the microphone.

```
25W INT
TAG
Received
DistressACK
<Osaka Bay
<CLR>
BeeP Off> CALLING
16
```

- ➔ A distress alert contains (default);
  - Nature of distress : Selected nature of the distress
  - Position data : GPS or manual input position data held for 23.5 hrs or until the power is turned OFF.
- ➔ The distress call is repeated every 3.5–4.5 min., until receiving an 'acknowledgement.'
- ➔ Push **[CLR]** to cancel the 'Call repeat' mode.
- ➔ "??" may blink instead of position and time indications when the GPS data is invalid, or has not been manually updated after 4 hours.

## ■ Transmitting DSC calls

/// To ensure correct operation of the DSC function, please make sure you set the squelch correctly. (p. 8)

### ◆ Transmitting an individual call

The individual call function allows you to transmit a DSC signal to a specific ship only.

- ① Push **[MENU]** to enter the DSC menu.
- ② Rotate **[DIAL]** to select "Individual Call," push **[DIAL•ENTER]**.
  - "Position InPut" item appears when a GPS receiver (NMEA0183 ver. 2.0 or 3.01) is not connected.

```
--DSC Menu--
Select Item
Position InPut
➔Individual Call
Group Call
All ShiPs Call
Position Request
Position RePort
```



- ③ Rotate [DIAL] to select the desired pre-programmed individual address or "Manual InPut," push [DIAL•ENTER].
- The ID code for the individual call can be set in advance. (p. 16)
  - When "Manual InPut" is selected, set the 9-digit ID code for the individual you wish to call with rotating [DIAL].  
 // 1st digit must not be '0'.

```

--DSC Menu--
Select Address
Manual InPut
John
>Paul
George
Michael
<CLR>Exit / ENT>OK>
    
```

- ④ Rotate [DIAL] to select a desired intership channel, push [DIAL•ENTER].
- Intership channels are already preset into the transceiver in recommending order.

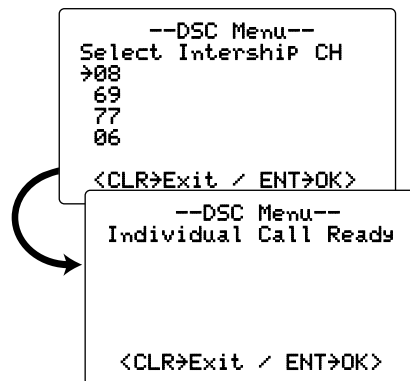

- ⑤ Push [DIAL•ENTER] to transmit the individual call.
- If Channel 70 is busy, the transceiver stands by until the channel becomes clear.

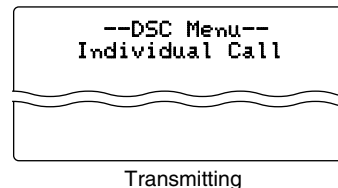

## 6 DSC OPERATION

- ⑥ Standby on Channel 70 until an acknowledgement is received.

```
  --DSC Menu--
  Individual Call
  TX Complete
  /-----\
 /         \
| Now Waiting for ACK |
 \         /
  -----
  <CLR>Exit>
```

- ⑦ When the acknowledgement 'Able to comply' is received, the specified channel (in step ④) is selected with beeps automatically. Or, when the acknowledgement 'Unable to comply' is received, the display returns to the operated channel (before enter the DSC menu) with beeps.

```
  25W  INT
  Received INDU ACK
  <John
  <CLR>
  BeeP Off> COMMERCIAL
  08
```

'Able to comply' is received.

```
  25W  INT
  DUP
  Received Unable ACK
  <John
  <CLR>
  BeeP Off>
  21
  INTL
```

'Unable to comply' is received.

- ⑧ Push [CLR] to stop the beep, then push and hold [PTT] to communicate your message to the responding ship.

### ◆ Transmitting an individual acknowledgement

When receiving an individual call, you can transmit an acknowledgement ('Able to comply' or 'Unable to comply') by using the on screen prompts (see page 38 for details). Alternatively, you can send an acknowledgement through the menu system as follows.

- ① Push [MENU] to enter the DSC menu.
- ② Rotate [DIAL] to select "Individual ACK," push [DIAL•ENTER].

- "Position InPut" item appears when a GPS receiver (NMEA0183 ver. 2.0 or 3.01) is not connected.
- "Individual ACK" item appears after an individual call is received.

```
  --DSC Menu--
  Select Item
  Position InPut
  Individual Call
  →Individual ACK
  Group Call
  All ShiPs Call
  Position Request
```

- ③ Rotate [DIAL] to select the desired individual address or ID code, push [DIAL•ENTER].

```
  --DSC Menu--
  Select Address
  John
  →Paul
  George
  Michael
  <CLR>Exit / ENT→OK>
```

- ④ Rotate [DIAL] to select that you can comply to the call or not from “Able to Comply” or “Unable to Comply,” push [DIAL•ENTER].
- When “Unable to Comply” is selected, the reason “No Reason Given” will be transmitted.

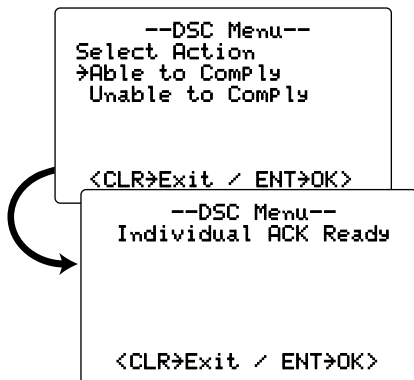

- ⑤ Push [DIAL•ENTER] to transmit the acknowledgement call to the selected station.
- ⑥ After the individual acknowledgement call has been transmitted, the specified channel (specified by the calling station) is selected automatically when “Able to Comply” is selected, or returns to the previous condition (before entering the DSC menu) when “Unable to Comply” is selected in step ④.

### ◇ Transmitting a group call

The group call function allows you to transmit a DSC signal to a specific group only.

- ① Push [MENU] to enter the DSC menu.
- ② Rotate [DIAL] to select “Group Call,” push [DIAL•ENTER].
  - “Position InPut” item appears when a GPS receiver (NMEA0183 ver. 2.0 or 3.01) is not connected.

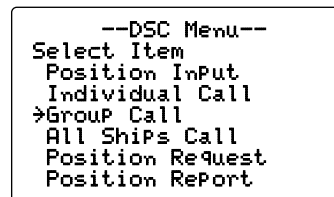

- ③ Rotate [DIAL] to select the desired pre-programmed group address or “Manual InPut,” push [DIAL•ENTER].
  - The ID code for the group call can be set in advance. (p. 18)
  - When “Manual InPut” is selected, set the 8-digit ID code for the group you wish to call with rotating [DIAL].



## 6 DSC OPERATION

- ④ Rotate **[DIAL]** to select a desired intership channel, push **[DIAL•ENTER]**.

- Intership channels are already preset into the transceiver in recommending order.

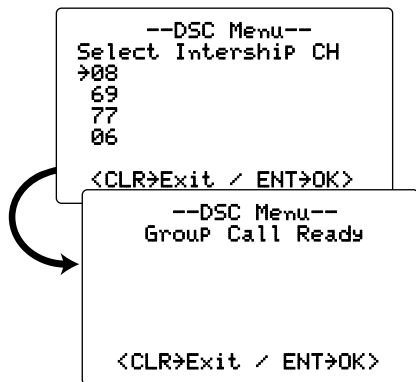

- ⑤ Push **[DIAL•ENTER]** to transmit the group call.

- If Channel 70 is busy, the transceiver stands by until the channel becomes clear.

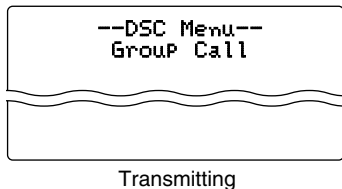

- ⑥ After the group call has been transmitted, the following indication is displayed.



- ⑦ Push **[CLR]** to exit the condition and selects the specified intership channel in step ④ automatically.

- Even if **[CLR]** hasn't been pushed, the transceiver selects the specified intership channel in step ④ automatically after 2 sec. of inactivity.

◆ **Transmitting an all ships call**

Large ships use Channel 70 as their 'listening channel.' When you want to announce a message to these ships, use the all ships call function.

- ① Push **[MENU]** to enter the DSC menu.
- ② Rotate **[DIAL]** to select "All Ships Call," and push **[DIAL•ENTER]**.
  - "Position InPut" item appears when a GPS receiver (NMEA0183 ver. 2.0 or 3.01) is not connected.

```

--DSC Menu--
Select Item
Position InPut
Individual Call
Group Call
>All Ships Call
Position Request
Position Report
    
```

- ③ Rotate **[DIAL]** to select the desired category, push **[DIAL•ENTER]**.
  - Output power of 'Routine' category is 1 W (low power) only.
  - The selectable category may differ according to the programmed setting. Ask your dealer for the available categories.

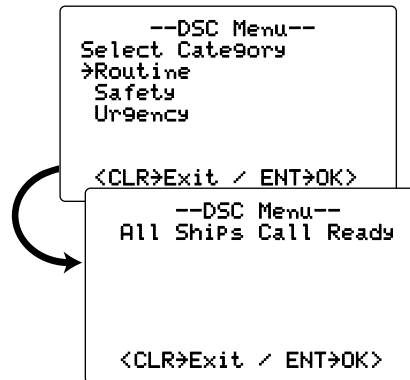

- ④ Push **[DIAL•ENTER]** to transmit the all ships call.
  - Channel 70 is selected and the all ships call is transmitted.

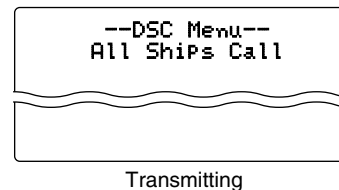

## 6 DSC OPERATION

- ⑤ After the all ships call has been transmitted, the following indication is displayed.

```
  --DSC Menu--  
  All ShiPs Call  
  TX Complete  
  
  <CLR>Exit>
```

- ⑥ Push **[CLR]** to exit the condition and selects Channel 16 automatically.
- Even if **[CLR]** hasn't been pushed, the transceiver automatically selects Channel 16 after 2 sec. of inactivity.

### ◆ Transmitting a position request call

Transmit a position request call when you want to know a specific ship's current position, etc.

- ① Push **[MENU]** to enter the DSC menu.
- ② Rotate **[DIAL]** to select "Position Request," push **[DIAL•ENTER]**.
  - "Position InPut" item appears when a GPS receiver (NMEA0183 ver. 2.0 or 3.01) is not connected.

```
  --DSC Menu--  
  Select Item  
  Position InPut  
  Individual Call  
  Group Call  
  All ShiPs Call  
  →Position ReQuest  
  Position RePort
```

- ③ Rotate **[DIAL]** to select the desired pre-programmed individual address or "Manual InPut," push **[DIAL•ENTER]**.
  - The ID code can be set in advance. (p. 17)
  - When "Manual InPut" is selected, set the 9-digit ID code for the individual you wish to call with rotating **[DIAL]**.

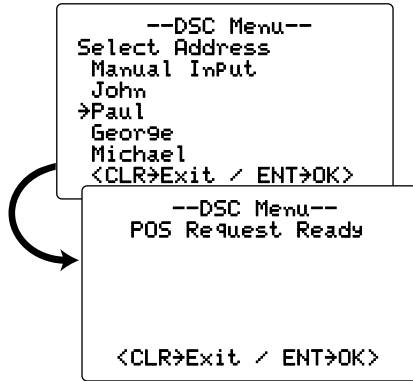

- ④ Push **[DIAL•ENTER]** to transmit the position request call.
- If Channel 70 is busy, the transceiver stands by until the channel becomes clear.

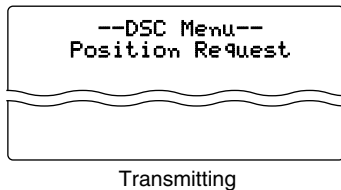

- ⑤ After the position request call has been transmitted, the following indication is displayed.

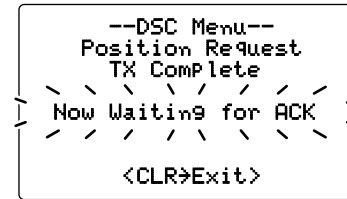

- ⑥ Push **[CLR]** to return to the previous indication before entering the DSC menu.
- Even if **[CLR]** hasn't been pushed, the display automatically returns to the previous indication after 2 sec. of inactivity.

## 6 DSC OPERATION

### ◆ Transmitting a position report call

Transmit a position report call when you want to announce your own position to a specific ship and to get an answer, etc.

- ① Push **[MENU]** to enter the DSC menu.
- ② Rotate **[DIAL]** to select "Position RePort," push **[DIAL•ENTER]**.
  - "Position InPut" item appears when a GPS receiver (NMEA0183 ver. 2.0 or 3.01) is not connected.

```
--DSC Menu--
Select Item
Position InPut
Individual Call
Group Call
All Ships Call
Position Request
→Position RePort
```

- ③ Rotate **[DIAL]** to select the desired pre-programmed individual address or "Manual InPut," push **[DIAL•ENTER]**.
  - The ID code can be set in advance. (p. 17)
  - When "Manual InPut" is selected, set the 9-digit ID code for the individual you wish to call with rotating **[DIAL]**.

```
--DSC Menu--
Select Address
Manual InPut
John
→Paul
George
Michael
<CLR>Exit / ENT>OK>
```

/// When a GPS receiver (NMEA0183 ver. 2.0 or 3.01) is connected, next steps ④, ⑤ (Current position/time programming) do not appear. Go to step ⑥.

- ④ The position information appears. Set your position (latitude and longitude) data with rotating **[DIAL]**.
  - Push **[16•9]** or **[CH/WX•DUAL•U/I/C]** to move the cursor forward or backward, respectively.
  - Rotate **[DIAL]** to edit N; North latitude or S; South latitude when the cursor is on the 'N' or 'S' position, and W; West longitude or E; East longitude when the cursor is on the 'W' or 'E' position.
  - Push **[CLR]** for 1 sec. to clear the latitude/longitude data.
  - Push **[CLR]** to cancel and exit the condition to the DSC menu.

```
--DSC Menu--
InPut Position
Latitude
> ■ . . . . . N      Null
Lc/n)gitude
  . . . . . W      Null
<CLR 1sec>Null Data>
<CLR>Exit / ENT>OK>
```

- ⑤ After setting the position data, push **[DIAL•ENTER]** to set the time information appears. Set the current UTC time with rotating **[DIAL]**, then push **[DIAL•ENTER]**.
  - Push **[16•9]** or **[CH/WX•DUAL•U/I/C]** to move the cursor forward or backward, respectively.
  - Push **[CLR]** for 1 sec. to clear the UTC time data.
  - Push **[CLR]** to cancel and exit the condition to the DSC menu.



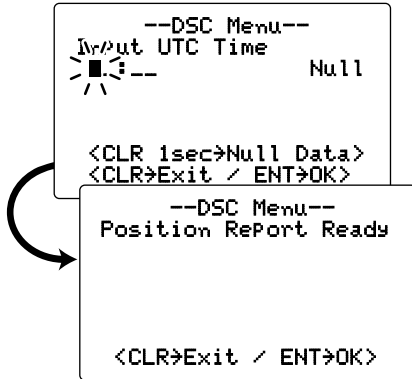

- ⑥ Push **[DIAL•ENTER]** to transmit the position report call.
- If Channel 70 is busy, the transceiver stands by until the channel becomes clear.

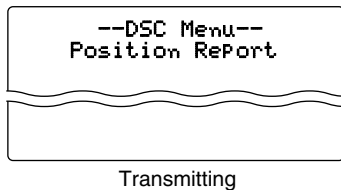

- ⑦ After the position report call has been transmitted, the following indication is displayed.



- ⑧ Push **[CLR]** to return to the previous indication before entering the DSC menu.
- Even if **[CLR]** hasn't been pushed, the display automatically returns to the previous indication after 2 sec. of inactivity.

## 6 DSC OPERATION

### ◆ Transmitting a polling request call

Transmit a polling request call when you want to know a specific ship is in the communication area, etc.

- ① Push **[MENU]** to enter the DSC menu.
- ② Rotate **[DIAL]** to select "Polling Request," push **[DIAL•ENTER]**.

```
--DSC Menu--
Select Item
Individual Call
Group Call
All Ships Call
Position Request
Position Report
→Polling Request
```

- ③ Rotate **[DIAL]** to select the desired pre-programmed individual address or "Manual Input," push **[DIAL•ENTER]**.
  - The ID code can be set in advance. (p. 17)
  - When "Manual Input" is selected, set the 9-digit ID code for the individual you wish to call with rotating **[DIAL]**.

```
--DSC Menu--
Select Address
Manual Input
John
→Paul
George
Michael
<CLR>Exit / ENT→OK>
```



```
--DSC Menu--
Polling Request Ready

<CLR>Exit / ENT→OK>
```

- ④ Push **[DIAL•ENTER]** to transmit the polling request call.
  - If Channel 70 is busy, the transceiver stands by until the channel becomes clear.

```
--DSC Menu--
Polling Request
```



Transmitting

- ⑤ After the polling request call has been transmitted, the following indication is displayed.

```

--DSC Menu--
Polling Request
TX Complete
}
Now Waiting for ACK
}
<CLR>Exit>

```

- ⑥ Push **[CLR]** to return to the previous indication before entering the DSC menu.
- Even if **[CLR]** hasn't been pushed, the display automatically returns to the previous indication after 2 sec. of inactivity.

### ◆ Transmitting a position request reply call

Transmit a position request reply call when a position request call is received.

- ① Push **[MENU]** to enter the DSC menu.
- ② Rotate **[DIAL]** to select "Position Reply," push **[DIAL•ENTER]**.
  - "Position Reply" item appears after a position request call is received.

```

--DSC Menu--
Select Item
Position Input
Individual Call
Group Call
All Ships Call
Position Request
>Position Reply

```

- ③ Rotate **[DIAL]** to select the desired individual address or ID code, push **[DIAL•ENTER]**.

```

--DSC Menu--
Select Address
John
>Paul
George
Michael

<CLR>Exit / ENT>OK>

```

## 6 DSC OPERATION

When a GPS receiver (NMEA0183 ver. 2.0 or 3.01) is connected, next steps ④, ⑤ (Current position/time programming) do not appear. Go to step ⑥.

④ The position information appears. Set your position (latitude and longitude) data with rotating [DIAL].

- Push [16•9] or [CH/WX•DUAL•U//C] to move the cursor forward or backward, respectively.
- Rotate [DIAL] to edit N; North latitude or S; South latitude when the cursor is on the 'N' or 'S' position, and W; West longitude or E; East longitude when the cursor is on the 'W' or 'E' position.
- Push [CLR] for 1 sec. to clear the latitude/longitude data.
- Push [CLR] to cancel and exit the condition to the DSC menu.

```

--DSC Menu--
Input Position
Latitude
> ■  - - - - - N      Null
Longitude
  ■  - - - - - W      Null
<CLR 1sec>Null Data>
<CLR>Exit / ENT>OK>
    
```

⑤ After setting the position data, push [DIAL•ENTER] to set the time information appears. Set the current UTC time with rotating [DIAL], then push [DIAL•ENTER].

- Push [16•9] or [CH/WX•DUAL•U//C] to move the cursor forward or backward, respectively.
- Push [CLR] for 1 sec. to clear the UTC time data.
- Push [CLR] to cancel and exit the condition to the DSC menu.

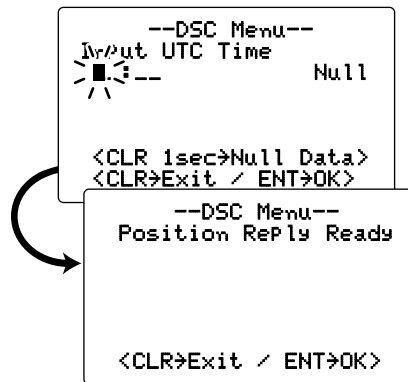

⑥ Push [DIAL•ENTER] to transmit the position request reply call to the selected station.

- Your position data is transmitted, when [DIAL•ENTER] is pushed.

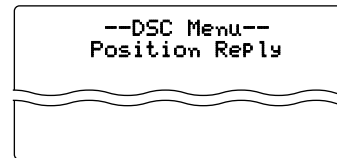

Transmitting

### ◆ Transmitting a position report reply call

Transmit a position report reply call when a position report call is received.

- ① Push **[MENU]** to enter the DSC menu.
- ② Rotate **[DIAL]** to select "POS RePort RePly," push **[DIAL•ENTER]**.
  - "POS RePort RePly" item appears after a position report call is received.

```

--DSC Menu--
Select Item
Individual Call
Group Call
All ShiPs Call
Position Request
Position RePort
➔POS RePort RePly
    
```

- ③ Rotate **[DIAL]** to select the desired individual address or ID code, push **[DIAL•ENTER]**.

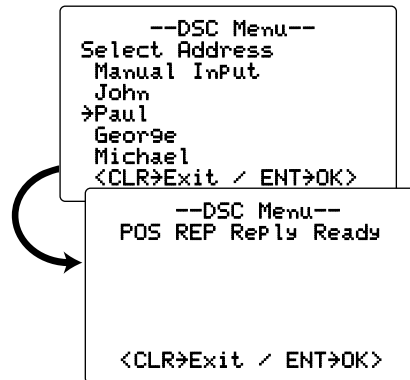

- ④ Push **[DIAL•ENTER]** to transmit the position report reply call to the selected station.

```

--DSC Menu--
Position RePort RePly
    
```

Transmitting

## 6 DSC OPERATION

### ◆ Transmitting a polling request reply call

Transmit a polling reply call when a polling request call is received.

- ① Push **[MENU]** to enter the DSC menu.
- ② Rotate **[DIAL]** to select "Polling Reply," push **[DIAL•ENTER]**.
  - "Polling Reply" item appears after a polling request call is received.

```
      --DSC Menu--  
Select Item  
Group Call  
All Ships Call  
Position Request  
Position Report  
Polling Request  
→Polling Reply
```

- ③ Rotate **[DIAL]** to select the desired individual address or ID code, push **[DIAL•ENTER]**.

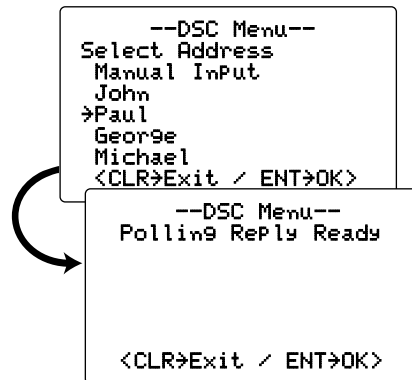

- ④ Push **[DIAL•ENTER]** to transmit the polling request call to the selected station.

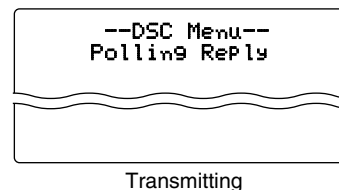

## ■ Receiving DSC calls

### ◇ Receiving a distress call

While monitoring Channel 70 and a distress call is received:

- ➔ The emergency alarm sounds for 2 minutes.
  - Push [CLR] to stop the alarm.
- ➔ “Received Distress” appears in the display, then Channel 16 is automatically selected.
- ➔ Continue monitoring Channel 16 as a coast station may require assistance.

```

25W   INT
      TAG
Received
Distress
<Paul
<CLR>
Beep Off>  16
                CALLING
  
```

### ◇ Receiving a distress acknowledgement

While monitoring Channel 70 and a distress acknowledgement to other ship is received:

- ➔ The emergency alarm sounds for 2 minutes.
  - Push [CLR] to stop the alarm.
- ➔ “Received DistressACK” appears in the display, then Channel 16 is automatically selected.

```

25W   INT
      TAG
Received
DistressACK
<Osaka Bay
<CLR>
Beep Off>  16
                CALLING
  
```

### ◇ Receiving a distress relay call

While monitoring Channel 70 and a distress relay acknowledgement is received:

- ➔ The emergency alarm sounds for 2 minutes.
  - Push [CLR] to stop the alarm.
- ➔ “Received DistressRLY” appears in the display, then Channel 16 is automatically selected.

```

25W   INT
      TAG
Received
DistressRLY
<John
<CLR>
Beep Off>  16
                CALLING
  
```

## 6 DSC OPERATION

### ◇ Receiving an individual call

While monitoring Channel 70 and an individual call is received:

- The emergency alarm or beeps sound depending on the received category.
- “Received Individual” appears in the display.
- Push [CLR] to stop the beep, then push [DIAL•ENTER] to reply the call and select the channel specified by the calling station for voice communication (depending on your reply condition see p. 28 for individual acknowledgement call procedure for details.); push [CLR] to ignore the individual call.

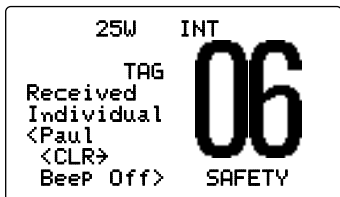

### ◇ Receiving a group call

While monitoring Channel 70 and a group call is received:

- The emergency alarm or beeps sound depending on the received category.
- “Received Group” appears in the display.
- Push [CLR] to stop the beep, then push [DIAL•ENTER] to select the channel specified by the calling station for voice communication; push [CLR] to ignore the group call.

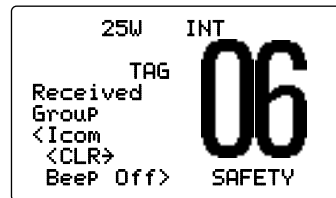

### ◇ Receiving an all ships call

While monitoring Channel 70 and an all ships call is received:

- The emergency alarm sounds when the category is ‘Distress’ or ‘Urgency’; beeps sound for 2 minutes.
- “Received All Ships” appears in the display.
- Push [CLR] to stop the beep, then push [DIAL•ENTER] to monitor channel 16 for an announcement from the calling vessel, push [CLR] to ignore the call.



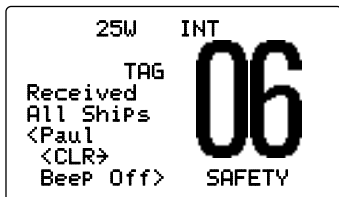

### ◆ Receiving a geographical area call

While monitoring Channel 70 and a geographical area call (for the area you are in) is received:

- ➔ Emergency alarm or beeps sound depending on the received category.
- ➔ “Received GeoGraphic” appears in the display.



- ➔ Push [CLR] to stop the beep, then push [DIAL•ENTER] to change to the channel specified by the calling station for voice communication; push other key to ignore the geographical area call.

- ➔ Monitor the selected channel for an announcement from the calling station.

When no GPS receiver is connected or if there is a problem with the connected receiver, all geographical area calls are received, regardless of your position.

### ◆ Receiving a position request call

While monitoring Channel 70 and a position request call is received:

- ➔ “Received POS Request” appears in the display.
- ➔ Push [CLR] to stop the beep, then push [DIAL•ENTER] to reply to the position request call; push [CLR] to ignore the position request call.

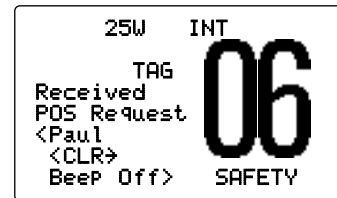

### ◆ Receiving a position report call

While monitoring Channel 70 and a position report call is received:

- ➔ “Received POS Report” appears in the display.
- ➔ Push [CLR] to stop the beep, then push [DIAL•ENTER] to reply to the position report call; push [CLR] to ignore the position report call.

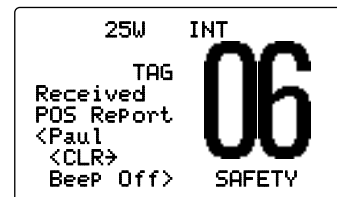

## 6 DSC OPERATION

### ◆ Receiving a polling request call

While monitoring Channel 70 and a polling request call is received:

- “Received POLL REQ” appears in the display.
- Push [CLR] to stop the beep, then push [DIAL•ENTER] to reply to the call; push [CLR] to ignore the call.



### ◆ Receiving a position request reply call

While monitoring Channel 70 and a position request reply call is received:

- “Received POS RePly” appears in the display.
- Push [CLR] to stop the beep, then push [DIAL•ENTER] to display the position information; push [CLR] to ignore the reply call.



### ◆ Receiving a position report reply call

While monitoring Channel 70 and a position report reply call is received:

- “Received POS RePly” appears in the display.
- Push [CLR] to stop the beep, then push [DIAL•ENTER] to display the position information; push [CLR] to ignore the reply call.

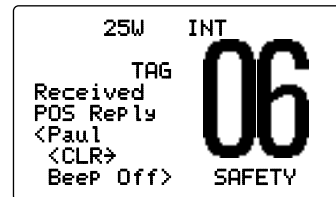

### ◆ Receiving a polling request reply call

While monitoring Channel 70 and a polling request reply call is received:

- “Received POLL RePly” appears in the display.
- Push [CLR] to stop the beep, then push [DIAL•ENTER] to display the position information; push [CLR] to ignore the reply call.

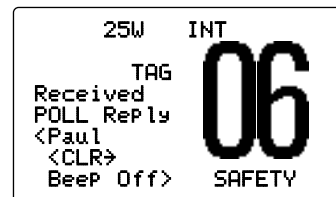

## ■ Received messages

The transceiver automatically stores up to 20 distress messages and 20 other messages. The messages can be used as an assistance to the logbook.

- ① Push **[MENU]** to enter the DSC menu.
- ② Rotate **[DIAL]** to select "Received Calls," push **[DIAL•ENTER]**.

```

--DSC Menu--
Select Item
Position Reply
Position Report
POS Report Reply
Polling Request
Polling Reply
>Received Calls
  
```

### ◇ Distress message

- ① Rotate **[DIAL]** to select "Distress," push **[DIAL•ENTER]**.

```

--DSC Menu--
Select Message
>Distress
Other

<CLR>Exit / ENT>OK>
  
```

- ② Rotate **[DIAL]** to scroll to the desired message, push **[DIAL•ENTER]**.

• Messages which are blinking have not read.

```

--DSC Menu--
Select Message
->12:15 John
 07:13 George

<CLR>Exit / ENT>OK>
  
```

- ③ Rotate **[DIAL]** to scroll the message.

Rotate



```

--DSC Menu--
Distress
<John
Explosion
LAT:12°34.567N
LON:123°45.678W
UTC:12:15
DISTANCE:100.8nm
BEARING:12.25°
<CLR>Exit/CLR 1s>Del>
  
```

- ④ Push **[CLR]** to exit the condition or push **[CLR]** for 1 sec. to delete the displayed message and returns to DSC menu.

## 6 DSC OPERATION

### ◆ Other messages

- ① Rotate [DIAL] to select "Other," push [DIAL•ENTER].

```
--DSC Menu--
Select Message
Distress
→Other

<CLR>Exit / ENT→OK>
```

- ② Rotate [DIAL] to scroll to the desired message, push [DIAL•ENTER].

- Messages which are blinking have not read.

```
--DSC Menu--
Select Message
→Individual Call
  You Call
  Position RePlay
  All Ships Call

<CLR>Exit / ENT→OK>
```

- ③ Rotate [DIAL] to scroll the message.
- The stored message has various information and depending on the type of distress call.

```
--DSC Menu--
Individual Call
<Paul
Routine
F3E simplex
CH 08

<CLR>Exit/CLR 1s→Del>
```

- ④ Push [CLR] to exit the condition or push [CLR] for 1 sec. to delete the displayed message and returns to DSC menu.



## 6 DSC OPERATION

### ◆ Automatic acknowledgement

This item sets the automatic acknowledgement function ON or OFF.

When a position request, position report or polling request call is received, transceiver automatically transmits a position request reply, position report reply or polling reply call, respectively.

- ① Push **[MENU]** to enter the DSC menu.
- ② Rotate **[DIAL]** to select "Set. uP," push **[DIAL•ENTER]**.

```
--DSC Menu--
Select Item
POS RePort RePlY
Polling Request
Polling Reply
Received Calls
Distress Setting
→Set uP
```

- ③ Rotate **[DIAL]** to select "Auto ACK," push **[DIAL•ENTER]**.

```
--DSC Menu--
Select Item
Add:Group ID
DEL:INDU ID
DEL:Group ID
Offset Time
MMSI Check
→Auto ACK
```

- ④ Rotate **[DIAL]** to turn the automatic acknowledgement function ON or OFF.

```
--DSC Menu--
Auto ACK
→ON
OFF

<CLR>Exit / ENT→OK>
```

- ⑤ Push **[DIAL•ENTER]** to set the condition.
  - Push **[CLR]** to cancel and exit the condition to the set up menu.

### ◆ NMEA Output

Select the NMEA Output function OFF, All station or List station.

When receiving position acknowledgment, transceiver outputs it to the external equipment via the NMEA connector.

- ① Push **[MENU]** to enter the DSC menu.
- ② Rotate **[DIAL]** to select "Set uP," push **[DIAL•ENTER]**.

```

--DSC Menu--
Select Item
POS Report Reply
Polling Request
Polling Reply
Received Calls
Distress Setting
>Set uP

```

- ③ Rotate **[DIAL]** to select "NMEA Output," push **[DIAL•ENTER]**.

```

--DSC Menu--
Select Item
DEL:INDU ID
DEL:Group ID
Offset Time
MMSI Check
Auto ACK
>NMEA Output

```

- ④ Rotate **[DIAL]** to select the NMEA Output function OFF, All station or List station.
  - List Station: Outputs the position data from the specified vessels listed on the DSC individual ID screen.
  - All Station : Outputs the position data from all vessels.
  - OFF : No outputs any position data to external equipment.

```

--DSC Menu--
NMEA OutPut
>List Station
All Station
OFF

<CLR>Exit / ENT>OK>

```

- ⑤ Push **[DIAL•ENTER]** to set the condition.
  - Push **[CLR]** to cancel and exit the condition to the set up menu.

## ■ Intercom operation

The optional Intercom function allows you to talk to the deck from the cabin. The optional command microphone is required for Intercom operation.

Connect an optional command microphone as described on p. 63.

- Transmitting is impossible during Intercom operation.
- The received signal is muted during Intercom operation.

- ① Push and hold **[LO/DX•IC•SCRM]** for 1 sec. to enter Intercom mode.
  - The optional command microphone power is automatically turned ON, even if the power is OFF.

Push and hold  for 1 sec.



IC-M504/HM-162

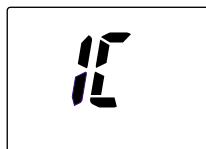

HM-157

- ② Push and hold **[LO/DX•IC•SCRM]** for 1 sec. again to call up the optional command microphone side.
  - The transceiver and the optional command microphone emit call beeps.

- ③ Push and hold **[PTT]** and speak at a normal voice level into the microphone.
  - "TALK" or "LISTEN"\* appears on the caller or listener function display, respectively.
    - \* "TALK" or "LSTN" appears on the HM-157.
  - To adjust the IC-M504's speaker output level, rotate **[VOL]**.
  - To adjust the HM-162's speaker output level, rotate **[SELECTOR]** on the HM-162.
  - To adjust the HM-157's speaker output level, push **[▲]** or **[▼]** after pushing **[VOL•DIM PA/RX ◀▶]** on the HM-157.



IC-M504 (caller)



HM-162 (listener)



HM-157 (listener)

- ④ After releasing **[PTT]** you can hear the response through the speaker.
- ⑤ To return to the normal operation, push **[LO/DX•IC•SCRM]** momentarily.
  - **[16•9]** and **[DISTRESS]** keys are also available.



- While in the Intercom mode, the transceiver functions (transmit and receive) are interrupted. If the transceiver is in transmit condition, the Intercom function is not available.
- When a DSC call is received, the intercom function is interrupted with an automatic return to the transceiver mode. The transceiver's display indicates 'Receiving DSC calls.' (p. 41)
- When a WX alert is received, "WX ALERT" blinks and a beep sounds. The WX alert sounds after the Intercom use is finished.

## ■ RX Speaker function

The IC-M504 has an RX Speaker function. When this function is turned ON, the received audio can be heard on the deck or tower via an external speaker or hailer speaker.

Connect an external speaker or hailer speaker as described on p. 58.

- ① Push and hold **[HAIL•RX ⏏]** for 1 sec. to enter the RX Speaker mode.
  - "RX ⏏" appears
  - To adjust the audio output level, rotate **[DIAL]**.

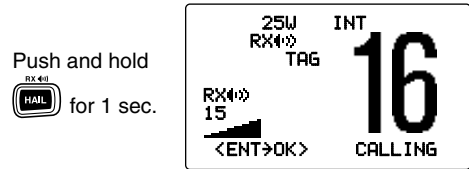

- ② To return to normal operation, push and hold **[HAIL•RX ⏏]** for 1 sec.

### ■ Hailer operation

The IC-M504 has a 2-way hailer function for voice amplification and reception over a loudspeaker, making it unnecessary to leave the bridge to hear a hailing party.

Connect an external hailer speaker (25 W nominal at 13.8 V/4 Ω) as described on p. 58.

- Transmitting is not possible during hailer operation.
- The received signal is muted during hailer operation.

① Push [**HAIL•RX** 

Push 





- ② Push and hold [**PTT**] and speak at a normal voice level into the microphone.
- “**TALK**” or “**LISTEN**” appears on the caller or listener function display, respectively.
  - To adjust the hailer level , rotate [**DIAL**].
- ③ After releasing [**PTT**] you can hear the response through the speaker.
- ④ To return to normal operation, push [**CLR**] or [**HAIL•RX** 

- While in the hailer mode, the transceiver functions (transmit and receive) are interrupted. If the transceiver is in transmit condition, the hailer function is not available.
- When a DSC call is received, the hailer function is interrupted with an automatic return to the transceiver mode. The transceiver’s display indicates ‘Receiving DSC calls.’ (p. 41)

## ■ Automatic foghorn function

The automatic foghorn function sounds a horn repeatedly until the function is turned OFF. Four patterns are available for varying conditions.

The foghorn outputs from the hailer speaker. To use this function, the hailer speaker must be connected to the transceiver. See p. 58 for connection details.

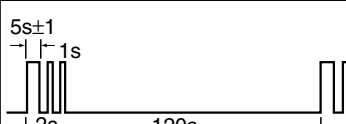
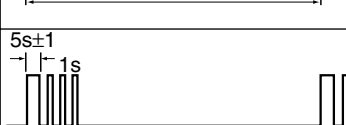
TYPE	PATTERN		USAGE
<b>UNDERWAY</b>	One 5-second blasts every 120 seconds.		Motor vessel underway and making way.
<b>STOP</b>	Two 5-second blasts (separated by 2 seconds) every 120 seconds.		Motor vessel underway but stopped (not making way).
<b>SAIL</b>	One 5-second blast followed by two 1-second blasts (each separated by 2 seconds) every 120 seconds.		Sailing vessel underway, fishing vessel (underway or anchored), vessel not under command, a vessel restricted in her ability to maneuver (underway or at anchor), or a vessel towing or pushing another ahead.
<b>TOW</b>	One 5-second blast followed by three 1-second blasts (each separated by 2-seconds) every 120 seconds.		Vessel under tow (manned).

/// The audio frequency of the foghorn is selectable. See p. 57 for details on selecting the audio frequency.

## 7 OTHER FUNCTIONS

- ① While pushing and holding [H/L], push [HAIL•RX] to enter auto foghorn mode.

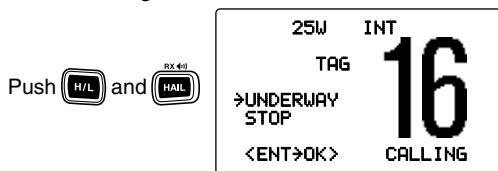

- ② Rotate [DIAL] to select the desired foghorn pattern, push [DIAL•ENTER].

- 'UNDERWAY', 'STOP', 'SAIL', 'TOW' are available. (p. 53)
- Even if [DIAL•ENTER] hasn't been pushed, the display automatically changes to the next step after 2 sec. of inactivity.

- ③ Rotate [DIAL] to adjust the foghorn level, push [DIAL•ENTER].

- The foghorn level is adjustable in 30 steps.
- Even if [ENT] hasn't been pushed, the display automatically changes to the next step after 2 sec. of inactivity.

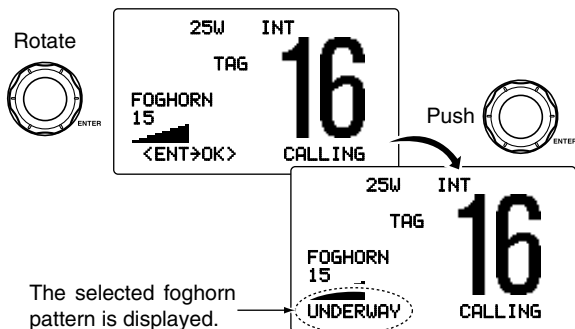

- ④ To return to normal operation, repeat step ①.

When a DSC call is received, the automatic foghorn function is interrupted with an automatic return to the transceiver mode. The transceiver's display indicates 'Receiving DSC calls.' (p. 41)

## ■ Set mode programming

Set mode is used to change the conditions of the transceiver's functions: Scan type, Scan resume timer, Weather alert, Dual/Tri-watch, Beep tone, LCD contrast, Automatic foghorn frequency, Radio power, Scrambler type\* and Scrambler code.\*

\*Appears only when the optional scrambler unit is installed.

/// Available functions may differ depending on dealer setting.

- ① Turn power OFF.
- ② While pushing and holding [16•9], turn power ON to enter Set mode.
- ③ After the display appears, release [16•9].
- ④ Rotate [DIAL] to select the desired item, push [DIAL•ENTER].
- ⑤ Rotate [DIAL] to select the desired condition of the item.
- ⑥ Push [CLR], or rotate [DIAL] to select "Exit," then push [DIAL•ENTER] to exit set mode and returns to normal operation condition.

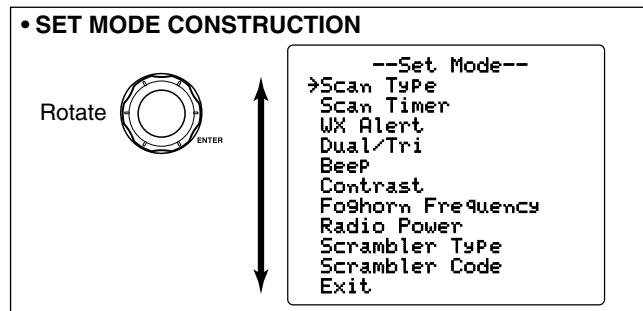

## ■ Set mode items

### ◇ Scan type

The transceiver has 2 scan types: Normal scan and Priority scan. Normal scan searches all TAG channels in the selected channel group. Priority scan searches all TAG channels in sequence while monitoring Channel 16.

```

--Set Mode--
Scan-Type
Priority
->Normal

<ENT>OK>
                    
```

Default: Normal

### ◇ Scan resume timer

The scan resume timer can be selected as a pause (OFF) or timer scan (ON). When OFF is selected, the scan pauses until the signal disappears. When ON is selected, the scan pauses 5 sec. and resumes even if a signal has been received on any other channel than Channel 16.

```

--Set Mode--
Scan Timer
ON
->OFF

<ENT>OK>
                    
```

Default: OFF

## 8 SET MODE

### ◆ Weather alert

A NOAA broadcast station transmits a weather alert tone before important weather information.

When "ON" is selected, the previously selected (used) weather channel is checked any time during standby or while scanning. When "ON with WX SCAN" is selected, the weather channels are checked in sequence during standby or while scanning.

The "WX ALERT" indicator blinks until the transceiver is operated after the transceiver detects the alert.

- "WX ALERT" appears instead of "WX" indication when the function is set ON.

```
      --Set Mode--
WX Alert
ON
ON with WX SCAN
➔OFF

      <ENT➔OK>
```

Default: OFF

### ◆ Dual/Tri-watch

This item can be selected as Dualwatch or Tri-watch. (p. 14)

```
      --Set Mode--
Dual/Tri
Tri-watch
➔Dualwatch

      <ENT➔OK>
```

Default: Dualwatch

### ◆ Beep tone

You can select the silent operation by turning beep tones OFF or you can have confirmation beeps sound at the push of a key by turning beep tones ON.

```
      --Set Mode--
Beep
➔ON
OFF

      <ENT➔OK>
```

Default: ON

### ◆ LCD contrast

The LCD contrast can be adjustable in 8 levels. The level 1 is the lowest contrast, and the level 8 is the highest contrast.

```
      --Set Mode--
Contrast
➔5
4
3
2
1

      <ENT➔OK>
```

Default: 5

### ◇ Automatic foghorn frequency

The audio frequency of the automatic foghorn can be adjusted to suit your preference. While this item is selected, pushing [PTT] outputs the foghorn— experiment with the frequencies available until you find one you like.

- Available frequency range is 200 Hz to 850Hz in 50 Hz step.

```

--Set Mode--
Foghorn Frequency
→400
 350
 300
 250
 200
<ENT>OK>

```

Default: 400

### ◇ Radio power

This item sets the Radio Power function ON or OFF.

**ON** : The transceiver's power is controlled by the optional command microphone. When the command microphone is turned OFF, the transceiver will also be turned OFF automatically.

**OFF** : The transceiver's power is not controlled by the optional command microphone. Even if the command microphone is turned OFF, the transceiver will continue to work.

```

--Set Mode--
Radio Power
→ON
 OFF
<ENT>OK>

```

Default: ON

### ◇ Scrambler type

(Appears when a scrambler unit is installed)

When an optional scrambler unit is installed, the scrambler type can be selected in set mode depending on dealer setting.

```

--Set Mode--
Scrambler Type
UT-98
→UT-112
<ENT>OK>

```

Default: UT-112

### ◇ Scrambler code

(Appears when a scrambler unit is installed)

When an optional scrambler unit is installed, the scrambler code can be set depending on dealer setting.

When the UT-112 is installed, 32 codes (1 to 32) can be selected.

When the UT-98 is installed, 128 codes (0 to 127) can be selected.

(When UT-112 is installed)

```

--Set Mode--
Scrambler Code
5
4
3
2
→1
<ENT>OK>

```

Default: 1

(When UT-98 is installed)

```

--Set Mode--
Scrambler Code
4
3
2
1
→0
<ENT>OK>

```

Default: 0

## Connections

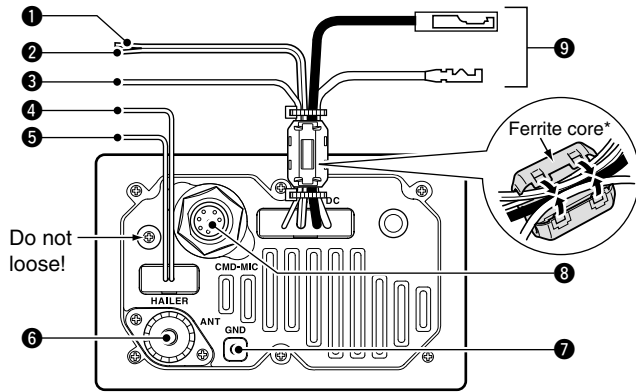

### 1 NMEA IN LEAD (Red)

Connects to a GPS receiver for position indication.

- A NMEA0183 ver. 2.0 or 3.01 (sentence formatters RMC, GGA, GNS, GLL) compatible GPS receiver is required. Ask your dealer about suitable GPS receivers.

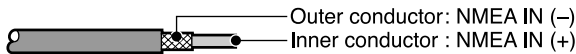

### 2 NMEA OUT LEAD (White)

Connects to a PC or navigation equipment (NMEA0183 ver. 3.01 sentence formatters DSC, DSE compatible) for position data received from other ships.

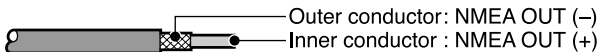

### 3 EXTERNAL SPEAKER LEAD (Yellow)

Connects to an external speaker.

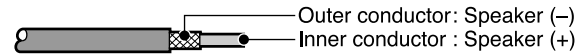

### 4 HAILER/FOGHORN (-) LEAD (Black)

Connects to a hailer speaker (25 W nominal at 13.8 V/4 Ω).

### 5 HAILER/FOGHORN (+) LEAD (Blue)

Connects to a hailer speaker (25 W nominal at 13.8 V/4 Ω).

### 6 ANTENNA CONNECTOR

Connects a marine VHF antenna with a PL-259 connector to the transceiver.

**CAUTION:** Transmitting without an antenna may damage the transceiver.

### 7 GROUND TERMINAL

Connect this terminal to a vessel ground to prevent electrical shocks and interference from other equipment occurring. Use a self-tapping screw (3 × 8 mm.)

### 8 EXTERNAL MICROPHONE JACK

Connects to optional command microphone.

### 9 DC POWER CONNECTOR

Connects the supplied DC power cable from this connector to an external 12 V battery.



**CAUTION:** After connecting the DC power cable, NMEA IN/OUT leads, external speaker lead and hailer lead, cover the connector and leads with an adhesive tape as shown below, to prevent water seeping into the transceiver.

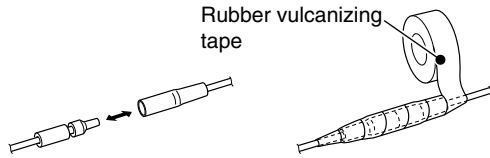

\* The supplied ferrite core must be attached to the NMEA in/out leads and DC power cables as illustrated at left. Fix the ferrite core near the transceiver with the two supplied ties to prevent it from moving.

## Supplied accessories

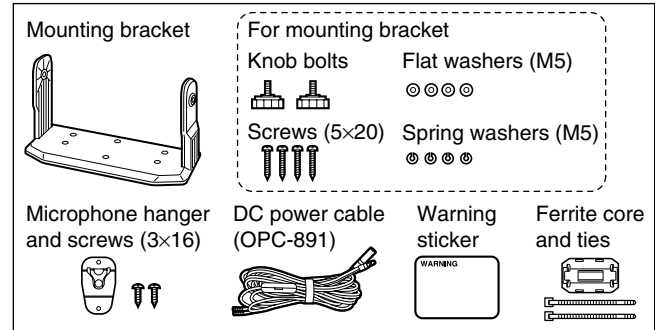

## Antenna

A key element in the performance of any communication system is the antenna. Ask your dealer about antennas and the best place to mount them.

## Fuse replacement

One fuse is installed in the supplied DC power cable. If a fuse blows or the transceiver stops functioning, track down the source of the problem, if possible, and replace the damaged fuse with a new one of the proper rating.

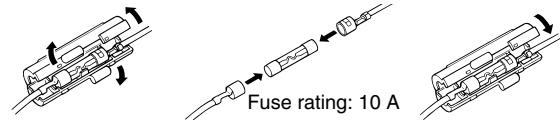

### ■ Mounting the transceiver

#### ◆ Using the supplied mounting bracket

The universal mounting bracket supplied with your transceiver allows overhead or dashboard mounting.

- Mount the transceiver securely with the 4 supplied screws (5 × 20) to a surface which is more than 10 mm thick and can support more than 5 kg.
- Mount the transceiver so that the face of the transceiver is at 90° to your line of sight when operating it.

**CAUTION:** KEEP the transceiver and microphone at least 1 meter away from your vessel's magnetic navigation compass.

**NOTE:** Check the installation angle; the function display may not be easy-to-read at some angles.

#### • OVERHEAD MOUNTING

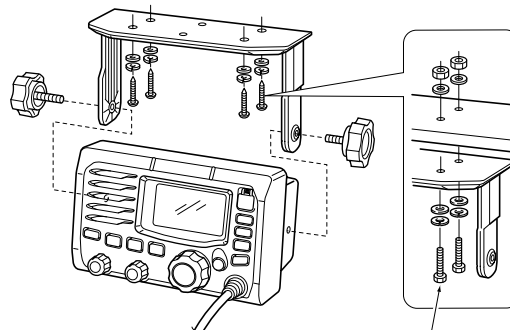

#### • MOUNTING ON THE BOARD

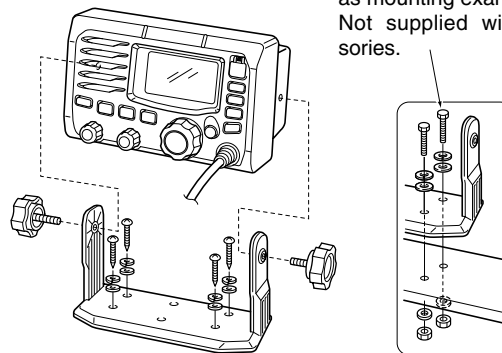

These screws are shown as mounting example only. Not supplied with accessories.

## ■ MB-75 installation

An optional MB-75 FLUSH MOUNT is available for mounting the transceiver to a flat surface such as an instrument panel.

**CAUTION:** KEEP the transceiver and microphone at least 1 meter away from your vessel's magnetic navigation compass.

- ① Using the template on the last page, carefully cut a hole into the instrument panel (or wherever you plan to mount the transceiver).
- ② Slide the transceiver through the hole as shown below.

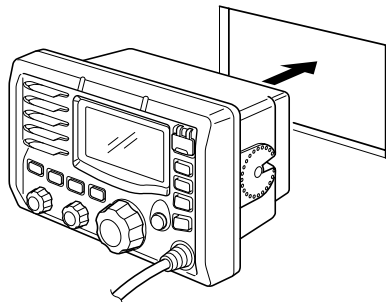

- ③ Attach the 2 supplied bolts (M5 × 8 mm) on either side of the IC-M504.
- ④ Attach the clamps on either side of the IC-M504.
  - Make sure that the clamps align parallel to the IC-M504's body.

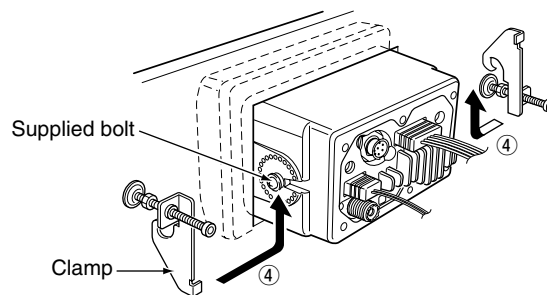

- ⑤ Tighten the end bolts on the clamps (rotate clockwise) so that the clamps press firmly against the inside of the instrument control panel.
- ⑥ Tighten the locking nuts (rotate counterclockwise) so that the IC-M504 is securely mounted in position as below.

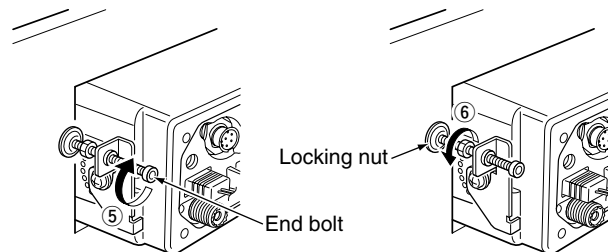

- ⑦ Connect the antenna and power cable, then return the instrument control panel to its original place.

### ■ UT-98/UT-112 installation

**CAUTION: DISCONNECT** the DC power cable from the transceiver before performing any work on the transceiver. Otherwise, there is danger of electric shock and/or equipment damage.

Follow the case opening procedure shown here when you want to install an optional scrambler unit.

- ① Remove the 6 screws as shown below and open the transceiver.

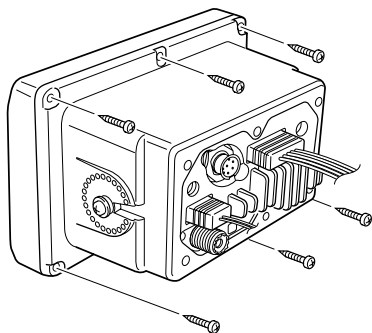

- ② Disconnect the flat cable and NMEA (4 pin) from J5 of the LOGIC unit.

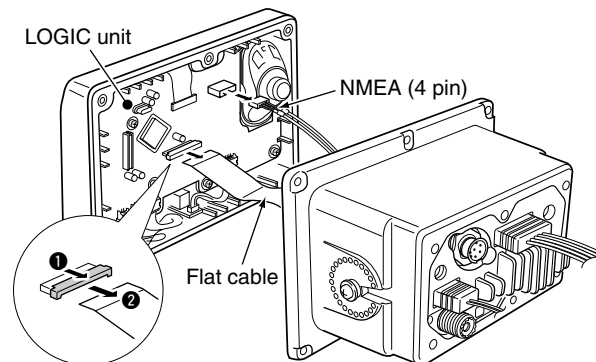

- ③ Install an optional unit (UT-98 or UT-112) to J3 on the AF unit as shown below.

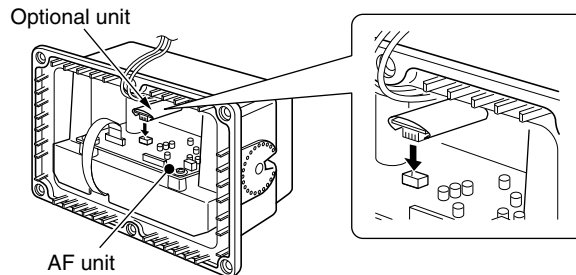

- ④ Return the cables and screws to the original position.
- Be sure not upside down the flat cable.

**CAUTION:**

- When re-assembling the case and tightening the screws, you must keep the specified torque ( $0.7\pm 0.1$  N.m). Otherwise the transceiver may be damaged (torque too high) or lose waterproof efficiency (torque too low).
- When uninstalling the optional unit, remove it vertically. Wiggling the unit from side to side may damage the optional unit's connector.

## ■ HM-157/HM-162 installation

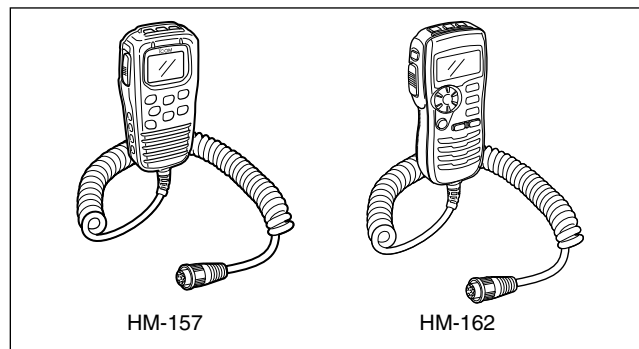

The optional HM-157/HM-162 can be connected to the transceiver directly, as well as via the supplied connection cable for longer distance remote operation. The connector of the connection cable can be installed into a cabinet, wall, etc., as a built-in plug.

For longer distance remote operation, the optional extension cable, OPC-999/OPC-1541\* (6 m; 20 ft/connecting between transceiver and the connection cable), is available, and up to two OPC-999/OPC-1541\* can be added.

\*OPC-999 : For the HM-157

OPC-1541 : For the HM-162

Do not connect the HM-162 to the OPC-999, and the HM-157 to the OPC-1541.

## 9 CONNECTIONS AND MAINTENANCE

- ① Insert the supplied cable into the external microphone jack and tighten the cable nut as shown below.

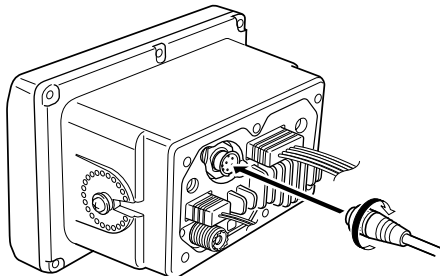

- ② To use the supplied cable as a wall socket, follow the below steps.  
③ Using the mounting base, carefully mark off the two spots where the cable and screws will be fastened.  
④ Drill holes at these marks.

- ⑤ Install the mounting base using the supplied screws as shown below.

### • HM-157

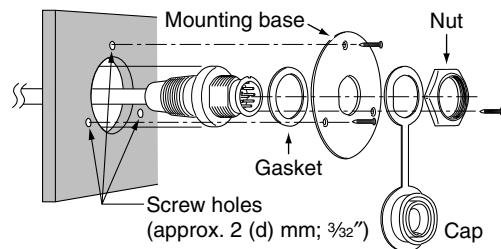

### • HM-162

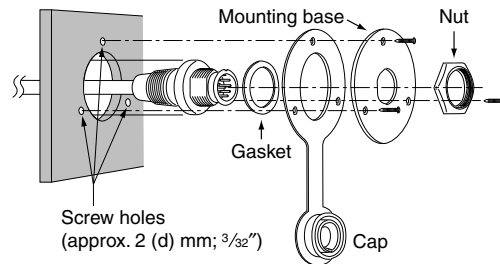

⑥ The completed installation should look like this.

• HM-157

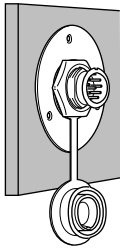

• HM-162

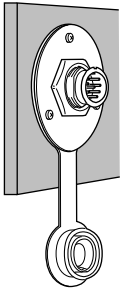

## 9 CONNECTIONS AND MAINTENANCE

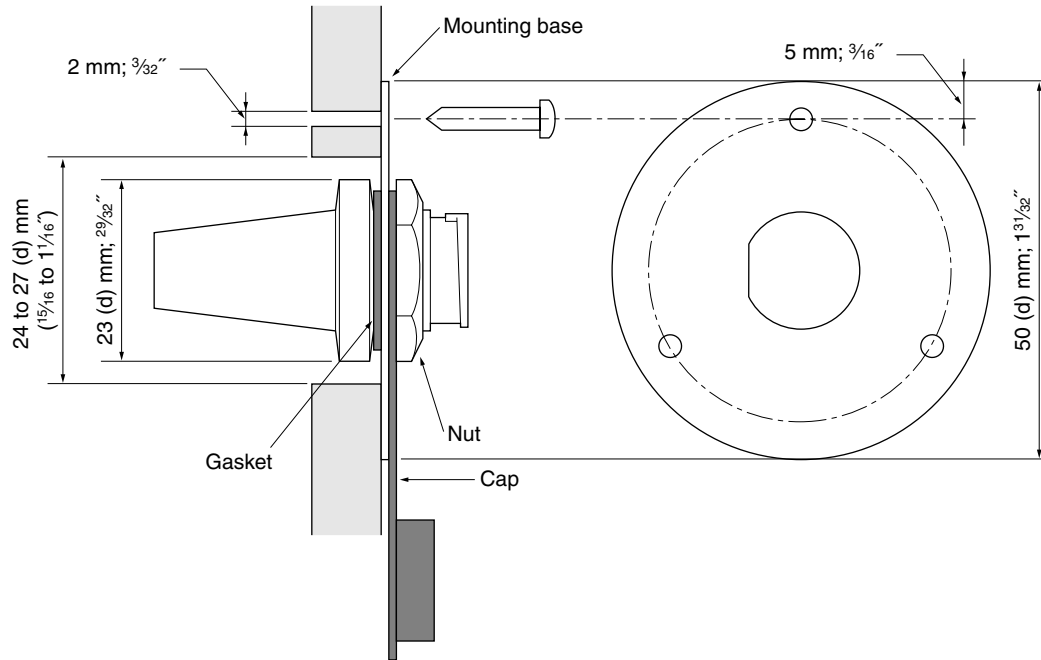



# TROUBLESHOOTING 10

PROBLEM	POSSIBLE CAUSE	SOLUTION	REF.
The transceiver does not turn ON.	<ul style="list-style-type: none"> <li>• Bad connection to the power supply.</li> </ul>	<ul style="list-style-type: none"> <li>• Check the connection to the transceiver.</li> </ul>	p. 58
No sound from speaker.	<ul style="list-style-type: none"> <li>• Squelch level is too high.</li> <li>• Volume level is too low.</li> <li>• Speaker has been exposed to water.</li> </ul>	<ul style="list-style-type: none"> <li>• Set <b>[SQL]</b> to the threshold point.</li> <li>• Set <b>[VOL]</b> to a suitable level.</li> <li>• Drain water from the speaker.</li> </ul>	p. 8 p. 8 —
Sensitivity is low.	<ul style="list-style-type: none"> <li>• The Attenuator is activated.</li> </ul>	<ul style="list-style-type: none"> <li>• Push <b>[LO/DX•IC•SCRM]</b> to turn the function OFF.</li> </ul>	p. 8
Transmitting is impossible, or high power can not be selected.	<ul style="list-style-type: none"> <li>• Some channels are for low power or receive only.</li> <li>• The output power is set to low.</li> </ul>	<ul style="list-style-type: none"> <li>• Change channels.</li> <li>• Push <b>[H/L]</b> to select high power.</li> </ul>	pgs. 6, 7, 70 p. 8
Scan does not start.	<ul style="list-style-type: none"> <li>• TAG channel is not programmed.</li> </ul>	<ul style="list-style-type: none"> <li>• Set the desired channels as TAG channels.</li> </ul>	p. 13
No beeps.	<ul style="list-style-type: none"> <li>• Beep tones are turned OFF.</li> <li>• The squelch is open.</li> </ul>	<ul style="list-style-type: none"> <li>• Turn the beep tone ON in Set mode.</li> <li>• Set <b>[SQL]</b> to the threshold point.</li> </ul>	p. 56 p. 8
Distress call cannot be transmitted.	<ul style="list-style-type: none"> <li>• MMSI (DSC self ID) code is not programmed.</li> </ul>	<ul style="list-style-type: none"> <li>• Program the MMSI (DSC self ID) code.</li> </ul>	p. 15

## ■ Specifications

### ◆ General

- Frequency coverage : Tx 156.025–157.425 MHz  
Rx 156.050–163.275 MHz
- Mode : FM (16K0G3E), DSC (16K0G2B)
- Channel spacing : 25 kHz
- Current drain (at 13.8 V) : TX high 5.5 A max.  
Max. audio 1.5 A max.
- Power supply requirement : 13.8 V DC  $\pm$ 15%  
(negative ground)
- Frequency stability :  $\pm$ 10 ppm  
(–20°C to +60°C; –4°F to +140°F)
- Antenna impedance : 50  $\Omega$  nominal
- Dimensions : 165(W)  $\times$  110(H)  $\times$  123.2(D) mm  
(Projections not included) 6 1/2(W)  $\times$  4 11/32(H)  $\times$  4 27/32(D) in
- Weight : Approx. 1450 g; 3 lb 19 oz

### ◆ Transmitter

- Output power : 25 W/1 W
- Modulation system : Variable reactance frequency modulation
- Max. frequency deviation :  $\pm$ 5.0 kHz
- Spurious emissions : Less than 70 dBc

### ◆ Receiver

- Receive system : Double conversion superheterodyne
- Sensitivity (12 dB SINAD) : 0.22  $\mu$ V (typical)
- Squelch sensitivity : Less than 0.32  $\mu$ V
- Intermodulation rejection ratio : More than 80 dB
- Spurious response rejection ratio : More than 80 dB
- Adjacent channel selectivity : More than 80 dB
- Audio output power : 4.5 W (typical) at 10% distortion with a 4  $\Omega$  load

**All stated specifications are subject to change without notice or obligation.**

### ◆ Dimensions

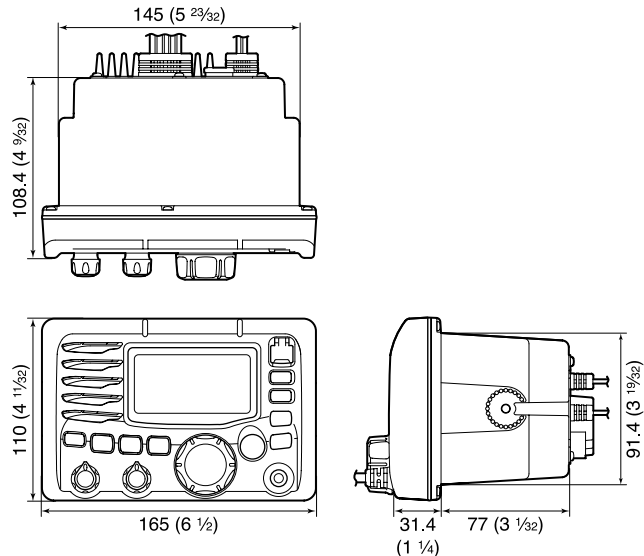

Unit: mm (inch)

## ■ Options

- **MB-75** FLUSH MOUNT KIT  
For mounting the transceiver to a panel.
- **HM-157** COMMANDMIC II™  
External microphone-type controller. Provides optional inter-com operation. 6 m (20 feet) microphone cable and mounting base included. Black and white colors are available. Do not connect the HM-157 to the OPC-1541.
- **HM-162** COMMANDMIC III™  
External microphone-type controller. Provides optional inter-com operation. 6 m (20 feet) microphone cable and mounting base included. Black and white colors are available. Do not connect the HM-162 to the OPC-999.
- **OPC-999** MICROPHONE EXTENSION CABLE  
6 m (20 feet) microphone extension cable for optional HM-157 COMMANDMIC II™. Up to 2 OPC-999 can be connected. (18 m; 60 feet maximum)
- **OPC-1541** MICROPHONE EXTENSION CABLE  
6 m (20 feet) microphone extension cable for optional HM-162 COMMANDMIC III™. Up to 2 OPC-1541 can be connected. (18 m; 60 feet maximum)
- **UT-112** VOICE SCRAMBLER UNIT  
Ensures private communications. 32 codes are available. Not available in some countries.
- **UT-98** VOICE SCRAMBLER UNIT  
Ensures private communications. 128 codes are available. Not available in some countries.

# 12 CHANNEL LIST

Channel number			Frequency (MHz)	
USA	INT	CAN	Transmit	Receive
	01	01	156.050	160.650
01A			156.050	156.050
	02	02	156.100	160.700
	03	03	156.150	160.750
03A			156.150	156.150
	04		156.200	160.800
		04A	156.200	156.200
	05		156.250	160.850
05A		05A	156.250	156.250
06	06	06	156.300	156.300
	07		156.350	160.950
07A		07A	156.350	156.350
08	08	08	156.400	156.400
09	09	09	156.450	156.450
10	10	10	156.500	156.500
11	11	11	156.550	156.550
12	12	12	156.600	156.600
13 <sup>2</sup>	13	13 <sup>1</sup>	156.650	156.650
14	14	14	156.700	156.700
15 <sup>2</sup>	15 <sup>1</sup>	15 <sup>1</sup>	156.750	156.750
16	16	16	156.800	156.800
17 <sup>1</sup>	17	17 <sup>1</sup>	156.850	156.850
	18		156.900	161.500
18A		18A	156.900	156.900
	19		156.950	161.550

Channel number			Frequency (MHz)	
USA	INT	CAN	Transmit	Receive
19A		19A	156.950	156.950
20	20	20 <sup>1</sup>	157.000	161.600
20A			157.000	157.000
	21	21	157.050	161.650
21A		21A	157.050	157.050
		21b	Rx only	161.650
	22		157.100	161.700
22A		22A	157.100	157.100
	23	23	157.150	161.750
23A			157.150	157.150
24	24	24	157.200	161.800
25	25	25	157.250	161.850
		25b	Rx only	161.850
26	26	26	157.300	161.900
27	27	27	157.350	161.950
28	28	28	157.400	162.000
		28b	Rx only	162.000
	60	60	156.025	160.625
	61		156.075	160.675
61A		61A	156.075	156.075
	62		156.125	160.725
		62A	156.125	156.125
	63		156.175	160.775
63A			156.175	156.175
	64	64	156.225	160.825

Channel number			Frequency (MHz)	
USA	INT	CAN	Transmit	Receive
64A		64A	156.225	156.225
	65		156.275	160.875
65A	65A	65A	156.275	156.275
	66		156.325	160.925
66A	66A	66A <sup>1</sup>	156.325	156.325
67 <sup>2</sup>	67	67	156.375	156.375
68	68	68	156.425	156.425
69	69	69	156.475	156.475
70 <sup>3</sup>	70 <sup>3</sup>	70 <sup>3</sup>	156.525	156.525
71	71	71	156.575	156.575
72	72	72	156.625	156.625
73	73	73	156.675	156.675
74	74	74	156.725	156.725
77 <sup>1</sup>	77	77 <sup>1</sup>	156.875	156.875
	78		156.925	161.525
78A		78A	156.925	156.925
	79		156.975	161.575
79A		79A	156.975	156.975
	80		157.025	161.625
80A		80A	157.025	157.025
	81		157.075	161.675
81A		81A	157.075	157.075
	82		157.125	161.725
82A		82A	157.125	157.125
	83	83	157.175	161.775

Channel number			Frequency (MHz)	
USA	INT	CAN	Transmit	Receive
83A		83A	157.175	157.175
		83b	Rx only	161.775
84	84	84	157.225	161.825
84A			157.225	157.225
85	85	85	157.275	161.875
85A			157.275	157.275
86	86	86	157.325	161.925
86A			157.325	157.325
87	87	87	157.375	161.975
87A			157.375	157.375
88	88	88	157.425	162.025
88A			157.425	157.425
WX channel		Frequency (MHz)		
		Transmit		Receive
1		RX only		162.550
2		RX only		162.400
3		RX only		162.475
4		RX only		162.425
5		RX only		162.450
6		RX only		162.500
7		RX only		162.525
8		RX only		161.650
9		RX only		161.775
10		RX only		163.275

<sup>1</sup>Low power only. <sup>2</sup>Momentary high power. <sup>3</sup>DSC operation only

**NOTE:** Simplex channels, 3, 21, 23, 61, 64, 81, 82 and 83 **CANNOT** be lawfully used by the general public in U.S.A. waters.

# TEMPLATE

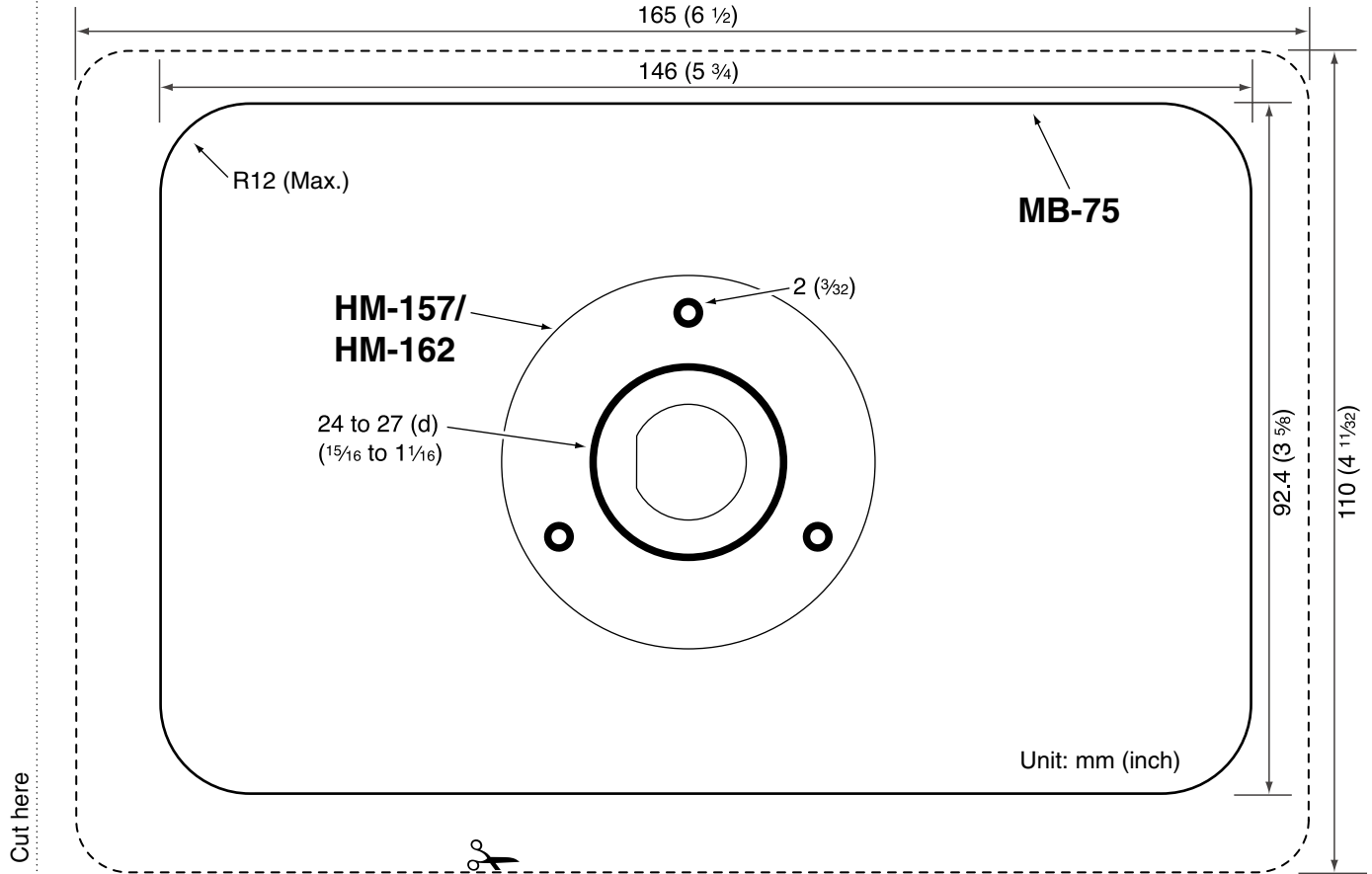





**Count on us!**

A-6483H-1US  
Printed in Japan  
© 2006 Icom Inc.

**Icom Inc.**  
1-1-32 Kamiminami, Hirano-ku, Osaka 547-0003, Japan