

ENGINEERING TEST REPORT

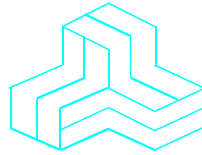

VHF Marine Transceiver
Model No.: IC-M72
FCC ID: AFJ290500

Applicant:

ICOM Incorporated
1-1-32, Kamiminami, Hirano-ku
Osaka
Japan, 547-0003

Tested in Accordance With

Federal Communications Commission (FCC)
47 CFR, Part 2, Part 80 (Marine in 156.025-157.425 MHz)

UltraTech's File No.: ICOM-121F80

This Test report is Issued under the Authority of
Tri M. Luu, Professional Engineer,
Vice President of Engineering
UltraTech Group of Labs

Date: January 3, 2006



Report Prepared by: JaeWook Choi

Tested by: Wayne Wu, EMC/RFI Technician

Issued Date: January 3, 2006

Test Dates: November 30, 2005 – December 11, 2005

*The results in this Test Report apply only to the sample(s) tested, and the sample tested is randomly selected.
This report must not be used by the client to claim product endorsement by NVLAP or any agency of the US Government.*

UltraTech

3000 Bristol Circle, Oakville, Ontario, Canada, L6H 6G4
Tel.: (905) 829-1570 Fax.: (905) 829-8050

Website: www.ultratech-labs.com, Email: vic@ultratech-labs.com, Email: tri@ultratech-labs.com



31040/SIT



C-1376



46390-2049



200093-0



SL2-IN-E-1119R



00-034



TABLE OF CONTENTS

EXHIBIT 1.	SUBMITTAL CHECK LIST.....	1
EXHIBIT 2.	INTRODUCTION	2
2.1.	SCOPE.....	2
2.2.	RELATED SUBMITTAL(S)/GRANT(S).....	2
2.3.	NORMATIVE REFERENCES	2
EXHIBIT 3.	PERFORMANCE ASSESSMENT	3
3.1.	CLIENT INFORMATION	3
3.2.	EQUIPMENT UNDER TEST (EUT) INFORMATION.....	3
3.3.	EUT'S TECHNICAL SPECIFICATIONS	4
3.4.	LIST OF EUT'S PORTS	5
3.5.	ANCILLARY EQUIPMENT	5
EXHIBIT 4.	EUT OPERATING CONDITIONS AND CONFIGURATIONS DURING TESTS	6
4.1.	CLIMATE TEST CONDITIONS	6
4.2.	OPERATIONAL TEST CONDITIONS & ARRANGEMENT FOR TEST SIGNALS	6
EXHIBIT 5.	SUMMARY OF TEST RESULTS	7
5.1.	LOCATION OF TESTS	7
5.2.	APPLICABILITY & SUMMARY OF EMC EMISSION TEST RESULTS	7
5.3.	MODIFICATIONS INCORPORATED IN THE EUT FOR COMPLIANCE PURPOSES.....	8
5.4.	DEVIATION OF STANDARD TEST PROCEDURES	8
EXHIBIT 6.	MEASUREMENTS, EXAMINATIONS & TEST DATA FOR EMC EMISSIONS.....	9
6.1.	TEST PROCEDURES.....	9
6.2.	MEASUREMENT UNCERTAINTIES.....	9
6.3.	MEASUREMENT EQUIPMENT USED	9
6.4.	ESSENTIAL/PRIMARY FUNCTIONS AS DECLARED BY THE MANUFACTURER	9
6.5.	RF POWER OUTPUT [§§ 2.1046 & 80.215]	10
6.6.	FREQUENCY STABILITY [§§ 2.1055 & 80.209]	12
6.7.	AUDIO FREQUENCY RESPONSE [§§ 2.1047(A) & 80.213(E)].....	15
6.8.	MODULATION LIMITING [§ 2.1047(B)]	18
6.9.	EMISSION MASK [§§ 2.1049 & 80.211]	21
6.10.	TRANSMITTER ANTENNA POWER SPURIOUS/HARMONIC CONDUCTED EMISSIONS [§§ 80.211(F)(3)].....	35
6.11.	TRANSMITTER SPURIOUS/HARMONIC RADIATED EMISSIONS [§§ 80.211(F)(3)].....	44
EXHIBIT 7.	MEASUREMENT UNCERTAINTY.....	46
7.1.	RADIATED EMISSION MEASUREMENT UNCERTAINTY	46
EXHIBIT 8.	MEASUREMENT METHODS.....	47
8.1.	CONDUCTED POWER MEASUREMENTS.....	47
8.2.	RADIATED POWER MEASUREMENTS (ERP & EIRP) USING SUBSTITUTION METHOD	48
8.3.	FREQUENCY STABILITY	51
8.4.	EMISSION MASK.....	52
8.5.	SPURIOUS EMISSIONS (CONDUCTED)	52

EXHIBIT 1. SUBMITTAL CHECK LIST

Annex No.	Exhibit Type	Description of Contents	Quality Check (OK)
--	Test Report	<ul style="list-style-type: none"> ▪ Exhibit 1: Submittal Check Lists ▪ Exhibit 2: Introduction ▪ Exhibit 3: Performance Assessment ▪ Exhibit 4: EUT Operation and Configuration During Tests ▪ Exhibit 5: Summary of test Results ▪ Exhibit 6: Measurement Data ▪ Exhibit 7: Measurement Uncertainty ▪ Exhibit 8: Measurement Methods 	OK
1	Test Setup Photos	Radiated Emissions Setup Photos	OK
2	External Photos of EUT	External Photos	OK
3	Internal Photos of EUT	Internal Photos	OK
4	Cover Letters	<ul style="list-style-type: none"> ▪ Letter from Ultratech for Certification Request ▪ Letter from the Applicant to Appoint Ultratech to Act as an Agent ▪ Letter from the Applicant to Request for Confidentiality Filing 	OK
5	Attestation Statements	<ul style="list-style-type: none"> ▪ Manufacturer's Declaration ▪ Part 80 	OK
6	ID Label/Location Info	<ul style="list-style-type: none"> ▪ ID Label ▪ Location of ID Label 	OK
7	Block Diagrams	Block Diagram	OK
8	Schematic Diagrams	Schematic Diagrams	OK
9	Parts List/Tune Up Info	<ul style="list-style-type: none"> ▪ Parts List ▪ Tune Up/Adjustment Procedures 	OK
10	Operational Description	Operational Description	OK
11	RF Exposure Info	See SAR Exhibit for categorically exclusion	OK
12	Users Manual	Instruction Manual	OK

ULTRATECH GROUP OF LABS

3000 Bristol Circle, Oakville, Ontario, Canada L6H 6G4
Tel. #: 905-829-1570, Fax. #: 905-829-8050, Email: vic@ultratech-labs.com, Website: <http://www.ultratech-labs.com>

File #: ICOM-092F80-90
January 3, 2006

All test results contained in this engineering test report are traceable to National Institute of Standards and Technology (NIST)

EXHIBIT 2. INTRODUCTION

2.1. SCOPE

Reference:	FCC Parts 2 and 80
Title:	Telecommunication - Code of Federal Regulations, 47CFR, Parts 2 and 80
Purpose of Test:	To gain FCC Equipment Authorization for Radio operating in the frequency bands, 156.025-157.425 MHz (Marine)
Test Procedures:	Both conducted and radiated emissions measurements were conducted in accordance with American National Standards Institute ANSI C63.4 - American National Standard for Methods of Measurement of Radio-Noise Emissions from Low-Voltage Electrical and Electronic Equipment in the Range of 9 kHz to 40 GHz.
Categories of Station:	Ship Station in 156.025-157.425 MHz

2.2. RELATED SUBMITTAL(S)/GRANT(S)

None.

2.3. NORMATIVE REFERENCES

Publication	Year	Title
FCC CFR Parts 0-19, 80-End	2003	Code of Federal Regulations – Telecommunication
ANSI C63.4	2003	American National Standard for Methods of Measurement of Radio-Noise Emissions from Low-Voltage Electrical and Electronic Equipment in the Range of 9 kHz to 40 GHz
CISPR 22 & EN 55022	2003 2003	Limits and Methods of Measurements of Radio Disturbance Characteristics of Information Technology Equipment
CISPR 16-1	2003	Specification for Radio Disturbance and Immunity measuring apparatus and methods
TIA-603-B	2002	Land Mobile FM or Pm Communications Equipment, Measurement and Performance Standards.

EXHIBIT 3. PERFORMANCE ASSESSMENT

3.1. CLIENT INFORMATION

APPLICANT	
Name:	Icom Incorporated
Address:	1-1-32, Kamiminami Hirano-ku, Oaska Japan, 547-0003
Contact Person:	Mr. Takashi Aoki Phone #: +81-66-793-5302 Fax #: +81-66-793-0013 Email Address: export@icom.co.jp

MANUFACTURER	
Name:	Icom Incorporated
Address:	1-1-32, Kamiminami Hirano-ku, Oaska Japan, 547-0003
Contact Person:	Mr. Takashi Aoki Phone #: +81-66-793-5302 Fax #: +81-66-793-0013 Email Address: export@icom.co.jp

3.2. EQUIPMENT UNDER TEST (EUT) INFORMATION

The following information (with the exception of the Date of Receipt) has been supplied by the applicant.

Brand Name:	ICOM Incorporated
Product Name:	VHF Marine Transceiver
Model Name or Number:	IC-M72
Serial Number:	Test Sample
Type of Equipment:	Non-broadcast Radio Communication Equipment
Power Supply Requirement:	7.4 V/2000 mAh Li-Ion battery pack (BP-245)
Transmitting/Receiving Antenna Type:	Non-integral, ICOM Helical antenna (M/N: FA-S64V, 156 MHz ~ 164 MHz, Gain: -14.5 dBi)
Primary User Functions of EUT:	Voice wireless communication for Marine in 156.025-157.425 MHz band.

ULTRATECH GROUP OF LABS

3000 Bristol Circle, Oakville, Ontario, Canada L6H 6G4
Tel. #: 905-829-1570, Fax. #: 905-829-8050, Email: vic@ultratech-labs.com, Website: <http://www.ultratech-labs.com>

File #: ICOM-092F80-90
January 3, 2006

All test results contained in this engineering test report are traceable to National Institute of Standards and Technology (NIST)

3.3. EUT'S TECHNICAL SPECIFICATIONS

Transmitter	
Equipment Type:	Portable
Intended Operating Environment:	Marine
Power Supply Requirement:	7.4 V/2000 mAh Li Ion battery pack (BP-245)
RF Output Power Rating:	6 Watts (High), 3 Watts (Mid) and 1 Watt (Low)
Operating Frequency Range:	156.025-157.425 MHz (Marine)
RF Output Impedance:	50 Ohms
Channel Spacing:	25 kHz
Occupied Bandwidth (99%):	14.83 kHz (25 kHz channel spacing)
Emission Designation*:	16K0F3E
Antenna Connector Type:	SMA

* For an average case of commercial telephony, the Necessary Bandwidth is calculated as follows:

For FM Voice Modulation:

* Channel Spacing = 25 KHz, D = 5 KHz max., K = 1, M = 3 KHz
 $B_n = 2M + 2DK = 2(3) + 2(5)(1) = \underline{16 \text{ KHz}}$
 emission designation: 16K0F3E

Receiver	
Power Supply Requirement:	7.5 Vdc
Operating Frequency Range:	156.05-163.275 MHz (Marine)
RF Input Impedance:	50 Ohms
Channel Spacing:	25 kHz
IF Frequencies	21.70 MHz (1 st IF), 450 kHz (2 nd IF)
Audio Output Power	0.35 W typical at 10% distortion with an 8 Ω load

3.4. LIST OF EUT'S PORTS

Port Number	EUT's Port Description	Number of Identical Ports	Connector Type	Cable Type (Shielded/Non-shielded)
1	RF Port	1	Female SMA	None
2	SP MIC	1	4 pin Microphone Connector	Shielded

3.5. ANCILLARY EQUIPMENT

None.

EXHIBIT 4. EUT OPERATING CONDITIONS AND CONFIGURATIONS DURING TESTS

4.1. CLIMATE TEST CONDITIONS

The climate conditions of the test environment are as follows:

Temperature:	21°C
Humidity:	51%
Pressure:	102 kPa
Power input source:	7.5 Vdc

4.2. OPERATIONAL TEST CONDITIONS & ARRANGEMENT FOR TEST SIGNALS

Operating Modes:	The transmitter was operated in a continuous transmission mode with the carrier modulated as specified in the Test Data.
Special Test Software:	N/A
Special Hardware Used:	N/A
Transmitter Test Antenna:	The EUT is tested with the transmitter antenna port terminated to a 50 Ohms RF Load.

Transmitter Test Signals	
Frequency Band(s):	<ul style="list-style-type: none"> ▪ 156.025-157.425 MHz
Test Frequency(ies): (Near lowest, near middle & near highest frequencies in the frequency range of operation.)	<ul style="list-style-type: none"> ▪ 156.025 and 157.425 MHz
Transmitter Wanted Output Test Signals:	
<ul style="list-style-type: none"> • Transmitter Power (measured maximum output power): • Normal Test Modulation: • Modulating signal source: 	<p>6 Watts High, 3 Watts Middle & 1 Watts Low</p> <p>FM with and without scrambler</p> <p>External</p>

EXHIBIT 5. SUMMARY OF TEST RESULTS

5.1. LOCATION OF TESTS

All of the measurements described in this report were performed at Ultratech Group of Labs located in the city of Oakville, Province of Ontario, Canada.

- AC power line conducted emissions were performed in UltraTech's shielded room, 24'(L) by 16'(W) by 8'(H).
- Radiated emissions were performed at the Ultratech's 3-10 TDK Semi-Anechoic Chamber situated in the Town of Oakville, province of Ontario. This test site been calibrated in accordance with ANSI C63.4, and found to be in compliance with the requirements of Sec. 2.948 of the FCC Rules. The descriptions and site measurement data of the Oakville 3-10 TDK Semi-Anechoic Chamber has been filed with FCC office (FCC File No.: 31040/SIT 1300B3) and Industry Canada office (Industry Canada File No.: IC2049-1). Last Date of Site Calibration: June. 20, 2005.

5.2. APPLICABILITY & SUMMARY OF EMC EMISSION TEST RESULTS

FCC Section(s)	Test Requirements	Applicability (Yes/No)
80.215 & 2.1046	RF Power Output	Yes
1.1307, 1.1310, 2.1091 & 2.1093	RF Exposure Limit	Yes
80.209 & 2.1055	Frequency Stability	Yes
80.213(e) & 2.1047(a)	Audio Frequency Response	Yes
2.1047(b)	Modulation Limiting	Yes
80.211(f) & 2.1049	Emission Limitation / Emission Mask	Yes
80.211(f)(3), 2.1051 & 2.1057	Emission Limits - Spurious Emissions at Antenna Terminal	Yes
80.211(f)(3), 2.1053 & 2.1057	Emission Limits - Field Strength of Spurious Emissions	Yes
80.217	Suppression of Interference aboard ships	Yes
<p>VHF Marine Transceiver, Model No.: IC-M72, by ICOM Incorporated has also been tested and found to comply with FCC Part 15, Subpart B - Radio Receivers and Class B Digital Devices. The engineering test report has been documented and it is available upon FCC request.</p>		

5.3. MODIFICATIONS INCORPORATED IN THE EUT FOR COMPLIANCE PURPOSES

None.

5.4. DEVIATION OF STANDARD TEST PROCEDURES

None.

ULTRATECH GROUP OF LABS

3000 Bristol Circle, Oakville, Ontario, Canada L6H 6G4
Tel. #: 905-829-1570, Fax. #: 905-829-8050, Email: vic@ultratech-labs.com, Website: <http://www.ultratech-labs.com>

File #: ICOM-092F80-90
January 3, 2006

All test results contained in this engineering test report are traceable to National Institute of Standards and Technology (NIST)

EXHIBIT 6. MEASUREMENTS, EXAMINATIONS & TEST DATA FOR EMC EMISSIONS

6.1. TEST PROCEDURES

This section contains test results only. Details of test methods and procedures can be found in Exhibit 8 of this report.

6.2. MEASUREMENT UNCERTAINTIES

The measurement uncertainties stated were calculated in accordance with requirements of UKAS Document NIS 81 with a confidence level of 95%. Please refer to Exhibit 7 for Measurement Uncertainties.

6.3. MEASUREMENT EQUIPMENT USED

The measurement equipment used complied with the requirements of the Standards referenced in the Methods & Procedures ANSI C63.4 and CISPR 16-1.

6.4. ESSENTIAL/PRIMARY FUNCTIONS AS DECLARED BY THE MANUFACTURER

The essential function of the EUT is to correctly communicate data to and from radios over RF link.

6.5. RF POWER OUTPUT [§§ 2.1046 & 80.215]

6.5.1. Limits

§ 80.215 - For 156-162 MHz Band:

- Coast Stations: 50W (Maximum authorized power at the input terminals of the station antenna)
- Marine utility stations: 10W
- Ship stations: 25W (Reducible to 1 watt or less, except for transmitters limited to public correspondence channels and used in an automated system.)
- Marine utility stations and hand-held portable transmitters: 10W

6.5.2. Method of Measurements

Refer to Section 8.1 (Conducted) and Section 8.2 (Radiated) in this test report for test procedures and test setup.

6.5.3. Test Equipment List

Test Instruments	Manufacturer	Model No.	Serial No.	Frequency Range
Attenuator	Weinschel Corp	23-20-34	BH7876	DC – 18 GHz
Power Meter	Hewlett Packard	436A	1725A02249	10 kHz – 50 GHz, sensor dependent
Power Sensor	Hewlett Packard	8481A	2702A68983	10 MHz – 18 GHz

6.5.4. Test Arrangement

Power at RF Power Output Terminals

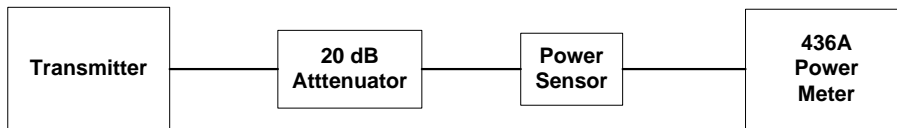

6.5.5. Test Data

Transmitter Channel Output	Fundamental Frequency (MHz)	Measured (Average) Conducted Power (Watts)	Power Rating (Watts)
Power Setting: High			
Lowest	156.025	5.75	6.0
Highest	157.425	5.66	6.0
Power Setting: Medium			
Lowest	156.025	3.18	3.0
Highest	157.425	3.18	3.0
Power Setting: Low			
Lowest	156.025	0.72	1.0
Highest	157.425	0.66	1.0

6.6. FREQUENCY STABILITY [§§ 2.1055 & 80.209]

6.6.1. Limits

Refer to § 80.209 for specification details.

Operating Frequency Band (MHz)	Coast Stations		Ship Stations
	Below 3 W	3 to 100 W	
156-162	10 ppm	¹ 5 ppm	² 10 ppm

1 For transmitters operated at private coast stations with antenna heights less than 6 meters (20 feet) above ground and output power of 25 watts or less the frequency tolerance is 10 parts in 10^6 .

2 For transmitters in the radiolocation and associated telecommand service operating on 154.585 MHz, 159.480 MHz, 160.725 MHz and 160.785 MHz the frequency tolerance is 15 parts in 10^6 .

6.6.2. Method of Measurements

Refer to Section 8.3 of this report for measurement details

6.6.3. Test Equipment List

Test Instruments	Manufacturer	Model No.	Serial No.	Frequency Range
Frequency Counter	EIP	545A	2683	10Hz-18GHz
Attenuator	Weinschel	23-20-34	BH7876	DC-18 GHz
Temperature & Humidity Chamber	Tenney	T5	9723B	-40° to +60° C range

6.6.4. Test Arrangement

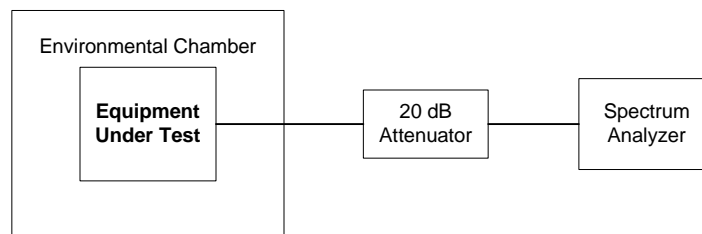

6.6.5. Test Data

6.6.5.1. Frequency Tolerance versus Ambient Temperature

Product Name:	VHF Marine Transceiver
Model No.:	IC-M72
Center Frequency:	156.025 MHz
Full Power Level:	6 Watts
Frequency Tolerance Limit (Worst Case):	+10 ppm or 1560.25 Hz
Max. Frequency Tolerance Measured:	-736 Hz or 4.7 ppm
Input Voltage Rating:	7.5 Vdc

CENTER FREQUENCY & RF POWER OUTPUT VARIATION			
Ambient Temperature (°C)	Supply Voltage (Nominal) 7.5 Volts	Supply Voltage (Minimum before switch-off) 5.6 Volts	Supply Voltage (115% of Nominal) 8.63 Volts
	Hz	Hz	Hz
-30	359	N/A	N/A
-20	372	N/A	N/A
-10	345	N/A	N/A
0	280	N/A	N/A
+10	177	N/A	N/A
+20	-219	-139	-244
+30	-516	N/A	N/A
+40	-587	N/A	N/A
+50	-729	N/A	N/A
+60	-736	N/A	N/A

6.7. AUDIO FREQUENCY RESPONSE [§§ 2.1047(a) & 80.213(e)]

6.7.1. Limits

The coast station transmitter operated in 156.025-157.425 MHz must be equipped with a lowpass filter. The filter must be installed between the modulation limiter and the modulated radio frequency stages. The audio lowpass filter shall meet the following characteristics:

RF Band	Audio band	Minimum Attenuation Rel. to 1 kHz Attenuation
156.025-157.425 MHz / 146-174 MHz	3 –20 kHz above 20 kHz	$60 \log_{10}(f/3)$ dB where f is in kHz 50dB

6.7.2. Method of Measurements

The rated audio input signal was applied to the input of the audio lowpass filter (or of all modulation stages) using an audio oscillator, this input signal level and its corresponding output signal were then measured and recorded using the FFT (Audio) spectrum analyzer. Tests were repeated at different audio signal frequencies from 0 to 50 kHz.

6.7.3. Test Equipment List

Test Instruments	Manufacturer	Model No.	Serial No.	Frequency Range
FFT (audio) Spectrum Analyzer	Advantest	R9211E	...	10 mHz – 100 kHz, 1 MHz Input Impedance
Radio Communication Test Set	Marconi Instruments	2955	132037/226	AF SG 20Hz--20KHz

6.7.4. Test Arrangement

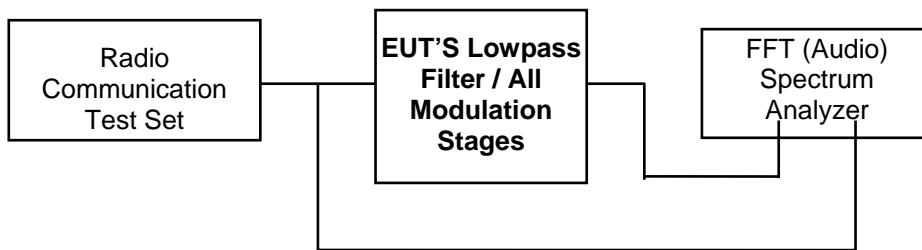

6.7.5. Test Data

6.7.5.1. 25 kHz Channel Spacing, Frequency of All Modulation States*

Note: Due to the difficulty of measuring the Frequency Response of the internal lowpass filter, the Frequency Response of All Modulation States are performed to show the roll-off at 3 kHz in comparison with FCC Limit for audio lowpass filter.

Frequency (kHz)	Audio IN (dBV)	Audio OUT (dBV)	Attenuation (OUT - IN) (dB)	Attenuation wrt. 1 kHz (dB)	Recommended FCC Limit (dB)
0.1	-51.37	-37.96	14.0	-26.4	--
0.2	-51.37	-11.54	40.5	-19.5	--
0.4	-51.37	-3.44	48.6	-10.4	--
0.6	-51.37	0.81	52.8	-5.6	--
0.8	-51.37	3.73	55.7	-2.3	--
1.0	-51.37	5.88	57.9	0.0	--
1.5	-51.37	9.02	61.0	2.4	--
2.0	-51.37	9.75	61.8	2.7	--
2.5	-51.37	9.77	61.8	1.5	--
3.0	-51.37	8.83	60.8	-0.1	0
3.5	-51.37	6.36	58.4	-1.9	-4
4.0	-51.37	2.96	55.0	-5.8	-7
4.5	-51.37	-0.76	51.2	-9.6	-11
5.0	-51.37	-4.25	47.8	-13.1	-13
6.0	-51.37	-11.01	41.0	-19.0	-18
7.0	-51.37	-16.15	35.9	-23.8	-22
8.0	-51.37	-20.86	31.1	-27.3	-26
9.0	-51.37	-25.07	26.9	-30.9	-29
10.0	-51.37	-28.70	23.3	-34.3	-31
12.0	-51.37	-36.57	15.4	-40.6	-36
14.0	-51.37	-42.02	10.0	-46.5	-40
16.0	-51.37	-49.39	2.6	-50.2	-44
18.0	-51.37	-56.20	-4.2	-62.6	-47
20.0	-51.37	<-60.00	<-8.6	<-66.5	<-50
25.0	-51.37	<-60.00	<-8.6	<-66.5	<-50
30.0	-51.37	<-60.00	<-8.6	<-66.5	<-50
35.0	-51.37	<-60.00	<-8.6	<-66.5	<-50
40.0	-51.37	<-60.00	<-8.6	<-66.5	<-50
45.0	-51.37	<-60.00	<-8.6	<-66.5	<-50
50.0	-51.37	<-60.00	<-8.6	<-66.5	<-50

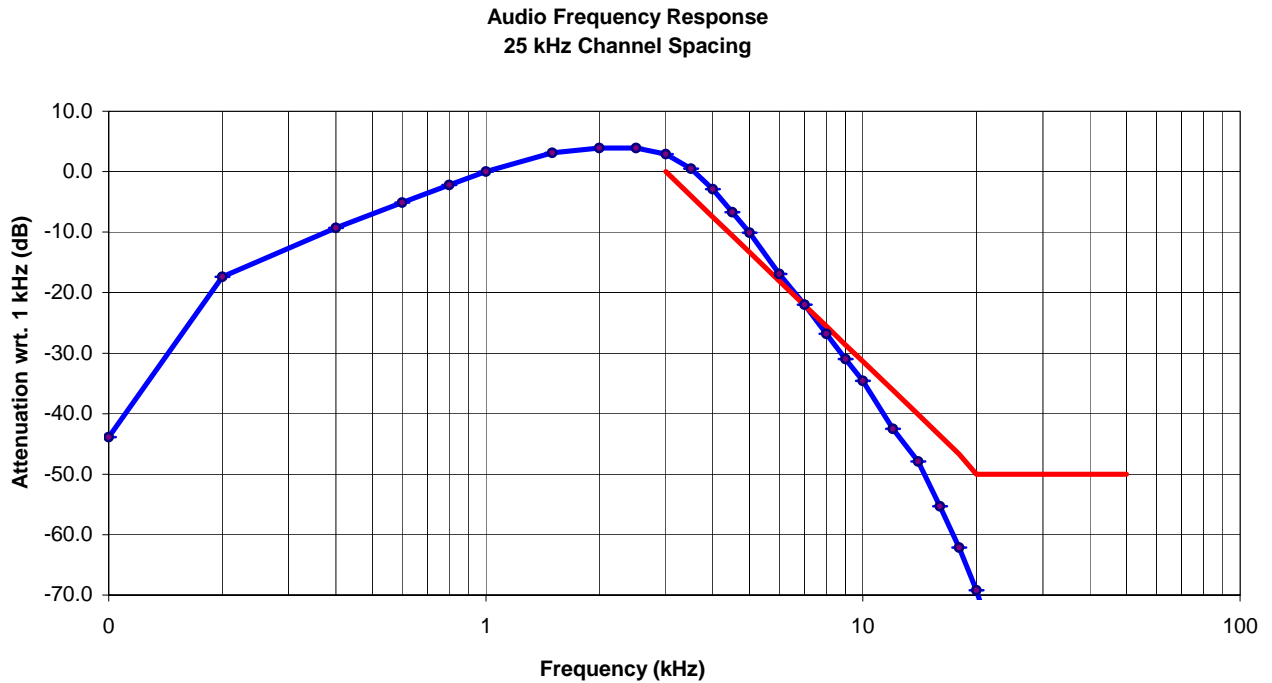

ULTRATECH GROUP OF LABS

3000 Bristol Circle, Oakville, Ontario, Canada L6H 6G4
Tel. #: 905-829-1570, Fax. #: 905-829-8050, Email: vic@ultratech-labs.com, Website: <http://www.ultratech-labs.com>

File #: ICOM-092F80-90

January 3, 2006

All test results contained in this engineering test report are traceable to National Institute of Standards and Technology (NIST)

6.8. MODULATION LIMITING [§ 2.1047(b)]

6.8.1. Limits

Recommended frequency deviation characteristics are given below:

Frequency Range (MHz)	Maximum Authorized BW (KHz)	Channel Spacing (KHz)	Recommended Frequency Deviation (KHz)
156.025-157.425 MHz (Marine) 150-174 MHz (General)	20.0	25.0	5.0
150-174 MHz (General)	11.25	12.5	2.5

6.8.2. Method of Measurements

For Audio Transmitter:- The carrier frequency deviation was measured with the tone input signal level varied from 0 Vp to audio input rating level plus 16 dB at frequencies 0.1, 0.5, 1.0, 3.0 and 5.0 kHz. The maximum deviation was recorded at each test condition.

For Data Transmitter with Maximum Frequency Deviation set by Factory:- The EUT was set at maximum frequency deviation, and its peak frequency deviation was then measured using EUT's internal random data source.

6.8.3. Test Equipment List

Test Instruments	Manufacturer	Model No.	Serial No.	Frequency Range
Radio Communication Test Set	Marconi Instruments	2955	132037/226	20 Hz - 20 kHz
Modulation Analyzer	Hewlett-Packard	8901B	3226A04606	150kHz - 1300 MHz
Attenuator	Weinschel	23-20-34	BH7876	DC-18 GHz

6.8.4. Test Arrangement

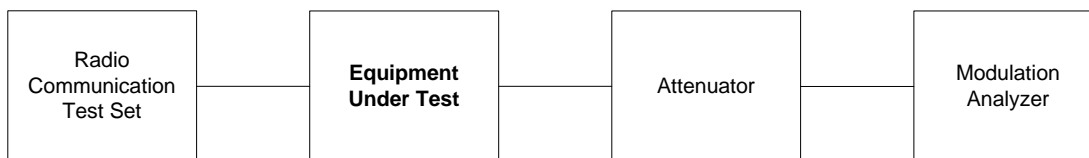

6.8.5. Test Data

6.8.5.1. Voice Modulation Limiting for 25 kHz Channel Spacing Operation:

MODULATING SIGNAL LEVEL (mVrms)	PEAK FREQUENCY DEVIATION (kHz) at the following modulating frequency:					MAXIMUM LIMIT (kHz)
	0.1 kHz	0.5 kHz	1.0 kHz	3.0 kHz	5.0 kHz	
1	0.36	0.74	1.37	3.38	1.04	5.0
2	0.44	1.27	2.56	4.02	0.98	5.0
4	0.57	2.25	3.75	4.06	0.98	5.0
6	0.64	3.25	4.11	4.07	0.93	5.0
8	0.81	3.91	4.22	4.06	0.90	5.0
10	0.96	3.92	4.24	4.05	0.89	5.0
20	1.87	3.93	4.28	4.06	0.88	5.0
30	2.75	4.12	4.31	4.08	0.88	5.0
40	3.58	4.21	4.31	4.00	0.88	5.0
50	4.41	4.24	4.32	4.01	0.88	5.0
60	5.37	4.33	4.35	4.02	0.88	5.0

Voice Signal Input Level = STD MOD Level + 16 dB = 7.96 dB(mVrms) + 16 = 23.96 dB(mVrms) or 15.77 mVrms

MODULATING FREQUENCY (KHz)	PEAK FREQUENCY DEVIATION (KHz)	MAXIMUM LIMIT (KHz)
0.1	1.41	5.0
0.2	2.61	5.0
0.4	4.05	5.0
0.6	3.95	5.0
0.8	4.22	5.0
1.0	4.26	5.0
1.2	4.33	5.0
1.4	4.27	5.0
1.6	4.26	5.0
1.8	4.31	5.0
2.0	4.39	5.0
2.5	4.51	5.0
3.0	4.05	5.0
3.5	3.10	5.0
4.0	2.08	5.0
4.5	1.35	5.0
5.0	0.88	5.0
6.0	0.42	5.0
7.0	0.24	5.0
8.0	0.14	5.0
9.0	0.09	5.0
10.0	0.06	5.0

ULTRATECH GROUP OF LABS

3000 Bristol Circle, Oakville, Ontario, Canada L6H 6G4
Tel. #: 905-829-1570, Fax. #: 905-829-8050, Email: vic@ultratech-labs.com, Website: <http://www.ultratech-labs.com>

File #: ICOM-092F80-90
January 3, 2006

All test results contained in this engineering test report are traceable to National Institute of Standards and Technology (NIST)

6.9. EMISSION MASK [§§ 2.1049 & 80.211]

6.9.1. Limits

Emissions shall be attenuated below the mean output power of the transmitter as follows:

§ 80.211 (Marine):

Frequency Range (MHz)	Maximum Authorized BW (KHz)	Channel Spacing (KHz)	Recommended Frequency Deviation (KHz)	FCC Applicable Mask
156.025-157.425	20.0	25.0	5.0	See § 80.211(f)

6.9.2. Method of Measurements

Refer to Section 8.4 of this report for measurement details

6.9.3. Test Equipment List

Test Instruments	Manufacturer	Model No.	Serial No.	Frequency Range
Spectrum Analyzer	Advantest	R3271	15050203	100 Hz - 26.5 GHz
Radio Communication Test Set	Marconi Instruments	2955	132037/226	20 Hz - 20 kHz
Attenuator	Weinschel	23-20-34	BH7876	DC-18 GHz

6.9.4. Test Arrangement

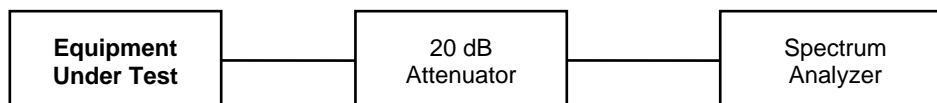

6.9.5. Test Data

6.9.5.1. 99% Occupied Bandwidth

Frequency (MHz)	Channel Spacing (kHz)	Measured 99% OBW (kHz)	Authorized Bandwidth (kHz)
Scrambler not Active			
156.025	25.0	14.83	16.0
157.425	25.0	14.79	16.0
Scrambler Active			
156.025	25.0	11.70	16.0
157.425	25.0	11.66	16.0

See the following plots (1 – 4) for details of measurements.

Plot # 1:
Occupied Bandwidth
Carrier Frequency: 156.025 MHz
Channel Spacing: 25.0 kHz
Power: 6 W
Modulation: FM with 2.5kHz sine wave

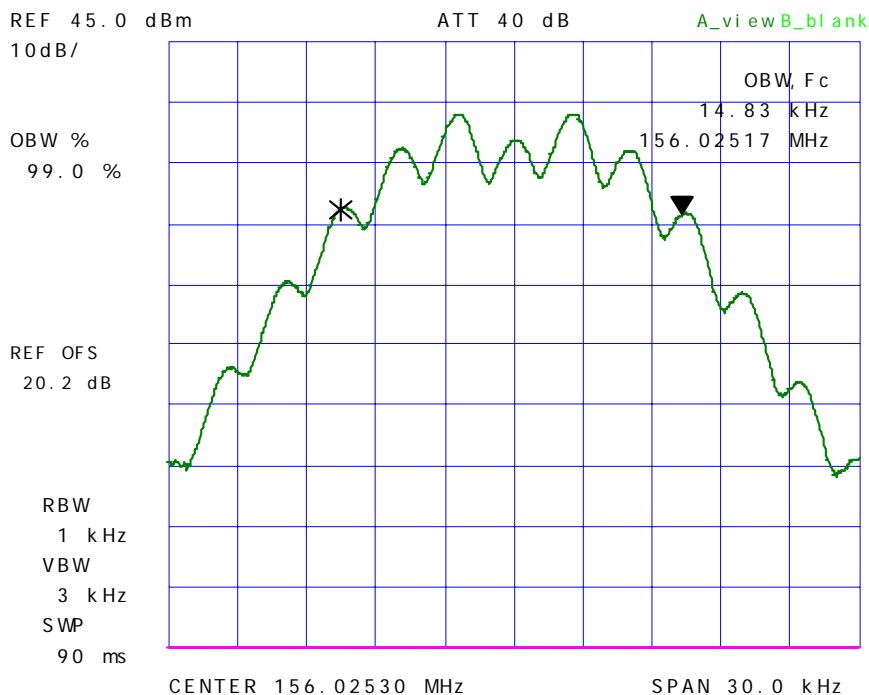

ULTRATECH GROUP OF LABS

3000 Bristol Circle, Oakville, Ontario, Canada L6H 6G4
Tel. #: 905-829-1570, Fax. #: 905-829-8050, Email: vic@ultratech-labs.com, Website: <http://www.ultratech-labs.com>

File #: ICOM-092F80-90
January 3, 2006

All test results contained in this engineering test report are traceable to National Institute of Standards and Technology (NIST)

Plot # 2:
Occupied Bandwidth
Carrier Frequency: 157.425 MHz
Channel Spacing: 25.0 kHz
Power: 6 W
Modulation: FM with 2.5kHz sine wave

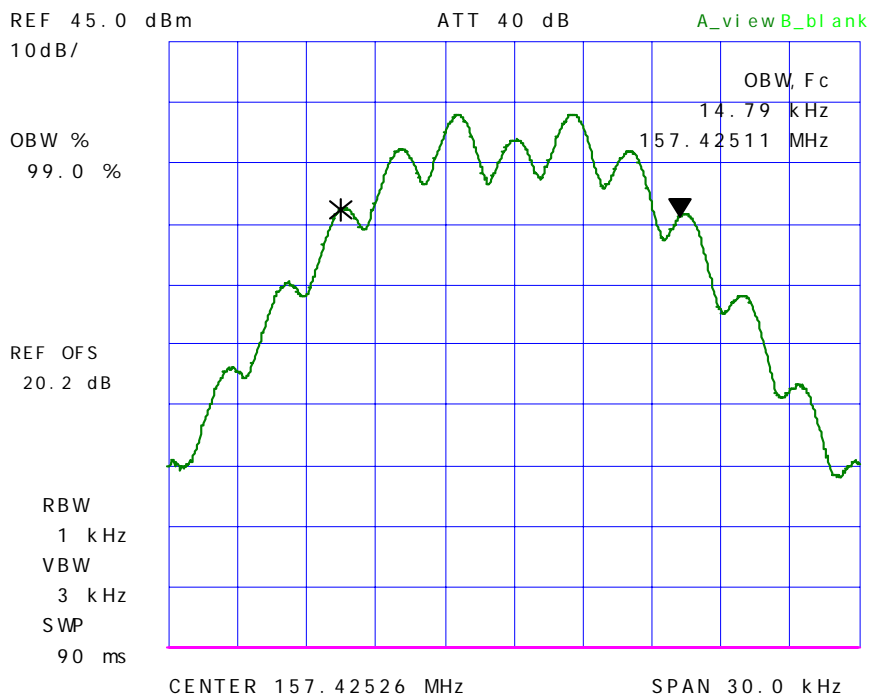

ULTRATECH GROUP OF LABS

3000 Bristol Circle, Oakville, Ontario, Canada L6H 6G4
Tel. #: 905-829-1570, Fax. #: 905-829-8050, Email: vic@ultratech-labs.com, Website: <http://www.ultratech-labs.com>

File #: ICOM-092F80-90
January 3, 2006

All test results contained in this engineering test report are traceable to National Institute of Standards and Technology (NIST)

Plot # 3:
Occupied Bandwidth
Carrier Frequency: 156.025 MHz
Channel Spacing: 25.0 kHz
Power: 6 W
Modulation: FM with 2.5 kHz sine wave signal and scrambler

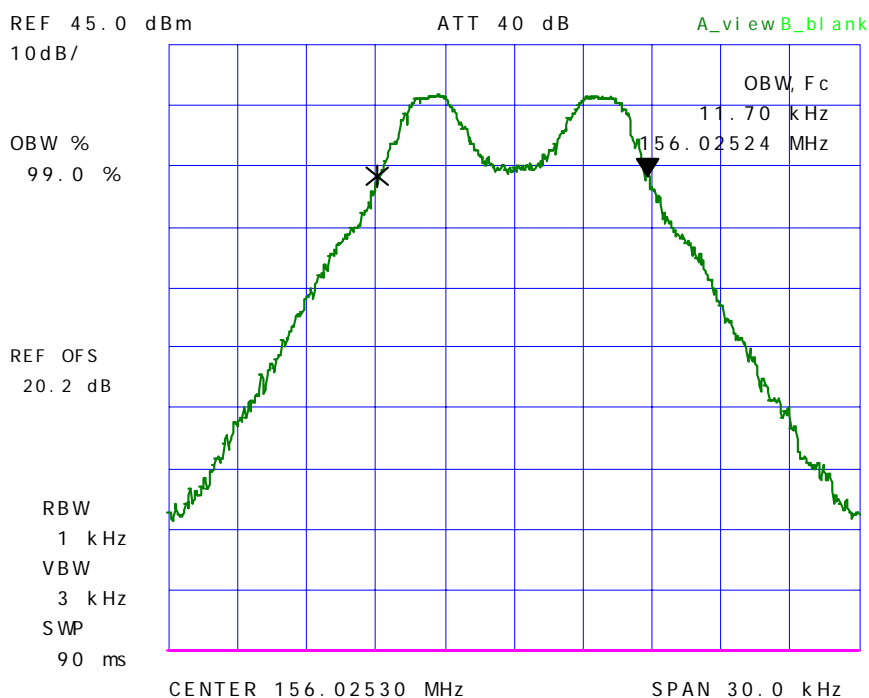

ULTRATECH GROUP OF LABS

3000 Bristol Circle, Oakville, Ontario, Canada L6H 6G4
Tel. #: 905-829-1570, Fax. #: 905-829-8050, Email: vic@ultratech-labs.com, Website: <http://www.ultratech-labs.com>

File #: ICOM-092F80-90
January 3, 2006

All test results contained in this engineering test report are traceable to National Institute of Standards and Technology (NIST)

Plot # 8:
Occupied Bandwidth
Carrier Frequency: 157.425 MHz
Channel Spacing: 25.0 kHz
Power: 6 W
Modulation: FM with 2.5 kHz sine wave signal and scrambler

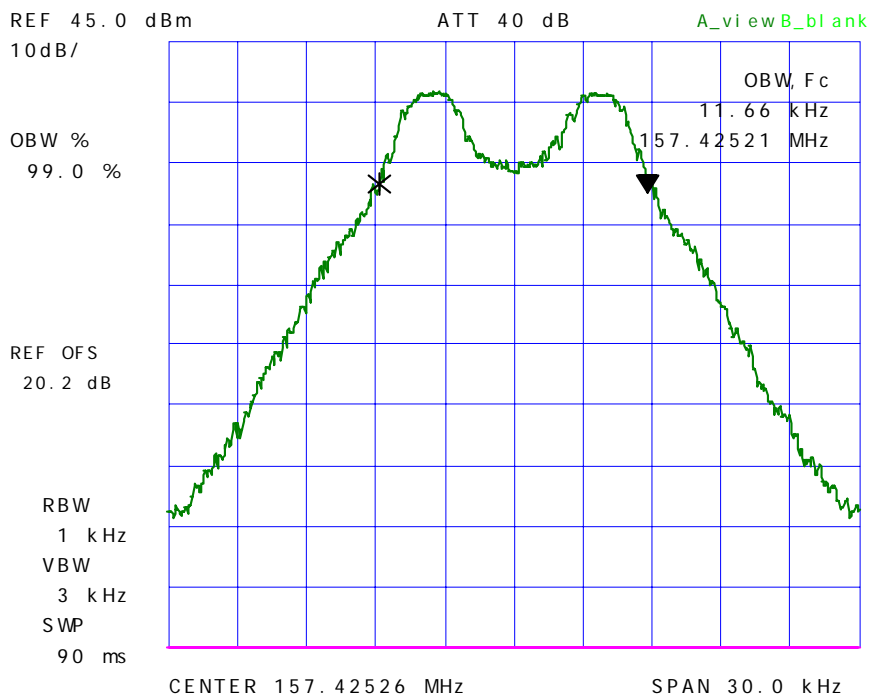

ULTRATECH GROUP OF LABS

3000 Bristol Circle, Oakville, Ontario, Canada L6H 6G4
Tel. #: 905-829-1570, Fax. #: 905-829-8050, Email: vic@ultratech-labs.com, Website: <http://www.ultratech-labs.com>

File #: ICOM-092F80-90
January 3, 2006

All test results contained in this engineering test report are traceable to National Institute of Standards and Technology (NIST)

6.9.5.2. Emission Masks

Conform. See the following test data plots (05 through 12) for details.

Plot # 05:
Emission Mask B
Carrier Frequency: 156.025 MHz
Channel Spacing: 25 kHz
Power: 6 W
Modulation: FM with 2.5kHz sine wave

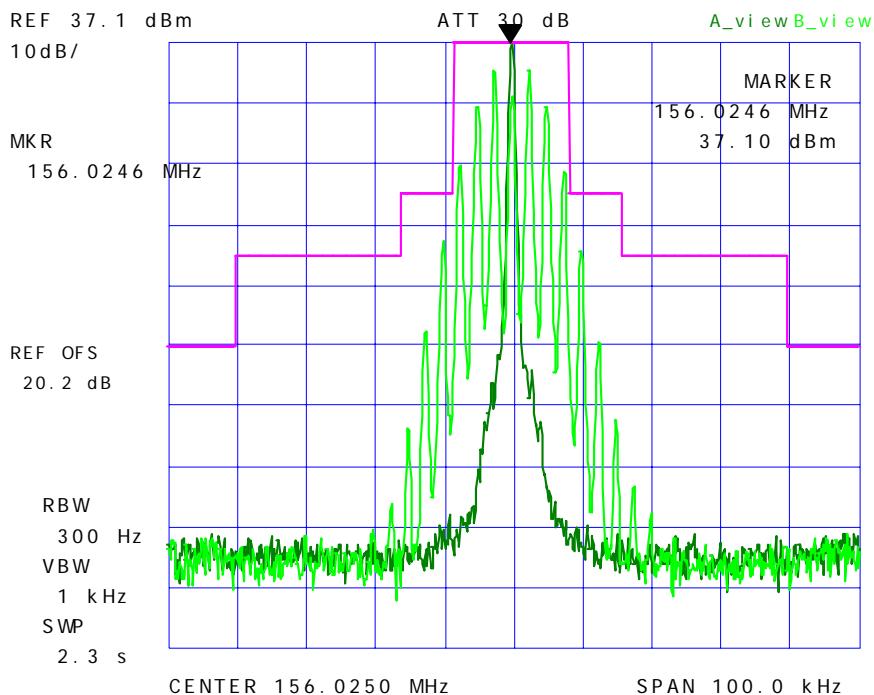

ULTRATECH GROUP OF LABS

3000 Bristol Circle, Oakville, Ontario, Canada L6H 6G4
Tel. #: 905-829-1570, Fax. #: 905-829-8050, Email: vic@ultratech-labs.com, Website: <http://www.ultratech-labs.com>

File #: ICOM-092F80-90
January 3, 2006

All test results contained in this engineering test report are traceable to National Institute of Standards and Technology (NIST)

Plot # 06:
Emission Mask B
Carrier Frequency: 157.425 MHz
Channel Spacing: 25 kHz
Power: 6 W
Modulation: FM with 2.5kHz sine wave

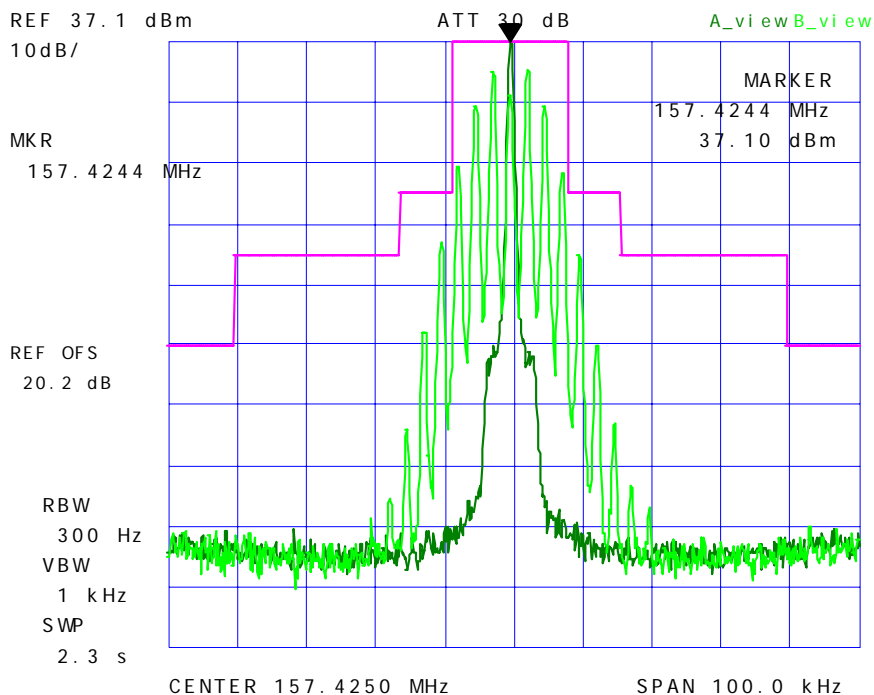

ULTRATECH GROUP OF LABS

3000 Bristol Circle, Oakville, Ontario, Canada L6H 6G4
Tel. #: 905-829-1570, Fax. #: 905-829-8050, Email: vic@ultratech-labs.com, Website: <http://www.ultratech-labs.com>

File #: ICOM-092F80-90
January 3, 2006

All test results contained in this engineering test report are traceable to National Institute of Standards and Technology (NIST)

Plot # 07:
Emission Mask B
Carrier Frequency: 156.025 MHz
Channel Spacing: 25 kHz
Power: 1 W
Modulation: FM with 2.5kHz sine wave

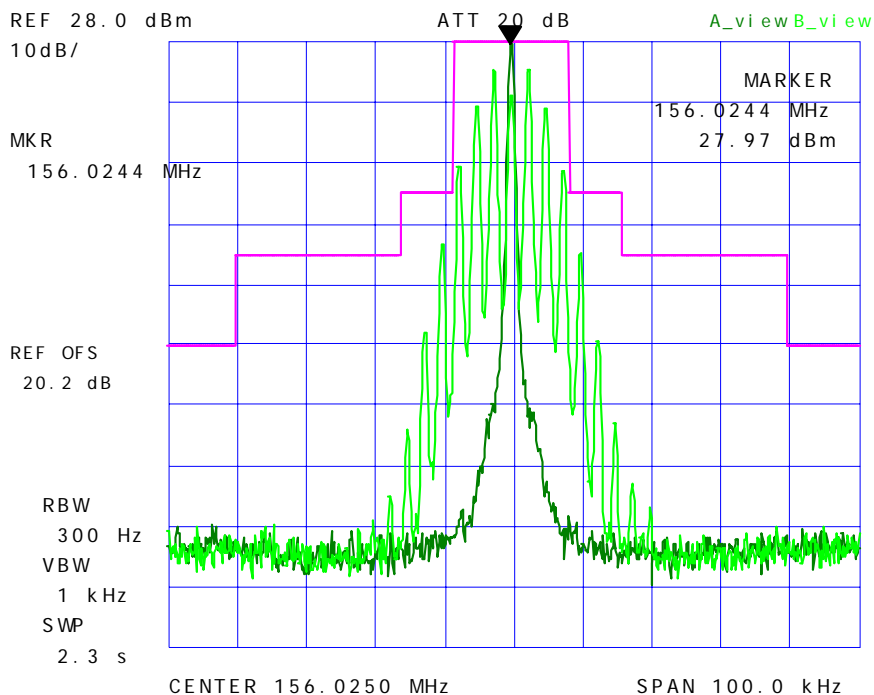

ULTRATECH GROUP OF LABS

3000 Bristol Circle, Oakville, Ontario, Canada L6H 6G4
Tel. #: 905-829-1570, Fax. #: 905-829-8050, Email: vic@ultratech-labs.com, Website: <http://www.ultratech-labs.com>

File #: ICOM-092F80-90
January 3, 2006

All test results contained in this engineering test report are traceable to National Institute of Standards and Technology (NIST)

Plot # 08:
Emission Mask B
Carrier Frequency: 157.425 MHz
Channel Spacing: 25 kHz
Power: 1W
Modulation: FM with 2.5kHz sine wave

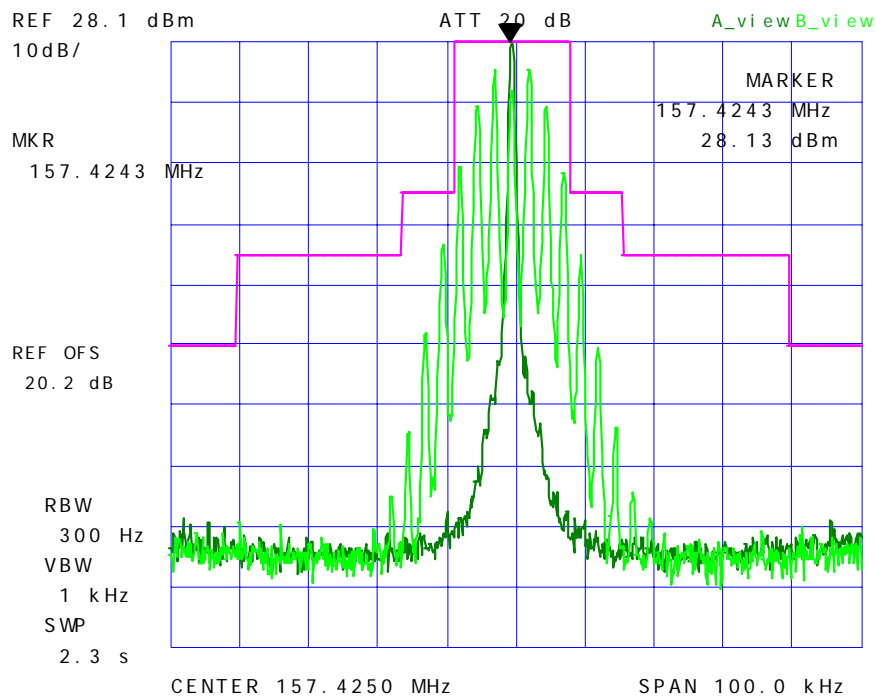

ULTRATECH GROUP OF LABS

3000 Bristol Circle, Oakville, Ontario, Canada L6H 6G4
Tel. #: 905-829-1570, Fax. #: 905-829-8050, Email: vic@ultratech-labs.com, Website: <http://www.ultratech-labs.com>

File #: ICOM-092F80-90
January 3, 2006

All test results contained in this engineering test report are traceable to National Institute of Standards and Technology (NIST)

Plot # 09:
Emission Mask B
Carrier Frequency: 156.025 MHz
Channel Spacing: 25 kHz
Power: 6 W
Modulation: FM with 2.5kHz sine wave and scrambler

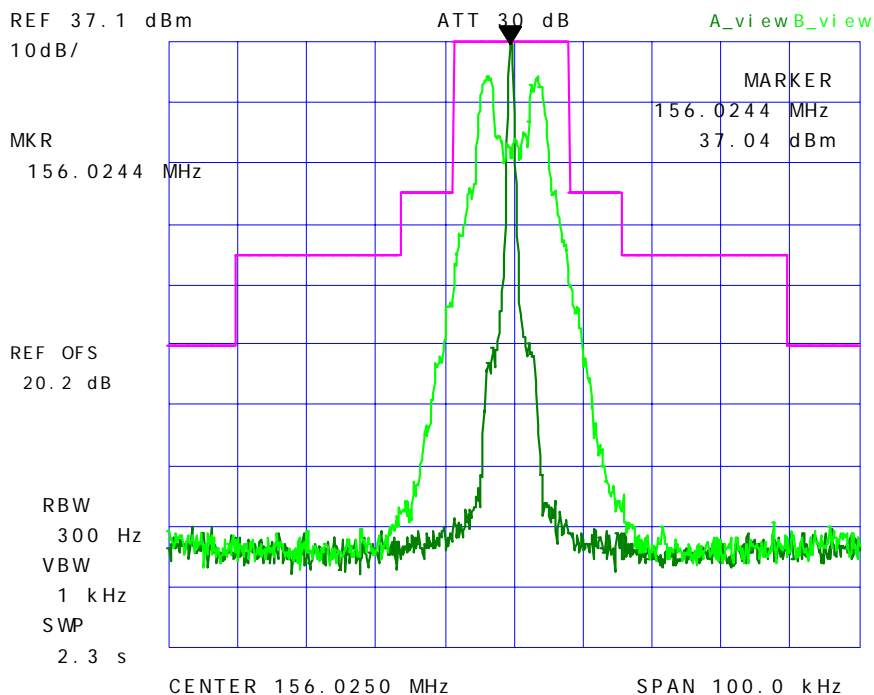

ULTRATECH GROUP OF LABS

3000 Bristol Circle, Oakville, Ontario, Canada L6H 6G4
Tel. #: 905-829-1570, Fax. #: 905-829-8050, Email: vic@ultratech-labs.com, Website: <http://www.ultratech-labs.com>

File #: ICOM-092F80-90

January 3, 2006

All test results contained in this engineering test report are traceable to National Institute of Standards and Technology (NIST)

Plot # 10:
Emission Mask B
Carrier Frequency: 157.425 MHz
Channel Spacing: 25 kHz
Power: 6 W
Modulation: FM with 2.5kHz sine wave and scrambler

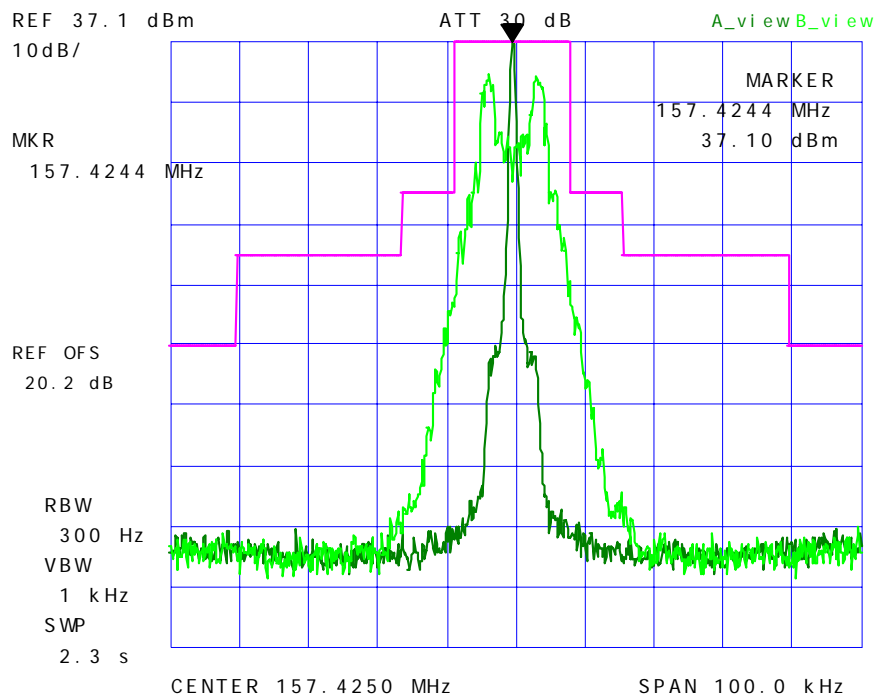

ULTRATECH GROUP OF LABS

3000 Bristol Circle, Oakville, Ontario, Canada L6H 6G4
Tel. #: 905-829-1570, Fax. #: 905-829-8050, Email: vic@ultratech-labs.com, Website: <http://www.ultratech-labs.com>

File #: ICOM-092F80-90
January 3, 2006

All test results contained in this engineering test report are traceable to National Institute of Standards and Technology (NIST)

Plot # 11:
Emission Mask B
Carrier Frequency: 156.025 MHz
Channel Spacing: 25 kHz
Power: 1W
Modulation: FM with 2.5kHz sine wave and scrambler

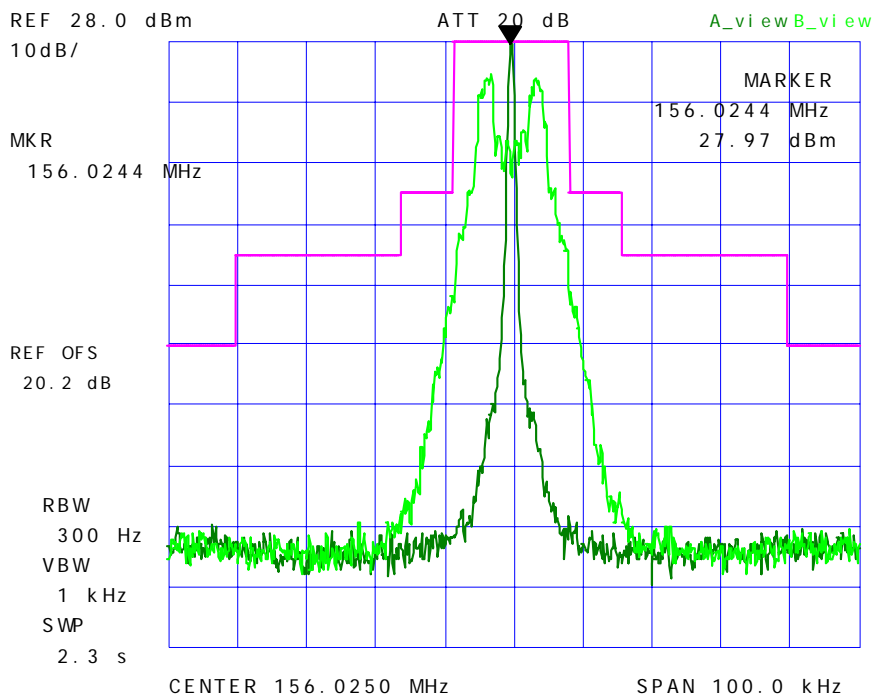

ULTRATECH GROUP OF LABS

3000 Bristol Circle, Oakville, Ontario, Canada L6H 6G4
Tel. #: 905-829-1570, Fax. #: 905-829-8050, Email: vic@ultratech-labs.com, Website: <http://www.ultratech-labs.com>

File #: ICOM-092F80-90
January 3, 2006

All test results contained in this engineering test report are traceable to National Institute of Standards and Technology (NIST)

Plot # 12:
Emission Mask B
Carrier Frequency: 157.425 MHz
Channel Spacing: 25 kHz
Power: 1 W
Modulation: FM with 2.5kHz sine wave and scrambler

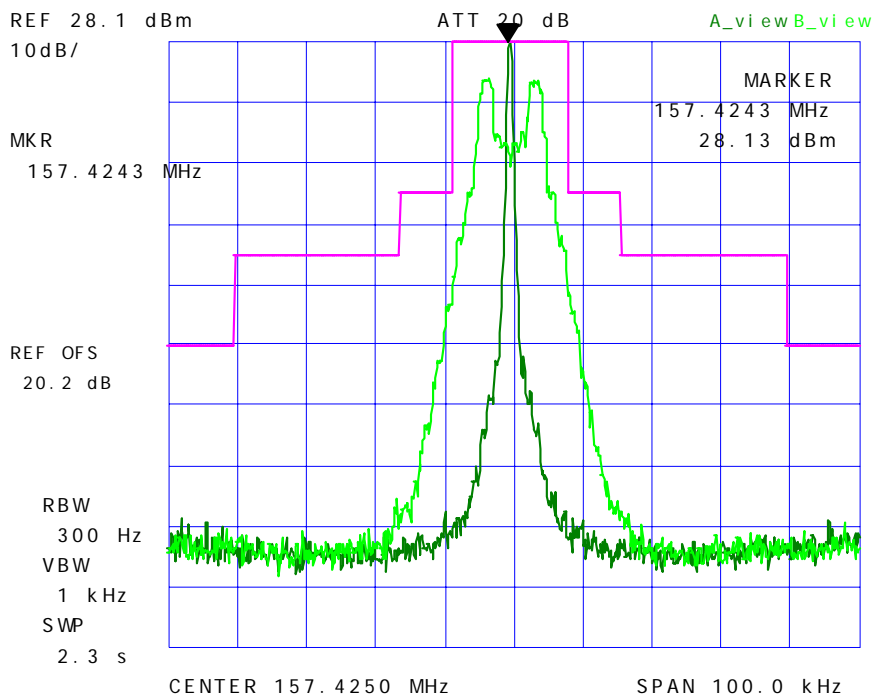

ULTRATECH GROUP OF LABS

3000 Bristol Circle, Oakville, Ontario, Canada L6H 6G4
Tel. #: 905-829-1570, Fax. #: 905-829-8050, Email: vic@ultratech-labs.com, Website: <http://www.ultratech-labs.com>

File #: ICOM-092F80-90
January 3, 2006

All test results contained in this engineering test report are traceable to National Institute of Standards and Technology (NIST)

6.10. TRANSMITTER ANTENNA POWER SPURIOUS/HARMONIC CONDUCTED EMISSIONS [§§ 80.211(f)(3)]

6.10.1. Limits

Emissions shall be attenuated below the mean output power of the transmitter as follows:

FCC Rules	Frequency Range	Attenuation Limit (dBc)
80.211(f)(3) - Marine	10 MHz or Lowest frequency of the radio to 10 th harmonic of the highest frequency of the radio	43+10*log(P)

6.10.2. Method of Measurements

Refer to Section 8.5 of this report for measurement details

6.10.3. Test Equipment List

Test Instruments	Manufacturer	Model No.	Serial No.	Frequency Range
EMI Receiver/ Spectrum Analyzer	Advantest	R3271	15050203	100 Hz – 26.5 GHz
Attenuator(s)	Weinschel Corp	23-20-34	BH7876	DC – 18 GHz
Radio Communication	Marconi	2955	132037/226	20Hz – 20kHz
High Pass Filter	Mini-Circuits	SHP-250	--	Cut-off Frequency at 225 MHz
Power Supply	Tenna	72-6153	--	--
Digital Multimeter	Rohde & Schwarz	UDS5	8729841067	DC-100 kHz

6.10.4. Test Arrangement

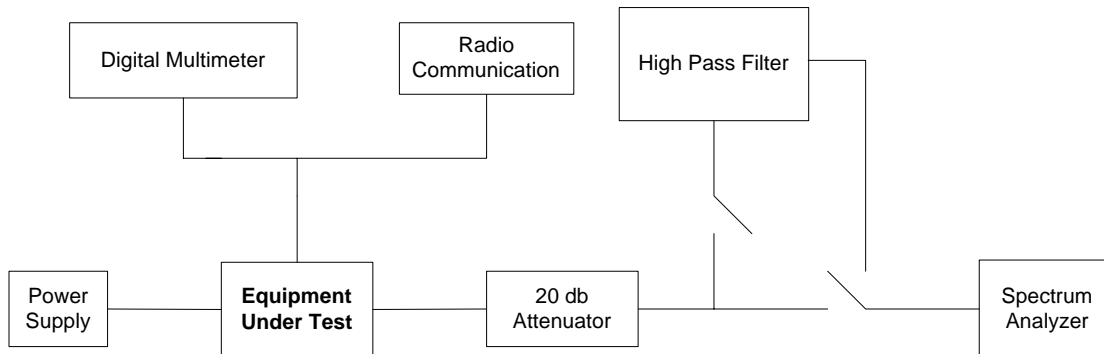

6.10.5. Test Data

6.10.5.1. Near Lowest Frequency (156.025 MHz)

Plot # 13:
Spurious Emissions at Antenna Terminals
Carrier Frequency: 156.025 MHz
Channel Spacing: 25.0kHz
Power: 6 W
Modulation: FM with 2.5kHz sine wave

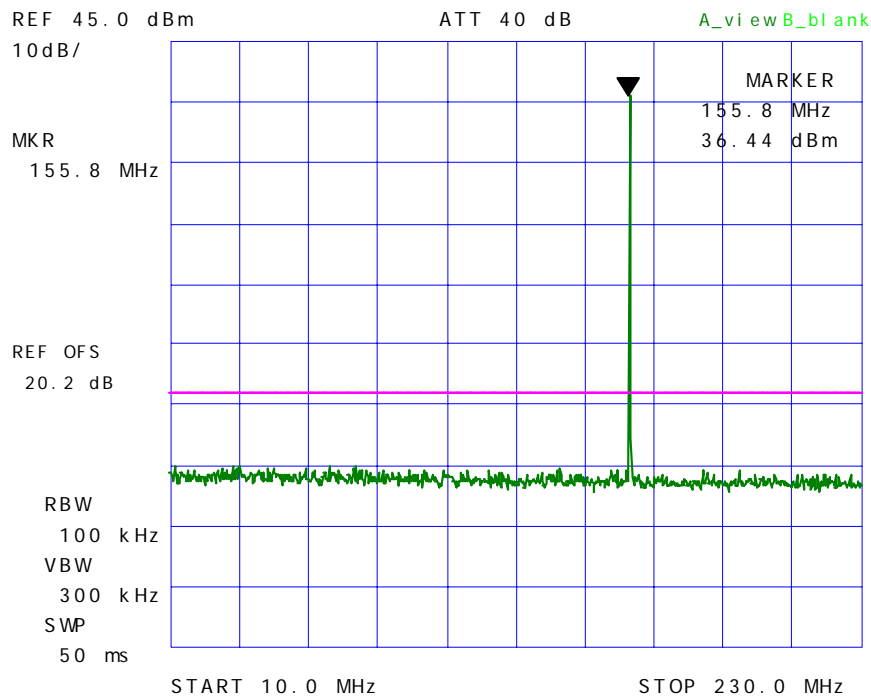

Plot # 14:
Spurious Emissions at Antenna Terminals
Carrier Frequency: 156.025 MHz
Channel Spacing: 25.0 kHz
Power: 6 W
Modulation: FM with 2.5kHz sine wave

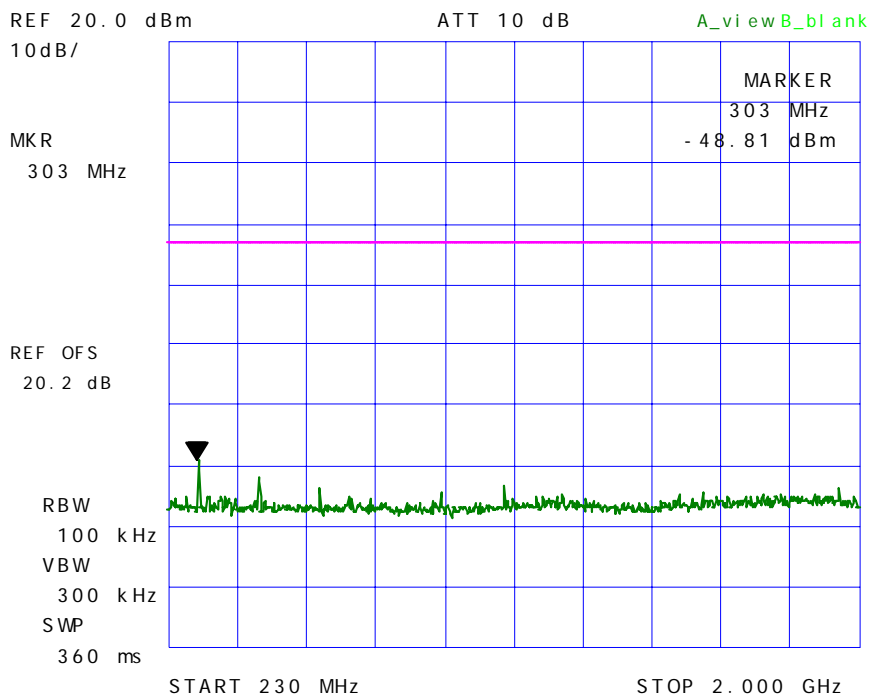

ULTRATECH GROUP OF LABS

3000 Bristol Circle, Oakville, Ontario, Canada L6H 6G4
Tel. #: 905-829-1570, Fax. #: 905-829-8050, Email: vic@ultratech-labs.com, Website: <http://www.ultratech-labs.com>

File #: ICOM-092F80-90
January 3, 2006

All test results contained in this engineering test report are traceable to National Institute of Standards and Technology (NIST)

Plot # 15:
Spurious Emissions at Antenna Terminals
Carrier Frequency: 156.025 MHz
Channel Spacing: 25.0 kHz
Power: 1 W
Modulation: FM with 2.5kHz sine wave

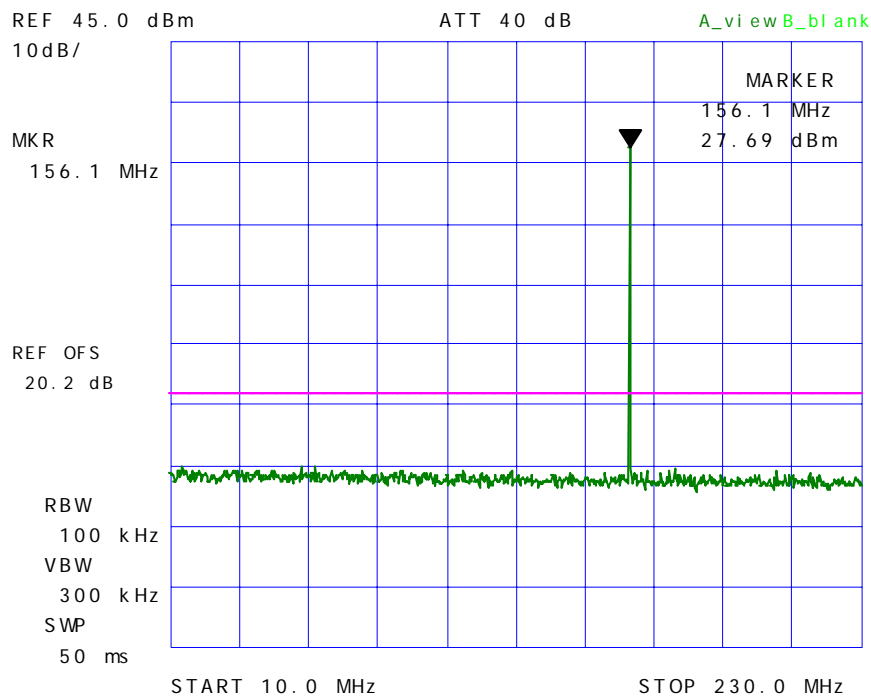

ULTRATECH GROUP OF LABS

3000 Bristol Circle, Oakville, Ontario, Canada L6H 6G4
Tel. #: 905-829-1570, Fax. #: 905-829-8050, Email: vic@ultratech-labs.com, Website: <http://www.ultratech-labs.com>

File #: ICOM-092F80-90
January 3, 2006

All test results contained in this engineering test report are traceable to National Institute of Standards and Technology (NIST)

Plot # 16:
Spurious Emissions at Antenna Terminals
Carrier Frequency: 156.025 MHz
Channel Spacing: 25.0 kHz
Power: 1 W
Modulation: FM with 2.5kHz sine wave

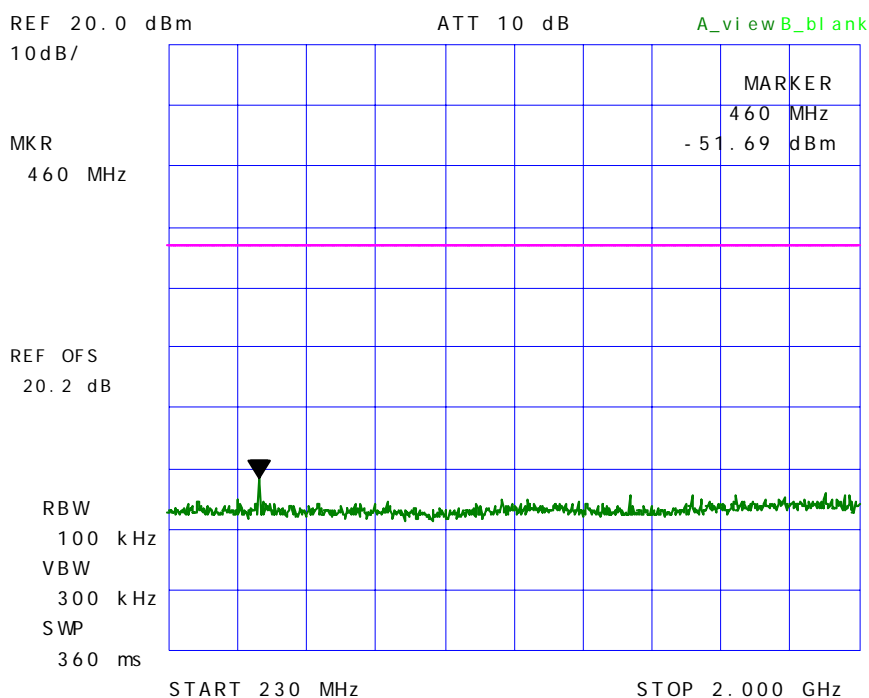

ULTRATECH GROUP OF LABS

3000 Bristol Circle, Oakville, Ontario, Canada L6H 6G4
Tel. #: 905-829-1570, Fax. #: 905-829-8050, Email: vic@ultratech-labs.com, Website: <http://www.ultratech-labs.com>

File #: ICOM-092F80-90
January 3, 2006

All test results contained in this engineering test report are traceable to National Institute of Standards and Technology (NIST)

6.10.5.2. Near Highest Frequency (157.425 MHz)

Plot # 17:
Spurious Emissions at Antenna Terminals
Carrier Frequency: 157.425 MHz
Channel Spacing: 25.0 kHz
Power: 6 W
Modulation: FM with 2.5kHz sine wave

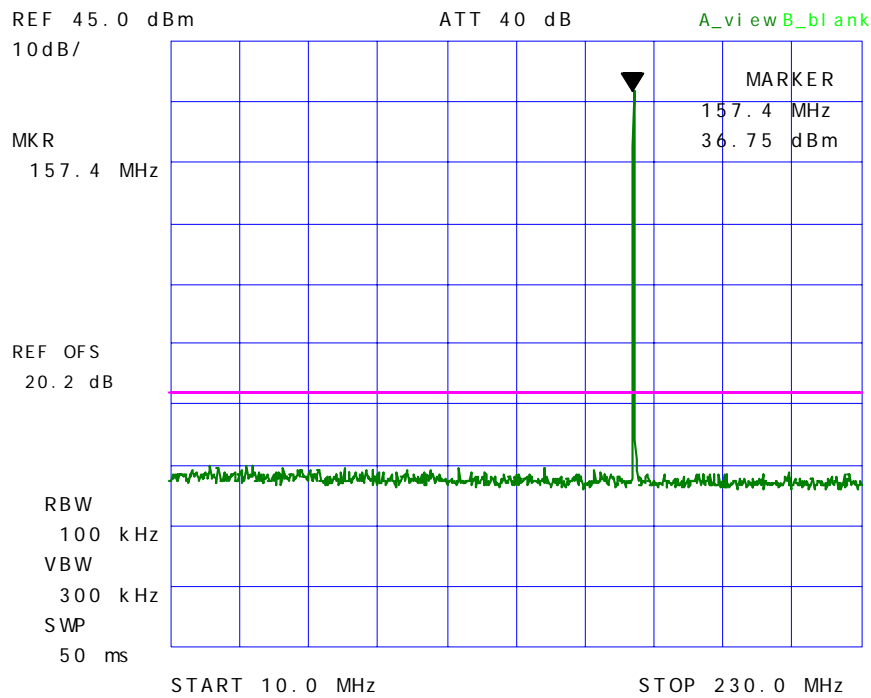

Plot # 18:
Spurious Emissions at Antenna Terminals
Carrier Frequency: 157.425 MHz
Channel Spacing: 25.0 kHz
Power: 6 W
Modulation: FM with 2.5kHz sine wave

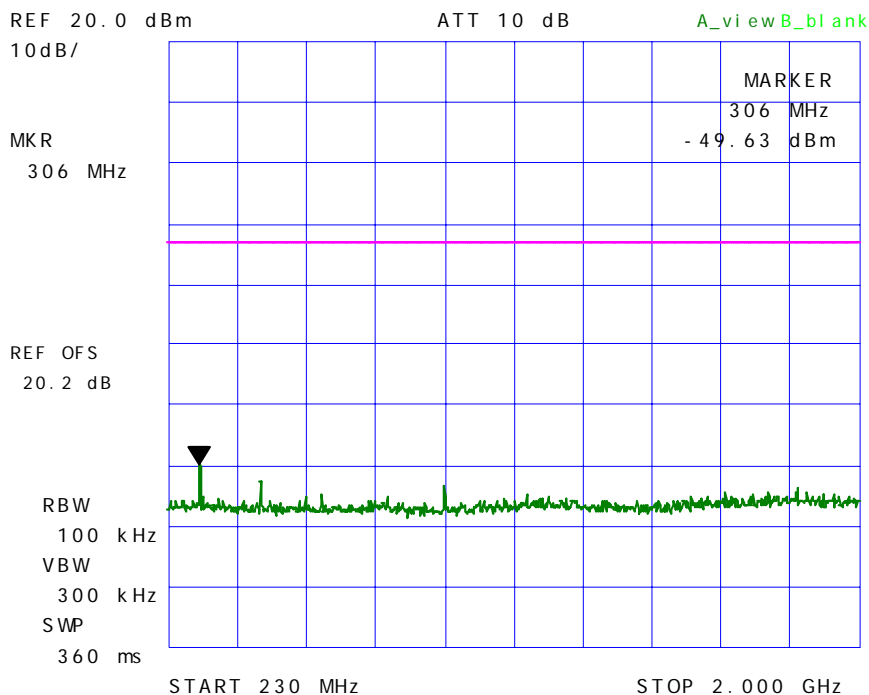

ULTRATECH GROUP OF LABS

3000 Bristol Circle, Oakville, Ontario, Canada L6H 6G4
Tel. #: 905-829-1570, Fax. #: 905-829-8050, Email: vic@ultratech-labs.com, Website: <http://www.ultratech-labs.com>

File #: ICOM-092F80-90

January 3, 2006

All test results contained in this engineering test report are traceable to National Institute of Standards and Technology (NIST)

Plot #19:
Spurious Emissions at Antenna Terminals
Carrier Frequency: 157.425 MHz
Channel Spacing: 25.0 kHz
Power: 1 W
Modulation: FM with 2.5kHz sine wave

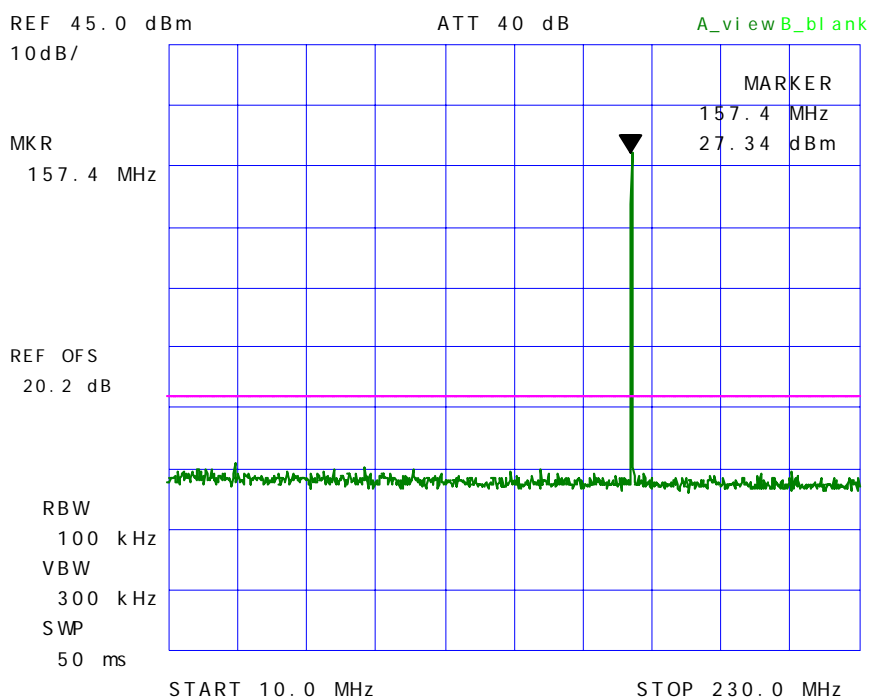

ULTRATECH GROUP OF LABS

3000 Bristol Circle, Oakville, Ontario, Canada L6H 6G4
Tel. #: 905-829-1570, Fax. #: 905-829-8050, Email: vic@ultratech-labs.com, Website: <http://www.ultratech-labs.com>

File #: ICOM-092F80-90
January 3, 2006

All test results contained in this engineering test report are traceable to National Institute of Standards and Technology (NIST)

Plot # 20:
Spurious Emissions at Antenna Terminals
Carrier Frequency: 157.425 MHz
Channel Spacing: 25.0 kHz
Power: 1 W
Modulation: FM with 2.5kHz sine wave

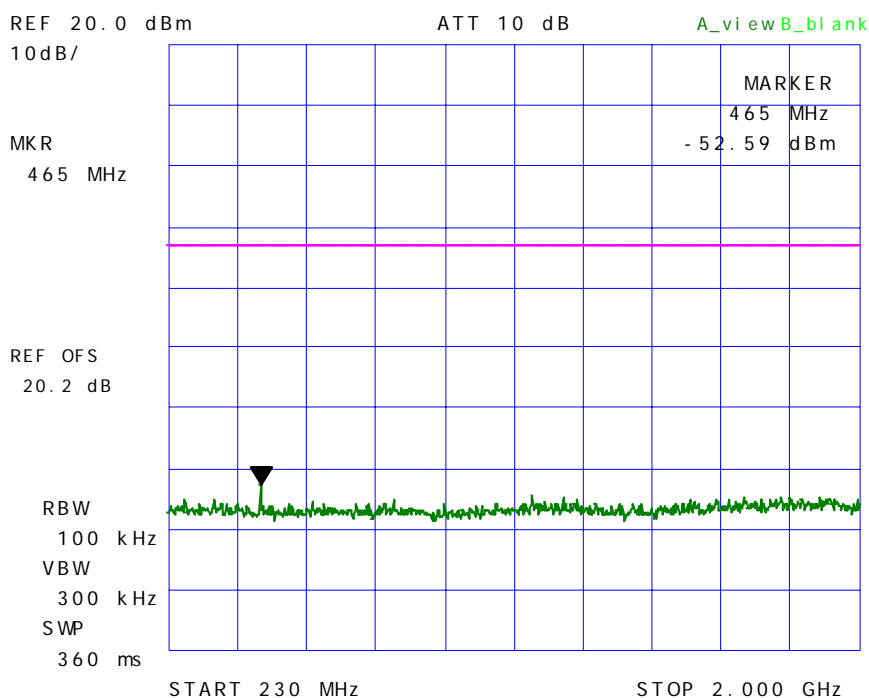

ULTRATECH GROUP OF LABS

3000 Bristol Circle, Oakville, Ontario, Canada L6H 6G4
Tel. #: 905-829-1570, Fax. #: 905-829-8050, Email: vic@ultratech-labs.com, Website: <http://www.ultratech-labs.com>

File #: ICOM-092F80-90
January 3, 2006

All test results contained in this engineering test report are traceable to National Institute of Standards and Technology (NIST)

6.11. TRANSMITTER SPURIOUS/HARMONIC RADIATED EMISSIONS [§§ 80.211(f)(3)]

6.11.1. Limits

Emissions shall be attenuated below the mean output power of the transmitter as follows:

FCC Rules	Frequency Range	Attenuation Limit (dBc)
80.211(f)(3) - Marine	10 MHz or Lowest frequency of the radio to 10 th harmonic of the highest frequency of the radio	43+10*log(P)

6.11.2. Method of Measurements

The spurious/harmonic ERP measurements are using substitution method specified in Exhibit 8, § 8.2 of this report and its value in dBc is calculated as follows:

- (1) If the transmitter's antenna is an integral part of the EUT, the ERP is measured using substitution method.
- (2) If the transmitter's antenna is non-integral and diverse, the lowest ERP of the carrier with 0 dBi antenna gain is used for calculation of the spurious/harmonic emissions in dBc:
Lowest ERP of the carrier = EIRP – 2.15 dB = P_c + G - 2.15 dB = P_c dBm (conducted) + 0 dBi – 2.15 dB
- (3) Spurious /harmonic emissions levels expressed in dBc (dB below carrier) are as follows:

$$\text{ERP of spurious/harmonic (dBc)} = \text{ERP of carrier (dBm)} - \text{ERP of spurious/harmonic emission (dBm)}$$

6.11.3. Test Equipment List

Test Instruments	Manufacturer	Model No.	Serial No.	Frequency Range
Spectrum Analyzer/ EMI Receiver	Hewlett Packard	HP 8546A	...	9 kHz to 5.6 GHz with built-in 30 dB Gain Pre-selector, QP, Average & Peak Detectors.
RF Amplifier	Com-Power	PA-102		1 MHz to 1 GHz, 30 dB gain nominal
Microwave Amplifier	Hewlett Packard	HP 83017A		1 GHz to 26.5 GHz, 30 dB nominal
Biconilog Antenna	EMCO	3142	10005	30 MHz to 2 GHz
Dipole Antenna	EMCO	3121C	8907-434	30 GHz – 1 GHz
Dipole Antenna	EMCO	3121C	8907-440	30 GHz – 1 GHz
Horn Antenna	EMCO	3155	9701-5061	1 GHz – 18 GHz
Horn Antenna	EMCO	3155	9911-5955	1 GHz – 18 GHz
RF Signal Generator	Hewlett Packard	HP 83752B	3610A00457	0.01 – 20 GHz

6.11.4. Test Data

Remarks:

- The radiated emissions are performed with high power setting (6 Watts) at 3 meters distance to represents the worst-case test configuration.

6.11.4.1. Near Lowest Frequency (156.025 MHz)

Fundamental Frequency: 156.025 MHz
RF Output Power: 6 Watts
Modulation: FM modulation with 2.5 kHz sine wave signal
Frequency Test Range: 30 MHz – 2 GHz

All spurious emissions and harmonics are more than 20 dB below the limit.

6.11.4.2. Near Highest Frequency (157.425 MHz)

Fundamental Frequency: 157.425 MHz
RF Output Power: 6 Watts
Modulation: FM modulation with 2.5 kHz sine wave signal
Frequency Test Range: 30 MHz – 2 GHz

All spurious emissions and harmonics are more than 20 dB below the limit.

EXHIBIT 7. MEASUREMENT UNCERTAINTY

The measurement uncertainties stated were calculated in accordance with the requirements of NIST Technical Note 1297 and NIS 81 (1994)

7.1. RADIATED EMISSION MEASUREMENT UNCERTAINTY

CONTRIBUTION (Radiated Emissions)	PROBABILITY DISTRIBUTION	UNCERTAINTY (\pm dB)	
		3 m	10 m
Antenna Factor Calibration	Normal (k=2)	± 1.0	± 1.0
Cable Loss Calibration	Normal (k=2)	± 0.3	± 0.5
EMI Receiver specification	Rectangular	± 1.5	± 1.5
Antenna Directivity	Rectangular	+0.5	+0.5
Antenna factor variation with height	Rectangular	± 2.0	± 0.5
Antenna phase center variation	Rectangular	0.0	± 0.2
Antenna factor frequency interpolation	Rectangular	± 0.25	± 0.25
Measurement distance variation	Rectangular	± 0.6	± 0.4
Site imperfections	Rectangular	± 2.0	± 2.0
Mismatch: Receiver VRC $\Gamma_1 = 0.2$ Antenna VRC $\Gamma_R = 0.67$ (Bi) 0.3 (Lp) Uncertainty limits $20\text{Log}(1 \pm \Gamma_1 \Gamma_R)$	U-Shaped	+1.1 -1.25	± 0.5
System repeatability	Std. Deviation	± 0.5	± 0.5
Repeatability of EUT		-	-
Combined standard uncertainty	Normal	+2.19 / -2.21	+1.74 / -1.72
Expanded uncertainty U	Normal (k=2)	+4.38 / -4.42	+3.48 / -3.44

Calculation for maximum uncertainty when 3m biconical antenna including a factor of k = 2 is used:

$$U = 2u_c(y) = 2x(+2.19) = +4.38 \text{ dB} \quad \text{And} \quad U = 2u_c(y) = 2x(-2.21) = -4.42 \text{ dB}$$

EXHIBIT 8. MEASUREMENT METHODS

8.1. CONDUCTED POWER MEASUREMENTS

The following shall be applied to the combination(s) of the radio device and its intended antenna(e).

- If the RF level is user adjustable, all measurements shall be made with the highest power level available to the user for that combination.
- The following method of measurement shall apply to both conducted and radiated measurements.
 - The radiated measurements are performed at the Ultratech Calibrated Open Field Test Site.
 - The measurement shall be performed using normal operation of the equipment with modulation.
- Test procedure shall be as follows:

Step 1: Duty Cycle measurements if the transmitter's transmission is transient

- Using a EMI Receiver with the frequency span set to 0 Hz and the sweep time set at a suitable value to capture the envelope peaks and the duty cycle of the transmitter output signal;
- The duty cycle of the transmitter, $x = \text{Tx on} / (\text{Tx on} + \text{Tx off})$ with $0 < x < 1$, is measure and recorded in the test report. For the purpose of testing, the equipment shall be operated with a duty cycle that is equal or more than 0.1.

Step 2: Calculation of Average EIRP. See Figure 1

- The average output power of the transmitter shall be determined using a wideband, calibrated RF average power meter with the power sensor with an integration period that exceeds the repetition period of the transmitter by a factor 5 or more. The observed value shall be recorded as "A" (in dBm);
- The e.i.r.p. shall be calculated from the above measured power output "A", the observed duty cycle x , and the applicable antenna assembly gain "G" in dBi, according to the formula:

$$\text{EIRP} = \text{A} + \text{G} + 10\log(1/x)$$

{ $X = 1$ for continuous transmission $\Rightarrow 10\log(1/x) = 0 \text{ dB}$ }

Figure 1.

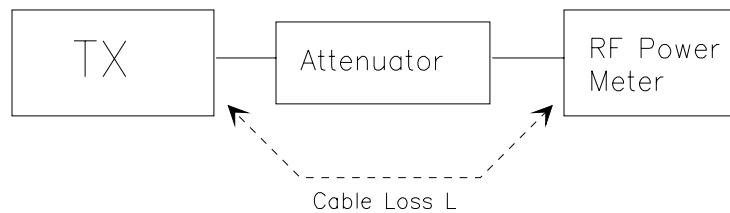

8.2. RADIATED POWER MEASUREMENTS (ERP & EIRP) USING SUBSTITUTION METHOD

8.2.1. Maximizing RF Emission Level (E-Field)

- The measurements was performed with full rf output power and modulation.
- Test was performed at listed 3m open area test site (listed with FCC, IC, ITI, NVLAP, ACA & VCCI).
- The transmitter under test was placed at the specified height on a non-conducting turntable (80 cm height)
- The BICONILOG antenna (20 MHz to 1 GHz) or HORN antenna (1 GHz to 18 GHz) was used for measuring.
- Load an appropriate correction factors file in EMI Receiver for correcting the field strength reading level

Total Correction Factor recorded in the EMI Receiver = Cable Loss + Antenna Factor
E (dBuV/m) = Reading (dBuV) + Total Correction Factor (dB/m)

- Set the EMI Receiver #1 and #2 as follows:

Center Frequency:	test frequency
Resolution BW:	100 kHz
Video BW:	same
Detector Mode:	positive
Average:	off
Span:	3 x the signal bandwidth

- The test antenna was lowered or raised from 1 to 4 meters until the maximum signal level was detected.
- The transmitter was rotated through 360° about a vertical axis until a higher maximum signal was received.
- The test antenna was lowered or raised again from 1 to 4 meters until a maximum was obtained. This level was recorded.
- The recorded reading was corrected to the true field strength level by adding the antenna factor, cable loss and subtracting the pre-amplifier gain.
- The above steps were repeated with both transmitters' antenna and test receiving antenna placed in vertical and horizontal polarization. Both readings with the antennas placed in vertical and horizontal polarization shall be recorded.
- Repeat for all different test signal frequencies

8.2.2. Measuring the EIRP of Spurious/Harmonic Emissions using Substitution Method

- Set the EMI Receiver (for measuring E-Field) and Receiver #2 (for measuring EIRP) as follows:

Center Frequency: equal to the signal source
Resolution BW: 10 kHz
Video BW: same
Detector Mode: positive
Average: off
Span: 3 x the signal bandwidth

- Load an appropriate correction factors file in EMI Receiver for correcting the field strength reading level

Total Correction Factor recorded in the EMI Receiver = Cable Loss + Antenna Factor
 $E \text{ (dBuV/m)} = \text{Reading (dBuV)} + \text{Total Correction Factor (dB/m)}$

- Select the frequency and E-field levels obtained in the Section 8.2.1 for ERP/EIRP measurements.
- Substitute the EUT by a signal generator and one of the following transmitting antenna (substitution antenna):
 - DIPOLE antenna for frequency from 30-1000 MHz or
 - HORN antenna for frequency above 1 GHz }.
- Mount the transmitting antenna at 1.5 meter high from the ground plane.
- Use one of the following antenna as a receiving antenna:
 - DIPOLE antenna for frequency from 30-1000 MHz or
 - HORN antenna for frequency above 1 GHz }.
- If the DIPOLE antenna is used, tune it's elements to the frequency as specified in the calibration manual.
- Adjust both transmitting and receiving antenna in a VERTICAL polarization.
- Tune the EMI Receivers to the test frequency.
- Lower or raise the test antenna from 1 to 4 meters until the maximum signal level was detected.
- The transmitter was rotated through 360° about a vertical axis until a higher maximum signal was received.
- Lower or raise the test antenna from 1 to 4 meters until the maximum signal level was detected.
- Adjust input signal to the substitution antenna until an equal or a known related level to that detected from the transmitter was obtained in the test receiver.
- Record the power level read from the Average Power Meter and calculate the ERP/EIRP as follows:

$$P = P1 - L1 = (P2 + L2) - L1 = P3 + A + L2 - L1$$

$$\text{EIRP} = P + G1 = P3 + L2 - L1 + A + G1$$

$$\text{ERP} = \text{EIRP} - 2.15 \text{ dB}$$

$$\text{Total Correction factor in EMI Receiver \# 2} = L2 - L1 + G1$$

Where: P: Actual RF Power fed into the substitution antenna port after corrected.
P1: Power output from the signal generator
P2: Power measured at attenuator A input
P3: Power reading on the Average Power Meter
EIRP: EIRP after correction
ERP: ERP after correction

- Adjust both transmitting and receiving antenna in a HORIZONTAL polarization, then repeat step (k) to (o)
- Repeat step (d) to (o) for different test frequency
- Repeat steps (c) to (j) with the substitution antenna oriented in horizontal polarization.
- Actual gain of the EUT's antenna is the difference of the measured EIRP and measured RF power at the RF port. Correct the antenna gain if necessary.

Figure 2

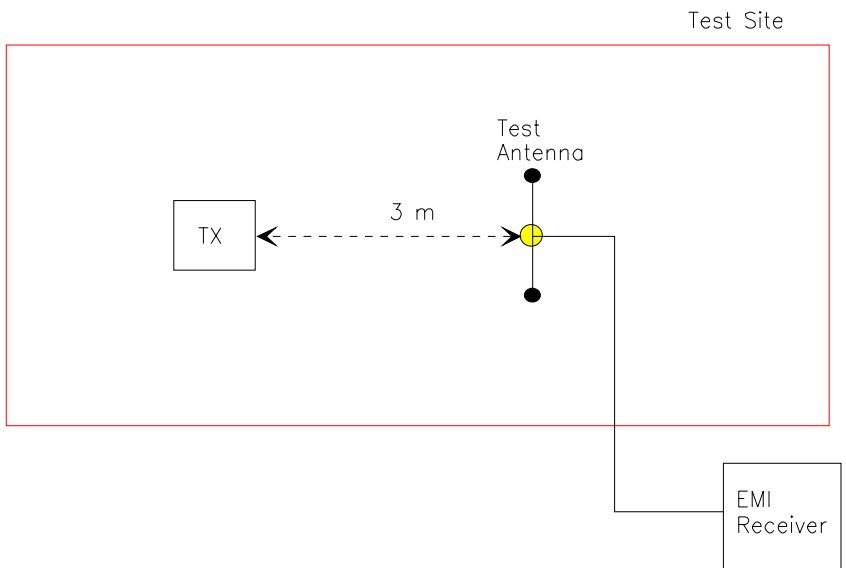
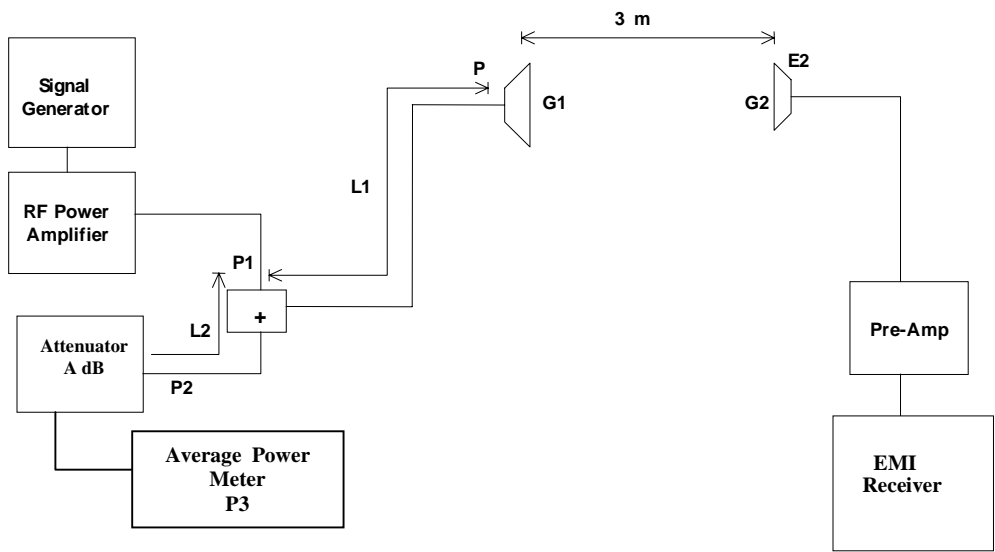

Figure 3



8.3. FREQUENCY STABILITY

Refer to § 2.1055.

- (a) The frequency stability shall be measured with variation of ambient temperature as follows: From -30 to +50 centigrade except that specified in subparagraph (2) & (3) of this paragraph.
- (b) Frequency measurements shall be made at extremes of the specified temperature range and at intervals of not more than 10 centigrade through the range. A period of time sufficient to stabilize all of the components of the oscillator circuit at each temperature level shall be allowed prior to frequency measurement. The short-term transient effects on the frequency of the transmitter due to keying (except for broadcast transmitters) and any heating element cycling normally occurring at each ambient temperature level also shall be shown. Only the portion or portions of the transmitter containing the frequency determining and stability circuitry need be subjected to the temperature variation test.
- (d) The frequency stability supply shall be measured with variation of primary supply voltage as follows:
 - (1) Vary primary supply voltage from 85 to 115 percent of the nominal value for other than hand carried battery equipment.
 - (2) For hand carried, battery powered equipment, reduce primary supply voltage to the battery operating end point which shall be specified by the manufacturer.
 - (3) The supply voltage shall be measured at the input to the cable normally provide with the equipment, or at the power supply terminals if cables are not normally provided. Effects on frequency of transmitter keying (except for broadcast transmitters) and any heating element cycling at the nominal supply voltage and at each extreme also shall be shown.
- (e) When deemed necessary, the Commission may require tests of frequency stability under conditions in addition to those specifically set out in paragraphs (a), (b), (c) and (d) of this section. (For example, measurements showing the effect of proximity to large metal objects, or of various types of antennas, may be required for portable equipment).

8.4. EMISSION MASK

Voice or Digital Modulation Through a Voice Input Port @ 2.1049(c)(i):- The transmitter was modulated by a 2.5 KHz tone signal at an input level 16 dB greater than that required to produce 50% modulation (e.g.: ± 2.5 KHz peak deviation at 1 KHz modulating frequency). The input level was established at the frequency of maximum response of the audio modulating circuit.

Digital Modulation Through a Data Input Port @ 2.1049(h):- Transmitters employing digital modulation techniques - when modulated by an input signal such that its amplitude and symbol rate represent the maximum rated conditions under which the equipment will be operated. The signal shall be applied through any filter networks, pseudo-random generators or other devices required in normal service. Additionally, the Emission Masks shall be shown for operation with any devices used for modifying the spectrum when such devices are operational at the discretion of the user.

The following EMI Receiver bandwidth shall be used for measurement of Emission Mask/Out-of-Band Emission Measurements:

For 25 kHz Channel Spacing: RBW = 300 Hz

For 12.5 kHz or 6.25 kHz Channel Spacings: RBW = 100 Hz

The all cases the Video Bandwidth shall be equal or greater than the measuring bandwidth.

8.5. SPURIOUS EMISSIONS (CONDUCTED)

With transmitter modulation characteristics described in Out-of-Band Emissions measurements @ 2.1049, the transmitter spurious and harmonic emissions were scanned. The spurious and harmonic emissions were measured with the EMI Receiver controls set as RBW = 30 kHz minimum , VBW \geq RBW and SWEEP TIME = AUTO). The transmitter was operated at a full rated power output, and modulated as follows:

FCC 47 CFR 2.1057 - Frequency Spectrum to be investigated: The spectrum was investigated from the lowest radio generated in the equipment up to at least the 10th harmonic of the carrier frequency or to the highest frequency practicable in the present state of the art of measuring techniques, whichever is lower. Particular attention should be paid to harmonics and subharmonics of the carrier frequency. Radiation at the frequencies of multiplier stages should be checked. The amplitude of spurious emissions which are attenuated more than 20 dB below the permissible value need not be reported.

FCC 47 CFR 2.1051 - Spurious Emissions at Antenna Terminal: The radio frequency voltage or powers generated within the equipment and appearing on a spurious frequency shall be checked at the equipment output terminals when properly loaded with a suitable artificial antenna. Curves or equivalent data shall show the magnitude of the harmonic and other spurious emission that can be detected when the equipment is operated under the conditions specified in 2.1049 as appropriate. The magnitude of spurious emissions which are attenuated more than 20 dB below the permissible value need not be specified.