

# ENGINEERING TEST REPORT

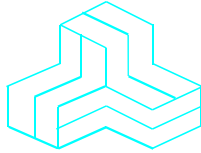

## Communication Receiver Model Nos.: IC-R2500 & IC-PCR2500

**FCC ID: AFJ287901**

*Applicant:*

**ICOM Incorporated**  
1-1-32, Kamiminami, Hirano-ku  
Osaka, Japan, 547-0003

**Tested in Accordance With**

**Federal Communications Commission (FCC)  
47 CFR, Part 15, Subpart B  
Scanning Receivers Operating in the Frequency Band 0.495 to 3299.9999 MHz**

**UltraTech's File No.: ICOM-151FCC15RX**

This Test report is Issued under the Authority of  
Tri M. Luu, Professional Engineer,  
Vice President of Engineering  
UltraTech Group of Labs

Date: June 11, 2007



Report Prepared by: Dharmajit Solanki, RF Engineer

Tested by: Wayne Wu, EMI/RFI Technician

Issued Date: June 11, 2007

Test Dates: Mar.22 - Apr.03, 2006

- *The results in this Test Report apply only to the sample(s) tested, and the sample tested is randomly selected.*
- *This report must not be used by the client to claim product endorsement by NVLAP or any agency of the US Government.*

## UltraTech

3000 Bristol Circle, Oakville, Ontario, Canada, L6H 6G4  
Tel.: (905) 829-1570 Fax.: (905) 829-8050

Website: [www.ultratech-labs.com](http://www.ultratech-labs.com), Email: [vic@ultratech-labs.com](mailto:vic@ultratech-labs.com), Email: [tri@ultratech-labs.com](mailto:tri@ultratech-labs.com)



## TABLE OF CONTENTS

<b>EXHIBIT 1. SUBMITTAL CHECK LIST.....</b>	<b>2</b>
<b>EXHIBIT 2. INTRODUCTION.....</b>	<b>3</b>
2.1. SCOPE.....	3
2.2. RELATED SUBMITTAL(S)/GRANT(S).....	3
2.3. NORMATIVE REFERENCES.....	3
<b>EXHIBIT 3. PERFORMANCE ASSESSMENT.....</b>	<b>4</b>
3.1. CLIENT INFORMATION.....	4
3.2. EQUIPMENT UNDER TEST (EUT) INFORMATION.....	4
3.3. EUT'S TECHNICAL SPECIFICATIONS.....	5
3.4. LIST OF EUT'S PORTS.....	5
3.5. ANCILLARY EQUIPMENT.....	5
3.6. DRAWING OF TEST SETUP.....	6
<b>EXHIBIT 4. EUT OPERATING CONDITIONS AND CONFIGURATIONS DURING TESTS.....</b>	<b>7</b>
4.1. CLIMATE TEST CONDITIONS.....	7
4.2. OPERATIONAL TEST CONDITIONS & ARRANGEMENT FOR TEST SIGNALS.....	7
<b>EXHIBIT 5. SUMMARY OF TEST RESULTS.....</b>	<b>8</b>
5.1. LOCATION OF TESTS.....	8
5.2. APPLICABILITY & SUMMARY OF EMC EMISSION TEST RESULTS.....	8
5.3. MODIFICATIONS REQUIRED FOR COMPLIANCE.....	8
<b>EXHIBIT 6. MEASUREMENTS, EXAMINATIONS &amp; TEST DATA FOR EMC EMISSIONS.....</b>	<b>9</b>
6.1. TEST PROCEDURES.....	9
6.2. MEASUREMENT UNCERTAINTIES.....	9
6.3. MEASUREMENT EQUIPMENT USED.....	9
6.4. AC POWER LINE CONDUCTED EMISSIONS [§ 15.107(A)].....	10
6.5. RECEIVER ANTENNA POWER SPURIOUS/HARMONIC CONDUCTED EMISSIONS [§15.111(A)].....	14
6.6. RECEIVER SPURIOUS/HARMONIC RADIATED EMISSIONS [§ 15.109(A)].....	26
6.7. RADIATED EMISSIONS FROM CLASS B UNINTENTIONAL RADIATORS (DIGITAL DEVICES) [§ 15.109(A)].....	29
6.8. REQUIREMENTS FOR SCANNING RECEIVERS [47 CFR 15.121].....	31
<b>EXHIBIT 7. MEASUREMENT UNCERTAINTY.....</b>	<b>34</b>
7.1. LINE CONDUCTED EMISSION MEASUREMENT UNCERTAINTY.....	34
7.2. RADIATED EMISSION MEASUREMENT UNCERTAINTY.....	35

## EXHIBIT 1. SUBMITTAL CHECK LIST

Annex No.	Exhibit Type	Description of Contents	Quality Check (OK)
--	Test Report	Exhibit 1: Submittal check lists Exhibit 2: Introduction Exhibit 3: Performance Assessment Exhibit 4: EUT Operation and Configuration during Tests Exhibit 5: Summary of test Results Exhibit 6: Measurement Data Exhibit 7: Measurement Uncertainty	OK
1	Test Setup Photos	Radiated Emissions Test Setup Photos	OK
2	External Photos of EUT	External EUT Photos	OK
3	Internal Photos of EUT	Internal EUT Photos	OK
4	Cover Letters	Cover Letter for Certification Request. Letter from the Applicant to appoint Ultratech to act as an agent Letter from the Applicant to request for Confidentiality Filing	OK
5	Attestation Statements	Manufacturer Attestation Letter	OK
6	ID Label/Location Info	ID Label Location of ID Label	OK
7	Block Diagrams	Block Diagram	OK
8	Schematic Diagrams	Schematics	OK
9	Operational Description	IC-R2500 & IC-PCR2500 Circuit Description	OK
10	RF Exposure Info	N/A	N/A
11	Users Manual	IC-R2500 & IC-PCR2500 Instruction Manual	OK

## EXHIBIT 2. INTRODUCTION

### 2.1. SCOPE

<b>Reference:</b>	FCC Part 15, Subpart B, Sections 15.107, 15.109, 15.111 & 15.121
<b>Title:</b>	Code of Federal Regulations (CFR), Title 47, Telecommunication, Part 15
<b>Purpose of Test:</b>	To gain FCC Certification Authorization for Scanning Receivers Operating in 0.495 to 3299.9999 MHz band.
<b>Test Procedures:</b>	Both conducted and radiated emissions measurements were conducted in accordance with American National Standards Institute ANSI C63.4 - American National Standard for Methods of Measurement of Radio-Noise Emissions from Low-Voltage Electrical and Electronic Equipment in the Range of 9 kHz to 40 GHz.
<b>Environmental Classification:</b>	Commercial, Industrial or Business environment.

### 2.2. RELATED SUBMITTAL(S)/GRANT(S)

None.

### 2.3. NORMATIVE REFERENCES

Publication	YEAR	Title
FCC CFR 47 Parts 0-19, 80-End	2006	Code of Federal Regulations – Telecommunication
ANSI C63.4	2003	American National Standard for Methods of Measurement of Radio-Noise Emissions from Low-Voltage Electrical and Electronic Equipment in the Range of 9 kHz to 40 GHz
CISPR 22 +A1 EN 55022	2003-04-10 2004-10-14 2003	Limits and Methods of Measurements of Radio Disturbance Characteristics of Information Technology Equipment
CISPR 16-1-1	2003	Specification for radio disturbance and immunity measuring apparatus and methods. Part 1-1: Measuring Apparatus
CISPR 16-2-1	2003	Specification for radio disturbance and immunity measuring apparatus and methods. Part 2-1: Conducted disturbance measurement
CISPR 16-2-3	2003	Specification for radio disturbance and immunity measuring apparatus and methods. Part 2-3: Radiated disturbance measurement

## EXHIBIT 3. PERFORMANCE ASSESSMENT

### 3.1. CLIENT INFORMATION

APPLICANT	
<b>Name:</b>	ICOM Incorporated
<b>Address:</b>	1-1-32, Kamiminami Hirano-ku, Osaka Japan, 547-003
<b>Contact Person:</b>	Mr. Kenji Asano Phone #: +81-66-793-5302 Fax #: +81-66-793-0013 Email Address: export@icom.co.jp

MANUFACTURER	
<b>Name:</b>	ICOM Incorporated
<b>Address:</b>	1-1-32, Kamiminami Hirano-ku, Osaka Japan, 547-0003
<b>Contact Person:</b>	Mr. Kenji Asano Phone #: +81-66-793-5302 Fax #: +81-66-793-0013 Email Address: export@icom.co.jp

### 3.2. EQUIPMENT UNDER TEST (EUT) INFORMATION

The following information (with the exception of the Date of Receipt) has been supplied by the applicant.

<b>Brand Name:</b>	ICOM Incorporated
<b>Product Name:</b>	Communication Receiver
<b>Model Name or Number:</b>	IC-R2500
<b>Serial Number:</b>	0000006
<b>Type of Equipment:</b>	Scanning Receiver
<b>Accessories:</b>	Icom AC/DC Power Supply, Model DFU105180, INPUT: 120VAC 60Hz, 29W, OUTPUT: 10.5 VDC, 1.8A.
<b>Power input source:</b>	10.5 VDC Adapter

### 3.3. EUT'S TECHNICAL SPECIFICATIONS

RECEIVER	
Equipment Type:	Fixed or Mobile
Power Supply Requirement:	12.0 VDC
Operating Frequency Range:	0.495 to 3299.9999 MHz (excluding cellular bands)
RF Input Impedance:	50 Ohms

### 3.4. LIST OF EUT'S PORTS

Port Number	EUT's Port Description	Number of Identical Ports	Connector Type	Cable Type (Shielded/Non-shielded)
1	Antenna Connector	2	BNC Female	Shielded
2	External Speaker Jack	1	SP jack	Non-Shielded
3	DC IN	1	Single Pin male	Non-Shielded
4	Packet	2	Single Pin Female	Non-Shielded
5	Controller	1	RJ11	Non-Shielded
6	USB	1	USB	Non-Shielded
7	DATA	1	Single Pin Female	Non-Shielded
8	GND	1	GND Connector	Shielded

### 3.5. ANCILLARY EQUIPMENT

The EUT was tested while connected to the following representative configuration of ancillary equipment necessary to exercise the ports during tests:

Ancillary Equipment # 1	
Description:	AC/DC Power Supply
Brand name:	ICOM
Model Name or Number:	DFU105180
Serial Number:	1
Cable Type:	Non-Shielded

### 3.6. DRAWING OF TEST SETUP

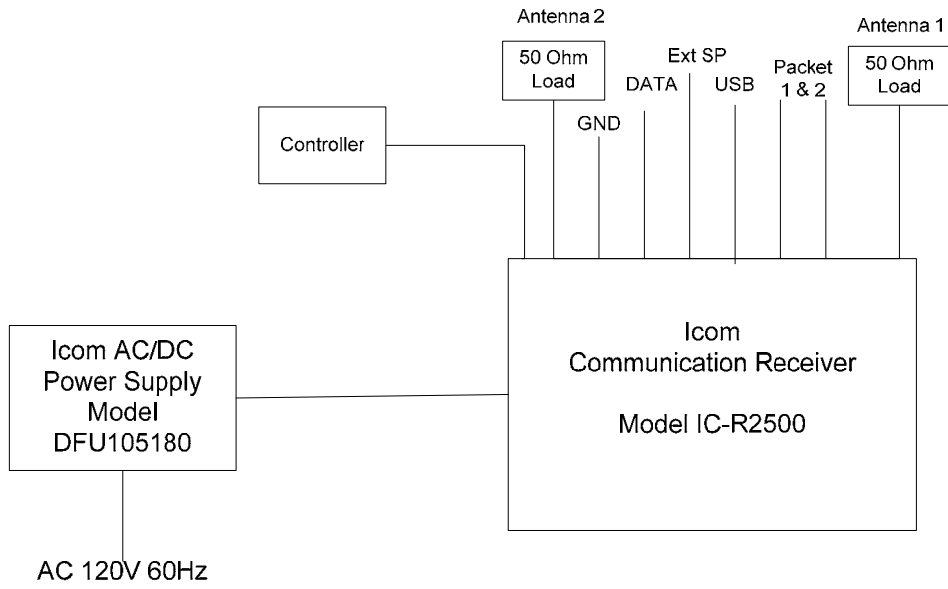

## EXHIBIT 4. EUT OPERATING CONDITIONS AND CONFIGURATIONS DURING TESTS

### 4.1. CLIMATE TEST CONDITIONS

The climate conditions of the test environment are as follows:

Temperature:	23°C
Humidity:	20%
Pressure:	102 kPa
Power input source:	10.5 VDC

### 4.2. OPERATIONAL TEST CONDITIONS & ARRANGEMENT FOR TEST SIGNALS

<b>Operating Modes:</b>	The receiver was operated in the normal intended mode during testing
<b>Special Test Software:</b>	None
<b>Special Hardware Used:</b>	None
<b>Receiver Test Antenna:</b>	The EUT's was tested with its antenna ports terminated with 50 Ohm Load

<b>Receiver Test Signals</b>	
<b>Frequency Band(s):</b>	0.495 to 3299.9999 MHz
<b>Test Frequency(ies):</b> (Near lowest, near middle & near highest frequencies in the frequency range of operation.)	0.495, 30, 1665 and 3299.9999 MHz



## EXHIBIT 5. SUMMARY OF TEST RESULTS

### 5.1. LOCATION OF TESTS

All of the measurements described in this report were performed at Ultratech Group of Labs located in the city of Oakville, Province of Ontario, Canada.

- AC Powerline Conducted Emissions were performed in UltraTech's shielded room, 16'(L) by 12'(W) by 12'(H).
- Radiated Emissions were performed at the Ultratech's 3-10 TDK Semi-Anechoic Chamber situated in the Town of Oakville, province of Ontario. This test site been calibrated in accordance with ANSI C63.4, and found to be in compliance with the requirements of Sec. 2.948 of the FCC Rules. The descriptions and site measurement data of the Oakville 3-10 TDK Semi-Anechoic Chamber has been filed with FCC office (FCC File No.: 31040/SIT 1300B3) and Industry Canada office (Industry Canada File No.: IC2049-1). Last Date of Site Calibration: June. 20, 2006.

### 5.2. APPLICABILITY & SUMMARY OF EMC EMISSION TEST RESULTS

FCC Part 15, Subpart B	Test Requirements	Compliance (Yes/No)
15.107(a), Class B	AC Power Line Conducted Emissions Measurements	Yes
15.111(a)	Receiver Antenna Power Conducted Emissions for Non-Integral Antenna Port	Yes
15.109(a)	Radiated Emissions from Scanning Receivers & Class B Digital Device	Yes
15.121	Requirements for Scanning Receivers	Yes

### 5.3. MODIFICATIONS REQUIRED FOR COMPLIANCE

None.

---

## **EXHIBIT 6. MEASUREMENTS, EXAMINATIONS & TEST DATA FOR EMC EMISSIONS**

### **6.1. TEST PROCEDURES**

Please refer to Ultratech Test Procedures, File# ULTR-P001-2004 and for Test Procedures.

### **6.2. MEASUREMENT UNCERTAINTIES**

The measurement uncertainties stated were calculated in accordance with requirements of UKAS Document LAB 34 with a confidence level of 95%. Please refer to Exhibit 6 for Measurement Uncertainties.

### **6.3. MEASUREMENT EQUIPMENT USED**

The measurement equipment used complied with the requirements of the Standards referenced in the Methods & Procedures ANSI C63.4 and CIPSR 16-1-1.

## 6.4. AC POWER LINE CONDUCTED EMISSIONS [§ 15.107(a)]

### 6.4.1. Limits

The equipment shall meet the limits of the following table:

Frequency of Emissions (MHz)	Class B Conducted Limit (dB $\mu$ V)		Measuring Bandwidth
	Quasi-Peak	Average	
0.15 to 0.5	66 to 56*	56 to 46*	RBW = 9 kHz VBW $\geq$ 9 kHz for QP VBW = 1 Hz for Average
0.5 to 5	56	46	
5 to 30	60	50	

\* Decreasing linearly with logarithm of frequency

### 6.4.2. Method of Measurements

Refer to Ultratech Test Procedures ULTR-P001-200 & ANSI C63.4 for method of measurements.

### 6.4.3. Test Equipment List

Test Instruments	Manufacturer	Model No.	Serial No.	Frequency Range
EMI Receiver System/Spectrum Analyzer with built-in Amplifier	Hewlett Packard	HP 8546A	3520A00248	9KHz-5.6GHz, 50 Ohms
Transient Limiter	Hewlett Packard	11947A	--	9 kHz – 200 MHz 10 dB attenuation
L.I.S.N.	EMCO	3825/2	--	9 kHz – 200 MHz 50 Ohms / 50 $\mu$ H
12'x16'x12' RF Shielded Chamber	RF Shielding	--	--	--

### 6.4.4. Photos of test Setup

Please refer to Photos #1 and 2 in Annex 1 for details of test setup.

**6.4.5. Test Data**

The emissions were scanned from 150 KHz to 30 MHz at AC mains Terminal via a LISN, and all emissions less than 20 dB below the limits were recorded.							
FREQUENCY (MHz)	RF LEVEL (dBuV)	RECEIVER DETECTOR (P/QP/AVG)	QP LIMIT (dBuV)	AVG LIMIT (dBuV)	MARGIN (dB)	PASS/ FAIL	LINE TESTED (L1/L2)
0.15	64.4	QP	66.0	56.0	-1.5	PASS	L1
0.15	29.8	AVG	66.0	56.0	-26.1	PASS	L1
0.56	27.4	QP	56.0	46.0	-28.6	PASS	L1
0.56	21.6	AVG	56.0	46.0	-24.4	PASS	L1
0.15	64.7	QP	66.0	56.0	-1.2	PASS	L2
0.15	30.3	AVG	66.0	56.0	-25.6	PASS	L2
0.34	36.9	QP	59.2	49.2	-22.3	PASS	L2
0.34	19.5	AVG	59.2	49.2	-29.7	PASS	L2

Conforms, Please refer to the Plots# 1 & 2 below for test results.

UltraTech Group of Labs		AC POWER LINE CONDUCTED EMISSIONS MEASUREMENT PLOT			
Applicant: ICOM America	Detector: <input checked="" type="checkbox"/> PEAK <input checked="" type="checkbox"/> QUASI-PEAK <input checked="" type="checkbox"/> AVERAGE		Temp: 23°C	Humidity:20%	
Product: Communications Receiver	Line Tested:1	Line Voltage :120VAC	Test Tech: Will	Test Date: Mar 25, 2006	
Model: IC-R2500	Standard : FCC Part 15 Class B		Comments : : AF Max Output		

**Plot # 1:**

*hp*

Signal	Freq (MHz)	PK Amp	QP Amp	AV Amp	QPΔL1
1	0.151813	70.4	64.4	29.8	-1.5
2	0.555225	36.1	27.4	21.6	-28.6

ACTV DET: PEAK  
 MEAS DET: PEAK QP AVG  
 MKR 550 kHz  
 31.46 dBμV

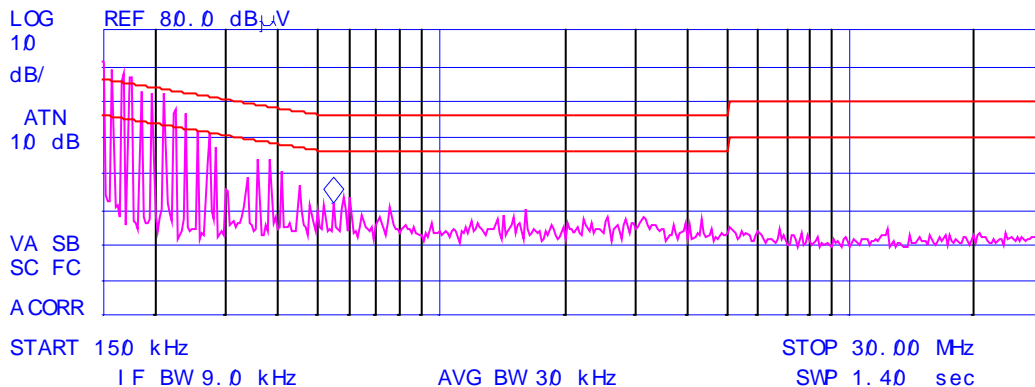

UltraTech Group of Labs		AC POWER LINE CONDUCTED EMISSIONS MEASUREMENT PLOT			
Applicant: ICOM America	Detector: <input checked="" type="checkbox"/> PEAK <input checked="" type="checkbox"/> QUASI-PEAK <input checked="" type="checkbox"/> AVERAGE		Temp: 23°C	Humidity:20%	
Product: Communications Receiver	Line Tested:2	Line Voltage :120VAC	Test Tech: Will	Test Date: Mar 25, 2006	
Model: IC-R2500	Standard : FCC Part 15 Class B		Comments : : AF Max Output		

**Plot # 2:**



Signal	Freq (MHz)	PK Amp	QP Amp	AV Amp	QPΔL1
1	0.151788	71.0	64.7	30.3	-1.2
2	0.342090	45.0	36.9	19.5	-22.3

ACTV DET: PEAK  
 MEAS DET: PEAK QP AVG  
 MKR 150 kHz  
 33.38 dBμV

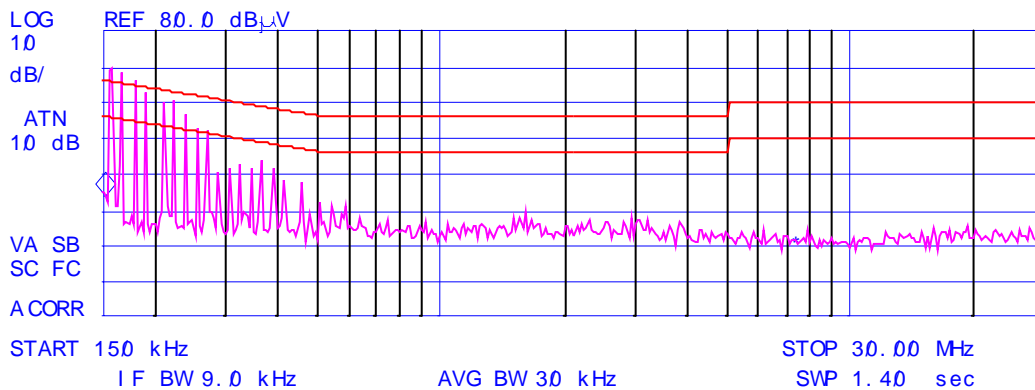

## 6.5. RECEIVER ANTENNA POWER SPURIOUS/HARMONIC CONDUCTED EMISSIONS [§15.111(a)]

### 6.5.1. Limits

Receivers that operate (tune) in the frequency range 30 to 960 Mhz and CB receivers that provides terminals for the connection of an external antenna may be tested to demonstrate compliance with the provisions of @ 15.109 with the antenna terminals shielded and terminated with a resistive termination equal to the impedance specified for the antenna, provided these receivers also comply with the following:- ***With the receiver antenna terminal connected to a resistive termination equal to the impedance specified or employed for the antenna, the power at the antenna terminal at frequency within the range from 30 Mhz to 5<sup>th</sup> harmonic of the highest frequency shall not exceed 2.0 nanowatts (or -57 dBm @ 50 Ohm).***

### 6.5.2. Method of Measurements

Refer to Ultratech Test Procedures ULTR-P001-200 & ANSI C63.4 for method of measurements.

The spectrum shall be investigated from the lowest radio frequency signal generated or used in the device, without going below the lowest frequency for which a radiated emission limit is specified, up to the frequency shown in the following table:

Highest frequency generated or used in the device or on which the device operates or tunes (MHz)	Upper frequency of measurement range (MHz)
Below 1.705	30
1.705 - 108	1000
108 – 500	2000
500 -1000	5000
Above 1000	5 <sup>th</sup> harmonic of the highest frequency or 40 GHz, whichever is lower

### 6.5.3. Test Equipment List

Test Instruments	Manufacturer	Model No.	Serial No.	Frequency Range
Spectrum Analyzer/ EMI Receiver	Rohde & Schawrz	FSEK20/B4/B21	834157/005	9 kHz – 40 GHz with external mixer
RF Signal Generator	Hewlett Packard	HP 83752B	3610A00457	0.01 – 20 GHz

#### 6.5.4. Test Arrangement

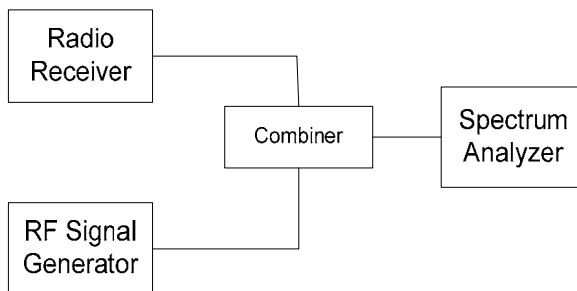



### 6.5.5. Test Data

Conform. Please refer to Plot # 3 through # 6 for detailed measurement data.

#### 6.5.5.1. Plot # 3 – Receiver Conducted Emissions @ 0.495 MHz

The emissions were scanned from 30 MHz to 1.0 GHz and all emissions found were more than 20 dB below the limits.

18:56:06 MAR 28, 2006

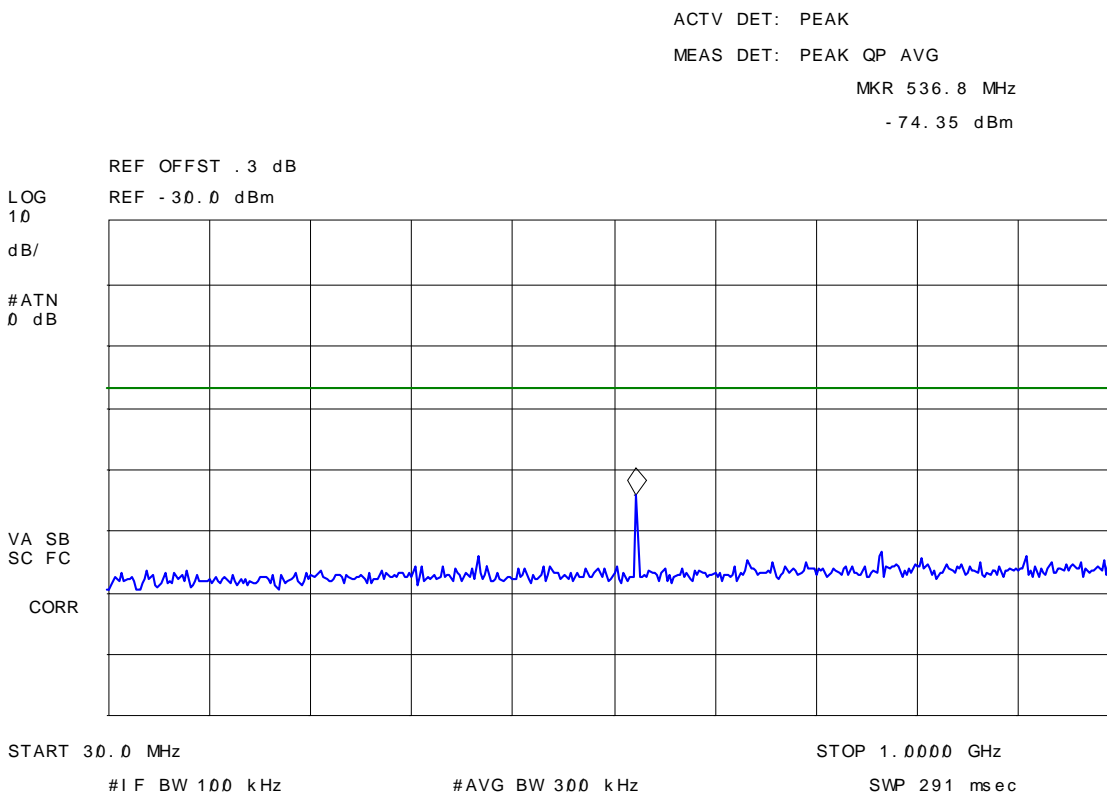

### 6.5.5.2. Plot # 4 – Receiver Conducted Emissions @ 30 MHz

The emissions were scanned from 30 MHz to 1.0 GHz and all emissions found were more than 20 dB below the limits.

18:54:45 MAR 28, 2006

ACTV DET: PEAK  
MEAS DET: PEAK QP AVG  
MKR 597.5 MHz  
- 75.86 dBm

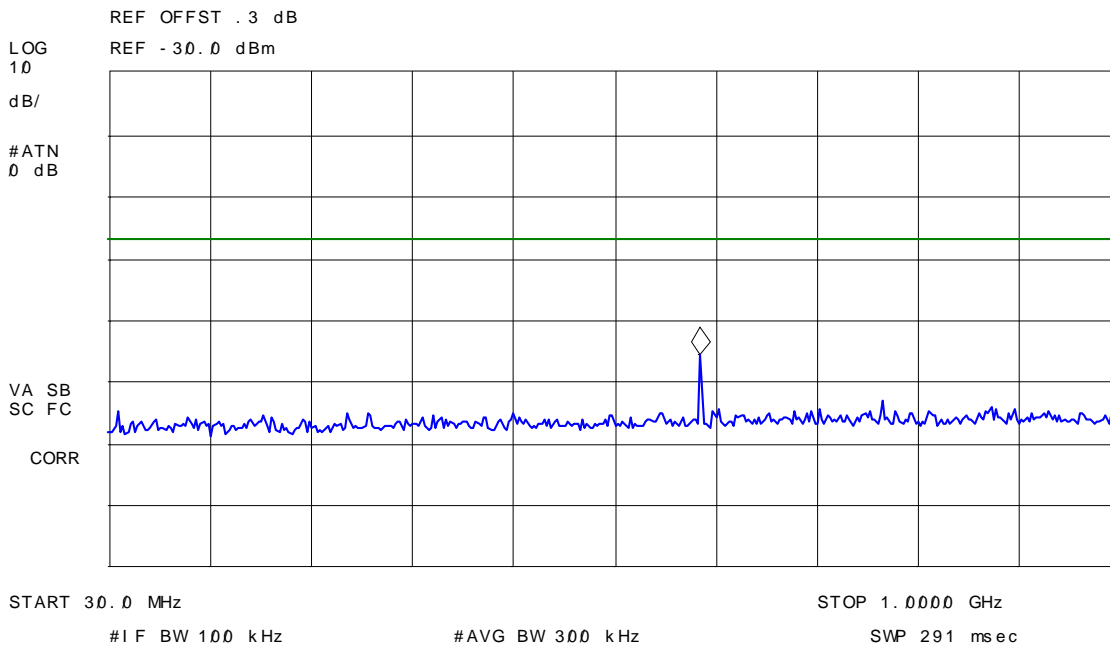

6.5.5.3. Plot # 5 – Receiver Conducted Emissions @ 1665 MHz

The emissions were scanned from 30 MHz to 10 GHz and all emissions found were more than 20 dB below the limits.

19:23:36 MAR 28, 2006

Signal Freq (MHz) PK Amp QP Amp AV Amp PK△L1

ACTV DET: PEAK  
 MEAS DET: PEAK QP AVG  
 MKR 459.2 MHz  
 - 86.79 dBm

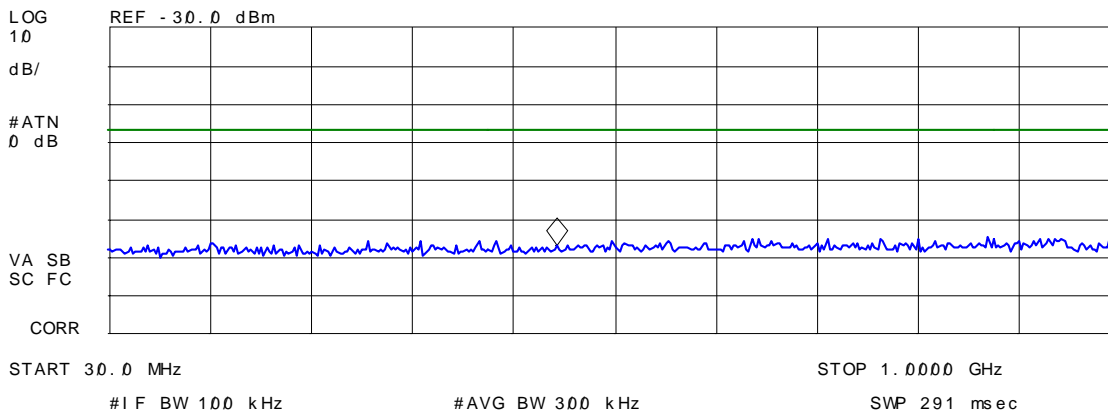

19:01:42 MAR 28, 2006

Signal	Freq (MHz)	PK Amp	QP Amp	AV Amp	PK $\Delta$ L1
1	1001.040000	-66.8	-68.8	-69.0	-9.8
2	1412.946250	-69.7	-73.9	-74.6	-12.7
3	1535.820625	-72.6	-78.5	-80.6	-15.6
4	2047.865110	-68.4	-72.8	-75.6	-11.4
5	2637.510515	-76.4	-85.9	-89.2	-19.5

ACTV DET: PEAK

MEAS DET: PEAK QP AVG

MKR 2.639 GHz

-80.12 dBm

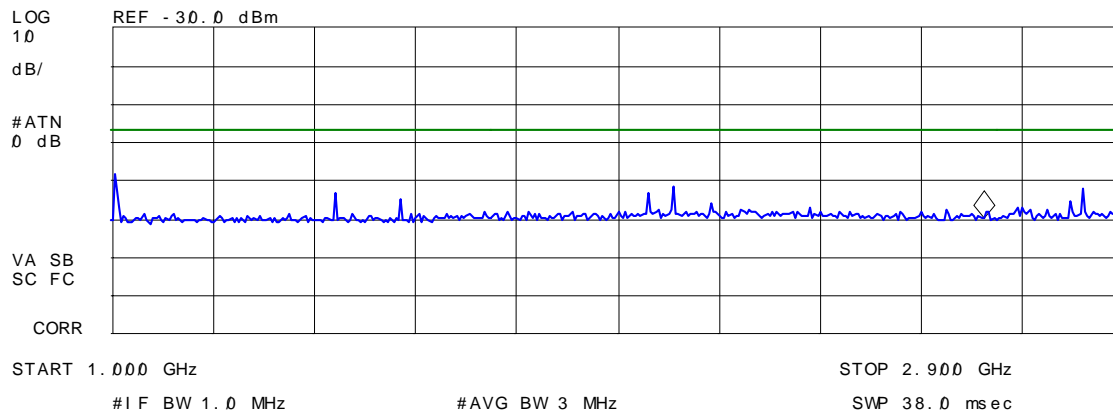

19:39:44 MAR 28, 2006

Signal	Freq (MHz)	PK Amp	QP Amp	AV Amp	PK $\Delta$ L1
1	3003.008413	-68.0	-71.5	-72.0	-11.0
2	3072.082385	-70.1	-75.5	-76.6	-13.1
3	3722.854430	-68.1	-72.5	-73.1	-11.1
4	4004.082293	-69.4	-73.4	-74.1	-12.4

ACTV DET: PEAK  
 MEAS DET: PEAK QP AVG  
 MKR 4.007 GHz  
 -78.15 dBm

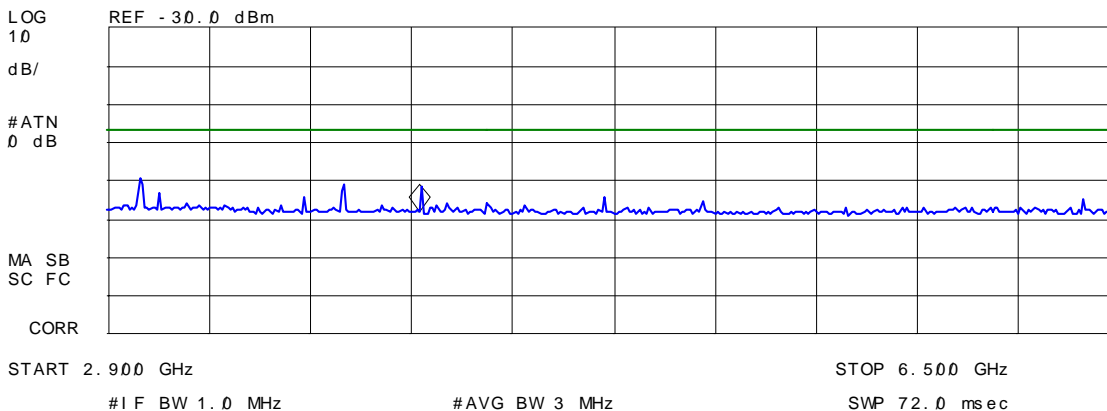

19:12:40 MAR 28, 2006

Signal Freq (MHz) PK Amp QP Amp AV Amp PK $\Delta$ L1

ACTV DET: PEAK  
 MEAS DET: PEAK QP AVG  
 MKR 8.049 GHz  
 -69.33 dBm

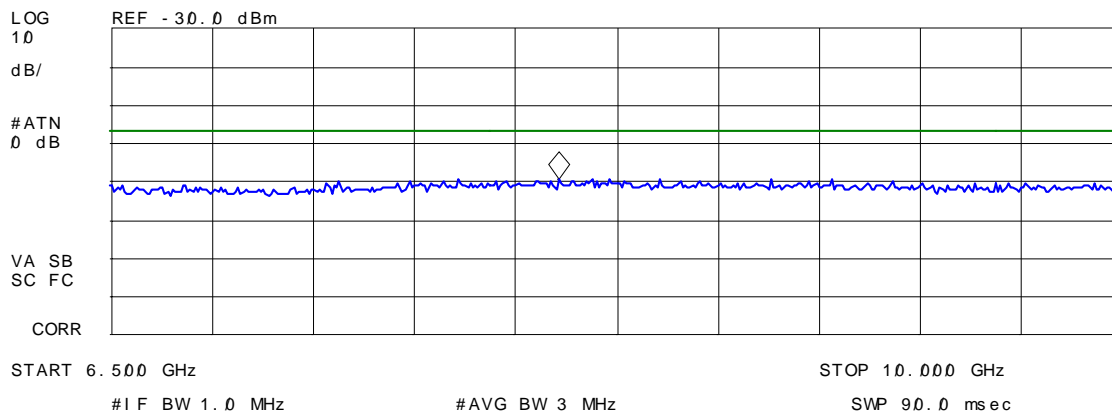

6.5.5.4. Plot # 6 – Receiver Conducted Emissions @ 3299.9999 MHz

The emissions were scanned from 30 MHz to 18 GHz and all emissions within 20 dB below the limits were recorded.

19:44:12 MAR 28, 2006

Signal	Freq (MHz)	PK Amp	QP Amp	AV Amp	PK $\Delta$ L1
1	1001.032750	-65.7	-67.6	-67.7	-8.7
2	1412.898875	-70.0	-74.3	-74.9	-13.0
3	2002.055934	-68.3	-71.9	-72.4	-11.3
4	2047.941493	-69.0	-75.1	-76.4	-12.0

ACTV DET: PEAK  
 MEAS DET: PEAK QP AVG  
 MKR 2.046 GHz  
 -77.02 dBm

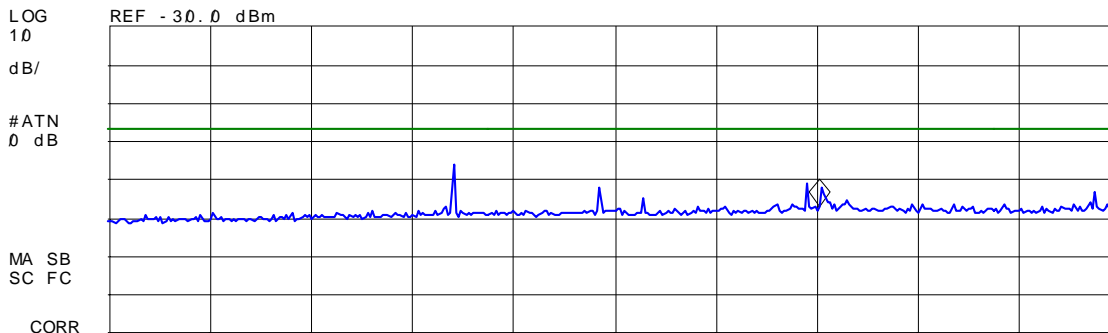

START 30 MHz STOP 2.900 GHz  
 #IF BW 1.0 MHz #AVG BW 3 MHz SWP 57.4 msec

19:49:04 MAR 28, 2006

Signal	Freq (MHz)	PK Amp	QP Amp	AV Amp	PK $\Delta$ L1
1	3002.950250	-70.2	-74.9	-75.9	-13.2
2	3584.448930	-72.0	-77.8	-79.3	-15.0
3	4004.049010	-68.1	-71.5	-72.0	-11.1
4	6187.495000	-69.6	-73.6	-74.3	-12.6

ACTV DET: PEAK  
 MEAS DET: PEAK QP AVG  
 MKR 6.185 GHz  
 -78.33 dBm

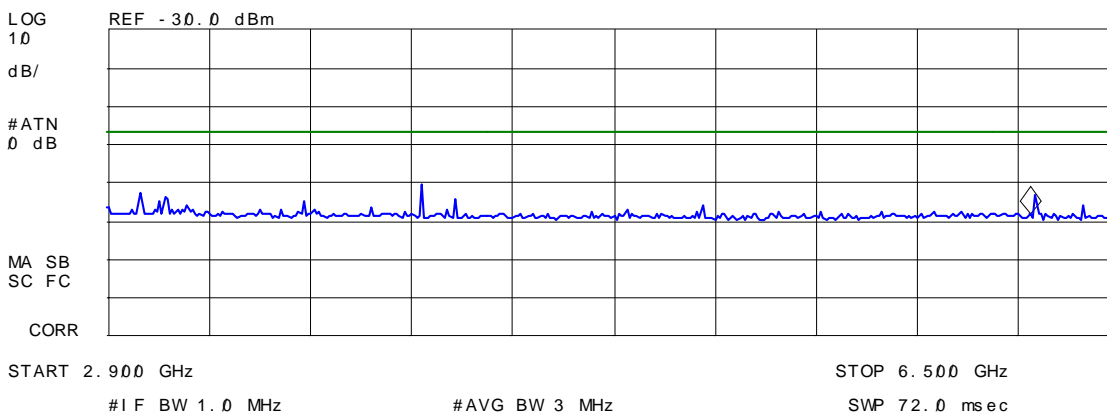



20:40:43 MAR 28, 2006

Signal Freq (MHz) PK Amp QP Amp AV Amp PK $\Delta$ L1

ACTV DET: PEAK  
 MEAS DET: PEAK QP AVG  
 MKR 11.975 GHz  
 -70.40 dBm

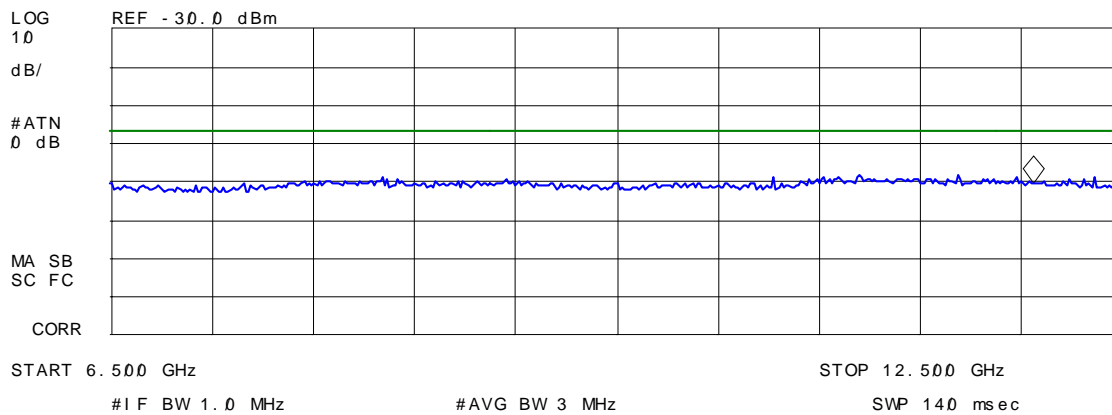

20:44:43 MAR 28, 2006

Signal Freq (MHz) PK Amp QP Amp AV Amp PK $\Delta$ L1

ACTV DET: PEAK  
 MEAS DET: PEAK QP AVG  
 MKR 16.150 GHz  
 -65.84 dBm

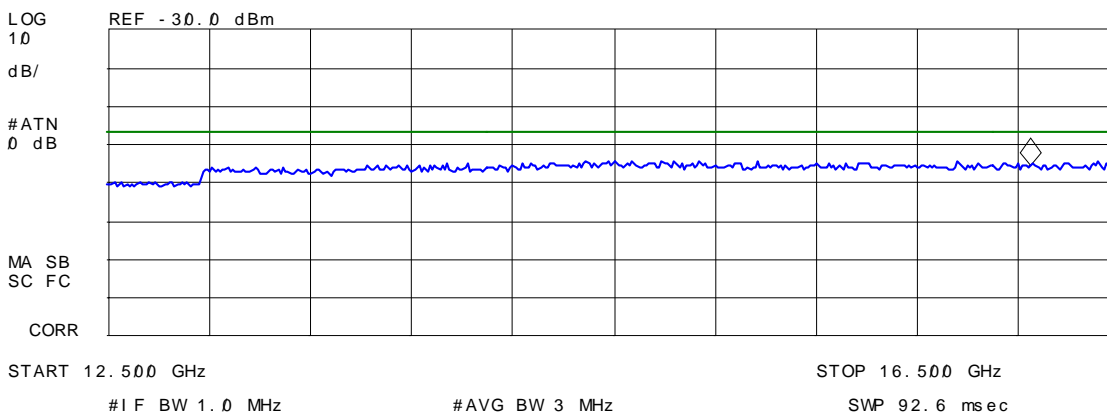

## 6.6. RECEIVER SPURIOUS/HARMONIC RADIATED EMISSIONS [§ 15.109(a)]

### 6.6.1. Limits

The equipment shall meet the limits of the following table:

Test Frequency Range (MHz)	Class B Limits @ 3 m (dB $\mu$ V/m)	EMI Detector Used	Measuring Bandwidth (kHz)
30 – 88	40.0	Quasi-Peak	RBW = 120 kHz, VBW $\geq$ 120 kHz
88 – 216	43.5	Quasi-Peak	RBW = 120 kHz, VBW $\geq$ 120 kHz
216 – 960	46.0	Quasi-Peak	RBW = 120 kHz, VBW $\geq$ 120 kHz
Above 960	54.0	Average	RBW = 1 MHz, VBW $\geq$ 1 Hz

### 6.6.2. Method of Measurements

Refer to Ultratech Test Procedures ULTR-P001-200 & ANSI C63.4 for method of measurements.

The spectrum shall be investigated from the lowest radio frequency signal generated or used in the device, without going below the lowest frequency for which a radiated emission limit is specified, up to the frequency shown in the following table:

Highest frequency generated or used in the device or on which the device operates or tunes (MHz)	Upper frequency of measurement range (MHz)
Below 1.705	30
1.705 - 108	1000
108 – 500	2000
500 -1000	5000
Above 1000	5 <sup>th</sup> harmonic of the highest frequency or 40 GHz, whichever is lower

### 6.6.3. Test Equipment List

Test Instruments	Manufacturer	Model No.	Serial No.	Frequency Range
Spectrum Analyzer/ EMI Receiver	Rohde & Schawrz	FSEK20/B4/B21	834157/005	9 kHz – 40 GHz with external mixer
Microwave Amplifier	Hewlett Packard	HP 83017A		1 GHz to 26.5 GHz
Biconilog Antenna	EMCO	3143	1029	20 MHz to 2 GHz
Horn Antenna	EMCO	3155	9701-5061	1 GHz – 18 GHz

### 6.6.4. Photos of test Setup

Please refer to Photos # 3 and 4 in Annex 1 for details of test setup

## 6.6.5. Test Data

### 6.6.5.1. Lowest Frequency (0.495 MHz)

The emissions were scanned from 30 MHz to 1.5 GHz and all emissions found were more than 20 dB below the limits.

### 6.6.5.2. Near Lowest Frequency (30 MHz)

The emissions were scanned from 30 MHz to 1.5 GHz and all emissions found were more than 20 dB below the limits.

### 6.6.5.3. Near Middle Frequency (1665 MHz)

The emissions were scanned from 30 MHz to 10 GHz and all emissions found were more than 20 dB below the limits.

### 6.6.5.4. Highest Frequency (3299.9999 MHz)

The emissions were scanned from 30 MHz to 18 GHz and all emissions found were more than 20 dB below the limits.

## 6.7. RADIATED EMISSIONS FROM CLASS B UNINTENTIONAL RADIATORS (DIGITAL DEVICES) [§ 15.109(a)]

### 6.7.1. Limits

The equipment shall meet the limits of the following table:

Test Frequency Range (MHz)	Class B Limits @3m (dB $\mu$ V/m)	EMI Detector Used	Measuring Bandwidth (kHz)
30 – 88	40.0	Quasi-Peak	RBW = 120 kHz, VBW $\geq$ 120 kHz
88 – 216	43.5	Quasi-Peak	RBW = 120 kHz, VBW $\geq$ 120 kHz
216 – 960	46.0	Quasi-Peak	RBW = 120 kHz, VBW $\geq$ 120 kHz
Above 960	54.0	Average	RBW = 1 MHz, VBW $\geq$ 1 Hz

### 6.7.2. Method of Measurements

Refer to Ultratech Test Procedures ULTR-P001-200 & ANSI C63.4 for method of measurements.

The spectrum shall be investigated from the lowest radio frequency signal generated or used in the device, without going below the lowest frequency for which a radiated emission limit is specified, up to the frequency shown in the following table:

Highest frequency generated or used in the device or on which the device operates or tunes (MHz)	Upper frequency of measurement range (MHz)
Below 1.705	30
1.705 - 108	1000
108 – 500	2000
500 -1000	5000
Above 1000	5 <sup>th</sup> harmonic of the highest frequency or 40 GHz, whichever is lower

### 6.7.3. Test Equipment List

Test Instruments	Manufacturer	Model No.	Serial No.	Frequency Range
Spectrum Analyzer/ EMI Receiver	Rohde & Schawrz	FSEK20/B4/B21	834157/005	9 kHz – 40 GHz with external mixer
Microwave Amplifier	Hewlett Packard	HP 83017A		1 GHz to 26.5 GHz
Biconilog Antenna	EMCO	3143	1029	20 MHz to 2 GHz
Horn Antenna	EMCO	3155	9701-5061	1 GHz – 18 GHz

### 6.7.4. Photos of test Setup

Please refer to Photos # 3 and 4 in Annex 1 for details of test setup.

### 6.7.5. Test Data

The emissions were scanned from 30 MHz to 1000 MHz at 3 Meters distance and all emissions found were more than 20 dB below the limits.

## 6.8. REQUIREMENTS FOR SCANNING RECEIVERS [47 CFR 15.121]

### 6.8.1. FCC Rules

- a. Except as provided in paragraph (c) of this section, scanning receivers and frequency converters designed or marketed for use with scanning receivers, shall:
  - (1) Be incapable of operating (tuning), or readily being altered by the user to operate, within the frequency bands allocated to the Cellular Radiotelephone Service in part 22 of this chapter (cellular telephone bands). Scanning receivers capable of "readily being altered by the user" include, but are not limited to, those for which the ability to receive transmissions in the cellular telephone bands can be added by clipping the leads of, or installing, a simple component such as a diode, resistor or jumper wire; replacing a plug-in semiconductor chip; or programming a semiconductor chip using special access codes or an external device, such as a personal computer. Scanning receivers, and frequency converters designed for use with scanning receivers, also shall be incapable of converting digital cellular communication transmissions to analog voice audio.
  - (2) Be designed so that the tuning, control and filtering circuitry is inaccessible. The design must be such that any attempts to modify the equipment to receive transmissions from the Cellular Radiotelephone Service likely will render the receiver inoperable.
- b. Except as provided in paragraph (c) of this section, scanning receivers shall reject any signals from the Cellular Radiotelephone Service frequency bands that are 38 dB or lower based upon a 12 dB SINAD measurement, which is considered the threshold where a signal can be clearly discerned from any interference that may be present.
- c. **Scanning receivers and frequency converters designed or marketed for use with scanning receivers, are not subject to the requirements of paragraphs (a) and (b) of this section provided that they are manufactured exclusively for, and marketed exclusively to, entities described in 18 U.S.C. 2512(2), or are marketed exclusively as test equipment pursuant to Sec. 15.3(dd)**
- d. Modification of a scanning receiver to receive transmissions from Cellular Radiotelephone Service frequency bands will be considered to constitute manufacture of such equipment. This includes any individual, individuals, entity or organization that modifies one or more scanners. Any modification to a scanning receiver to receive transmissions from the Cellular Radiotelephone Service frequency bands voids the certification of the scanning receiver, regardless of the date of manufacture of the original unit. In addition, the provisions of Sec. 15.23 shall not be interpreted as permitting modification of a scanning receiver to receive Cellular Radiotelephone Service transmissions.
- e. Scanning receivers and frequency converters designed for use with scanning receivers shall not be assembled from kits or marketed in kit form unless they comply with the requirements in paragraph (a) through (c) of this section.



- f. Scanning receivers shall have a label permanently affixed to the product, and this label shall be readily visible to the purchaser at the time of purchase. The label shall read as follows: WARNING:  
MODIFICATION OF THIS DEVICE TO RECEIVE CELLULAR RADIOTELEPHONE SERVICE SIGNALS  
IS PROHIBITED UNDER FCC RULES AND FEDERAL LAW.
- (1) ``Permanently affixed" means that the label is etched, engraved, stamped, silkscreened, indelible printed or otherwise permanently marked on a permanently attached part of the equipment or on a nameplate of metal, plastic or other material fastened to the equipment by welding, riveting, or permanent adhesive. The label shall be designed to last the expected lifetime of the equipment in the environment in which the equipment may be operated and must not be readily detachable. The label shall not be a stick-on, paper label.
  - (2) When the device is so small that it is not practicable to place the warning label on it, the information required by this paragraph shall be placed in a prominent location in the instruction manual or pamphlet supplied to the user and shall also be placed on the container in which the device is marketed. However, the FCC identifier must be displayed on the device.

### 6.8.2. Declaration for Compliance with FCC §15.121

- FCC §121(a)(1) – Not applicable.
- FCC §121(a)(2) – Not applicable.
- FCC §121(b) – Not applicable.
- Comply with FCC §121(c) – Please refer to manufacturer's declaration letter for compliance with this Rule.
- Comply with FCC §121(d) – Not applicable.
- Comply with FCC §121(e) – This Scanning Receiver will not be assembled from kits or marketed in kit form.
- Comply with FCC §121(f) – Not applicable.

## EXHIBIT 7. MEASUREMENT UNCERTAINTY

The measurement uncertainties stated were calculated in accordance with the requirements of NIST Technical Note 1297 and LAB 34

### 7.1. LINE CONDUCTED EMISSION MEASUREMENT UNCERTAINTY

CONTRIBUTION (Line Conducted)	PROBABILITY DISTRIBUTION	UNCERTAINTY (dB)	
		9-150 kHz	0.15-30 MHz
EMI Receiver specification	Rectangular	$\pm 1.5$	$\pm 1.5$
LISN coupling specification	Rectangular	$\pm 1.5$	$\pm 1.5$
Cable and Input Transient Limiter calibration	Normal (k=2)	$\pm 0.3$	$\pm 0.5$
Mismatch: Receiver VRC $\Gamma_1 = 0.03$ LISN VRC $\Gamma_R = 0.8(9 \text{ kHz}) 0.2 (30 \text{ MHz})$ Uncertainty limits $20\text{Log}(1+\Gamma_1\Gamma_R)$	U-Shaped	$\pm 0.2$	$\pm 0.3$
System repeatability	Std. deviation	$\pm 0.2$	$\pm 0.05$
Repeatability of EUT	--	--	--
Combined standard uncertainty	Normal	$\pm 1.25$	$\pm 1.30$
Expanded uncertainty U	Normal (k=2)	$\pm 2.50$	$\pm 2.60$

Sample Calculation for Measurement Accuracy in 150 kHz to 30 MHz Band:

$$u_c(y) = \sqrt{\sum_{i=1}^m u_i^2(y)} = \pm \sqrt{(1.5^2 + 1.5^2)/3 + (0.5/2)^2 + (0.05/2)^2 + 0.35^2} = \pm 1.30 \text{ dB}$$

$$U = 2u_c(y) = \pm 2.6 \text{ dB}$$

## 7.2. RADIATED EMISSION MEASUREMENT UNCERTAINTY

CONTRIBUTION (Radiated Emissions)	PROBABILITY DISTRIBUTION	UNCERTAINTY ( $\pm$ dB)	
		3 m	10 m
Antenna Factor Calibration	Normal (k=2)	$\pm 1.0$	$\pm 1.0$
Cable Loss Calibration	Normal (k=2)	$\pm 0.3$	$\pm 0.5$
EMI Receiver specification	Rectangular	$\pm 1.5$	$\pm 1.5$
Antenna Directivity	Rectangular	$+0.5$	$+0.5$
Antenna factor variation with height	Rectangular	$\pm 2.0$	$\pm 0.5$
Antenna phase center variation	Rectangular	0.0	$\pm 0.2$
Antenna factor frequency interpolation	Rectangular	$\pm 0.25$	$\pm 0.25$
Measurement distance variation	Rectangular	$\pm 0.6$	$\pm 0.4$
Site imperfections	Rectangular	$\pm 2.0$	$\pm 2.0$
Mismatch: Receiver VRC $\Gamma_1 = 0.2$ Antenna VRC $\Gamma_R = 0.67(\text{Bi}) 0.3 (\text{Lp})$ Uncertainty limits $20\text{Log}(1 \pm \Gamma_1 \Gamma_R)$	U-Shaped	+1.1 -1.25	$\pm 0.5$
System repeatability	Std. Deviation	$\pm 0.5$	$\pm 0.5$
Repeatability of EUT		-	-
Combined standard uncertainty	Normal	+2.19 / -2.21	+1.74 / -1.72
Expanded uncertainty U	Normal (k=2)	+4.38 / -4.42	+3.48 / -3.44

Calculation for maximum uncertainty when 3m biconical antenna including a factor of k = 2 is used:

$$U = 2u_c(y) = 2x(+2.19) = +4.38 \text{ dB} \quad \text{And} \quad U = 2u_c(y) = 2x(-2.21) = -4.42 \text{ Db}$$