

ENGINEERING TEST REPORT

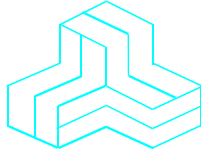

UHF Transceiver
Model No.: IC-F80DT/DS/T/S
FCC ID: AFJ280402

Applicant:

ICOM Incorporated
1-1-32, Kamiminami, Hirano-ku
Osaka
Japan, 547-0003

Tested in Accordance With

Federal Communications Commission (FCC)
47 CFR, PARTS 2 and 90 (Subpart I)

UltraTech's File No.: ICOM-104F90

This Test report is Issued under the Authority of
Tri M. Luu, Professional Engineer,
Vice President of Engineering
UltraTech Group of Labs

Date: December 15, 2004



Report Prepared by: Dan Huynh

Tested by: Wayne Wu, RFI/EMI Technician

Issued Date: December 15, 2004

Test Dates: November 15 - 29, 2004

- *The results in this Test Report apply only to the sample(s) tested, and the sample tested is randomly selected.*
- *This report must not be used by the client to claim product endorsement by NVLAP or any agency of the US Government.*

UltraTech

3000 Bristol Circle, Oakville, Ontario, Canada, L6H 6G4
Tel.: (905) 829-1570 Fax.: (905) 829-8050

Website: www.ultratech-labs.com, Email: vic@ultratech-labs.com, Email: tri@ultratech-labs.com



TABLE OF CONTENTS

EXHIBIT 1.	SUBMITTAL CHECK LIST	1
EXHIBIT 2.	INTRODUCTION.....	2
2.1.	SCOPE	2
2.2.	RELATED SUBMITTAL(S)/GRANT(S)	2
2.3.	NORMATIVE REFERENCES	2
EXHIBIT 3.	PERFORMANCE ASSESSMENT	3
3.1.	CLIENT INFORMATION.....	3
3.2.	EQUIPMENT UNDER TEST (EUT) INFORMATION.....	3
3.3.	EUT'S TECHNICAL SPECIFICATIONS.....	4
3.4.	LIST OF EUT'S PORTS.....	5
EXHIBIT 4.	EUT OPERATING CONDITIONS AND CONFIGURATIONS DURING TESTS	6
4.1.	CLIMATE TEST CONDITIONS	6
4.2.	OPERATIONAL TEST CONDITIONS & ARRANGEMENT FOR TEST SIGNALS	6
EXHIBIT 5.	SUMMARY OF TEST RESULTS.....	7
5.1.	LOCATION OF TESTS.....	7
5.2.	APPLICABILITY & SUMMARY OF EMISSION TEST RESULTS	7
5.3.	MODIFICATIONS INCORPORATED IN THE EUT FOR COMPLIANCE PURPOSES.....	7
5.4.	DEVIATION OF STANDARD TEST PROCEDURES	7
EXHIBIT 6.	MEASUREMENTS, EXAMINATIONS & TEST DATA FOR EMC EMISSIONS.....	8
6.1.	TEST PROCEDURES	8
6.2.	MEASUREMENT UNCERTAINTIES	8
6.3.	MEASUREMENT EQUIPMENT USED	8
6.4.	ESSENTIAL/PRIMARY FUNCTIONS AS DECLARED BY THE MANUFACTURER	8
6.5.	RF POWER OUTPUT [§§ 2.1046 & 90.205].....	9
6.6.	FREQUENCY STABILITY [§§ 2.1055 & 90.213].....	10
6.7.	AUDIO FREQUENCY RESPONSE [§ 2.1047(a)]	13
6.8.	MODULATION LIMITING [§§ 2.1047(b) & 90.210].....	18
6.9.	EMISSION MASK [§§ 2.1049, 90.209 & 90.210].....	23
6.10.	TRANSMITTER ANTENNA POWER SPURIOUS/HARMONIC CONDUCTED EMISSIONS [§ 90.210].....	125
6.11.	TRANSMITTER SPURIOUS/HARMONIC RADIATED EMISSIONS [§ 90.210].....	138
6.12.	TRANSIENT FREQUENCY BEHAVIOR [§ 90.214].....	140
EXHIBIT 7.	MEASUREMENT UNCERTAINTY	146
7.1.	RADIATED EMISSION MEASUREMENT UNCERTAINTY.....	146
EXHIBIT 8.	MEASUREMENT METHODS	147
8.1.	CONDUCTED POWER MEASUREMENTS	147
8.2.	RADIATED POWER MEASUREMENTS (ERP & EIRP) USING SUBSTITUTION METHOD.....	148
8.3.	FREQUENCY STABILITY	151
8.4.	EMISSION MASK	152
8.5.	SPURIOUS EMISSIONS (CONDUCTED).....	152
8.6.	TRANSIENT FREQUENCY BEHAVIOR	153

EXHIBIT 1. SUBMITTAL CHECK LIST

Annex No.	Exhibit Type	Description of Contents	Quality Check (OK)
--	Test Report	<ul style="list-style-type: none"> ▪ Exhibit 1: Submittal check lists ▪ Exhibit 2: Introduction ▪ Exhibit 3: Performance Assessment ▪ Exhibit 4: EUT Operation and Configuration during Tests ▪ Exhibit 5: Summary of test Results ▪ Exhibit 6: Measurement Data ▪ Exhibit 7: Measurement Uncertainty ▪ Exhibit 8: Measurement Methods 	OK
1	Test Setup Photos	Radiated Emissions Test Setup Photos	OK
2	External Photos of EUT	External EUT Photos	OK
3	Internal Photos of EUT	Internal EUT Photos	OK
4	Cover Letters	Cover Letter	OK
5	Attestation Statements	<ul style="list-style-type: none"> ▪ Letter from the Applicant to appoint Ultratech to act as an agent ▪ Letter from the Applicant to request for Confidentiality Filing ▪ Applicant Part 90 Attestation 	OK
6	ID Label/Location Info	<ul style="list-style-type: none"> ▪ ID Label ▪ Location of ID Label 	OK
7	Block Diagrams	Block Diagram	OK
8	Schematic Diagrams	Schematics	OK
9	Parts List/Tune Up Info	<ul style="list-style-type: none"> ▪ Parts List ▪ Adjustment for IC-F80DT/DS/T/S 	OK
10	Operational Description	Circuit Description	OK
11	RF Exposure Info	See SAR Test Report for Details.	OK
12	Users Manual	Instruction Manual	OK

ULTRATECH GROUP OF LABS

3000 Bristol Circle, Oakville, Ontario, Canada L6H 6G4
 Tel. #: 905-829-1570, Fax. #: 905-829-8050, Email: vic@ultratech-labs.com, Website: <http://www.ultratech-labs.com>

File #: ICOM-104F90
 December 15, 2004

All test results contained in this engineering test report are traceable to National Institute of Standards and Technology (NIST)

EXHIBIT 2. INTRODUCTION

2.1. SCOPE

Reference:	FCC Parts 2 and 90
Title:	Code of Federal Regulations (CFR), Title 47 Telecommunication – Parts 2 & 90
Purpose of Test:	To gain FCC Certification Authorization for Radio operating in the Frequency Band 450-520 MHz (12.5 kHz and 25 kHz Channel Spacings).
Test Procedures:	Both conducted and radiated emissions measurements were conducted in accordance with American National Standards Institute ANSI C63.4 - American National Standard for Methods of Measurement of Radio-Noise Emissions from Low-Voltage Electrical and Electronic Equipment in the Range of 9 kHz to 40 GHz.

2.2. RELATED SUBMITTAL(S)/GRANT(S)

None.

2.3. NORMATIVE REFERENCES

Publication	Year	Title
FCC CFR Parts 0-19, 80-End	2003	Code of Federal Regulations – Telecommunication
ANSI C63.4	2003	American National Standard for Methods of Measurement of Radio-Noise Emissions from Low-Voltage Electrical and Electronic Equipment in the Range of 9 kHz to 40 GHz
CISPR 22 & EN 55022	2003 2003	Limits and Methods of Measurements of Radio Disturbance Characteristics of Information Technology Equipment
CISPR 16-1	2003	Specification for Radio Disturbance and Immunity measuring apparatus and methods
TIA-603-B	2002	Land Mobile FM or Pm Communications Equipment, Measurement and Performance Standards.

EXHIBIT 3. PERFORMANCE ASSESSMENT

3.1. CLIENT INFORMATION

APPLICANT	
Name:	Icom Incorporated
Address:	1-1-32 kamiminami Hirano-ku Osaka 547-0003 Japan
Contact Person:	Mr. Takashi Aoki Phone #: +81-66-793-5302 Fax #: +81-66-793-0013 Email Address: export@icom.co.jp

MANUFACTURER	
Name:	Icom Incorporated
Address:	1-1-32 kamiminami Hirano-ku Osaka 547-0003 Japan
Contact Person:	Mr. Takashi Aoki Phone #: +81-66-793-5302 Fax #: +81-66-793-0013 Email Address: export@icom.co.jp

3.2. EQUIPMENT UNDER TEST (EUT) INFORMATION

The following information (with the exception of the Date of Receipt) has been supplied by the applicant.

Brand Name:	ICOM Incorporated
Product Name:	UHF Transceiver
Model Name or Number:	IC-F80DT/DS/T/S
Serial Number:	Test Sample
Type of Equipment:	Licensed Non-broadcast Radio Communication Equipment
External Power Supply:	7.2 V DC nominal
Transmitting/Receiving Antenna Type:	Non-integral
Primary User Functions of EUT:	UHF portable transceiver for voice communication in occupational environment.

ULTRATECH GROUP OF LABS

3000 Bristol Circle, Oakville, Ontario, Canada L6H 6G4
Tel. #: 905-829-1570, Fax. #: 905-829-8050, Email: vic@ultratech-labs.com, Website: <http://www.ultratech-labs.com>

File #: ICOM-104F90
December 15, 2004

All test results contained in this engineering test report are traceable to National Institute of Standards and Technology (NIST)

3.3. EUT'S TECHNICAL SPECIFICATIONS

TRANSMITTER	
Equipment Type:	Portable
Intended Operating Environment:	Commercial, Light Industry & Heavy Industry
Power Supply Requirement:	7.2 V DC nominal
RF Output Power Rating:	4 W, 2 W and 1 W
Operating Frequency Range:	450-520 MHz
RF Output Impedance:	50 Ohms nominal
Channel Spacing:	12.5 kHz and 25 kHz
Occupied Bandwidth (99%):	<ul style="list-style-type: none"> ▪ 7.37 kHz (Digital: C4-FM (CQPSK)) ▪ 6.43 kHz (for 12.5 kHz Channel Spacing) ▪ 10.91 kHz (for 25 kHz Channel Spacing)
Emission Designation*:	8K10F1D, 8K10F3E, 11K0F3E, 16K0F3E
Antenna Connector Type:	J Type Connector
Antenna Description:	<p>There are three antennas to be used with this device.</p> <p>Antenna 1 Description: Manufacturer: ICOM Inc. Type: Flexible long helical antenna Model: FA-SC57U Frequency Range: 440–470 MHz Gain: -3.0 dBi</p> <p>Antenna 2 Description: Manufacturer: ICOM Inc. Type: Flexible long helical antenna Model: FA-SC72U Frequency Range: 470–520 MHz Gain: -1.9 dBi</p> <p>Antenna 3 Description: Manufacturer: ICOM Inc. Type: Stubby helical antenna Model: FA-SC73US Frequency Range: 450–490 MHz Gain: -10.4dBi</p>

* For an average case of commercial telephony, the Necessary Bandwidth is calculated as follows:

For FM Voice Modulation:

Channel Spacing = 12.5 KHz, D = 2.5 KHz max., K = 1, M = 3 KHz

$$B_n = 2M + 2DK = 2(3) + 2(2.5)(1) = \underline{11 \text{ KHz}}$$

Emission designation: 11K0F3E

Channel Spacing = 25 KHz, D = 5 KHz max., K = 1, M = 3 KHz

$$B_n = 2M + 2DK = 2(3) + 2(5)(1) = \underline{16 \text{ KHz}}$$

Emission designation: 16K0F3E

3.4. LIST OF EUT'S PORTS

Port Number	EUT's Port Description	Number of Identical Ports	Connector Type	Cable Type (Shielded/Non-shielded)
1	Antenna	1	J Type	N/A
2	Speaker-Microphone Connector	1	9-pin Connector	Shielded

EXHIBIT 4. EUT OPERATING CONDITIONS AND CONFIGURATIONS DURING TESTS

4.1. CLIMATE TEST CONDITIONS

The climate conditions of the test environment are as follows:

Temperature:	21°C
Humidity:	51%
Pressure:	102 kPa
Power Input Source:	7.2 V DC

4.2. OPERATIONAL TEST CONDITIONS & ARRANGEMENT FOR TEST SIGNALS

Operating Modes:	The transmitter was operated in a continuous transmission mode with the carrier modulated as specified in the Test Data.
Special Test Software:	N/A
Special Hardware Used:	N/A
Transmitter Test Antenna:	The EUT is tested with the transmitter antenna port terminated to a 50 Ohms RF Load.

Transmitter Test Signals	
Frequency Band(s):	450-520 MHz
Test Frequency(ies): (Near lowest, near middle & near highest frequencies in the frequency range of operation.)	450.05, 485.05 and 519.95 MHz
Transmitter Wanted Output Test Signals:	
Transmitter Power (measured maximum output power):	4 W (High), 2 W (Middle) & 1 W (Low)
Normal Test Modulation:	FM Voice and C4-FM (CQPSK)
Modulating signal source:	External

EXHIBIT 5. SUMMARY OF TEST RESULTS

5.1. LOCATION OF TESTS

All of the measurements described in this report were performed at Ultratech Group of Labs located in the city of Oakville, Province of Ontario, Canada.

Radiated Emissions were performed at the Ultratech's 3 Meter Open Field Test Site (OFTS) situated in the Town of Oakville, province of Ontario.

The above sites have been calibrated in accordance with ANSI C63.4, and found to be in compliance with the requirements of Sec. 2.948 of the FCC Rules. The descriptions and site measurement data of the Oakville Open Field Test Site has been filed with FCC office (FCC File No.: 31040/SIT 1300B3) and Industry Canada office (Industry Canada File No.: IC2049). Last Date of Site Calibration: February 17, 2004.

5.2. APPLICABILITY & SUMMARY OF EMISSION TEST RESULTS

FCC Section(s)	Test Requirements	Applicability Yes/No)
90.205 & 2.1046	RF Power Output	Yes
1.1307, 1.1310, 2.1091 & 2.1093	RF Exposure Limit	Yes
90.213 & 2.1055	Frequency Stability	Yes
90.242(b)(8) & 2.1047(a)	Audio Frequency Response	Not applicable to current standard. However, tests are conducted under FCC's recommendation.
90.210 & 2.1047(b)	Modulation Limiting	Yes
90.210 & 2.1049	Emission Limitation & Emission Mask	Yes
90.210, 2.1057 & 2.1051	Emission Limits - Spurious Emissions at Antenna Terminal	Yes
90.210, 2.1057 & 2.1053	Emission Limits - Field Strength of Spurious Emissions	Yes
90.214	Transient Frequency Behavior	Yes

UHF Transceiver, Model No.: IC-F80DT/DS/T/S, by **ICOM Incorporated** has also been tested and found to comply with **FCC Part 15, Subpart B - Radio Receivers and Class B Digital Devices**. The engineering test report has been documented and kept on file and it is available upon request.

5.3. MODIFICATIONS INCORPORATED IN THE EUT FOR COMPLIANCE PURPOSES

None.

5.4. DEVIATION OF STANDARD TEST PROCEDURES

None.

ULTRATECH GROUP OF LABS

3000 Bristol Circle, Oakville, Ontario, Canada L6H 6G4
Tel. #: 905-829-1570, Fax. #: 905-829-8050, Email: vic@ultratech-labs.com, Website: <http://www.ultratech-labs.com>

File #: ICOM-104F90
December 15, 2004

All test results contained in this engineering test report are traceable to National Institute of Standards and Technology (NIST)

EXHIBIT 6. MEASUREMENTS, EXAMINATIONS & TEST DATA FOR EMC EMISSIONS

6.1. TEST PROCEDURES

This section contains test results only. Details of test methods and procedures can be found in Exhibit 8 of this report

6.2. MEASUREMENT UNCERTAINTIES

The measurement uncertainties stated were calculated in accordance with requirements of UKAS Document NIS 81 with a confidence level of 95%. Please refer to Exhibit 7 for Measurement Uncertainties.

6.3. MEASUREMENT EQUIPMENT USED

The measurement equipment used complied with the requirements of the Standards referenced in the Methods & Procedures ANSI C63.4 and CISPR 16-1.

6.4. ESSENTIAL/PRIMARY FUNCTIONS AS DECLARED BY THE MANUFACTURER

The essential function of the EUT is to correctly communicate data to and from radios over RF link.

6.5. RF POWER OUTPUT [§§ 2.1046 & 90.205]

6.5.1. Limits

Please refer to FCC 47 CFR 90.205 for specification details.

6.5.2. Method of Measurements

Refer to Exhibit 8, Section 8.1 (Conducted) and 8.2 (Radiated) of this report for measurement details

6.5.3. Test Equipment List

Test Instruments	Manufacturer	Model No.	Serial No.	Frequency Range
Attenuator	Weinschel Corp	23-20-34	BH7876	DC – 18 GHz
Power Meter	Hewlett Packard	436A	1725A02249	10 kHz – 50 GHz, sensor dependent
Power Sensor	Hewlett Packard	8481A	2702A68983	10 MHz – 18 GHz

6.5.4. Test Arrangement

Power at RF Power Output Terminals:

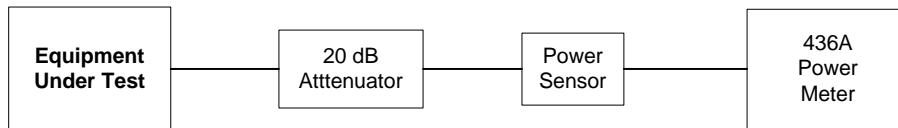

6.5.5. Test Data

Fundamental Frequency (MHz)	Measured (Average) Power (dBm)	Power Rating (dBm)
High Power		
450.05	36.00	36
485.05	35.91	36
519.95	36.13	36
Middle Power		
450.05	33.06	33
485.05	32.93	33
519.95	33.18	33
Low Power		
450.05	29.97	30
485.05	29.69	30
519.95	30.03	30

ULTRATECH GROUP OF LABS

3000 Bristol Circle, Oakville, Ontario, Canada L6H 6G4
 Tel. #: 905-829-1570, Fax. #: 905-829-8050, Email: vic@ultratech-labs.com, Website: <http://www.ultratech-labs.com>

File #: ICOM-104F90
 December 15, 2004

All test results contained in this engineering test report are traceable to National Institute of Standards and Technology (NIST)

6.6. FREQUENCY STABILITY [§§ 2.1055 & 90.213]

6.6.1. Limits

Refer to FCC 47 CFR 90.213 for specification details.

Frequency Range (MHz)	Channel Bandwidth (kHz)	Frequency Tolerance (ppm)		
		Fixed and Base Stations	Mobile Stations	
			> 2 W	≤ 2 W
421–512 MHz	12.5	1.5	2.5	2.5
	25	2.5	5.0	5.0

6.6.2. Method of Measurements

Refer to Exhibit 8, Section 8.3 of this report for measurement details

6.6.3. Test Equipment List

Test Instruments	Manufacturer	Model No.	Serial No.	Frequency Range
Frequency Counter	EIP	545A	2683	10Hz-18GHz
Attenuator	Weinschel Corp	23-20-34	BH7876	DC – 18 GHz
Temperature & Humidity Chamber	Tenney	T5	9723B	-40° to +60° C range

6.6.4. Test Arrangement

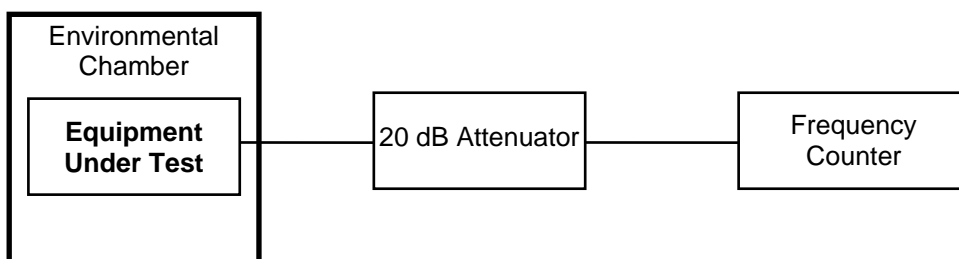

6.6.5. Test Data

Product Name:	UHF Transceiver
Model No.:	IC-F80DT/DS/T/S
Center Frequency:	450.05 MHz
Full Power Level:	4 Watts
Frequency Tolerance Limit:	± 2.5 ppm or ± 1000.125 Hz (Manufacturer's rating is 2.0 ppm)
Max. Frequency Tolerance Measured:	-239 Hz or 0.53 ppm
Input Voltage Rating:	7.2 V DC

Ambient Temperature (°C)	CENTER FREQUENCY & RF POWER OUTPUT VARIATION		
	Supply Voltage (Nominal) 7.2 Volts dc	Supply Voltage (85% of Nominal) 6.4 Volts	Supply Voltage (115% of Nominal) 8.3 Volts dc
	Hz	Hz	Hz
-30	-132	N/A	N/A
-20	-80	N/A	N/A
-10	-135	N/A	N/A
0	-63	N/A	N/A
+10	-42	N/A	N/A
+20	+61	-4	+146
+30	+165	N/A	N/A
+40	+217	N/A	N/A
+50	+222	N/A	N/A
+60	+239	N/A	N/A

6.6.5.1. **RF Output Power versus Input Voltage at Room Temperature**

Input Voltage (Vdc)	Input Current (A)	RF Output Power (dBm)
8.5	2.180	36.07
8.4	2.180	36.05
8.2	2.200	36.03
8.0	2.200	36.03
7.8	2.230	36.01
7.6	2.250	36.01
7.4	2.270	35.99
7.2	2.290	35.99
7.1	1.028	29.55
7.0	1.028	29.54
6.8	1.024	29.53
6.6	1.024	29.50
6.4	1.022	29.48
6.2	1.027	29.41
6.0	1.025	29.39
5.8	1.029	29.32
5.6	1.039	29.31
5.5	1.037	29.31
5.4	*	*

* Device shuts down.

6.7. AUDIO FREQUENCY RESPONSE [§ 2.1047(a)]

6.7.1. Limits

Recommended audio filter attenuation characteristics are given below:

RF Band	Audio band	Minimum Attenuation Rel. to 1 kHz Attenuation
406.1 - 960 MHz	3 –20 kHz Above 20 kHz	$60 \log_{10}(f/3)$ dB where f is in kHz 50dB

6.7.2. Method of Measurements

The rated audio input signal was applied to the input of the audio lowpass filter (or of all modulation stages) using an audio oscillator, this input signal level and its corresponding output signal were then measured and recorded using the FFT (Audio) EMI Receiver. Tests were repeated at different audio signal frequencies from 0 to 50 kHz.

6.7.3. Test Equipment List

Test Instruments	Manufacturer	Model No.	Serial No.	Frequency Range
FFT (audio) EMI Receiver	Advantest	R9211E	82020336	10 mHz – 100 kHz, 1 MHz Input Impedance
Radio Communication	Marconi	2955	132037/226	20Hz – 20 kHz
Modulation Analyzer	Hewlett Packard	8901B	3226A04606	150 kHz – 1300 MHz
Attenuator(s)	Weinschel Corp	23-20-34	BH7876	DC – 18 GHz
Digital Multimeter	Rohde & Schwarz	UDS-5	8729841067	DC – 100kHz
Power Supply	Tenna	72-6153	--	--

6.7.4. Test Arrangement

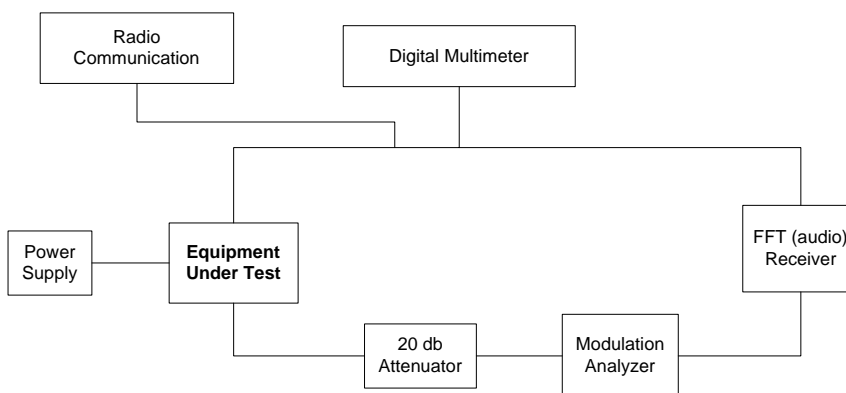

6.7.5. Test Data

6.7.5.1. 12.5 kHz Channel Spacing, F3E, Frequency of All Modulation States*

Note: Due to the difficulty of measuring the Frequency Response of the internal low-pass filter, the Frequency Response of All Modulation States was performed to show the roll-off at 3 kHz in comparison with recommended attenuation for audio low-pass filter.

Frequency (kHz)	Audio IN (dBV)	Audio OUT (dBV)	Attenuation (OUT - IN) (dB)	Attenuation wrt. 1 kHz (dB)	Recommended Attenuation (dB)
0.1	-36.48	<-85.00	<-48.5	<-85.4	--
0.2	-36.48	<-85.00	<-48.5	<-85.4	--
0.4	-36.48	-6.85	29.6	-7.2	--
0.6	-36.48	-3.72	32.8	-4.1	--
0.8	-36.48	-1.43	35.1	-1.8	--
1.0	-36.48	0.36	36.8	0.0	--
1.5	-36.48	1.59	38.1	1.2	--
2.0	-36.48	1.67	38.2	1.3	--
2.5	-36.48	0.83	37.3	0.5	--
3.0	-36.48	-2.34	34.1	-2.7	0
3.5	-36.48	-7.46	29.0	-7.8	-4
4.0	-36.48	-13.08	23.4	-13.4	-7
4.5	-36.48	-18.47	18.0	-18.8	-11
5.0	-36.48	-23.31	13.2	-23.7	-13
6.0	-36.48	-32.31	4.2	-32.7	-18
7.0	-36.48	-39.76	-3.3	-40.1	-22
8.0	-36.48	-48.50	-12.0	-48.9	-26
9.0	-36.48	-58.30	-21.8	-58.7	-29
10.0	-36.48	<-85.00	-48.5	-85.4	-31
12.0	-36.48	<-85.00	<-48.5	<-85.4	-36
14.0	-36.48	<-85.00	<-48.5	<-85.4	-40
15.0	-36.48	<-85.00	<-48.5	<-85.4	-42
18.0	-36.48	<-85.00	<-48.5	<-85.4	-47
20.0	-36.48	<-85.00	<-48.5	<-85.4	-50
25.0	-36.48	<-85.00	<-48.5	<-85.4	-50
30.0	-36.48	<-85.00	<-48.5	<-85.4	-50
35.0	-36.48	<-85.00	<-48.5	<-85.4	-50
40.0	-36.48	<-85.00	<-48.5	<-85.4	-50
45.0	-36.48	<-85.00	<-48.5	<-85.4	-50
50.0	-36.48	<-85.00	<-48.5	<-85.4	-50

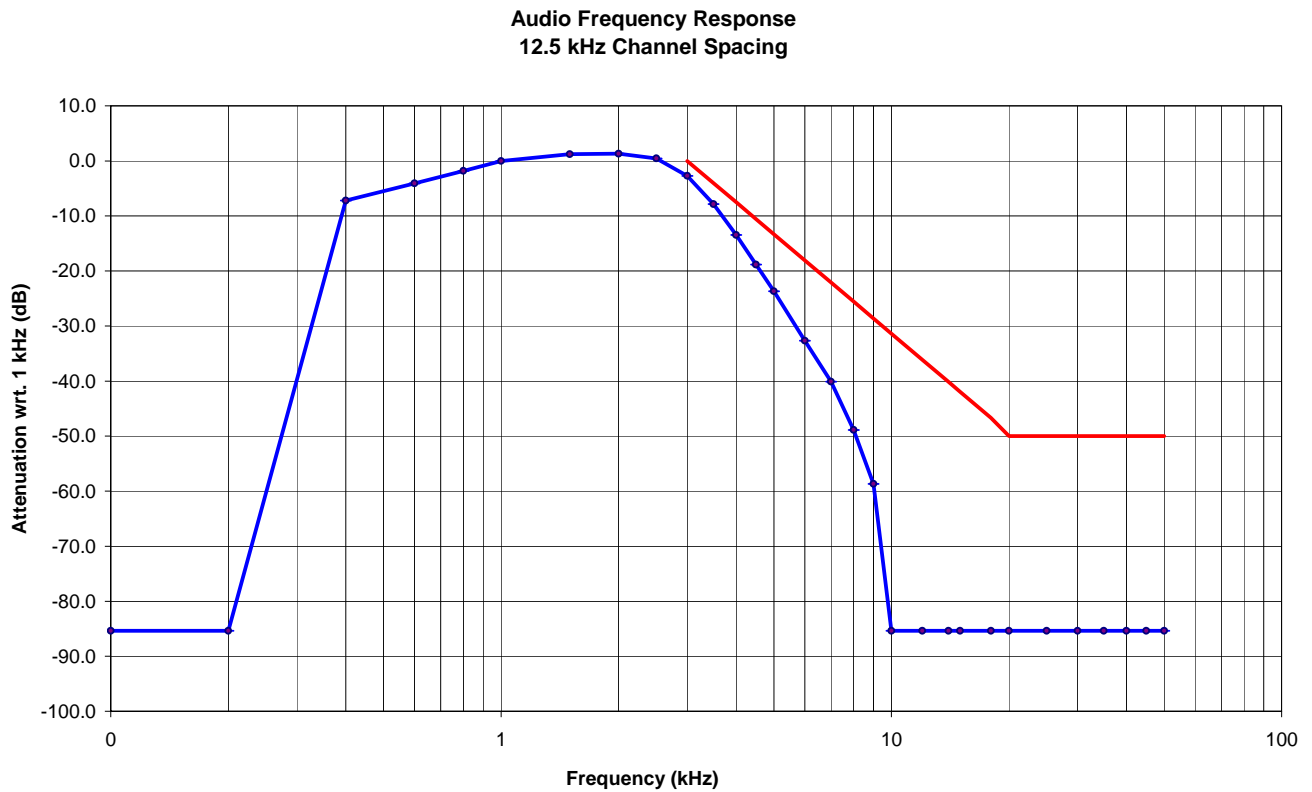

ULTRATECH GROUP OF LABS

3000 Bristol Circle, Oakville, Ontario, Canada L6H 6G4
Tel. #: 905-829-1570, Fax. #: 905-829-8050, Email: vic@ultratech-labs.com, Website: <http://www.ultratech-labs.com>

File #: ICOM-104F90

December 15, 2004

All test results contained in this engineering test report are traceable to National Institute of Standards and Technology (NIST)

6.7.5.2. 25 kHz Channel Spacing, F3E, Frequency of All Modulation States*

Note: Due to the difficulty of measuring the Frequency Response of the internal low-pass filter, the Frequency Response of All Modulation States was performed to show the roll-off at 3 kHz in comparison with recommended attenuation for audio low-pass filter.

Frequency (kHz)	Audio IN (dBV)	Audio OUT (dBV)	Attenuation (OUT - IN) (dB)	Attenuation wrt. 1 kHz (dB)	Recommended Attenuation (dB)
0.1	-36.19	<-85.00	<-48.8	<-91.4	--
0.2	-36.19	<-85.00	<-48.8	<-91.4	--
0.4	-36.19	-1.22	35.0	-7.6	--
0.6	-36.19	1.81	38.0	-4.5	--
0.8	-36.19	4.21	40.4	-2.1	--
1.0	-36.19	6.35	42.5	0.0	--
1.5	-36.19	7.74	43.9	1.4	--
2.0	-36.19	8.00	44.2	1.7	--
2.5	-36.19	7.83	44.0	1.5	--
3.0	-36.19	6.54	42.7	0.2	0
3.5	-36.19	3.13	39.3	-3.2	-4
4.0	-36.19	-1.76	34.4	-8.1	-7
4.5	-36.19	-6.73	29.5	-13.1	-11
5.0	-36.19	-11.57	24.6	-17.9	-13
6.0	-36.19	-20.43	15.8	-26.8	-18
7.0	-36.19	-28.31	7.9	-34.7	-22
8.0	-36.19	-36.31	-0.1	-42.7	-26
9.0	-36.19	-45.35	-9.2	-51.7	-29
10.0	-36.19	-54.67	-18.5	-61.0	-31
12.0	-36.19	<-85.00	<-48.8	<-91.4	-36
14.0	-36.19	<-85.00	<-48.8	<-91.4	-40
15.0	-36.19	<-85.00	<-48.8	<-91.4	-42
18.0	-36.19	<-85.00	<-48.8	<-91.4	-47
20.0	-36.19	<-85.00	<-48.8	<-91.4	-50
25.0	-36.19	<-85.00	<-48.8	<-91.4	-50
30.0	-36.19	<-85.00	<-48.8	<-91.4	-50
35.0	-36.19	<-85.00	<-48.8	<-91.4	-50
40.0	-36.19	<-85.00	<-48.8	<-91.4	-50
45.0	-36.19	<-85.00	<-48.8	<-91.4	-50
50.0	-36.19	<-85.00	<-48.8	<-91.4	-50

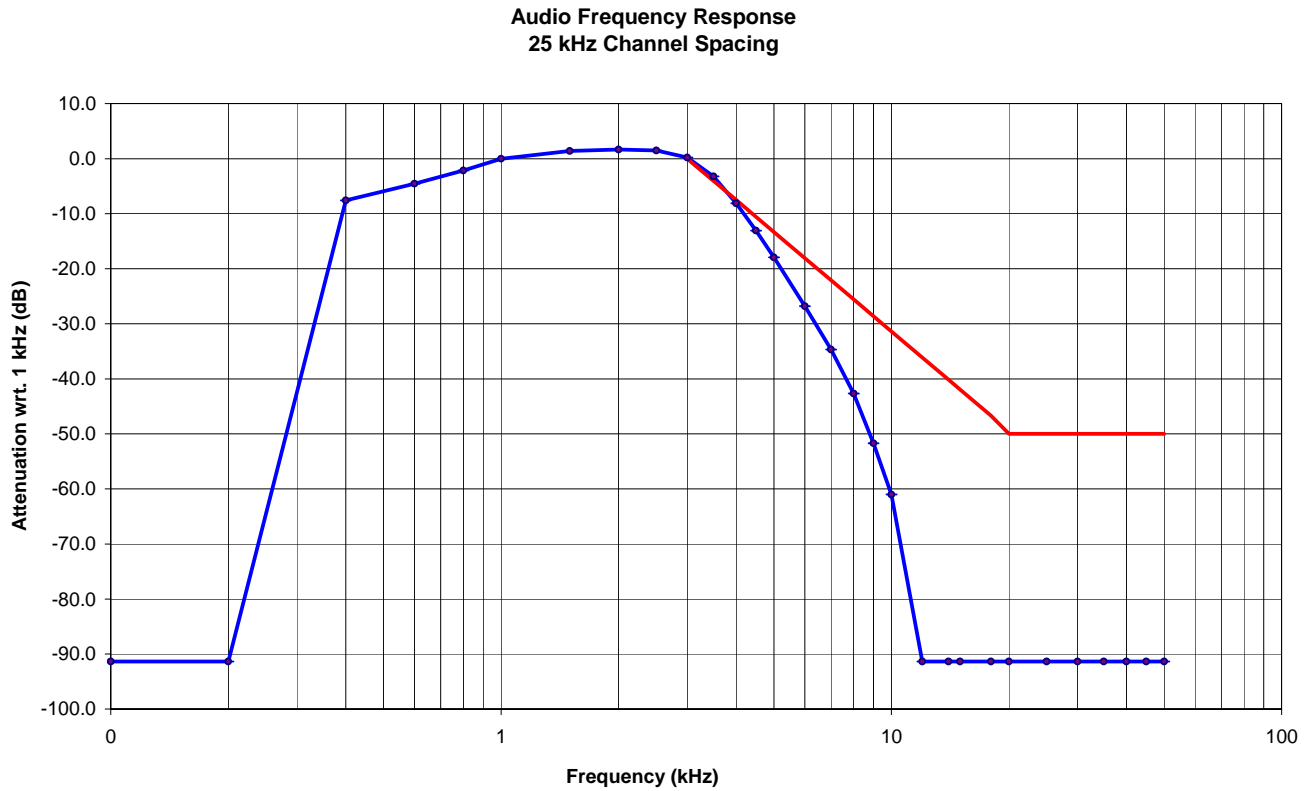

6.8. MODULATION LIMITING [§§ 2.1047(b) & 90.210]

6.8.1. Limits

Recommended frequency deviation characteristics are given below:

- 2.5 kHz for 12.5 kHz Channel Spacing
- 5 kHz for 25 kHz Channel Spacing System

6.8.2. Method of Measurements

For Audio Transmitter:- The carrier frequency deviation was measured with the tone input signal level varied from 0 Vp to audio input rating level plus 16 dB at frequencies 0.1, 0.5, 1.0, 3.0 and 5.0 kHz. The maximum deviation was recorded at each test condition.

For Data Transmitter with Maximum Frequency Deviation set by Factory:- The EUT was set at maximum frequency deviation, and its peak frequency deviation was then measured using EUT's internal random data source.

6.8.3. Test Equipment List

Test Instruments	Manufacturer	Model No.	Serial No.	Frequency Range
Radio Communication	Marconi	2955	132037/226	20Hz – 20 kHz
Modulation Analyzer	Hewlett Packard	8901B	3226A04606	150 kHz – 1300 MHz
Attenuator(s)	Weinschel Corp	23-20-34	BH7876	DC – 18 GHz
Power Supply	Tenna	72-6153	--	--
Digital Multimeter	Rohde & Schwarz	UDS5	8729841067	DC-100 kHz

6.8.4. Test Arrangement

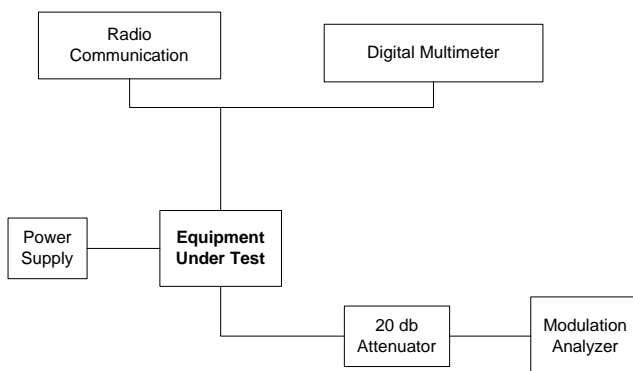

6.8.5. Test Data

6.8.5.1. Data Modulation Limiting

FM modulation with random data and modulation limiter set at a maximum frequency deviations (factory setting)

Data Baud Rate	Peak Deviation
9600bps	3.1 kHz

6.8.5.2. Voice Modulation Limiting for 12.5 kHz Channel Spacing Operation

MODULATING SIGNAL LEVEL (mVrms)	PEAK FREQUENCY DEVIATION (kHz) at the following modulating frequency:					MAXIMUM LIMIT (kHz)
	0.1 kHz	0.5 kHz	1.0 kHz	3.0 kHz	5.0 kHz	
2	0.08	0.17	0.24	0.35	0.11	2.5
4	0.08	0.25	0.45	0.65	0.12	2.5
6	0.09	0.36	0.62	0.94	0.15	2.5
8	0.09	0.45	0.81	1.07	0.16	2.5
10	0.08	0.55	0.98	1.10	0.18	2.5
15	0.09	0.79	1.45	1.15	0.19	2.5
20	0.08	1.02	1.70	1.17	0.18	2.5
25	0.10	1.27	1.78	1.18	0.17	2.5
30	0.09	1.51	1.82	1.18	0.19	2.5
35	0.10	1.75	1.86	1.19	0.20	2.5
40	0.10	1.90	1.90	1.18	0.21	2.5
45	0.09	1.96	1.92	1.19	0.24	2.5
50	0.09	2.06	1.93	1.20	0.24	2.5
60	0.10	2.15	1.88	1.20	0.24	2.5
70	0.09	2.16	1.89	1.23	0.25	2.5
80	0.09	2.14	1.89	1.23	0.25	2.5
90	0.10	2.08	1.89	1.24	0.27	2.5
100	0.10	2.09	1.90	1.23	0.26	2.5
150	0.21	2.08	1.90	1.23	0.28	2.5
200	0.35	2.08	1.89	1.25	0.28	2.5
300	0.82	2.07	1.88	1.26	0.28	2.5
400	1.20	2.08	1.90	1.27	0.28	2.5
500	1.46	2.08	1.89	1.27	0.30	2.5
600	1.67	2.07	1.90	1.26	0.28	2.5
700	1.82	2.09	1.89	1.27	0.28	2.5
800	1.85	2.09	1.87	1.25	0.28	2.5
900	1.87	2.09	1.88	1.26	0.28	2.5
1000	1.90	2.11	1.88	1.26	0.29	2.5

Voice Signal Input Level = STD MOD Level + 16 dB
 = 23.80 dB(mVrms) + 16 dB
 = 39.80 dB(mVrms)
 = 97.7 mVrms

Modulating Frequency (kHz)	Peak Frequency Deviation (kHz)	Maximum Limit (kHz)
0.1	0.09	2.5
0.2	0.76	2.5
0.4	1.90	2.5
0.6	1.90	2.5
0.8	1.87	2.5
1.0	1.89	2.5
1.2	1.88	2.5
1.4	1.86	2.5
1.6	1.86	2.5
1.8	1.87	2.5
2.0	1.85	2.5
2.5	1.68	2.5
3.0	1.23	2.5
3.5	0.70	2.5
4.0	0.43	2.5
4.5	0.33	2.5
5.0	0.25	2.5
6.0	0.15	2.5
7.0	0.10	2.5
8.0	0.25	2.5
9.0	0.09	2.5
10.0	0.09	2.5

6.8.5.3. Voice Modulation Limiting for 25 kHz Channel Spacing Operation:

MODULATING SIGNAL LEVEL (mVrms)	PEAK FREQUENCY DEVIATION (kHz) at the following modulating frequency:					MAXIMUM LIMIT (kHz)
	0.1 kHz	0.5 kHz	1.0 kHz	3.0 kHz	5.0 kHz	
2	0.08	0.24	0.49	0.90	0.15	5
4	0.10	0.45	0.87	1.71	0.26	5
6	0.10	0.65	1.25	2.50	0.35	5
8	0.08	0.84	1.63	2.86	0.41	5
10	0.09	1.06	2.03	2.98	0.45	5
15	0.10	1.52	2.98	3.10	0.49	5
20	0.09	2.02	3.39	3.14	0.47	5
25	0.10	2.51	3.35	3.18	0.45	5
30	0.10	3.02	3.64	3.18	0.49	5
35	0.10	3.50	3.74	3.18	0.52	5
40	0.09	3.78	3.78	3.16	0.55	5
45	0.09	3.93	3.84	3.16	0.60	5
50	0.10	4.17	3.88	3.20	0.61	5
60	0.10	4.37	3.78	3.22	0.62	5
70	0.10	4.33	3.80	3.24	0.64	5
80	0.10	4.29	3.81	3.25	0.65	5
90	0.10	4.24	3.82	3.26	0.65	5
100	0.10	4.22	3.83	3.26	0.66	5
150	0.38	4.18	3.82	3.28	0.67	5
200	0.66	4.15	3.82	3.30	0.70	5
300	1.65	4.14	3.85	3.31	0.71	5
400	2.40	4.14	3.83	3.31	0.72	5
500	2.90	4.09	3.89	3.32	0.72	5
600	3.30	4.13	3.83	3.32	0.72	5
700	3.73	4.14	3.85	3.32	0.72	5
800	3.85	4.15	3.85	3.33	0.73	5
900	3.88	4.14	3.86	3.33	0.73	5
1000	2.94	4.15	3.86	3.33	0.72	5

ULTRATECH GROUP OF LABS

3000 Bristol Circle, Oakville, Ontario, Canada L6H 6G4
 Tel. #: 905-829-1570, Fax. #: 905-829-8050, Email: vic@ultratech-labs.com, Website: <http://www.ultratech-labs.com>

File #: ICOM-104F90
 December 15, 2004

All test results contained in this engineering test report are traceable to National Institute of Standards and Technology (NIST)

Voice Signal Input Level = STD MOD Level + 16 dB
= 23.52 dB(mVrms) + 16 dB
= 39.52 dB(mVrms)
= 94.6 mVrms

Modulating Frequency (kHz)	Peak Frequency Deviation (kHz)	Maximum Limit (kHz)
0.1	0.10	5
0.2	1.40	5
0.4	4.05	5
0.6	3.84	5
0.8	3.85	5
1.0	3.84	5
1.2	3.79	5
1.4	3.77	5
1.6	3.76	5
1.8	3.81	5
2.0	3.79	5
2.5	3.71	5
3.0	3.25	5
3.5	3.24	5
4.0	1.36	5
4.5	0.92	5
5.0	0.65	5
6.0	0.37	5
7.0	0.17	5
8.0	0.44	5
9.0	0.15	5
10.0	0.12	5

ULTRATECH GROUP OF LABS

3000 Bristol Circle, Oakville, Ontario, Canada L6H 6G4
Tel. #: 905-829-1570, Fax. #: 905-829-8050, Email: vic@ultratech-labs.com, Website: <http://www.ultratech-labs.com>

File #: ICOM-104F90
December 15, 2004

All test results contained in this engineering test report are traceable to National Institute of Standards and Technology (NIST)

6.9. EMISSION MASK [§§ 2.1049, 90.209 & 90.210]

6.9.1. Limits

Emissions shall be attenuated below the mean output power of the transmitter as follows:

Frequency Range (MHz)	Maximum Authorized BW (KHz)	Channel Spacing (KHz)	Recommended Frequency Deviation (KHz)	FCC Applicable Mask
421-512	20.0	25.0	5.0	<ul style="list-style-type: none"> Mask B – Voice Mask C – Data
421-512	11.25	12.5	2.5	<ul style="list-style-type: none"> Mask D – Voice & Data

6.9.2. Method of Measurements

Refer to Exhibit 8, Section 8.4 of this report for measurement details

6.9.3. Test Equipment List

Test Instruments	Manufacturer	Model No.	Serial No.	Frequency Range
EMI Receiver/ Spectrum Analyzer	Advantest	R3271	15050203	100 Hz – 26.5 GHz
Attenuator(s)	Weinschel Corp	23-20-34	BH7876	DC – 18 GHz
Radio Communication	Marconi	2955	132037/226	20Hz – 20kHz
Digital Multimeter	Rohde & Schwarz	UDS5	8729841067	DC-100 kHz
Power Supply	Tenna	72-6153	--	--

6.9.4. Test Arrangement

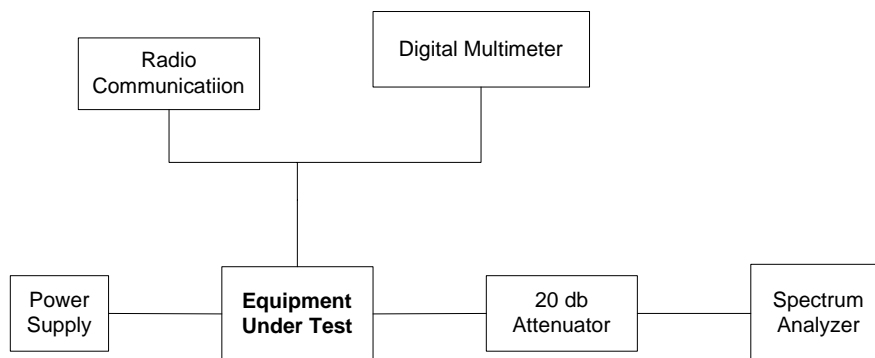

6.9.5. Test Data

6.9.5.1. 99% Occupied Bandwidth

Frequency (MHz)	Channel Spacing (kHz)	*Measured 99% OBW at Maximum Freq. Deviation (kHz)	Maximum Authorized Bandwidth (kHz)
Modulation: C4-FM (CQPSK)			
450.05	--	7.37	8.1
485.05	--	7.16	8.1
519.95	--	7.37	8.1
Modulation: FM with 2.5 kHz sine wave signal			
450.05	12.5	5.57	11.25
485.05	12.5	5.57	11.25
519.95	12.5	5.57	11.25
Modulation: FM with 2.5 kHz sine wave & CDCSS (754N)			
450.05	12.5	5.66	11.25
485.05	12.5	5.66	11.25
519.95	12.5	5.66	11.25
Modulation: FM with 2.5 kHz sine wave & CTCSS (254.1 Hz)			
450.05	12.5	5.66	11.25
485.05	12.5	5.66	11.25
519.95	12.5	5.74	11.25
Modulation: FM with 2.5 kHz sine wave signal, scrambler & CDCSS (754N)			
450.05	12.5	6.39	11.25
485.05	12.5	6.39	11.25
519.95	12.5	6.30	11.25
Modulation: FM with 2.5 kHz sine wave signal, scrambler & CTCSS (254.1 Hz)			
450.05	12.5	6.43	11.25
485.05	12.5	6.43	11.25
519.95	12.5	6.34	11.25

Frequency (MHz)	Channel Spacing (kHz)	*Measured 99% OBW at Maximum Freq. Deviation (kHz)	Maximum Authorized Bandwidth (kHz)
Modulation: FM with 2.5 kHz sine wave			
450.05	25.0	10.46	20.0
485.05	25.0	10.51	20.0
519.95	25.0	10.51	20.0
Modulation: FM with 2.5 kHz sine wave & CDCSS (754N)			
450.05	25.0	10.63	20.0
485.05	25.0	10.69	20.0
519.95	25.0	10.69	20.0
Modulation: FM with 2.5 kHz sine wave & CTCSS (254.1 Hz)			
450.05	25.0	10.63	20.0
485.05	25.0	10.74	20.0
519.95	25.0	10.91	20.0
Modulation: FM with 2.5 kHz sine wave signal, scrambler & CDCSS (754N)			
450.05	25.0	10.06	20.0
485.05	25.0	10.17	20.0
519.95	25.0	10.17	20.0
Modulation: FM with 2.5 kHz sine wave signal, scrambler & CTCSS (254.1 Hz)			
450.05	25.0	10.11	20.0
485.05	25.0	10.17	20.0
519.95	25.0	10.23	20.0

*See the following test data plots (1 through 33) for details.

Plot 1:
Occupied Bandwidth
Carrier Frequency: 450.05MHz
Power: 4 W
Modulation: C4-FM (CQPSK)

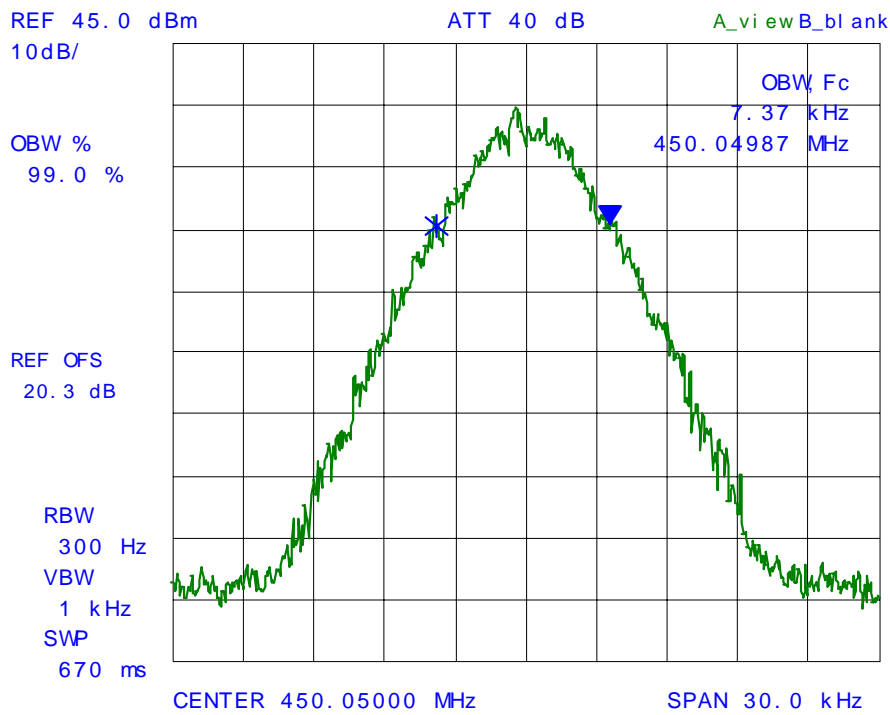

ULTRATECH GROUP OF LABS

3000 Bristol Circle, Oakville, Ontario, Canada L6H 6G4
Tel. #: 905-829-1570, Fax. #: 905-829-8050, Email: vic@ultratech-labs.com, Website: <http://www.ultratech-labs.com>

File #: ICOM-104F90

December 15, 2004

All test results contained in this engineering test report are traceable to National Institute of Standards and Technology (NIST)

Plot 2:
Occupied Bandwidth
Carrier Frequency: 485.05 MHz
Power Level: 4 W
Modulation: C4-FM (CQPSK)

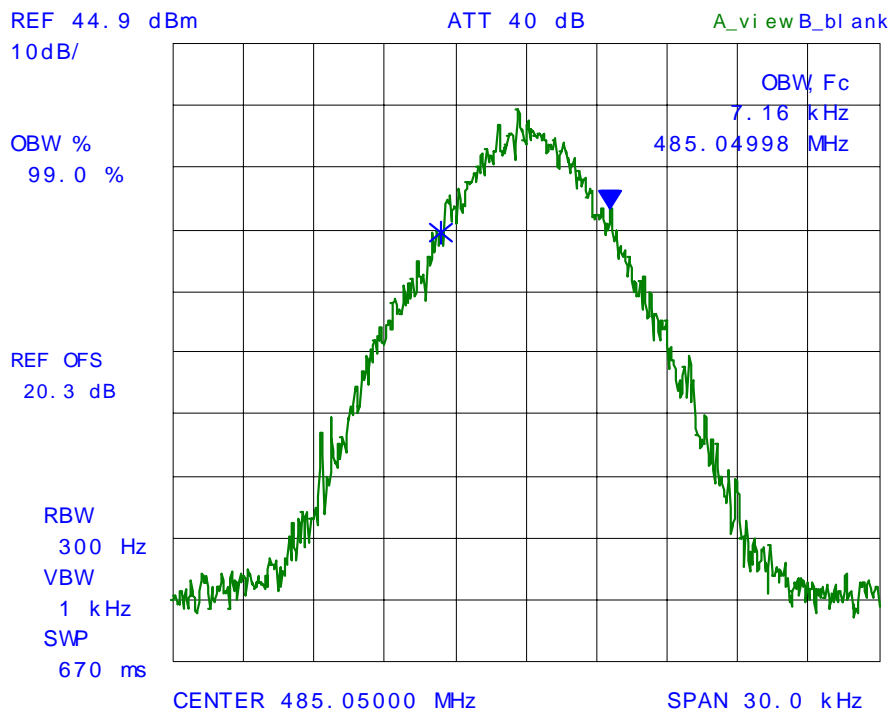

ULTRATECH GROUP OF LABS

3000 Bristol Circle, Oakville, Ontario, Canada L6H 6G4
Tel. #: 905-829-1570, Fax. #: 905-829-8050, Email: vic@ultratech-labs.com, Website: <http://www.ultratech-labs.com>

File #: ICOM-104F90

December 15, 2004

All test results contained in this engineering test report are traceable to National Institute of Standards and Technology (NIST)

Plot 3:
Occupied Bandwidth
Carrier Frequency: 519.95 MHz
Power Level: 4 W
Modulation: C4-FM (CQPSK)

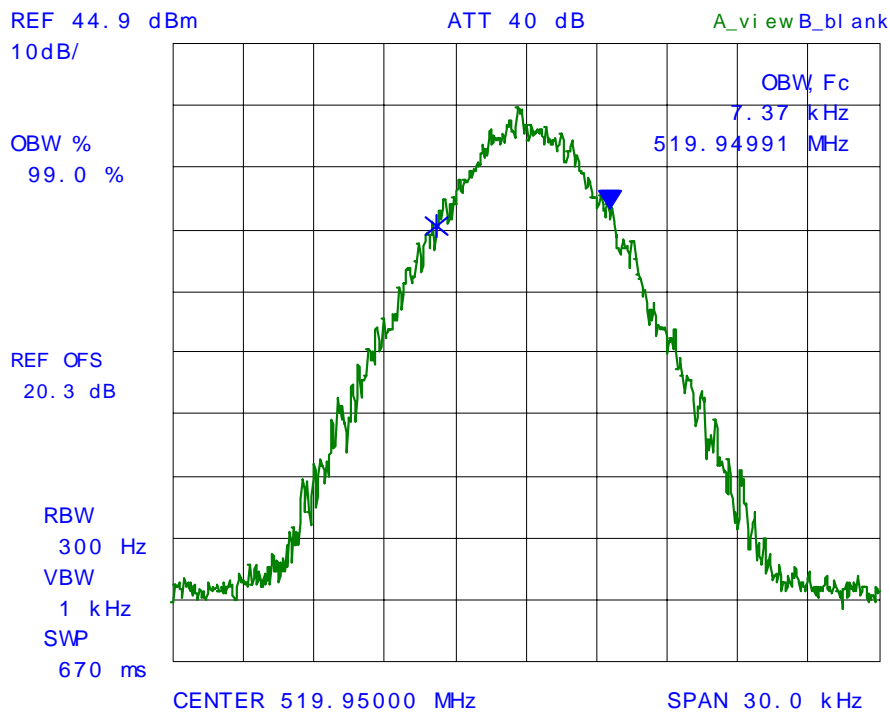

ULTRATECH GROUP OF LABS

3000 Bristol Circle, Oakville, Ontario, Canada L6H 6G4
Tel. #: 905-829-1570, Fax. #: 905-829-8050, Email: vic@ultratech-labs.com, Website: <http://www.ultratech-labs.com>

File #: ICOM-104F90

December 15, 2004

All test results contained in this engineering test report are traceable to National Institute of Standards and Technology (NIST)

Plot 4:
Occupied Bandwidth
Carrier Frequency: 450.05MHz
Channel Spacing: 12.5 kHz
Power Level: 4 W
Modulation: FM with 2.5 kHz sine wave

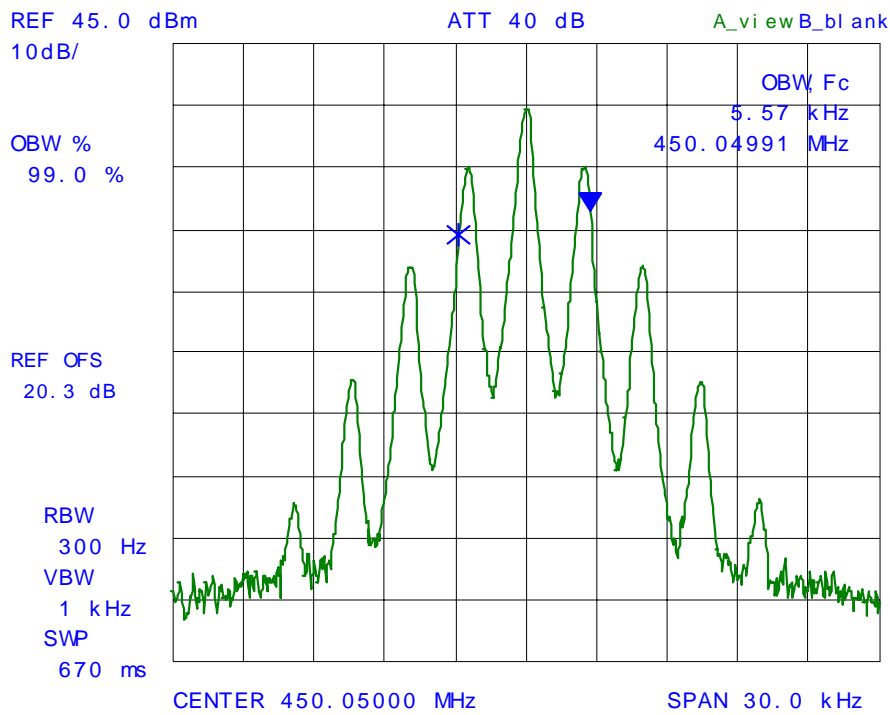

ULTRATECH GROUP OF LABS

3000 Bristol Circle, Oakville, Ontario, Canada L6H 6G4
Tel. #: 905-829-1570, Fax. #: 905-829-8050, Email: vic@ultratech-labs.com, Website: <http://www.ultratech-labs.com>

File #: ICOM-104F90
December 15, 2004

All test results contained in this engineering test report are traceable to National Institute of Standards and Technology (NIST)

Plot 5:
Occupied Bandwidth
Carrier Frequency: 485.05 MHz
Channel Spacing: 12.5 kHz
Power Level: 4 W
Modulation: FM with 2.5 kHz sine wave

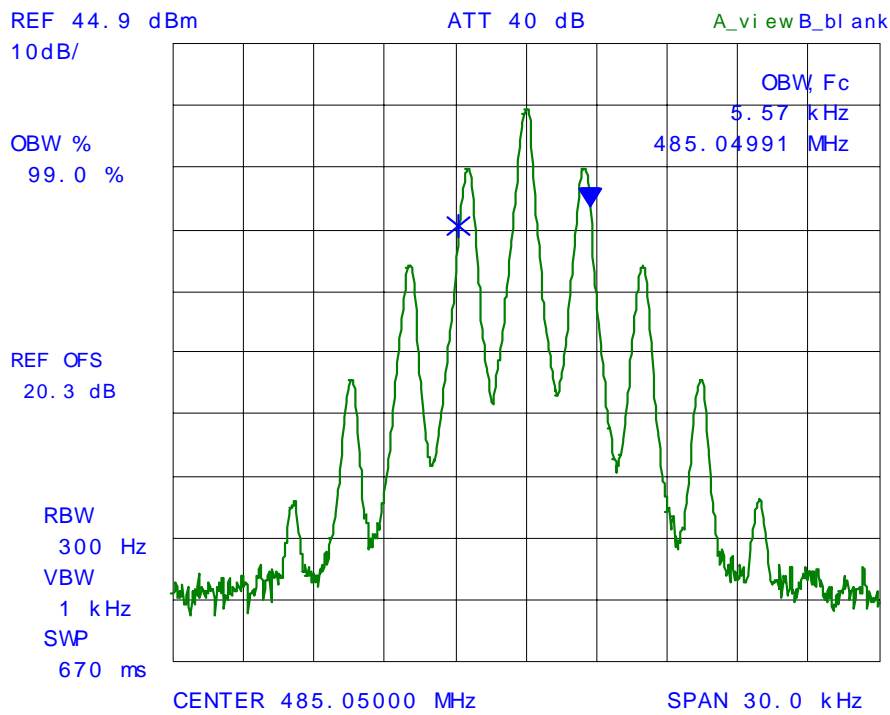

ULTRATECH GROUP OF LABS

3000 Bristol Circle, Oakville, Ontario, Canada L6H 6G4
Tel. #: 905-829-1570, Fax. #: 905-829-8050, Email: vic@ultratech-labs.com, Website: <http://www.ultratech-labs.com>

File #: ICOM-104F90

December 15, 2004

All test results contained in this engineering test report are traceable to National Institute of Standards and Technology (NIST)

Plot 6:
Occupied Bandwidth
Carrier Frequency: 519.95 MHz
Channel Spacing: 12.5 kHz
Power Level: 4 W
Modulation: FM with 2.5 kHz sine wave

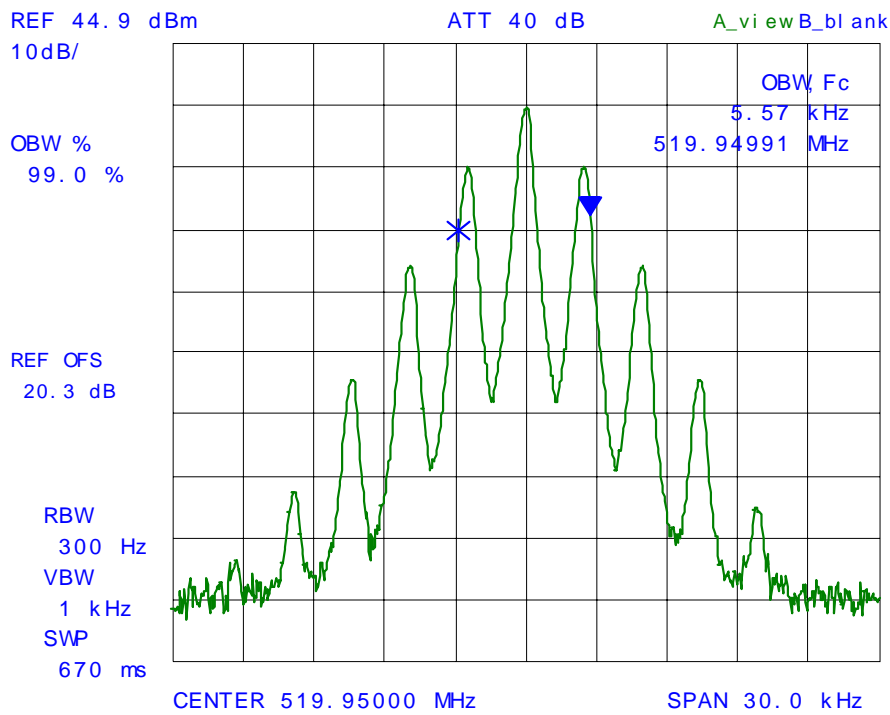

ULTRATECH GROUP OF LABS

3000 Bristol Circle, Oakville, Ontario, Canada L6H 6G4
Tel. #: 905-829-1570, Fax. #: 905-829-8050, Email: vic@ultratech-labs.com, Website: <http://www.ultratech-labs.com>

File #: ICOM-104F90

December 15, 2004

All test results contained in this engineering test report are traceable to National Institute of Standards and Technology (NIST)

Plot 7:
Occupied Bandwidth
Carrier Frequency: 450.05MHz
Channel Spacing: 12.5 kHz
Power: 4 W
Modulation: FM with 2.5 kHz sine wave & CDCSS (754N)

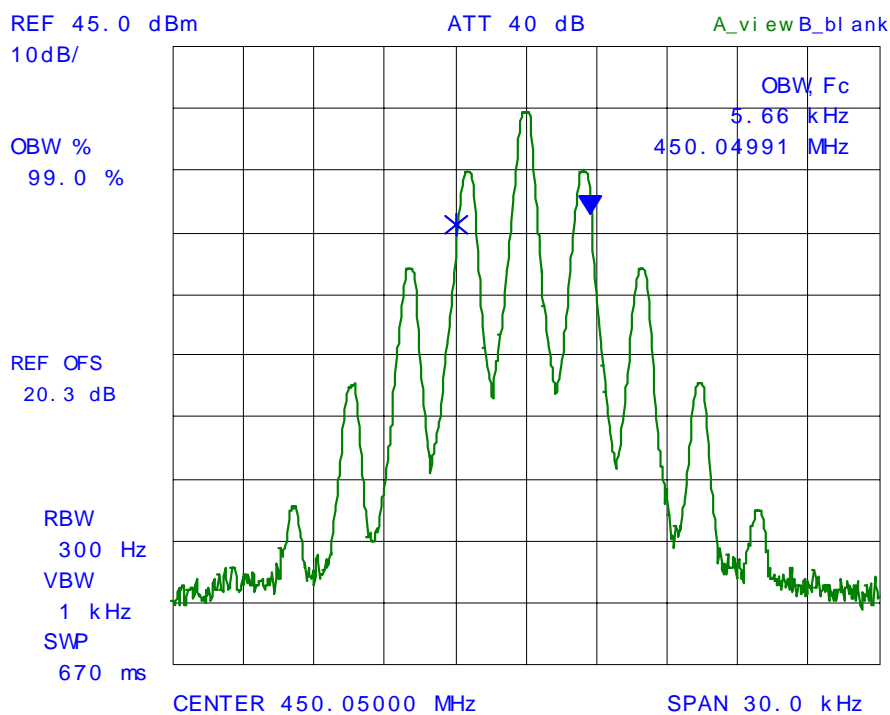

ULTRATECH GROUP OF LABS

3000 Bristol Circle, Oakville, Ontario, Canada L6H 6G4
Tel. #: 905-829-1570, Fax. #: 905-829-8050, Email: vic@ultratech-labs.com, Website: <http://www.ultratech-labs.com>

File #: ICOM-104F90

December 15, 2004

All test results contained in this engineering test report are traceable to National Institute of Standards and Technology (NIST)

Plot 8:
Occupied Bandwidth
Carrier Frequency: 485.05 MHz
Channel Spacing: 12.5 kHz
Power: 4 W
Modulation: FM with 2.5 kHz sine wave & CDCSS (754N)

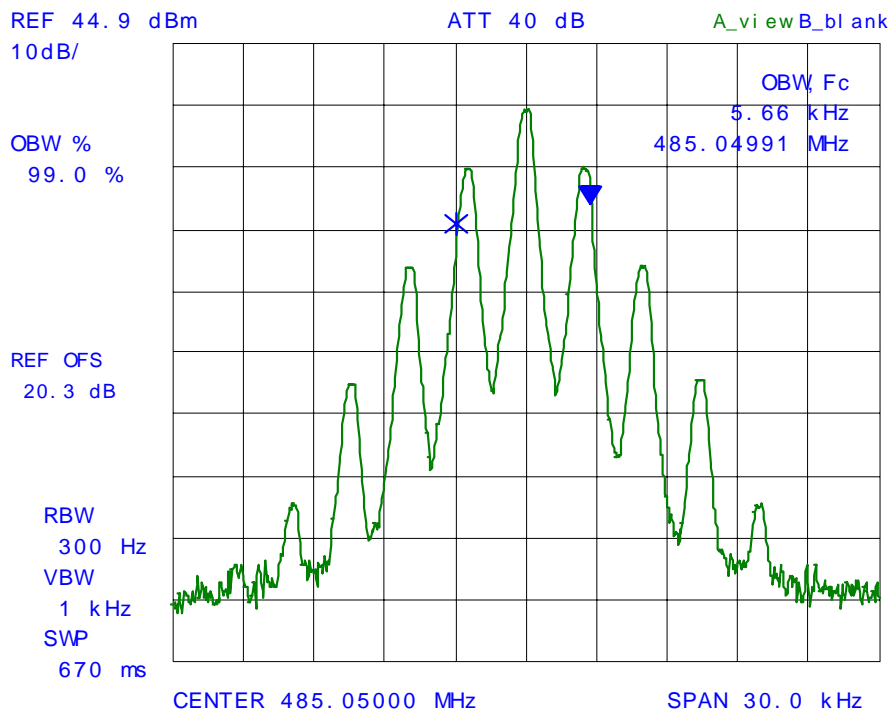

ULTRATECH GROUP OF LABS

3000 Bristol Circle, Oakville, Ontario, Canada L6H 6G4
Tel. #: 905-829-1570, Fax. #: 905-829-8050, Email: vic@ultratech-labs.com, Website: <http://www.ultratech-labs.com>

File #: ICOM-104F90

December 15, 2004

All test results contained in this engineering test report are traceable to National Institute of Standards and Technology (NIST)

Plot 9:
Occupied Bandwidth
Carrier Frequency: 519.95 MHz
Channel Spacing: 12.5 kHz
Power Level: 4 W
Modulation: FM with 2.5 kHz sine wave & CDCSS (754N)

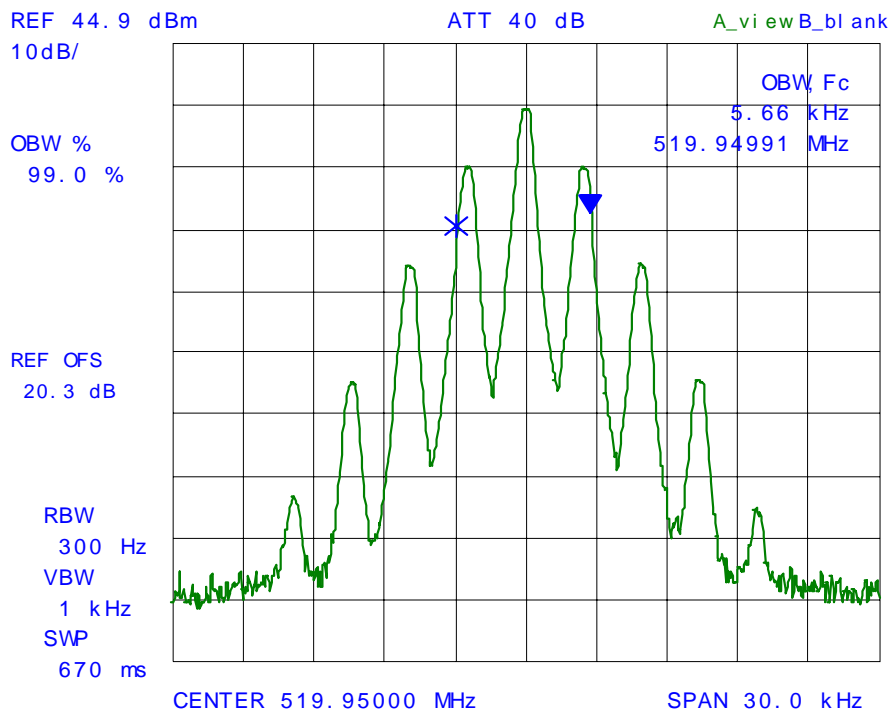

ULTRATECH GROUP OF LABS

3000 Bristol Circle, Oakville, Ontario, Canada L6H 6G4
Tel. #: 905-829-1570, Fax. #: 905-829-8050, Email: vic@ultratech-labs.com, Website: <http://www.ultratech-labs.com>

File #: ICOM-104F90

December 15, 2004

All test results contained in this engineering test report are traceable to National Institute of Standards and Technology (NIST)

Plot 10:
Occupied Bandwidth
Carrier Frequency: 450.05MHz
Channel Spacing: 12.5 kHz
Power Level: 4 W
Modulation: FM with 2.5 kHz sine wave & CTCSS (254.1 Hz)

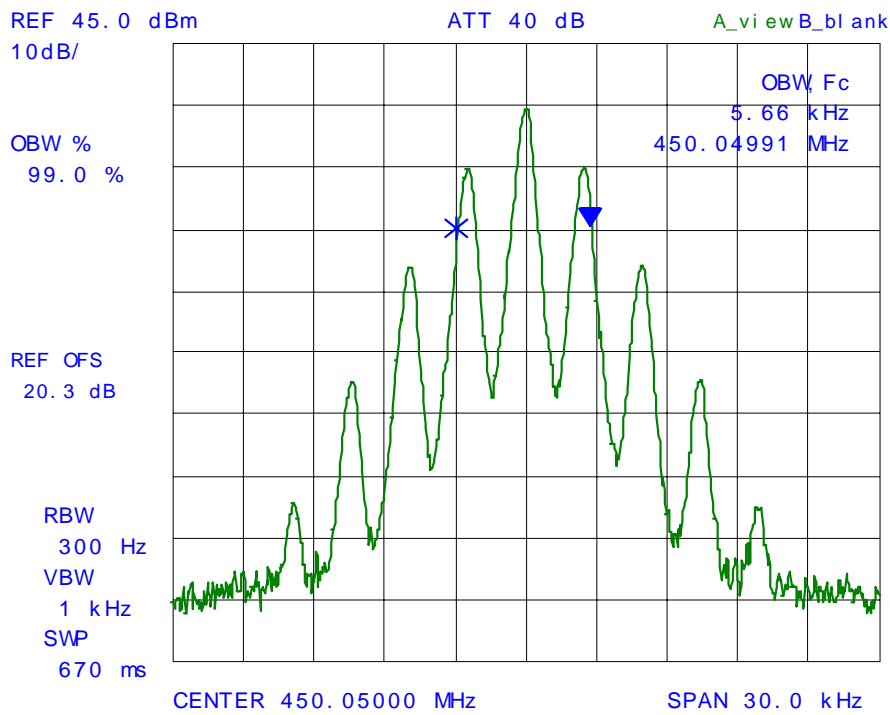

ULTRATECH GROUP OF LABS

3000 Bristol Circle, Oakville, Ontario, Canada L6H 6G4
Tel. #: 905-829-1570, Fax. #: 905-829-8050, Email: vic@ultratech-labs.com, Website: <http://www.ultratech-labs.com>

File #: ICOM-104F90

December 15, 2004

All test results contained in this engineering test report are traceable to National Institute of Standards and Technology (NIST)

Plot 11:
Occupied Bandwidth
Carrier Frequency: 485.05 MHz
Channel Spacing: 12.5 kHz
Power Level: 4 W
Modulation: FM with 2.5 kHz sine wave & CTCSS (254.1 Hz)

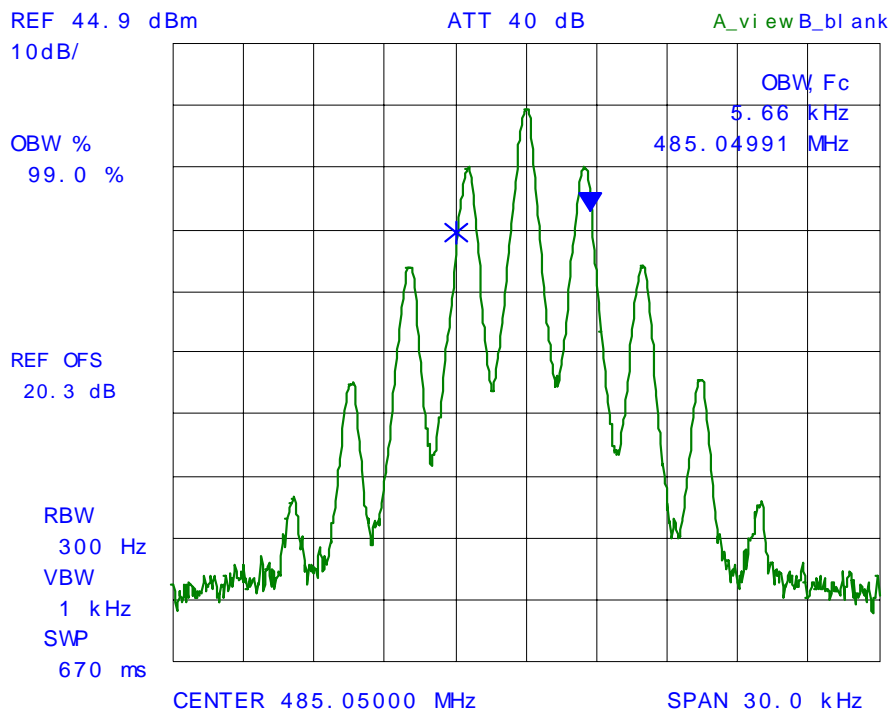

ULTRATECH GROUP OF LABS

3000 Bristol Circle, Oakville, Ontario, Canada L6H 6G4
Tel. #: 905-829-1570, Fax. #: 905-829-8050, Email: vic@ultratech-labs.com, Website: <http://www.ultratech-labs.com>

File #: ICOM-104F90

December 15, 2004

All test results contained in this engineering test report are traceable to National Institute of Standards and Technology (NIST)

Plot 12:
Occupied Bandwidth
Carrier Frequency: 519.95 MHz
Channel Spacing: 12.5 kHz
Power Level: 4 W
Modulation: FM with 2.5 kHz sine wave signal & CTCSS (254.1 Hz)

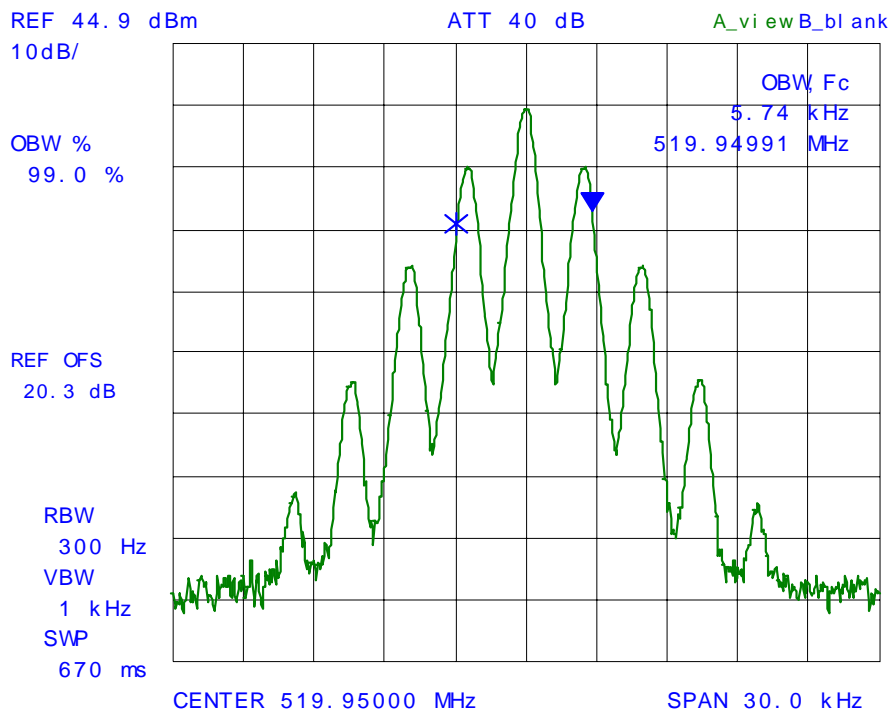

ULTRATECH GROUP OF LABS

3000 Bristol Circle, Oakville, Ontario, Canada L6H 6G4
Tel. #: 905-829-1570, Fax. #: 905-829-8050, Email: vic@ultratech-labs.com, Website: <http://www.ultratech-labs.com>

File #: ICOM-104F90

December 15, 2004

All test results contained in this engineering test report are traceable to National Institute of Standards and Technology (NIST)

Plot 13:
Occupied Bandwidth
Carrier Frequency: 450.05MHz
Channel Spacing: 12.5 kHz
Power Level: 4 W
Modulation: FM with 2.5 kHz sine wave signal, scrambler & CDCSS (754N)

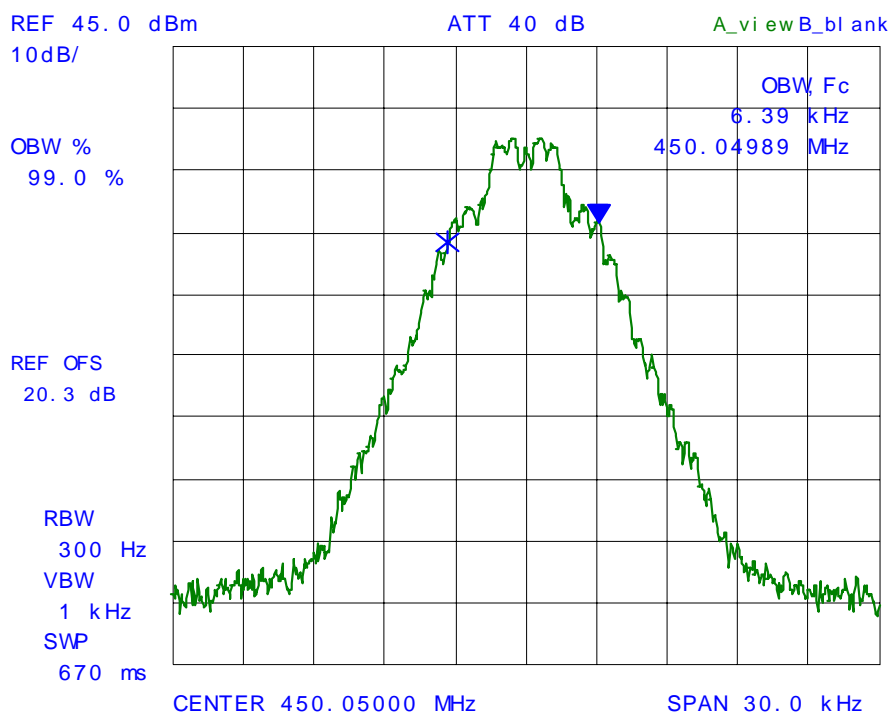

Plot 14:
Occupied Bandwidth
Carrier Frequency: 485.05 MHz
Channel Spacing: 12.5 kHz
Power Level: 4 W
Modulation: FM with 2.5 kHz sine wave signal, scrambler & CDCSS (754N)

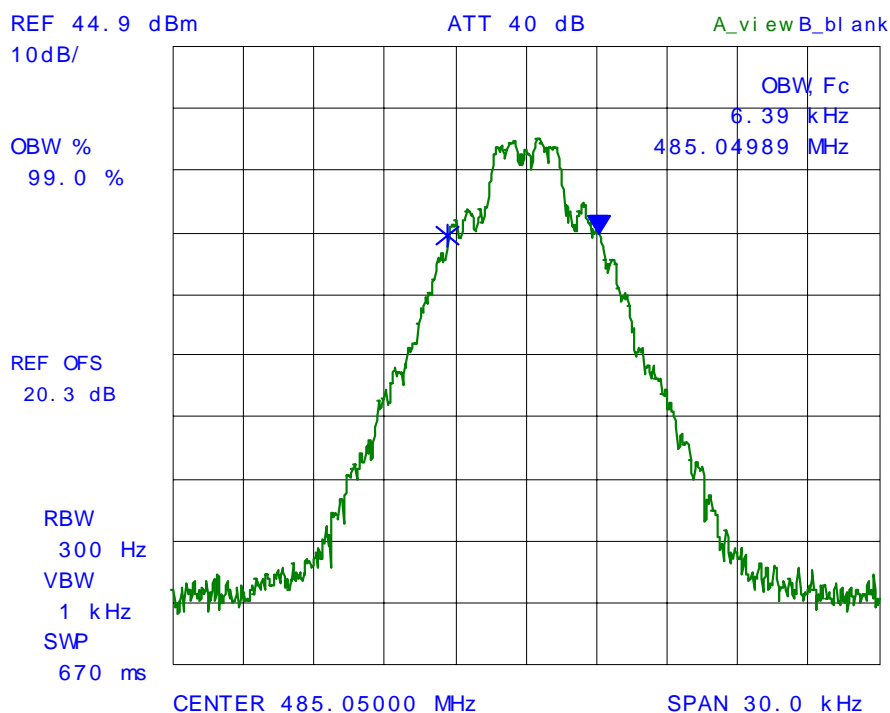

ULTRATECH GROUP OF LABS

3000 Bristol Circle, Oakville, Ontario, Canada L6H 6G4
Tel. #: 905-829-1570, Fax. #: 905-829-8050, Email: vic@ultratech-labs.com, Website: <http://www.ultratech-labs.com>

File #: ICOM-104F90

December 15, 2004

All test results contained in this engineering test report are traceable to National Institute of Standards and Technology (NIST)

Plot 15:
Occupied Bandwidth
Carrier Frequency: 519.95 MHz
Channel Spacing: 12.5 kHz
Power Level: 4 W
Modulation: FM with 2.5 kHz sine wave signal, scrambler & CDCSS (754N)

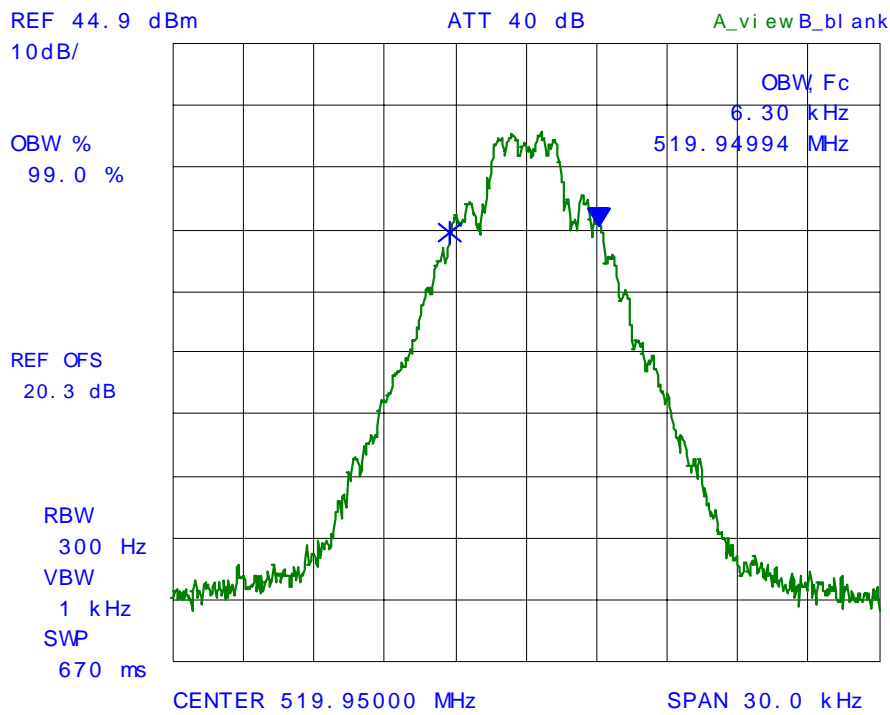

ULTRATECH GROUP OF LABS

3000 Bristol Circle, Oakville, Ontario, Canada L6H 6G4
Tel. #: 905-829-1570, Fax. #: 905-829-8050, Email: vic@ultratech-labs.com, Website: <http://www.ultratech-labs.com>

File #: ICOM-104F90

December 15, 2004

All test results contained in this engineering test report are traceable to National Institute of Standards and Technology (NIST)

Plot 16:
Occupied Bandwidth
Carrier Frequency: 450.05MHz
Channel Spacing: 12.5 kHz
Power Level: 4 W
Modulation: FM with 2.5 kHz sine wave signal, scrambler & CTCSS (254.1 Hz)

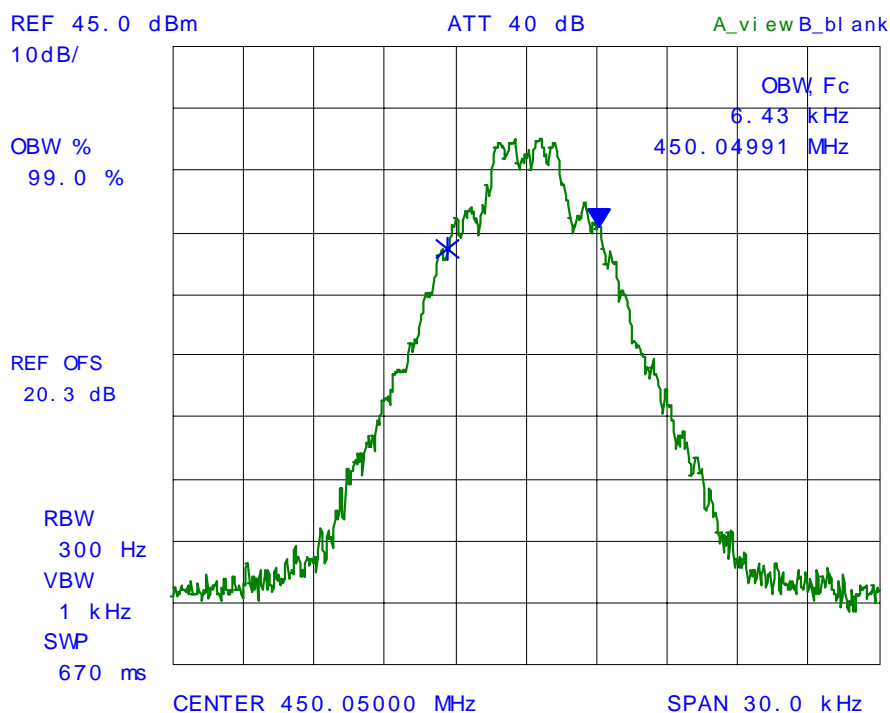

ULTRATECH GROUP OF LABS

3000 Bristol Circle, Oakville, Ontario, Canada L6H 6G4
Tel. #: 905-829-1570, Fax. #: 905-829-8050, Email: vic@ultratech-labs.com, Website: <http://www.ultratech-labs.com>

File #: ICOM-104F90
December 15, 2004

All test results contained in this engineering test report are traceable to National Institute of Standards and Technology (NIST)

Plot 17:
Occupied Bandwidth
Carrier Frequency: 485.05 MHz
Channel Spacing: 12.5 kHz
Power Level: 4 W
Modulation: FM with 2.5 kHz sine wave signal, scrambler & CTCSS (254.1 Hz)

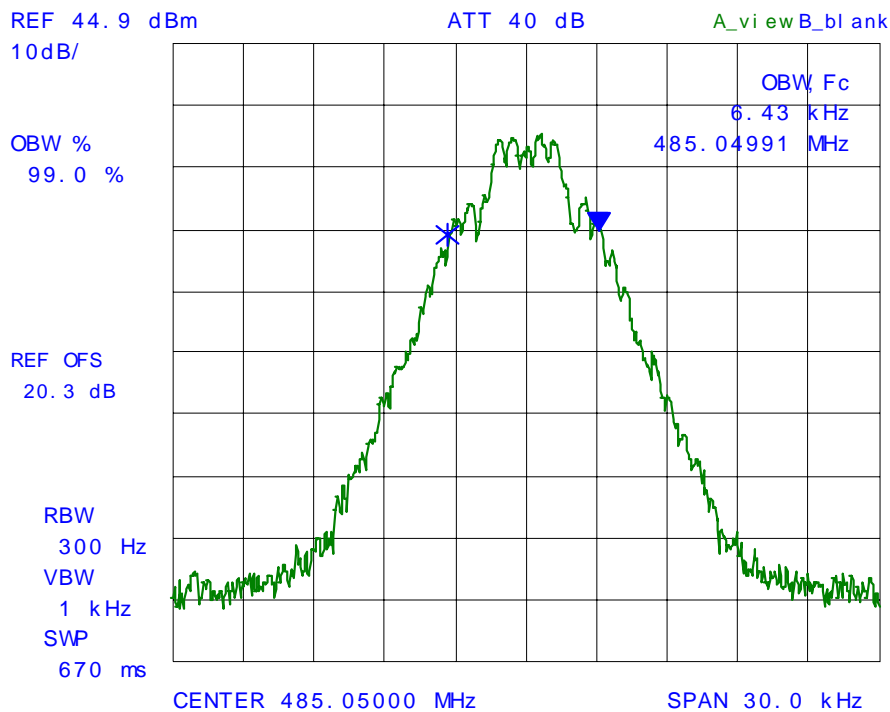

ULTRATECH GROUP OF LABS

3000 Bristol Circle, Oakville, Ontario, Canada L6H 6G4
Tel. #: 905-829-1570, Fax. #: 905-829-8050, Email: vic@ultratech-labs.com, Website: <http://www.ultratech-labs.com>

File #: ICOM-104F90
December 15, 2004

All test results contained in this engineering test report are traceable to National Institute of Standards and Technology (NIST)

Plot 18:
Occupied Bandwidth
Carrier Frequency: 519.95 MHz
Channel Spacing: 12.5 kHz
Power Level: 4 W
Modulation: FM with 2.5 kHz sine wave signal, scrambler & CTCSS (254.1 Hz)

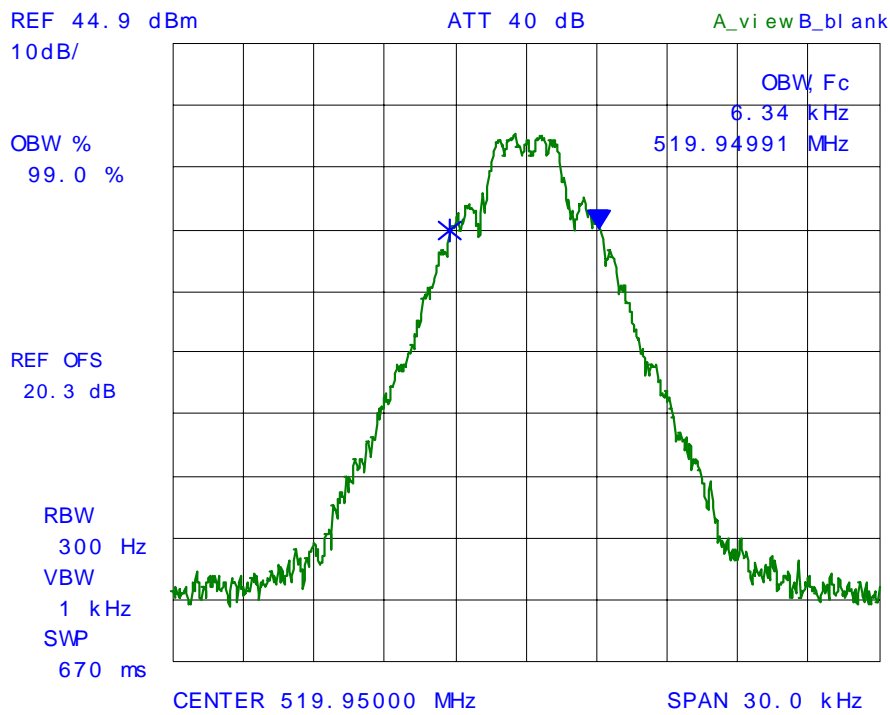

ULTRATECH GROUP OF LABS

3000 Bristol Circle, Oakville, Ontario, Canada L6H 6G4
Tel. #: 905-829-1570, Fax. #: 905-829-8050, Email: vic@ultratech-labs.com, Website: <http://www.ultratech-labs.com>

File #: ICOM-104F90

December 15, 2004

All test results contained in this engineering test report are traceable to National Institute of Standards and Technology (NIST)

Plot 19:
Occupied Bandwidth
Carrier Frequency: 450.05MHz
Channel Spacing: 25 kHz
Power Level: 4 W
Modulation: FM with 2.5 kHz sine wave

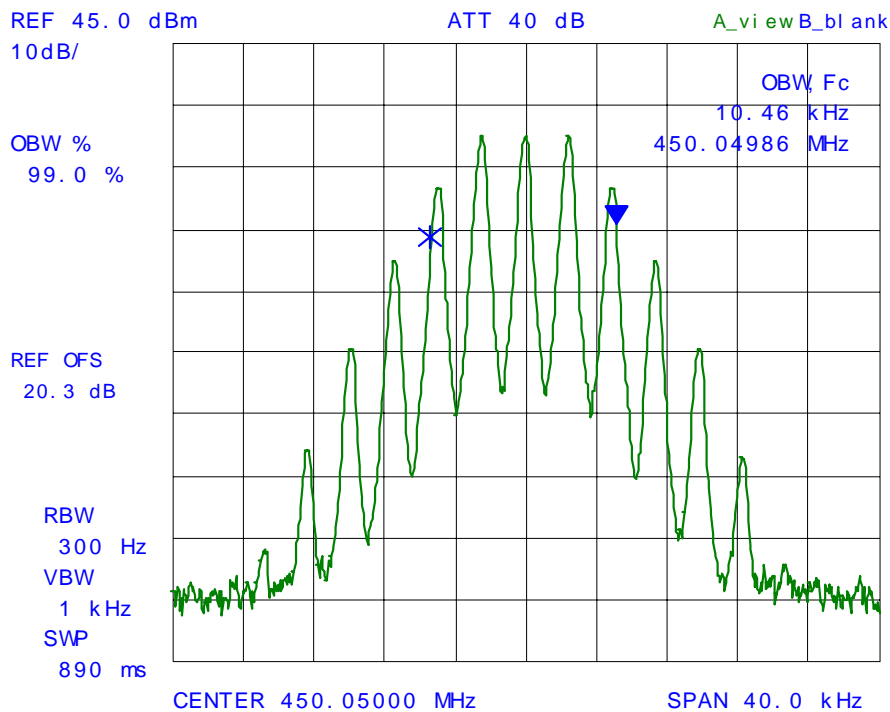

ULTRATECH GROUP OF LABS

3000 Bristol Circle, Oakville, Ontario, Canada L6H 6G4
Tel. #: 905-829-1570, Fax. #: 905-829-8050, Email: vic@ultratech-labs.com, Website: <http://www.ultratech-labs.com>

File #: ICOM-104F90
December 15, 2004

All test results contained in this engineering test report are traceable to National Institute of Standards and Technology (NIST)

Plot 20:
Occupied Bandwidth
Carrier Frequency: 485.05 MHz
Channel Spacing: 25 kHz
Power Level: 4 W
Modulation: FM with 2.5 kHz sine wave

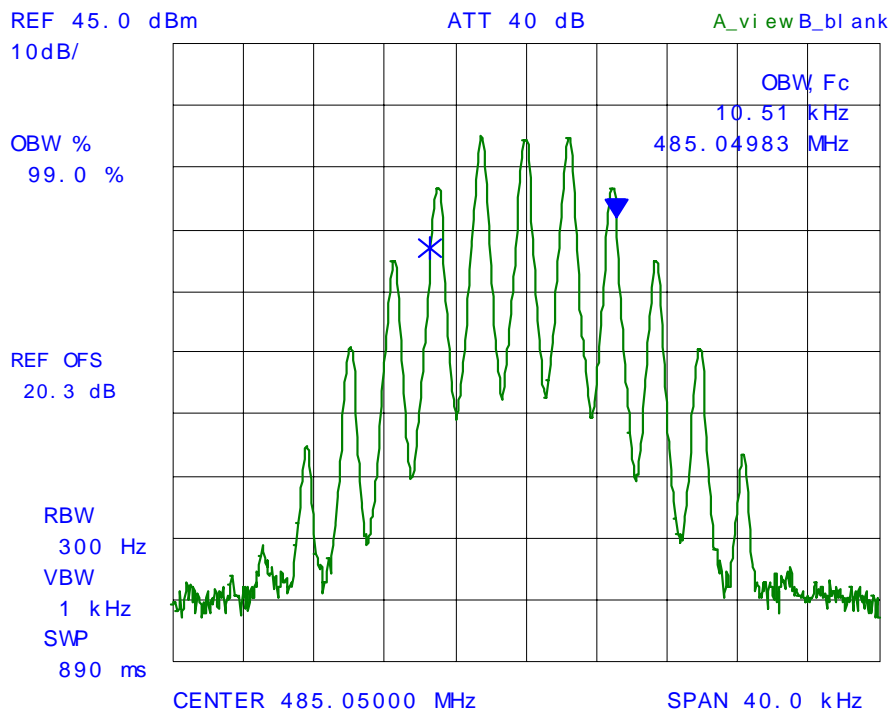

ULTRATECH GROUP OF LABS

3000 Bristol Circle, Oakville, Ontario, Canada L6H 6G4
Tel. #: 905-829-1570, Fax. #: 905-829-8050, Email: vic@ultratech-labs.com, Website: <http://www.ultratech-labs.com>

File #: ICOM-104F90

December 15, 2004

All test results contained in this engineering test report are traceable to National Institute of Standards and Technology (NIST)

Plot 21:
Occupied Bandwidth
Carrier Frequency: 519.95 MHz
Channel Spacing: 25 kHz
Power Level: 4 W
Modulation: FM with 2.5 kHz sine wave

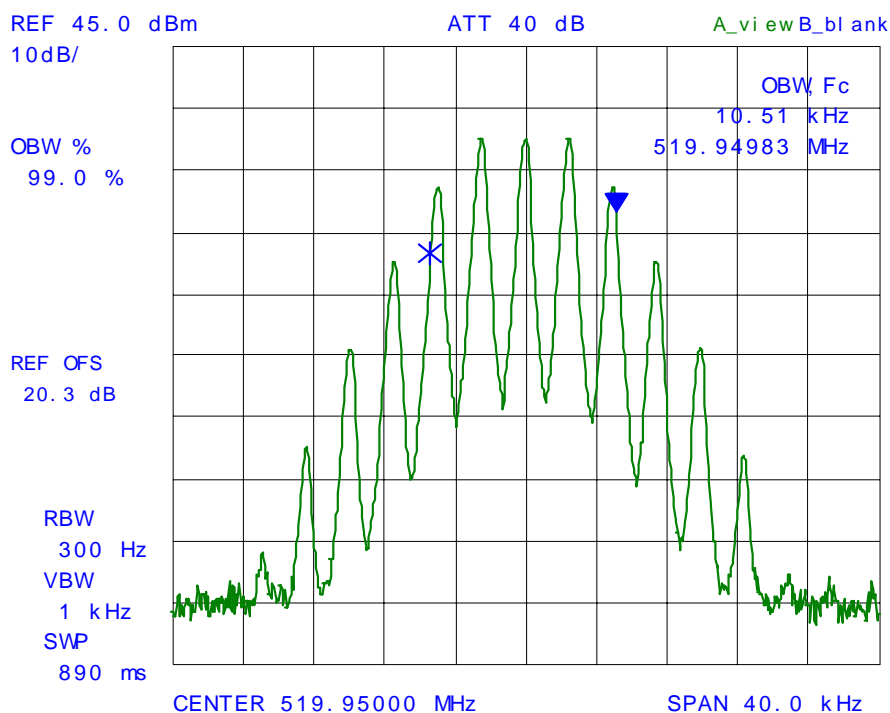

ULTRATECH GROUP OF LABS

3000 Bristol Circle, Oakville, Ontario, Canada L6H 6G4
Tel. #: 905-829-1570, Fax. #: 905-829-8050, Email: vic@ultratech-labs.com, Website: <http://www.ultratech-labs.com>

File #: ICOM-104F90

December 15, 2004

All test results contained in this engineering test report are traceable to National Institute of Standards and Technology (NIST)

Plot 22:
Occupied Bandwidth
Carrier Frequency: 450.05MHz
Channel Spacing: 25 kHz
Power Level: 4 W
Modulation: FM with 2.5 kHz sine wave & CDCSS (754N)

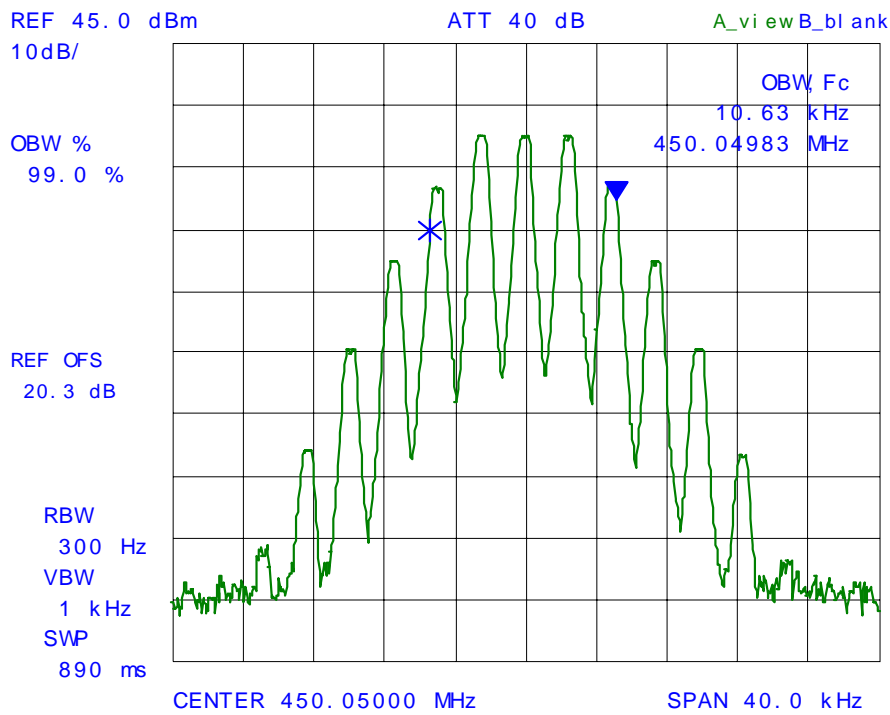

ULTRATECH GROUP OF LABS

3000 Bristol Circle, Oakville, Ontario, Canada L6H 6G4
Tel. #: 905-829-1570, Fax. #: 905-829-8050, Email: vic@ultratech-labs.com, Website: <http://www.ultratech-labs.com>

File #: ICOM-104F90

December 15, 2004

All test results contained in this engineering test report are traceable to National Institute of Standards and Technology (NIST)

Plot 23:
Occupied Bandwidth
Carrier Frequency: 485.05 MHz
Channel Spacing: 25 kHz
Power Level: 4 W
Modulation: FM with 2.5 kHz sine wave & CDCSS (754N)

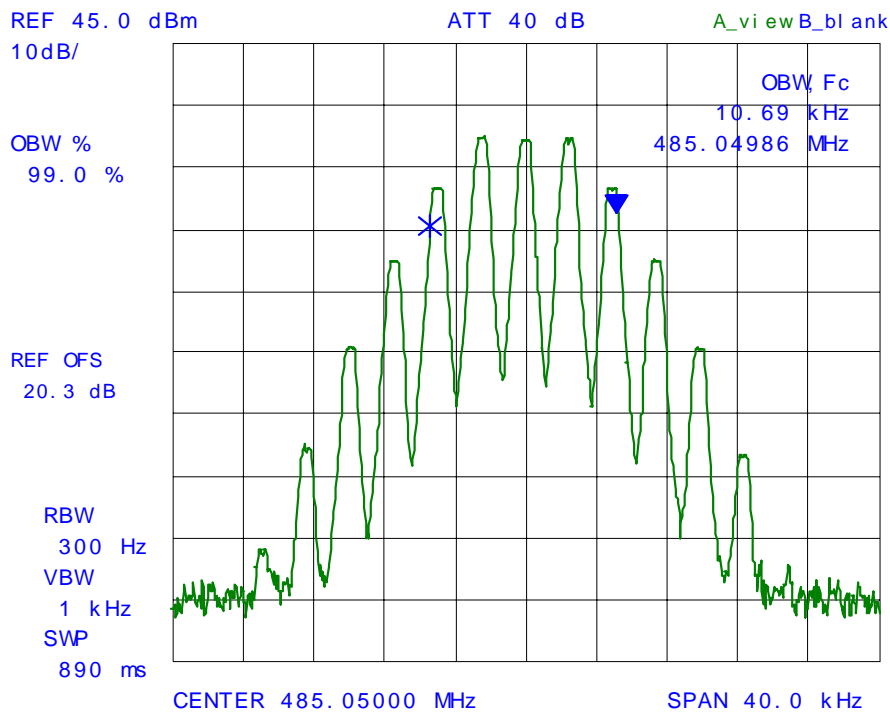

ULTRATECH GROUP OF LABS

3000 Bristol Circle, Oakville, Ontario, Canada L6H 6G4
Tel. #: 905-829-1570, Fax. #: 905-829-8050, Email: vic@ultratech-labs.com, Website: <http://www.ultratech-labs.com>

File #: ICOM-104F90

December 15, 2004

All test results contained in this engineering test report are traceable to National Institute of Standards and Technology (NIST)

Plot 24:
Occupied Bandwidth
Carrier Frequency: 519.95 MHz
Channel Spacing: 25 kHz
Power Level: 4 W
Modulation: FM with 2.5 kHz sine wave & CDCSS (754N)

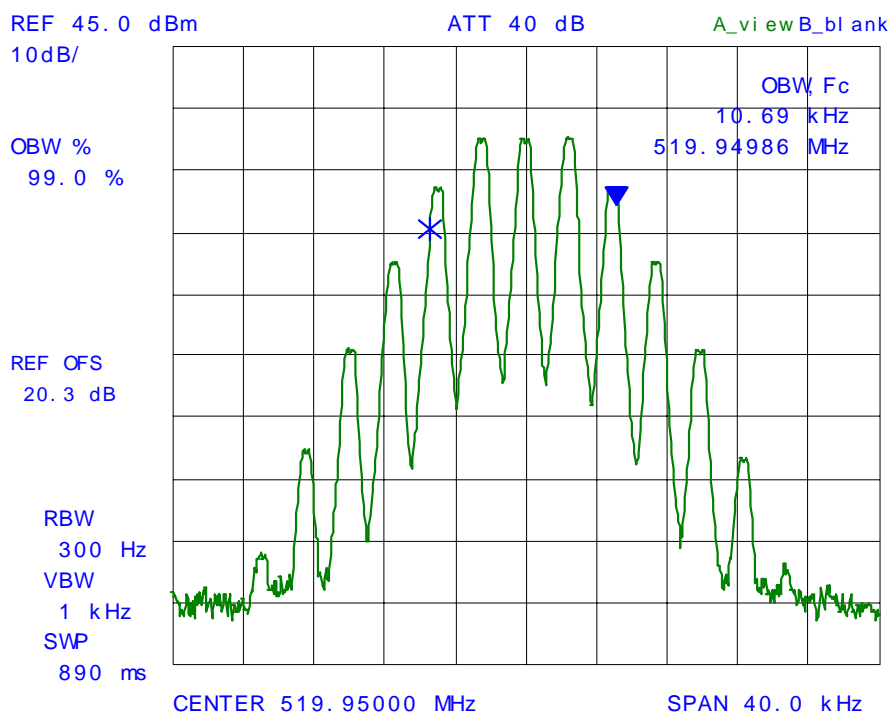

Plot 25:
Occupied Bandwidth
Carrier Frequency: 450.05MHz
Channel Spacing: 25 kHz
Power Level: 4 W
Modulation: FM with 2.5 kHz sine wave & CTCSS (254.1 Hz)

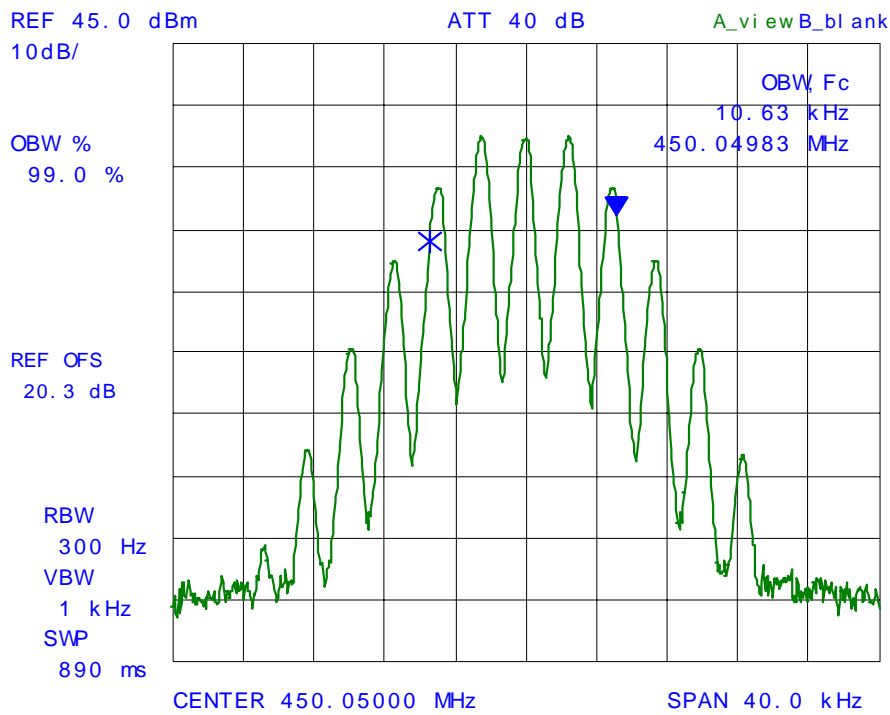

ULTRATECH GROUP OF LABS

3000 Bristol Circle, Oakville, Ontario, Canada L6H 6G4
Tel. #: 905-829-1570, Fax. #: 905-829-8050, Email: vic@ultratech-labs.com, Website: <http://www.ultratech-labs.com>

File #: ICOM-104F90

December 15, 2004

All test results contained in this engineering test report are traceable to National Institute of Standards and Technology (NIST)

Plot 26:
Occupied Bandwidth
Carrier Frequency: 485.05 MHz
Channel Spacing: 25 kHz
Power Level: 4 W
Modulation: FM with 2.5 kHz sine wave & CTCSS (254.1 Hz)

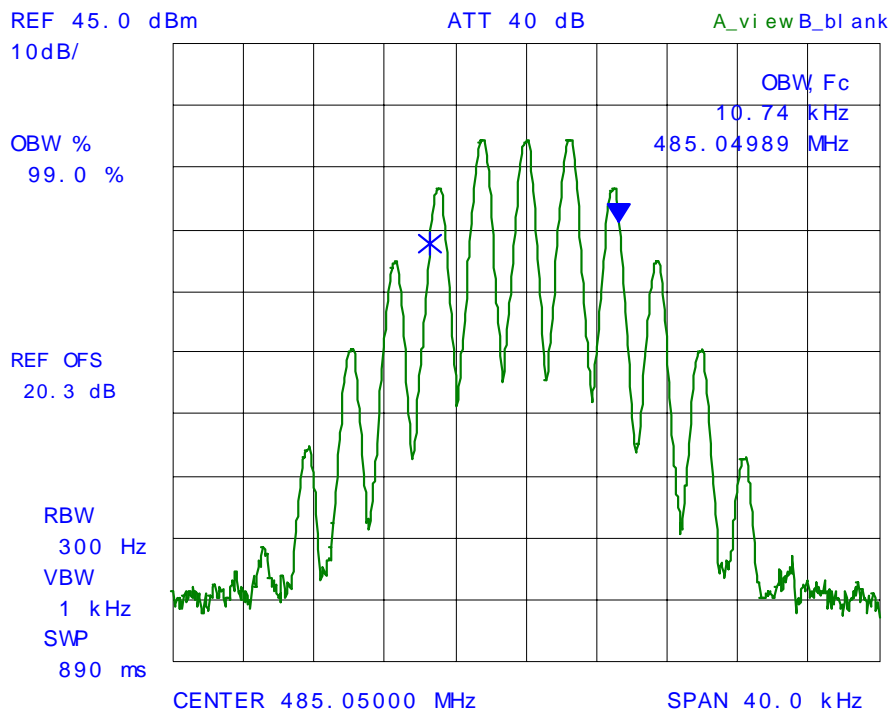

ULTRATECH GROUP OF LABS

3000 Bristol Circle, Oakville, Ontario, Canada L6H 6G4
Tel. #: 905-829-1570, Fax. #: 905-829-8050, Email: vic@ultratech-labs.com, Website: <http://www.ultratech-labs.com>

File #: ICOM-104F90

December 15, 2004

All test results contained in this engineering test report are traceable to National Institute of Standards and Technology (NIST)

Plot 27:
Occupied Bandwidth
Carrier Frequency: 519.95 MHz
Channel Spacing: 25 kHz
Power Level: 4 W
Modulation: FM with 2.5 kHz sine wave signal & CTCSS (254.1 Hz)

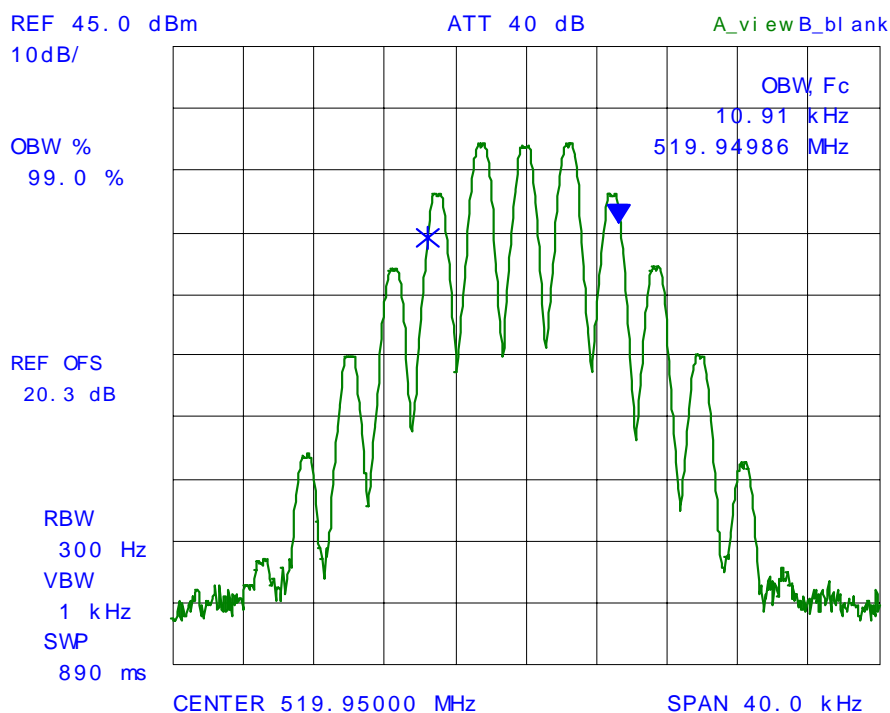

ULTRATECH GROUP OF LABS

3000 Bristol Circle, Oakville, Ontario, Canada L6H 6G4
Tel. #: 905-829-1570, Fax. #: 905-829-8050, Email: vic@ultratech-labs.com, Website: <http://www.ultratech-labs.com>

File #: ICOM-104F90

December 15, 2004

All test results contained in this engineering test report are traceable to National Institute of Standards and Technology (NIST)

Plot 28:
Occupied Bandwidth
Carrier Frequency: 450.05MHz
Channel Spacing: 25 kHz
Power Level: 4 W
Modulation: FM with 2.5 kHz sine wave signal, scrambler & CDCSS (754N)

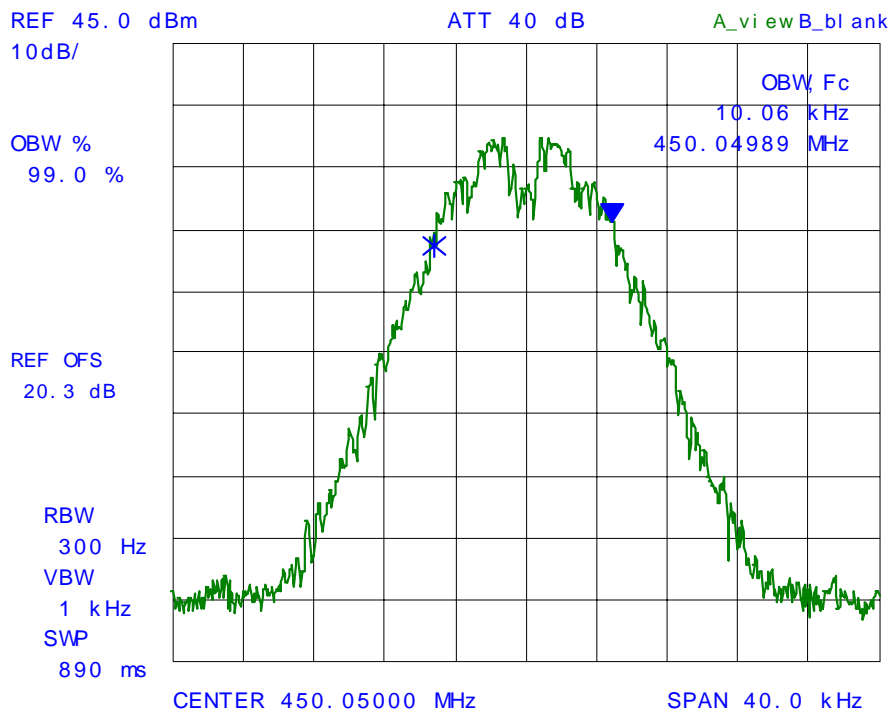

ULTRATECH GROUP OF LABS

3000 Bristol Circle, Oakville, Ontario, Canada L6H 6G4
Tel. #: 905-829-1570, Fax. #: 905-829-8050, Email: vic@ultratech-labs.com, Website: <http://www.ultratech-labs.com>

File #: ICOM-104F90
December 15, 2004

All test results contained in this engineering test report are traceable to National Institute of Standards and Technology (NIST)

Plot 29:
Occupied Bandwidth
Carrier Frequency: 485.05 MHz
Channel Spacing: 25 kHz
Power Level: 4 W
Modulation: FM with 2.5 kHz sine wave signal, scrambler & CDCSS (754N)

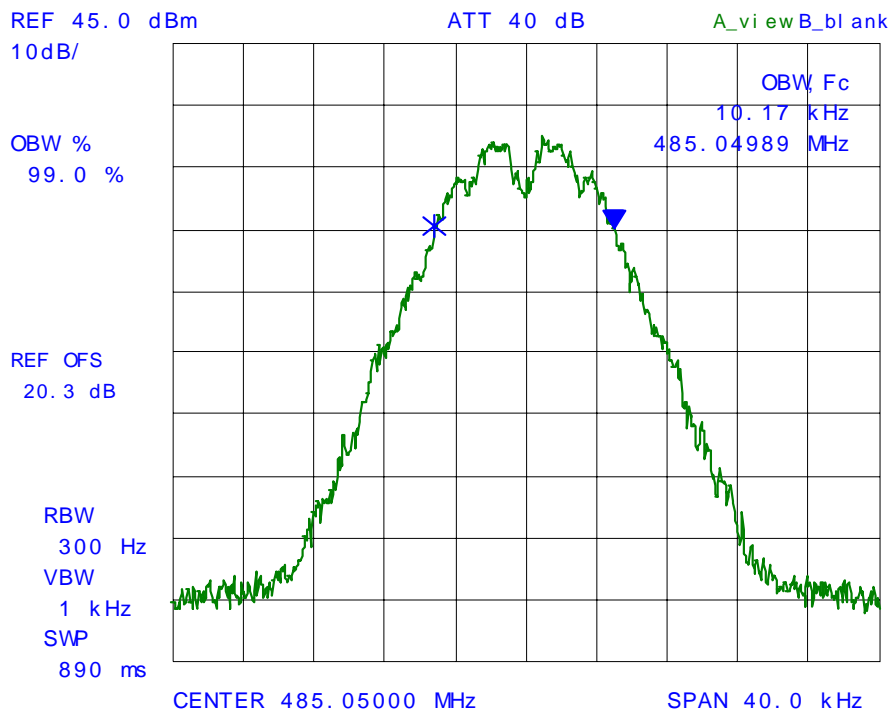

ULTRATECH GROUP OF LABS

3000 Bristol Circle, Oakville, Ontario, Canada L6H 6G4
Tel. #: 905-829-1570, Fax. #: 905-829-8050, Email: vic@ultratech-labs.com, Website: <http://www.ultratech-labs.com>

File #: ICOM-104F90

December 15, 2004

All test results contained in this engineering test report are traceable to National Institute of Standards and Technology (NIST)

Plot 30:
Occupied Bandwidth
Carrier Frequency: 519.95 MHz
Channel Spacing: 25 kHz
Power Level: 4 W
Modulation: FM with 2.5 kHz sine wave signal, scrambler & CDCSS (754N)

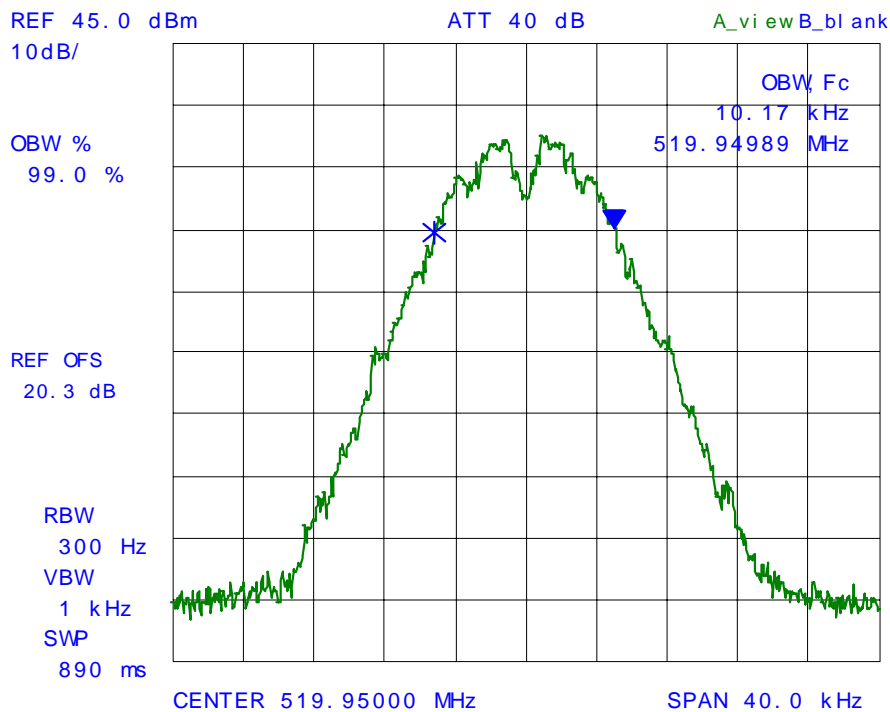

ULTRATECH GROUP OF LABS

3000 Bristol Circle, Oakville, Ontario, Canada L6H 6G4
Tel. #: 905-829-1570, Fax. #: 905-829-8050, Email: vic@ultratech-labs.com, Website: <http://www.ultratech-labs.com>

File #: ICOM-104F90

December 15, 2004

All test results contained in this engineering test report are traceable to National Institute of Standards and Technology (NIST)

Plot 31:
Occupied Bandwidth
Carrier Frequency: 450.05MHz
Channel Spacing: 25 kHz
Power Level: 4 W
Modulation: FM with 2.5 kHz sine wave signal, scrambler & CTCSS (254.1 Hz)

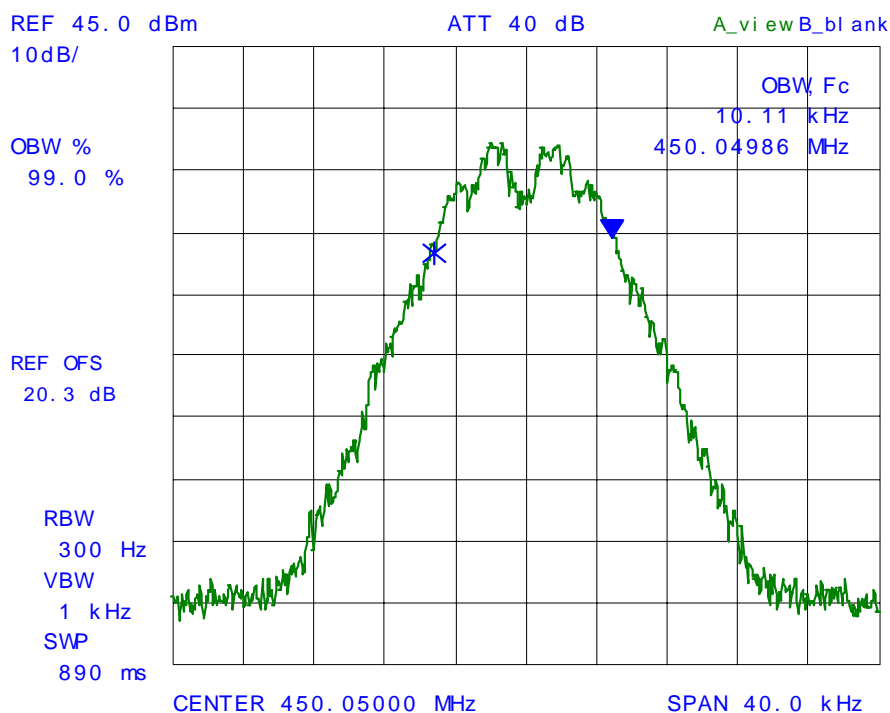

ULTRATECH GROUP OF LABS

3000 Bristol Circle, Oakville, Ontario, Canada L6H 6G4
Tel. #: 905-829-1570, Fax. #: 905-829-8050, Email: vic@ultratech-labs.com, Website: <http://www.ultratech-labs.com>

File #: ICOM-104F90

December 15, 2004

All test results contained in this engineering test report are traceable to National Institute of Standards and Technology (NIST)

Plot 32:
Occupied Bandwidth
Carrier Frequency: 485.05 MHz
Channel Spacing: 25 kHz
Power Level: 4 W
Modulation: FM with 2.5 kHz sine wave signal, scrambler & CTCSS (254.1 Hz)

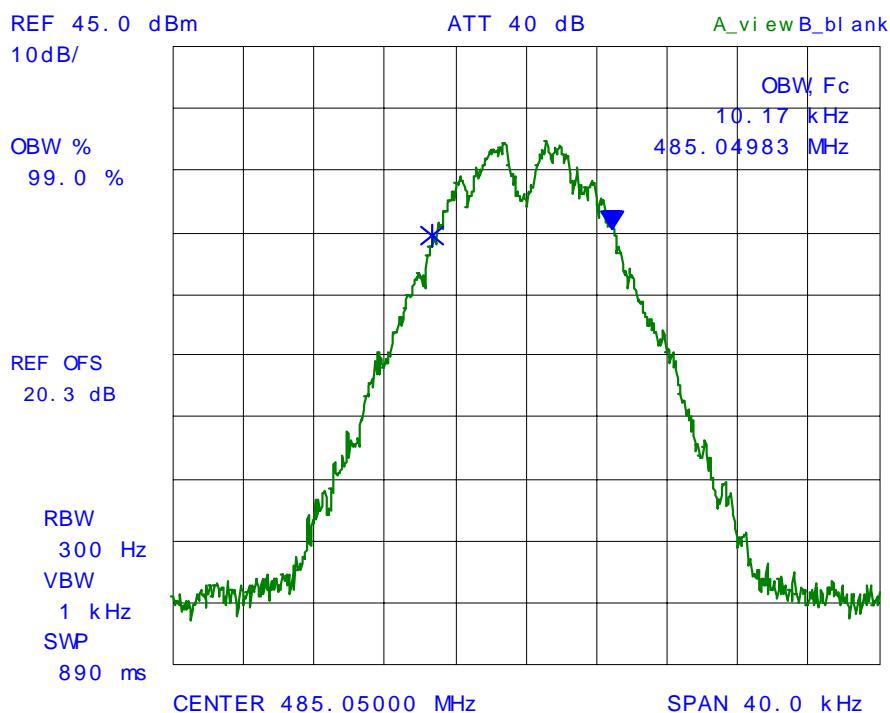

ULTRATECH GROUP OF LABS

3000 Bristol Circle, Oakville, Ontario, Canada L6H 6G4
Tel. #: 905-829-1570, Fax. #: 905-829-8050, Email: vic@ultratech-labs.com, Website: <http://www.ultratech-labs.com>

File #: ICOM-104F90

December 15, 2004

All test results contained in this engineering test report are traceable to National Institute of Standards and Technology (NIST)

Plot 33:
Occupied Bandwidth
Carrier Frequency: 519.95 MHz
Channel Spacing: 25 kHz
Power Level: 4 W
Modulation: FM with 2.5 kHz sine wave signal, scrambler & CTCSS (254.1 Hz)

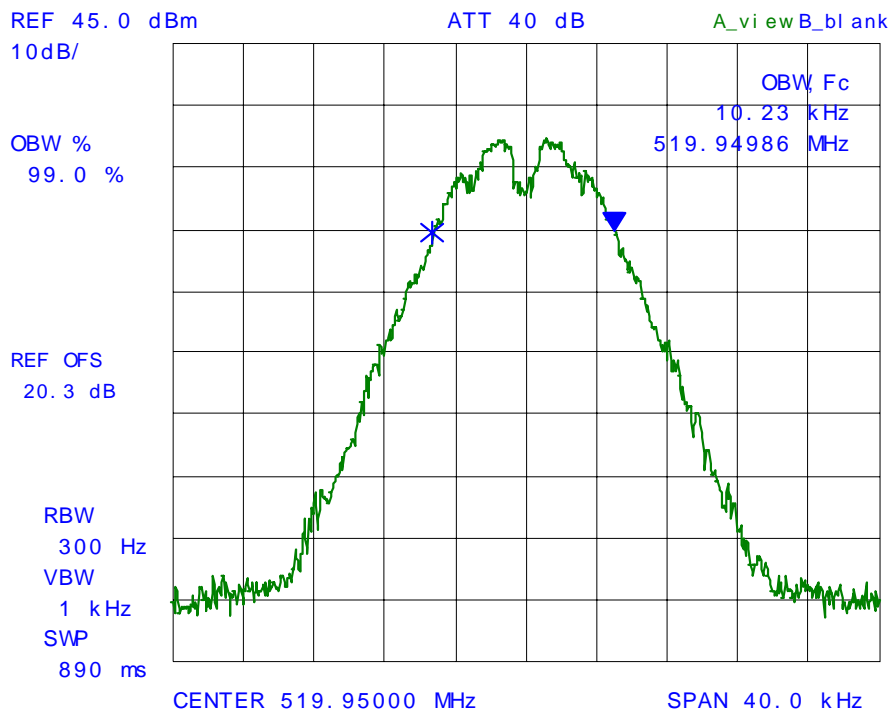

ULTRATECH GROUP OF LABS

3000 Bristol Circle, Oakville, Ontario, Canada L6H 6G4
Tel. #: 905-829-1570, Fax. #: 905-829-8050, Email: vic@ultratech-labs.com, Website: <http://www.ultratech-labs.com>

File #: ICOM-104F90

December 15, 2004

All test results contained in this engineering test report are traceable to National Institute of Standards and Technology (NIST)

6.9.5.2. Emission Masks

Conform. See the following test data plots (34 through 99) for details.

Plot 34:
Emission Mask B
Carrier Frequency: 450.05MHz
Channel Spacing: 25 kHz
Power Level: 4 W
Modulation: FM with 2.5 kHz sine wave

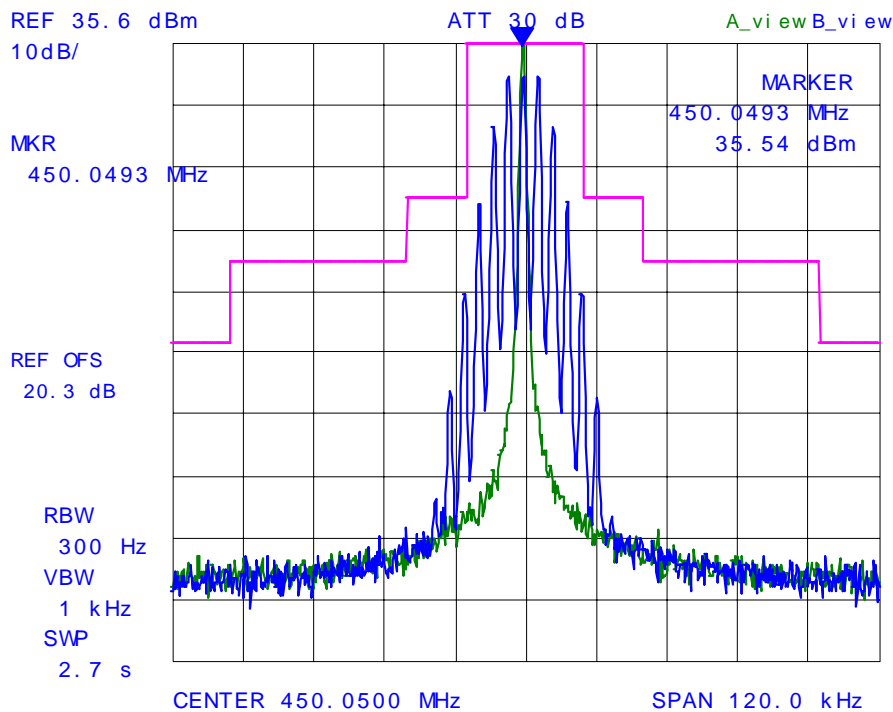

Plot 35:
Emission Mask B
Carrier Frequency: 485.05 MHz
Channel Spacing: 25 kHz
Power Level: 4 W
Modulation: FM with 2.5 kHz sine wave

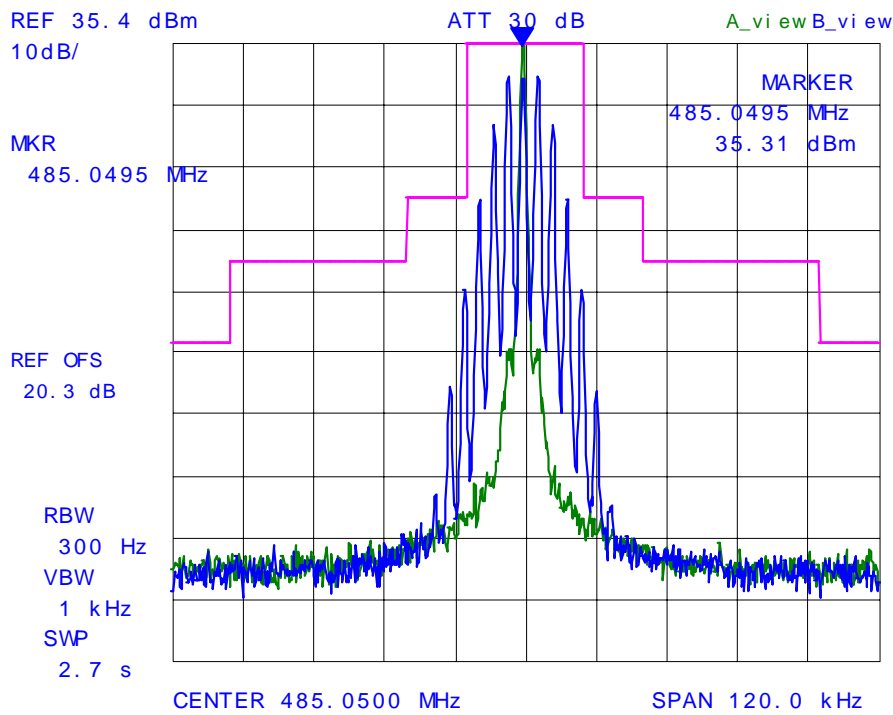

ULTRATECH GROUP OF LABS

3000 Bristol Circle, Oakville, Ontario, Canada L6H 6G4
Tel. #: 905-829-1570, Fax. #: 905-829-8050, Email: vic@ultratech-labs.com, Website: <http://www.ultratech-labs.com>

File #: ICOM-104F90

December 15, 2004

All test results contained in this engineering test report are traceable to National Institute of Standards and Technology (NIST)

Plot 36:
Emission Mask B
Carrier Frequency: 519.95 MHz
Channel Spacing: 25 kHz
Power Level: 4 W
Modulation: FM with 2.5 kHz sine wave

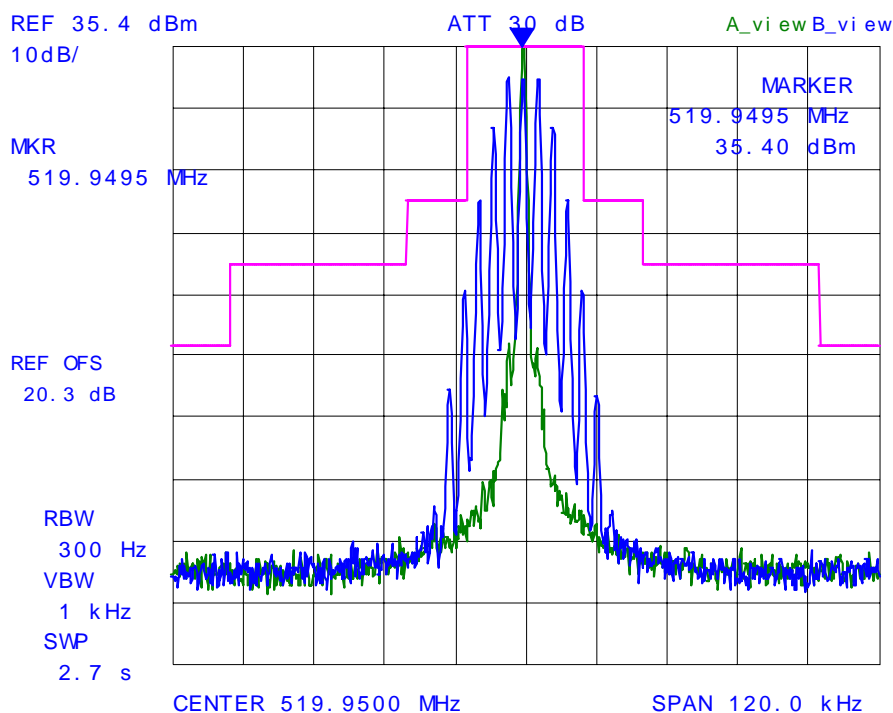

ULTRATECH GROUP OF LABS

3000 Bristol Circle, Oakville, Ontario, Canada L6H 6G4
Tel. #: 905-829-1570, Fax. #: 905-829-8050, Email: vic@ultratech-labs.com, Website: <http://www.ultratech-labs.com>

File #: ICOM-104F90
December 15, 2004

All test results contained in this engineering test report are traceable to National Institute of Standards and Technology (NIST)

Plot 37:
Emission Mask B
Carrier Frequency: 450.05MHz
Channel Spacing: 25 kHz
Power Level: 1 W
Modulation: FM with 2.5 kHz sine wave

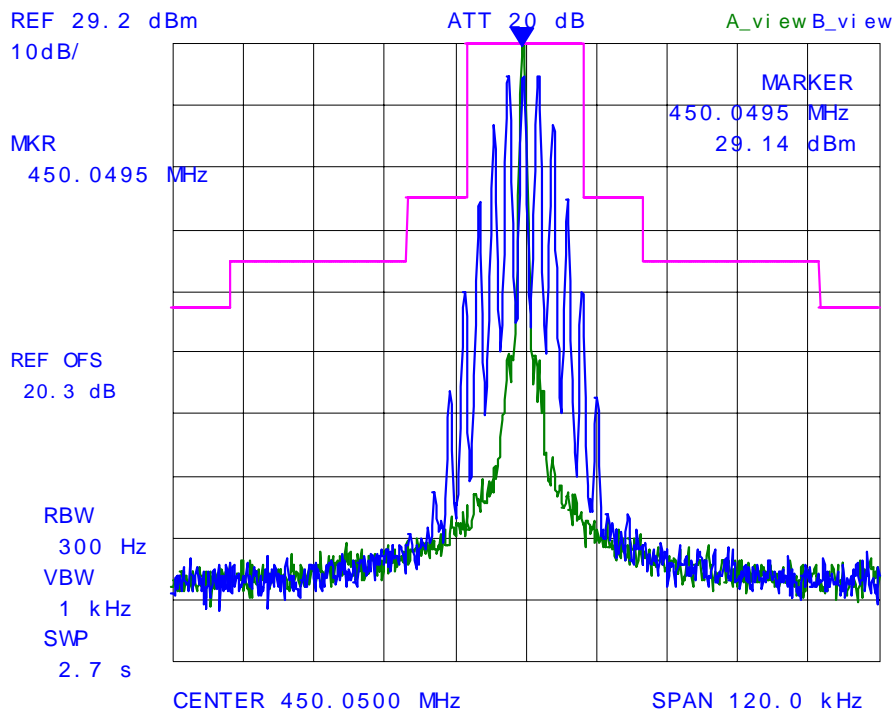

ULTRATECH GROUP OF LABS

3000 Bristol Circle, Oakville, Ontario, Canada L6H 6G4
Tel. #: 905-829-1570, Fax. #: 905-829-8050, Email: vic@ultratech-labs.com, Website: <http://www.ultratech-labs.com>

File #: ICOM-104F90
December 15, 2004

All test results contained in this engineering test report are traceable to National Institute of Standards and Technology (NIST)

Plot 38:
Emission Mask B
Carrier Frequency: 485.05 MHz
Channel Spacing: 25 kHz
Power Level: 1 W
Modulation: FM with 2.5 kHz sine wave

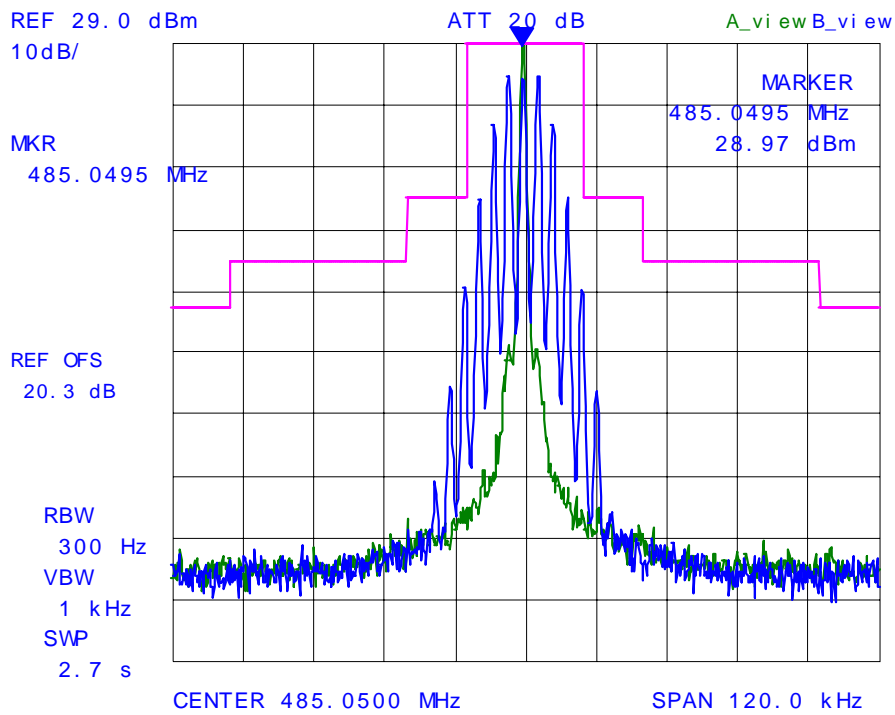

ULTRATECH GROUP OF LABS

3000 Bristol Circle, Oakville, Ontario, Canada L6H 6G4
Tel. #: 905-829-1570, Fax. #: 905-829-8050, Email: vic@ultratech-labs.com, Website: <http://www.ultratech-labs.com>

File #: ICOM-104F90

December 15, 2004

All test results contained in this engineering test report are traceable to National Institute of Standards and Technology (NIST)

Plot 39:
Emission Mask B
Carrier Frequency: 519.95 MHz
Channel Spacing: 25 kHz
Power Level: 1 W
Modulation: FM with 2.5 kHz sine wave

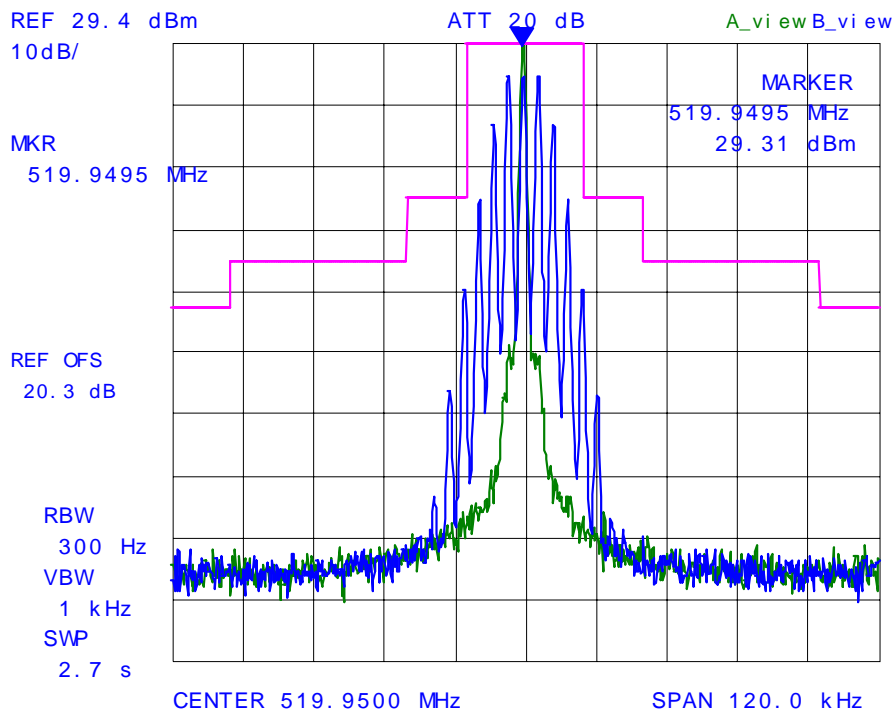

ULTRATECH GROUP OF LABS

3000 Bristol Circle, Oakville, Ontario, Canada L6H 6G4
Tel. #: 905-829-1570, Fax. #: 905-829-8050, Email: vic@ultratech-labs.com, Website: <http://www.ultratech-labs.com>

File #: ICOM-104F90

December 15, 2004

All test results contained in this engineering test report are traceable to National Institute of Standards and Technology (NIST)

Plot 40:
Emission Mask B
Carrier Frequency: 450.05MHz
Channel Spacing: 25 kHz
Power Level: 4 W
Modulation: FM with 2.5 kHz sine wave & CDCSS (754N)

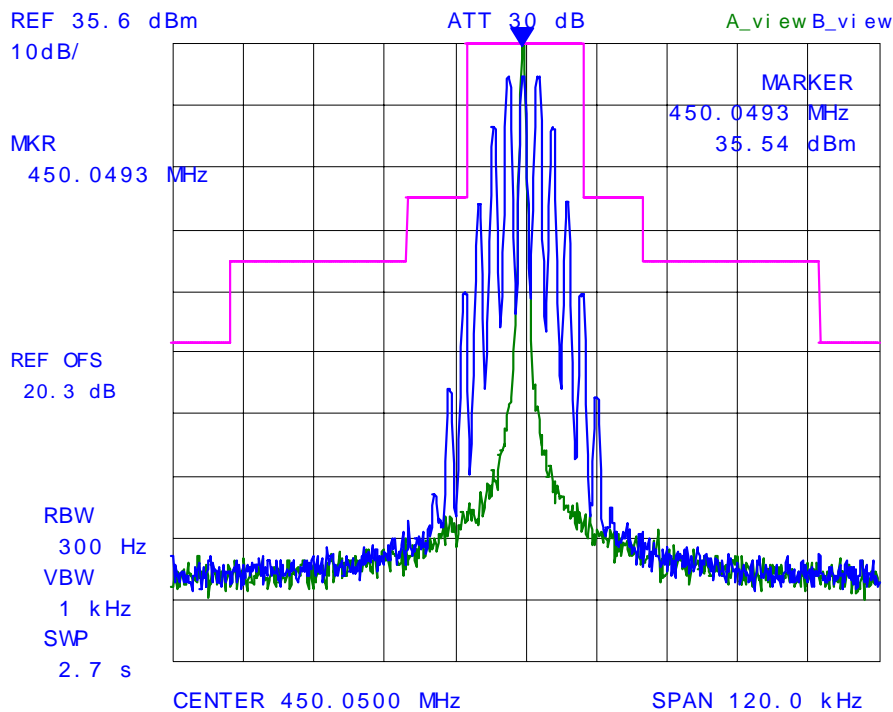

ULTRATECH GROUP OF LABS

3000 Bristol Circle, Oakville, Ontario, Canada L6H 6G4
Tel. #: 905-829-1570, Fax. #: 905-829-8050, Email: vic@ultratech-labs.com, Website: <http://www.ultratech-labs.com>

File #: ICOM-104F90

December 15, 2004

All test results contained in this engineering test report are traceable to National Institute of Standards and Technology (NIST)

Plot 41:
Emission Mask B
Carrier Frequency: 485.05 MHz
Channel Spacing: 25 kHz
Power Level: 4 W
Modulation: FM with 2.5 kHz sine wave & CDCSS (754N)

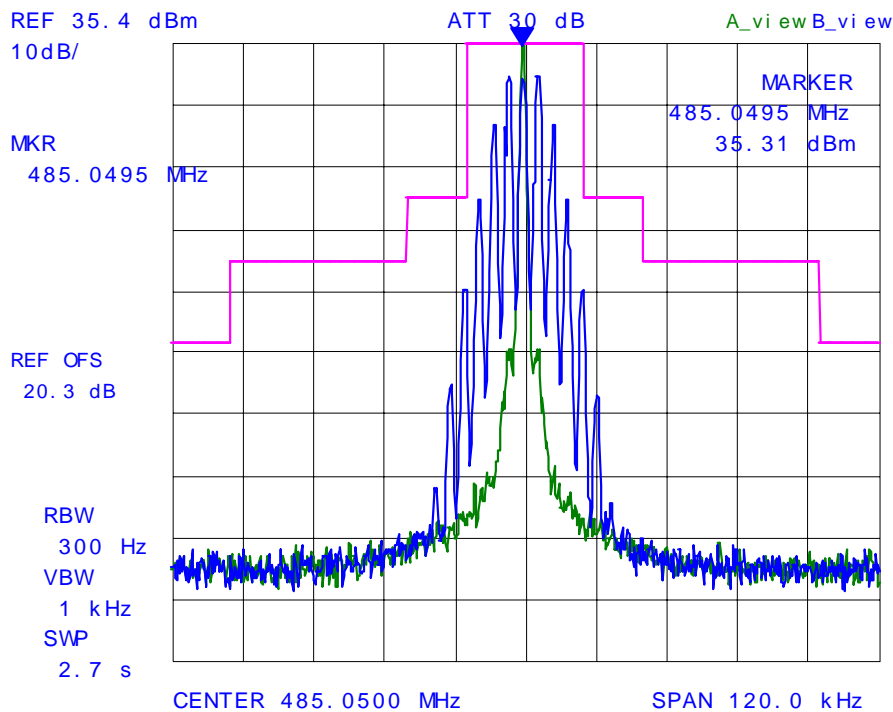

ULTRATECH GROUP OF LABS

3000 Bristol Circle, Oakville, Ontario, Canada L6H 6G4
Tel. #: 905-829-1570, Fax. #: 905-829-8050, Email: vic@ultratech-labs.com, Website: <http://www.ultratech-labs.com>

File #: ICOM-104F90
December 15, 2004

All test results contained in this engineering test report are traceable to National Institute of Standards and Technology (NIST)

Plot 42:
Emission Mask B
Carrier Frequency: 519.95 MHz
Channel Spacing: 25 kHz
Power Level: 4 W
Modulation: FM with 2.5 kHz sine wave & CDCSS (754N)

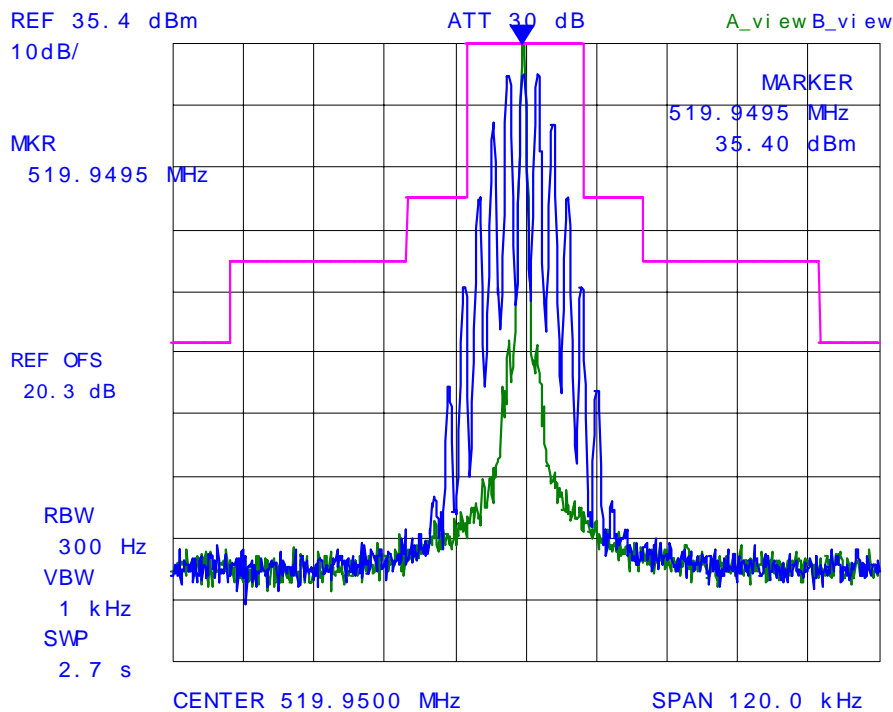

ULTRATECH GROUP OF LABS

3000 Bristol Circle, Oakville, Ontario, Canada L6H 6G4
Tel. #: 905-829-1570, Fax. #: 905-829-8050, Email: vic@ultratech-labs.com, Website: <http://www.ultratech-labs.com>

File #: ICOM-104F90

December 15, 2004

All test results contained in this engineering test report are traceable to National Institute of Standards and Technology (NIST)

Plot 43:
Emission Mask B
Carrier Frequency: 450.05MHz
Channel Spacing: 25 kHz
Power Level: 1 W
Modulation: FM with 2.5 kHz sine wave & CDCSS (754N)

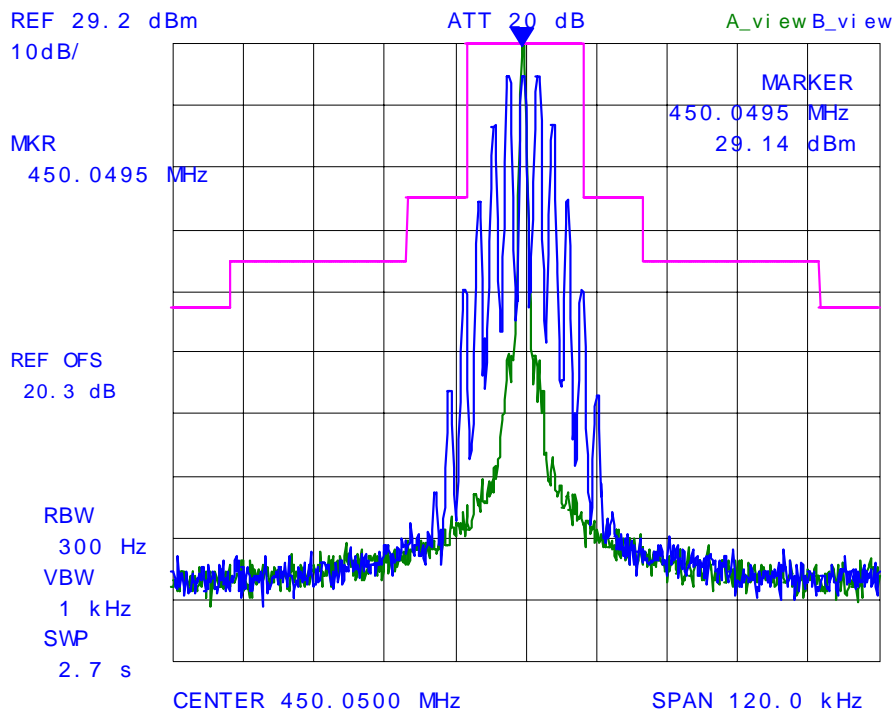

ULTRATECH GROUP OF LABS

3000 Bristol Circle, Oakville, Ontario, Canada L6H 6G4
Tel. #: 905-829-1570, Fax. #: 905-829-8050, Email: vic@ultratech-labs.com, Website: <http://www.ultratech-labs.com>

File #: ICOM-104F90

December 15, 2004

All test results contained in this engineering test report are traceable to National Institute of Standards and Technology (NIST)

Plot 44:
Emission Mask B
Carrier Frequency: 485.05 MHz
Channel Spacing: 25 kHz
Power Level: 1 W
Modulation: FM with 2.5 kHz sine wave & CDCSS (754N)

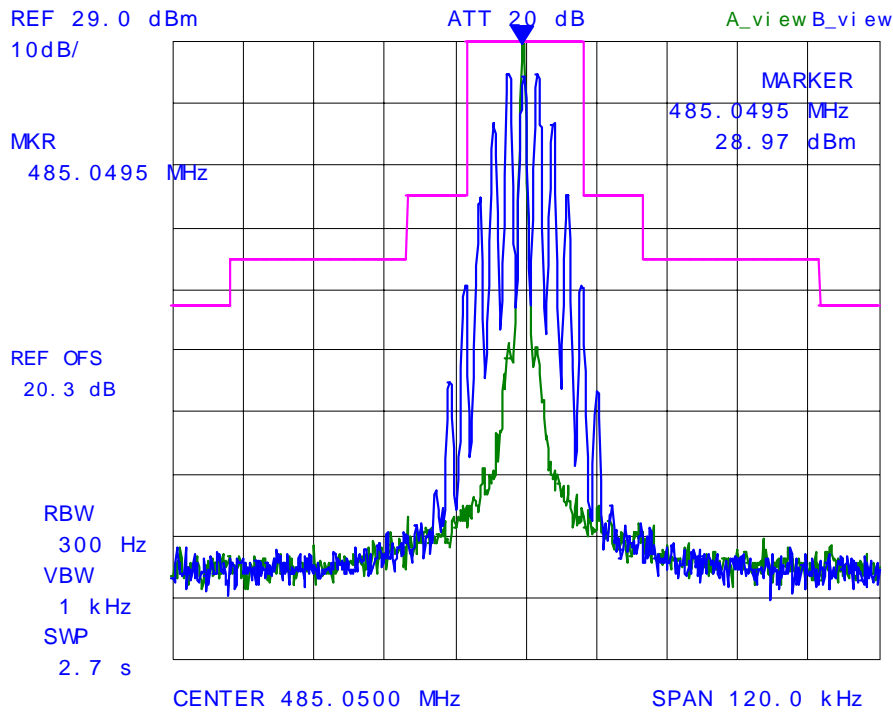

ULTRATECH GROUP OF LABS

3000 Bristol Circle, Oakville, Ontario, Canada L6H 6G4
Tel. #: 905-829-1570, Fax. #: 905-829-8050, Email: vic@ultratech-labs.com, Website: <http://www.ultratech-labs.com>

File #: ICOM-104F90

December 15, 2004

All test results contained in this engineering test report are traceable to National Institute of Standards and Technology (NIST)

Plot 45:
Emission Mask B
Carrier Frequency: 519.95 MHz
Channel Spacing: 25 kHz
Power Level: 1 W
Modulation: FM with 2.5 kHz sine wave & CDCSS (754N)

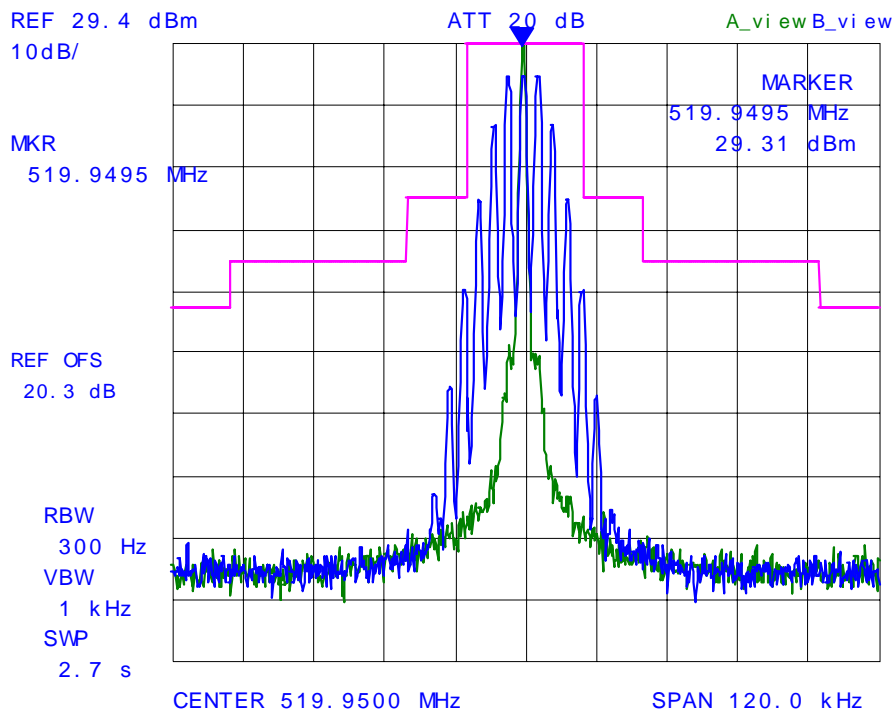

ULTRATECH GROUP OF LABS

3000 Bristol Circle, Oakville, Ontario, Canada L6H 6G4
Tel. #: 905-829-1570, Fax. #: 905-829-8050, Email: vic@ultratech-labs.com, Website: <http://www.ultratech-labs.com>

File #: ICOM-104F90

December 15, 2004

All test results contained in this engineering test report are traceable to National Institute of Standards and Technology (NIST)

Plot 46:
Emission Mask B
Carrier Frequency: 450.05MHz
Channel Spacing: 25 kHz
Power Level: 4 W
Modulation: FM with 2.5 kHz sine wave & CTCSS (254.1Hz)

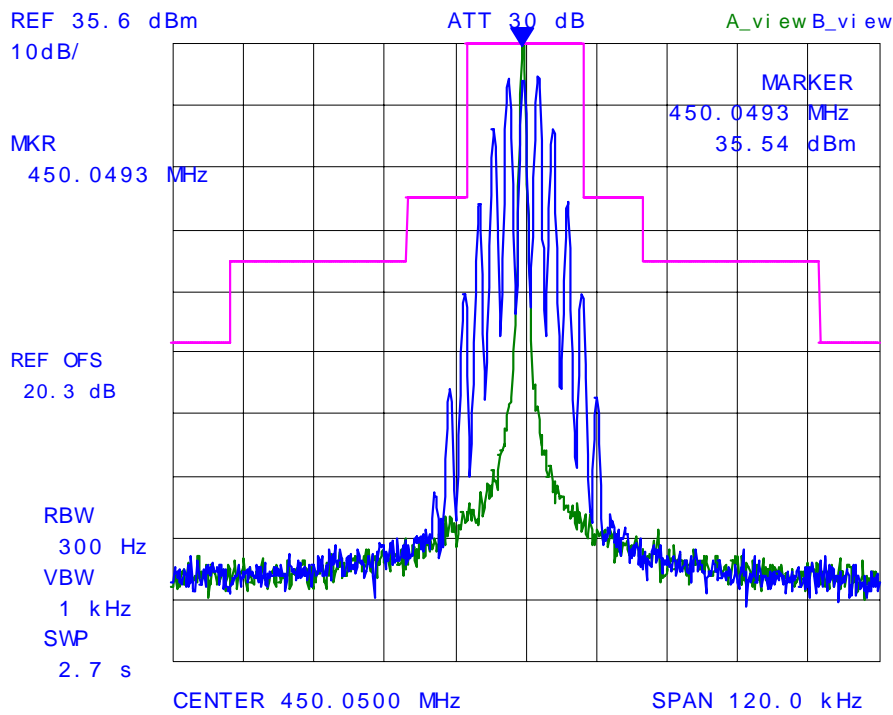

ULTRATECH GROUP OF LABS

3000 Bristol Circle, Oakville, Ontario, Canada L6H 6G4
Tel. #: 905-829-1570, Fax. #: 905-829-8050, Email: vic@ultratech-labs.com, Website: <http://www.ultratech-labs.com>

File #: ICOM-104F90

December 15, 2004

All test results contained in this engineering test report are traceable to National Institute of Standards and Technology (NIST)

Plot 47:
Emission Mask B
Carrier Frequency: 485.05 MHz
Channel Spacing: 25 kHz
Power Level: 4 W
Modulation: FM with 2.5 kHz sine wave & CTCSS (254.1Hz)

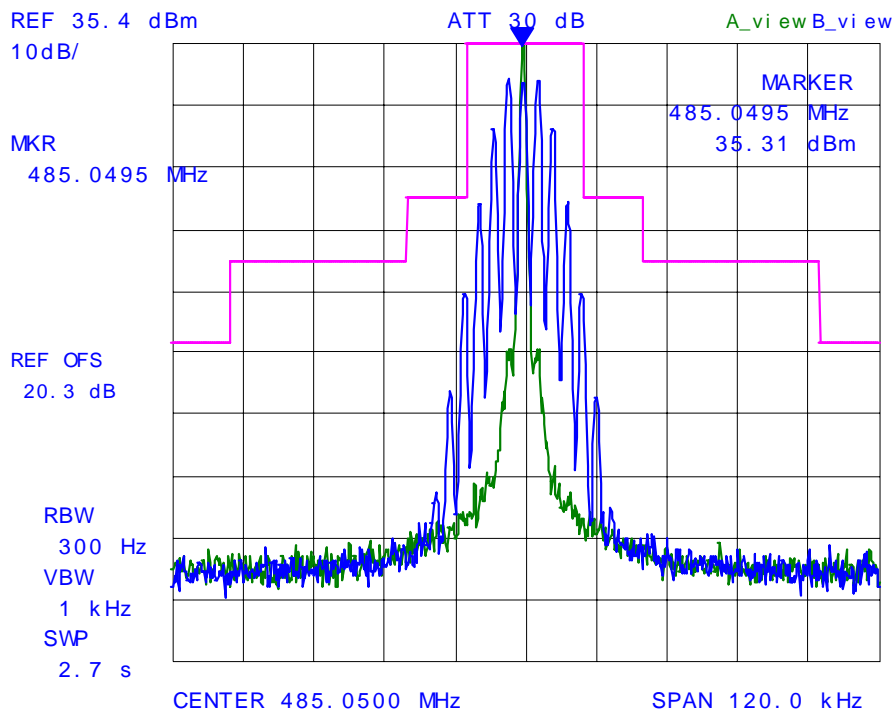

ULTRATECH GROUP OF LABS

3000 Bristol Circle, Oakville, Ontario, Canada L6H 6G4
Tel. #: 905-829-1570, Fax. #: 905-829-8050, Email: vic@ultratech-labs.com, Website: <http://www.ultratech-labs.com>

File #: ICOM-104F90

December 15, 2004

All test results contained in this engineering test report are traceable to National Institute of Standards and Technology (NIST)

Plot 48:
Emission Mask B
Carrier Frequency: 519.95 MHz
Channel Spacing: 25 kHz
Power Level: 4 W
Modulation: FM with 2.5 kHz sine wave & CTCSS (254.1Hz)

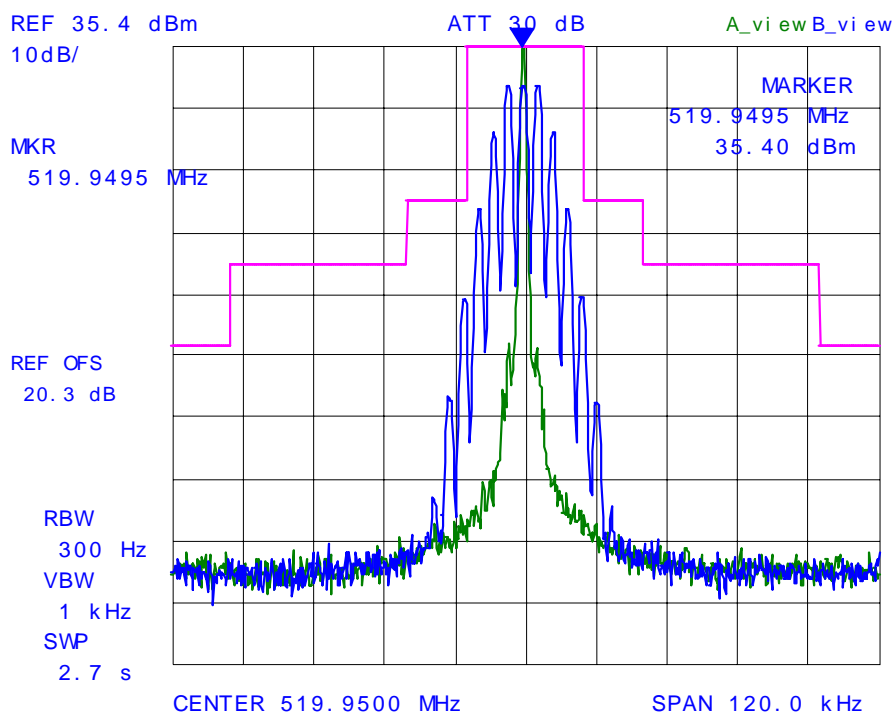

ULTRATECH GROUP OF LABS

3000 Bristol Circle, Oakville, Ontario, Canada L6H 6G4
Tel. #: 905-829-1570, Fax. #: 905-829-8050, Email: vic@ultratech-labs.com, Website: <http://www.ultratech-labs.com>

File #: ICOM-104F90
December 15, 2004

All test results contained in this engineering test report are traceable to National Institute of Standards and Technology (NIST)

Plot 49:
Emission Mask B
Carrier Frequency: 450.05MHz
Channel Spacing: 25 kHz
Power Level: 1 W
Modulation: FM with 2.5 kHz sine wave & CTCSS (254.1Hz)

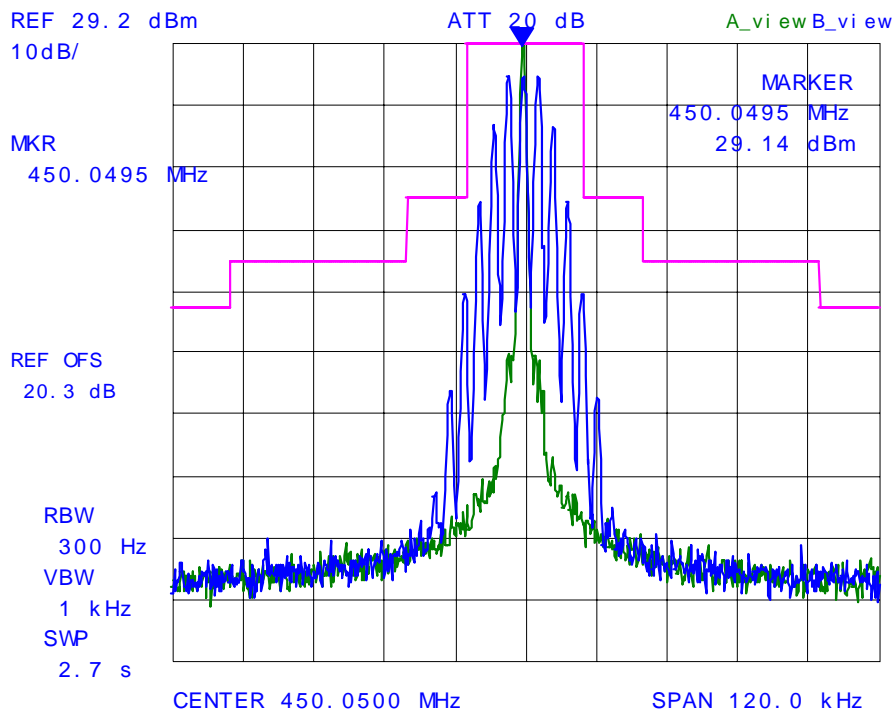

ULTRATECH GROUP OF LABS

3000 Bristol Circle, Oakville, Ontario, Canada L6H 6G4
Tel. #: 905-829-1570, Fax. #: 905-829-8050, Email: vic@ultratech-labs.com, Website: <http://www.ultratech-labs.com>

File #: ICOM-104F90

December 15, 2004

All test results contained in this engineering test report are traceable to National Institute of Standards and Technology (NIST)

Plot 50:
Emission Mask B
Carrier Frequency: 485.05 MHz
Channel Spacing: 25 kHz
Power Level: 1 W
Modulation: FM with 2.5 kHz sine wave & CTCSS (254.1Hz)

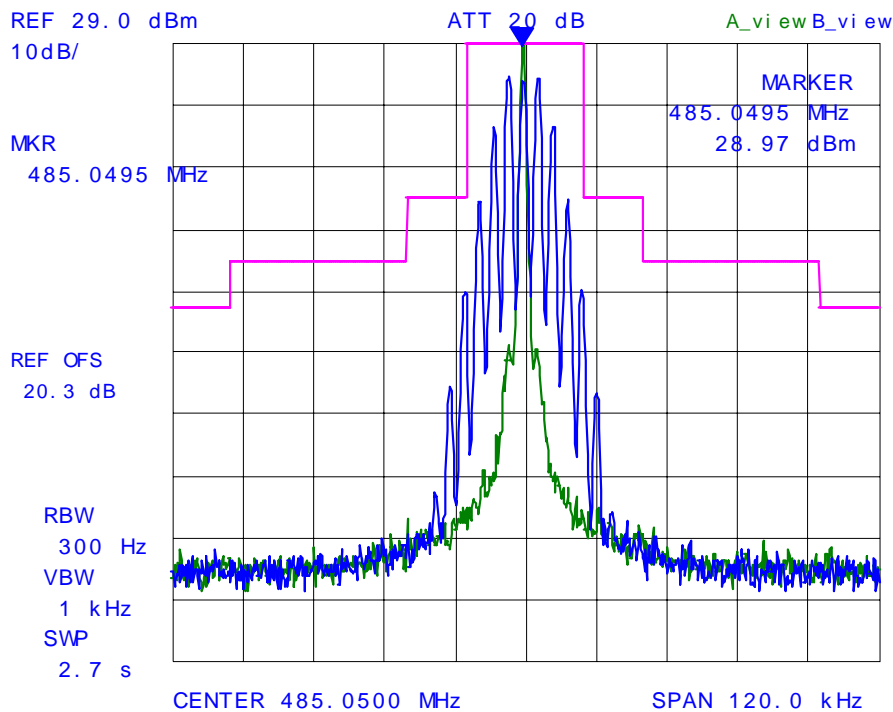

ULTRATECH GROUP OF LABS

3000 Bristol Circle, Oakville, Ontario, Canada L6H 6G4
Tel. #: 905-829-1570, Fax. #: 905-829-8050, Email: vic@ultratech-labs.com, Website: <http://www.ultratech-labs.com>

File #: ICOM-104F90
December 15, 2004

All test results contained in this engineering test report are traceable to National Institute of Standards and Technology (NIST)

Plot 51:
Emission Mask B
Carrier Frequency: 519.95 MHz
Channel Spacing: 25 kHz
Power Level: 1 W
Modulation: FM with 2.5 kHz sine wave & CTCSS (254.1Hz)

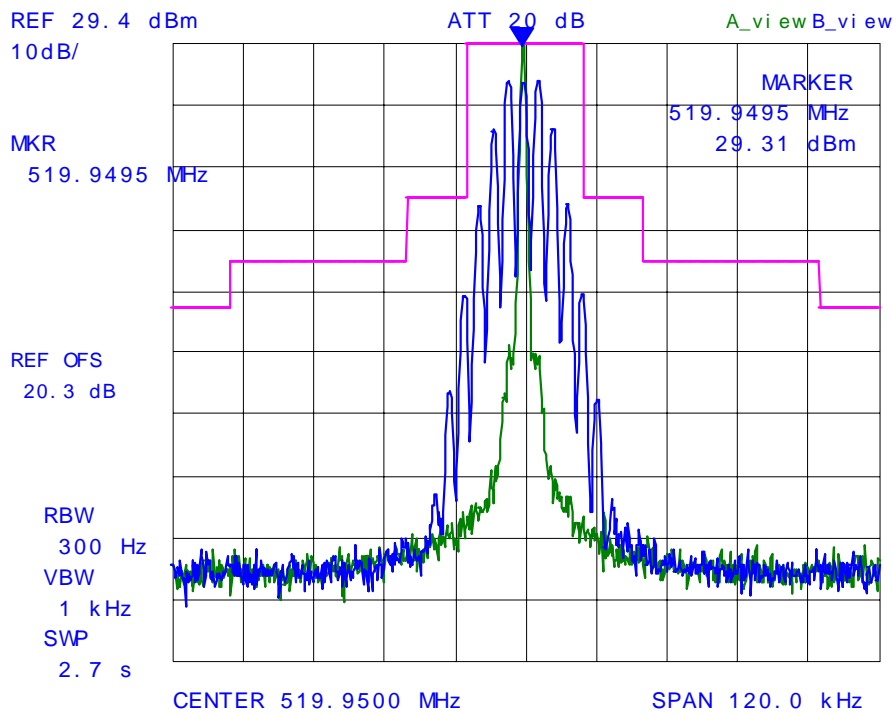

ULTRATECH GROUP OF LABS

3000 Bristol Circle, Oakville, Ontario, Canada L6H 6G4
Tel. #: 905-829-1570, Fax. #: 905-829-8050, Email: vic@ultratech-labs.com, Website: <http://www.ultratech-labs.com>

File #: ICOM-104F90

December 15, 2004

All test results contained in this engineering test report are traceable to National Institute of Standards and Technology (NIST)

Plot 52:
Emission Mask B
Carrier Frequency: 450.05MHz
Channel Spacing: 25 kHz
Power Level: 4 W
Modulation: FM with 2.5 kHz sine wave, scrambler & CDCSS (754N)

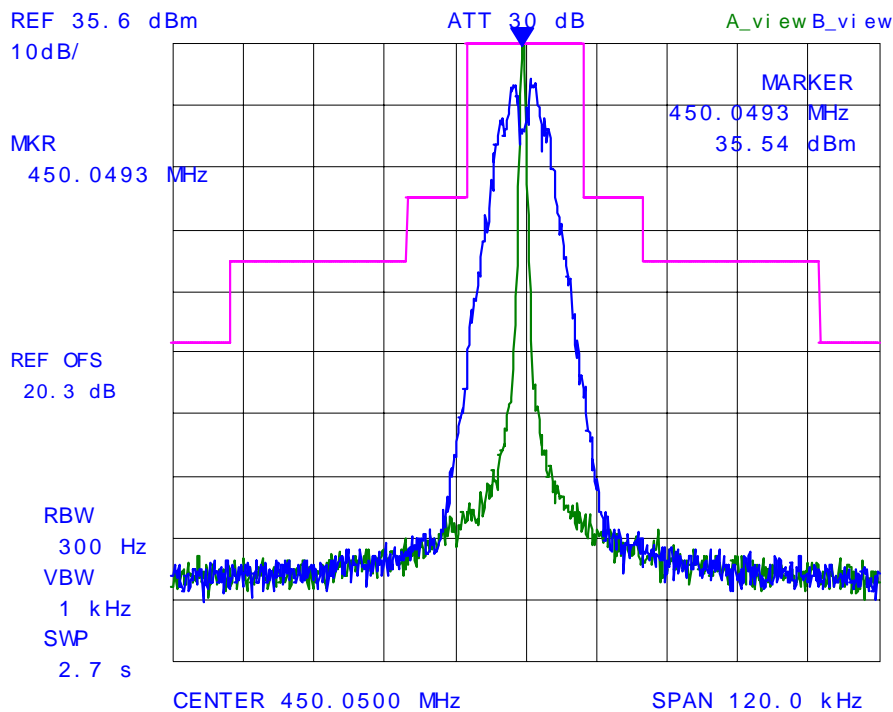

ULTRATECH GROUP OF LABS

3000 Bristol Circle, Oakville, Ontario, Canada L6H 6G4
Tel. #: 905-829-1570, Fax. #: 905-829-8050, Email: vic@ultratech-labs.com, Website: <http://www.ultratech-labs.com>

File #: ICOM-104F90
December 15, 2004

All test results contained in this engineering test report are traceable to National Institute of Standards and Technology (NIST)

Plot 53:
Emission Mask B
Carrier Frequency: 485.05 MHz
Channel Spacing: 25 kHz
Power Level: 4 W
Modulation: FM with 2.5 kHz sine wave, scrambler & CDCSS (754N)

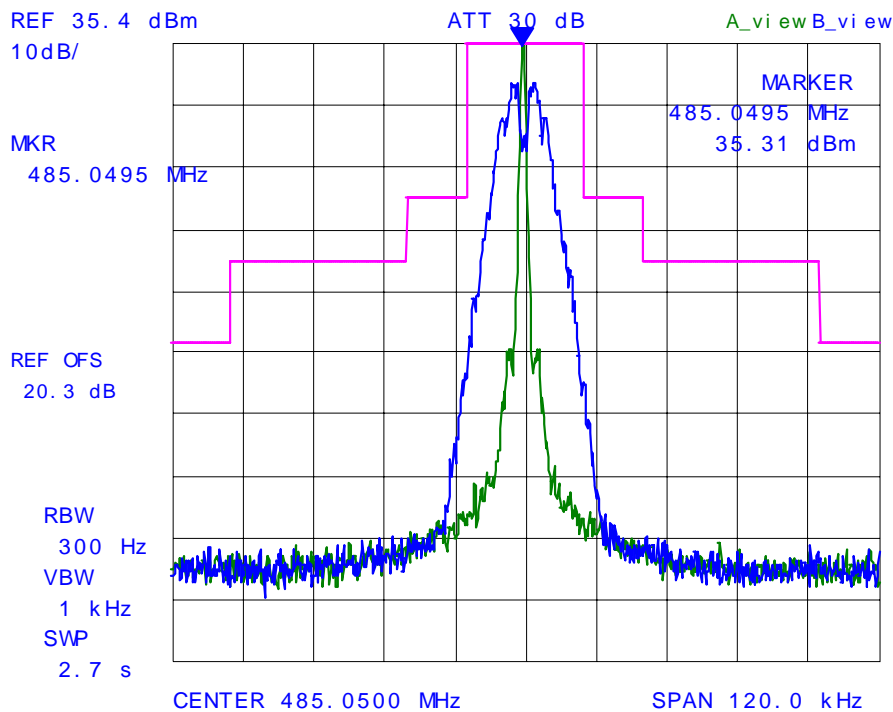

ULTRATECH GROUP OF LABS

3000 Bristol Circle, Oakville, Ontario, Canada L6H 6G4
Tel. #: 905-829-1570, Fax. #: 905-829-8050, Email: vic@ultratech-labs.com, Website: <http://www.ultratech-labs.com>

File #: ICOM-104F90
December 15, 2004

All test results contained in this engineering test report are traceable to National Institute of Standards and Technology (NIST)

Plot 54:
Emission Mask B
Carrier Frequency: 519.95 MHz
Channel Spacing: 25 kHz
Power Level: 4 W
Modulation: FM with 2.5 kHz sine wave, scrambler & CDCSS (754N)

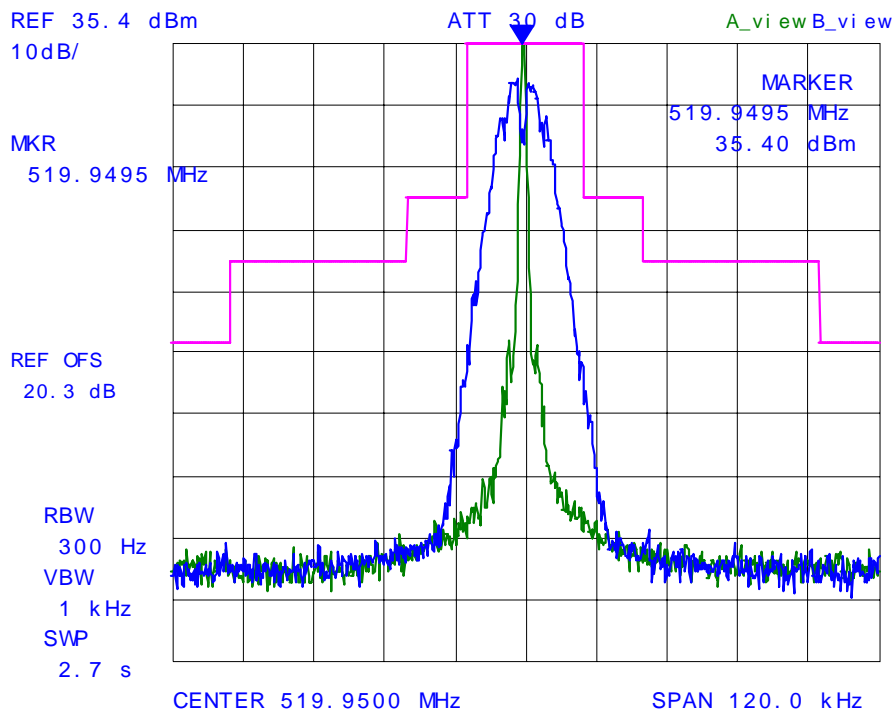

ULTRATECH GROUP OF LABS

3000 Bristol Circle, Oakville, Ontario, Canada L6H 6G4
Tel. #: 905-829-1570, Fax. #: 905-829-8050, Email: vic@ultratech-labs.com, Website: <http://www.ultratech-labs.com>

File #: ICOM-104F90

December 15, 2004

All test results contained in this engineering test report are traceable to National Institute of Standards and Technology (NIST)

Plot 55:
Emission Mask B
Carrier Frequency: 450.05MHz
Channel Spacing: 25 kHz
Power Level: 1 W
Modulation: FM with 2.5 kHz sine wave, scrambler & CDCSS (754N)

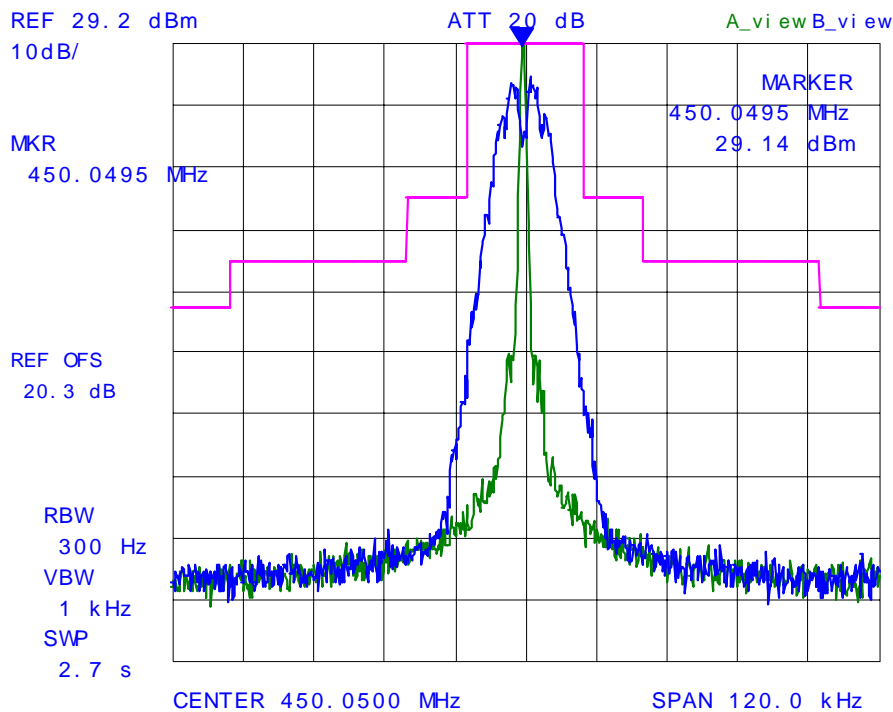

ULTRATECH GROUP OF LABS

3000 Bristol Circle, Oakville, Ontario, Canada L6H 6G4
Tel. #: 905-829-1570, Fax. #: 905-829-8050, Email: vic@ultratech-labs.com, Website: <http://www.ultratech-labs.com>

File #: ICOM-104F90
December 15, 2004

All test results contained in this engineering test report are traceable to National Institute of Standards and Technology (NIST)

Plot 56:
Emission Mask B
Carrier Frequency: 485.05 MHz
Channel Spacing: 25 kHz
Power Level: 1 W
Modulation: FM with 2.5 kHz sine wave, scrambler & CDCSS (754N)

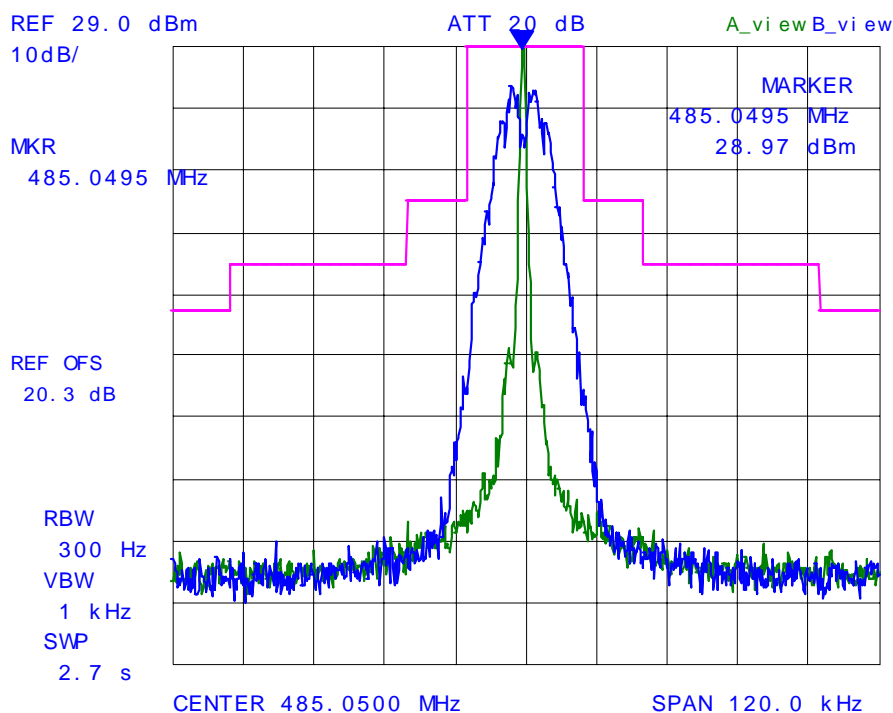

ULTRATECH GROUP OF LABS

3000 Bristol Circle, Oakville, Ontario, Canada L6H 6G4
Tel. #: 905-829-1570, Fax. #: 905-829-8050, Email: vic@ultratech-labs.com, Website: <http://www.ultratech-labs.com>

File #: ICOM-104F90
December 15, 2004

All test results contained in this engineering test report are traceable to National Institute of Standards and Technology (NIST)

Plot 57:
Emission Mask B
Carrier Frequency: 519.95 MHz
Channel Spacing: 25 kHz
Power Level: 1 W
Modulation: FM with 2.5 kHz sine wave, scrambler & CDCSS (754N)

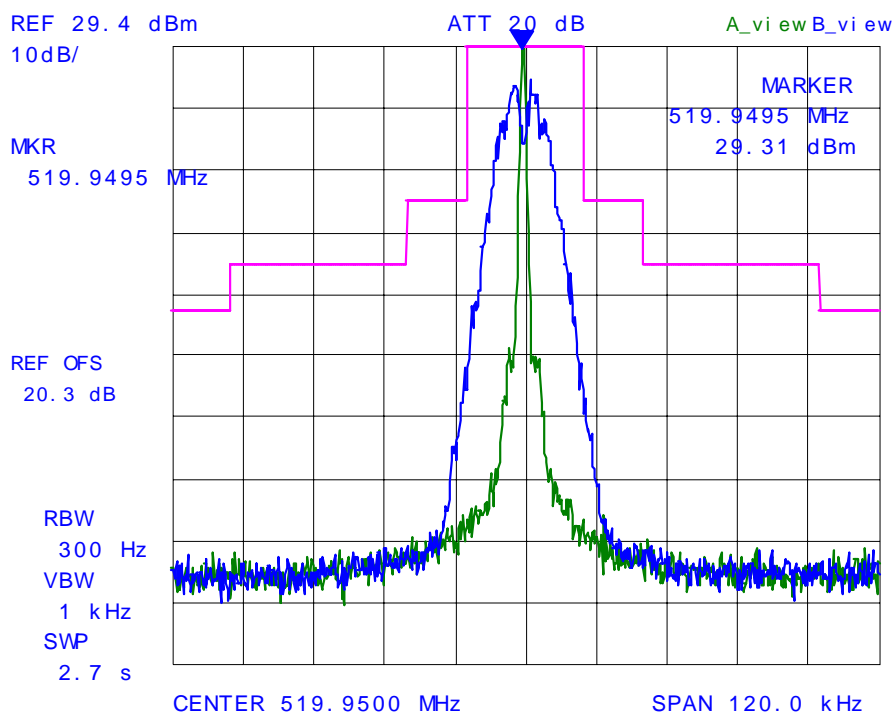

ULTRATECH GROUP OF LABS

3000 Bristol Circle, Oakville, Ontario, Canada L6H 6G4
Tel. #: 905-829-1570, Fax. #: 905-829-8050, Email: vic@ultratech-labs.com, Website: <http://www.ultratech-labs.com>

File #: ICOM-104F90

December 15, 2004

All test results contained in this engineering test report are traceable to National Institute of Standards and Technology (NIST)

Plot 58:
Emission Mask B
Carrier Frequency: 450.05MHz
Channel Spacing: 25 kHz
Power Level: 4 W
Modulation: FM with 2.5 kHz sine wave, scrambler & CTCSS (254.1 Hz)

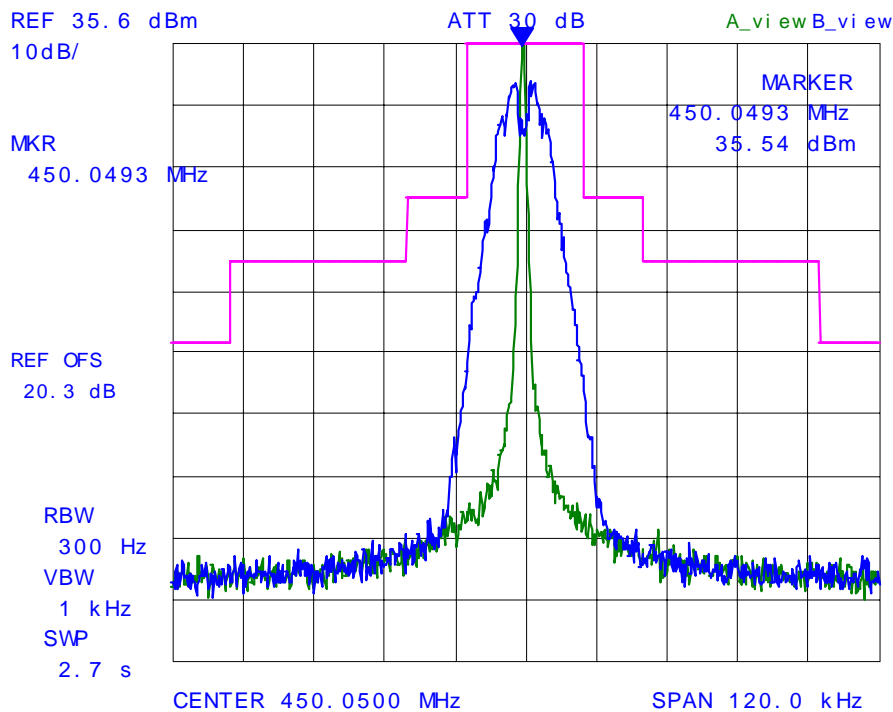

ULTRATECH GROUP OF LABS

3000 Bristol Circle, Oakville, Ontario, Canada L6H 6G4
Tel. #: 905-829-1570, Fax. #: 905-829-8050, Email: vic@ultratech-labs.com, Website: <http://www.ultratech-labs.com>

File #: ICOM-104F90
December 15, 2004

All test results contained in this engineering test report are traceable to National Institute of Standards and Technology (NIST)

Plot 59:
Emission Mask B
Carrier Frequency: 485.05 MHz
Channel Spacing: 25 kHz
Power Level: 4 W
Modulation: FM with 2.5 kHz sine wave, scrambler & CTCSS (254.1 Hz)

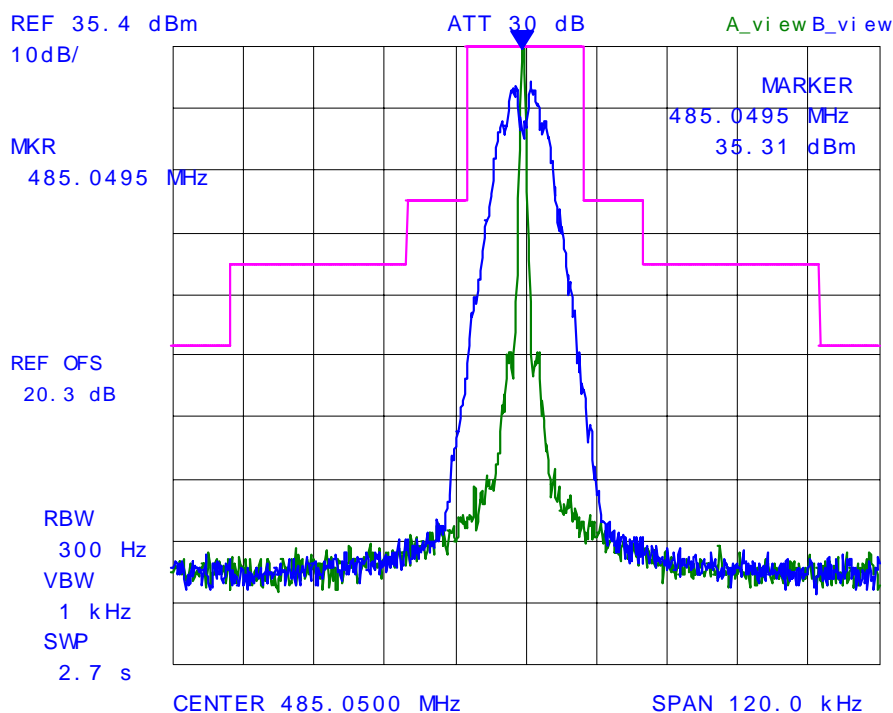

ULTRATECH GROUP OF LABS

3000 Bristol Circle, Oakville, Ontario, Canada L6H 6G4
Tel. #: 905-829-1570, Fax. #: 905-829-8050, Email: vic@ultratech-labs.com, Website: <http://www.ultratech-labs.com>

File #: ICOM-104F90

December 15, 2004

All test results contained in this engineering test report are traceable to National Institute of Standards and Technology (NIST)

Plot 60:
Emission Mask B
Carrier Frequency: 519.95 MHz
Channel Spacing: 25 kHz
Power Level: 4 W
Modulation: FM with 2.5 kHz sine wave, scrambler & CTCSS (254.1 Hz)

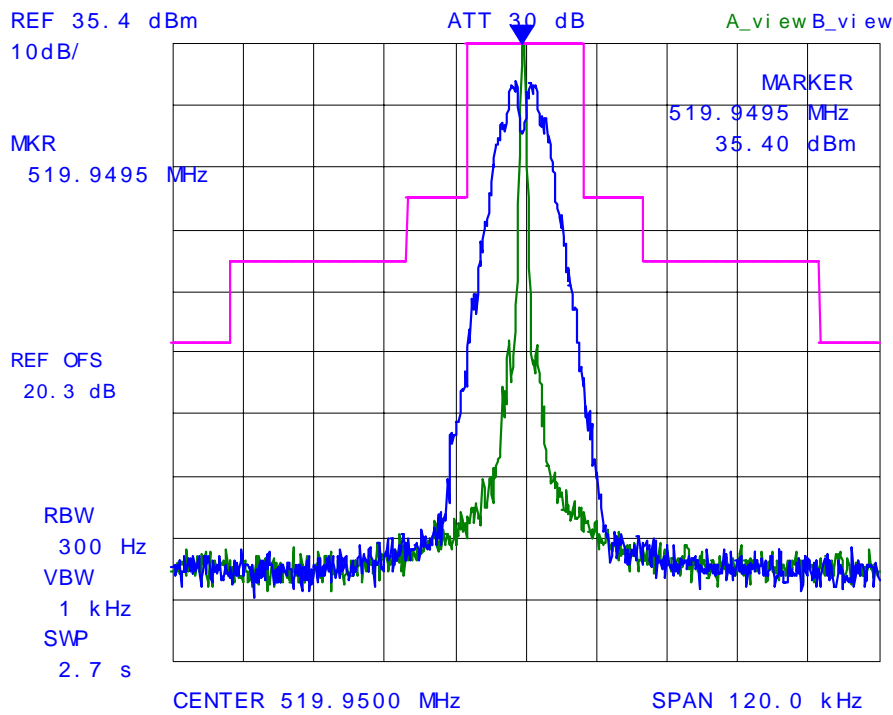

ULTRATECH GROUP OF LABS

3000 Bristol Circle, Oakville, Ontario, Canada L6H 6G4
Tel. #: 905-829-1570, Fax. #: 905-829-8050, Email: vic@ultratech-labs.com, Website: <http://www.ultratech-labs.com>

File #: ICOM-104F90

December 15, 2004

All test results contained in this engineering test report are traceable to National Institute of Standards and Technology (NIST)

Plot 61:
Emission Mask B
Carrier Frequency: 450.05MHz
Channel Spacing: 25 kHz
Power Level: 1 W
Modulation: FM with 2.5 kHz sine wave, scrambler & CTCSS (254.1 Hz)

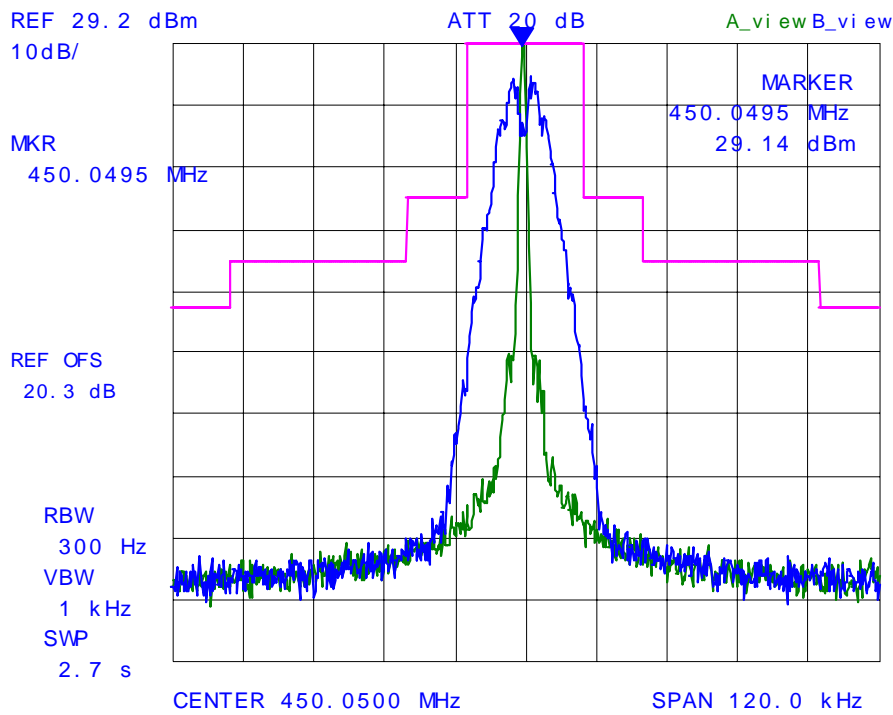

ULTRATECH GROUP OF LABS

3000 Bristol Circle, Oakville, Ontario, Canada L6H 6G4
Tel. #: 905-829-1570, Fax. #: 905-829-8050, Email: vic@ultratech-labs.com, Website: <http://www.ultratech-labs.com>

File #: ICOM-104F90

December 15, 2004

All test results contained in this engineering test report are traceable to National Institute of Standards and Technology (NIST)

Plot 62:
Emission Mask B
Carrier Frequency: 485.05 MHz
Channel Spacing: 25 kHz
Power Level: 1 W
Modulation: FM with 2.5 kHz sine wave, scrambler & CTCSS (254.1 Hz)

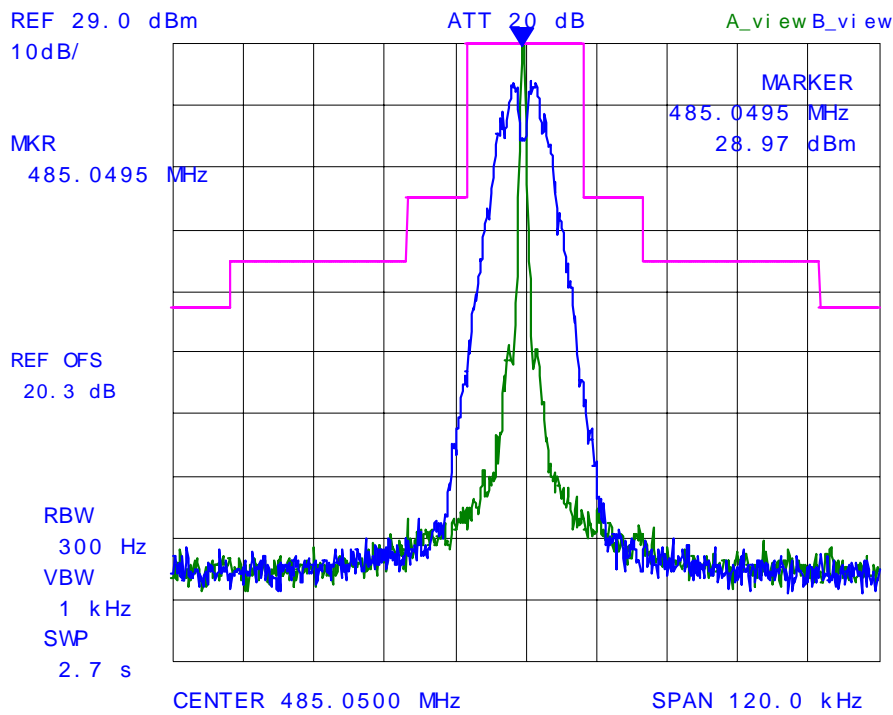

ULTRATECH GROUP OF LABS

3000 Bristol Circle, Oakville, Ontario, Canada L6H 6G4
Tel. #: 905-829-1570, Fax. #: 905-829-8050, Email: vic@ultratech-labs.com, Website: <http://www.ultratech-labs.com>

File #: ICOM-104F90

December 15, 2004

All test results contained in this engineering test report are traceable to National Institute of Standards and Technology (NIST)

Plot 63:
Emission Mask B
Carrier Frequency: 519.95 MHz
Channel Spacing: 25 kHz
Power Level: 1 W
Modulation: FM with 2.5 kHz sine wave, scrambler & CTCSS (254.1 Hz)

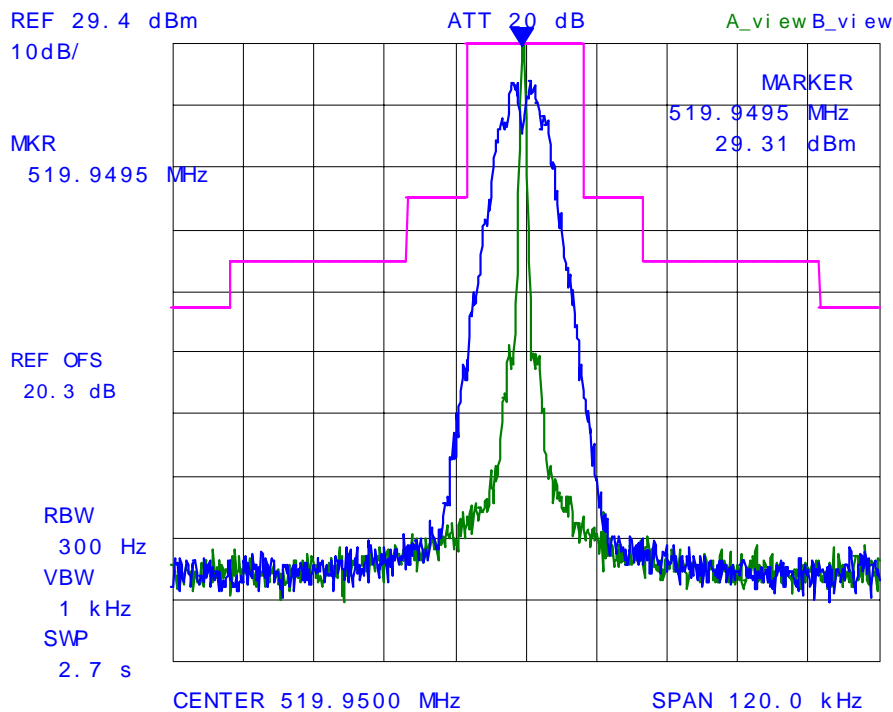

ULTRATECH GROUP OF LABS

3000 Bristol Circle, Oakville, Ontario, Canada L6H 6G4
Tel. #: 905-829-1570, Fax. #: 905-829-8050, Email: vic@ultratech-labs.com, Website: <http://www.ultratech-labs.com>

File #: ICOM-104F90

December 15, 2004

All test results contained in this engineering test report are traceable to National Institute of Standards and Technology (NIST)

Plot 64:
Emission Mask D
Carrier Frequency: 450.05MHz
Channel Spacing: 12.5 kHz
Power Level: 4 W
Modulation: FM with 2.5 kHz sine wave

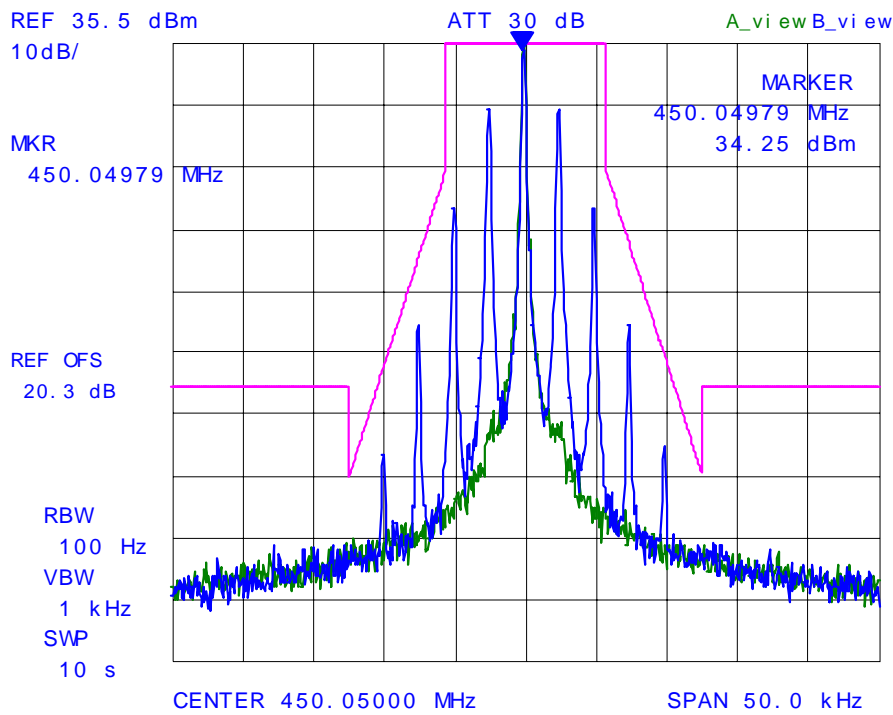

ULTRATECH GROUP OF LABS

3000 Bristol Circle, Oakville, Ontario, Canada L6H 6G4
Tel. #: 905-829-1570, Fax. #: 905-829-8050, Email: vic@ultratech-labs.com, Website: <http://www.ultratech-labs.com>

File #: ICOM-104F90

December 15, 2004

All test results contained in this engineering test report are traceable to National Institute of Standards and Technology (NIST)

Plot 65:
Emission Mask D
Carrier Frequency: 485.05 MHz
Channel Spacing: 12.5 kHz
Power Level: 4 W
Modulation: FM with 2.5 kHz sine wave

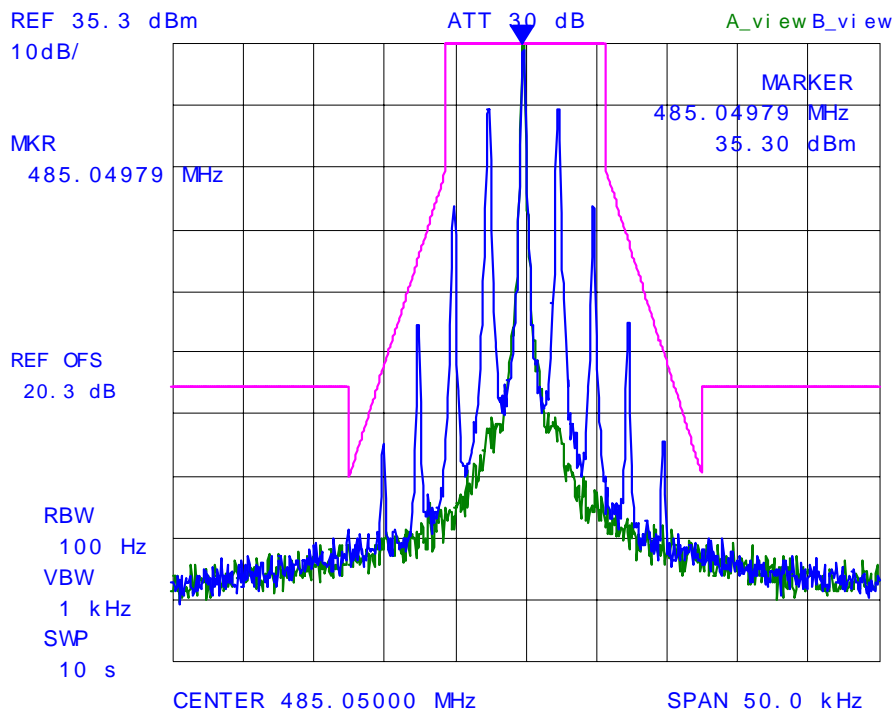

ULTRATECH GROUP OF LABS

3000 Bristol Circle, Oakville, Ontario, Canada L6H 6G4
Tel. #: 905-829-1570, Fax. #: 905-829-8050, Email: vic@ultratech-labs.com, Website: <http://www.ultratech-labs.com>

File #: ICOM-104F90

December 15, 2004

All test results contained in this engineering test report are traceable to National Institute of Standards and Technology (NIST)

Plot 66:
Emission Mask D
Carrier Frequency: 519.95 MHz
Channel Spacing: 12.5 kHz
Power Level: 4 W
Modulation: FM with 2.5 kHz sine wave

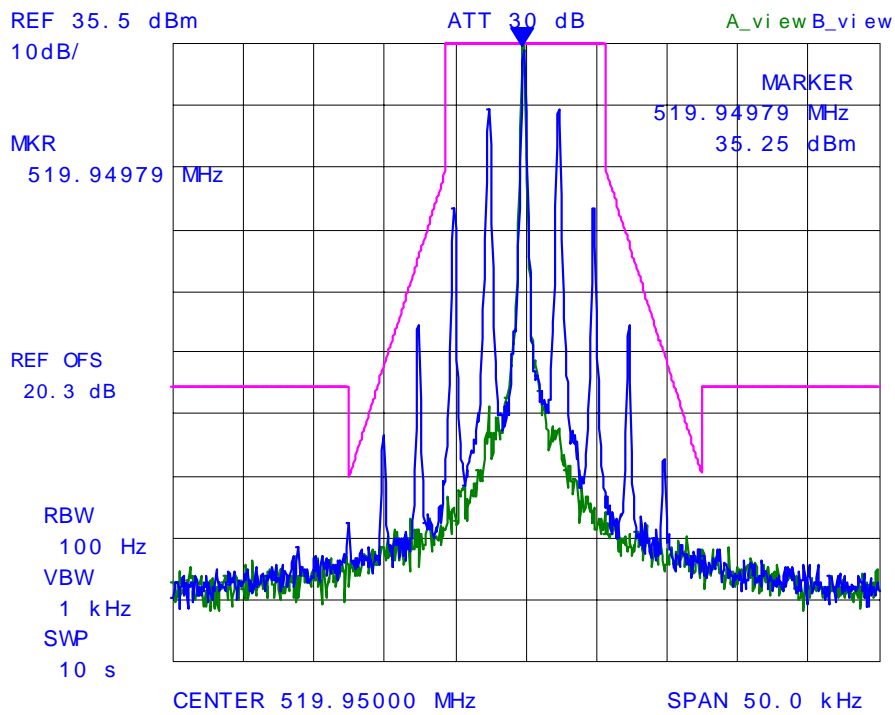

ULTRATECH GROUP OF LABS

3000 Bristol Circle, Oakville, Ontario, Canada L6H 6G4
Tel. #: 905-829-1570, Fax. #: 905-829-8050, Email: vic@ultratech-labs.com, Website: <http://www.ultratech-labs.com>

File #: ICOM-104F90

December 15, 2004

All test results contained in this engineering test report are traceable to National Institute of Standards and Technology (NIST)

Plot 67:
Emission Mask D
Carrier Frequency: 450.05MHz
Channel Spacing: 12.5 kHz
Power Level: 1 W
Modulation: FM with 2.5 kHz sine wave

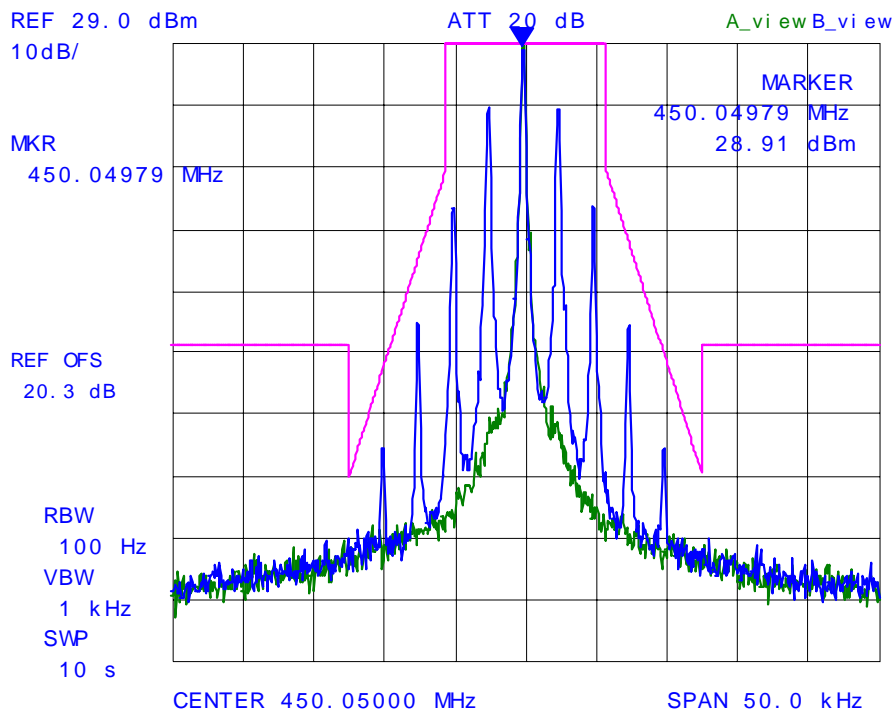

ULTRATECH GROUP OF LABS

3000 Bristol Circle, Oakville, Ontario, Canada L6H 6G4
Tel. #: 905-829-1570, Fax. #: 905-829-8050, Email: vic@ultratech-labs.com, Website: <http://www.ultratech-labs.com>

File #: ICOM-104F90

December 15, 2004

All test results contained in this engineering test report are traceable to National Institute of Standards and Technology (NIST)

Plot 68:
Emission Mask D
Carrier Frequency: 485.05 MHz
Channel Spacing: 12.5 kHz
Power Level: 1 W
Modulation: FM with 2.5 kHz sine wave

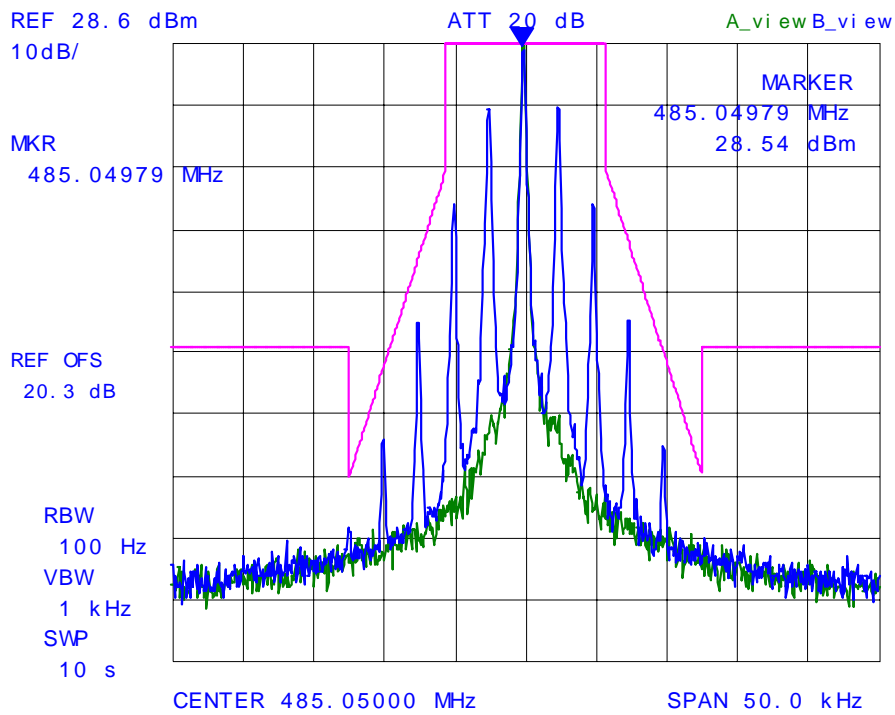

ULTRATECH GROUP OF LABS

3000 Bristol Circle, Oakville, Ontario, Canada L6H 6G4
Tel. #: 905-829-1570, Fax. #: 905-829-8050, Email: vic@ultratech-labs.com, Website: <http://www.ultratech-labs.com>

File #: ICOM-104F90

December 15, 2004

All test results contained in this engineering test report are traceable to National Institute of Standards and Technology (NIST)

Plot 69:
Emission Mask D
Carrier Frequency: 519.95 MHz
Channel Spacing: 12.5 kHz
Power Level: 1 W
Modulation: FM with 2.5 kHz sine wave

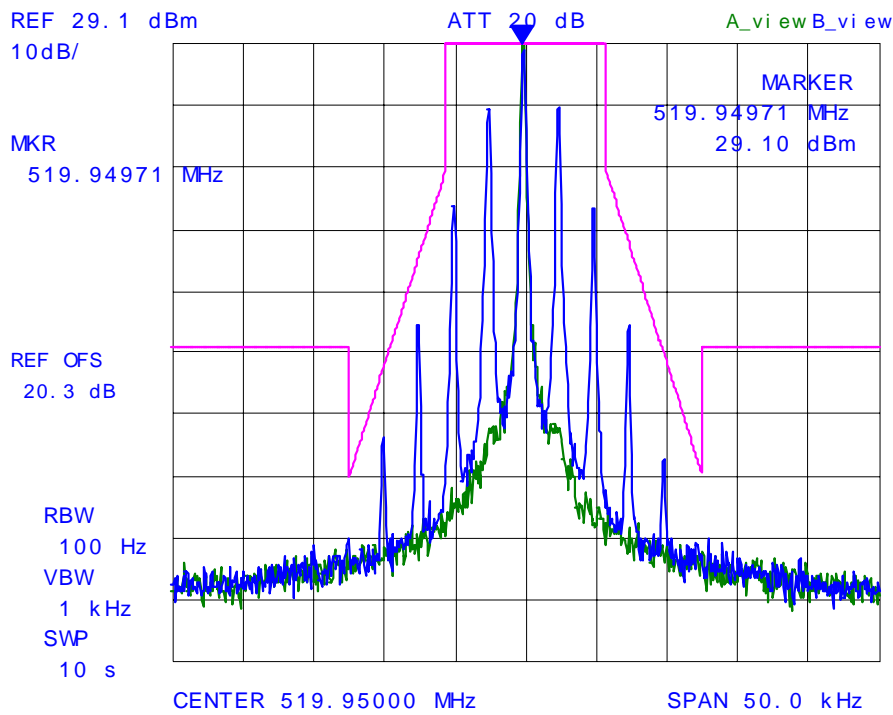

ULTRATECH GROUP OF LABS

3000 Bristol Circle, Oakville, Ontario, Canada L6H 6G4
Tel. #: 905-829-1570, Fax. #: 905-829-8050, Email: vic@ultratech-labs.com, Website: <http://www.ultratech-labs.com>

File #: ICOM-104F90

December 15, 2004

All test results contained in this engineering test report are traceable to National Institute of Standards and Technology (NIST)

Plot 70:
Emission Mask D
Carrier Frequency: 450.05MHz
Channel Spacing: 12.5 kHz
Power Level: 4 W
Modulation: FM with 2.5 kHz sine wave & CDCSS (754N)

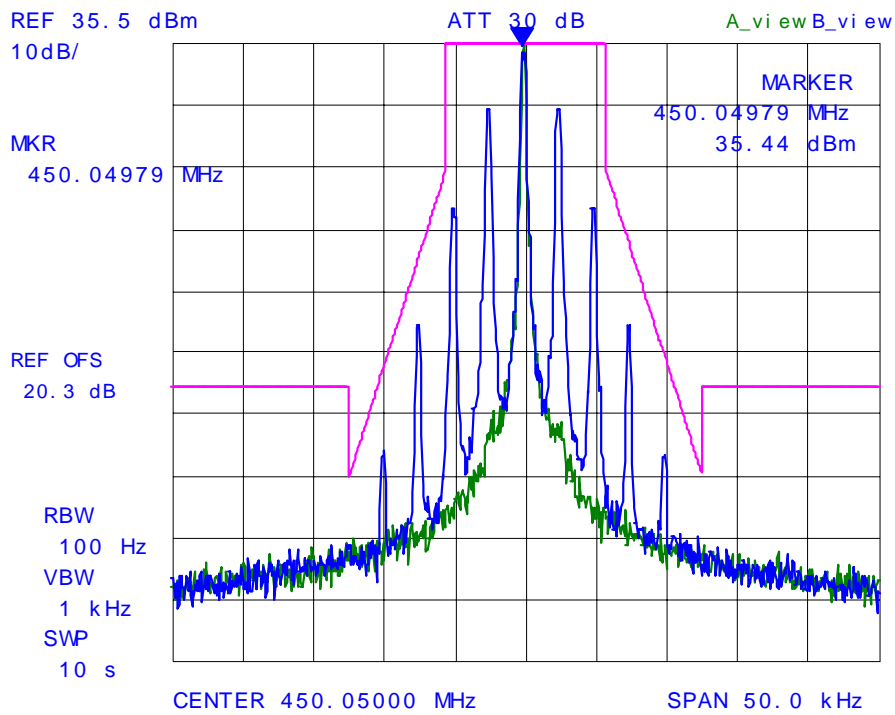

ULTRATECH GROUP OF LABS

3000 Bristol Circle, Oakville, Ontario, Canada L6H 6G4
Tel. #: 905-829-1570, Fax. #: 905-829-8050, Email: vic@ultratech-labs.com, Website: <http://www.ultratech-labs.com>

File #: ICOM-104F90

December 15, 2004

All test results contained in this engineering test report are traceable to National Institute of Standards and Technology (NIST)

Plot 71:
Emission Mask D
Carrier Frequency: 485.05 MHz
Channel Spacing: 12.5 kHz
Power Level: 4 W
Modulation: FM with 2.5 kHz sine wave & CDCSS (754N)

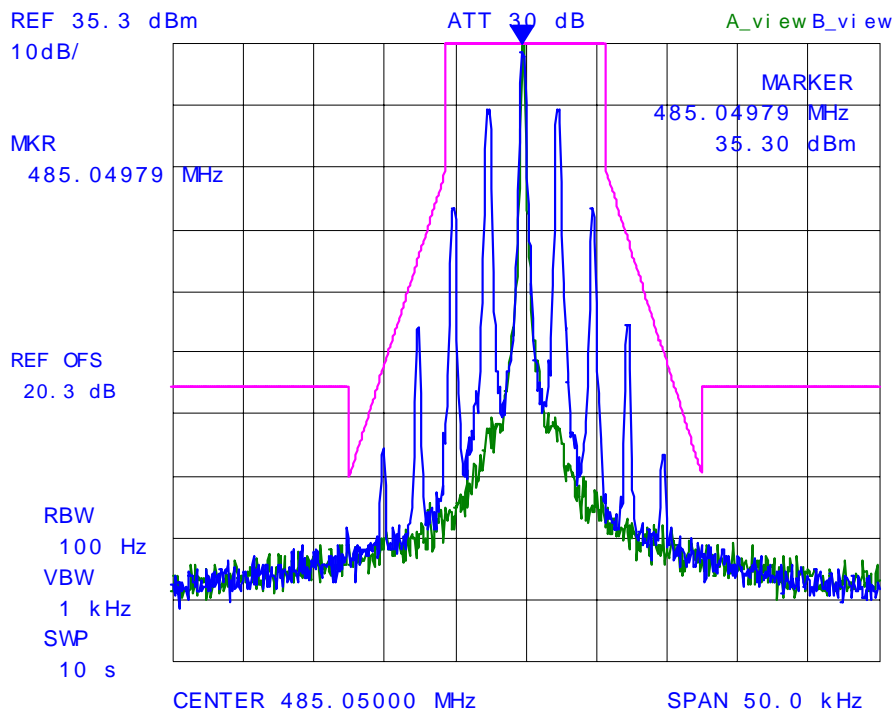

ULTRATECH GROUP OF LABS

3000 Bristol Circle, Oakville, Ontario, Canada L6H 6G4
Tel. #: 905-829-1570, Fax. #: 905-829-8050, Email: vic@ultratech-labs.com, Website: <http://www.ultratech-labs.com>

File #: ICOM-104F90

December 15, 2004

All test results contained in this engineering test report are traceable to National Institute of Standards and Technology (NIST)

Plot 72:
Emission Mask D
Carrier Frequency: 519.95 MHz
Channel Spacing: 12.5 kHz
Power Level: 4 W
Modulation: FM with 2.5 kHz sine wave & CDCSS (754N)

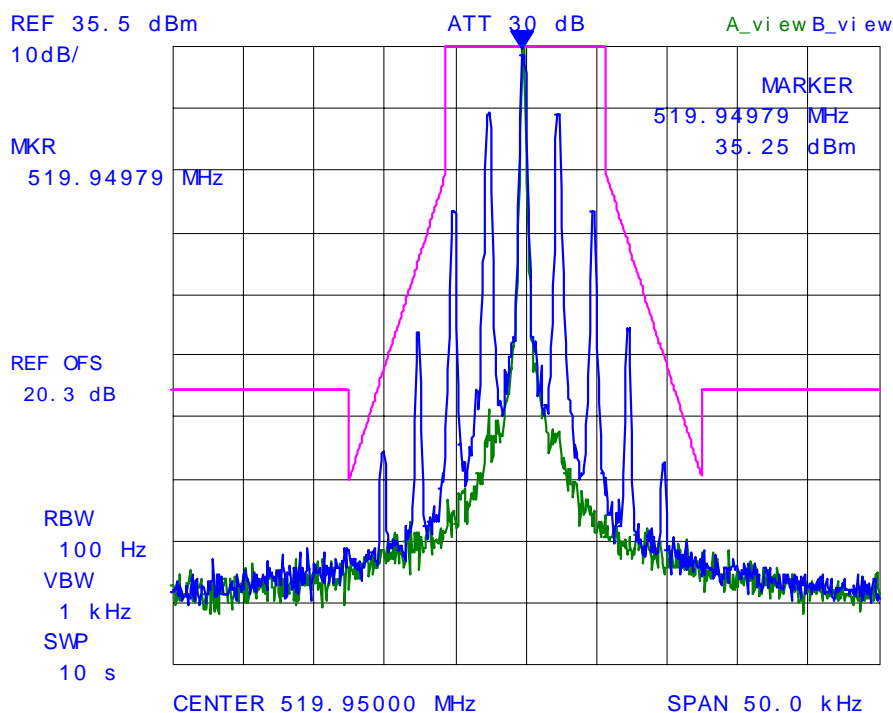

ULTRATECH GROUP OF LABS

3000 Bristol Circle, Oakville, Ontario, Canada L6H 6G4
Tel. #: 905-829-1570, Fax. #: 905-829-8050, Email: vic@ultratech-labs.com, Website: <http://www.ultratech-labs.com>

File #: ICOM-104F90

December 15, 2004

All test results contained in this engineering test report are traceable to National Institute of Standards and Technology (NIST)

Plot 73:
Emission Mask D
Carrier Frequency: 450.05MHz
Channel Spacing: 12.5 kHz
Power Level: 1 W
Modulation: FM with 2.5 kHz sine wave & CDCSS (754N)

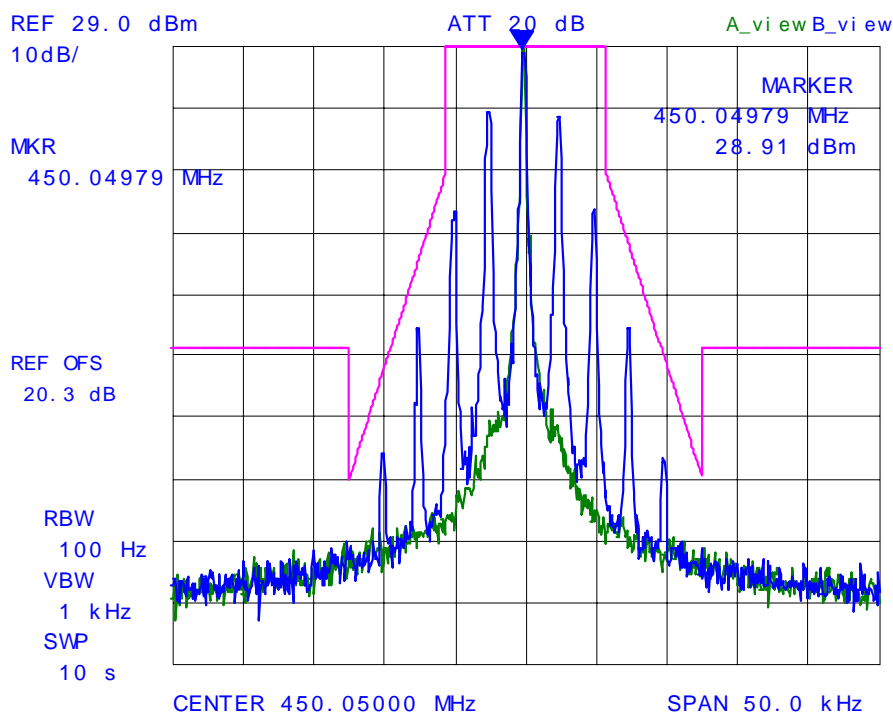

ULTRATECH GROUP OF LABS

3000 Bristol Circle, Oakville, Ontario, Canada L6H 6G4
Tel. #: 905-829-1570, Fax. #: 905-829-8050, Email: vic@ultratech-labs.com, Website: <http://www.ultratech-labs.com>

File #: ICOM-104F90

December 15, 2004

All test results contained in this engineering test report are traceable to National Institute of Standards and Technology (NIST)

Plot 74:
Emission Mask D
Carrier Frequency: 485.05 MHz
Channel Spacing: 12.5 kHz
Power Level: 1 W
Modulation: FM with 2.5 kHz sine wave & CDCSS (754N)

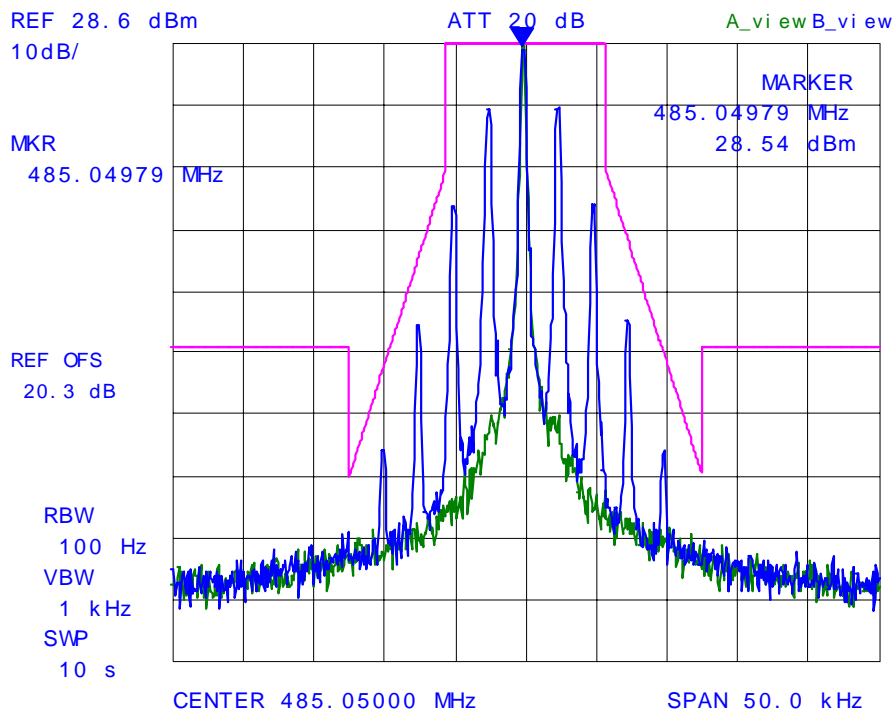

ULTRATECH GROUP OF LABS

3000 Bristol Circle, Oakville, Ontario, Canada L6H 6G4
Tel. #: 905-829-1570, Fax. #: 905-829-8050, Email: vic@ultratech-labs.com, Website: <http://www.ultratech-labs.com>

File #: ICOM-104F90

December 15, 2004

All test results contained in this engineering test report are traceable to National Institute of Standards and Technology (NIST)

Plot 75:
Emission Mask D
Carrier Frequency: 519.95 MHz
Channel Spacing: 12.5 kHz
Power Level: 1 W
Modulation: FM with 2.5 kHz sine wave & CDCSS (754N)

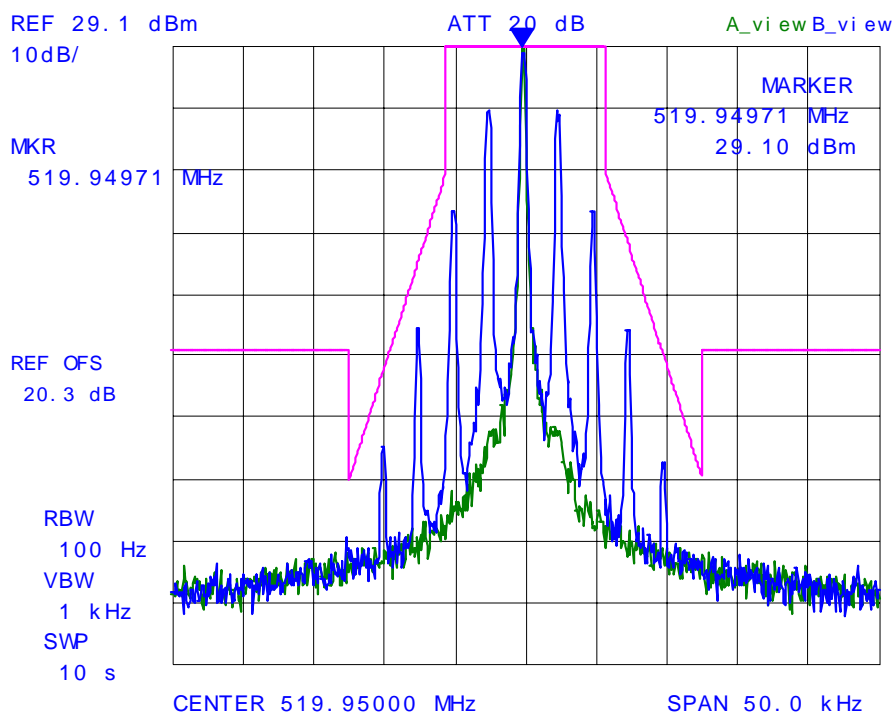

ULTRATECH GROUP OF LABS

3000 Bristol Circle, Oakville, Ontario, Canada L6H 6G4
Tel. #: 905-829-1570, Fax. #: 905-829-8050, Email: vic@ultratech-labs.com, Website: <http://www.ultratech-labs.com>

File #: ICOM-104F90
December 15, 2004

All test results contained in this engineering test report are traceable to National Institute of Standards and Technology (NIST)

Plot 76:
Emission Mask D
Carrier Frequency: 450.05MHz
Channel Spacing: 12.5 kHz
Power Level: 4 W
Modulation: FM with 2.5 kHz sine wave & CTCSS (254.1 Hz)

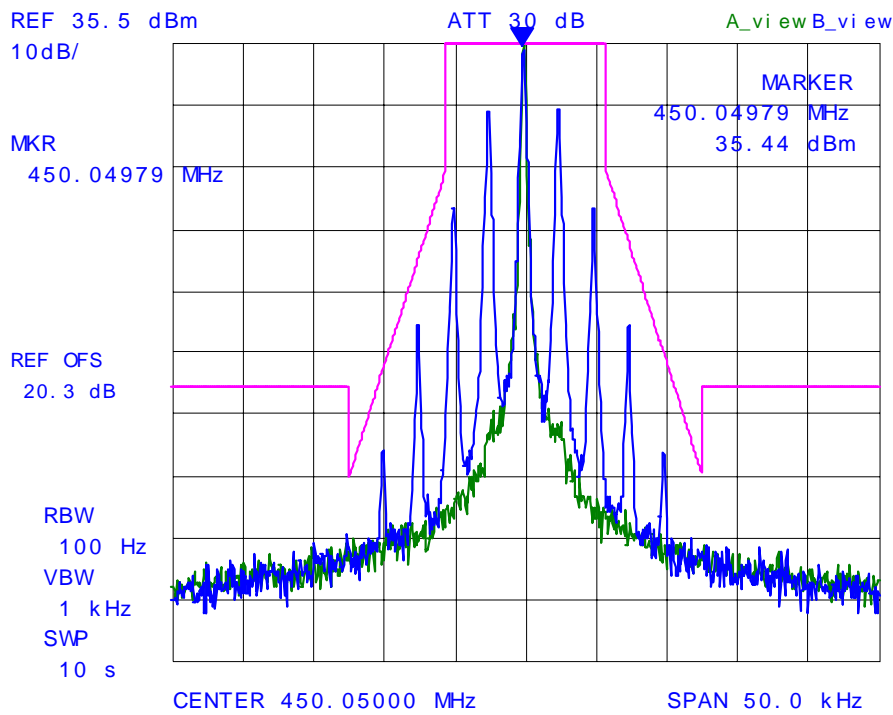

ULTRATECH GROUP OF LABS

3000 Bristol Circle, Oakville, Ontario, Canada L6H 6G4
Tel. #: 905-829-1570, Fax. #: 905-829-8050, Email: vic@ultratech-labs.com, Website: <http://www.ultratech-labs.com>

File #: ICOM-104F90

December 15, 2004

All test results contained in this engineering test report are traceable to National Institute of Standards and Technology (NIST)

Plot 77:
Emission Mask D
Carrier Frequency: 485.05 MHz
Channel Spacing: 12.5 kHz
Power Level: 4 W
Modulation: FM with 2.5 kHz sine wave & CTCSS (254.1 Hz)

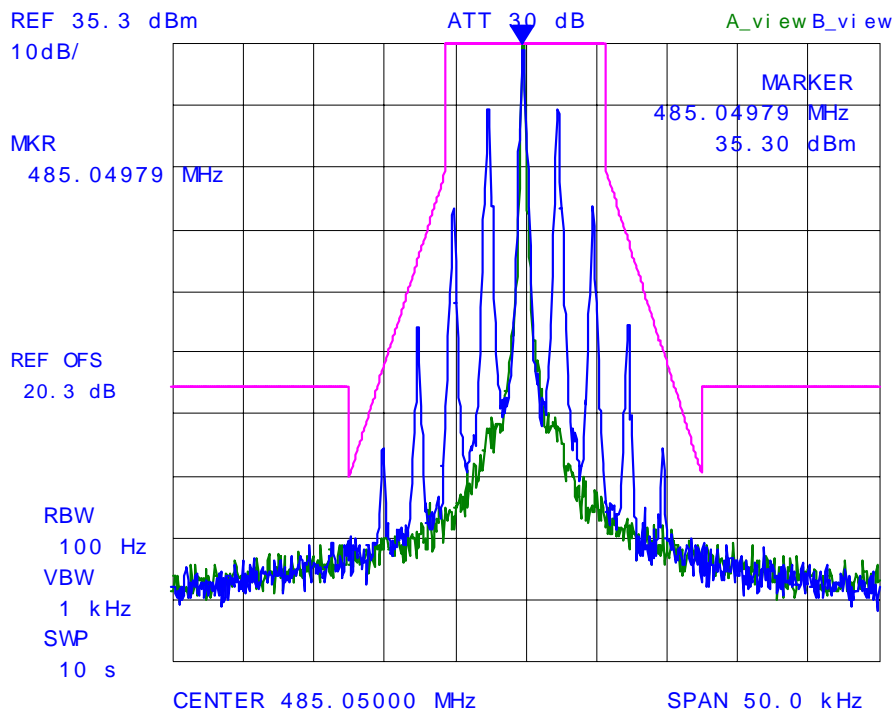

ULTRATECH GROUP OF LABS

3000 Bristol Circle, Oakville, Ontario, Canada L6H 6G4
Tel. #: 905-829-1570, Fax. #: 905-829-8050, Email: vic@ultratech-labs.com, Website: <http://www.ultratech-labs.com>

File #: ICOM-104F90

December 15, 2004

All test results contained in this engineering test report are traceable to National Institute of Standards and Technology (NIST)

Plot 78:
Emission Mask D
Carrier Frequency: 519.95 MHz
Channel Spacing: 12.5 kHz
Power Level: 4 W
Modulation: FM with 2.5 kHz sine wave & CTCSS (254.1 Hz)

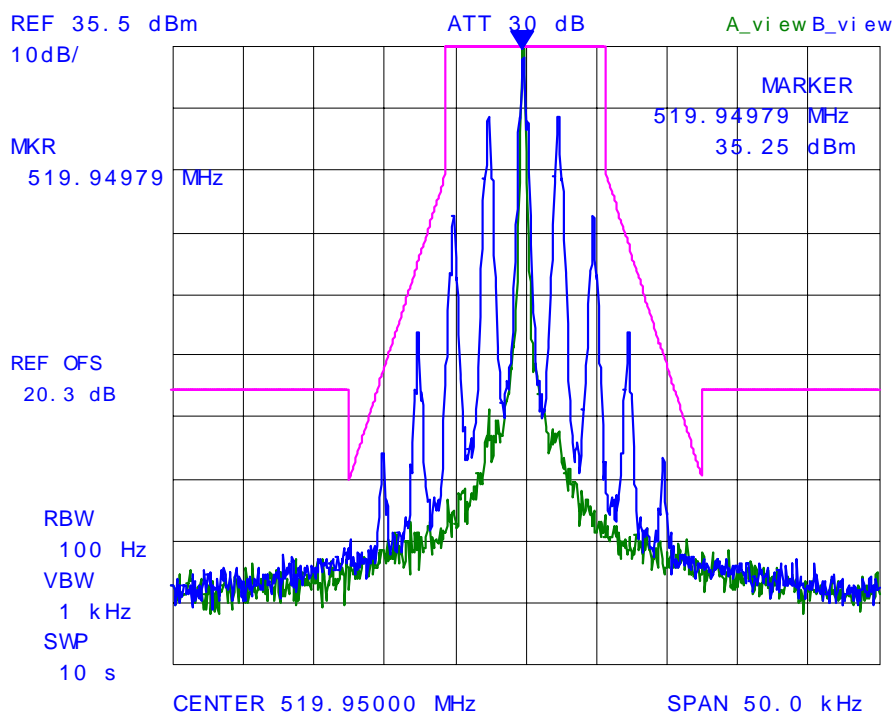

ULTRATECH GROUP OF LABS

3000 Bristol Circle, Oakville, Ontario, Canada L6H 6G4
Tel. #: 905-829-1570, Fax. #: 905-829-8050, Email: vic@ultratech-labs.com, Website: <http://www.ultratech-labs.com>

File #: ICOM-104F90

December 15, 2004

All test results contained in this engineering test report are traceable to National Institute of Standards and Technology (NIST)

Plot 79:
Emission Mask D
Carrier Frequency: 450.05MHz
Channel Spacing: 12.5 kHz
Power Level: 1 W
Modulation: FM with 2.5 kHz sine wave & CTCSS (254.1 Hz)

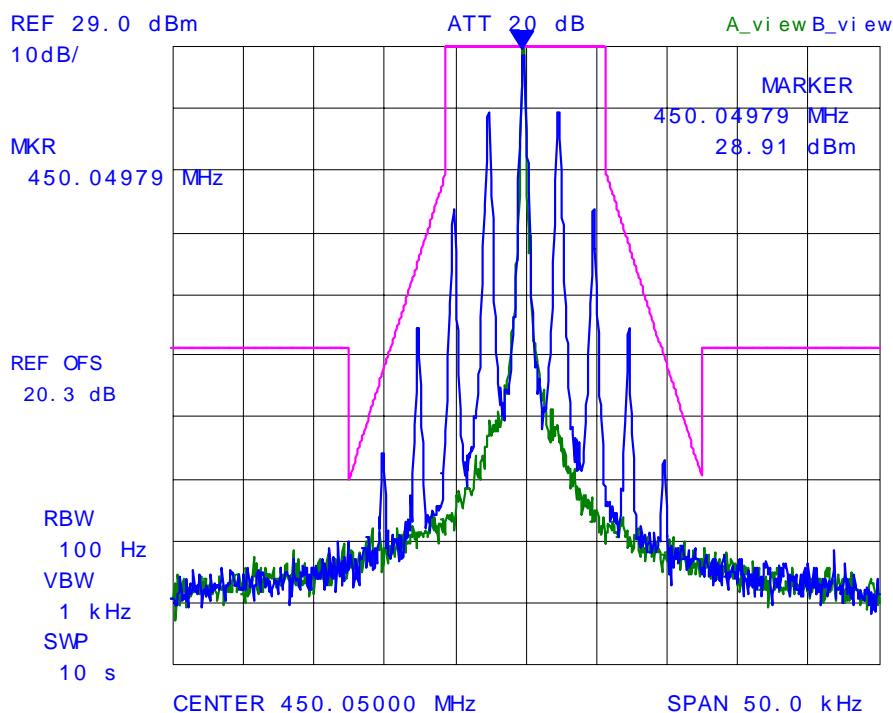

ULTRATECH GROUP OF LABS

3000 Bristol Circle, Oakville, Ontario, Canada L6H 6G4
Tel. #: 905-829-1570, Fax. #: 905-829-8050, Email: vic@ultratech-labs.com, Website: <http://www.ultratech-labs.com>

File #: ICOM-104F90

December 15, 2004

All test results contained in this engineering test report are traceable to National Institute of Standards and Technology (NIST)

Plot 80:
Emission Mask D
Carrier Frequency: 485.05 MHz
Channel Spacing: 12.5 kHz
Power Level: 1 W
Modulation: FM with 2.5 kHz sine wave & CTCSS (254.1 Hz)

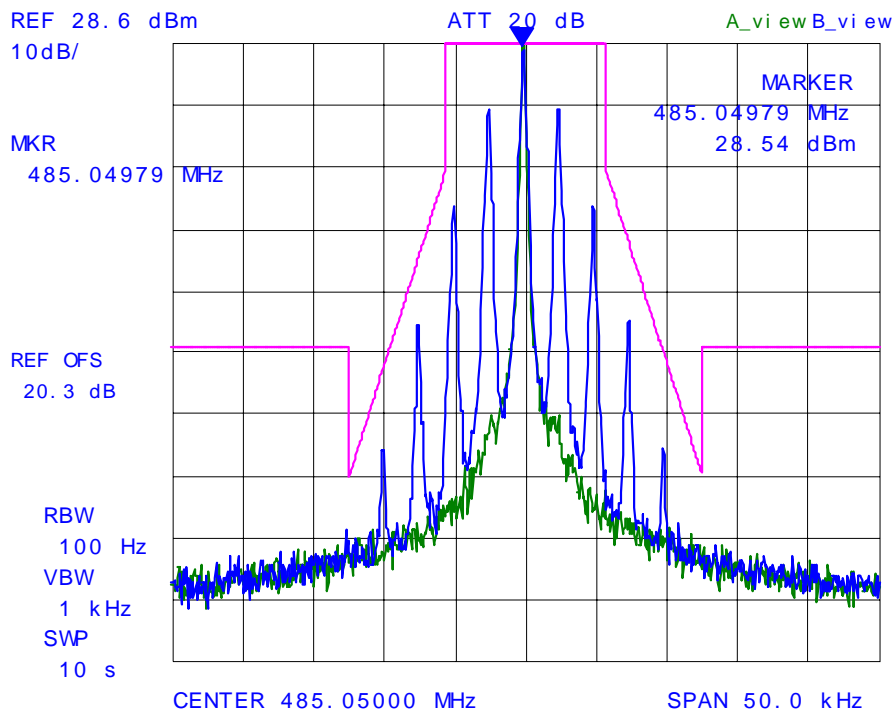

ULTRATECH GROUP OF LABS

3000 Bristol Circle, Oakville, Ontario, Canada L6H 6G4
Tel. #: 905-829-1570, Fax. #: 905-829-8050, Email: vic@ultratech-labs.com, Website: <http://www.ultratech-labs.com>

File #: ICOM-104F90

December 15, 2004

All test results contained in this engineering test report are traceable to National Institute of Standards and Technology (NIST)

Plot 81:
Emission Mask D
Carrier Frequency: 519.95 MHz
Channel Spacing: 12.5 kHz
Power Level: 1 W
Modulation: FM with 2.5 kHz sine wave & CTCSS (254.1 Hz)

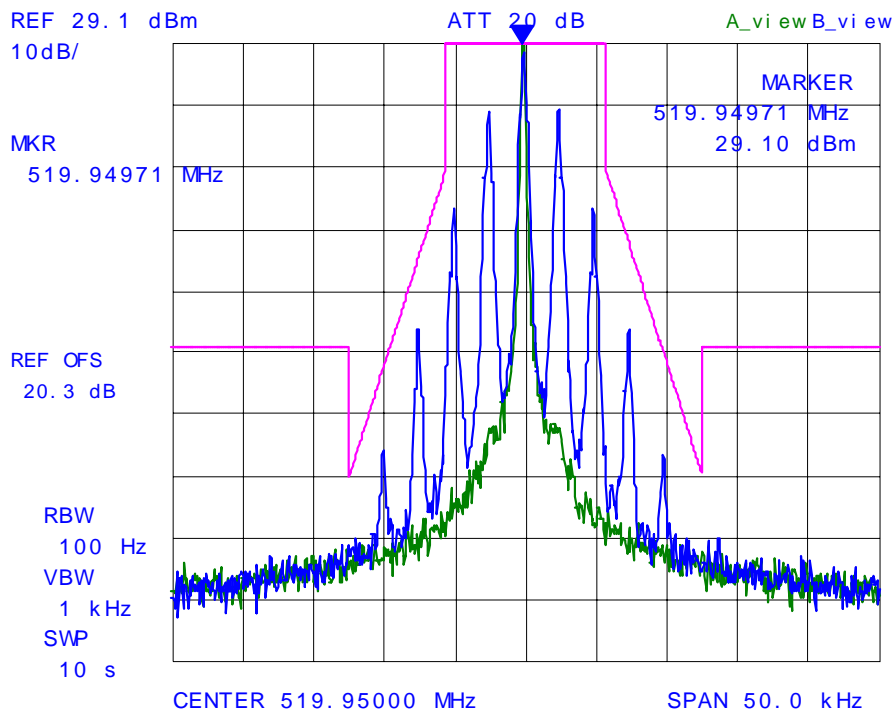

ULTRATECH GROUP OF LABS

3000 Bristol Circle, Oakville, Ontario, Canada L6H 6G4
Tel. #: 905-829-1570, Fax. #: 905-829-8050, Email: vic@ultratech-labs.com, Website: <http://www.ultratech-labs.com>

File #: ICOM-104F90
December 15, 2004

All test results contained in this engineering test report are traceable to National Institute of Standards and Technology (NIST)

Plot 82:
Emission Mask D
Carrier Frequency: 450.05MHz
Channel Spacing: 12.5 kHz
Power Level: 4 W
Modulation: FM with 2.5 kHz sine wave, scrambler & CDCSS (754N)

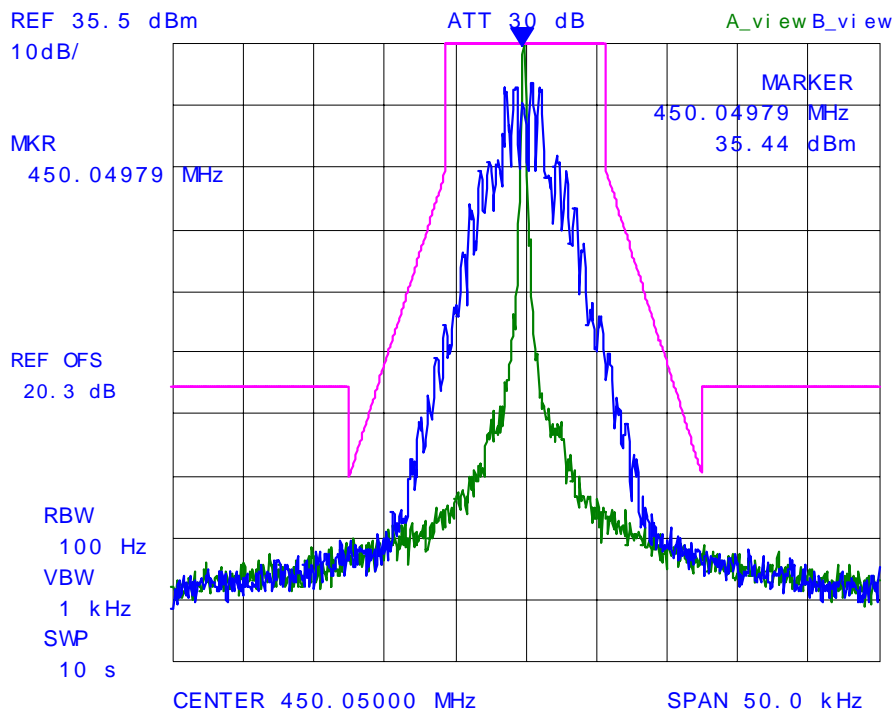

ULTRATECH GROUP OF LABS

3000 Bristol Circle, Oakville, Ontario, Canada L6H 6G4
Tel. #: 905-829-1570, Fax. #: 905-829-8050, Email: vic@ultratech-labs.com, Website: <http://www.ultratech-labs.com>

File #: ICOM-104F90
December 15, 2004

All test results contained in this engineering test report are traceable to National Institute of Standards and Technology (NIST)

Plot 83:
Emission Mask D
Carrier Frequency: 485.05 MHz
Channel Spacing: 12.5 kHz
Power Level: 4 W
Modulation: FM with 2.5 kHz sine wave, scrambler & CDCSS (754N)

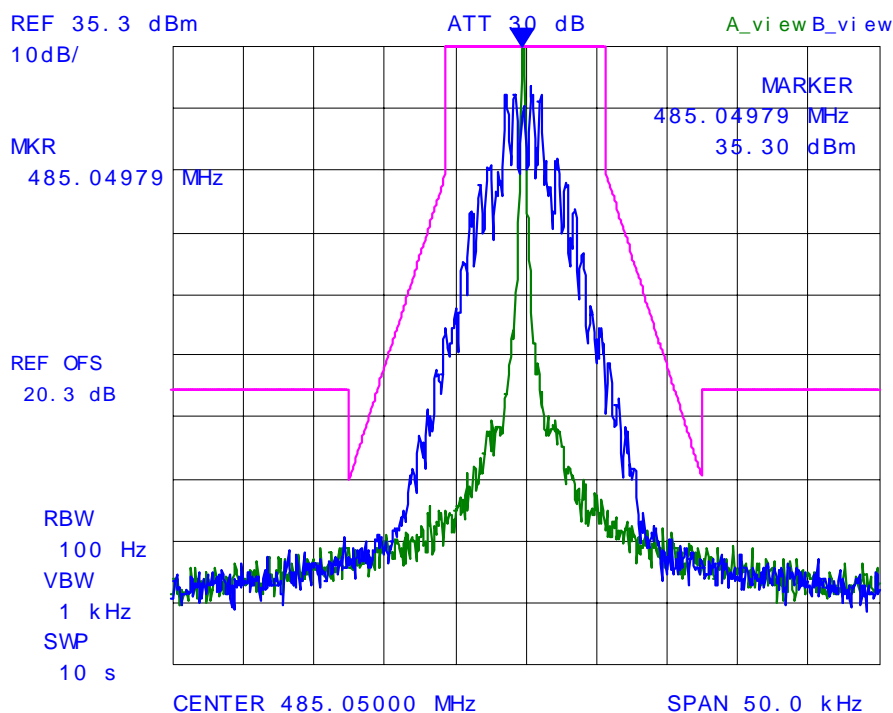

ULTRATECH GROUP OF LABS

3000 Bristol Circle, Oakville, Ontario, Canada L6H 6G4
Tel. #: 905-829-1570, Fax. #: 905-829-8050, Email: vic@ultratech-labs.com, Website: <http://www.ultratech-labs.com>

File #: ICOM-104F90

December 15, 2004

All test results contained in this engineering test report are traceable to National Institute of Standards and Technology (NIST)

Plot 84:
Emission Mask D
Carrier Frequency: 519.95 MHz
Channel Spacing: 12.5 kHz
Power Level: 4 W
Modulation: FM with 2.5 kHz sine wave, scrambler & CDCSS (754N)

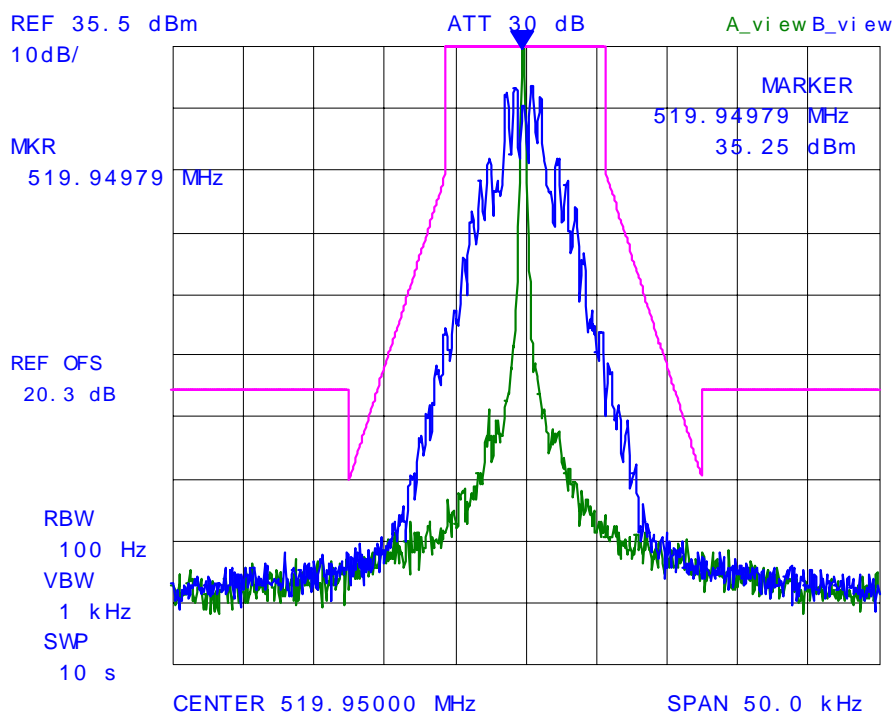

ULTRATECH GROUP OF LABS

3000 Bristol Circle, Oakville, Ontario, Canada L6H 6G4
Tel. #: 905-829-1570, Fax. #: 905-829-8050, Email: vic@ultratech-labs.com, Website: <http://www.ultratech-labs.com>

File #: ICOM-104F90

December 15, 2004

All test results contained in this engineering test report are traceable to National Institute of Standards and Technology (NIST)

Plot 85:
Emission Mask D
Carrier Frequency: 450.05MHz
Channel Spacing: 12.5 kHz
Power Level: 1 W
Modulation: FM with 2.5 kHz sine wave, scrambler & CDCSS (754N)

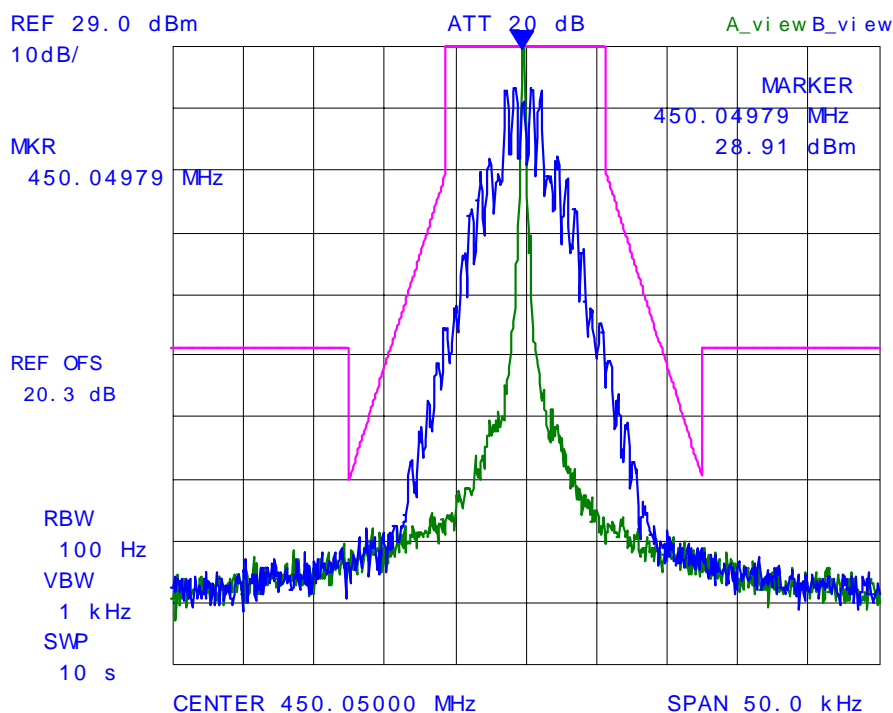

ULTRATECH GROUP OF LABS

3000 Bristol Circle, Oakville, Ontario, Canada L6H 6G4
Tel. #: 905-829-1570, Fax. #: 905-829-8050, Email: vic@ultratech-labs.com, Website: <http://www.ultratech-labs.com>

File #: ICOM-104F90
December 15, 2004

All test results contained in this engineering test report are traceable to National Institute of Standards and Technology (NIST)

Plot 86:
Emission Mask D
Carrier Frequency: 485.05 MHz
Channel Spacing: 12.5 kHz
Power Level: 1 W
Modulation: FM with 2.5 kHz sine wave, scrambler & CDCSS (754N)

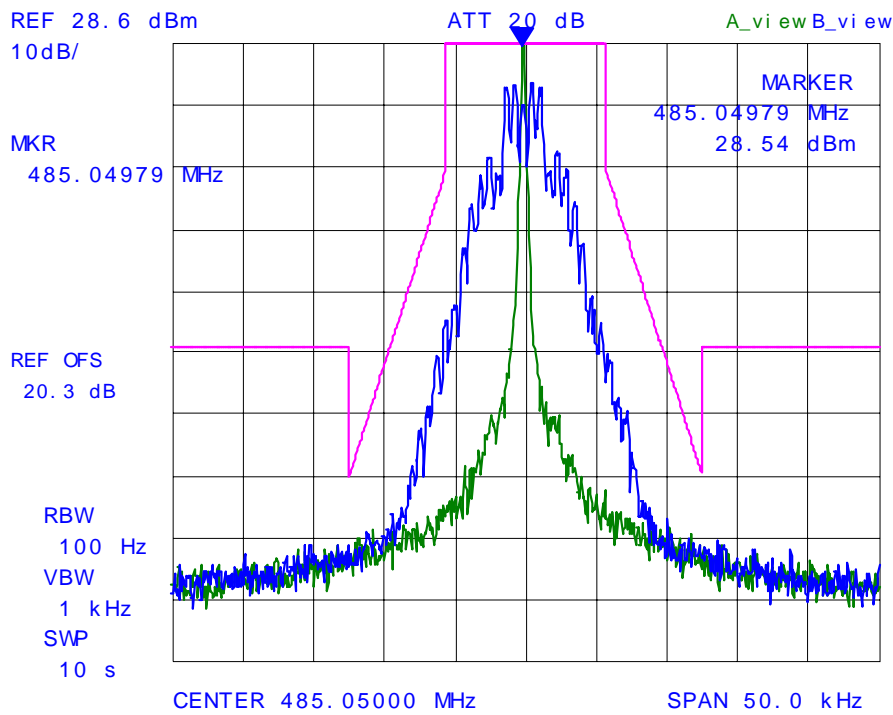

ULTRATECH GROUP OF LABS

3000 Bristol Circle, Oakville, Ontario, Canada L6H 6G4
Tel. #: 905-829-1570, Fax. #: 905-829-8050, Email: vic@ultratech-labs.com, Website: <http://www.ultratech-labs.com>

File #: ICOM-104F90

December 15, 2004

All test results contained in this engineering test report are traceable to National Institute of Standards and Technology (NIST)

Plot 87:
Emission Mask D
Carrier Frequency: 519.95 MHz
Channel Spacing: 12.5 kHz
Power Level: 1 W
Modulation: FM with 2.5 kHz sine wave, scrambler & CDCSS (754N)

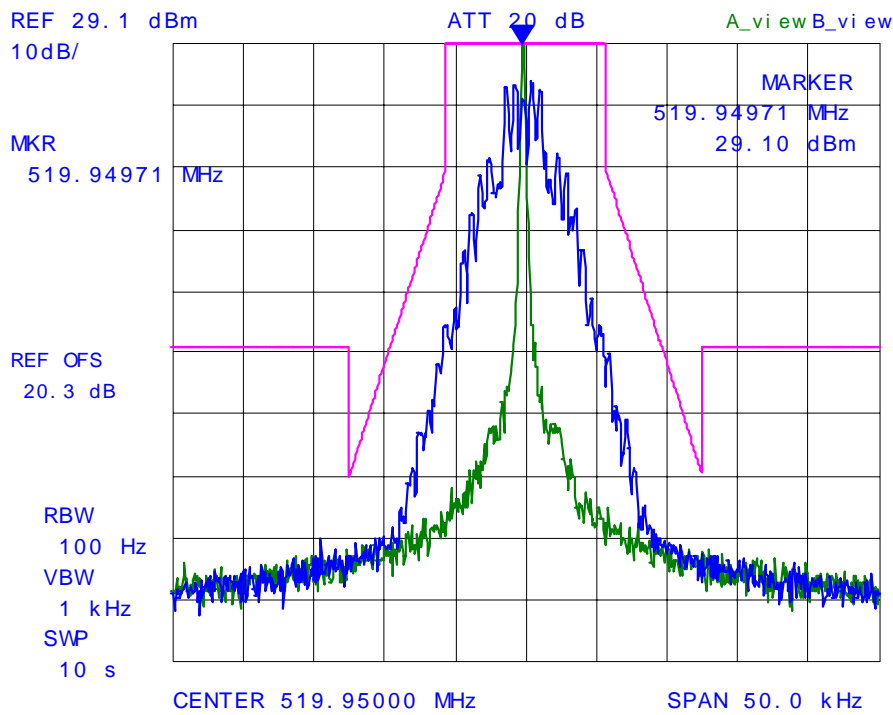

ULTRATECH GROUP OF LABS

3000 Bristol Circle, Oakville, Ontario, Canada L6H 6G4
Tel. #: 905-829-1570, Fax. #: 905-829-8050, Email: vic@ultratech-labs.com, Website: <http://www.ultratech-labs.com>

File #: ICOM-104F90

December 15, 2004

All test results contained in this engineering test report are traceable to National Institute of Standards and Technology (NIST)

Plot 88:
Emission Mask D
Carrier Frequency: 450.05MHz
Channel Spacing: 12.5 kHz
Power Level: 4 W
Modulation: FM with 2.5 kHz sine wave, scrambler & CTCSS (254.1 Hz)

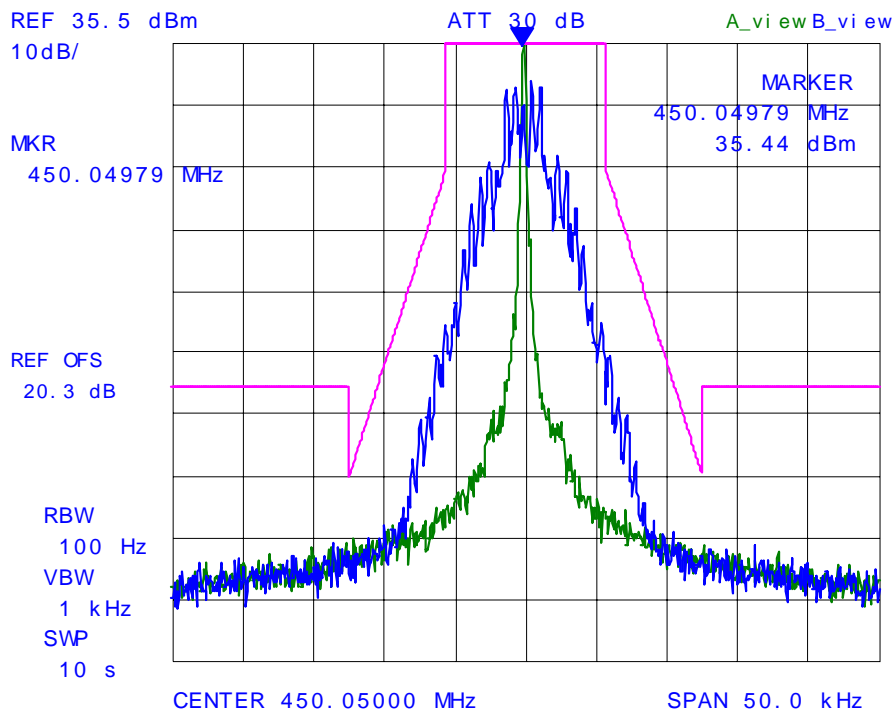

ULTRATECH GROUP OF LABS

3000 Bristol Circle, Oakville, Ontario, Canada L6H 6G4
Tel. #: 905-829-1570, Fax. #: 905-829-8050, Email: vic@ultratech-labs.com, Website: <http://www.ultratech-labs.com>

File #: ICOM-104F90

December 15, 2004

All test results contained in this engineering test report are traceable to National Institute of Standards and Technology (NIST)

Plot 89:
Emission Mask D
Carrier Frequency: 485.05 MHz
Channel Spacing: 12.5 kHz
Power Level: 4 W
Modulation: FM with 2.5 kHz sine wave, scrambler & CTCSS (254.1 Hz)

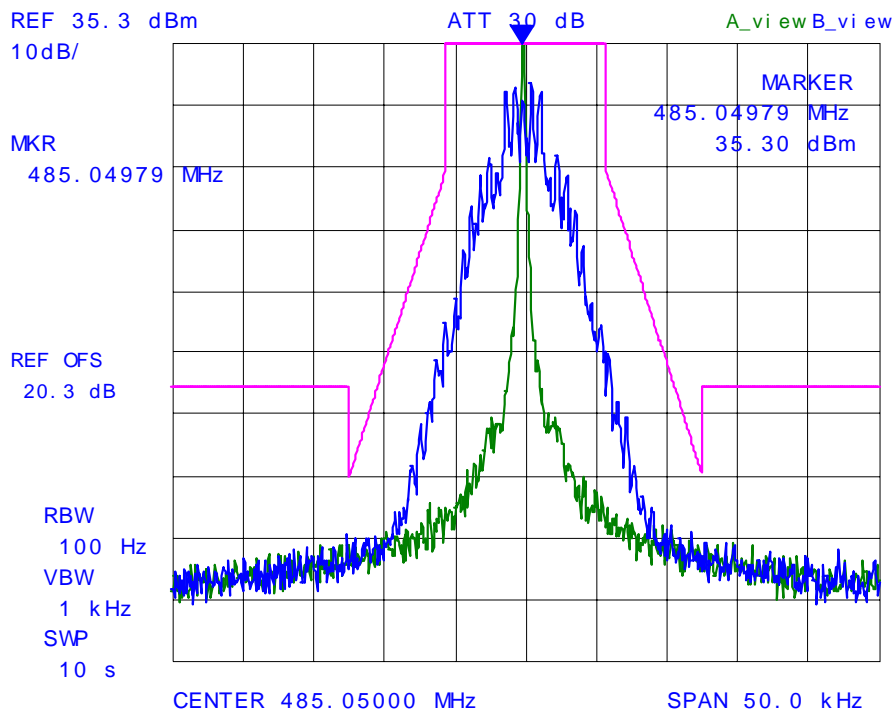

ULTRATECH GROUP OF LABS

3000 Bristol Circle, Oakville, Ontario, Canada L6H 6G4
Tel. #: 905-829-1570, Fax. #: 905-829-8050, Email: vic@ultratech-labs.com, Website: <http://www.ultratech-labs.com>

File #: ICOM-104F90
December 15, 2004

All test results contained in this engineering test report are traceable to National Institute of Standards and Technology (NIST)

Plot 90:
Emission Mask D
Carrier Frequency: 519.95 MHz
Channel Spacing: 12.5 kHz
Power Level: 4 W
Modulation: FM with 2.5 kHz sine wave, scrambler & CTCSS (254.1 Hz)

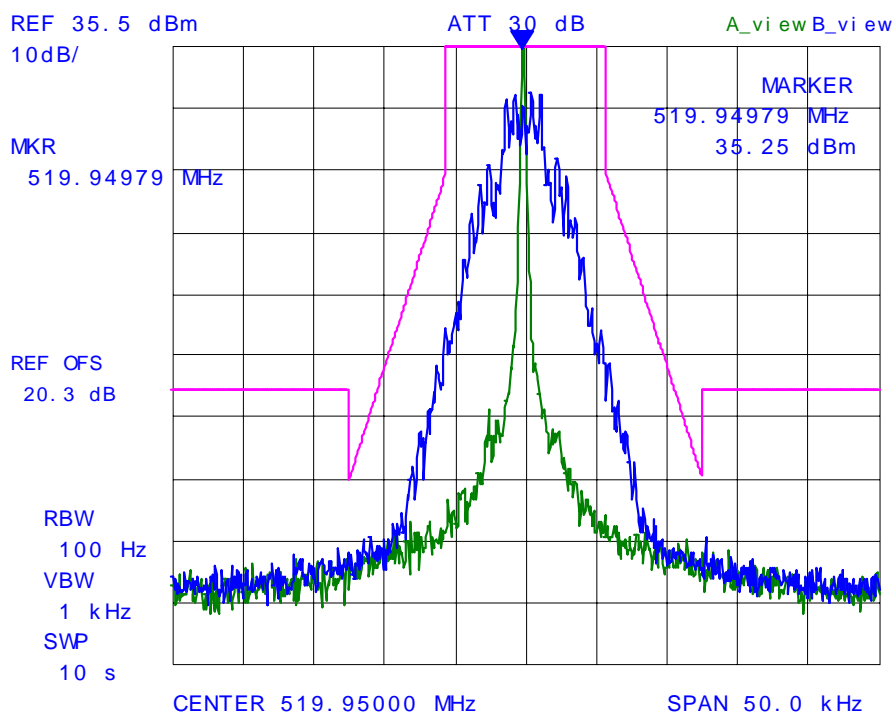

ULTRATECH GROUP OF LABS

3000 Bristol Circle, Oakville, Ontario, Canada L6H 6G4
Tel. #: 905-829-1570, Fax. #: 905-829-8050, Email: vic@ultratech-labs.com, Website: <http://www.ultratech-labs.com>

File #: ICOM-104F90
December 15, 2004

All test results contained in this engineering test report are traceable to National Institute of Standards and Technology (NIST)

Plot 91:
Emission Mask D
Carrier Frequency: 450.05MHz
Channel Spacing: 12.5 kHz
Power Level: 1 W
Modulation: FM with 2.5 kHz sine wave, scrambler & CTCSS (254.1 Hz)

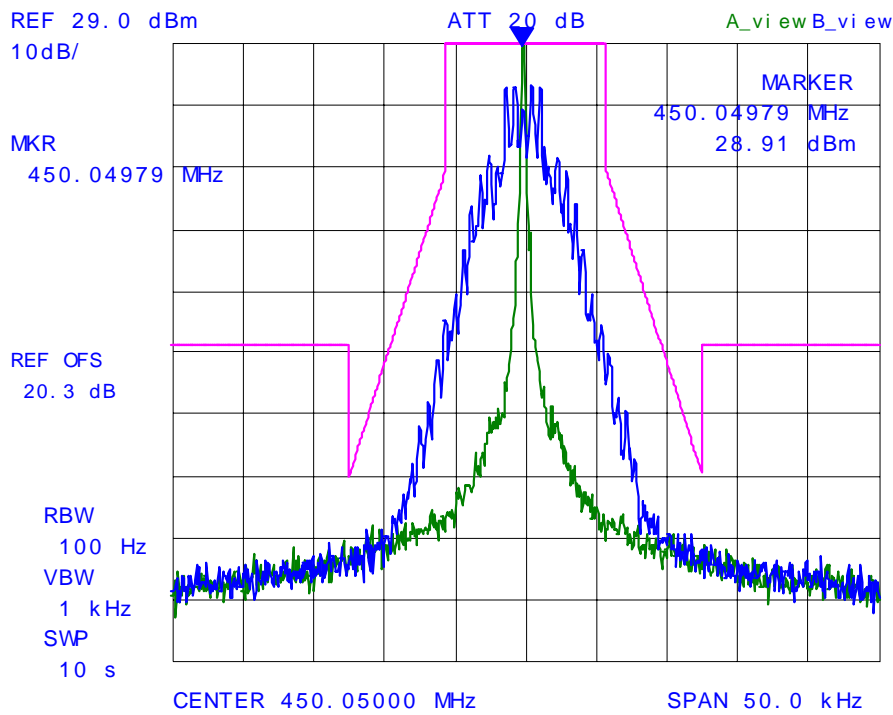

ULTRATECH GROUP OF LABS

3000 Bristol Circle, Oakville, Ontario, Canada L6H 6G4
Tel. #: 905-829-1570, Fax. #: 905-829-8050, Email: vic@ultratech-labs.com, Website: <http://www.ultratech-labs.com>

File #: ICOM-104F90

December 15, 2004

All test results contained in this engineering test report are traceable to National Institute of Standards and Technology (NIST)

Plot 92:
Emission Mask D
Carrier Frequency: 485.05 MHz
Channel Spacing: 12.5 kHz
Power Level: 1 W
Modulation: FM with 2.5 kHz sine wave, scrambler & CTCSS (254.1 Hz)

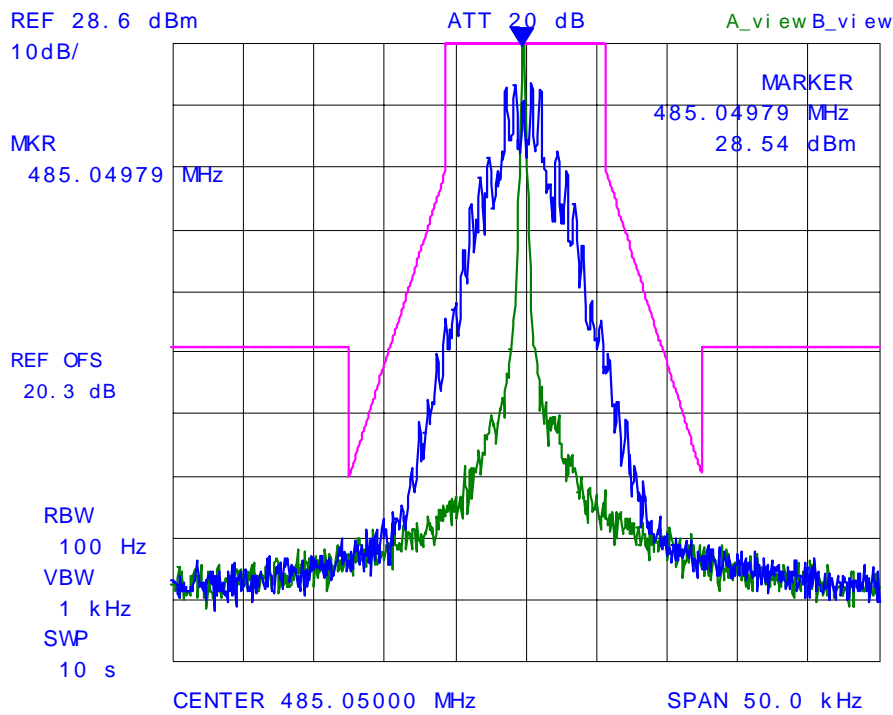

ULTRATECH GROUP OF LABS

3000 Bristol Circle, Oakville, Ontario, Canada L6H 6G4
Tel. #: 905-829-1570, Fax. #: 905-829-8050, Email: vic@ultratech-labs.com, Website: <http://www.ultratech-labs.com>

File #: ICOM-104F90

December 15, 2004

All test results contained in this engineering test report are traceable to National Institute of Standards and Technology (NIST)

Plot 93:
Emission Mask D
Carrier Frequency: 519.95 MHz
Channel Spacing: 12.5 kHz
Power Level: 1 W
Modulation: FM with 2.5 kHz sine wave, scrambler & CTCSS (254.1 Hz)

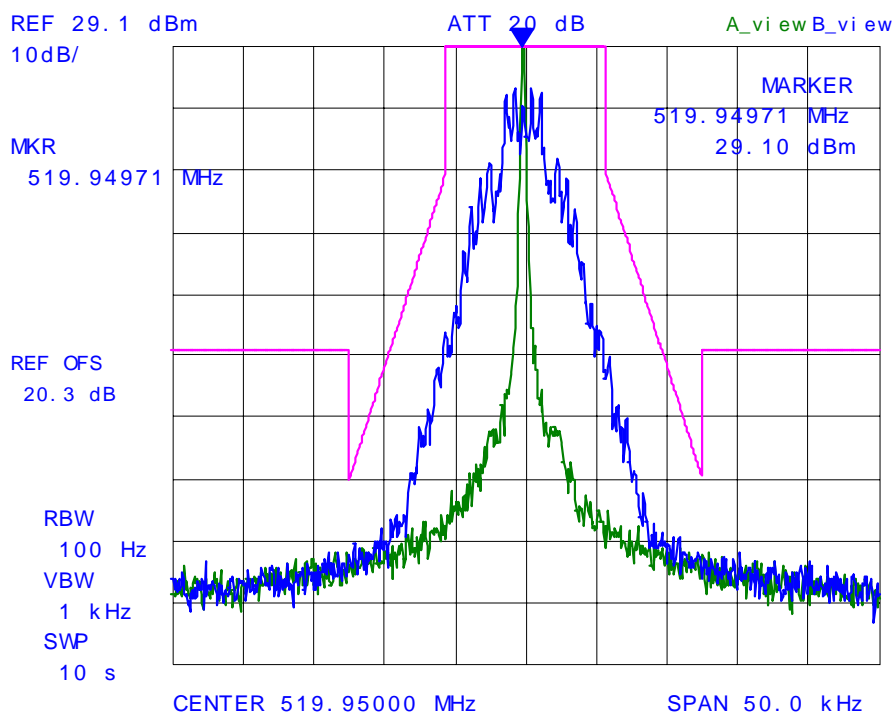

ULTRATECH GROUP OF LABS

3000 Bristol Circle, Oakville, Ontario, Canada L6H 6G4
Tel. #: 905-829-1570, Fax. #: 905-829-8050, Email: vic@ultratech-labs.com, Website: <http://www.ultratech-labs.com>

File #: ICOM-104F90
December 15, 2004

All test results contained in this engineering test report are traceable to National Institute of Standards and Technology (NIST)

Plot 94:
Emission Mask D
Carrier Frequency: 450.05MHz
Power Level: 4 W
Modulation: C4-FM (CQPSK)

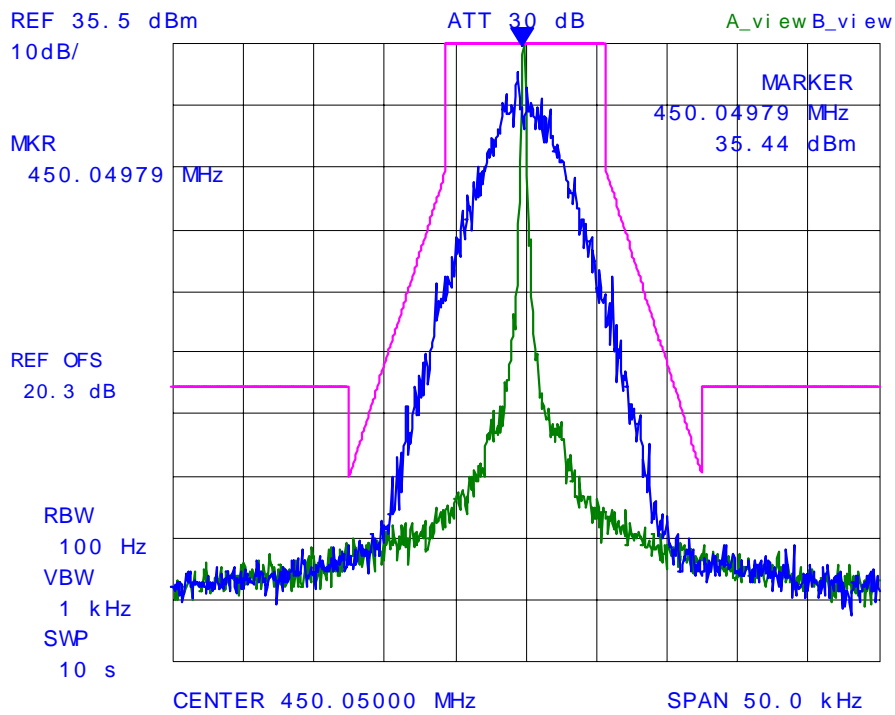

ULTRATECH GROUP OF LABS

3000 Bristol Circle, Oakville, Ontario, Canada L6H 6G4
Tel. #: 905-829-1570, Fax. #: 905-829-8050, Email: vic@ultratech-labs.com, Website: <http://www.ultratech-labs.com>

File #: ICOM-104F90

December 15, 2004

All test results contained in this engineering test report are traceable to National Institute of Standards and Technology (NIST)

Plot 95:
Emission Mask D
Carrier Frequency: 485.05 MHz
Power Level: 4 W
Modulation: C4-FM (CQPSK)

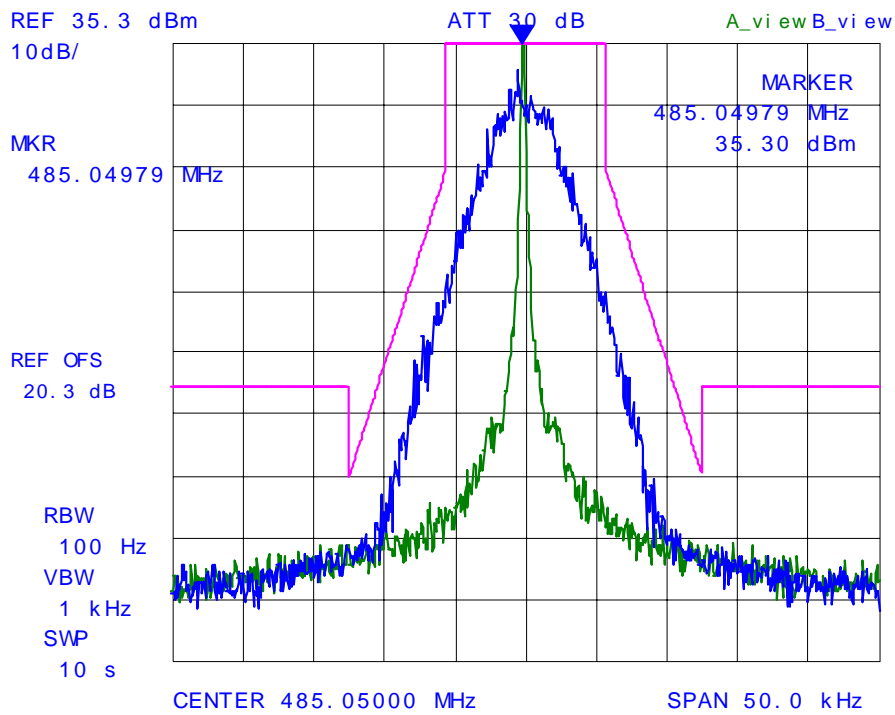

ULTRATECH GROUP OF LABS

3000 Bristol Circle, Oakville, Ontario, Canada L6H 6G4
Tel. #: 905-829-1570, Fax. #: 905-829-8050, Email: vic@ultratech-labs.com, Website: <http://www.ultratech-labs.com>

File #: ICOM-104F90

December 15, 2004

All test results contained in this engineering test report are traceable to National Institute of Standards and Technology (NIST)

Plot 96:
Emission Mask D
Carrier Frequency: 519.95 MHz
Power Level: 4 W
Modulation: C4-FM (CQPSK)

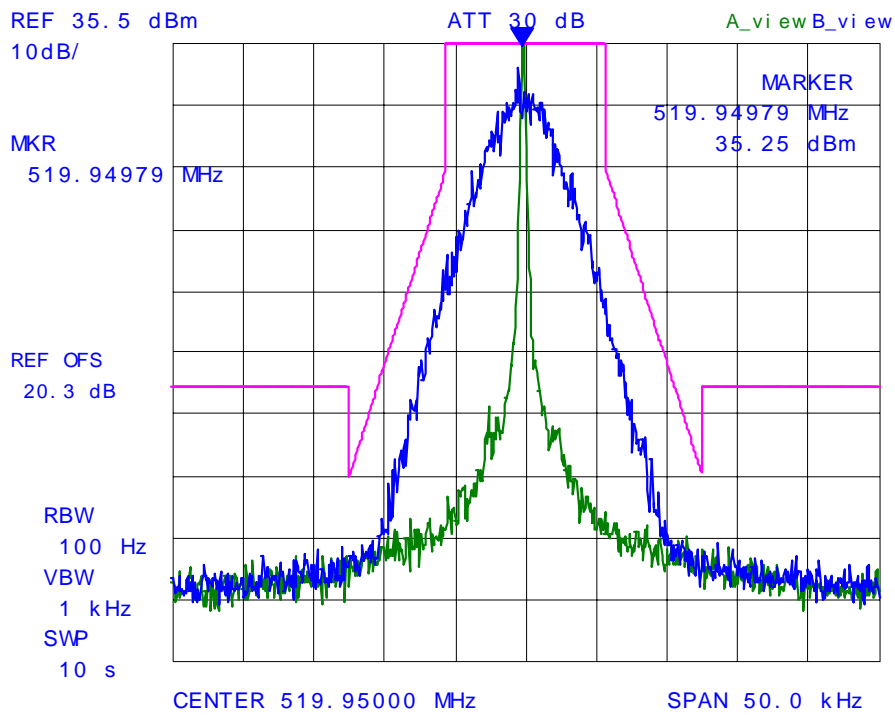

ULTRATECH GROUP OF LABS

3000 Bristol Circle, Oakville, Ontario, Canada L6H 6G4
Tel. #: 905-829-1570, Fax. #: 905-829-8050, Email: vic@ultratech-labs.com, Website: <http://www.ultratech-labs.com>

File #: ICOM-104F90

December 15, 2004

All test results contained in this engineering test report are traceable to National Institute of Standards and Technology (NIST)

Plot 97:
Emission Mask D
Carrier Frequency: 450.05MHz
Power Level: 1 W
Modulation: C4-FM (CQPSK)

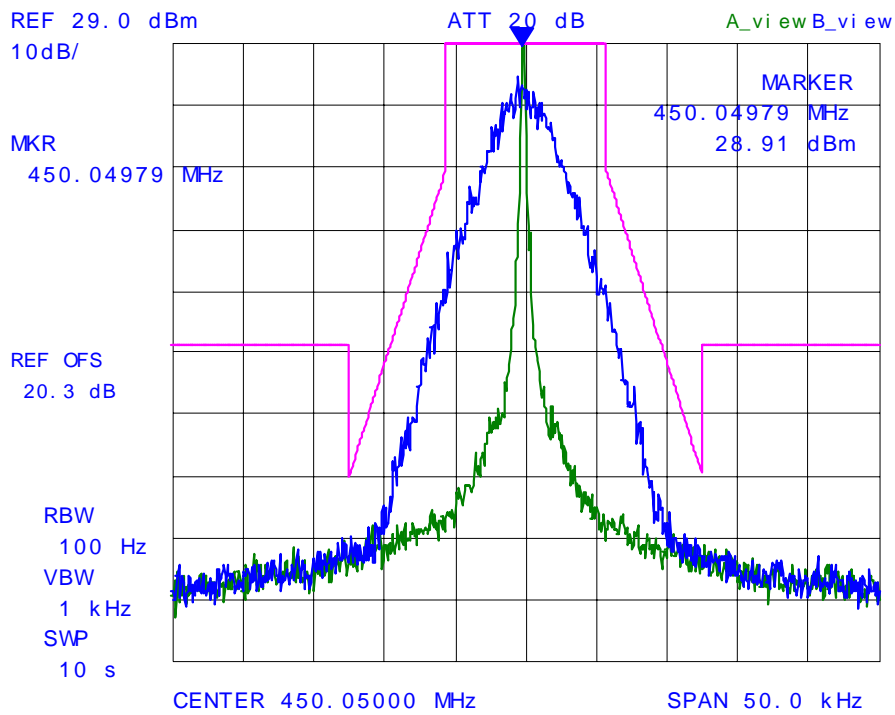

ULTRATECH GROUP OF LABS

3000 Bristol Circle, Oakville, Ontario, Canada L6H 6G4
Tel. #: 905-829-1570, Fax. #: 905-829-8050, Email: vic@ultratech-labs.com, Website: <http://www.ultratech-labs.com>

File #: ICOM-104F90

December 15, 2004

All test results contained in this engineering test report are traceable to National Institute of Standards and Technology (NIST)

Plot 98:
Emission Mask D
Carrier Frequency: 485.05 MHz
Power Level: 1 W
Modulation: C4-FM (CQPSK)

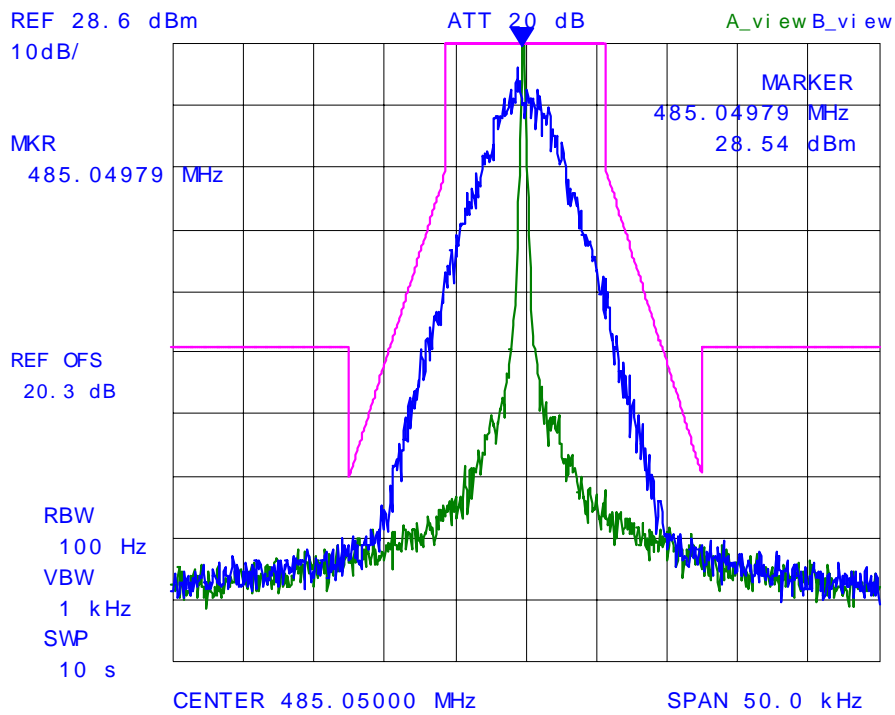

ULTRATECH GROUP OF LABS

3000 Bristol Circle, Oakville, Ontario, Canada L6H 6G4
Tel. #: 905-829-1570, Fax. #: 905-829-8050, Email: vic@ultratech-labs.com, Website: <http://www.ultratech-labs.com>

File #: ICOM-104F90

December 15, 2004

All test results contained in this engineering test report are traceable to National Institute of Standards and Technology (NIST)

Plot 99:
Emission Mask D
Carrier Frequency: 519.95 MHz
Power Level: 1 W
Modulation: C4-FM (CQPSK)

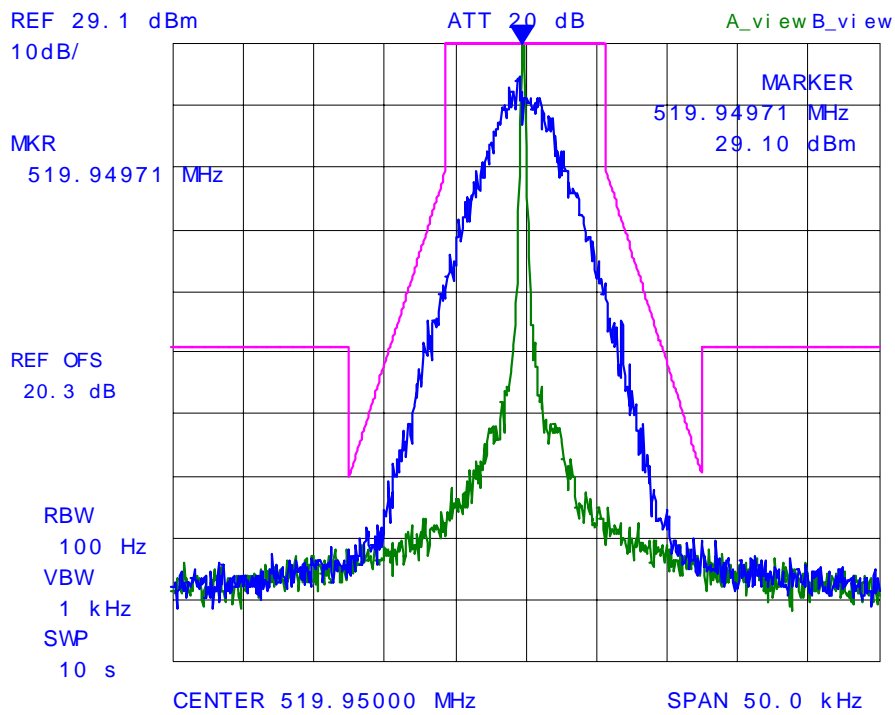

ULTRATECH GROUP OF LABS

3000 Bristol Circle, Oakville, Ontario, Canada L6H 6G4
Tel. #: 905-829-1570, Fax. #: 905-829-8050, Email: vic@ultratech-labs.com, Website: <http://www.ultratech-labs.com>

File #: ICOM-104F90

December 15, 2004

All test results contained in this engineering test report are traceable to National Institute of Standards and Technology (NIST)

6.10. TRANSMITTER ANTENNA POWER SPURIOUS/HARMONIC CONDUCTED EMISSIONS [§ 90.210]

6.10.1. Limits

Emissions shall be attenuated below the mean output power of the transmitter as follows:

FCC Rules	Frequency Range	Attenuation Limit (dBc)
90.210(b)&(c) – Voice & data	10 MHz to Lowest frequency of the radio to 10 th harmonic of the highest frequency of the radio	43 + 10 log (P) dB
90.210(d) – Voice & data	10 MHz to Lowest frequency of the radio to 10 th harmonic of the highest frequency of the radio	50 + 10 log (P) dB or 70 dB whichever is the lesser attenuation

Note: P is output power in watts

6.10.2. Method of Measurements

Refer to Exhibit 8 Section 8.5 of this report for measurement details

6.10.3. Test Equipment List

Test Instruments	Manufacturer	Model No.	Serial No.	Frequency Range
EMI Receiver/ Spectrum Analyzer	Advantest	R3271	15050203	100 Hz – 26.5 GHz
Attenuator(s)	Weinschel Corp	23-20-34	BH7876	DC – 18 GHz
Radio Communication	Marconi	2955	132037/226	20Hz – 20kHz
High Pass Filter	Mini-Circuits	SHP-600	--	Cut-off Frequency at 560 MHz
Power Supply	Tenna	72-6153	--	--
Digital Multimeter	Rohde & Schwarz	UDS5	8729841067	DC-100 kHz

6.10.4. Test Arrangement

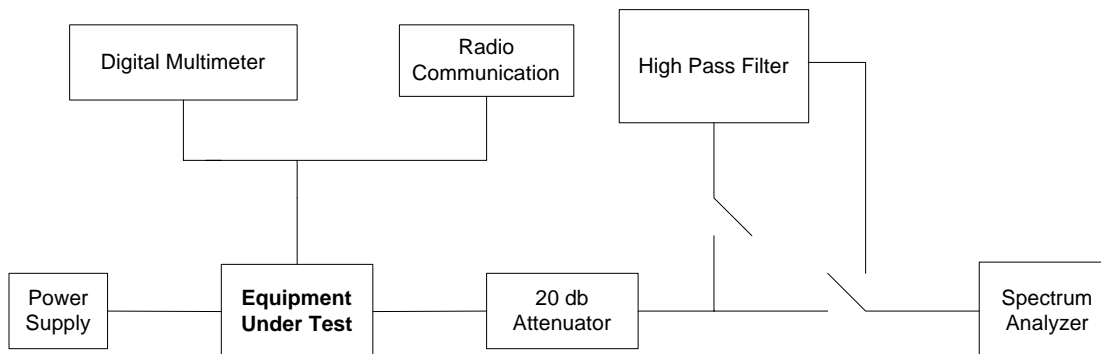

6.10.5. Test Data

Note: There was no difference in spurious/harmonic emissions on the pre-scans for narrow band and wide band operation. Therefore the rf spurious/harmonic emissions in this section would be performed for 12.5 kHz Channel Spacing and the more stringent limit of $50 + 10 \log (P)$ would be applied for worst case.

6.10.5.1. Near Lowest Frequency (450.05 MHz)

Plot 100
Spurious Emissions at Antenna Terminals
Carrier Frequency: 450.05MHz
Channel Spacing: 12.5 kHz
Power Level: 4 W
Modulation: FM with 2.5 kHz sine wave

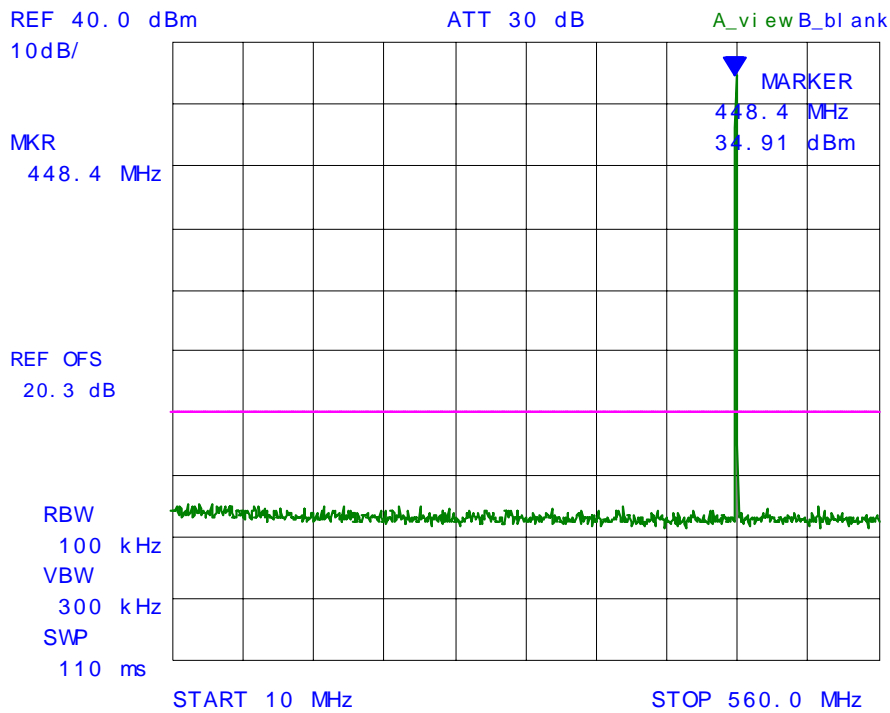

Plot 101:
Spurious Emissions at Antenna Terminals
Carrier Frequency: 450.05MHz
Channel Spacing: 12.5 kHz
Power Level: 4 W
Modulation: FM with 2.5 kHz sine wave

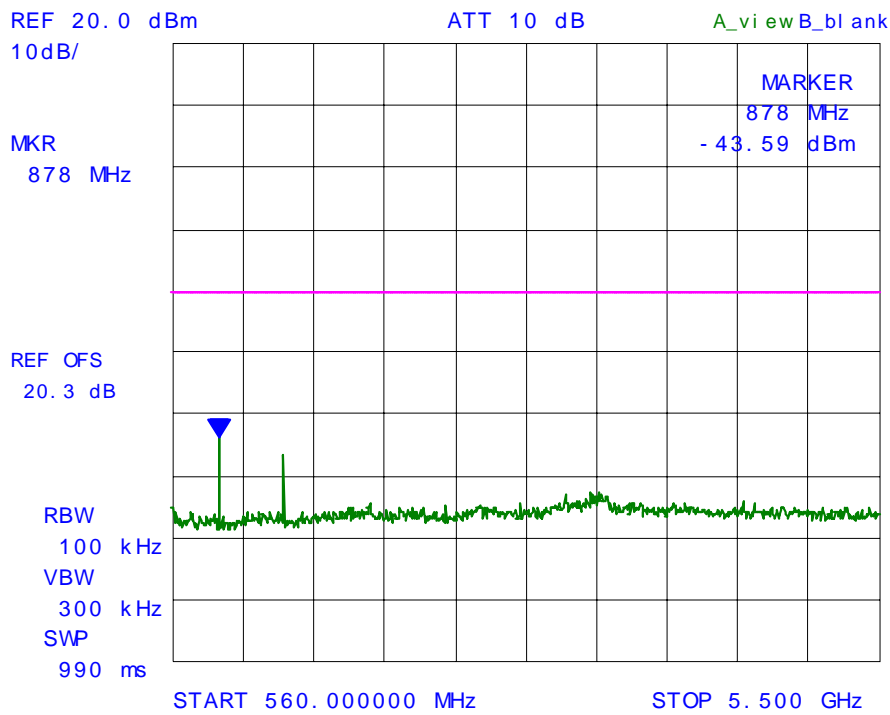

ULTRATECH GROUP OF LABS

3000 Bristol Circle, Oakville, Ontario, Canada L6H 6G4
Tel. #: 905-829-1570, Fax. #: 905-829-8050, Email: vic@ultratech-labs.com, Website: <http://www.ultratech-labs.com>

File #: ICOM-104F90

December 15, 2004

All test results contained in this engineering test report are traceable to National Institute of Standards and Technology (NIST)

Plot 102:
Spurious Emissions at Antenna Terminals
Carrier Frequency: 450.05MHz
Channel Spacing: 12.5 kHz
Power Level: 1 W
Modulation: FM with 2.5 kHz sine wave

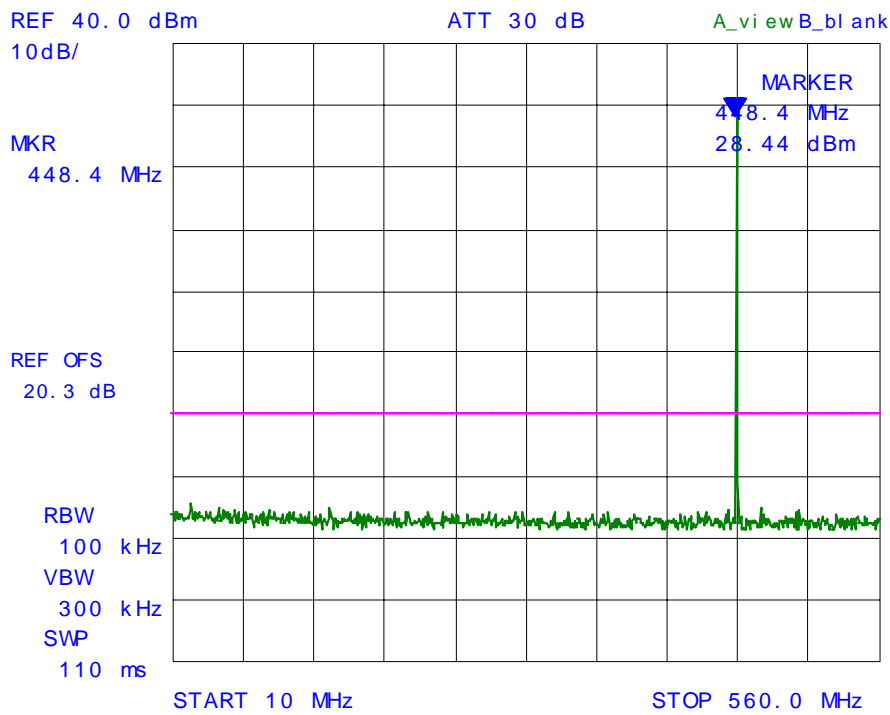

ULTRATECH GROUP OF LABS

3000 Bristol Circle, Oakville, Ontario, Canada L6H 6G4
Tel. #: 905-829-1570, Fax. #: 905-829-8050, Email: vic@ultratech-labs.com, Website: <http://www.ultratech-labs.com>

File #: ICOM-104F90

December 15, 2004

All test results contained in this engineering test report are traceable to National Institute of Standards and Technology (NIST)

Plot 103:
Spurious Emissions at Antenna Terminals
Carrier Frequency: 450.05MHz
Channel Spacing: 12.5 kHz
Power Level: 1 W
Modulation: FM with 2.5 kHz sine wave

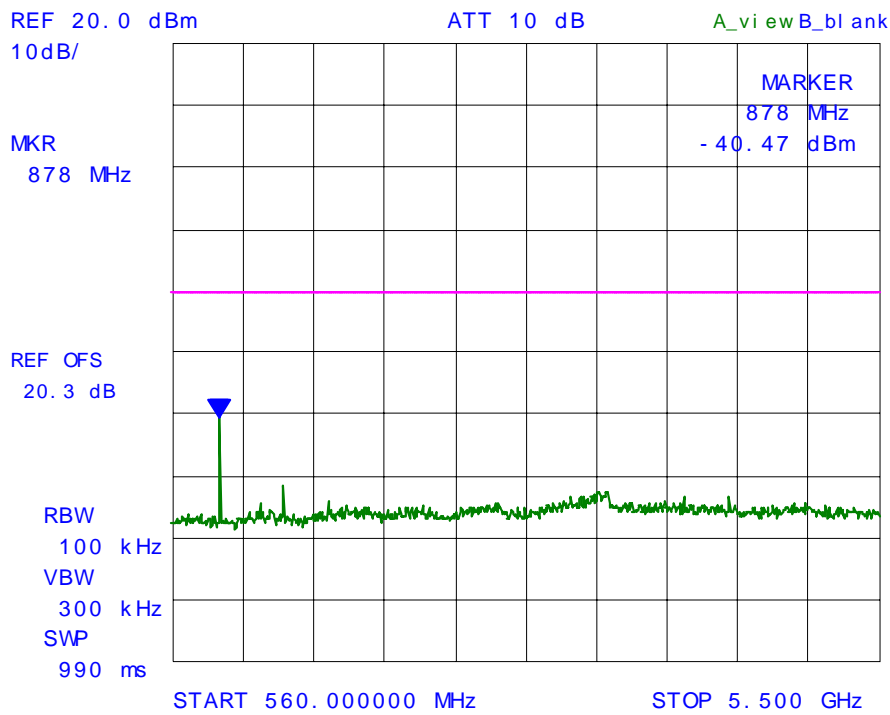

ULTRATECH GROUP OF LABS

3000 Bristol Circle, Oakville, Ontario, Canada L6H 6G4
Tel. #: 905-829-1570, Fax. #: 905-829-8050, Email: vic@ultratech-labs.com, Website: <http://www.ultratech-labs.com>

File #: ICOM-104F90

December 15, 2004

All test results contained in this engineering test report are traceable to National Institute of Standards and Technology (NIST)

6.10.5.2. Near Middle Frequency (485.05 MHz)

Plot 104:
Spurious Emissions at Antenna Terminals
Carrier Frequency: 485.05 MHz
Channel Spacing: 12.5 kHz
Power Level: 4 W
Modulation: FM with 2.5 kHz sine wave

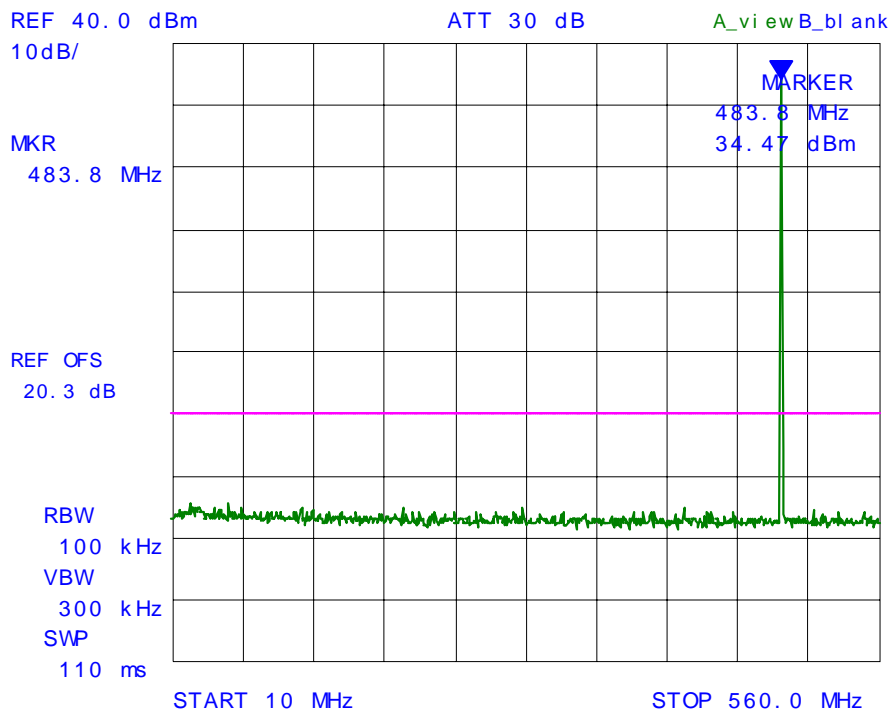

Plot 105:
Spurious Emissions at Antenna Terminals
Carrier Frequency: 485.05 MHz
Channel Spacing: 12.5 kHz
Power Level: 4 W
Modulation: FM with 2.5 kHz sine wave

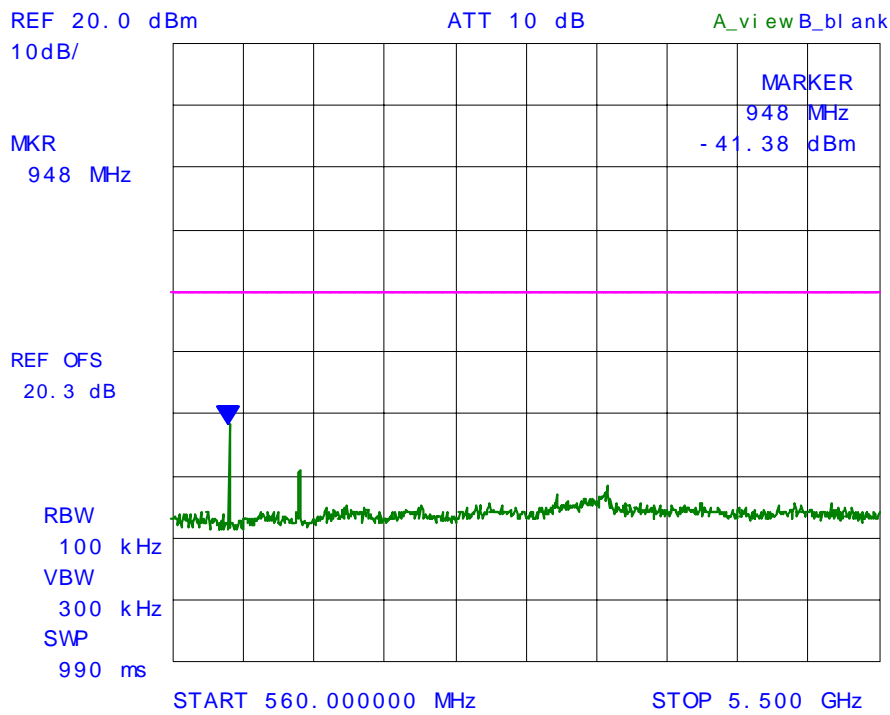

ULTRATECH GROUP OF LABS

3000 Bristol Circle, Oakville, Ontario, Canada L6H 6G4
Tel. #: 905-829-1570, Fax. #: 905-829-8050, Email: vic@ultratech-labs.com, Website: <http://www.ultratech-labs.com>

File #: ICOM-104F90

December 15, 2004

All test results contained in this engineering test report are traceable to National Institute of Standards and Technology (NIST)

Plot 106:
Spurious Emissions at Antenna Terminals
Carrier Frequency: 485.05 MHz
Channel Spacing: 12.5 kHz
Power Level: 1 W
Modulation: FM with 2.5 kHz sine wave

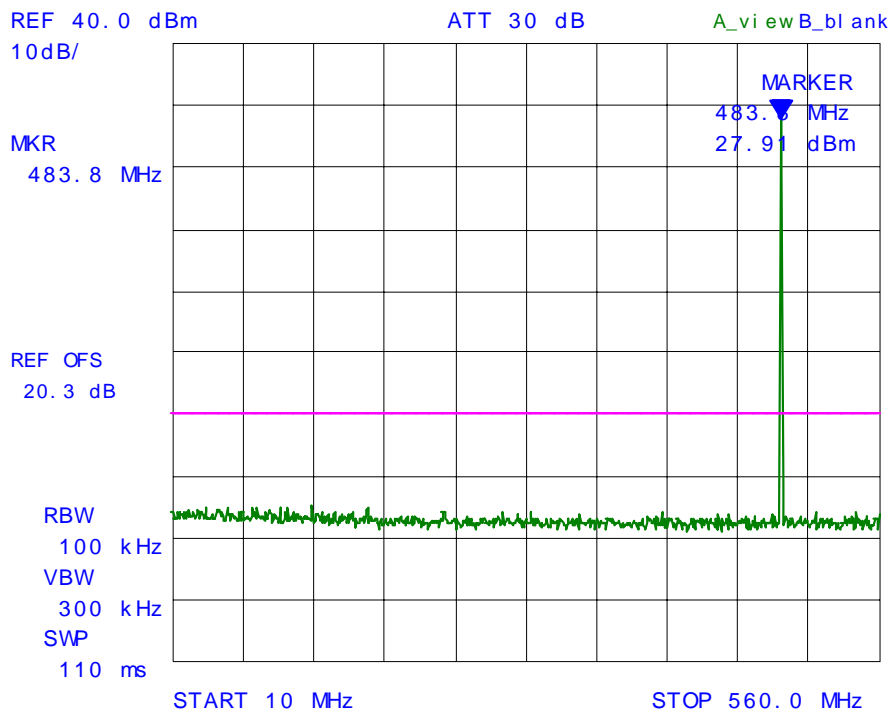

ULTRATECH GROUP OF LABS

3000 Bristol Circle, Oakville, Ontario, Canada L6H 6G4
Tel. #: 905-829-1570, Fax. #: 905-829-8050, Email: vic@ultratech-labs.com, Website: <http://www.ultratech-labs.com>

File #: ICOM-104F90

December 15, 2004

All test results contained in this engineering test report are traceable to National Institute of Standards and Technology (NIST)

Plot 107:
Spurious Emissions at Antenna Terminals
Carrier Frequency: 485.05 MHz
Channel Spacing: 12.5 kHz
Power Level: 1 W
Modulation: FM with 2.5 kHz sine wave

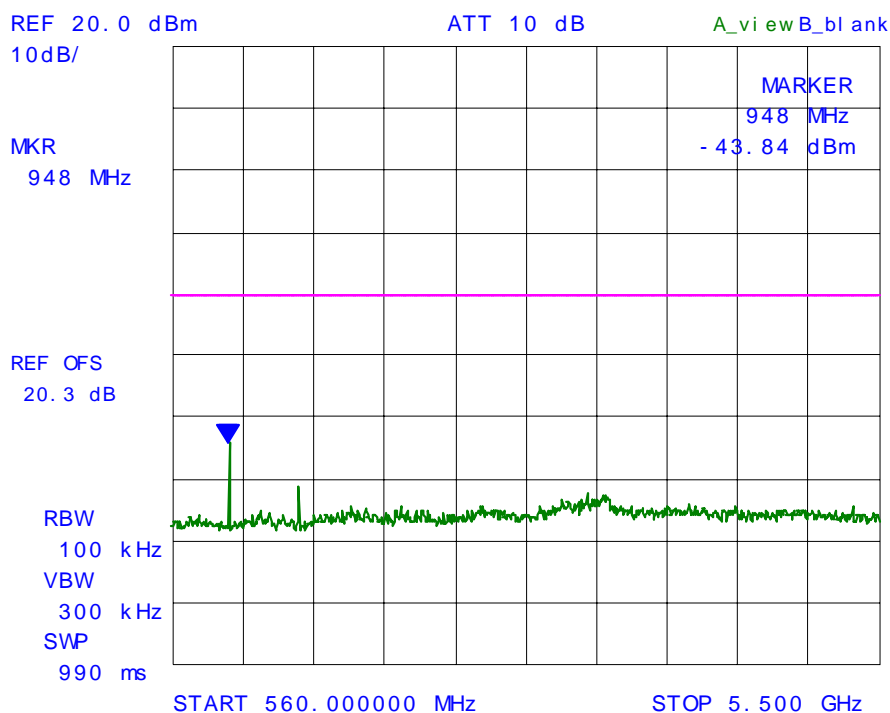

ULTRATECH GROUP OF LABS

3000 Bristol Circle, Oakville, Ontario, Canada L6H 6G4
Tel. #: 905-829-1570, Fax. #: 905-829-8050, Email: vic@ultratech-labs.com, Website: <http://www.ultratech-labs.com>

File #: ICOM-104F90

December 15, 2004

All test results contained in this engineering test report are traceable to National Institute of Standards and Technology (NIST)

6.10.5.3. Near Highest Frequency (519.95 MHz)

Plot 108:
Spurious Emissions at Antenna Terminals
Carrier Frequency: 519.95 MHz
Channel Spacing: 12.5 kHz
Power Level: 4 W
Modulation: FM with 2.5 kHz sine wave

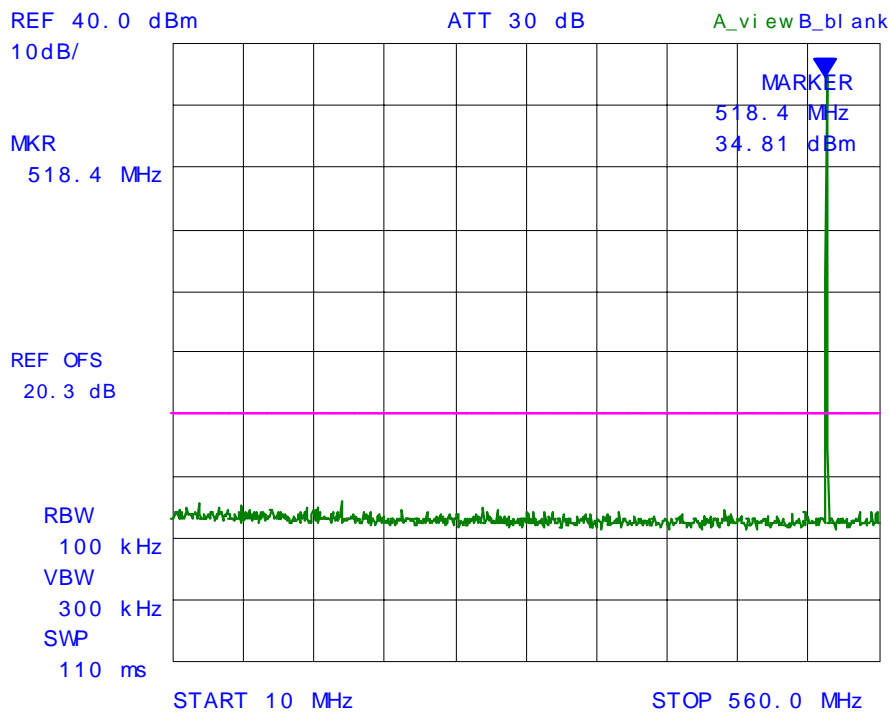

Plot 109:
Spurious Emissions at Antenna Terminals
Carrier Frequency: 519.95 MHz
Channel Spacing: 12.5 kHz
Power Level: 4 W
Modulation: FM with 2.5 kHz sine wave

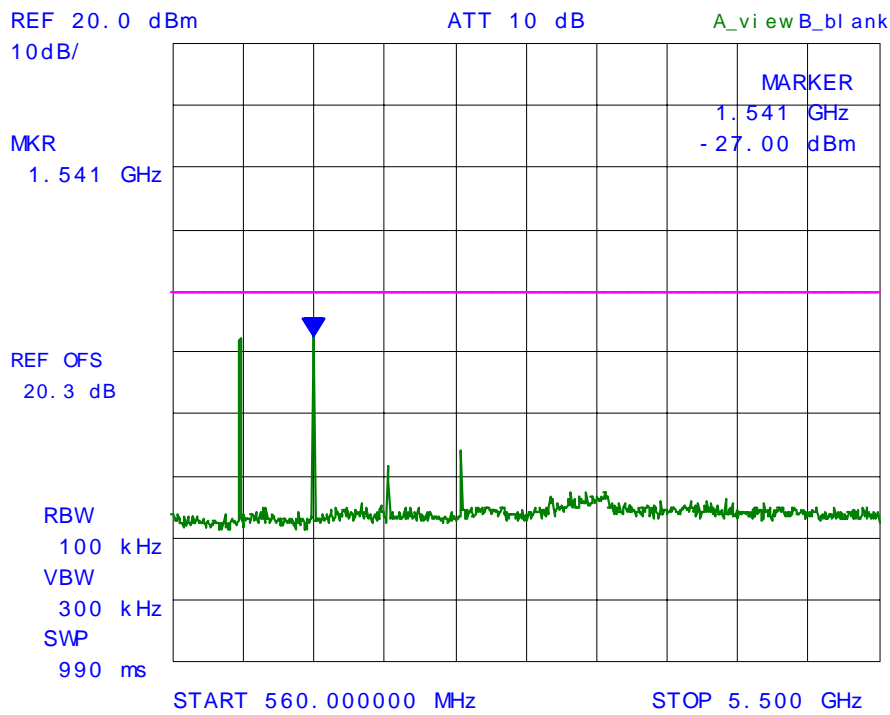

ULTRATECH GROUP OF LABS

3000 Bristol Circle, Oakville, Ontario, Canada L6H 6G4
Tel. #: 905-829-1570, Fax. #: 905-829-8050, Email: vic@ultratech-labs.com, Website: <http://www.ultratech-labs.com>

File #: ICOM-104F90

December 15, 2004

All test results contained in this engineering test report are traceable to National Institute of Standards and Technology (NIST)

Plot 110:
Spurious Emissions at Antenna Terminals
Carrier Frequency: 519.95 MHz
Channel Spacing: 12.5 kHz
Power Level: 1 W
Modulation: FM with 2.5 kHz sine wave

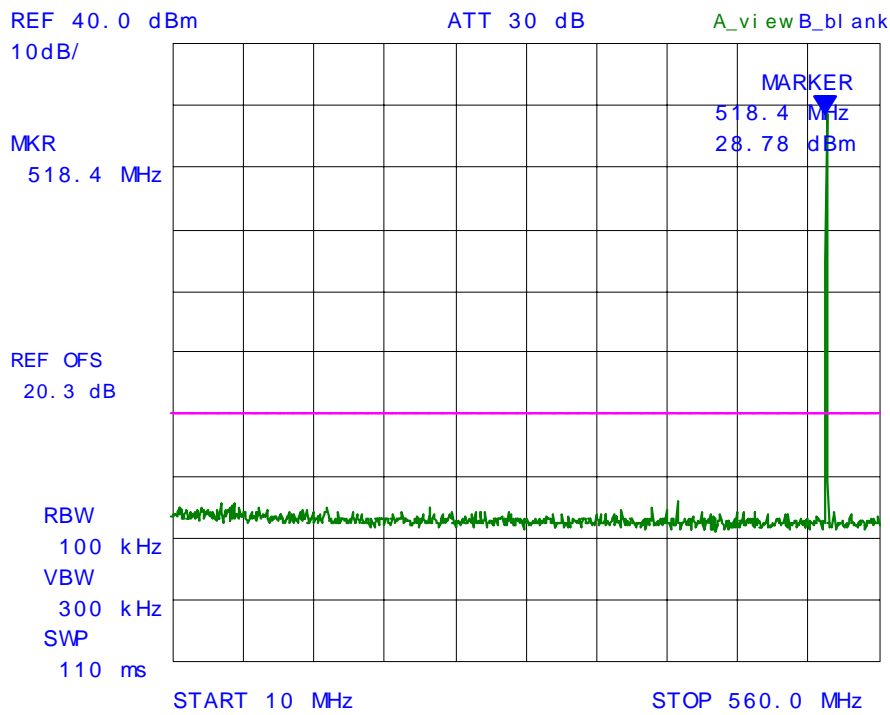

ULTRATECH GROUP OF LABS

3000 Bristol Circle, Oakville, Ontario, Canada L6H 6G4
Tel. #: 905-829-1570, Fax. #: 905-829-8050, Email: vic@ultratech-labs.com, Website: <http://www.ultratech-labs.com>

File #: ICOM-104F90

December 15, 2004

All test results contained in this engineering test report are traceable to National Institute of Standards and Technology (NIST)

Plot 111:
Spurious Emissions at Antenna Terminals
Carrier Frequency: 519.95 MHz
Channel Spacing: 12.5 kHz
Power Level: 1 W
Modulation: FM with 2.5 kHz sine wave

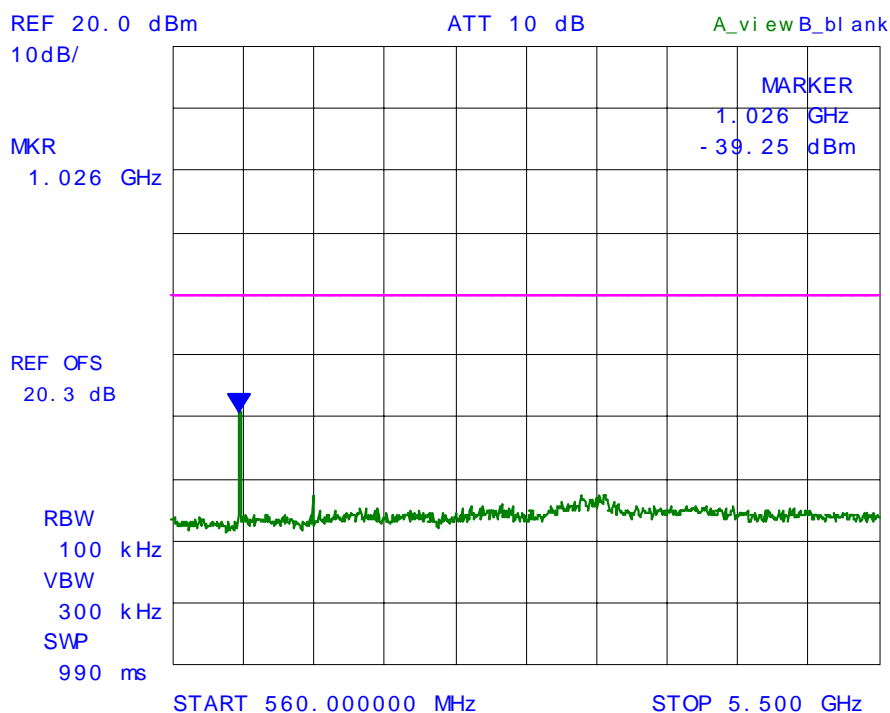

ULTRATECH GROUP OF LABS

3000 Bristol Circle, Oakville, Ontario, Canada L6H 6G4
Tel. #: 905-829-1570, Fax. #: 905-829-8050, Email: vic@ultratech-labs.com, Website: <http://www.ultratech-labs.com>

File #: ICOM-104F90
December 15, 2004

All test results contained in this engineering test report are traceable to National Institute of Standards and Technology (NIST)

6.11. TRANSMITTER SPURIOUS/HARMONIC RADIATED EMISSIONS [§ 90.210]

6.11.1. Limits

Emissions shall be attenuated below the mean output power of the transmitter as follows:

FCC Rules	Frequency Range	Attenuation Limit (dBc)
90.210(b)&(c) – Voice & data	10 MHz to Lowest frequency of the radio to 10 th harmonic of the highest frequency of the radio	43 + 10 log (P) dB
90.210(d) – Voice & data	10 MHz to Lowest frequency of the radio to 10 th harmonic of the highest frequency of the radio	50 + 10 log (P) dB or 70 dB whichever is the lesser attenuation

6.11.2. Method of Measurements

The spurious/harmonic ERP measurements are using substitution method specified in Exhibit 8, § 8.2 of this report and its value in dBc is calculated as follows:

- (1) If the transmitter's antenna is an integral part of the EUT, the ERP is measured using substitution method.
- (2) If the transmitter's antenna is non-integral and diverse, the lowest ERP of the carrier with 0 dBi antenna gain is used for calculation of the spurious/harmonic emissions in dBc:
 Lowest ERP of the carrier = EIRP – 2.15 dB = P_c + G - 2.15 dB = P_c dBm (conducted) + 0 dBi – 2.15 dB
- (3) Spurious /harmonic emissions levels expressed in dBc (dB below carrier) are as follows:

$$\text{ERP of spurious/harmonic (dBc)} = \text{ERP of carrier (dBm)} - \text{ERP of spurious/harmonic emission (dBm)}$$

6.11.3. Test Equipment List

Test Instruments	Manufacturer	Model No.	Serial No.	Frequency Range
Spectrum Analyzer/ EMI Receiver	Hewlett Packard	HP 8546A	...	9 kHz to 5.6 GHz with built-in 30 dB Gain Pre-selector, QP, Average & Peak Detectors.
RF Amplifier	Com-Power	PA-102		1 MHz to 1 GHz, 30 dB gain nominal
Microwave Amplifier	Hewlett Packard	HP 83017A		1 GHz to 26.5 GHz, 30 dB nominal
Biconilog Antenna	EMCO	3142	10005	30 MHz to 2 GHz
Dipole Antenna	EMCO	3121C	8907-434	30 GHz – 1 GHz
Dipole Antenna	EMCO	3121C	8907-440	30 GHz – 1 GHz
Horn Antenna	EMCO	3155	9701-5061	1 GHz – 18 GHz
Horn Antenna	EMCO	3155	9911-5955	1 GHz – 18 GHz
RF Signal Generator	Hewlett Packard	HP 83752B	3610A00457	0.01 – 20 GHz

ULTRATECH GROUP OF LABS

3000 Bristol Circle, Oakville, Ontario, Canada L6H 6G4
 Tel. #: 905-829-1570, Fax. #: 905-829-8050, Email: vic@ultratech-labs.com, Website: <http://www.ultratech-labs.com>

File #: ICOM-104F90
 December 15, 2004

All test results contained in this engineering test report are traceable to National Institute of Standards and Technology (NIST)

6.11.4. Test Data

Remarks:

- The RF spurious/harmonic emission characteristics for narrow band and wide band operation with different modulations are indistinguishable. Therefore, the following radiated emissions were performed at 12.5 kHz channel spacing (narrow band) operation, and the results were compared with the more stringent limit of $50+10*\log(P \text{ in Watts})$ for the worst-case.
- The radiated emissions were performed with high power setting (4 Watts) at 3 meters distance to represent the worst-case test configuration.

6.11.4.1. Near Lowest Frequency (450.05 MHz)

Fundamental Frequency:	450.05 MHz
RF Output Power:	36.00 dBm
Limit:	$50+10*\log(3.98) = 56.0 \text{ dBc}$
Modulation:	FM modulation with 2.5 kHz sine wave signal
Frequency Test Range:	30 MHz – 5.5 GHz

All spurious emissions and harmonics are attenuated more than 20 dB below the limit.

6.11.4.2. Near Middle Frequency (485.05 MHz)

Fundamental Frequency:	485.05 MHz
RF Output Power:	35.91 dBm
Limit:	$50+10*\log(3.90) = 55.9 \text{ dBc}$
Modulation:	FM modulation with 2.5 kHz sine wave signal
Frequency Test Range:	30 MHz – 5.5 GHz

All spurious emissions and harmonics are attenuated more than 20 dB below the limit.

6.11.4.3. Near Highest Frequency (519.95 MHz)

Fundamental Frequency:	519.95 MHz
RF Output Power:	36.13 dBm
Limit:	$50+10*\log(4.10) = 56.1 \text{ dBc}$
Modulation:	FM modulation with 2.5 kHz sine wave signal
Frequency Test Range:	30 MHz – 5.5 GHz

All spurious emissions and harmonics are attenuated more than 20 dB below the limit.

6.12. TRANSIENT FREQUENCY BEHAVIOR [§ 90.214]

6.12.1. Limits

Transient frequencies must be within the maximum frequency difference limits during the time intervals indicated:

Time intervals ^{1, 2}	Maximum frequency difference ³	All equipment	
		150 to 174 MHz	421 to 512MHz
Transient Frequency Behavior for Equipment Designed to Operate on 25 kHz Channels			
t ₁ ⁴	± 25.0 kHz	5.0 ms	10.0 ms
t ₂	± 12.5 kHz	20.0 ms	25.0 ms
t ₃ ⁴	± 25.0 kHz	5.0 ms	10.0 ms
Transient Frequency Behavior for Equipment Designed to Operate on 12.5 kHz Channels			
t ₁ ⁴	± 12.5 kHz	5.0 ms	10.0 ms
t ₂	± 6.25 kHz	20.0 ms	25.0 ms
t ₃ ⁴	± 12.5 kHz	5.0 ms	10.0 ms

- t_{on} is the instant when a 1 kHz test signal is completely suppressed, including any capture time due to phasing.
 t₁ is the time period immediately following t_{on}.
 t₂ is the time period immediately following t₁.
 t₃ is the time period from the instant when the transmitter is turned off until t_{off}.
 t_{off} is the instant when the 1 kHz test signal starts to rise.
- During the time from the end of t₂ to the beginning of t₃, the frequency difference must not exceed the limits specified in § 90.213.
- Difference between the actual transmitter frequency and the assigned transmitter frequency.
- If the transmitter carrier output power rating is 6 watts or less, the frequency difference during this time period may exceed the maximum frequency difference for this time period.

6.12.2. Method of Measurements

Refer to Exhibit 8, Section 8.6 of this test report and ANSI/TIA-603-B, Section 2.2.19.

6.12.3. Test Equipment List

Test Instruments	Manufacturer	Model No.	Serial No.	Frequency Range
Radio Communication	Marconi	2955	132037/226	20Hz – 20kHz
RF Synthesized Signal Generator	Gigatronic	6061A	5130408	10kHz – 1050 MHz
Network Combiner	Mini-Circuit	ZFSC-3-4	15542	1 – 1000 MHz
Infinium Digitizing Oscilloscope	Hewlett Packard	54810A	US38380192	DC - 500 MHz, 1 Gsa/s
RF Detector	Narda	503A-03	105	10 MHz - GHz
Attenuator	Weinschel	23-20-34	BH7876	DC - 18GHz
Modulation Analyzer	Hewlett Packard	8901B	3226A04606	150 kHz – 1300 MHz
Digital Multimeter	Rohde & Schwartz	UDS5	872984/067	DC-100kHz

6.12.4. Test Arrangement

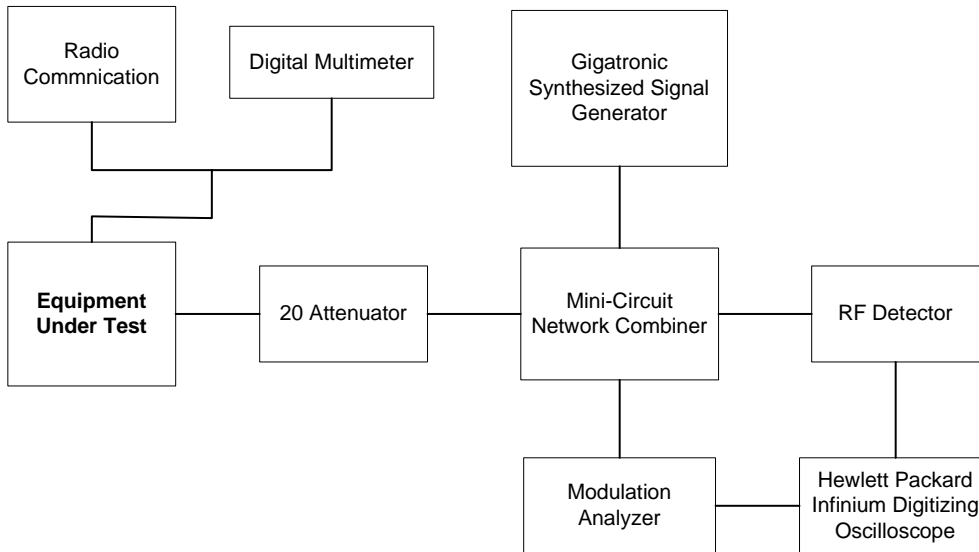

6.12.5. Test Data

6.12.5.1. 12.5 kHz Channel Spacing Operation

Plot 112:
Transient Frequency Behavior
Carrier Frequency: 450.05MHz
Channel Spacing: 12.5 kHz
Power Level: 4 W
Modulation: Unmodulated
Description: Switch on condition t_{on} , t_1 , and t_2

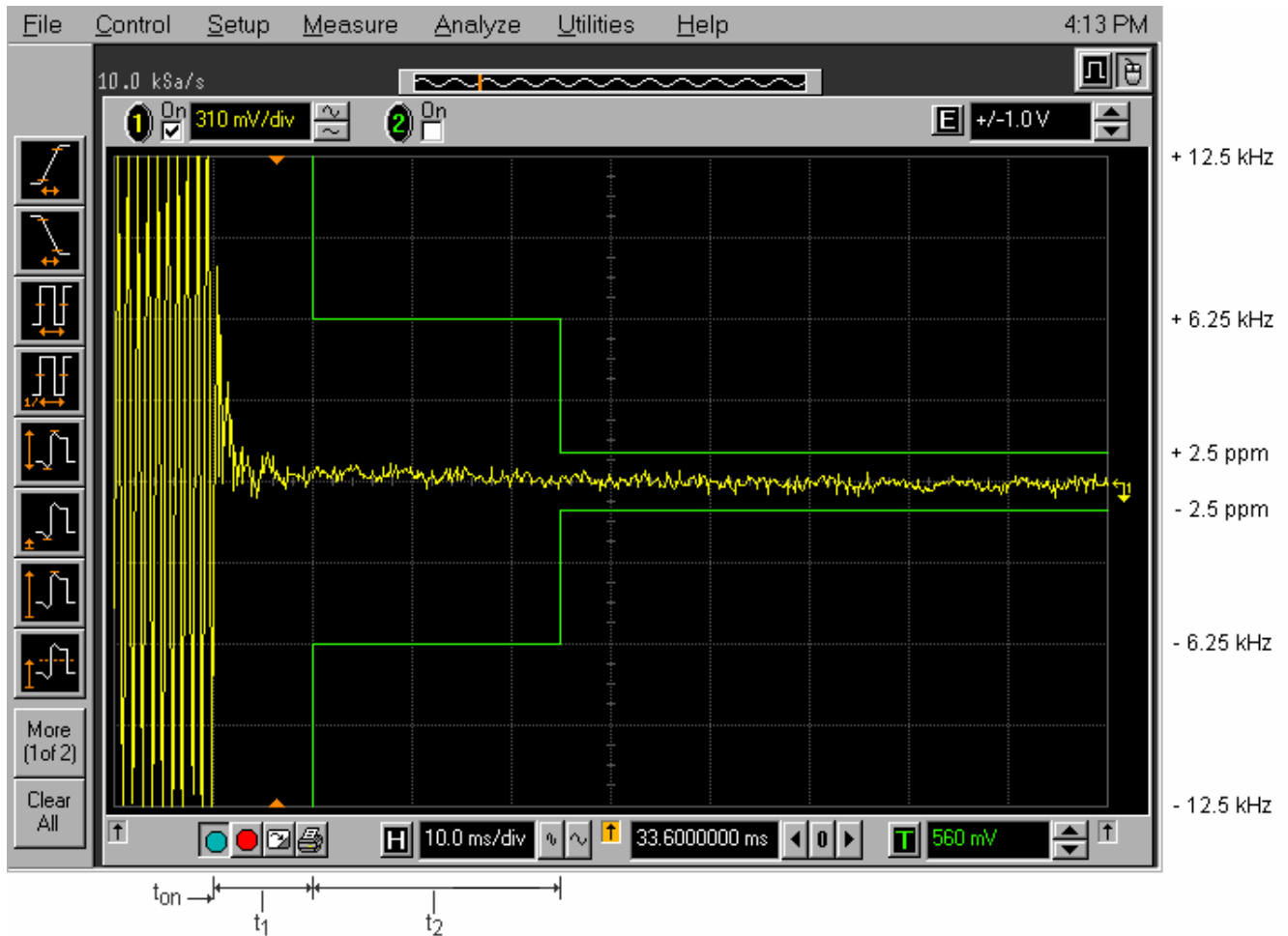

ULTRATECH GROUP OF LABS

3000 Bristol Circle, Oakville, Ontario, Canada L6H 6G4
Tel. #: 905-829-1570, Fax. #: 905-829-8050, Email: vic@ultratech-labs.com, Website: <http://www.ultratech-labs.com>

File #: ICOM-104F90
December 15, 2004

All test results contained in this engineering test report are traceable to National Institute of Standards and Technology (NIST)

Plot 113:
Transient Frequency Behavior
Carrier Frequency: 450.05MHz
Channel Spacing: 12.5 kHz
Power Level: 4 W
Modulation: Unmodulated
Description: Switch off condition t_3 , t_{off}

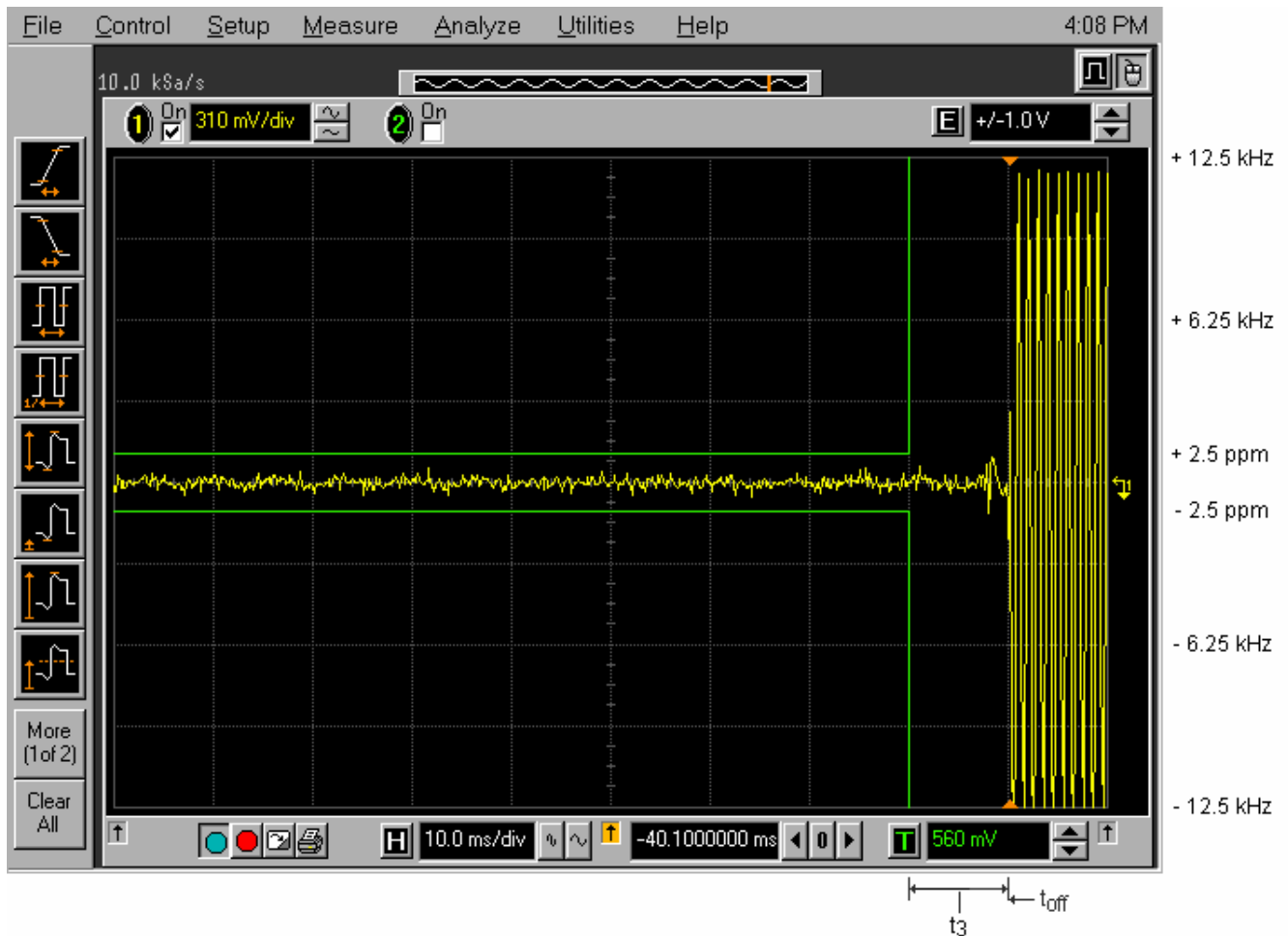

ULTRATECH GROUP OF LABS

3000 Bristol Circle, Oakville, Ontario, Canada L6H 6G4
Tel. #: 905-829-1570, Fax. #: 905-829-8050, Email: vic@ultratech-labs.com, Website: <http://www.ultratech-labs.com>

File #: ICOM-104F90
December 15, 2004

All test results contained in this engineering test report are traceable to National Institute of Standards and Technology (NIST)

6.12.5.2. 25 kHz Channel Spacing Operation

Plot 114:
Transient Frequency Behavior
Carrier Frequency: 450.05MHz
Channel Spacing: 25 kHz
Power Level: 4 W
Modulation: Unmodulated
Description: Switch on condition t_{on} , t_1 , and t_2

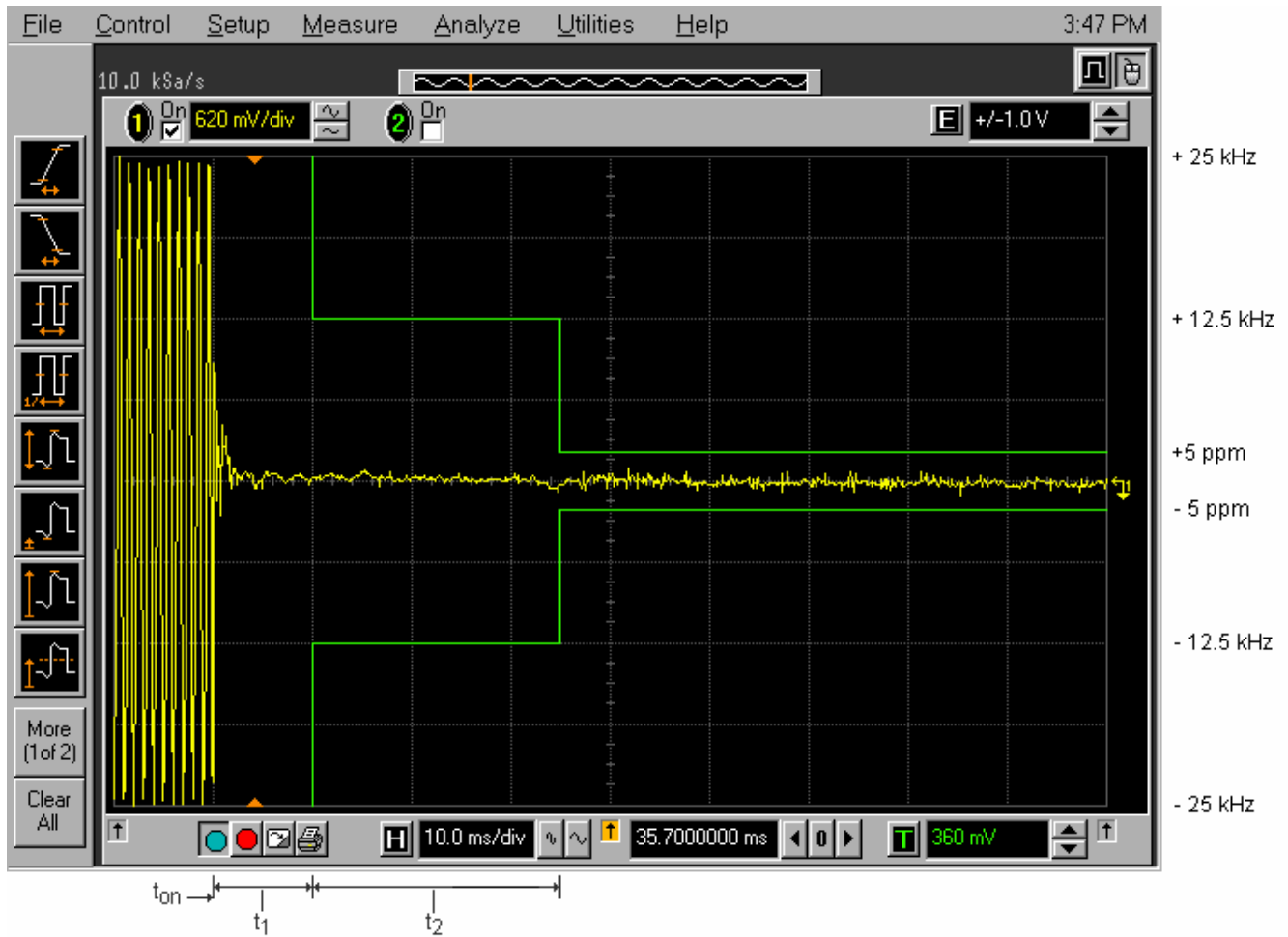

Plot 115:
Transient Frequency Behavior
Carrier Frequency: 450.05MHz
Channel Spacing: 25 kHz
Power Level: 4 W
Modulation: Unmodulated
Description: Switch off condition t_3 , t_{off}

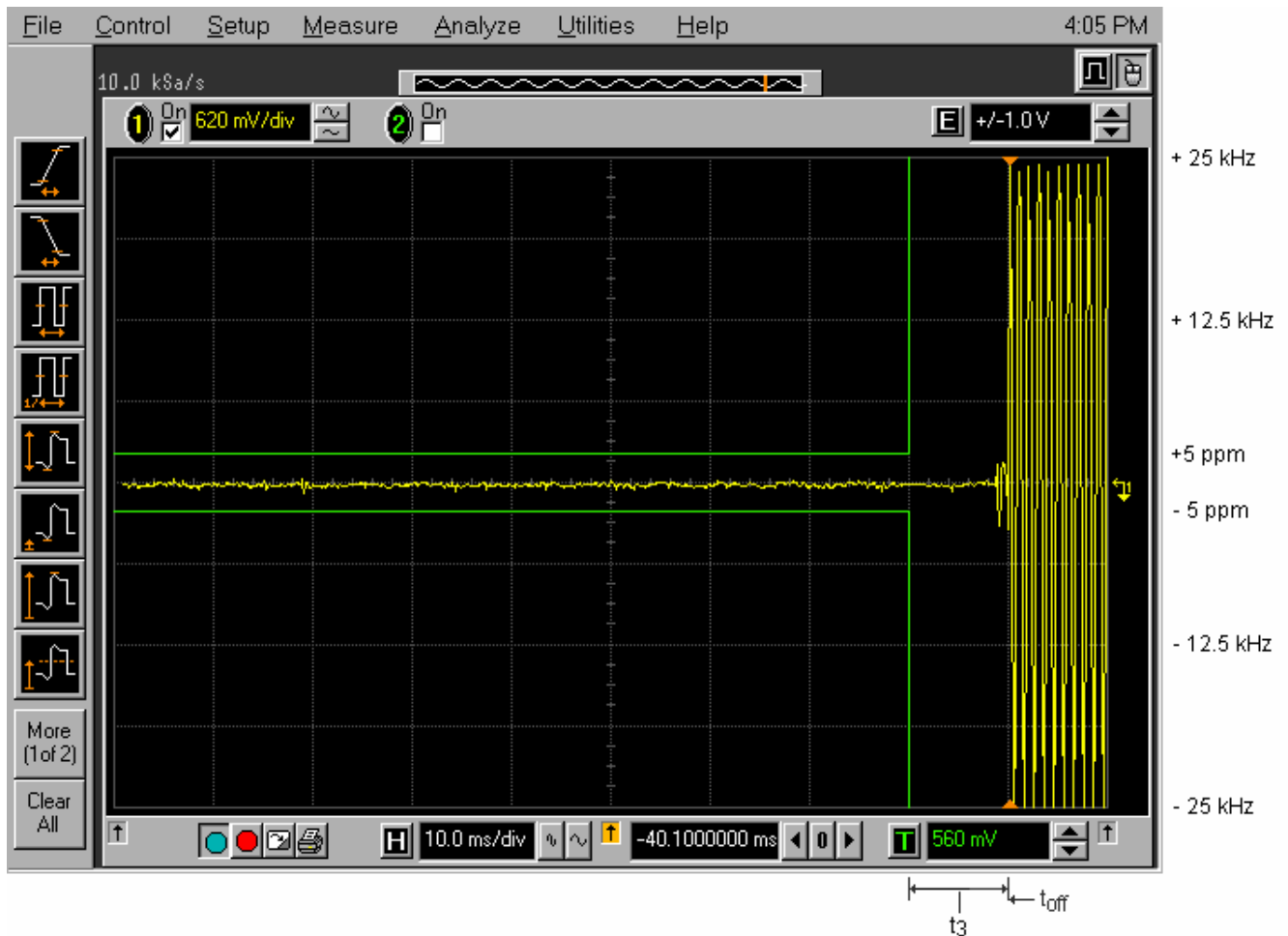

ULTRATECH GROUP OF LABS

3000 Bristol Circle, Oakville, Ontario, Canada L6H 6G4
Tel. #: 905-829-1570, Fax. #: 905-829-8050, Email: vic@ultratech-labs.com, Website: <http://www.ultratech-labs.com>

File #: ICOM-104F90
December 15, 2004

All test results contained in this engineering test report are traceable to National Institute of Standards and Technology (NIST)

EXHIBIT 7. MEASUREMENT UNCERTAINTY

The measurement uncertainties stated were calculated in accordance with the requirements of NIST Technical Note 1297 and NIS 81 (1994)

7.1. RADIATED EMISSION MEASUREMENT UNCERTAINTY

CONTRIBUTION (Radiated Emissions)	PROBABILITY DISTRIBUTION	UNCERTAINTY (+ dB)	
		3 m	10 m
Antenna Factor Calibration	Normal (k=2)	± 1.0	± 1.0
Cable Loss Calibration	Normal (k=2)	± 0.3	± 0.5
EMI Receiver specification	Rectangular	± 1.5	± 1.5
Antenna Directivity	Rectangular	+0.5	+0.5
Antenna factor variation with height	Rectangular	± 2.0	± 0.5
Antenna phase center variation	Rectangular	0.0	± 0.2
Antenna factor frequency interpolation	Rectangular	± 0.25	± 0.25
Measurement distance variation	Rectangular	± 0.6	± 0.4
Site imperfections	Rectangular	± 2.0	± 2.0
Mismatch: Receiver VRC $\Gamma_1 = 0.2$ Antenna VRC $\Gamma_R = 0.67(Bi) 0.3 (Lp)$ Uncertainty limits $20\text{Log}(1 \pm \Gamma_1 \Gamma_R)$	U-Shaped	+1.1 -1.25	± 0.5
System repeatability	Std. Deviation	± 0.5	± 0.5
Repeatability of EUT		-	-
Combined standard uncertainty	Normal	+2.19 / -2.21	+1.74 / -1.72
Expanded uncertainty U	Normal (k=2)	+4.38 / -4.42	+3.48 / -3.44

Calculation for maximum uncertainty when 3m biconical antenna including a factor of k = 2 is used:

$$U = 2u_c(y) = 2x(+2.19) = +4.38 \text{ dB} \quad \text{And} \quad U = 2u_c(y) = 2x(-2.21) = -4.42 \text{ dB}$$

EXHIBIT 8. MEASUREMENT METHODS

8.1. CONDUCTED POWER MEASUREMENTS

- The following shall be applied to the combination(s) of the radio device and its intended antenna(e).
- If the RF level is user adjustable, all measurements shall be made with the highest power level available to the user for that combination.
- The following method of measurement shall apply to both conducted and radiated measurements.
- The radiated measurements are performed at the Ultratech Calibrated Open Field Test Site.
- The measurement shall be performed using normal operation of the equipment with modulation.

Test procedure shall be as follows:

Step 1: Duty Cycle measurements if the transmitter's transmission is transient

- Using a EMI Receiver with the frequency span set to 0 Hz and the sweep time set at a suitable value to capture the envelope peaks and the duty cycle of the transmitter output signal;
- The duty cycle of the transmitter, $x = \text{Tx on} / (\text{Tx on} + \text{Tx off})$ with $0 < x < 1$, is measure and recorded in the test report. For the purpose of testing, the equipment shall be operated with a duty cycle that is equal or more than 0.1.

Step 2: Calculation of Average EIRP. See Figure 1

- The average output power of the transmitter shall be determined using a wideband, calibrated RF average power meter with the power sensor with an integration period that exceeds the repetition period of the transmitter by a factor 5 or more. The observed value shall be recorded as "A" (in dBm);
- The e.i.r.p. shall be calculated from the above measured power output "A", the observed duty cycle x, and the applicable antenna assembly gain "G" in dBi, according to the formula:

$$\text{EIRP} = \text{A} + \text{G} + 10\log(1/x)$$

{X = 1 for continuous transmission => $10\log(1/x) = 0$ dB}

Figure 1.

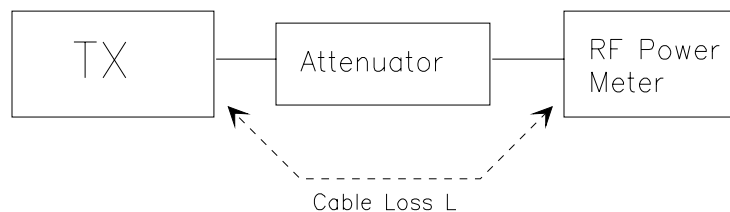

8.2. RADIATED POWER MEASUREMENTS (ERP & EIRP) USING SUBSTITUTION METHOD

8.2.1. MAXIMIZING RF EMISSION LEVEL (E-FIELD)

- (a) The measurements was performed with full rf output power and modulation.
- (b) Test was performed at listed 3m open area test site (listed with FCC, IC, ITI, NVLAP, ACA & VCCI).
- (c) The transmitter under test was placed at the specified height on a non-conducting turntable (80 cm height)
- (d) The BICONILOG antenna (20 MHz to 1 GHz) or HORN antenna (1 GHz to 18 GHz) was used for measuring.
- (e) Load an appropriate correction factors file in EMI Receiver for correcting the field strength reading level

Total Correction Factor recorded in the EMI Receiver = Cable Loss + Antenna Factor
 $E \text{ (dB}\mu\text{V/m)} = \text{Reading (dB}\mu\text{V)} + \text{Total Correction Factor (dB/m)}$

- (f) Set the EMI Receiver and #2 as follows:

Center Frequency: test frequency
Resolution BW: 100 kHz
Video BW: same
Detector Mode: positive
Average: off
Span: 3 x the signal bandwidth

- (g) The test antenna was lowered or raised from 1 to 4 meters until the maximum signal level was detected.
- (h) The transmitter was rotated through 360° about a vertical axis until a higher maximum signal was received.
- (i) The test antenna was lowered or raised again from 1 to 4 meters until a maximum was obtained. This level was recorded.
- (j) The recorded reading was corrected to the true field strength level by adding the antenna factor, cable loss and subtracting the pre-amplifier gain.
- (k) The above steps were repeated with both transmitters' antenna and test receiving antenna placed in vertical and horizontal polarization. Both readings with the antennas placed in vertical and horizontal polarization shall be recorded.
- (l) Repeat for all different test signal frequencies

8.2.2. Measuring the EIRP of Spurious/Harmonic Emissions using Substitution Method

(a) Set the EMI Receiver (for measuring E-Field) and Receiver #2 (for measuring EIRP) as follows:

Center Frequency: equal to the signal source
Resolution BW: 10 kHz
Video BW: same
Detector Mode: positive
Average: off
Span: 3 x the signal bandwidth

(b) Load an appropriate correction factors file in EMI Receiver for correcting the field strength reading level

Total Correction Factor recorded in the EMI Receiver = Cable Loss + Antenna Factor
 $E \text{ (dBuV/m)} = \text{Reading (dBuV)} + \text{Total Correction Factor (dB/m)}$

(c) Select the frequency and E-field levels obtained in the Section 8.2.1 for ERP/EIRP measurements.

(d) Substitute the EUT by a signal generator and one of the following transmitting antenna (substitution antenna):

- ◆ DIPOLE antenna for frequency from 30-1000 MHz or
- ◆ HORN antenna for frequency above 1 GHz }

(e) Mount the transmitting antenna at 1.5 meter high from the ground plane.

(f) Use one of the following antenna as a receiving antenna:

- ◆ DIPOLE antenna for frequency from 30-1000 MHz or
- ◆ HORN antenna for frequency above 1 GHz }

(g) If the DIPOLE antenna is used, tune it's elements to the frequency as specified in the calibration manual.

(h) Adjust both transmitting and receiving antenna in a VERTICAL polarization.

(i) Tune the EMI Receivers to the test frequency.

(j) Lower or raise the test antenna from 1 to 4 meters until the maximum signal level was detected.

(k) The transmitter was rotated through 360° about a vertical axis until a higher maximum signal was received.

(l) Lower or raise the test antenna from 1 to 4 meters until the maximum signal level was detected.

(m) Adjust input signal to the substitution antenna until an equal or a known related level to that detected from the transmitter was obtained in the test receiver.

(n) Record the power level read from the Average Power Meter and calculate the ERP/EIRP as follows:

$$P = P1 - L1 = (P2 + L2) - L1 = P3 + A + L2 - L1$$

$$EIRP = P + G1 = P3 + L2 - L1 + A + G1$$

$$ERP = EIRP - 2.15 \text{ dB}$$

$$\text{Total Correction factor in EMI Receiver \# 2} = L2 - L1 + G1$$

Where: P: Actual RF Power fed into the substitution antenna port after corrected.

P1: Power output from the signal generator

P2: Power measured at attenuator A input

P3: Power reading on the Average Power Meter

EIRP: EIRP after correction

ERP: ERP after correction

(o) Adjust both transmitting and receiving antenna in a HORIZONTAL polarization, then repeat step (k) to (o)

(p) Repeat step (d) to (o) for different test frequency

(q) Repeat steps (c) to (j) with the substitution antenna oriented in horizontal polarization.

(r) Actual gain of the EUT's antenna is the difference of the measured EIRP and measured RF power at the RF port. Correct the antenna gain if necessary.

Figure 2

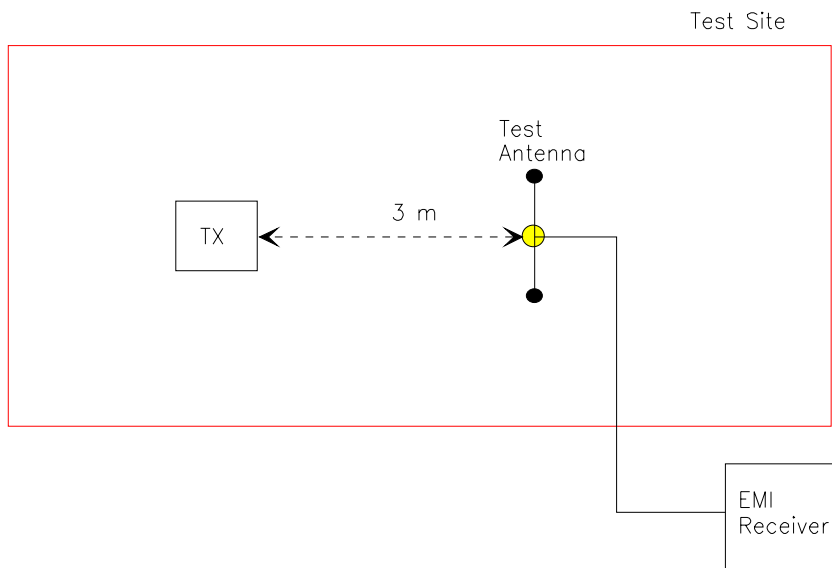
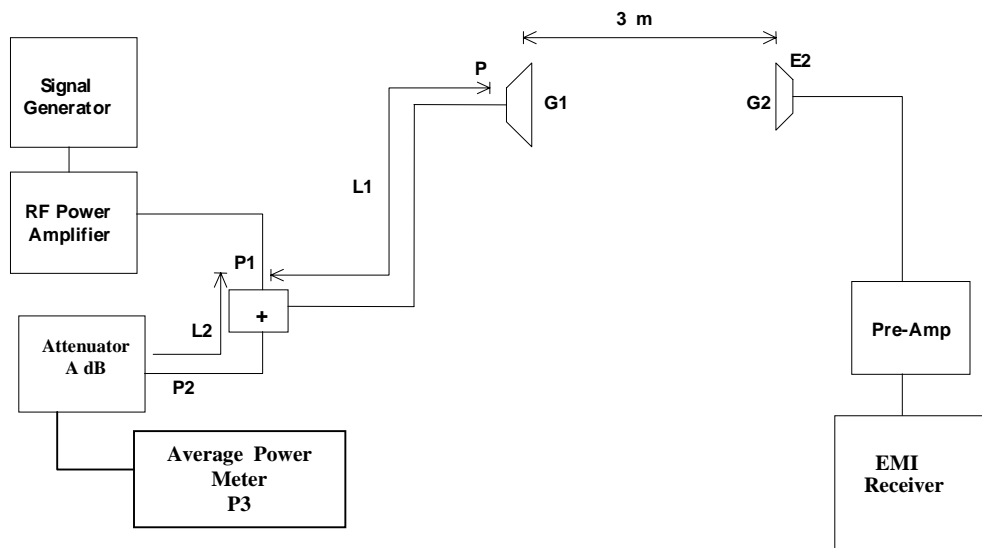

Figure 3



8.3. FREQUENCY STABILITY

Refer to FCC @ 2.1055.

- (a) The frequency stability shall be measured with variation of ambient temperature as follows: From -30 to +50 centigrade except that specified in subparagraph (2) & (3) of this paragraph.
- (b) Frequency measurements shall be made at extremes of the specified temperature range and at intervals of not more than 10 centigrade through the range. A period of time sufficient to stabilize all of the components of the oscillator circuit at each temperature level shall be allowed prior to frequency measurement. The short-term transient effects on the frequency of the transmitter due to keying (except for broadcast transmitters) and any heating element cycling normally occurring at each ambient temperature level also shall be shown. Only the portion or portions of the transmitter containing the frequency determining and stability circuitry need be subjected to the temperature variation test.
- (d) The frequency stability supply shall be measured with variation of primary supply voltage as follows:
 - (1) Vary primary supply voltage from 85 to 115 percent of the nominal value for other than hand carried battery equipment.
 - (2) For hand carried, battery powered equipment, reduce primary supply voltage to the battery operating end point which shall be specified by the manufacturer.
 - (3) The supply voltage shall be measured at the input to the cable normally provide with the equipment, or at the power supply terminals if cables are not normally provided. Effects on frequency of transmitter keying (except for broadcast transmitters) and any heating element cycling at the nominal supply voltage and at each extreme also shall be shown.
- (e) When deemed necessary, the Commission may require tests of frequency stability under conditions in addition to those specifically set out in paragraphs (a), (b), (c) and (d) of this section. (For example, measurements showing the effect of proximity to large metal objects, or of various types of antennas, may be required for portable equipment).

8.4. EMISSION MASK

Voice or Digital Modulation Through a Voice Input Port @ 2.1049(c)(i):- The transmitter was modulated by a 2.5 KHz tone signal at an input level 16 dB greater than that required to produce 50% modulation (e.g.: ± 2.5 KHz peak deviation at 1 KHz modulating frequency). The input level was established at the frequency of maximum response of the audio modulating circuit.

Digital Modulation Through a Data Input Port @ 2.1049(h):- Transmitters employing digital modulation techniques - when modulated by an input signal such that its amplitude and symbol rate represent the maximum rated conditions under which the equipment will be operated. The signal shall be applied through any filter networks, pseudo-random generators or other devices required in normal service. Additionally, the Emission Masks shall be shown for operation with any devices used for modifying the spectrum when such devices are operational at the discretion of the user.

The following EMI Receiver bandwidth shall be used for measurement of Emission Mask/Out-of-Band Emission Measurements:

- (1) For 25 kHz Channel Spacing: RBW = 300 Hz
- (2) For 12.5 kHz or 6.25 kHz Channel Spacings: RBW = 100 Hz

The all cases the Video Bandwidth shall be equal or greater than the measuring bandwidth.

8.5. SPURIOUS EMISSIONS (CONDUCTED)

With transmitter modulation characteristics described in Out-of-Band Emissions measurements @ 2.1049, the transmitter spurious and harmonic emissions were scanned. The spurious and harmonic emissions were measured with the EMI Receiver controls set as RBW = 30 kHz minimum , VBW \geq RBW and SWEEP TIME = AUTO). The transmitter was operated at a full rated power output, and modulated as follows:

FCC 47 CFR 2.1057 - Frequency spectrum to be investigated: The spectrum was investigated from the lowest radio generated in the equipment up to at least the 10th harmonic of the carrier frequency or to the highest frequency practicable in the present state of the art of measuring techniques, whichever is lower. Particular attention should be paid to harmonics and subharmonics of the carrier frequency. Radiation at the frequencies of multiplier stages should be checked. The amplitude of spurious emissions which are attenuated more than 20 dB below the permissible value need not be reported.

FCC 47 CFR 2.1051 - Spurious Emissions at Antenna Terminal: The radio frequency voltage or powers generated within the equipment and appearing on a spurious frequency shall be checked at the equipment output terminals when properly loaded with a suitable artificial antenna. Curves or equivalent data shall show the magnitude of the harmonic and other spurious emission that can be detected when the equipment is operated under the conditions specified in 2.1049 as appropriate. The magnitude of spurious emissions which are attenuated more than 20 dB below the permissible value need not be specified.

8.6. TRANSIENT FREQUENCY BEHAVIOR

1. Connect the transmitter under tests as shown in the above block diagram
2. Set the signal generator to the assigned frequency and modulate with a 1 kHz tone at ± 12.5 kHz deviation and its output level to be 50 dB below the transmitter rf output at the test receiver end.
3. Set the horizontal sweep rate on the storage scope to 10 milliseconds per division and adjust the display to continuously view the 1000 Hz tone from the Demodulator Output Port (DOP) of the Test Receiver. Adjust the vertical scale amplitude control of the scope to display the 1000 Hz at ± 4 divisions vertical Center at the display.
4. Adjust the scope so it will trigger on an increasing magnitude from the RF trigger signal of the transmitter under test when the transmitter was turned on. Set the controls to store the display.
5. The output at the DOP, due to the change in the ratio of the power between the signal generator input power and transmitter output power will, because of the capture effect of the test receiver, produce a change in display: For the first part of the sweep it will show the 1 kHz test signal. Then once the receiver's demodulator has been captured by the transmitter power, the display will show the frequency difference from the assigned frequency to the actual transmitter frequency versus time. The instant when the 1 kHz test signal is completely suppressed (including any capture time due to phasing) is considered to be t_{on} . The trace should be maintained within the allowed divisions during the period t_1 and t_2 .
6. During the time from the end of t_2 to the beginning of t_3 the frequency difference should not exceed the limits set by the FCC in Part 90.214 and the outlined in the Carrier Frequency Stability sections. The allowed limit is equal to FCC frequency tolerance limits specified in FCC 90.213.
7. Repeat the above steps when the transmitter was turned off for measuring t_3 .