



## INSTRUCTION MANUAL

VHF TRANSCEIVER

# IC-F33GT/GS

UHF TRANSCEIVER

# IC-F43GT/GS

This device complies with Part 15 of the FCC Rules. Operation is subject to the condition that this device does not cause harmful interference.

Icom Inc.

**MDC 1200**  
Compatible



---

## IMPORTANT

---

**READ ALL INSTRUCTIONS** carefully and completely before using the transceiver.

**SAVE THIS INSTRUCTION MANUAL** — This instruction manual contains important operating instructions for the **IC-F33GT/GS VHF TRANSCEIVER** and **IC-F43GT/GS UHF TRANSCEIVER**.

---

## EXPLICIT DEFINITIONS

---

WORD	DEFINITION
<b>⚠ DANGER</b>	Personal death, serious injury or an explosion may occur.
<b>⚠ WARNING</b>	Personal injury, fire hazard or electric shock may occur.
<b>CAUTION</b>	Equipment damage may occur.
<b>NOTE</b>	If disregarded, inconvenience only. No risk of personal injury, fire or electric shock.

Icom, Icom Inc. and the Icom logo are registered trademarks of Icom Incorporated (Japan) in Japan, the United states, the United Kingdom, Germany, France, Spain, Russia and/or other countries.

---

## PRECAUTION

---

**⚠ CAUTION! NEVER** hold the transceiver so that the antenna is very close to, or touching exposed parts of the body, especially the face or eyes, while transmitting. The transceiver will perform best if the microphone is 2 to 4 in. (5 to 10 cm) away from the lips and the transceiver is vertical.

**⚠ CAUTION! NEVER** operate the transceiver with a headset or other audio accessories at high volume levels.

**⚠ CAUTION! NEVER** short the terminals of the battery pack.

**DO NOT** push PTT when not actually desiring to transmit.

**DO NOT** use or place the transceiver in direct sunlight or in areas with temperatures below +22°F (−30°C) or above +140°F (+60°C).

The basic operations, transmission and reception of the transceiver are guaranteed within the specified operating temperature range. However, the LCD display may not be operate correctly, or show an indication in the case of long hours of operation, or after being placed in extremely cold areas.

---

---

**DO NOT** modify the transceiver for any reason.

**KEEP** the transceiver from the heavy rain, and **Never** immerse it in the water. The transceiver construction is **water resistant**, not waterproof.

The use of non-Icom battery packs/chargers may impair transceiver performance and invalidate the warranty.

Icom optional equipment is designed for optimal performance when used with this transceiver. We are not responsible for the transceiver being damaged or any accident caused when using non-Icom optional equipment.

***For U.S.A. only***

**CAUTION:** Changes or modifications to this transceiver, not expressly approved by Icom Inc., could void your authority to operate this transceiver under FCC regulations.

---

# TABLE OF CONTENTS

---

IMPORTANT .....	i	■ Stun function .....	26
EXPLICIT DEFINITIONS .....	i	■ BIIS indication .....	26
PRECAUTION .....	i	■ Priority A channel selection .....	26
TABLE OF CONTENTS .....	iii	■ Man Down Emergency Call .....	27
<b>1 ACCESSORIES .....</b>	<b>1-3</b>	<b>5 MDC 1200 OPERATION .....</b>	<b>28-33</b>
■ Supplied accessories .....	1	■ MDC 1200 system operation .....	28
■ Accessory attachments .....	1	■ Transmitting a call .....	28
<b>2 PANEL DESCRIPTION .....</b>	<b>4-10</b>	■ Receiving a call .....	33
■ Front panel .....	4	<b>6 OPTIONAL UNIT INSTALLATION .....</b>	<b>34-35</b>
■ Function display .....	6	■ Optional unit installation .....	34
■ Programmable function keys .....	7	■ UT-109 and UT-110 installation .....	35
<b>3 BASIC OPERATION .....</b>	<b>11-15</b>	<b>7 BATTERY CHARGING .....</b>	<b>36-40</b>
■ Turning power ON .....	11	■ Caution .....	36
■ Channel selection .....	11	■ Optional battery chargers .....	38
■ Call procedure .....	12	<b>8 BATTERY CASE .....</b>	<b>41</b>
■ Receiving and transmitting .....	12	■ Optional battery case (BP-240) .....	41
■ User Set mode .....	15	<b>9 SWIVEL BELT CLIP .....</b>	<b>42-43</b>
■ Scrambler function .....	15	■ MB-93 contents .....	42
<b>4 BIIS OPERATION .....</b>	<b>16-27</b>	■ To attach .....	42
■ Default setting .....	16	■ To detach .....	43
■ Receiving a call .....	16	<b>10 OPTIONS .....</b>	<b>44-45</b>
■ Transmitting a call .....	18	<b>11 SAFETY TRAINING INFORMATION .....</b>	<b>46-47</b>
■ Receiving a message .....	20		
■ Transmitting a status .....	22		
■ Transmitting an SDM .....	23		
■ Position data transmission .....	25		
■ Printer connection .....	25		
■ Digital ANI .....	25		
■ Auto emergency transmission .....	26		

## ■ Supplied accessories

The following accessories are supplied:	Qty.
① Flexible antenna.....	1
② Battery pack.....	1
③ Belt clip.....	1
④ Unit cover (double-sided tape)*.....	1
⑤ Jack cover (with screws).....	1 set

\*Use the unit cover as a spare. Ask your dealer for details.

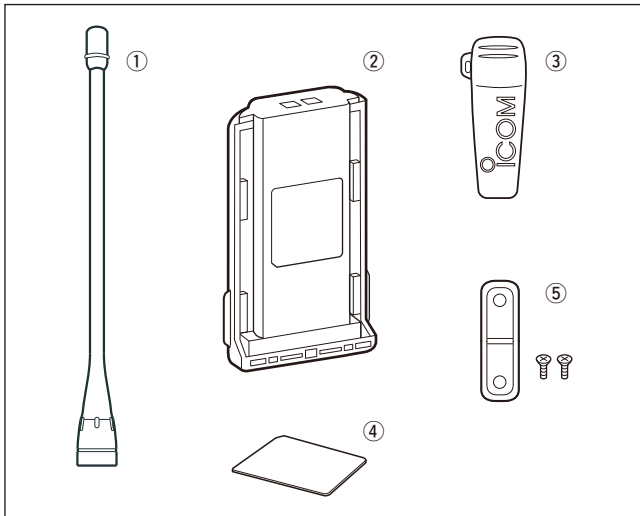

## ■ Accessory attachments

### ◇ Flexible antenna

Connect the supplied flexible antenna to the antenna connector.

#### CAUTION:

- NEVER HOLD by the antenna when carrying the transceiver.
- Transmitting without an antenna may damage the transceiver.

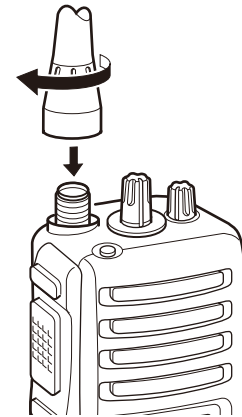

# 1 ACCESSORIES

## ◇ Battery pack

### *To attach the battery pack:*

Slide the battery pack in the direction of the arrow (❶), then lock it with the battery release button.

- Slide the battery pack until the battery release button makes a 'click' sound.

### *To release the battery pack:*

Push the battery release button in the direction of the arrow (❷) as shown below. The battery pack is then released.

**NEVER** release or attach the battery pack when the transceiver is wet or soiled. This may result water or dust getting into the transceiver/battery pack and may result in the transceiver being damaged.

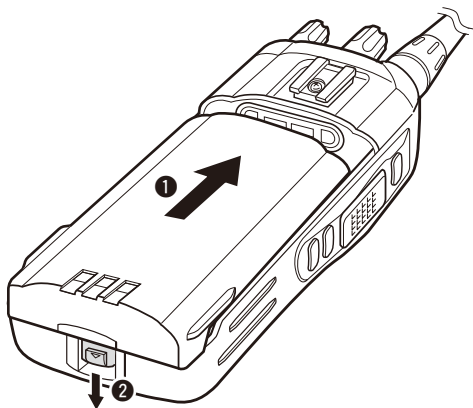

## ◇ Belt clip

### *To attach the belt clip:*

- ❶ Release the battery pack if it is attached.
- ❷ Slide the belt clip in the direction of the arrow until the belt clip is locked and makes a 'click' sound.

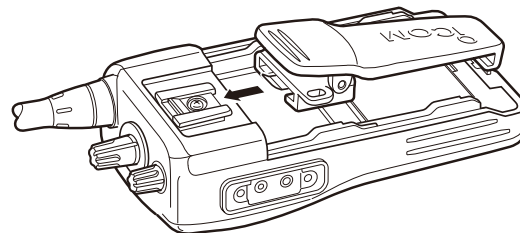

### *To detach the belt clip:*

- ❶ Release the battery pack if it is attached.
- ❷ Pinch the clip (❶), and slide the belt clip in the direction of the arrow (❷).

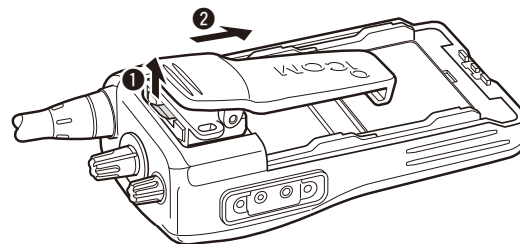

### ◇ Jack cover

Attach the jack cover when the optional speaker-microphone is not used.

#### **To attach the jack cover:**

- 1 Attach the jack cover on the [SP]/[MIC] jack.
- 2 Tighten the screws.

#### **To detach the jack cover:**

- 1 Unscrew the screws with a Phillips screwdriver.
- 2 Detach the jack cover for the speaker-microphone connection.

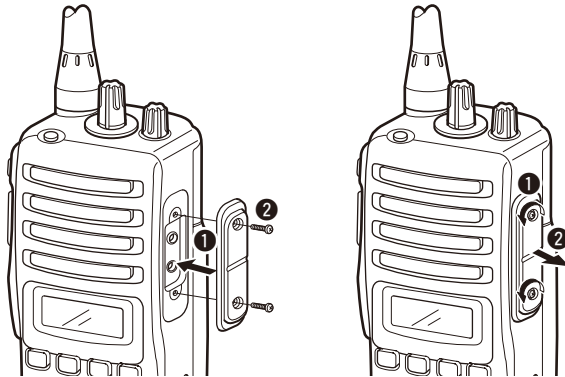

## ■ Front panel

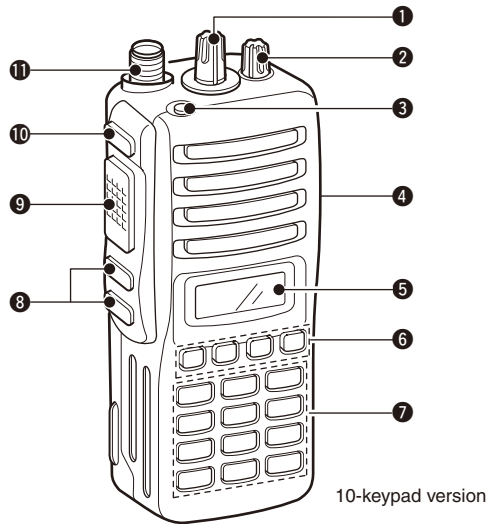

### 1 ROTARY SELECTOR

Rotate to select the pre-programmed memory channels or the operating bank.  
(Depending on the pre-setting)

### 2 VOLUME CONTROL [VOL]

Rotate to turn the power ON/OFF and adjusts the audio level.

### 3 DEALER-PROGRAMMABLE KEY [RED]

Desired function can be programmed by your dealer.  
(p. 7)

### 4 [SP]/[MIC] JACK

Connect the optional speaker-microphone.

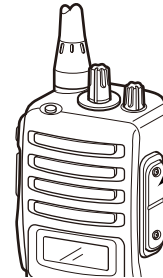

[SP]/[MIC] jack cover

**NOTE:** Attach the [SP]/[MIC] jack cover when the optional speaker-microphone is not used.  
(See p. 3 for details)

### 5 FUNCTION DISPLAY

Displays a variety of information such as an operating channel number/name, 2/5-tone code, DTMF numbers, selected function, etc.

### 6 DEALER-PROGRAMMABLE KEYS [P0] to [P3]

Desired functions can be programmed independently by your dealer. (p. 7)



**7 10-KEYPAD** (Depending on version)

The keypad allows you to enter digits to:

- Select memory channels
- Select tone channels
- Select DTMF codes (during transmit)
- Set TX codes
- Set BIIS status number
- Input text message for SDM operation
- Start up with the password

**8 UP/DOWN KEYS**

- Push to select an operating channel.
- Push to select a TX code channel after pushing [TX CODE CH SELECT].
- Push to select a DTMF channel after pushing [DTMF].
- Push to select a scan group after pushing and holding [SCAN].
- Push to select a BIIS code, status number or SDM after pushing [DIGITAL].

\*Desired functions can be programmed independently by your dealer. (p. 7)

**9 PTT SWITCH [PTT]**

- Push and hold to transmit; release to receive.
- Push to transmit the call during MSK operation, depending on the setting.

**10 MONITOR KEY**

- Mute and release the CTCSS (DTCS) or 2-tone squelch mute. Open any squelch/deactivate any mute while pushing this key. (LMR operation only)
- Activates one of (or two of) the following functions on each channel independently. (PMR or BIIS PMR operation only)
  - Push and hold the key to unmute the channel (audio is emitted; 'audible' condition).
  - Push the key to toggle the mute and unmute conditions (toggles 'audible' and 'inaudible').
  - Push the key to mute the channel (sets to 'inaudible' only).
  - Push the key to unmute the channel (sets to 'audible' only).
  - Push the key after communication is finished to send a 'reset code.'
  - Push the key after communication is finished to send a 'clear down code' during BIIS operation on an MSK channel.

**NOTE:** The unmute condition ('audible' conditions) may automatically return to the mute condition ('inaudible' condition) after a specified period.

\*Desired function can be programmed by your dealer. (p. 7)

**11 ANTENNA CONNECTOR**

Connects the supplied antenna.

## 2 PANEL DESCRIPTION

### ■ Function display

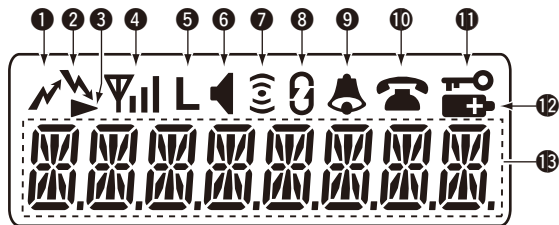

#### 1 TRANSMIT INDICATOR

Appears while transmitting.

#### 2 BUSY INDICATOR

Appears while the channel is busy.

#### 3 SCROLL INDICATOR

Appears when a received SDM including more than 8 characters is displayed.

#### 4 SIGNAL STRENGTH INDICATOR

Indicates relative signal strength level.

#### 5 LOW POWER INDICATOR

Appears when low output power is selected.

- When the battery power decreases to a specified level, low power is selected automatically.

#### 6 AUDIBLE INDICATOR

- Appears when the channel is in the 'audible' (unmute) condition.
- Appears when the specified 2/5-tone/BIIS code is received.

#### 7 COMPANDER INDICATOR

Appears when the compander function is activated.

#### 8 SCRAMBLER INDICATOR

Appears when the voice scrambler function is activated.

#### 9 BELL INDICATOR

Appears/blinks when the specific 2/5-tone/BIIS code is received, according to the pre-programming.

#### 10 CALL CODE MEMORY INDICATOR

Appears when the call code memory is selected.

#### 11 KEY LOCK INDICATOR

Appears during the key lock function is ON.

#### 12 BATTERY INDICATOR

Appears or blinks when the battery power decreases to a specified level.

#### 13 ALPHANUMERIC DISPLAY

Displays an operating channel number, channel name, Set mode contents, DTMF code, etc.

## ■ Programmable function keys

The following functions can be assigned to [UP], [DOWN], [P0], [P1], [P2], [P3], [RED] and [MONITOR] programmable function keys.

Consult your Icom dealer or system operator for details concerning your transceivers programming.

If the programmable function names are bracketed in the following explanations, the specific key is used to activate the function depends on the programming.

### **CH UP AND DOWN KEYS**

- Push to select an operating channel.
- Push to select a transmit code channel after pushing [TX Code CH Select].
- Push to select a DTMF channel after pushing [DTMF Autodial].
- Push to select a scan group after pushing and holding [Scan A Start/Stop]/[Scan B Start/Stop].
- Push to select a BIIS code, status number or SDM after pushing [Digital].
- Push to select the MDC menu after pushing [MDC CALL].
- Push to select the desired transceiver alias or message channel while in the transceiver alias or message channel selection mode.

### **BANK SELECT KEY**

Push this key, then push [CH Up] or [CH Down] to select the desired bank.

### **SCAN A KEY**

- This key's operation depends on the Power ON Scan setting.

#### **When the power ON scan function is turned OFF;**

Push to start and cancel scanning operation. In case of transmission during scan, cancels scanning.

#### **When the power ON scan function is turned ON;**

Push to pause scanning. Scanning resumes after passing a specified time period. In case of transmission during scan, pauses scanning. Scanning resumes after passing a specified time period specified.

- Push and hold this key for 1 sec. to indicate the scan group, then push [CH Up] or [CH Down] to select the desired group.

### **SCAN B KEY**

- Push to start and cancel scanning operation. In case of transmission during scan, pauses scanning. Scanning resumes after passing a specified time period.
- Push and hold this key for 1 sec. to indicate the scan group, then push [CH Up] or [CH Down] to select the desired group.

### **SCAN TAG KEY**

Push to add or delete the selected channel to the scan group.

### **PRIORITY CHANNEL KEYS**

- Push to select Priority A or Priority B channel.
- Push and hold [Prio A (Rewrite)] to rewrite the Prio A channel.

---

## 2 PANEL DESCRIPTION

### **MR-CH 1/2/3/4 KEYS**

Push to select an operating channel directly.

### **MONITOR KEY**

- ➔ Mute and release the CTCSS (DTCS) or 2-tone squelch mute. Open any squelch/deactivate any mute while pushing this key. (LMR operation only)
- ➔ Activates one of (or two of) the following functions on each channel independently: (PMR or BIIS PMR operation only)
  - Push and hold to un-mute the channel (audio is emitted; 'Audible' condition).
  - Push to mute the channel (sets to 'Inaudible' only).
  - Push to un-mute the channel (sets to 'Audible' only).
  - Push after the communication is finished to send a 'reset code'.

 **NOTE:** The un-mute condition ('Audible' condition) may automatically return to the mute condition ('Inaudible' condition) after a specified period.

### **LOCK KEY**

Push and hold to electronically lock all programmable keys except the following:  
[Call] (incl. Call A and Call B), [Moni(Audi)] and [Emergency].

### **OUTPUT POWER SELECTION KEY**

Push to select the transmit output power temporarily or permanently, depending on the pre-setting.

- Ask your dealer for the output power level for each selection.

### **C.TONE CHANNEL ENTER KEY**

Push to select the continuous tone channel using [CH Up]/[CH Down] to change the tone frequency/code setting after pushing this key for permanent operation.

### **TALK AROUND KEY**

Turn the talk around function ON and OFF.

- The talk around function equalizes the transmit frequency to the receive frequency for transceiver-to-transceiver communication.

### **WIDE/NARROW KEY**

Push to toggle the IF bandwidth between wide and narrow.

- The wide passband width can be selected from 25.0 or 20.0 kHz using the CS-F33G CLONING SOFTWARE. (PMR or BIIS PMR operation only) Ask your Dealer for details.

### **DTMF AUTODIAL KEY**

- ➔ Push to enter the DTMF channel selection mode. Then select the desired DTMF channel using [CH Up]/[CH Down] keys.
- ➔ After selecting the desired DTMF channel, push this key to transmit the DTMF code.

### **DTMF RE-DIAL KEY**

Push to transmit the last-transmitted DTMF code.

### **CALL KEYS**

Push to transmit a 2/5-tone/BIIS ID code.

- Call transmission is necessary before you call another station depending on your signalling system.
- [Call A] and/or [Call B] may be available when your system employs selective 'Individual/Group' calls. Ask your dealer which call is assigned to each key.

**EMERGENCY KEYS**

- Push and hold to transmit an emergency call.
- When [Emergency Single (Silent)] or [Emergency Repeat (Silent)] is pushed, an emergency call is transmitted without a beep emission and LCD indication change.
  - If you want to cancel the emergency call, push (or push and hold) the key again before transmitting the call.
  - The emergency call is transmitted one time only or repeatedly until receiving a control code depending on the pre-setting.

**TX CODE ENTER KEY** (PMR or BIIS PMR operation only)  
 Push to enter the direct ID code edit mode, for both 5-tone and MSK. Then set the desired digit using [CH Up]/[CH Down]/[TX Code CH Up]/[TX Code CH Down] or 10-key-pad.\* (p. 14)

\*Depending on version

**TX CODE CHANNEL SELECT KEY**

- Push to enter the direct ID code channel selection mode. Then set the desired channel using [CH Up]/[CH Down]/[TX Code CH Up] or [TX Code CH Down]. (p. 13)
- While in ID code channel selection mode, push for 1 sec. to enter the ID code edit mode for 5-tone and MSK. Then set the desired digit using [CH Up]/[CH Down]/[TX Code CH Up]/[TX Code CH Down] or 10-keypad.\* (p. 14)

\*Depending on version

**TX CODE CHANNEL UP/DOWN KEYS**

Push to select a TX code channel directly.

**ID MEMORY READ KEY** (PMR or BIIS PMR operation only)

- Recalls detected ID codes.
  - Push this key, then push [CH Up]/[CH Down] for selection.
  - Up to 5 ID's are memorized.
- Push and hold to erase the selected memorized ID's.

**VOICE SCRAMBLER FUNCTION**

Push to toggle the voice scrambler function ON and OFF.

**COMPANDER KEY**

Push to toggle the compander function ON and OFF. The compander function reduces noise components from the transmitting audio to provide clear communication.

**USER SET MODE KEY**

- Push and hold to enter user set mode.
  - During user set mode, push this key to select an item, and push [CH Up]/[CH Down] to change the value or condition.
- Push and hold this key again to exit user set mode.

**OPT OUT KEYS**

Push to control the optional unit connector output signal level.

**DIGITAL KEY** (BIIS operation only)

- Push to select the call ID list, transmit message and standby condition. Toggles between queue channel and received message record indication after queue channel is selected.
- Push and hold to select queue channel indication.

---

## 2 PANEL DESCRIPTION

### **STATUS UP/DOWN KEYS** (BIS operation only)

- ➔ While in the standby condition, push to display the transmit status indication and select a status number.
- ➔ When a received SDM is displayed, push to cancel the automatic scroll and scroll the message manually.
- ➔ When an SDM that contains more than 8 characters is displayed, push to scroll the message manually.

### **MDC CALL KEY** (MDC operation only)

- ➔ Push to enter the MDC menu selection mode. Then select the desired MDC menu from “SELCALL,” “MSG,” “STATUS,” “RADIOCHK” and “CALALERT” using [CH Up]/[CH Down]/[MDC Up]/[MDC Down].  
After selection, push this key again to enter the transceiver alias or message channel selection mode.
- ➔ While in the transceiver alias or message channel selection mode, push to return to the MDC menu selection mode.

### **MDC UP AND DOWN KEYS** (MDC operation only)

- ➔ Push to select the MDC menu after pushing [MDC CALL].
- ➔ Push to select the desired transceiver alias or message channel while in the transceiver alias or message channel selection mode.

### **MDC SELCALL KEY** (MDC operation only)

Push to enter the transceiver alias selection mode.

- After the desired alias selection, push [PTT] to transmit a selective call.

### **MDC CALLALERT KEY** (MDC operation only)

Push to enter the transceiver alias selection mode.

- After the desired alias selection, push [PTT] to transmit a call alert.

### **MDC EMG KEY** (MDC operation only)

Push and hold for a specified period to transmit an MDC emergency call.

- If you want to cancel the emergency call, push (or push and hold) the key again before transmitting the call.

## ■ Turning power ON

- ① Rotate [VOL] to turn the power ON.
- ② If the transceiver is programmed for a start up password, input the digit codes as directed by your dealer.
  - 10-keypad can be used for password input depending on version:
  - The keys in the table below can be used for password input:
  - The transceiver detects numbers in the same block as identical. Therefore “01234” and “56789” are the same.

KEY	P <sub>0</sub>	P <sub>1</sub>	P <sub>2</sub>	P <sub>3</sub>	DOWN
NUMBER	0	1	2	3	4
	5	6	7	8	9

- ③ When the “PASSWORD” indication does not clear after inputting 4 digits, the input code number may be incorrect. Turn the power off and start over in this case.

## ■ Channel selection

Several types of channel selections are available. Methods may differ according to your system set up.

### **NON-BANK TYPE:**

Push [UP] or [DOWN], or rotate [ROTARY SELECTOR]\* to select the desired operating channel, in sequence; or, push one of [MR-CH 1] to [MR-CH 4] keys to select a channel directly.

- Up to 16 pre-programmed channels can be selected via [ROTARY SELECTOR].\*

### **BANK TYPE:**

Push [BANK], then push [UP] or [DOWN] or rotate [ROTARY SELECTOR]\* to select the desired bank.

### **AUTOMATIC SCAN TYPE:**

Channel setting is not necessary for this type. When turning power ON, the transceiver automatically starts scanning. Scanning stops when receiving a call.

\*Depending on the pre-setting.

### 3 BASIC OPERATION

## ■ Call procedure

When your system employs tone signaling (excluding CTCSS and DTCSS), the call procedure may be necessary prior to voice transmission. The tone signalling employed may be a selective calling system which allows you to call specific station(s) only and prevent unwanted stations from contacting you.

- ① Select the desired TX code channel or 2/5-tone code according to your System Operator's instructions.
  - This may not be necessary depending on programming.
  - Refer to pgs. 13 or 14 for selection.
- ② Push the call key (assigned to one of the dealer programmable keys: [Up], [Down], [P0], [P1], [P2], [P3], [Emergency] and [Monitor]) or [PTT].
- ③ After transmitting a 2/5-tone code, the remainder of your communication can be carried out in the normal fashion.

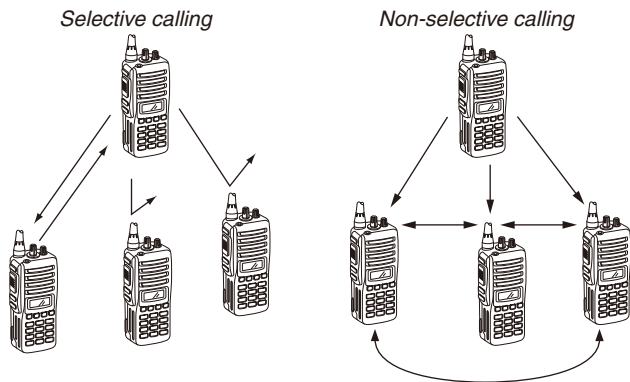

## ■ Receiving and transmitting

/// **NOTE:** Transmitting without an antenna may damage the transceiver. See p. 1 for antenna attachment.

### **Receiving:**

- ① Rotate [VOL] to turn the power ON.
- ② Push [UP] or [DOWN], or rotate [ROTARY SELECTOR]\* to select a channel, in sequence.
  - \*Depending on the pre-setting.
- ③ When receiving a call, adjust the audio output level to a comfortable listening level.

### **Transmitting:**

Wait for the channel to become clear to avoid interference.

- ① While pushing and holding [PTT], speak into the microphone at a normal voice level.
- ② Release [PTT] to return to receive.

/// **IMPORTANT:** To maximize the readability of your signal;  
1. Pause briefly after pushing [PTT].  
2. Hold the microphone 5 to 10 cm (2 to 4 inches) from your mouth, then speak into the microphone at a normal voice level.



### ◇ Transmitting notes

#### • Transmit inhibit function

The transceiver has several inhibit functions which restrict transmission under the following conditions:

- The channel is in mute condition ('Inaudible' condition; "◀" does not appear.)
- The channel is busy.
- Un-matched (or matched) CTCSS is received. (Depending on the pre-setting.)
- The selected channel is a 'receive only' channel.

#### • Time-out timer

After continuous transmission for the pre-programmed time period, the time-out timer is activated, causing the transceiver to stop transmitting.

#### • Penalty timer

Once the time-out timer is activated, transmission is further inhibited for a period determined by the penalty timer.

### ◇ TX code channel selection

If the transceiver has [TX Code CH Select] assigned to it, indication can be toggled between the operating channel number (or name) and TX code channel number (or name). When the TX code channel number (or name) is displayed, [UP]/[DOWN] selects the TX code channel.

#### **TO SELECT A TX CHANNEL:**

- ① Push [TX Code CH Select]— a TX code channel appears.
- ② Push [UP] or [DOWN] to select the desired TX code channel.
- ③ Push [Call] (or [PTT] during MSK operation) to transmit the selected TX code.
- ④ Push [TX Code CH Select] again to return to the operating channel number indication.

#### **FOR TX CODE CHANNEL TYPE:**

If the transceiver has a [TX Code CH Up] or [TX Code CH Down] key assignment, the programmed TX code channel can be selected directly.

---

## 3 BASIC OPERATION

### ◇ TX code number edit

(PMR or BIIS PMR operation only)

If the transceiver has [TX Code CH Select] or [TX Code Enter] assigned to it, TX code contents can be edited within the allowable digits.

#### **TO EDIT A TX CODE VIA [TX CODE CH SELECT] KEY:**

- ① Push [TX Code CH Select] to enter the TX code channel selection mode.
  - Select the desired channel using [UP] or [DOWN] if necessary.
- ② Push [TX Code CH Select] for 1 sec. to enter the TX code edit mode.
- ③ Push [TX Code CH Select] to select the desired digit to be edited.
- ④ Set the desired digit using [UP], [DOWN], [TX Code CH Up], [TX Code CH Down] or 10-keypad.\*  
\*Depending on version.
- ⑤ Push [TX Code CH Select] to set the digit. The editable digit will move to the right automatically.
  - When the 10-keypad is used to set, the editable digit will move to the right automatically without pushing [TX Code CH Select].
- ⑥ Repeat ④ and ⑤ to input all allowable digits.
- ⑦ Push [Call] or [PTT] to transmit the edited TX code.

#### **TO EDIT A TX CODE VIA [TX CODE ENTER] KEY:**

- ① Select the desired TX code channel via [TX Code CH Up] or [TX Code CH Down].
- ② Push [TX Code Enter] to enter the TX code edit mode.
- ③ Push [TX Code Enter] to select the desired digit to be edited.
- ④ Set the desired digit using [UP], [DOWN], [TX Code CH Up] or [TX Code CH Down] or 10-keypad\*.  
\*Depending on version.
- ⑤ Push [TX Code Enter] to set the digit. The editable digit will move to the right automatically.
  - When the 10-keypad is used to set, the editable digit will move to the right automatically without pushing [TX Code CH Select].
- ⑥ Repeat ④ and ⑤ to input all allowable digits.
- ⑦ Push [Call] or [PTT] to transmit the edited TX code.

### ◇ DTMF transmission

If the transceiver has [DTMF Autodial] assigned to it, the automatic DTMF transmission function is available. Up to 8 DTMF channels are available.

#### TO SELECT A TX CODE:

- ① Push [DTMF Autodial]— a DTMF channel appears.
- ② Push [UP] or [DOWN] to select the desired DTMF channel.
- ③ Push [DTMF Autodial] to transmit the DTMF code in the selected DTMF channel.

## ■ User set mode

User set mode is accessed with [User Set Mode] and allows you to set seldom-changed settings. In this case you can “customize” the transceiver operation to suit your preferences and operating style.

#### *Entering the user set mode:*

- ① Push and hold [User Set Mode] to enter user set mode. Push [User Set Mode] momentarily to select the item. Then push [UP] or [DOWN] to set the desired level/condition.
  - Available set mode functions are **Backlight**, **Beep**, **SQL Level**, **Mic Gain** and **Battery Voltage**.
- ② Push and hold [User Set Mode] to exit user set mode.

## ■ Scrambler function

The voice scrambler function provides private communication between stations. The frequency inversion type is equipped to all versions, moreover, the optional Rolling or Non-rolling type can be available.

- ① Push [Scrambler] to turn the scrambler function ON.
  - “**⓪**” appears.
- ② Push [Scrambler] again to turn the scrambler function OFF.
  - “**⓪**” disappears.

## ■ Default setting

The following functions are assigned to each programmable key as the default. However, the assigned function can be changed by your dealer. Ask your dealer for details.

/// **NOTE:** [TX Code Enter] must be assigned to any key.

[P0]; Call	: Push to transmit a 5-tone/BIIS call when the selected channel is a 5-tone or MSK channel, respectively.
[P1]; Digital	: Push to select the call list ID/transmit message, or to display the receive message record for selection.
[P3]; TX Code Enter	: Push to enter the direct ID code edit mode for both 5-tone and MSK.
[UP]/[DOWN]; CH Up/Down	: While in the standby condition, selects the operating channel. After pushing [Digital] or [TX Code CH Select], selects call list or TX code channel, respectively.
[MONITOR]; Moni(Audi)	: Push this key after the communication to send a 'Clear down' signal during MSK channel operation.
[P2]/[RED]; Null	: No function is assigned.

## ■ Receiving a call

### ◇ Individual call

- ① When an individual call is received;
  - Beeps sound.
  - “📞” appears and the mute is released.
  - The programmed text message (e.g. “CALLING”) and the calling station ID (or text) is displayed alternately, depending on the setting.
  - “📞” appears or blinks depending on the setting.

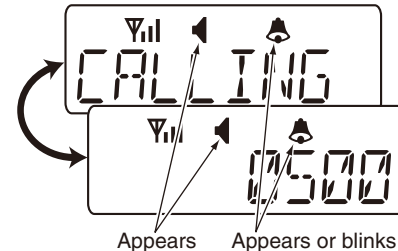

- ② Push and hold [PTT], then speak into the microphone at a normal voice level.
  - “🗣️” indicator appears.
- ③ Release [PTT] to return to receive.
  - “📞” appears while receiving a signal.
- ④ To finish the conversation, push [MONITOR] (Moni(Audi)) to send the 'Clear down' signal.
  - Either station can send a 'Clear down' signal.
  - “CLR DOWN” is displayed for 2 sec. (approx.).
  - “📞” disappears and the transceiver returns to the standby condition.

### ◇ Group call

- ① When a group call is received;
  - Beeps sound.
  - “🔊” appears and the mute is released.
  - The programmed text message (e.g. “GROUP”) and the calling station ID (or text) is displayed alternately, depending on the setting.
  - “🔔” appears or blinks depending on the setting.

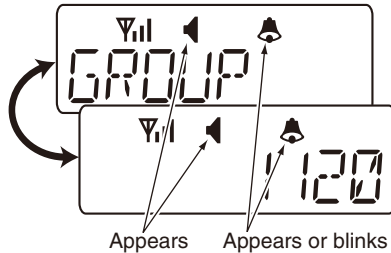

- ② Push and hold [PTT], then speak into the microphone at a normal voice level.
  - ⚡ **NOTE:** Only one station is permitted to speak.
  - “🔊” appears.
- ③ Release [PTT] to return to receive.
  - “🔊” appears while receiving a signal.
- ④ To finish the conversation, push [MONITOR] (Moni(Audi)) to send the ‘Clear down’ signal.
  - Either station can send a ‘Clear down’ signal.
  - “CLR DOWN” is displayed for 2 sec. (approx.)
  - “🔊” disappears and the transceiver returns to the standby condition.

### ◇ Displaying the received call record — Queue indication

The transceiver memorizes the calling station IDs for record. Up to 3 calls can be memorized, and the oldest call record is erased when a 4th call is received. However, once the transceiver is powered OFF, the all records are cleared.

- ① Push [P1] (Digital) for 1 sec.
  - Displays following indication.

#### *When a record is available*



#### *When no record is available*



- ② Push [UP] or [DOWN] to select the desired call.
- ③ Push [P1] (Digital) for 1 sec. again to return to the standby condition.
  - When no operation is performed for 30 sec., the transceiver returns to the standby condition automatically.

## 4 BIIS OPERATION

### ■ Transmitting a call

Total of a 3 ways for code selection are available—selecting the call code from memory, entering the call code from the keypad and calling back from the queue channel record.

#### ◇ Using call memory

- ① While in the standby condition, push [P1] (Digital) to enter the call code memory channel selection mode.
  - “☎” appears.

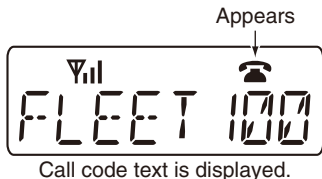

- ② Push [UP] or [DOWN] to select the desired call code.
- ③ Push [P0] (Call) or [PTT]\* to call.
  - \*PTT call can be made only when PTT call capability is permitted.
  - NOTE:** When no answer back is received, the transceiver repeats the call 3 times (default) automatically, and “WAIT” is displayed during each call. However, an error beep sounds and “FAILED” is displayed when no answer back is received after the calls.
- ④ Push [PTT] to transmit; release to receive.
- ⑤ Push [MONITOR] (Moni(Audi)) to send the ‘Clear down’ signal.

#### ◇ Calling back from the queue channel

- ① While in the standby condition, push [P1] (Digital) for 1 sec. to enter the queue memory channel selection mode.
- ② Push [UP] or [DOWN] to select the desired record.



- ③ Push [P0] (Call) or [PTT]\* to call.
  - \*PTT call can be made only when PTT call capability is permitted.
  - NOTE:** When no answer back is received, the transceiver repeats the call 3 times (default) automatically, and “WAIT” is displayed during each call. However, an error beep sounds and “FAILED” is displayed when no answer back is received after the calls.
- ④ Push [PTT] to transmit; release to receive.
- ⑤ Push [MONITOR] (Moni(Audi)) to send the ‘Clear down’ signal.

### ◇ Direct code entry

- ① While in the standby condition, push [P3] (TX Code Enter) to enter the TX code edit mode.
  - Editable code digit blinks.



- ② Push [P3] (TX Code Enter) to select the desired digit to be edited.
  - Editable digit differs according to the setting.
- ③ Set the desired digit using [CH Up]/[CH Down]/[TX Code CH Up]/[TX Code CH Down] or 10-keypad.\*
  - \*Depending on version
- ④ Push [P3] (TX Code Enter) to set the digit, then the editable digit will move to the right automatically.
  - When the 10-keypad is used to set, the editable digit will move to the right automatically without pushing [P3] (TX Code Enter).
- ⑤ Repeat ③ and ④ to input all allowable digits.
- ⑥ Push [P0] (Call) or [PTT]\* to call.

\*PTT call can be made only when PTT call capability is permitted.

/// **NOTE:** When no answer back is received, the transceiver repeats the call 3 times (default) automatically, and "WAIT" is displayed during each call. However, an error beep sounds and "FAILED" is displayed when no answer back is received after the calls.

- ⑦ Push [PTT] to transmit; release to receive.
- ⑧ Push [MONITOR] (Moni(Audi)) to send the 'Clear down' signal.

---

### ***For your information***

When the "UpDate" setting for the call code is enabled, the set code is overwritten into the call code memory.

---

## 4 BIIS OPERATION

### ■ Receiving a message

#### ◇ Receiving a status message

- ① When a status message is received;
  - Beeps sound.
  - The calling station ID (or text) and the status message is displayed alternately, depending on the setting.

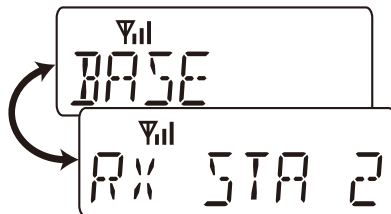

- ② Push [MONITOR] (Moni(Audi)) to return to the standby condition.

**NOTE:** Only the calling station ID (or text) is displayed (no message is displayed alternately) when the scroll timer is set to 'OFF'. In this case, push [Status Up]/[Status Down] to display the status message manually.

#### ◇ Receiving an SDM

- ① When an SDM is received;
  - Beeps sound.
  - The calling station ID (or text) and the SDM is displayed alternately, depending on the setting.



- ② When the received SDM includes more than 8 characters, "►" appears and the message scrolls automatically, when the automatic scroll function is activated.
  - Push [Status Up]/[Status Down] to scroll the message manually.
- ③ Push [MONITOR] (Moni(Audi)) to return to the standby condition.



### ◇ Received message selection

The transceiver memorizes the received messages for record. Up to 6 messages for status and SDM, or 95 character SDM's can be memorized. The oldest message is erased when the 7th message is received. However, once the transceiver is powered OFF, all messages are cleared.

- ① Push [P1] (Digital) for 1 sec.
  - Displays queue memory.
- ② Push [P1] (Digital) momentarily.
  - Displays message memory.

#### *When a message is available*

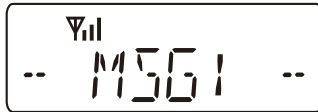

#### *When no message is available*



- ③ Push [UP] or [DOWN] to select the desired message.
  - When selecting the SDM that includes more than 8 characters, "►" appears and the message scrolls automatically, when the automatic scroll function is activated.
  - Push [Status Up]/[Status Down] to scroll the message manually.
- ④ Push [P1] (Digital) for 1 sec. again to return to the standby condition.
  - When no operation is performed for 30 sec., the transceiver returns to the standby condition automatically.

## 4 BIIS OPERATION

### ■ Transmitting a status

#### ◇ General

The status message can be selected with the programmed text, and the message text is also displayed on the function display of the called station.

Up to 24 status types (1 to 24) are available, and the status messages 22 and 24 have designated meanings.

Status 22: Emergency\*

Status 24: GPS request

\*The status 22 can also be used as a normal status message by disabling the designated meaning. However, the status 24 is fixed.

The status call can be sent with both individual and group calls.

#### ◇ Transmitting a status

- ① While in the standby condition, push [P1] (Digital), then push [UP] or [DOWN] to select the desired station/group code.
- ② Push [P1] (Digital) again, then push [UP] or [DOWN] to select the desired status message.

Or, you can select the desired status message using [Status Up]/[Status Down] key directly.



Status message is displayed.

- ③ Push [P0] (Call) or [PTT]\* to transmit the status message to the selected station/group.
  - \*PTT call can be made only when PTT call capability is permitted.
  - 2 beeps will sound and the transceiver returns to the standby condition automatically when the transmission is successful.

## ■ Transmitting an SDM

### ◇ General

The short data message, SDM, can be sent to an individual station or group stations. Also, 8 SDM memory channels are available and the messages can be edited via PC programming.

### ◇ Transmitting an SDM

- ① While in the standby condition, push [P1] (Digital), then push [UP] or [DOWN] to select the desired station/group code.
- ② Push [P1] (Digital) again, then push [UP] or [DOWN] to select the desired SDM.

Or, you can select the desired SDM using [Status Up]/[Status Down] key directly.



SDM is displayed.

- ③ Push [P0] (Call) or [PTT]\* to transmit the SDM to the selected station/group.

\*PTT call can be made only when PTT call capability is permitted.

- 2 beeps will sound and the transceiver returns to the standby condition automatically when the transmission is successful.

## 4 BIIS OPERATION

### ◇ Programming an SDM memory

(10-keypad version is required)

- ① During standby condition, push [P1] (Digital) twice, then push [UP] or [DOWN] to select the desired SDM to be edited.
- ② Push [\*] or [#] to enter the message editing condition.
  - The first character blinks when [#] is pushed, the last character blinks when [\*] is pushed as below.



- ③ Push the appropriate digit key, [0] to [9], to enter the desired character.
  - See the table at right for the available characters.
  - Pushing [UP] also enters space, pushing [DOWN] deletes the selected character.
- ④ Push [#] to move the cursor to the right, push [\*] to move the cursor to the left.
- ⑤ Repeat steps ③ and ④ to set the desired text message.
- ⑥ Push [P1] (Digital) for 1 sec. to overwrite the set content into the memory.
  - Push [P1] (Digital) momentarily to cancel the editing and return to the original message indication.

### • Available characters

Key	Characters
[0]	0 (0) . (.) ! (!) ? (?) ' (') " (") , (,) ; (;) : (:) _ ( _ ) ' ( ( ) ' ( ) < (<) > (>) [ ( [ ) ] ( ] )
[1]	1 (1) (Space) # (#) * (*) / (/) + (+) - (-) = (=) \ ( \ ) & (&) % (%) \$ (\$) @ (@) ^ (^)
[2]	2 (2) A (A) B (B) C (C) a (a) b (b) c (c)
[3]	3 (3) D (D) E (E) F (F) d (d) e (e) f (f)
[4]	4 (4) G (G) H (H) I (I) g (g) h (h) i (i)
[5]	5 (5) J (J) K (K) L (L) j (j) k (k) l (l)
[6]	6 (6) M (M) N (N) O (O) m (m) n (n) o (o)
[7]	7 (7) P (P) Q (Q) R (R) S (S) p (p) q (q) r (r) s (s)
[8]	8 (8) T (T) U (U) V (V) t (t) u (u) v (v)
[9]	9 (9) W (W) X (X) Y (Y) Z (Z) w (w) x (x) y (y) z (z)

**NOTE:** Once the pre-programmed character including a decimal point is rewritten with the 10-keypad, the decimal point cannot be displayed again.

## ■ Position data transmission

When the optional cable and a GPS receiver is connected to the transceiver, the position (longitude and latitude) data can be transmitted automatically.

Ask your dealer or system operator for connection details.

The position data is transmitted when;

- Status 24 message is received
  - \*When the status 24 message, GPS request, is received.
- Fully automatic
  - When automatic position transmission is enabled, send the position data according to 'Time Marker' and 'Interval Timer' settings.
- PTT is released
  - When 'Send with Logoff' is enabled.
    - Set the 'Log-In/Off' item as 'L-OFF'
- After sending a status message
  - When 'Send with Status' is enabled.
- After sending an SDM
  - When 'Send with SDM' is enabled.
- After sending status 22 (Emergency)
  - When 'Send with Emergency' is enabled.

## ■ Printer connection

When the optional cable is connected to the transceiver, a printer can be connected to print out the received SDM content and the ID of the station who sent the message.

Ask your dealer or system operator for connection details.

## ■ Digital ANI

The own ID can be transmitted each time the PTT is pushed (log-in) or released (log-off) during individual or group call communications.

By receiving the ANI, the communication log can be recorded when using a PC dispatch application.

In addition, when using the ANI with log-in, the PTT side tone function can be used to inform you that the ID is sent and voice communication can be performed.

---

## 4 BIIS OPERATION

### ■ Auto emergency transmission

When [Emergency Single (Silent)] or [Emergency Repeat (Silent)] is pushed, an emergency signal is automatically transmitted for the specified time period.

The status 22 (Emergency) is sent to the selected ID station, and the position data is transmitted after the emergency signal when a GPS receiver is connected to the transceiver.

The emergency transmission is performed on the emergency channel, however, when no emergency channel is specified, the signal is transmitted on the previously selected channel.

There is no change in the function display or beep emission during automatic emergency transmission.

### ■ Stun function

When the specified ID, set as a killer ID, is received, the stun function is activated.

When the killer ID is received, the transceiver switches to the password required condition. Entering of the password via the keypad is necessary to operate the transceiver again in this case.

### ■ BIIS indication

The following indications are available for the BIIS operation on an MSK channel.

*CONNECT* : Individual/group call is successful.

*OK* : Message (status or SDM) transmission is successful.

*FAILED* : No answer back is received.

*WAIT* : Appears during retry of the call (2nd call).

*CLR DOWN* : End the communication.

*BUSY* : Operating channel is in the busy condition.

### ■ Priority A channel selection

When one of the following operations is performed, the transceiver selects the Priority A channel automatically.

Priority A is selected when;

- Clear down signal is received/transmitted
  - Set the 'Move to PrioA CH' item as 'Clear down.'
- Turning the power ON
  - The Priority A channel is selected each time the transceiver power is turned ON.
- Status call
  - The Priority A channel is selected when transmitting a status call.
  - Enable the 'Send Status on PrioA CH' item in the MSK configuration.

## ■ Man Down Emergency Call

The optional UT-124 MAN DOWN UNIT is required for this function.

The man down emergency call function transmits an emergency call automatically, when the transceiver has been left in a horizontal position.

This function can be performed for both 5-tone and MSK channels.

After the emergency call, the transceiver performs transmission and reception alternately with the following conditions:

- Transmits the microphone signals.
- Receives the signal and emits audio.

When the emergency reset signal is received, the function is cancelled.

**/// IMPORTANT:** Set an emergency channel individually, to provide certain emergency call operation is recommended.

## ■ MDC 1200 system operation

The MDC 1200 signaling system enhances your transceiver's capabilities. It allows PTT ID\*, Selective Calling, Call Alert, Radio Check, Messaging and Emergency signaling. Also, the dispatcher can stun and revive transceivers on the system.

An additional feature of MDC 1200 found in Icom transceivers is called aliasing. Each transceiver on the system has a unique ID number. Aliasing allows the substitution of an alphanumeric name for this ID number. For transmit, you can use this alias to select a transceiver to call. For receive, the alias of the calling station is displayed instead of the ID.

The following section describes the operation of the MDC 1200 features using the alias function. The Selective Call, Call Alert and Radio Check features can also be used with direct ID code entry from the transceiver keypad. (p. 32)

Please note that your dealer has set one of the programmable keys (P0, P1, P2, or P3) for MDC 1200 operation.

\*When [PTT] is pushed or released, self ID is transmitted.

## ■ Transmitting a call

### ◇ Transmitting a Selective Call

Selective calling allows you to make a call to a specific station or to a particular group. Other MDC 1200 transceivers on the channel will not receive a selective call that does not match their station or group ID's.

- ① Push [MDC Call] to enter the MDC menu selection mode.
  - Or push [MDC Selcall] to enter the transceiver alias selection mode. In this case, skip step ②.



SELL CALL is displayed.

- ② Push [MDC Call] again to enter the transceiver alias selection mode.
- ③ Select the desired alias using [CH Up], [CH Down], [MDC Up] or [MDC Down].
- ④ Push and hold [PTT] to transmit the selective call to the selected station, then speak into the microphone.
- ⑤ Release [PTT] to receive.



### ◇ Transmitting a Call Alert

Call Alert allows you to notify another user who may be away from the transceiver that you want to talk.

- ① Push [MDC Call] to enter the MDC menu selection mode.
  - Or push [MDC CallAlert] to enter the transceiver alias selection mode. In this case, skip steps ② and ③.
- ② Select “CALALERT” using [CH Up], [CH Down], [MDC Up] or [MDC Down].



- ③ Push [MDC Call] again to enter the transceiver alias selection mode.
- ④ Select the desired alias using [CH Up], [CH Down], [MDC Up] or [MDC Down].
- ⑤ Push [PTT] to transmit the call alert to the selected station.
  - “CA CALL” is displayed.
- ⑥ Release [PTT].
  - “CA OK” is displayed if the targeted station received the alert.
  - “CA FAIL” is displayed if the targeted station does not send an acknowledgement.
- ⑦ After a specified time period has passed, the transceiver will return to receive.

### ◇ Transmitting a Radio Check Call

Radio check call allows you to determine whether another transceiver is turned on, within range and on channel without requiring any action from the targeted station user.

- ① Push [MDC Call] to enter the MDC menu selection mode.
- ② Select “RADIOCHK” using [CH Up], [CH Down], [MDC Up] or [MDC Down].



- ③ Push [MDC Call] again to enter the transceiver alias selection mode.
- ④ Select the desired alias using [CH Up], [CH Down], [MDC Up] or [MDC Down].
- ⑤ Push [PTT] to transmit the radio check call to the selected station.
  - “RDO CHK” is displayed.
- ⑥ Release [PTT].
  - “CHK ACK” is displayed if the targeted station is turned ON, on channel and within range.
  - “CHK FAIL” is displayed if the targeted station does not send an acknowledgement.
- ⑦ After a specified time period has passed, the transceiver will return to receive.

---

## 5 MDC 1200 OPERATION

### ◇ Transmitting a Status Message

Status Messaging allows you to send a pre-programmed status message to the dispatcher. There are 16 status codes that can be sent. In addition, the dispatcher can send an MDC 1200 signal that causes the transceiver to automatically transmit its current status.

- ① Push [MDC Call] to enter the MDC menu selection mode.
- ② Select “STATUS” using [CH Up], [CH Down], [MDC Up] or [MDC Down].



- ③ Push [MDC Call] again to enter the status message selection mode.



Pre-programmed status message is displayed.

- ④ Select the desired status message using [CH Up], [CH Down], [MDC Up] or [MDC Down].
- ⑤ Push [PTT] to transmit the status message to the dispatcher.
  - “STAT TX” is displayed.

- ⑥ Release [PTT].
  - “STAT OK” is displayed.
  - “STA FAIL” is displayed if there is no acknowledgment from the dispatcher.
- ⑦ After a specified time period has passed, the transceiver will return to receive.

### ◇ Transmitting a Message

The transceiver can send a pre-programmed message to the dispatcher. There are 16 messages that can be sent on a channel.

- ① Push [MDC Call] to enter the MDC menu selection mode.
- ② Select “MSG” using [CH Up], [CH Down], [MDC Up] or [MDC Down].



- ③ Push [MDC Call] again to enter the pre-programmed message selection mode.



Pre-programmed message is displayed.

- ④ Select the desired message using [CH Up], [CH Down], [MDC Up] or [MDC Down].
- ⑤ Push [PTT] to transmit the message to the dispatcher.
  - “MSG TX” is displayed.
- ⑥ Release [PTT].
  - “MSG OK” is displayed.
  - “MSG FAIL” is displayed if there is no acknowledgment from the dispatcher.
- ⑦ After a specified time period has passed, the transceiver will return to receive.

### ◇ Emergency Calls

The MDC 1200 Emergency feature can be accessed using the [MDC Emg] key (p. 10). The optional UT-124 MAN DOWN UNIT can also activate this feature. The transceiver will repeatedly send an Emergency MDC 1200 command to the dispatcher for a programmed length of time until it receives an acknowledgement signal.

The emergency call can be transmitted without a beep emission and LCD indication change depends on the setting. With MDC 1200 Emergency, the transceiver can also be programmed to keep the microphone open during an emergency call, allowing monitoring of the situation. Ask your dealer for details.

### ◇ Stun and Revive

The dispatcher can send MDC 1200 signals that will stun or revive your transceiver. If a Stun command is received that matches your station ID, the transceiver will display “SORRY” and you can not receive or transmit. When a Revive command is received that matches your station ID, normal operation is restored.

## 5 MDC 1200 OPERATION

### ◇ Programming station ID code

(10-keypad version is required)

If your transceiver is equipped with a 10-keypad, you can enter a station ID code from the keypad for the Selective Call, Call Alert or Radio Check Call functions.

- ① Push [MDC Call] to enter the MDC menu selection mode.
- ② Select “SELCALL”, “RADIOCHK” or “CALALERT” using [CH Up], [CH Down], [MDC Up] or [MDC Down].
- ③ Push [MDC Call] again to enter the transceiver alias selection mode.
- ④ Push any key of the keypad to enter the ID code programming condition.
  - The first digit blinks as below.



- ⑤ Push [UP] to move the cursor to the right, push [DOWN] to move the cursor to the left.
- ⑥ When the last digit of the desired ID has been entered, push [PTT] to transmit.

### • Available characters

Key	Characters	Key	Characters
[0]	∅ (0)	[6]	⋈ (6)
[1]	1 (1)	[7]	∩ (7)
[2]	2 (2) ∩ (A) ∩ (B) ∩ (C)	[8]	⋈ (8)
[3]	∩ (3) ∩ (D) ∩ (E) ∩ (F)	[9]	∩ (9)
[4]	∩ (4)	[*]	∩ (A)
[5]	∩ (5)	[#]	∩ (3) ∩ (D) ∩ (E) ∩ (F)

## ■ Receiving a call

### ◇ Receiving a Selective Call

- ① When an individual call is received;
  - Beeps sound.
  - “” blinks.
  - The calling station ID (or alias) and “SELCALL” are displayed alternately.

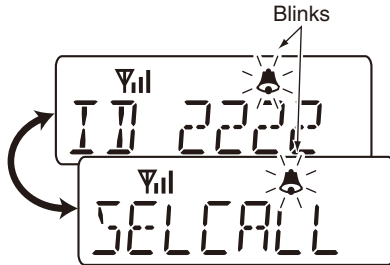

- ② Push and hold [PTT] and speak into the microphone.
- ③ Release [PTT] to receive a response.

### ◇ Receiving a Call Alert

- ① When a Call Alert is received;
  - Beeps sound.
  - “” blinks.
  - The calling station ID (or alias) and “CALLALRT” are displayed alternately.

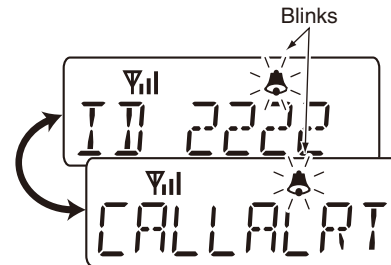

- ② Push and hold [PTT] and speak into the microphone.
- ③ Release [PTT] to receive a response.

## ■ Optional unit installation

Install the optional unit as follows:

- ① Rotate [VOL] to turn the power OFF, and remove the battery pack. (p. 2)
- ② Remove the unit cover.

**NOTE:** Use a flat head screw driver or a similar flat instrument, and insert into the hollow of the chassis, then lift and take away the unit cover.

**Use the supplied spare unit cover!** Do not use the cover that has been removed once. Water or dust may get into the transceiver because the cover may be bent or has lost its adhesion. This may result in the transceiver being damaged.

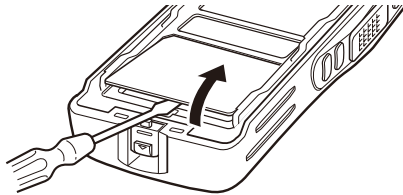

- ③ Install the unit as shown below.

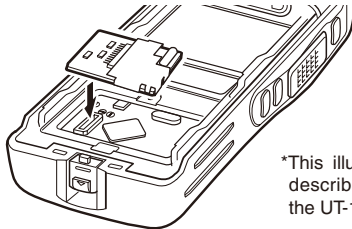

\*This illustration is described with the UT-109.

- ④ Replace the unit cover and the battery pack, then rotate [VOL] to turn the power ON.

**NOTE:** The optional UT-109/UT-110 SCRAMBLER UNITS require some PC board modifications. Please refer to the additional installation as shown on p. 35.

## ■ UT-109 and UT-110 installation

The following PC board modification is required when installing the optional UT-109 or UT-110:

- ① Rotate [VOL] to turn the power OFF, and remove the battery pack. (p. 2)
- ② Remove the unit cover as shown on p. 34 (Optional unit installation).
- ③ Cut the pattern on the PCB at the TX mic circuit (C) and RX AF circuit (F) as shown below.
- ④ Install the scrambler unit as described in the Optional unit installation (p. 34).
- ⑤ Replace the unit cover and the battery pack, then rotate [VOL] to turn the power ON.

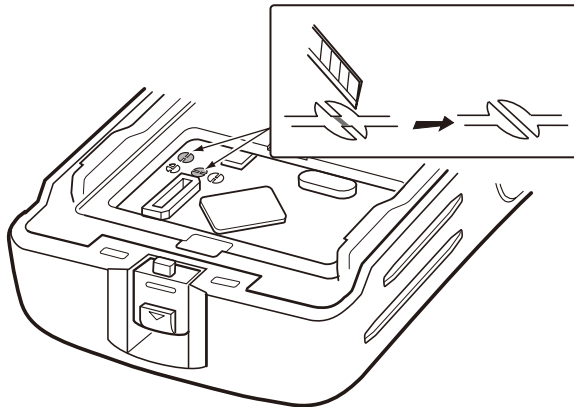

**NOTE: When uninstalling the scrambler unit**  
 Be sure to re-solder the disconnected points at left, otherwise no TX modulation or AF output is available.

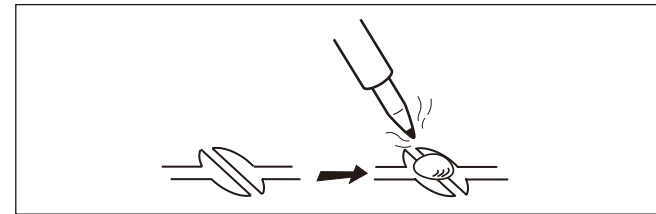

## ■ Caution

Misuse of Lithium-Ion batteries may result in the following hazards: smoke, fire, or the battery may rupture. Misuse can also cause damage to the battery or degradation of battery performance.

- ⚠ **DANGER!** Use and charge only specified Icom battery packs with Icom radios or Icom charger. Only Icom battery packs are tested and approved for use and charge with Icom radios or Icom charger. Using third-party or counterfeit battery packs or charger may cause smoke, fire, or cause the battery to burst.

### ◇ Battery caution

- ⚠ **DANGER! DO NOT** hammer or otherwise impact the battery. Do not use the battery if it has been severely impacted or dropped, or if the battery has been subjected to heavy pressure. Battery damage may not be visible on the outside of the case. Even if the surface of the battery does not show cracks or any other damage, the cells inside the battery may rupture or catch fire.
- ⚠ **DANGER! NEVER** use or leave battery packs in areas with temperatures above +60°C (+140°F). High temperature buildup in the battery, such as could occur near fires or stoves, inside a sun heated car, or in direct sunlight may cause the battery to rupture or catch fire. Excessive temperatures may also degrade battery performance or shorten battery life.
- ⚠ **DANGER! DO NOT** expose the battery to rain, snow, seawater, or any other liquids. Never charge or use a wet battery. If the battery gets wet, be sure to wipe it dry before using. The battery is not waterproof.
- ⚠ **DANGER! NEVER** incinerate used battery packs since internal battery gas may cause them to rupture, or may cause an explosion.
- ⚠ **DANGER! NEVER** solder the battery terminals or NEVER modify the battery pack. This may cause heat generation, and the battery may rupture, emit smoke or catch fire.
- ⚠ **DANGER!** Use the battery only with the transceiver for which it is specified. Never use a battery with any other equipment, or for any purpose that is not specified in this instruction manual.
- ⚠ **DANGER!** If fluid from inside the battery gets in your eyes, blindness can result. Rinse your eyes with clean water, without rubbing them, and see a doctor immediately.



- **WARNING!** Immediately stop using the battery if it emits an abnormal odor, heats up, or is discolored or deformed. If any of these conditions occur, contact your Icom dealer or distributor.
- **WARNING!** Immediately wash, using clean water, any part of the body that comes into contact with fluid from inside the battery.
- **WARNING! NEVER** put the battery in a microwave oven, high-pressure container, or in an induction heating cooker. This could cause a fire, overheating, or cause the battery to rupture.
- **CAUTION!** Always use the battery within the specified temperature range for the transceiver ( $-30^{\circ}\text{C}$  to  $+60^{\circ}\text{C}$ ;  $-22^{\circ}\text{F}$  to  $+140^{\circ}\text{F}$ ) and the battery itself ( $-20^{\circ}\text{C}$  to  $+60^{\circ}\text{C}$ ;  $-4^{\circ}\text{F}$  to  $+140^{\circ}\text{F}$ ). Using the battery out of its specified temperature range will reduce the battery's performance and battery life.
- **CAUTION!** Shorter battery life could occur if the battery is left fully charged, completely discharged, or in an excessive temperature environment (above  $+50^{\circ}\text{C}$ ;  $+122^{\circ}\text{F}$ ) for an extended period of time. If the battery must be left unused for a long time, it must be detached from the radio after discharging. You may use the battery until the remaining capacity is about half, then keep it safely in a cool dry place with the temperature range as below:
  - $-20^{\circ}\text{C}$  to  $+50^{\circ}\text{C}$  ( $-4^{\circ}\text{F}$  to  $+122^{\circ}\text{F}$ ) (within a month)
  - $-20^{\circ}\text{C}$  to  $+35^{\circ}\text{C}$  ( $-4^{\circ}\text{F}$  to  $+95^{\circ}\text{F}$ ) (within three months)
  - $-20^{\circ}\text{C}$  to  $+20^{\circ}\text{C}$  ( $-4^{\circ}\text{F}$  to  $+68^{\circ}\text{F}$ ) (within a year)

#### ◇ Charging caution

- **⚠ DANGER! NEVER** charge the battery pack in areas with extremely high temperatures, such as near fires or stoves, inside a sun heated car, or in direct sunlight. In such environments, the safety/protection circuit in the battery will activate, causing the battery to stop charging.
- **WARNING! NEVER** charge or leave the battery in the battery charger beyond the specified time for charging. If the battery is not completely charged by the specified time, stop charging and remove the battery from the battery charger. Continuing to charge the battery beyond the specified time limit may cause a fire, overheating, or the battery may rupture.
- **WARNING! NEVER** insert the transceiver (battery attached to the transceiver) into the charger if it is wet or soiled. This could corrode the battery charger terminals or damage the charger. The charger is not waterproof.
- **CAUTION! NEVER** charge the battery outside of the specified temperature range: BC-160 ( $0^{\circ}\text{C}$  to  $+40^{\circ}\text{C}$ ;  $+32^{\circ}\text{F}$  to  $+104^{\circ}\text{F}$ ). Icom recommends charging the battery at  $+20^{\circ}\text{C}$  ( $+68^{\circ}\text{F}$ ). The battery may heat up or rupture if charged out of the specified temperature range. Additionally, battery performance or battery life may be reduced.

## 7 BATTERY CHARGING

### ■ Optional battery chargers

#### ◇ Rapid charging with the BC-160

The optional BC-160 provides rapid charging of the Li-Ion battery pack.

- An AC adapter (may be supplied with BC-160 depending on version) or the DC power cable (OPC-515L/CP-17L) is additionally required.

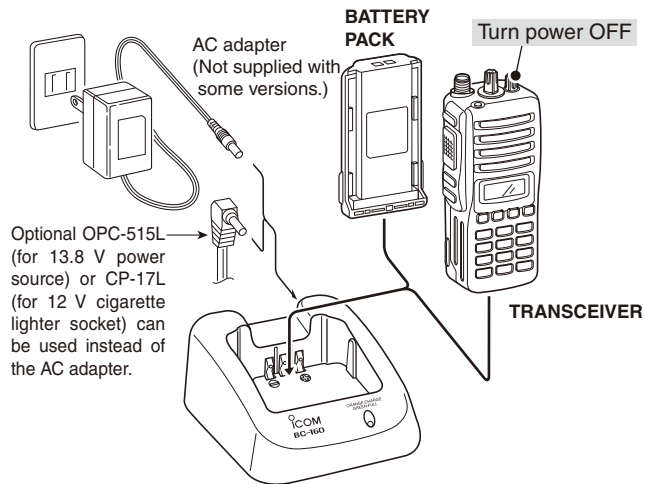

#### ◇ Regular charging with the BC-171

The optional BC-171 provides regular charging of the Li-Ion battery pack.

- An AC adapter (may be supplied with BC-171 depending on version) or the DC power cable (OPC-515L/CP-17L) is additionally required.

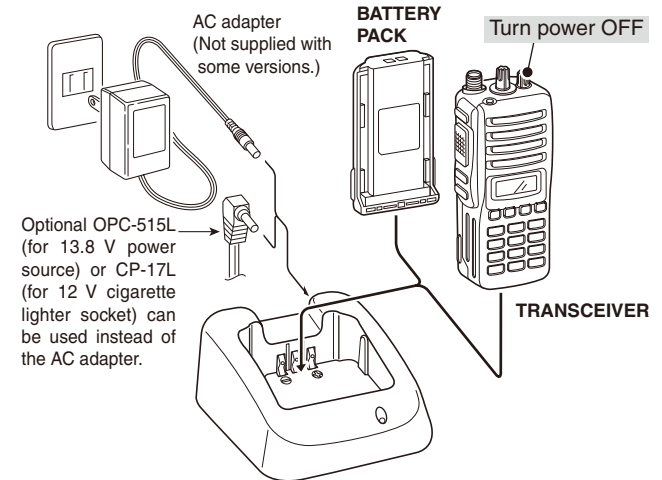

◆ **AD-106 installation**

- ① Install the AD-106 desktop charger adapter into the holder space of the BC-119N/BC-121N.
- ② Connect the plugs of the BC-119N/BC-121N to the AD-106 desktop charger adapter with the connector, then install the adapter into the charger with the supplied screws.

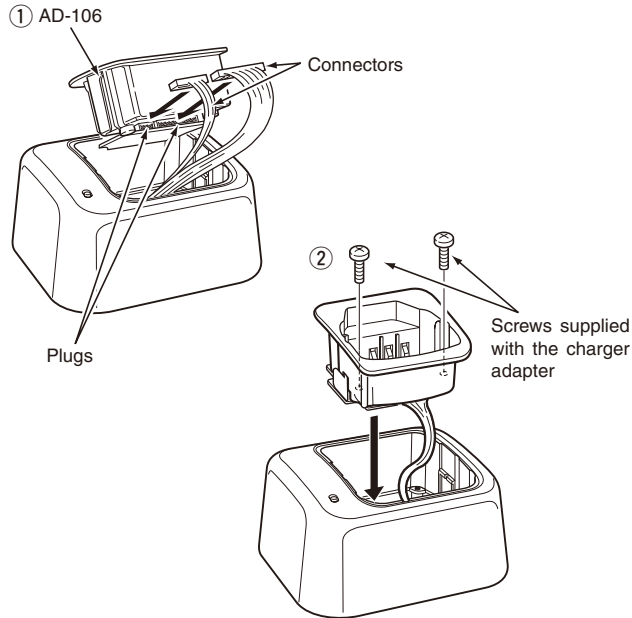

◆ **Rapid charging with the BC-119N+AD-106**

The optional BC-119N provides rapid charging of battery packs. The following items are additionally required.

- AD-106 charger adapter
- An AC adapter (may be supplied with BC-119N depending on version) or the DC power cable (OPC-515L/CP-17L).

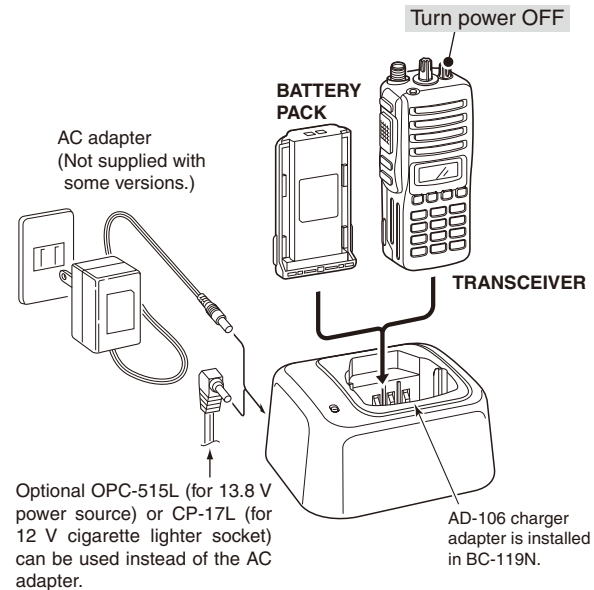

## 7 BATTERY CHARGING

### ◇ Rapid charging with the BC-121N+AD-106

The optional BC-121N allows up to 6 battery packs to be charged simultaneously. The following items are additionally required.

- Six AD-106 charger adapters
- An AC adapter (BC-157) or the DC power cable (OPC-656)

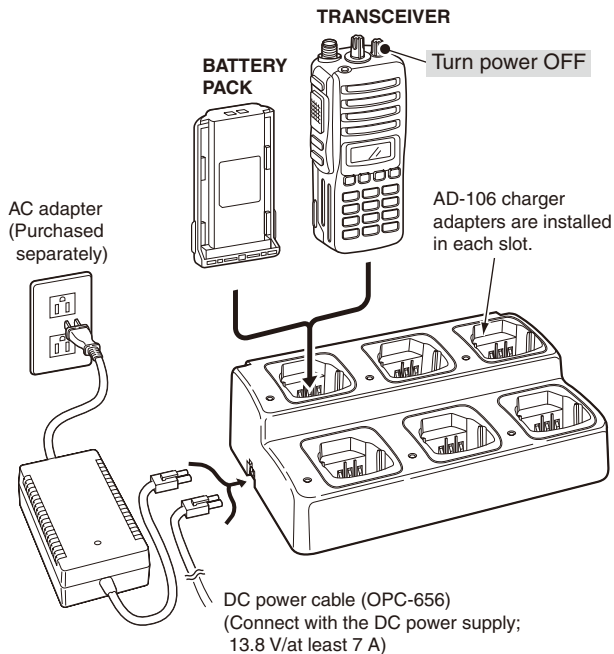

### /// IMPORTANT: Battery charging

Ensure the guide lobes on the battery pack are correctly aligned with the guide rails inside the charger adapter. (This illustration is described with the BC-160.)

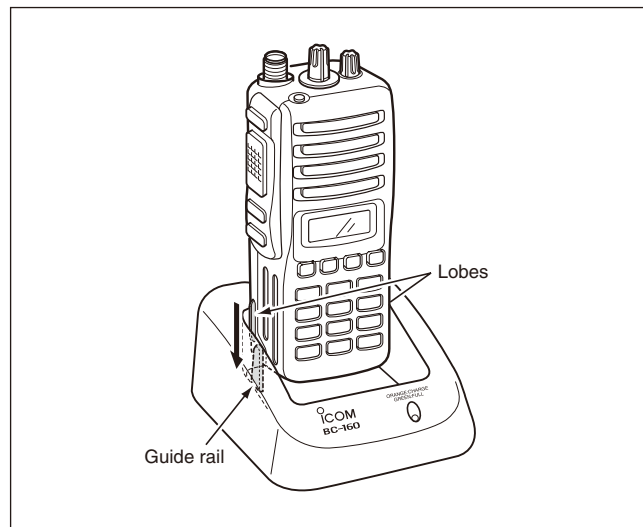

## ■ Optional battery case (BP-240)

When using the optional battery case, install 6 × AAA (LR03) size alkaline batteries as illustrated at right.

- ① Unhook the battery cover release hook (①), and open the cover in the direction of the arrow (②). (Fig.1)
- ② Then, install 6 × AAA (LR03) size alkaline batteries. (Fig.2)
  - Install the alkaline batteries only.
  - Be sure to observe the correct polarity.
- ③ Fit the cover in the direction of the arrow (③), then close (④). And hook the battery cover release hook until it makes a 'click' sound (⑤). (Fig.3)

### CAUTION:

- When installing batteries, make sure they are all the same brand, type and capacity. Also, do not mix new and old batteries together.
- Keep battery contacts clean. It's a good idea to clean battery terminals once a week.
- Never incinerate used battery cells since internal battery gas may cause them to rupture.
- Never expose a detached battery case to water. If the battery case gets wet, be sure to wipe it dry before using it.

Fig.1

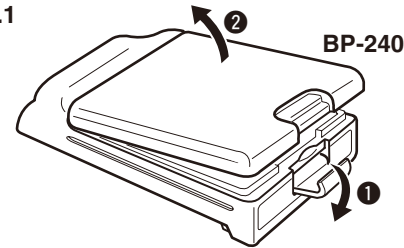

Fig.2

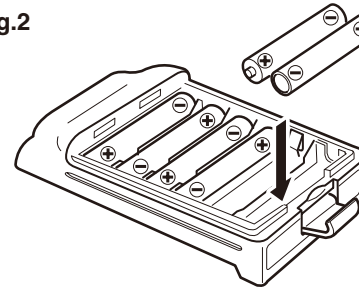
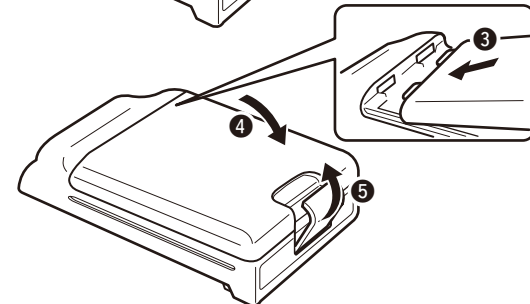
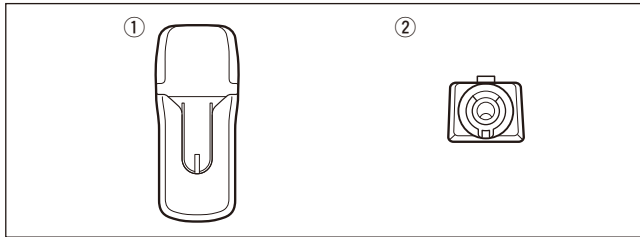

Fig.3



## ■ MB-93 contents

	Qty.
① Belt clip .....	1
② Base clip .....	1



## ■ To attach

- ① Release the battery pack if it is attached. (p. 2)
- ② Slide the base clip in the direction of the arrow until the base clip is locked and makes a 'click' sound.

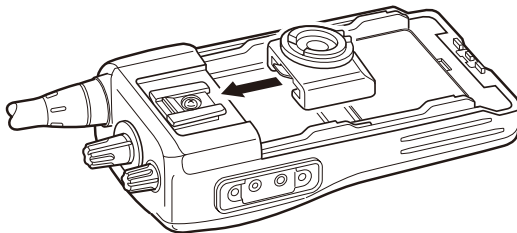

- ③ Clip the belt clip to a part of your belt. And insert the transceiver into the belt clip until the base clip inserted fully into the groove.

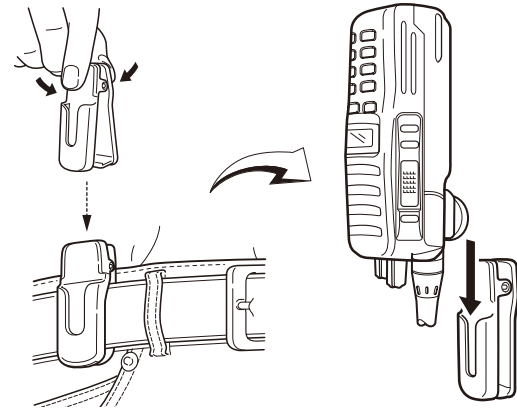

- ④ Once the transceiver is locked in place, it swivels as illustrated below.

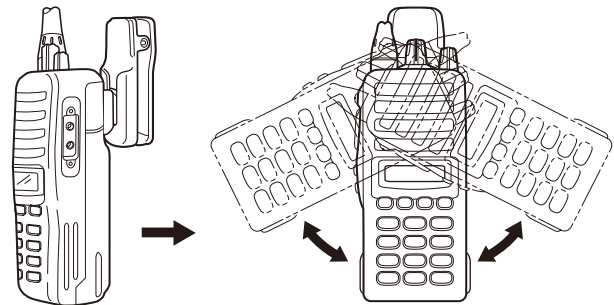

## ■ To detach

- ① Turn the transceiver upside down in the direction of the arrow and pull out from the belt clip.

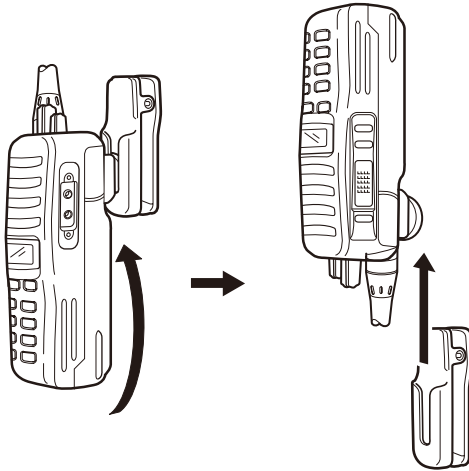

- ② Release the battery pack if it is attached. (p. 2)
- ③ Pinch the clip (①), and slide the base clip in the direction of the arrow (②).

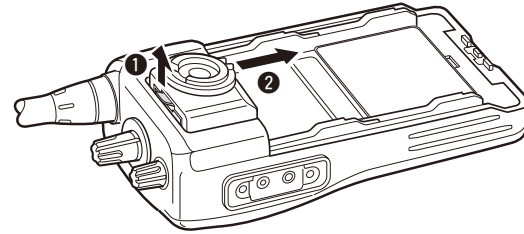

**CAUTION:**  
**HOLD THE TRANSCEIVER TIGHTLY, WHEN HANGING OR DETACHING THE TRANSCEIVER FROM THE BELT CLIP.**  
Otherwise the transceiver may not be attached to the holder or swivel properly if the transceiver is accidentally dropped and the base clip is scratched or damaged.

# 10 OPTIONS

## ◇ BATTERY PACK

Battery packs	Voltage	Capacity	Battery life*1
<b>BP-230N</b>	7.4 V	950 mAh (min.) 980 mAh (typ.)	6.5 hrs.
<b>BP-232N</b>	7.4 V	1800 mAh (min.) 2000 mAh (typ.)	13.25 hrs.
<b>BP-232H</b>	7.4 V	2250 mAh (min.) 2350 mAh (typ.)	17.5 hrs.
<b>BP-240</b>	Battery case for AAA (LR03) x 6 alkaline batteries		—*2

\*1 Operating periods are calculated under the following conditions;  
TX : RX : standby = 5 : 5 : 90

\*2 Operating period depends on the alkaline cells used.

## ◇ CHARGERS

- **BC-119N** DESKTOP CHARGER + **AD-106** CHARGER ADAPTER + **BC-145S** AC ADAPTER

For rapid charging of battery packs. An AC adapter is supplied with the charger depending on versions.

Charging time: approx. 3.5 hours when BP-232H is attached.

- **BC-121N** MULTI-CHARGER + **AD-106** CHARGER ADAPTER (6 pcs.) + **BC-157S** AC ADAPTER

For rapid charging of up to 6 battery packs (six AD-106's are required) simultaneously. An AC adapter should be purchased separately.

Charging time: approx. 3.5 hours when BP-232H is attached.

- **BC-160** DESKTOP CHARGER + **BC-145S** AC ADAPTER

For rapid charging of battery packs. An AC adapter is supplied with the charger depending on versions.

Charging time: approx. 3.5 hours when BP-232H is attached.

- **BC-171** DESKTOP CHARGER + **BC-147S** AC ADAPTER

For regular charging of battery packs. We recommend that the BP-230H charging. An AC adapter is supplied with the charger depending on versions.

Charging time: approx. 11.5 hours when BP-232H is attached.  
approx. 4 hours when BP-230 is attached.

## ◇ BELT CLIPS

- **MB-93** SWIVEL BELT CLIP
- **MB-94** BELT CLIP  
Exclusive alligator-type belt clip.
- **MB-96N/96F** LEATHER BELT HANGER

## ◇ OPTIONAL UNITS

- **UT-108** DTMF DECODER UNIT  
Provides pager and code squelch capabilities.
- **UT-109 (#02)/UT-110 (#02)** SCRAMBLER UNITS  
Non-rolling type (UT-109)/Rolling type (UT-110) voice scrambler unit provides higher communication security.
- **UT-124** MAN DOWN UNIT  
Provides a measure of safety when working in a hazardous environment, etc.



◇ DC CABLES

- **CP-17L** CIGARETTE LIGHTER CABLE  
Allows charging of the battery pack through a 12 V cigarette lighter socket. (For BC-119N)
- **OPC-515L/OPC-656** DC POWER CABLES  
Allows charging of the battery pack using a 13.8 V power source instead of the AC adapter.  
OPC-515L: For BC-119N  
OPC-656 : For BC-121N

◇ OTHER OPTIONS

- **SP-13** EARPHONE  
Provides clear receive audio in noisy environment.
- **HM-158L** SPEAKER-MICROPHONE  
Compact and durable body with screw-type connector.
- **HM-159L** SPEAKER-MICROPHONE  
Full size durable speaker microphone.
- **HM-153L** SPEAKER-MICROPHONE  
Durable earphone-microphone with revolving clip.
- **HM-166L** SPEAKER-MICROPHONE  
Light-weight earphone microphone with revolving clip.
- **HS-94/HS-95/HS-97** HEADSET + **VS-1L** VOX/PTT CASE  
HS-94: Ear-hook type  
HS-95: Neck-arm type  
HS-97: Throat microphone  
VS-1L: VOX/PTT switch box for hands-free operation, etc.
- **MB-130** VEHICLE CHARGER BRACKET  
Vehicle mounting bracket for BC-160 battery charger.

◇ ANTENNAS

- **FA-SC56VS/FA-SC57VS/FA-SC73US** STUBBY ANTENNAS  
Shorter VHF or UHF antennas.  
FA-SC56VS : 150–162 MHz  
FA-SC57VS : 160–174 MHz  
FA-SC73US : 450–490 MHz
- **FA-SC25V/FA-SC55V**  
**FA-SC25U/FA-SC57U/FA-SC72U** FLEXIBLE ANTENNAS  
VHF or UHF antennas.  
FA-SC25V : 136–150 MHz  
FA-SC55V : 150–174 MHz  
FA-SC25U : 400–430 MHz  
FA-SC57U : 430–470 MHz  
FA-SC72U : 470–520 MHz
- **FA-SC61VC/FA-SC61UC** CUT ANTENNAS  
FA-SC61VC : 136–174 MHz  
FA-SC61UC : 380–520 MHz

Approved Icom optional equipment is designed for optimal performance when used with an Icom transceiver. Icom is not responsible for the destruction or damage to an Icom transceiver in the event the Icom transceiver is used with equipment that is not manufactured or approved by Icom.

Some options may not be available in some countries. Please ask your dealer for details.



Your Icom radio generates RF electromagnetic energy during transmit mode. This radio is designed for and classified as “Occupational Use Only”, meaning it must be used only during the course of employment by individuals aware of the hazards, and the ways to minimize such hazards. This radio is NOT intended for use by the “General

Population” in an uncontrolled environment.

This radio has been tested and complies with the FCC RF exposure limits for “Occupational Use Only”. In addition, your Icom radio complies with the following Standards and Guidelines with regard to RF energy and electromagnetic energy levels and evaluation of such levels for exposure to humans:

- FCC OET Bulletin 65 Edition 97-01 Supplement C, Evaluating Compliance with FCC Guidelines for Human Exposure to Radio Frequency Electromagnetic Fields.
- American National Standards Institute (C95.1-1992), IEEE Standard for Safety Levels with Respect to Human Exposure to Radio Frequency Electromagnetic Fields, 3 kHz to 300 GHz.
- American National Standards Institute (C95.3-1992), IEEE Recommended Practice for the Measurement of Potentially Hazardous Electromagnetic Fields— RF and Microwave.
- The following accessories are authorized for use with this product. Use of accessories other than those specified may result in RF exposure levels exceeding the FCC requirements for wireless RF exposure.; Belt Clip (MB-94), Rechargeable Li-Ion Battery Pack (BP-232N/BP-232H) and Speaker-microphone (HM-131L).



CAUTION

To ensure that your exposure to RF electromagnetic energy is within the FCC allowable limits for occupational use, always adhere to the following guidelines:

- **DO NOT** operate the radio without a proper antenna attached, as this may damage the radio and may also cause you to exceed FCC RF exposure limits. A proper antenna is the antenna supplied with this radio by the manufacturer or antenna specifically authorized by the manufacturer for use with this radio.
- **DO NOT** transmit for more than 50% of total radio use time (“50% duty cycle”). Transmitting more than 50% of the time can cause FCC RF exposure compliance requirements to be exceeded. The radio is transmitting when the “TX” (TX indicator) lights. You can cause the radio to transmit by pressing the “PTT” switch.
- **ALWAYS keep** the antenna at least 2.5 cm (1 inch) away from the body when transmitting and only use the Icom belt-clips listed on page 46 when attaching the radio to your belt, etc., to ensure FCC RF exposure compliance requirements are not exceeded. To provide the recipients of your transmission the best sound quality, hold the antenna at least 5 cm (2 inches) from your mouth, and slightly off to one side.

The information listed above provides the user with the information needed to make him or her aware of RF exposure, and what to do to assure that this radio operates with the FCC RF exposure limits of this radio.

**Electromagnetic Interference/Compatibility**

During transmissions, your Icom radio generates RF energy that can possibly cause interference with other devices or systems. To avoid such interference, turn off the radio in areas where signs are posted to do so. **DO NOT** operate the transmitter in areas that are sensitive to electromagnetic radiation such as hospitals, aircraft, and blasting sites.

**Occupational/Controlled Use**

The radio transmitter is used in situations in which persons are exposed as consequence of their employment provided those persons are fully aware of the potential for exposure and can exercise control over their exposure.









**Count on us!**

A-6535H-1EX-②a  
Printed in Japan  
© 2006–2012 Icom Inc.

Printed on recycled paper with soy ink.

**Icom Inc.**

1-1-32 Kamiminami, Hirano-ku, Osaka 547-0003, Japan