

# ENGINEERING TEST REPORT

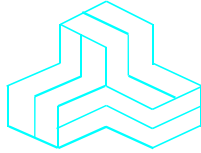

**UHF Trunked Radio**  
**Model No.: IC-F43TR**  
**FCC ID: AFJ272102**

*Applicant:*

**ICOM Incorporated**  
1-1-32, Kamiminami, Hirano-ku  
Osaka  
Japan, 547-0003

*Tested in Accordance With*

**Federal Communications Commission (FCC)**  
**47 CFR, Parts 2 and 90 (Subpart I)**

**UltraTech's File No.: ICOM-079F90**

This Test report is Issued under the Authority of  
Tri M. Luu, Professional Engineer,  
Vice President of Engineering  
UltraTech Group of Labs

Date: March 10, 2004



Report Prepared by: Anca Dobre

Tested by: Hung Trinh, EMI/RFI Technician

Issued Date: March 10, 2004

Test Dates: January 7 - March 3, 2004

- *The results in this Test Report apply only to the sample(s) tested, and the sample tested is randomly selected.*
- *This report must not be used by the client to claim product endorsement by NVLAP or any agency of the US Government.*

## UltraTech

3000 Bristol Circle, Oakville, Ontario, Canada, L6H 6G4  
Tel.: (905) 829-1570 Fax.: (905) 829-8050  
Website: [www.ultratech-labs.com](http://www.ultratech-labs.com), Email: [vic@ultratech-labs.com](mailto:vic@ultratech-labs.com), Email: [tri@ultratech-labs.com](mailto:tri@ultratech-labs.com)



## TABLE OF CONTENTS

<b>EXHIBIT 1.</b>	<b>SUBMITTAL CHECK LIST .....</b>	<b>1</b>
<b>EXHIBIT 2.</b>	<b>INTRODUCTION.....</b>	<b>2</b>
2.1.	SCOPE .....	2
2.2.	RELATED SUBMITTAL(S)/GRANT(S) .....	2
2.3.	NORMATIVE REFERENCES .....	2
<b>EXHIBIT 3.</b>	<b>PERFORMANCE ASSESSMENT .....</b>	<b>3</b>
3.1.	CLIENT INFORMATION.....	3
3.2.	EQUIPMENT UNDER TEST (EUT) INFORMATION.....	3
3.3.	EUT'S TECHNICAL SPECIFICATIONS.....	4
3.4.	LIST OF EUT'S PORTS.....	4
<b>EXHIBIT 4.</b>	<b>EUT OPERATING CONDITIONS AND CONFIGURATIONS DURING TESTS .....</b>	<b>5</b>
4.1.	CLIMATE TEST CONDITIONS .....	5
4.2.	OPERATIONAL TEST CONDITIONS & ARRANGEMENT FOR TEST SIGNALS .....	5
<b>EXHIBIT 5.</b>	<b>SUMMARY OF TEST RESULTS.....</b>	<b>6</b>
5.1.	LOCATION OF TESTS.....	6
5.2.	APPLICABILITY & SUMMARY OF EMISSION TEST RESULTS .....	6
5.3.	MODIFICATIONS INCORPORATED IN THE EUT FOR COMPLIANCE PURPOSES.....	6
5.4.	DEVIATION OF STANDARD TEST PROCEDURES .....	6
<b>EXHIBIT 6.</b>	<b>MEASUREMENTS, EXAMINATIONS &amp; TEST DATA FOR EMC EMISSIONS.....</b>	<b>7</b>
6.1.	TEST PROCEDURES .....	7
6.2.	MEASUREMENT UNCERTAINTIES .....	7
6.3.	MEASUREMENT EQUIPMENT USED .....	7
6.4.	ESSENTIAL/PRIMARY FUNCTIONS AS DECLARED BY THE MANUFACTURER .....	7
6.5.	RF POWER OUTPUT [§§ 2.1046 & 90.205].....	8
6.6.	FREQUENCY STABILITY [§§ 2.1055 & 90.213].....	9
6.7.	AUDIO FREQUENCY RESPONSE [§ 2.1047(a)] .....	13
6.8.	MODULATION LIMITING [§§ 2.1047(b) & 90.210].....	18
6.9.	OCCUPIED BANDWIDTH & EMISSION MASK [§§ 2.1049, 90.209 & 90.210].....	23
6.10.	TRANSMITTER ANTENNA POWER SPURIOUS/HARMONIC CONDUCTED EMISSIONS [§ 90.210].....	61
6.11.	TRANSMITTER SPURIOUS/HARMONIC RADIATED EMISSIONS [§ 90.210].....	80
6.12.	TRANSIENT FREQUENCY BEHAVIOR [§ 90.214].....	82
<b>EXHIBIT 7.</b>	<b>MEASUREMENT UNCERTAINTY .....</b>	<b>92</b>
7.1.	RADIATED EMISSION MEASUREMENT UNCERTAINTY.....	92
<b>EXHIBIT 8.</b>	<b>MEASUREMENT METHODS .....</b>	<b>93</b>
8.1.	CONDUCTED POWER MEASUREMENTS .....	93
8.2.	RADIATED POWER MEASUREMENTS (ERP & EIRP) USING SUBSTITUTION METHOD.....	94
8.3.	FREQUENCY STABILITY .....	97
8.4.	EMISSION MASK .....	98
8.5.	SPURIOUS EMISSIONS (CONDUCTED).....	98
8.6.	TRANSIENT FREQUENCY BEHAVIOR .....	99

## EXHIBIT 1. SUBMITTAL CHECK LIST

Annex No.	Exhibit Type	Description of Contents	Quality Check (OK)
--	Test Report	<ul style="list-style-type: none"> <li>▪ Exhibit 1: Submittal check lists</li> <li>▪ Exhibit 2: Introduction</li> <li>▪ Exhibit 3: Performance Assessment</li> <li>▪ Exhibit 4: EUT Operation and Configuration during Tests</li> <li>▪ Exhibit 5: Summary of test Results</li> <li>▪ Exhibit 6: Measurement Data</li> <li>▪ Exhibit 7: Measurement Uncertainty</li> <li>▪ Exhibit 8: Measurement Methods</li> </ul>	OK
1	Test Setup Photos	Radiated Emissions Test Setup Photos	OK
2	External Photos of EUT	External EUT Photos	OK
3	Internal Photos of EUT	Internal EUT Photos	OK
4	Cover Letters	Cover Letter	OK
5	Attestation Statements	<ul style="list-style-type: none"> <li>▪ Letter from the Applicant to Appoint Ultratech to Act as an Agent</li> <li>▪ Letter from the Applicant to Request for Confidentiality Filing</li> <li>▪ Applicant Part 90 Attestation</li> </ul>	OK
6	ID Label/Location Info	<ul style="list-style-type: none"> <li>▪ ID Label</li> <li>▪ Location of ID Label</li> </ul>	OK
7	Block Diagrams	Block Diagram	OK
8	Schematic Diagrams	Schematics	OK
9	Parts List/Tune Up Info	<ul style="list-style-type: none"> <li>▪ Parts List</li> <li>▪ Adjustment for IC-F43TR</li> </ul>	OK
10	Operational Description	Circuit Description	OK
11	RF Exposure Info	See SAR Test Report for Details.	OK
12	Users Manual	Instruction Manual	OK

## EXHIBIT 2. INTRODUCTION

### 2.1. SCOPE

<b>Reference:</b>	FCC Parts 2 and 90
<b>Title:</b>	Code of Federal Regulations (CFR), Title 47 Telecommunication – Parts 2 & 90
<b>Purpose of Test:</b>	To obtain FCC Certification Authorization for Radio operating in the Frequency Band 400-470 MHz (12.5 kHz and 25 kHz Channel Spacings).
<b>Test Procedures:</b>	Both conducted and radiated emissions measurements were conducted in accordance with TIA/EIA Standard TIA/EIA-603 (01-Nov-2002) – Land Mobile FM or PM Communications Equipment Measurement and performance Standards.

### 2.2. RELATED SUBMITTAL(S)/GRANT(S)

None.

### 2.3. NORMATIVE REFERENCES

Publication	Year	Title
FCC CFR Parts 0-19, 80-End	2003	Code of Federal Regulations – Telecommunication
ANSI C63.4	2003	American National Standard for Methods of Measurement of Radio-Noise Emissions from Low-Voltage Electrical and Electronic Equipment in the Range of 9 kHz to 40 GHz
TIA/EIA 603, Edition B	01-Nov-2002	Land Mobile FM or PM Communications Equipment Measurement and Performance Standards

### EXHIBIT 3. PERFORMANCE ASSESSMENT

#### 3.1. CLIENT INFORMATION

APPLICANT	
<b>Name:</b>	ICOM Incorporated
<b>Address:</b>	1-1-32, Kamiminami, Hirano-ku Osaka Japan, 547-0003
<b>Contact Person:</b>	Mr. Takashi Aoki Phone #: +81-66-793-5302 Fax #: +81-66-793-0013 Email Address: <a href="mailto:export@icom.co.jp">export@icom.co.jp</a>

MANUFACTURER	
<b>Name:</b>	ICOM Incorporated
<b>Address:</b>	1-1-32, Kamiminami, Hirano-ku Osaka Japan, 547-0003
<b>Contact Person:</b>	Mr. Takashi Aoki Phone #: +81-66-793-5302 Fax #: +81-66-793-0013 Email Address: <a href="mailto:export@icom.co.jp">export@icom.co.jp</a>

#### 3.2. EQUIPMENT UNDER TEST (EUT) INFORMATION

The following information (with the exception of the Date of Receipt) has been supplied by the applicant.

<b>Brand Name:</b>	ICOM Incorporated
<b>Product Name:</b>	UHF Trunked Radio
<b>Model Name or Number:</b>	IC-F43TR
<b>Serial Number:</b>	0000000
<b>Type of Equipment:</b>	Licensed Non-Broadcast UHF portable transceiver for voice communication
<b>External Power Supply:</b>	7.4 VDC Battery
<b>Transmitting/Receiving Antenna Type:</b>	Non-integral
<b>Primary User Functions of EUT:</b>	Voice communication in occupational environment.

**ULTRATECH GROUP OF LABS**

3000 Bristol Circle, Oakville, Ontario, Canada L6H 6G4  
 Tel. #: 905-829-1570, Fax. #: 905-829-8050, Email: [vic@ultratech-labs.com](mailto:vic@ultratech-labs.com), Website: <http://www.ultratech-labs.com>

File #: ICOM-079F90  
 March 10, 2004

All test results contained in this engineering test report are traceable to National Institute of Standards and Technology (NIST)

### 3.3. EUT'S TECHNICAL SPECIFICATIONS

<b>TRANSMITTER</b>	
<b>Equipment Type:</b>	Portable
<b>Intended Operating Environment:</b>	Commercial, Industrial or Business
<b>Power Supply Requirement:</b>	7.4 VDC
<b>RF Output Power Rating:</b>	4 Watts High and 1Watt Low
<b>Operating Frequency Range:</b>	400-470 MHz
<b>RF Output Impedance:</b>	50 Ohms
<b>Channel Spacing:</b>	12.5 kHz and 25 kHz
<b>Occupied Bandwidth (99%):</b>	<ul style="list-style-type: none"> <li>• 7.61 kHz (for 12.5 kHz Channel Spacing)</li> <li>• 11.95 kHz (for 25 kHz Channel Spacing)</li> </ul>
<b>Emission Designation*:</b>	11K0F3E and 16K0F3E
<b>Antenna Connector Type:</b>	J Type Connector
<b>Antenna Description:</b>	<p><b><u>Antenna #1:</u></b>                      Manufacturer: ICOM Inc.                      Antenna Type: ¼ wave whip antenna                      Model Number: FA-SC25U-1                      Operating Frequency: 400-430 MHz                      Gain: -2.57 dBi</p> <p><b><u>Antenna #2:</u></b>                      Manufacturer: ICOM Inc.                      Antenna Type: Helical Whip Antenna                      Model Number: FA-SC73US                      Operating Frequency: 450-490 MHz                      Gain: -10.4 dBi</p>

\* For an average case of commercial telephony, the Necessary Bandwidth is calculated as follows:

For FM Voice Modulation:

Channel Spacing = 12.5 KHz, D = 2.5 KHz max, K = 1, M = 3 KHz

$$B_n = 2M + 2DK = 2(3) + 2(2.5)(1) = \mathbf{11\ KHz}$$

Emission designation: 11K0F3E

Channel Spacing = 25 KHz, D = 5 KHz max, K = 1, M = 3 KHz

$$B_n = 2M + 2DK = 2(3) + 2(5)(1) = \mathbf{16\ KHz}$$

Emission designation: 16K0F3E

### 3.4. LIST OF EUT'S PORTS

Port Number	EUT's Port Description	Number of Identical Ports	Connector Type	Cable Type (Shielded/Non-shielded)
1	Antenna	1	J Type	N/A

#### ULTRATECH GROUP OF LABS

3000 Bristol Circle, Oakville, Ontario, Canada L6H 6G4  
 Tel. #: 905-829-1570, Fax. #: 905-829-8050, Email: [vic@ultratech-labs.com](mailto:vic@ultratech-labs.com), Website: <http://www.ultratech-labs.com>

File #: ICOM-079F90  
 March 10, 2004

All test results contained in this engineering test report are traceable to National Institute of Standards and Technology (NIST)

## EXHIBIT 4. EUT OPERATING CONDITIONS AND CONFIGURATIONS DURING TESTS

### 4.1. CLIMATE TEST CONDITIONS

The climate conditions of the test environment are as follows:

Temperature:	21°C
Humidity:	51%
Pressure:	102 kPa
Power Input Source:	7.4 VDC Battery

### 4.2. OPERATIONAL TEST CONDITIONS & ARRANGEMENT FOR TEST SIGNALS

<b>Operating Modes:</b>	The transmitter was operated in a continuous transmission mode with the carrier modulated as specified in the Test Data.
<b>Special Test Software:</b>	N/A
<b>Special Hardware Used:</b>	N/A
<b>Transmitter Test Antenna:</b>	The EUT is tested with the antenna port terminated to a 50 Ohms RF Load.

<b>Transmitter Test Signals</b>	
<b>Frequency Band(s):</b>	400-470 MHz
<b>Test Frequency(ies):</b> (Near lowest, near middle & near highest frequencies in the frequency range of operation.)	400.1, 435.1 and 469.9 MHz
<b>Transmitter Wanted Output Test Signals:</b>	
Transmitter Power (measured maximum output power):	4 Watts High & 1 Watt Low
Normal Test Modulation:	FM Voice
Modulating signal source:	External

## EXHIBIT 5. SUMMARY OF TEST RESULTS

### 5.1. LOCATION OF TESTS

All of the measurements described in this report were performed at Ultratech Group of Labs located in the city of Oakville, Province of Ontario, Canada.

Radiated Emissions were performed at the Ultratech's 3 Meter Open Field Test Site (OFTS) situated in the Town of Oakville, province of Ontario.

The above sites have been calibrated in accordance with ANSI C63.4, and found to be in compliance with the requirements of Sec. 2.948 of the FCC Rules. The descriptions and site measurement data of the Oakville Open Field Test Site has been filed with FCC office (FCC File No.: 31040/SIT 1300B3) and Industry Canada office (Industry Canada File No.: IC2049). Last Date of Site Calibration: November 4, 2003.

### 5.2. APPLICABILITY & SUMMARY OF EMISSION TEST RESULTS

FCC Section(s)	Test Requirements	Applicability Yes/No)
90.205 & 2.1046	RF Power Output	Yes
1.1307, 1.1310, 2.1091 & 2.1093	RF Exposure Limit	Yes
90.213 & 2.1055	Frequency Stability	Yes
90.242(b)(8) & 2.1047(a)	Audio Frequency Response	Not applicable to new standard. However, tests are conducted under FCC's recommendation.
90.210 & 2.1047(b)	Modulation Limiting	Yes
90.210 & 2.1049	Emission Limitation & Emission Mask	Yes
90.210, 2.1057 & 2.1051	Emission Limits - Spurious Emissions at Antenna Terminal	Yes
90.210, 2.1057 & 2.1053	Emission Limits - Field Strength of Spurious Emissions	Yes
90.214	Transient Frequency Behavior	Yes

**Portable UHF FM TRANSCEIVER, Model No.: IC-F43TR**, by **ICOM Incorporated** has also been tested and found to comply with **FCC Part 15, Subpart B - Radio Receivers and Class A Digital Devices**. The engineering test report has been documented and kept on file and it is available upon request.

### 5.3. MODIFICATIONS INCORPORATED IN THE EUT FOR COMPLIANCE PURPOSES

None.

### 5.4. DEVIATION OF STANDARD TEST PROCEDURES

None.

---

#### ULTRATECH GROUP OF LABS

3000 Bristol Circle, Oakville, Ontario, Canada L6H 6G4  
 Tel. #: 905-829-1570, Fax. #: 905-829-8050, Email: [vic@ultratech-labs.com](mailto:vic@ultratech-labs.com), Website: <http://www.ultratech-labs.com>

File #: ICOM-079F90  
 March 10, 2004

*All test results contained in this engineering test report are traceable to National Institute of Standards and Technology (NIST)*



## **EXHIBIT 6. MEASUREMENTS, EXAMINATIONS & TEST DATA FOR EMC EMISSIONS**

### **6.1. TEST PROCEDURES**

This section contains test results only. Details of test methods and procedures can be found in Exhibit 8 of this report

### **6.2. MEASUREMENT UNCERTAINTIES**

The measurement uncertainties stated were calculated in accordance with requirements of UKAS Document NIS 81 with a confidence level of 95%. Please refer to Exhibit 7 for Measurement Uncertainties.

### **6.3. MEASUREMENT EQUIPMENT USED**

The measurement equipment used complied with the requirements of the Standards referenced in the Methods & Procedures ANSI C63.4: 2001 and CISPR 16-1.

### **6.4. ESSENTIAL/PRIMARY FUNCTIONS AS DECLARED BY THE MANUFACTURER**

The essential function of the EUT is to correctly communicate data to and from radios over RF link.

## 6.5. RF POWER OUTPUT [§§ 2.1046 & 90.205]

### 6.5.1. Limits

Please refer to FCC 47 CFR 90.205 for specification details.

### 6.5.2. Method of Measurements

Refer to Exhibit 8, Section 8.1 (Conducted) and 8.2 (Radiated) of this report for measurement details

### 6.5.3. Test Equipment List

Test Instruments	Manufacturer	Model No.	Serial No.	Frequency Range
Attenuator	Weinschel Corp	23-20-34	BH7876	DC – 18 GHz
Power Meter	Hewlett Packard	436A	2709A27515	10 kHz – 50 GHz, sensor dependent
Power Sensor	Hewlett Packard	8481A	1550A07043	10 MHz – 18 GHz

### 6.5.4. Test Arrangement

Power at RF Power Output Terminals:

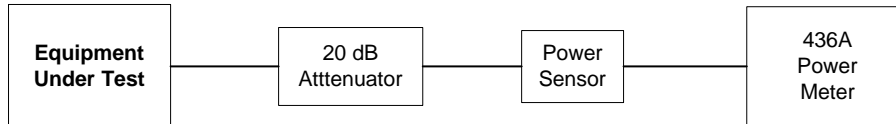

### 6.5.5. Test Data

Transmitter Channel Output	Fundamental Frequency (MHz)	Measured (Average) Power (dBm)	Power Rating (dBm)
Lowest	400.1	35.96	36
Middle	435.1	35.96	36
Highest	469.9	35.78	36
Lowest	400.1	30.07	30
Middle	435.1	30.50	30
Highest	469.9	29.88	30

## 6.6. FREQUENCY STABILITY [§§ 2.1055 & 90.213]

### 6.6.1. Limits

Refer to FCC 47 CFR 90.213 for specification details.

Frequency Range (MHz)	Channel Bandwidth (kHz)	Frequency Tolerance (ppm)		
		Fixed and Base Stations	Mobile Stations	
			> 2 W	≤ 2 W
421-512 MHz	12.5	1.5	2.5	2.5
	25	2.5	5.0	5.0

### 6.6.2. Method of Measurements

Refer to Exhibit 8, Section 8.3 of this report for measurement details

### 6.6.3. Test Equipment List

Test Instruments	Manufacturer	Model No.	Serial No.	Frequency Range
Spectrum Analyzer	HP	8953EM	3710A00237	9 kHz – 22 GHz
Attenuator	Weinschel Corp	23-20-34	BH7876	DC – 18 GHz
Temperature & Humidity Chamber	Tenney	T5	9723B	-40° to +60° C range

### 6.6.4. Test Arrangement

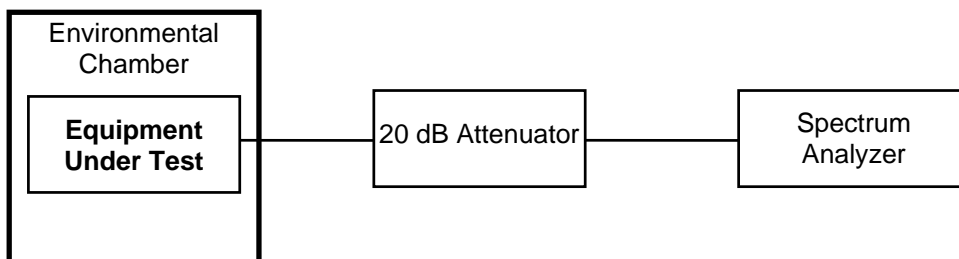

**6.6.5. Test Data**

<b>Product Name:</b> <b>Model No.:</b>	<b>UHF Trunked Radio</b> <b>IC-F43TR</b>
<b>Center Frequency:</b>	400.1 MHz
<b>Full Power Level:</b>	4 Watts
<b>Frequency Tolerance Limit:</b>	$\pm 2.5$ ppm or $\pm 1000.25$ Hz
<b>Max. Frequency Tolerance Measured:</b>	-326 Hz or 0.8 ppm
<b>Input Voltage Rating:</b>	7.4 VDC

Ambient Temperature (°C)	CENTER FREQUENCY & RF POWER OUTPUT VARIATION		
	Supply Voltage (Nominal) 7.4Vdc	Supply Voltage (Battery End Point) 5.4Vdc	Supply Voltage (Battery Fully Charged) 8.625Vdc
	Hz	Hz	Hz
-30	-326	N/A	N/A
-20	-211	N/A	N/A
-10	-234	N/A	N/A
-80	-80	N/A	N/A
+10	-29	N/A	N/A
+20	+63	+86	+86
+30	+63	N/A	N/A
+40	-57	N/A	N/A
+50	+109	N/A	N/A

**6.6.5.1. RF Output Power Versus Input Voltage at Room Temperature (Li-ion Battery)**

Input Voltage (Vdc)	Input Current (A)	RF Output Power (dBm)
7.8	1.718	35.91
7.6	1.722	35.93
7.4	1.752	36.01
7.2	1.805	36.08
7.0	1.858	36.12
6.8	0.867	29.96
6.6	0.868	29.95
6.4	0.870	29.94
6.2	0.871	29.93
6.0	0.873	29.93
5.8	0.875	29.93
5.6	0.829	29.92
5.4	0.829	29.92

**6.6.5.2. RF Output Power Drop Versus Time (with BP-32 Li-ion Battery at Room Temperature)**

Time (Minutes)	Input Voltage (Vdc)	Input Current (A)	RF Output Power (dBm)
0	7.90	1.715	36.90
1	7.63	1.723	35.93
2	7.57	1.727	35.93
3	7.54	1.734	35.96
4	7.50	1.738	35.96
5	7.46	1.749	35.99
10	7.34	1.774	36.04
15	7.18	1.809	36.09
20	7.06	1.835	36.10
25	6.97	1.858	36.12
28	6.91	1.865	36.12
30	7.29	0.878	30.00
35	7.27	0.873	29.98
40	7.24	0.871	29.97
45	7.22	0.873	29.98
50	7.20	0.861	29.96
55	7.18	0.865	29.93
60	7.16	0.865	29.94
65	7.13	0.864	29.94
70	7.11	0.864	29.94
75	7.07	0.864	29.94
80	7.02	0.863	29.94
85	6.96	0.866	29.96
90	6.80	0.867	29.96
95	6.23	0.871	29.93
97	5.40	0.879	29.92

## 6.7. AUDIO FREQUENCY RESPONSE [§ 2.1047(a)]

### 6.7.1. Limits

Recommended audio filter attenuation characteristics are given below:

RF Band	Audio band	Minimum Attenuation Rel. to 1 kHz Attenuation
421-512 MHz	3 –20 kHz 20 – 30 kHz	$60 \log_{10}(f/3)$ dB where f is in kHz 50dB

### 6.7.2. Method of Measurements

The rated audio input signal was applied to the input of the audio low-pass filter (or of all modulation stages) using an audio oscillator, this input signal level and its corresponding output signal were then measured and recorded using the FFT Digital Spectrum Analyzer. Tests were repeated at different audio signal frequencies from 0 to 50 kHz.

### 6.7.3. Test Equipment List

Test Instruments	Manufacturer	Model No.	Serial No.	Frequency Range
FFT Digital Spectrum Analyzer	Advantest	R9211Z	8202336	10 mHz – 100 kHz
Radio Communication Test Set	Marconi	2955	132037/226	20 Hz – 20 kHz
Modulation Analyzer	Hewlett Packard	8901B	3226A04606	150 kHz – 1300 MHz
Attenuator(s)	Weinschel Corp	23-20-34	BH7876	DC – 18 GHz
Digital Multimeter	Rohde & Schwarz	UDS-5	8729841067	DC – 100 kHz

### 6.7.4. Test Arrangement

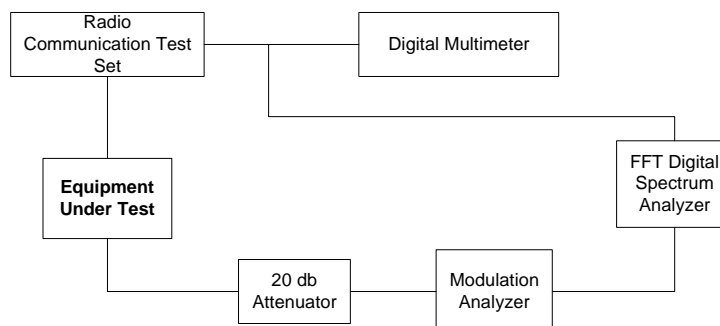

**6.7.5. Test Data**

**6.7.5.1. 12.5 kHz Channel Spacing, F3E, Frequency of All Modulation States\***

**Note:** Due to the difficulty of measuring the Frequency Response of the internal low-pass filter, the Frequency Response of All Modulation States are performed to show the roll-off at 3 kHz in comparison with the recommended audio filter attenuation.

FREQUENCY (kHz)	AUDIO IN (dBV)	AUDIO OUT (dBV)	ATTENUATION (OUT - IN) (dB)	ATTENUATION wrt. 1 kHz (dB)	RECOMMENDED ATTENUATION (dB)
0.10	-36.8	<-60.0	<-23.2	<-60.4	--
0.20	-36.8	<-60.0	<-23.2	<-60.4	--
0.40	-36.8	-8.0	28.9	-8.4	--
0.60	-36.8	-4.4	32.4	-4.8	--
0.80	-36.8	-1.6	35.3	-2.0	--
1.00	-36.8	0.4	37.3	0.0	--
1.50	-36.8	2.5	39.3	2.1	--
2.00	-36.8	2.7	39.6	2.3	--
2.50	-36.8	1.8	38.7	1.4	--
3.00	-36.8	-1.4	35.4	-1.8	0.0
3.50	-36.8	-6.7	30.2	-7.1	-4.0
4.00	-36.8	-12.6	24.2	-13.0	-7.5
4.50	-36.8	-18.0	18.8	-18.4	-10.6
5.00	-36.8	-23.0	13.8	-23.4	-13.3
6.00	-36.8	-31.8	5.0	-32.2	-18.1
7.00	-36.8	-40.1	-3.3	-40.5	-22.1
8.00	-36.8	-47.4	-10.6	-47.8	-25.6
9.00	-36.8	<-60.0	<-23.2	<-60.4	<-28.6
10.00	-36.8	<-60.0	<-23.2	<-60.4	<-31.4
12.00	-36.8	<-60.0	<-23.2	<-60.4	<-36.1
14.00	-36.8	<-60.0	<-23.2	<-60.4	<-40.1
16.00	-36.8	<-60.0	<-23.2	<-60.4	<-43.6
18.00	-36.8	<-60.0	<-23.2	<-60.4	<-46.7
20.00	-36.8	<-60.0	<-23.2	<-60.4	<-50.0
26.00	-36.8	<-60.0	<-23.2	<-60.4	<-50.0
28.00	-36.8	<-60.0	<-23.2	<-60.4	<-50.0
30.00	-36.8	<-60.0	<-23.2	<-60.4	<-50.0
40.00	-36.8	<-60.0	<-23.2	<-60.4	<-50.0
50.00	-36.8	<-60.0	<-23.2	<-60.4	<-50.0

**ULTRATECH GROUP OF LABS**

3000 Bristol Circle, Oakville, Ontario, Canada L6H 6G4  
 Tel. #: 905-829-1570, Fax. #: 905-829-8050, Email: [vic@ultratech-labs.com](mailto:vic@ultratech-labs.com), Website: <http://www.ultratech-labs.com>

File #: ICOM-079F90

March 10, 2004

All test results contained in this engineering test report are traceable to National Institute of Standards and Technology (NIST)



AUDIO FREQUENCY RESPONSE OF ALL MODULATION STATES  
47 CFR 2.1047(a)  
UHF Trunked Radio, Model IC-F43TR  
12.5 kHz Channel Spacing

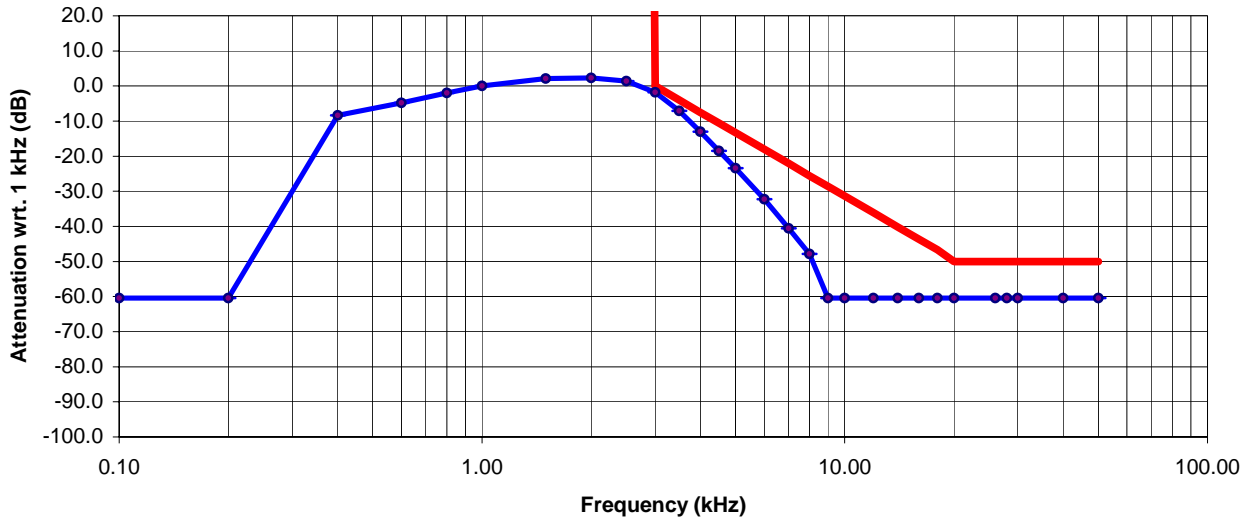

**6.7.5.2. 25 kHz Channel Spacing, F3E, Frequency of All Modulation States\***

**Note:** Due to the difficulty of measuring the Frequency Response of the internal low-pass filter, the Frequency Response of All Modulation States are performed to show the roll-off at 3 kHz in comparison with FCC Limit for audio low-pass filter.

FREQUENCY (kHz)	AUDIO IN (dBV)	AUDIO OUT (dBV)	ATTENUATION (OUT - IN) (dB)	ATTENUATION wrt. 1 kHz (dB)	FCC LIMIT (dB)
0.10	-36.5	<-60.0	<-23.5	<-66.4	--
0.20	-36.5	-33.5	3.0	-39.9	--
0.40	-36.5	-1.9	34.6	-8.4	--
0.60	-36.5	1.6	38.1	-4.9	--
0.80	-36.5	4.4	40.9	-2.0	--
1.00	-36.5	6.4	42.9	0.0	--
1.50	-36.5	8.5	45.0	2.1	--
2.00	-36.5	8.5	45.0	2.1	--
2.50	-36.5	8.4	44.9	2.0	--
3.00	-36.5	7.0	43.5	0.6	0.0
3.50	-36.5	3.5	40.0	-2.9	-4.0
4.00	-36.5	-1.5	35.0	-7.9	-7.5
4.50	-36.5	-6.6	29.9	-13.0	-10.6
5.00	-36.5	-11.6	24.9	-18.0	-13.3
6.00	-36.5	-20.9	15.6	-27.3	-18.1
7.00	-36.5	-29.0	7.5	-35.4	-22.1
8.00	-36.5	-37.4	-0.9	-43.8	-25.6
9.00	-36.5	-45.4	-8.9	-51.8	-28.6
10.00	-36.5	<-60.0	<-23.5	<-66.4	<-31.4
12.00	-36.5	<-60.0	<-23.5	<-66.4	<-36.1
14.00	-36.5	<-60.0	<-23.5	<-66.4	<-40.1
16.00	-36.5	<-60.0	<-23.5	<-66.4	<-43.6
18.00	-36.5	<-60.0	<-23.5	<-66.4	<-46.7
20.00	-36.5	<-60.0	<-23.5	<-66.4	<-50.0
26.00	-36.5	<-60.0	<-23.5	<-66.4	<-50.0
28.00	-36.5	<-60.0	<-23.5	<-66.4	<-50.0
30.00	-36.5	<-60.0	<-23.5	<-66.4	<-50.0
40.00	-36.5	<-60.0	<-23.5	<-66.4	<-50.0
50.00	-36.5	<-60.0	<-23.5	<-66.4	<-50.0

**ULTRATECH GROUP OF LABS**

3000 Bristol Circle, Oakville, Ontario, Canada L6H 6G4  
 Tel. #: 905-829-1570, Fax. #: 905-829-8050, Email: [vic@ultratech-labs.com](mailto:vic@ultratech-labs.com), Website: <http://www.ultratech-labs.com>

File #: ICOM-079F90

March 10, 2004

All test results contained in this engineering test report are traceable to National Institute of Standards and Technology (NIST)

AUDIO FREQUENCY RESPONSE OF ALL MODULATION STATES  
47 CFR 2.1047(a)  
UHF Trunked Radio, Model IC-F43TR  
25 kHz Channel Spacing

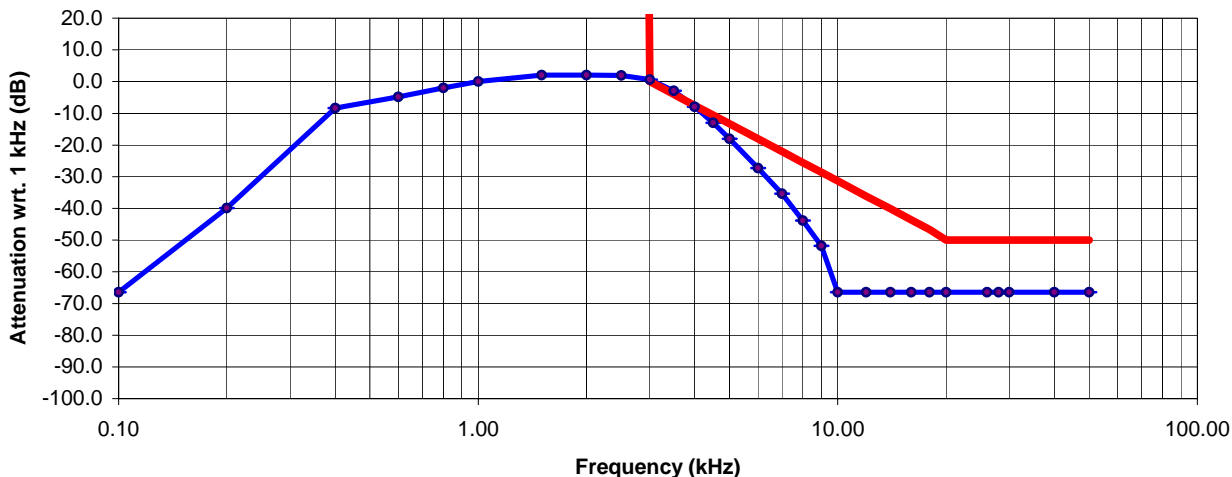

## 6.8. MODULATION LIMITING [§§ 2.1047(b) & 90.210]

### 6.8.1. Limits

Recommended frequency deviation characteristics are given below:

- 2.5 kHz for 12.5 kHz Channel Spacing
- 5 kHz for 25 kHz Channel Spacing System

### 6.8.2. Method of Measurements

**For Audio Transmitter:** The carrier frequency deviation was measured with the tone input signal level varied from 0 Vp to audio input rating level plus 16 dB at frequencies 0.1, 0.5, 1.0, 3.0 and 5.0 kHz. The maximum deviation was recorded at each test condition.

**For Data Transmitter with Maximum Frequency Deviation set by Factory:** The EUT was set at maximum frequency deviation, and its peak frequency deviation was then measured using EUT's internal random data source.

### 6.8.3. Test Equipment List

Test Instruments	Manufacturer	Model No.	Serial No.	Frequency Range
Radio Communication Test Set	Marconi	2955	132037/226	20 Hz – 20 kHz
Modulation Analyzer	Hewlett Packard	8901B	3226A04606	150 kHz – 1300 MHz
Attenuator(s)	Weinschel Corp	23-20-34	BH7876	DC – 18 GHz
Digital Multimeter	Rohde & Schwarz	UDS-5	8729841067	DC – 100 kHz

### 6.8.4. Test Arrangement

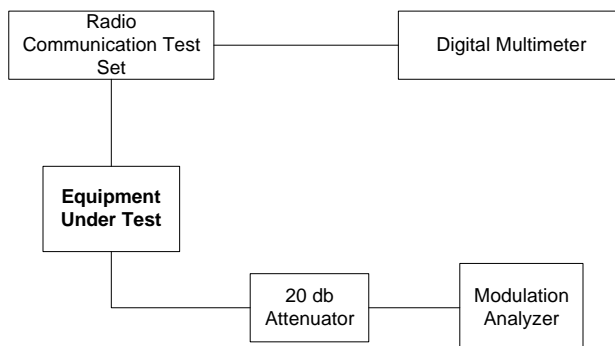

### 6.8.5. Test Data

#### 6.8.5.1. Voice Modulation Limiting for 12.5 kHz Channel Spacing Operation

MODULATING SIGNAL LEVEL	PEAK FREQUENCY DEVIATION (kHz) at the following modulating frequency:					MAXIMUM LIMIT (kHz)
	0.1 kHz	0.5 kHz	1.0 kHz	3.0 kHz	5.0 kHz	
(mVrms)						
1	0.07	0.09	0.16	0.21	0.07	2.5
2	0.07	0.13	0.27	0.37	0.07	2.5
4	0.08	0.22	0.43	0.70	0.10	2.5
6	0.06	0.31	0.65	1.02	0.13	2.5
8	0.07	0.41	0.83	1.15	0.14	2.5
10	0.06	0.51	1.03	1.20	0.15	2.5
12	0.07	0.59	1.25	1.22	0.15	2.5
14	0.07	0.70	1.42	1.24	0.18	2.5
16	0.07	0.29	1.64	1.25	0.17	2.5
18	0.07	0.87	1.78	1.26	0.17	2.5
20	0.07	0.96	1.81	1.26	0.17	2.5
25	0.07	1.20	1.90	1.28	0.17	2.5
30	0.07	1.44	1.96	1.27	0.17	2.5
35	0.07	1.66	2.00	1.27	0.22	2.5
40	0.07	1.67	2.02	1.28	0.23	2.5
45	0.07	1.67	2.04	1.29	0.23	2.5
50	0.07	1.68	2.04	1.29	0.73	2.5
60	0.07	1.69	2.08	1.31	0.25	2.5
70	0.06	1.70	2.09	1.33	0.25	2.5
80	0.08	1.77	2.12	1.34	0.25	2.5
90	0.33	1.93	2.09	1.34	0.27	2.5
100	0.50	1.97	2.08	1.34	0.27	2.5

Voice Signal Input Level = STD MOD Level + 16 dB  
= 23.16 dB(mVrms) + 16 dB  
= 39.16 dB(mVrms)  
= 90.8 mVrms

MODULATING FREQUENCY (KHz)	PEAK FREQUENCY DEVIATION (KHz)	MAXIMUM LIMIT (KHz)
0.1	0.33	2.5
0.2	0.91	2.5
0.4	1.77	2.5
0.6	1.93	2.5
0.8	1.99	2.5
1.0	2.09	2.5
1.2	2.07	2.5
1.4	2.07	2.5
1.6	2.10	2.5
1.8	2.10	2.5
2.0	2.08	2.5
2.5	1.91	2.5
3.0	1.34	2.5
3.5	0.76	2.5
4.0	0.47	2.5
4.5	0.37	2.5
5.0	0.27	2.5
6.0	0.17	2.5
7.0	0.09	2.5
8.0	0.30	2.5
9.0	0.11	2.5
10.0	0.08	2.5

**ULTRATECH GROUP OF LABS**

3000 Bristol Circle, Oakville, Ontario, Canada L6H 6G4  
Tel. #: 905-829-1570, Fax. #: 905-829-8050, Email: [vic@ultratech-labs.com](mailto:vic@ultratech-labs.com), Website: <http://www.ultratech-labs.com>

File #: ICOM-079F90

March 10, 2004

All test results contained in this engineering test report are traceable to National Institute of Standards and Technology (NIST)

**6.8.5.2. Voice Modulation Limiting for 25 kHz Channel Spacing Operation**

MODULATING SIGNAL LEVEL	PEAK FREQUENCY DEVIATION (kHz) at the following modulating frequency:					MAXIMUM LIMIT  (kHz)
	(mVrms)	0.1 kHz	0.5 kHz	1.0 kHz	3.0 kHz	
1	0.07	0.15	0.22	0.48	0.10	5
2	0.07	0.21	0.41	0.92	0.15	5
4	0.07	0.42	0.88	1.79	0.24	5
6	0.06	0.58	1.23	2.66	0.34	5
8	0.07	0.78	1.60	3.02	0.38	5
10	0.07	0.97	2.05	3.14	0.43	5
12	0.07	1.15	2.41	3.21	0.42	5
14	0.07	1.34	2.78	3.26	0.49	5
16	0.07	1.51	3.23	3.28	0.47	5
18	0.07	1.70	3.41	3.30	0.46	5
20	0.07	1.87	3.47	3.32	0.44	5
25	0.07	2.34	3.60	3.35	0.48	5
30	0.07	2.80	3.72	3.35	0.60	5
35	0.07	3.24	3.82	3.35	0.63	5
40	0.07	3.28	3.88	3.35	0.63	5
45	0.07	3.35	3.92	3.38	0.64	5
50	0.07	3.39	3.96	3.40	0.63	5
60	0.08	3.42	4.00	3.43	0.65	5
70	0.08	3.46	4.03	3.45	0.64	5
80	0.16	3.43	4.10	3.47	0.65	5
90	0.68	3.59	4.02	3.47	0.65	5
100	1.03	3.72	4.01	3.47	0.65	5

Voice Signal Input Level = STD MOD Level + 16 dB  
= 23.52 dB(mVrms) + 16 dB  
= 39.52 dB(mVrms)  
= 94.6 mVrms

MODULATING FREQUENCY (KHz)	PEAK FREQUENCY DEVIATION (KHz)	MAXIMUM LIMIT (KHz)
0.1	0.68	5
0.2	1.14	5
0.4	3.51	5
0.6	3.47	5
0.8	3.89	5
1.0	4.02	5
1.2	4.08	5
1.4	4.06	5
1.6	4.09	5
1.8	4.09	5
2.0	4.11	5
2.5	4.05	5
3.0	3.49	5
3.5	2.47	5
4.0	1.45	5
4.5	0.97	5
5.0	0.65	5
6.0	0.41	5
7.0	0.17	5
8.0	0.57	5
9.0	0.13	5
10.0	0.10	5

**ULTRATECH GROUP OF LABS**

3000 Bristol Circle, Oakville, Ontario, Canada L6H 6G4  
Tel. #: 905-829-1570, Fax. #: 905-829-8050, Email: [vic@ultratech-labs.com](mailto:vic@ultratech-labs.com), Website: <http://www.ultratech-labs.com>

File #: ICOM-079F90

March 10, 2004

All test results contained in this engineering test report are traceable to National Institute of Standards and Technology (NIST)



## 6.9. OCCUPIED BANDWIDTH & EMISSION MASK [§§ 2.1049, 90.209 & 90.210]

### 6.9.1. Limits

Emissions shall be attenuated below the mean output power of the transmitter as follows:

Frequency Range (MHz)	Maximum Authorized BW (KHz)	Channel Spacing (KHz)	Recommended Frequency Deviation (KHz)	FCC Applicable Mask
421-512	20.0	25.0	5.0	<ul style="list-style-type: none"> <li>Mask B – Voice</li> <li>Mask C – Data</li> </ul>
421-512	11.25	12.5	2.5	<ul style="list-style-type: none"> <li>Mask D – Voice &amp; Data</li> </ul>

### 6.9.2. Method of Measurements

Refer to Exhibit 8, Section 8.4 of this report for measurement details.

### 6.9.3. Test Equipment List

Test Instruments	Manufacturer	Model No.	Serial No.	Frequency Range
Spectrum Analyzer	HP	8953EM	3710A00237	9 kHz – 22 GHz
Attenuator(s)	Weinschel Corp	23-20-34	BH7876	DC – 18 GHz
Radio Communication Test Set	Marconi	2955	132037/226	20Hz – 20kHz
Digital Multimeter	Rohde & Schwarz	UDS-5	8729841067	DC-100 kHz

### 6.9.4. Test Arrangement

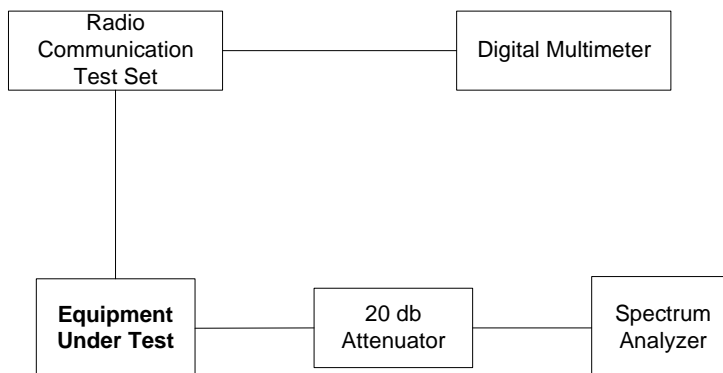

### 6.9.5. Test Data

#### 6.9.5.1. 99% Occupied Bandwidth

Frequency (MHz)	Channel Spacing (kHz)	Modulation	*Measured 99% OBW at Maximum Freq. Deviation (kHz)	Maximum Authorized Bandwidth (kHz)
400.1	12.5	FM with 2.5 kHz sine wave signal	8.66	11.25
435.1	12.5	FM with 2.5 kHz sine wave signal	8.96	11.25
469.9	12.5	FM with 2.5 kHz sine wave signal	8.78	11.25
400.1	25.0	FM with 2.5 kHz sine wave signal	13.95	20.0
435.1	25.0	FM with 2.5 kHz sine wave signal	13.50	20.0
469.9	25.0	FM with 2.5 kHz sine wave signal	13.15	20.0
400.1	12.5	FM with 2.5 kHz sine wave signal with Scrambler	7.61	11.25
435.1	12.5	FM with 2.5 kHz sine wave signal with Scrambler	7.61	11.25
469.9	12.5	FM with 2.5 kHz sine wave signal with Scrambler	7.61	11.25
400.1	25.0	FM with 2.5 kHz sine wave signal with Scrambler	12.05	20.0
435.1	25.0	FM with 2.5 kHz sine wave signal with Scrambler	12.05	20.0
469.9	25.0	FM with 2.5 kHz sine wave signal with Scrambler	11.95	20.0

\*Refer to the following test data plots (1 through 12) for details.

Plot # 1:  
Occupied Bandwidth  
Carrier Frequency: 400.1 MHz  
Channel Spacing: 12.5 kHz  
Power: 4 W  
Modulation: FM with 2.5kHz sine wave

177

ACTV DET: PEAK  
MEAS DET: PEAK QP AVG  
MKR 8.66 kHz  
- .16 dB

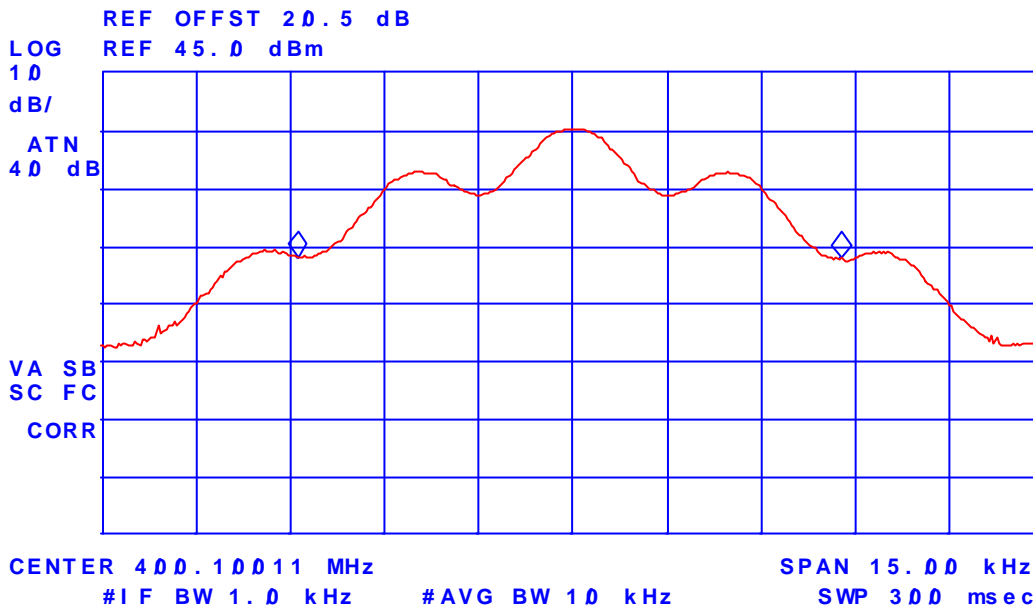

Plot # 2:  
Occupied Bandwidth  
Carrier Frequency: 435.1 MHz  
Channel Spacing: 12.5 kHz  
Power: 4 W  
Modulation: FM with 2.5kHz sine wave

177

ACTV DET: PEAK  
MEAS DET: PEAK QP AVG  
MKR 8.96 kHz  
- .23 dB

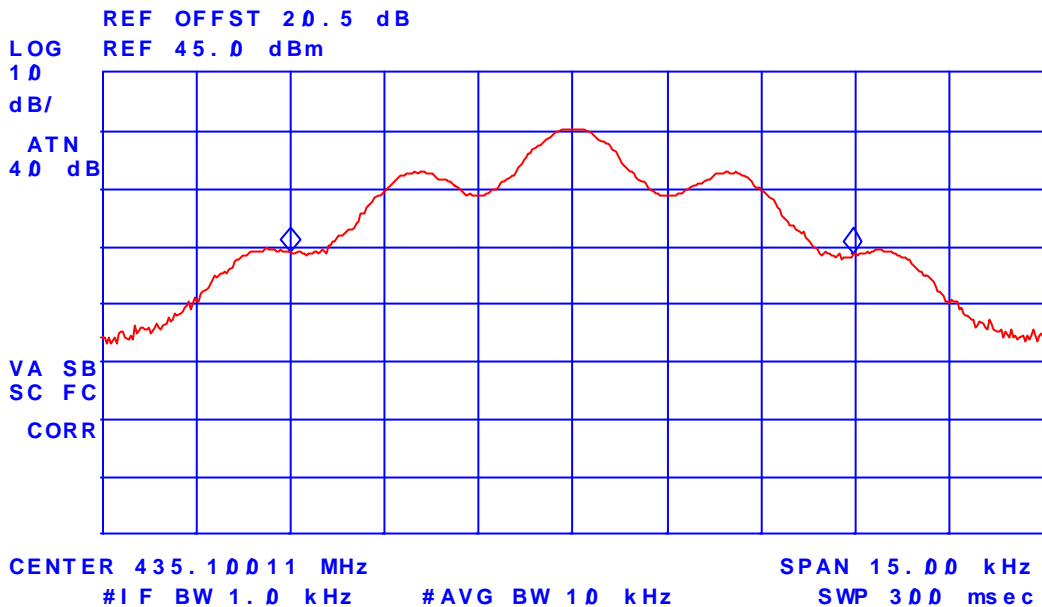

**ULTRATECH GROUP OF LABS**

3000 Bristol Circle, Oakville, Ontario, Canada L6H 6G4  
Tel. #: 905-829-1570, Fax. #: 905-829-8050, Email: [vic@ultratech-labs.com](mailto:vic@ultratech-labs.com), Website: <http://www.ultratech-labs.com>

File #: ICOM-079F90

March 10, 2004

All test results contained in this engineering test report are traceable to National Institute of Standards and Technology (NIST)

Plot # 3:  
Occupied Bandwidth  
Carrier Frequency: 469.9 MHz  
Channel Spacing: 12.5 kHz  
Power: 4 W  
Modulation: FM with 2.5kHz sine wave

177

ACTV DET: PEAK  
MEAS DET: PEAK QP AVG  
MKR 8.78 kHz  
- .21 dB

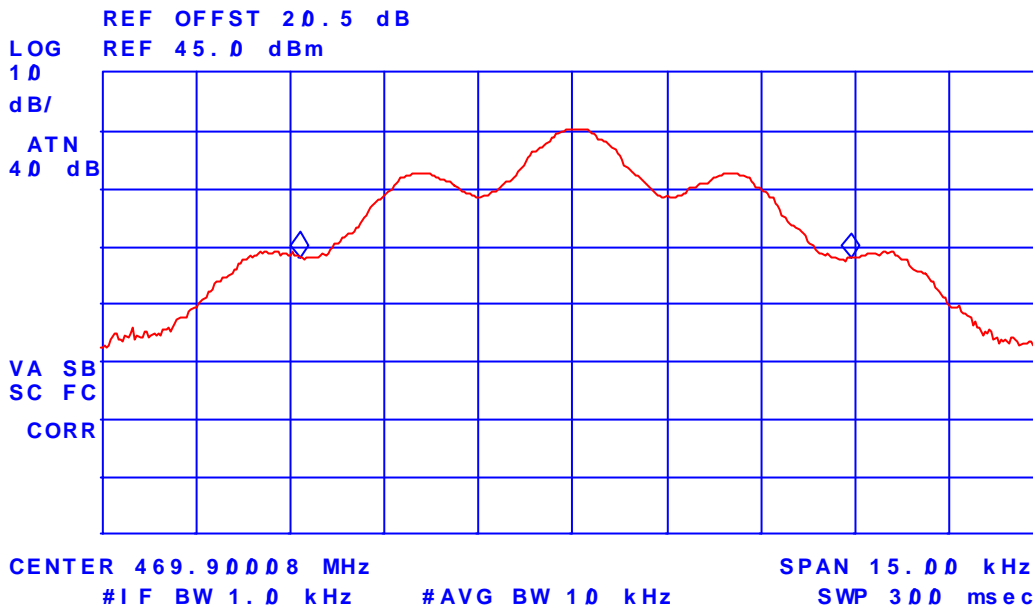

**ULTRATECH GROUP OF LABS**

3000 Bristol Circle, Oakville, Ontario, Canada L6H 6G4  
Tel. #: 905-829-1570, Fax. #: 905-829-8050, Email: [vic@ultratech-labs.com](mailto:vic@ultratech-labs.com), Website: <http://www.ultratech-labs.com>

File #: ICOM-079F90

March 10, 2004

All test results contained in this engineering test report are traceable to National Institute of Standards and Technology (NIST)

Plot # 4:  
Occupied Bandwidth  
Carrier Frequency: 400.1 MHz  
Channel Spacing: 25 kHz  
Power: 4W  
Modulation: FM with 2.5kHz sine wave

177

ACTV DET: PEAK  
MEAS DET: PEAK QP AVG  
MKR 13.95 kHz  
- .68 dB

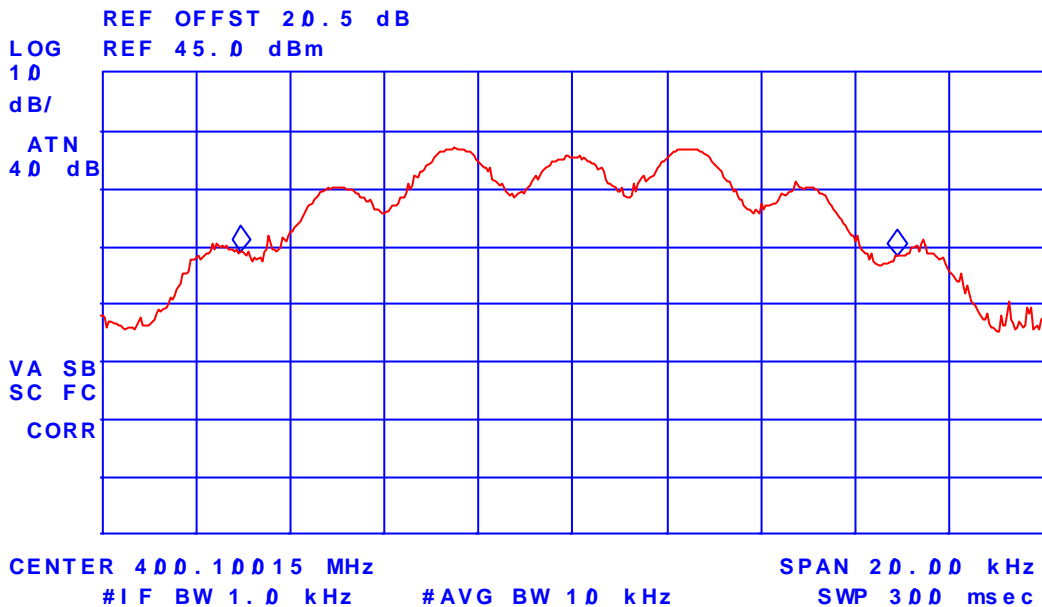

**ULTRATECH GROUP OF LABS**

3000 Bristol Circle, Oakville, Ontario, Canada L6H 6G4  
Tel. #: 905-829-1570, Fax. #: 905-829-8050, Email: [vic@ultratech-labs.com](mailto:vic@ultratech-labs.com), Website: <http://www.ultratech-labs.com>

File #: ICOM-079F90

March 10, 2004

All test results contained in this engineering test report are traceable to National Institute of Standards and Technology (NIST)

Plot # 5:  
Occupied Bandwidth  
Carrier Frequency: 435.1 MHz  
Channel Spacing: 25 kHz  
Power: 4 W  
Modulation: FM with 2.5kHz sine wave

*hp*

ACTV DET: PEAK  
MEAS DET: PEAK QP AVG  
MKR 13.50 kHz  
- .72 dB

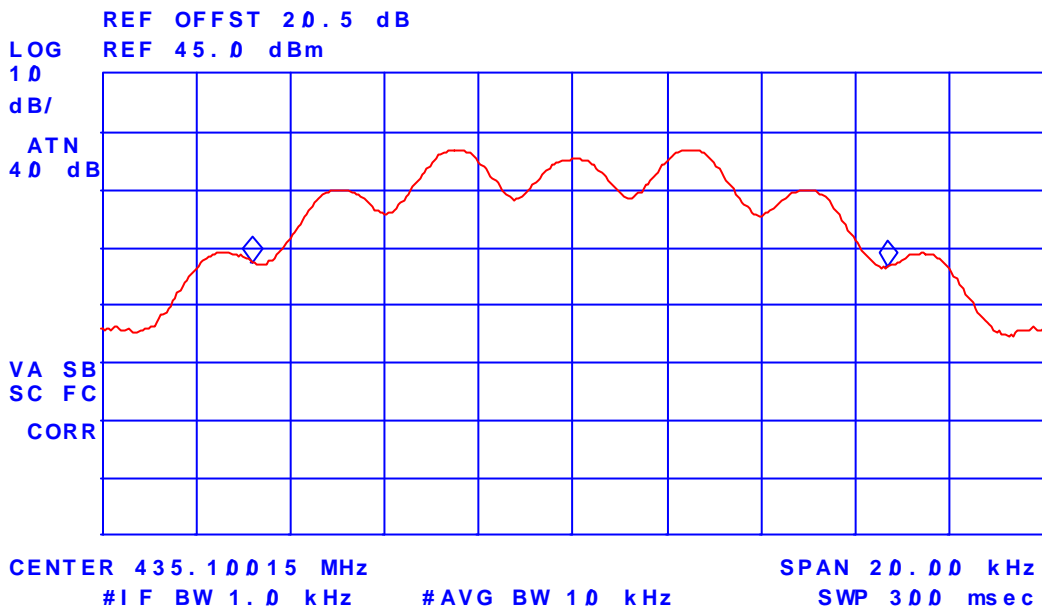

**ULTRATECH GROUP OF LABS**

3000 Bristol Circle, Oakville, Ontario, Canada L6H 6G4  
Tel. #: 905-829-1570, Fax. #: 905-829-8050, Email: [vic@ultratech-labs.com](mailto:vic@ultratech-labs.com), Website: <http://www.ultratech-labs.com>

File #: ICOM-079F90

March 10, 2004

All test results contained in this engineering test report are traceable to National Institute of Standards and Technology (NIST)

Plot # 6:  
Occupied Bandwidth  
Carrier Frequency: 469.9 MHz  
Channel Spacing: 25 kHz  
Power: 4 W  
Modulation: FM with 2.5kHz sine wave

177

ACTV DET: PEAK  
MEAS DET: PEAK QP AVG  
MKR 13.15 kHz  
- .21 dB

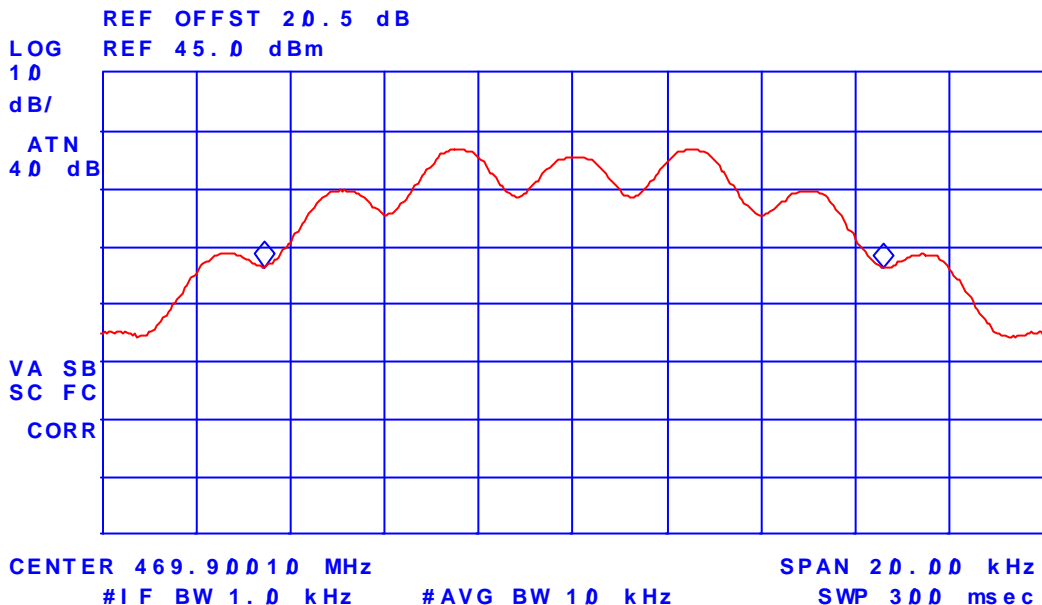

**ULTRATECH GROUP OF LABS**

3000 Bristol Circle, Oakville, Ontario, Canada L6H 6G4  
Tel. #: 905-829-1570, Fax. #: 905-829-8050, Email: [vic@ultratech-labs.com](mailto:vic@ultratech-labs.com), Website: <http://www.ultratech-labs.com>

File #: ICOM-079F90  
March 10, 2004

All test results contained in this engineering test report are traceable to National Institute of Standards and Technology (NIST)



Plot # 7:  
Occupied Bandwidth  
Carrier Frequency: 400.1 MHz  
Channel Spacing: 12.5 kHz  
Power: 4 W  
Modulation: FM with 2.5 kHz sine wave signal and scrambler

hp

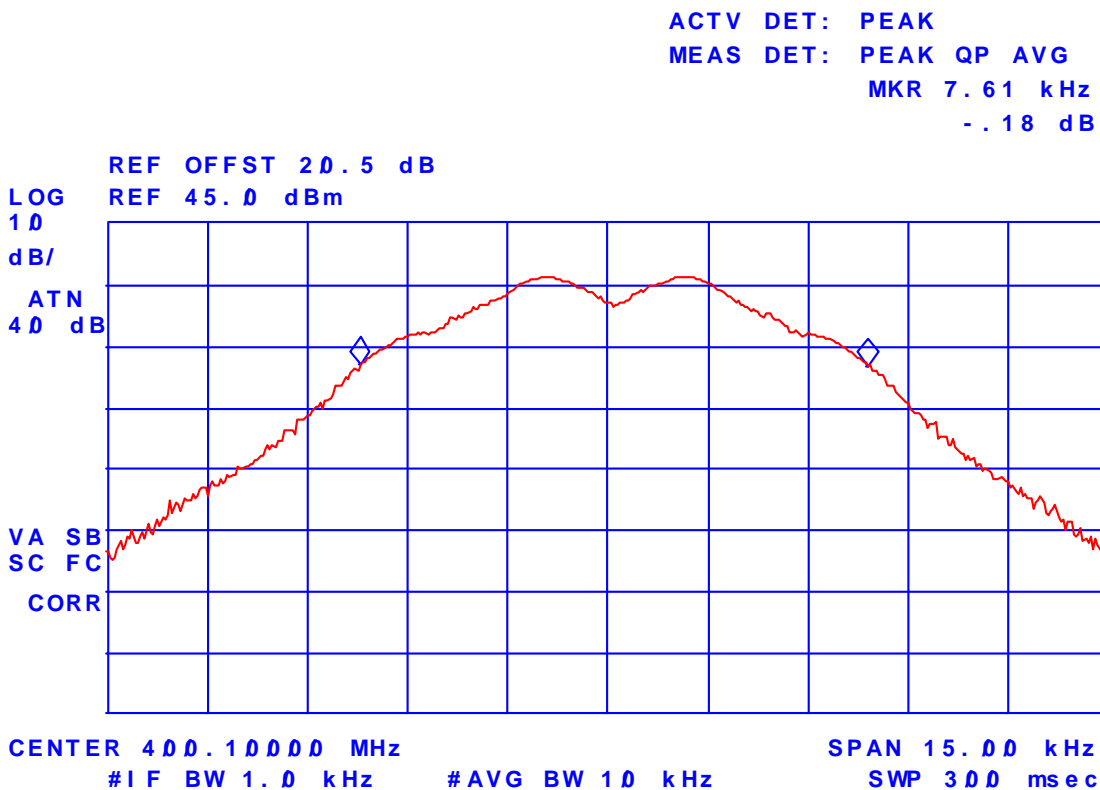

**ULTRATECH GROUP OF LABS**

3000 Bristol Circle, Oakville, Ontario, Canada L6H 6G4  
Tel. #: 905-829-1570, Fax. #: 905-829-8050, Email: [vic@ultratech-labs.com](mailto:vic@ultratech-labs.com), Website: <http://www.ultratech-labs.com>

File #: ICOM-079F90  
March 10, 2004

All test results contained in this engineering test report are traceable to National Institute of Standards and Technology (NIST)

Plot # 8:  
Occupied Bandwidth  
Carrier Frequency: 435.1 MHz  
Channel Spacing: 12.5 kHz  
Power: 4 W  
Modulation: FM with 2.5 kHz sine wave signal and scrambler

hp

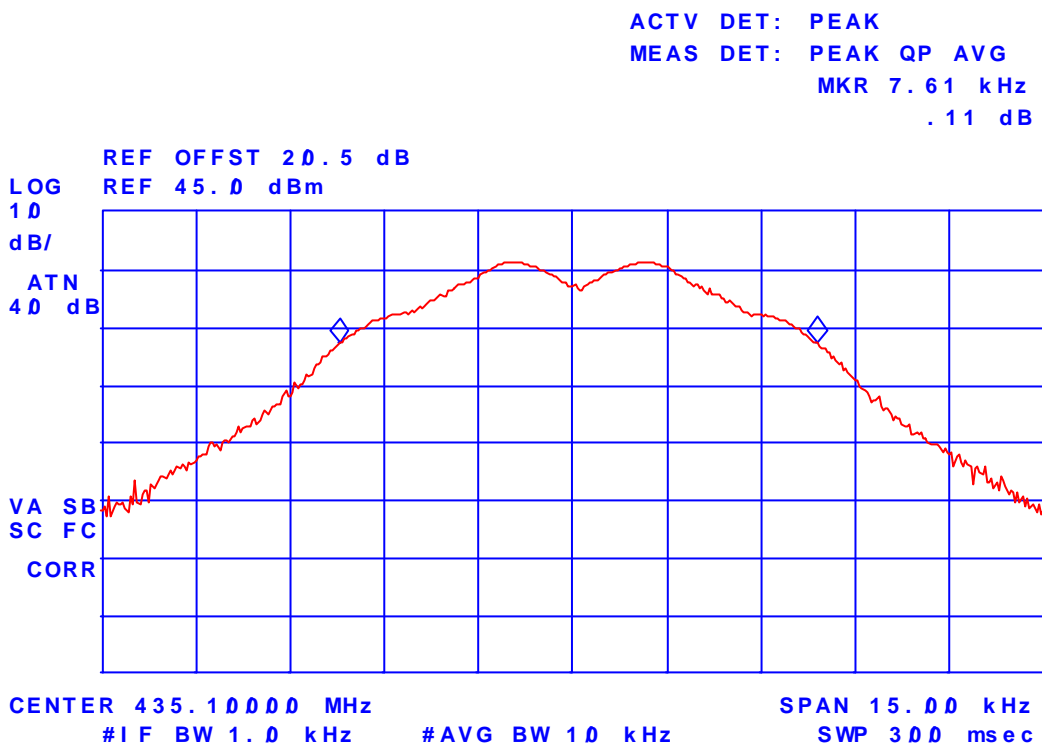

**ULTRATECH GROUP OF LABS**

3000 Bristol Circle, Oakville, Ontario, Canada L6H 6G4  
Tel. #: 905-829-1570, Fax. #: 905-829-8050, Email: [vic@ultratech-labs.com](mailto:vic@ultratech-labs.com), Website: <http://www.ultratech-labs.com>

File #: ICOM-079F90

March 10, 2004

All test results contained in this engineering test report are traceable to National Institute of Standards and Technology (NIST)

Plot # 9:  
Occupied Bandwidth  
Carrier Frequency: 469.9 MHz  
Channel Spacing: 12.5 kHz  
Power: 4 W  
Modulation: FM with 2.5 kHz sine wave signal and scrambler

hp

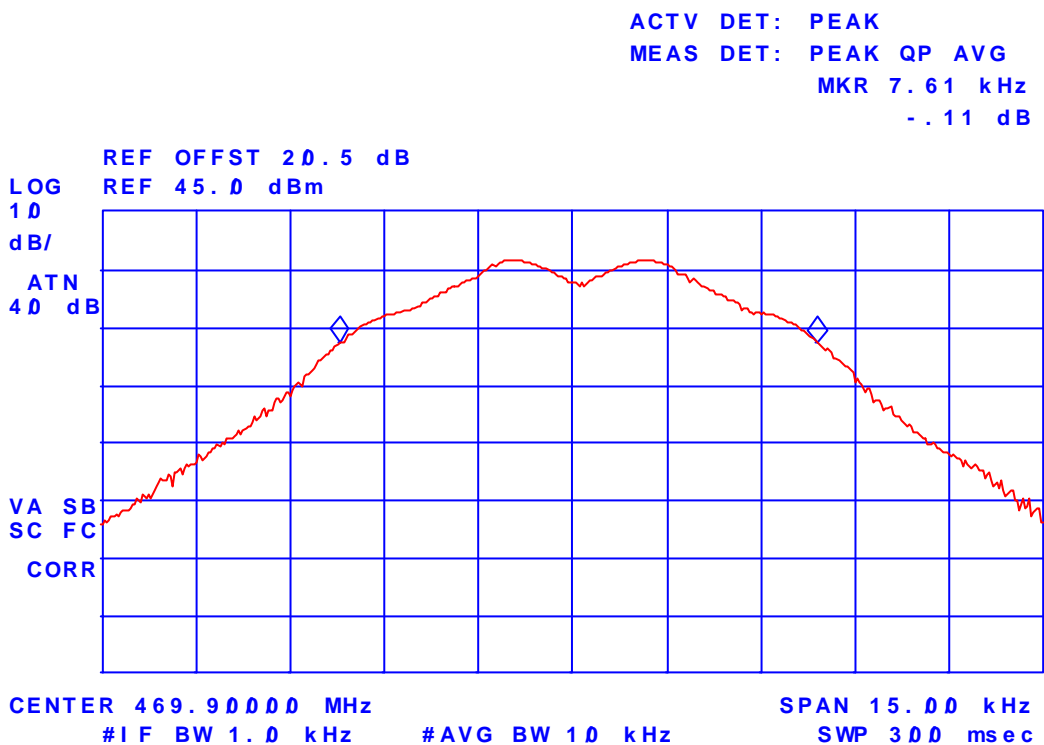

**ULTRATECH GROUP OF LABS**

3000 Bristol Circle, Oakville, Ontario, Canada L6H 6G4  
Tel. #: 905-829-1570, Fax. #: 905-829-8050, Email: [vic@ultratech-labs.com](mailto:vic@ultratech-labs.com), Website: <http://www.ultratech-labs.com>

File #: ICOM-079F90

March 10, 2004

All test results contained in this engineering test report are traceable to National Institute of Standards and Technology (NIST)

Plot # 10:  
Occupied Bandwidth  
Carrier Frequency: 400.1 MHz  
Channel Spacing: 25 kHz  
Power: 4 W  
Modulation: FM with 2.5 kHz sine wave signal and scrambler

hp

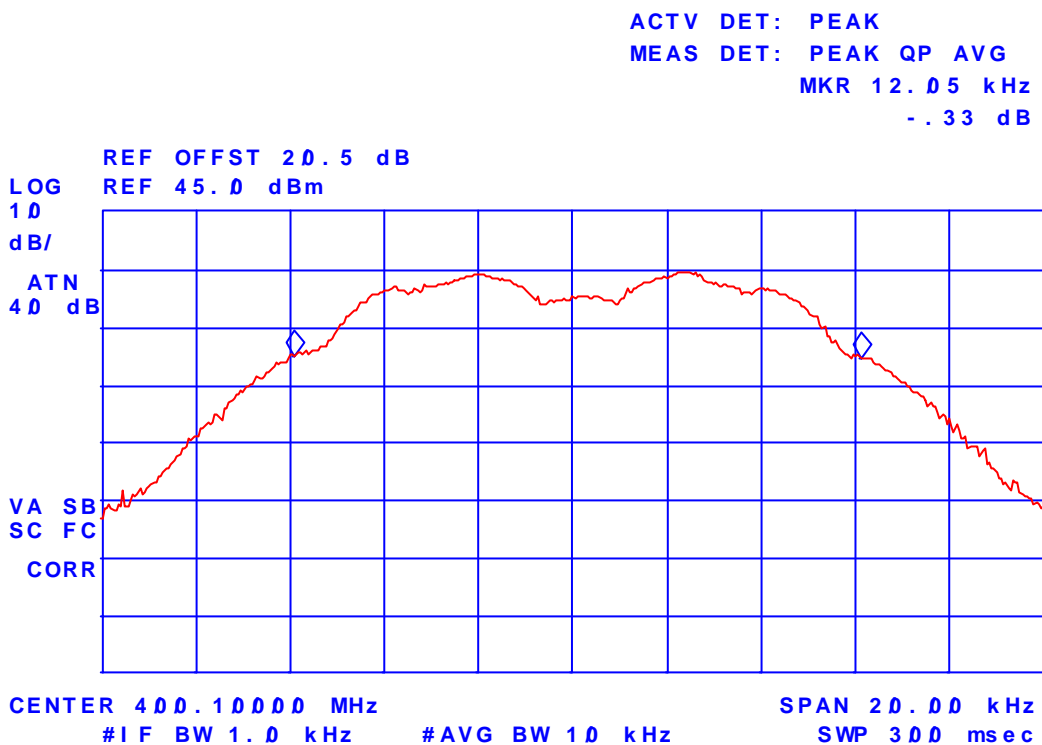

**ULTRATECH GROUP OF LABS**

3000 Bristol Circle, Oakville, Ontario, Canada L6H 6G4  
Tel. #: 905-829-1570, Fax. #: 905-829-8050, Email: [vic@ultratech-labs.com](mailto:vic@ultratech-labs.com), Website: <http://www.ultratech-labs.com>

File #: ICOM-079F90

March 10, 2004

All test results contained in this engineering test report are traceable to National Institute of Standards and Technology (NIST)

Plot # 11:  
Occupied Bandwidth  
Carrier Frequency: 435.1 MHz  
Channel Spacing: 25 kHz  
Power: 4 W  
Modulation: FM with 2.5 kHz sine wave signal and scrambler

hp

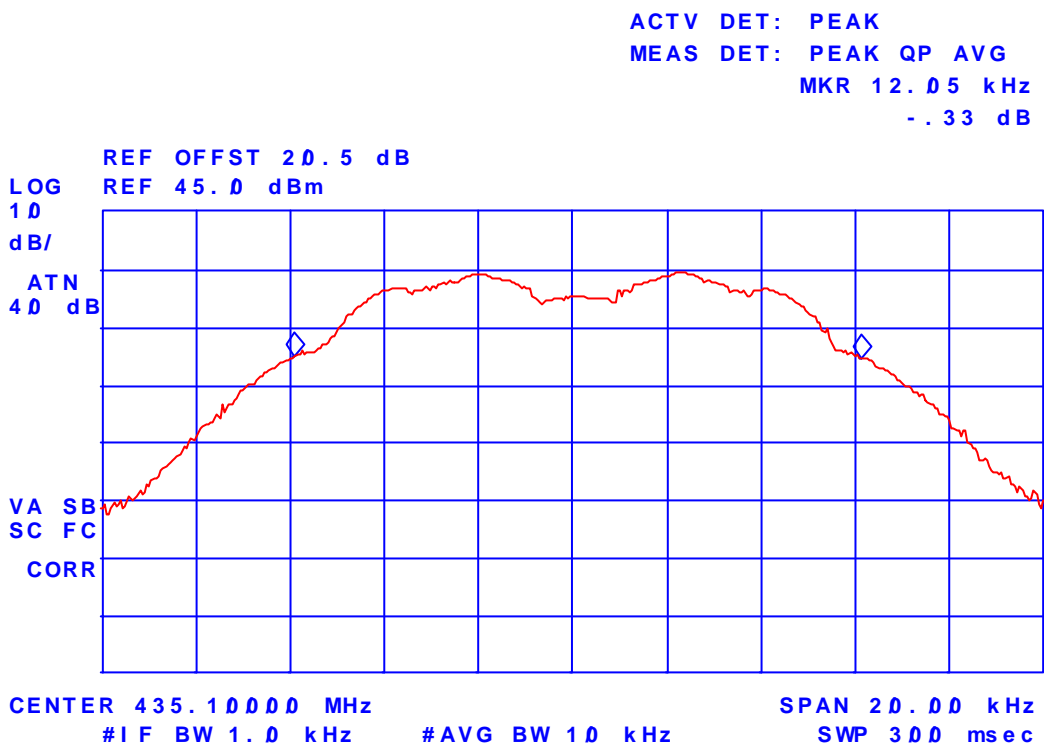

**ULTRATECH GROUP OF LABS**

3000 Bristol Circle, Oakville, Ontario, Canada L6H 6G4  
Tel. #: 905-829-1570, Fax. #: 905-829-8050, Email: [vic@ultratech-labs.com](mailto:vic@ultratech-labs.com), Website: <http://www.ultratech-labs.com>

File #: ICOM-079F90

March 10, 2004

All test results contained in this engineering test report are traceable to National Institute of Standards and Technology (NIST)

Plot # 12:  
Occupied Bandwidth  
Carrier Frequency: 469.9 MHz  
Channel Spacing: 25 kHz  
Power: 4 W  
Modulation: FM with 2.5 kHz sine wave signal and scrambler

hp

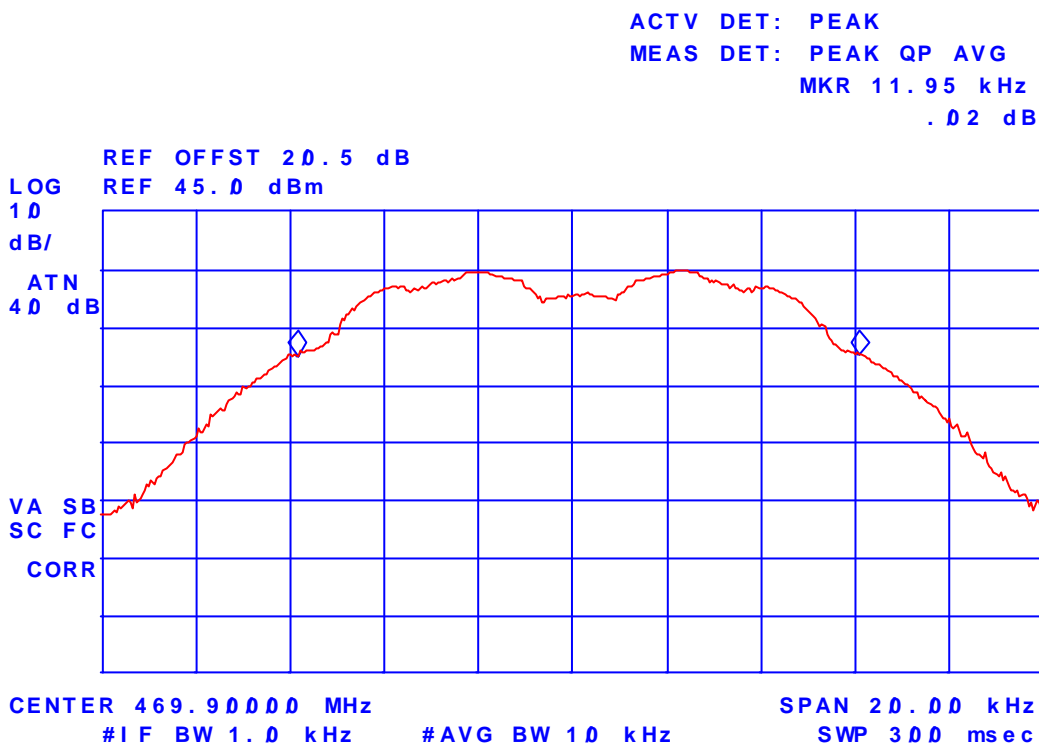

**ULTRATECH GROUP OF LABS**

3000 Bristol Circle, Oakville, Ontario, Canada L6H 6G4  
Tel. #: 905-829-1570, Fax. #: 905-829-8050, Email: [vic@ultratech-labs.com](mailto:vic@ultratech-labs.com), Website: <http://www.ultratech-labs.com>

File #: ICOM-079F90

March 10, 2004

All test results contained in this engineering test report are traceable to National Institute of Standards and Technology (NIST)

### 6.9.5.2. Emission Masks

Conform. See the following test data plots (13 through 36) for details.

Plot # 13:  
Emission Mask B  
Carrier Frequency: 400.1 MHz  
Channel Spacing: 25 kHz  
Power: 4 W  
Modulation: FM with 2.5kHz sine wave

*hp*

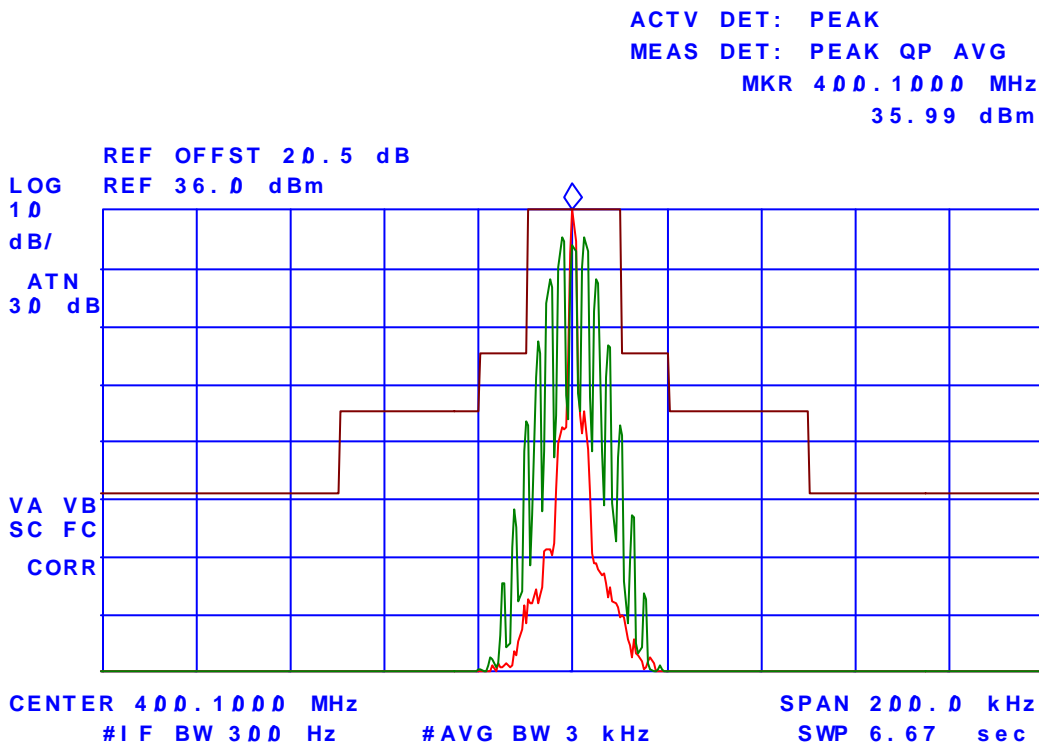

Plot # 14:  
Emission Mask B  
Carrier Frequency: 435.1 MHz  
Channel Spacing: 25 kHz  
Power: 4 W  
Modulation: FM with 2.5kHz sine wave

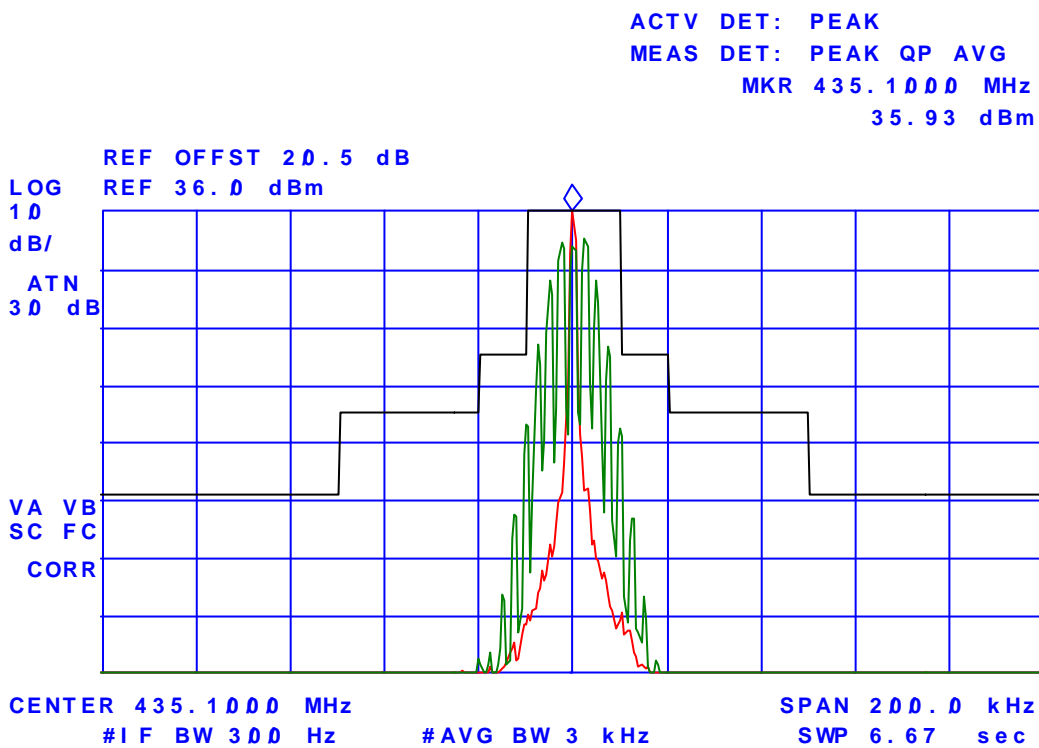

**ULTRATECH GROUP OF LABS**

3000 Bristol Circle, Oakville, Ontario, Canada L6H 6G4  
Tel. #: 905-829-1570, Fax. #: 905-829-8050, Email: [vic@ultratech-labs.com](mailto:vic@ultratech-labs.com), Website: <http://www.ultratech-labs.com>

File #: ICOM-079F90

March 10, 2004

All test results contained in this engineering test report are traceable to National Institute of Standards and Technology (NIST)



Plot # 15:  
Emission Mask B  
Carrier Frequency: 469.9 MHz  
Channel Spacing: 25 kHz  
Power: 4 W  
Modulation: FM with 2.5kHz sine wave

*hp*

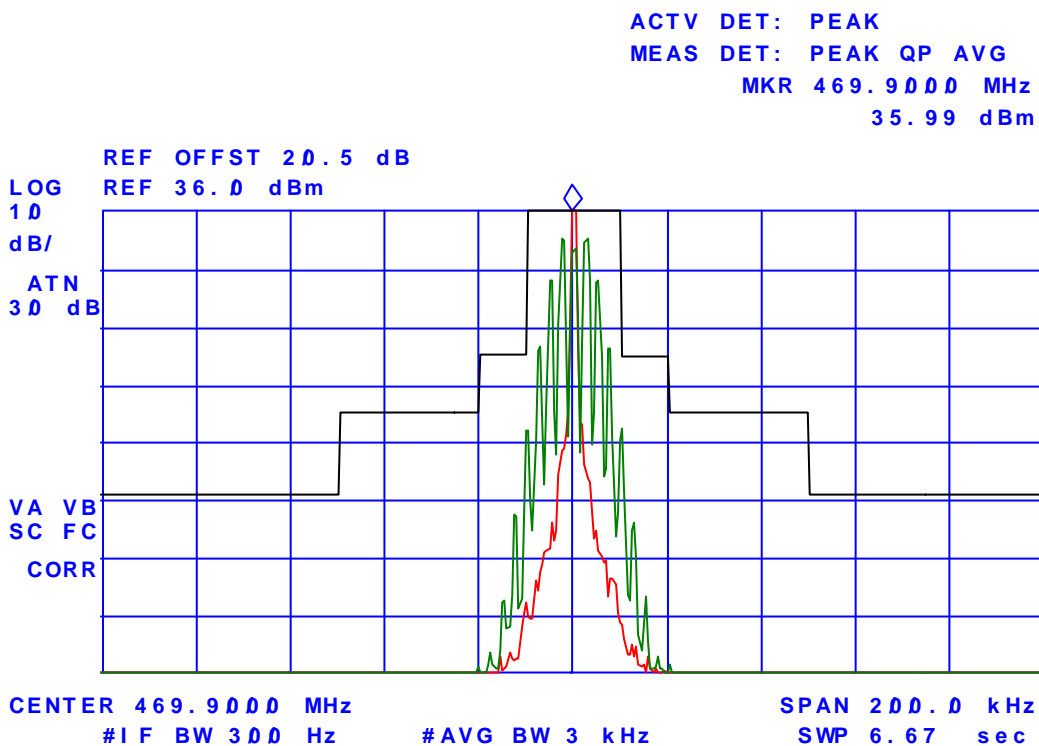

**ULTRATECH GROUP OF LABS**

3000 Bristol Circle, Oakville, Ontario, Canada L6H 6G4  
Tel. #: 905-829-1570, Fax. #: 905-829-8050, Email: [vic@ultratech-labs.com](mailto:vic@ultratech-labs.com), Website: <http://www.ultratech-labs.com>

File #: ICOM-079F90

March 10, 2004

All test results contained in this engineering test report are traceable to National Institute of Standards and Technology (NIST)

Plot # 16:  
Emission Mask B  
Carrier Frequency: 400.1 MHz  
Channel Spacing: 25 kHz  
Power: 1 W  
Modulation: FM with 2.5kHz sine wave

*hp*

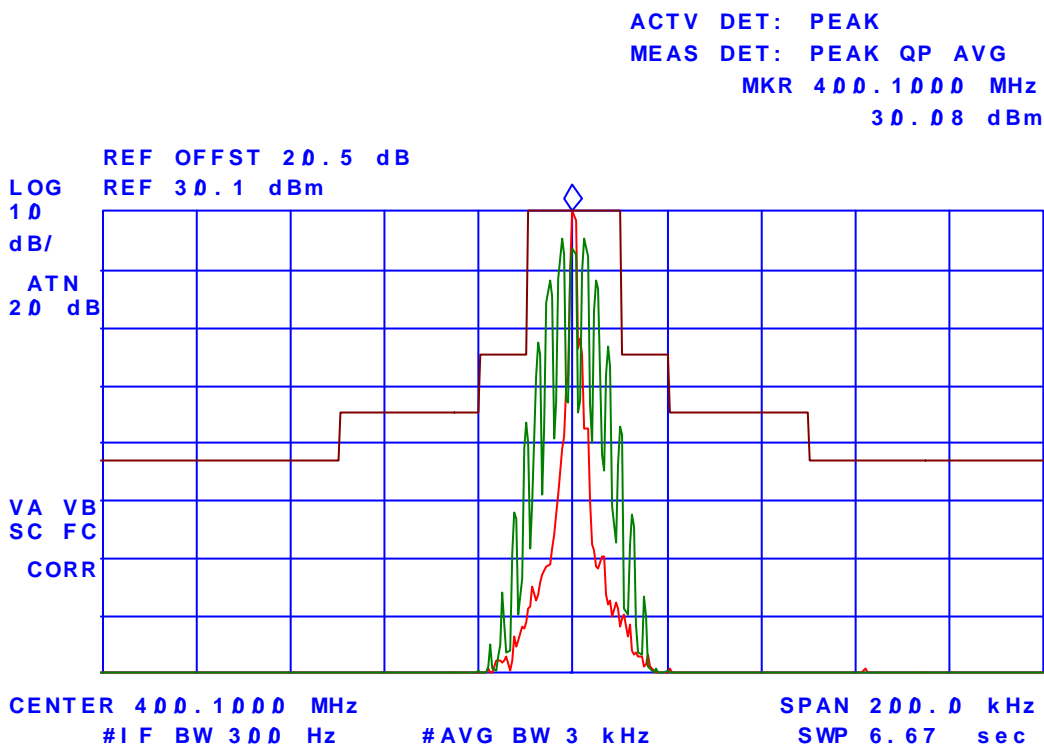

**ULTRATECH GROUP OF LABS**

3000 Bristol Circle, Oakville, Ontario, Canada L6H 6G4  
Tel. #: 905-829-1570, Fax. #: 905-829-8050, Email: [vic@ultratech-labs.com](mailto:vic@ultratech-labs.com), Website: <http://www.ultratech-labs.com>

File #: ICOM-079F90

March 10, 2004

All test results contained in this engineering test report are traceable to National Institute of Standards and Technology (NIST)

Plot # 17:  
Emission Mask B  
Carrier Frequency: 435.1 MHz  
Channel Spacing: 25 kHz  
Power: 1W  
Modulation: FM with 2.5kHz sine wave

*hp*

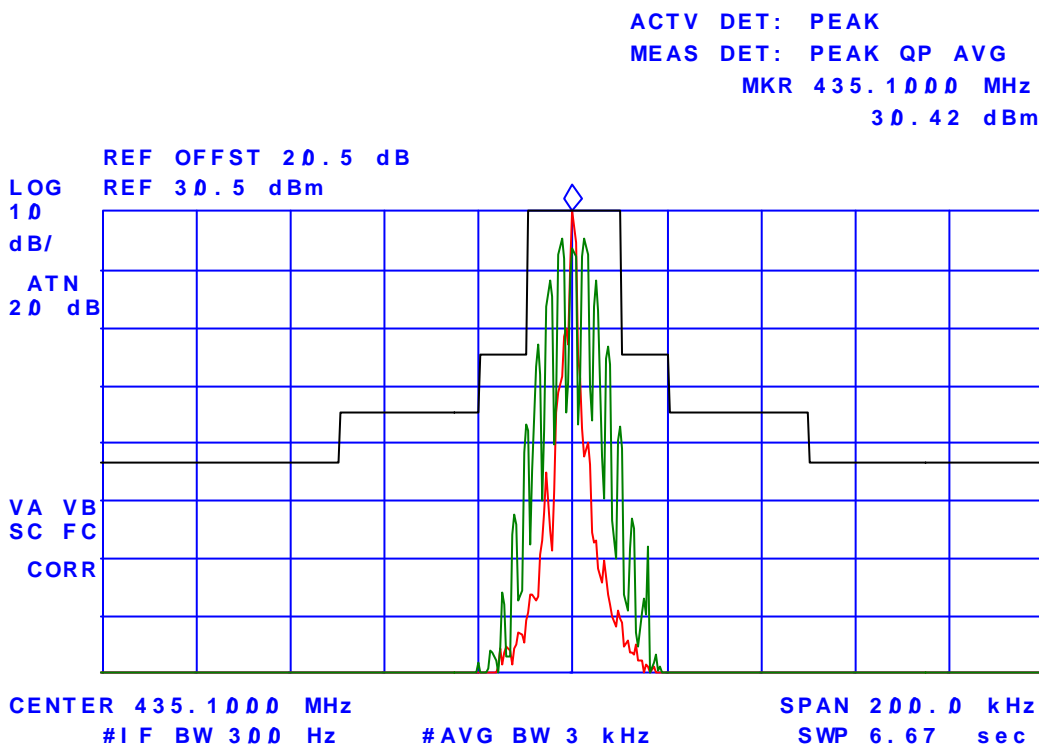

**ULTRATECH GROUP OF LABS**

3000 Bristol Circle, Oakville, Ontario, Canada L6H 6G4  
Tel. #: 905-829-1570, Fax. #: 905-829-8050, Email: [vic@ultratech-labs.com](mailto:vic@ultratech-labs.com), Website: <http://www.ultratech-labs.com>

File #: ICOM-079F90

March 10, 2004

All test results contained in this engineering test report are traceable to National Institute of Standards and Technology (NIST)

Plot # 18:  
Emission Mask B  
Carrier Frequency: 469.9 MHz  
Channel Spacing: 25 kHz  
Power: 1W  
Modulation: FM with 2.5kHz sine wave

*hp*

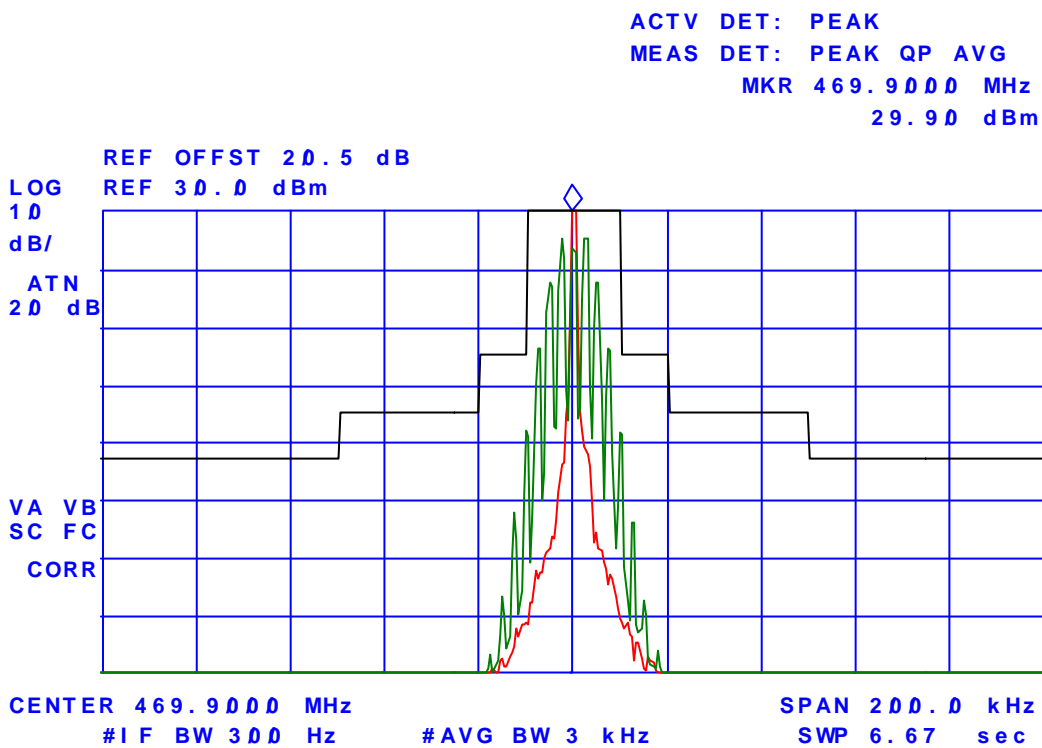

**ULTRATECH GROUP OF LABS**

3000 Bristol Circle, Oakville, Ontario, Canada L6H 6G4  
Tel. #: 905-829-1570, Fax. #: 905-829-8050, Email: [vic@ultratech-labs.com](mailto:vic@ultratech-labs.com), Website: <http://www.ultratech-labs.com>

File #: ICOM-079F90

March 10, 2004

All test results contained in this engineering test report are traceable to National Institute of Standards and Technology (NIST)

Plot # 19:  
Emission Mask B  
Carrier Frequency: 400.1 MHz  
Channel Spacing: 25 kHz  
Power: 4 W  
Modulation: FM with 2.5kHz sine wave and scrambler

hp

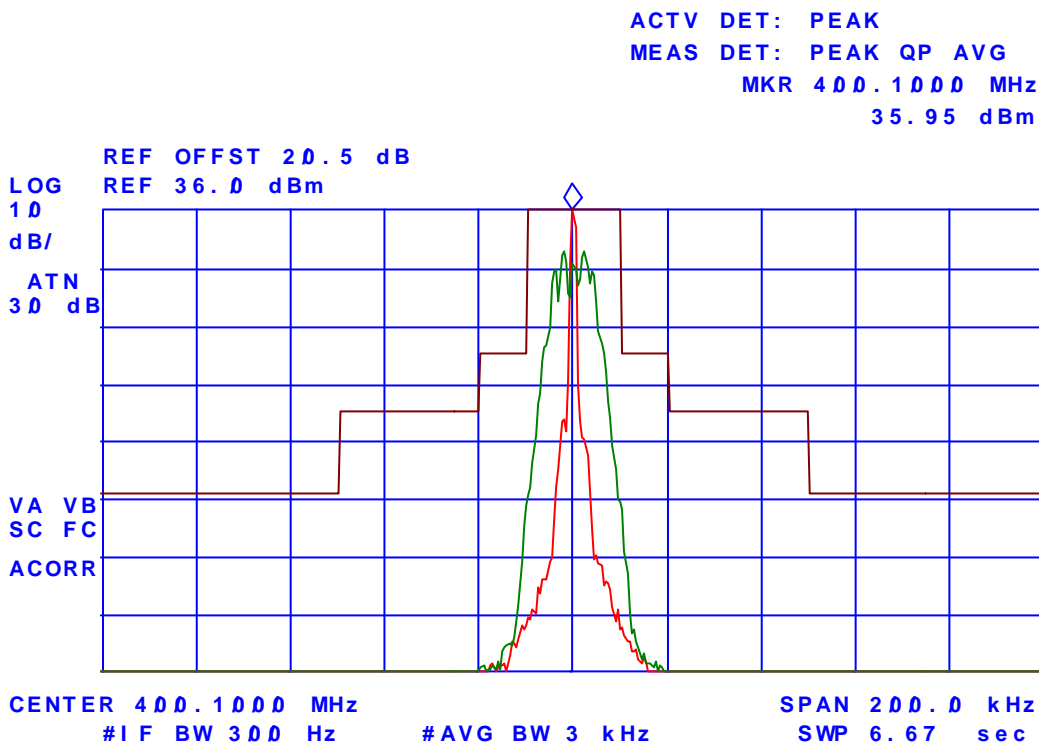

**ULTRATECH GROUP OF LABS**

3000 Bristol Circle, Oakville, Ontario, Canada L6H 6G4  
Tel. #: 905-829-1570, Fax. #: 905-829-8050, Email: [vic@ultratech-labs.com](mailto:vic@ultratech-labs.com), Website: <http://www.ultratech-labs.com>

File #: ICOM-079F90

March 10, 2004

All test results contained in this engineering test report are traceable to National Institute of Standards and Technology (NIST)

Plot # 20:  
Emission Mask B  
Carrier Frequency: 435.1 MHz  
Channel Spacing: 25 kHz  
Power: 4W  
Modulation: FM with 2.5kHz sine wave and scrambler

hp

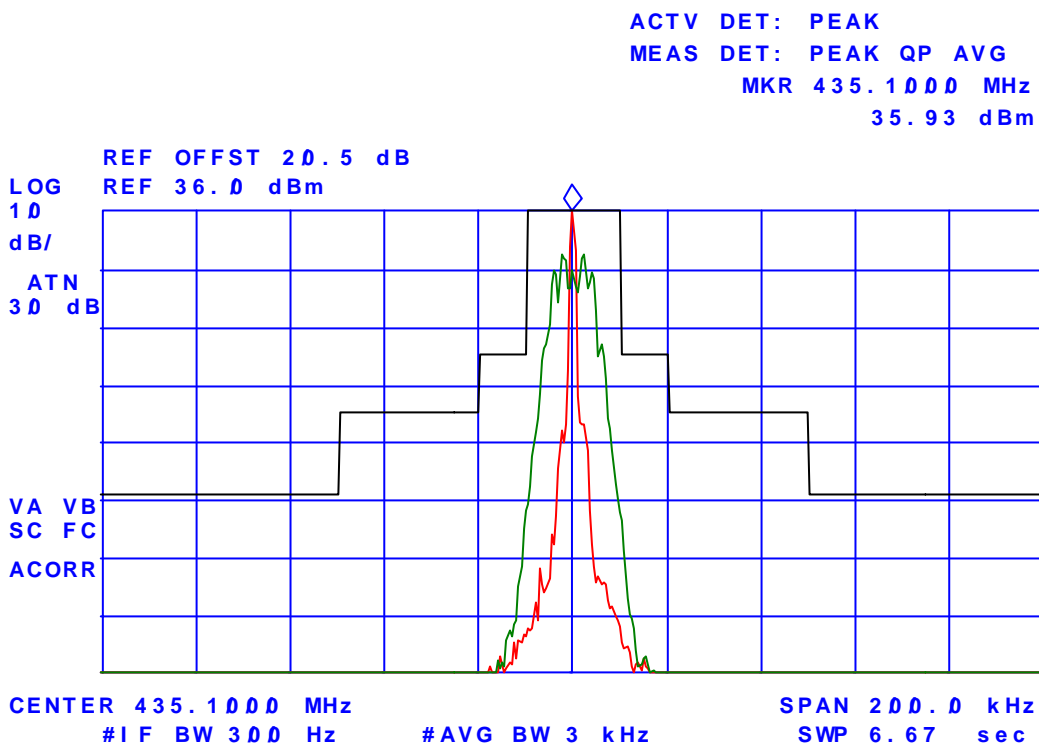

**ULTRATECH GROUP OF LABS**

3000 Bristol Circle, Oakville, Ontario, Canada L6H 6G4  
Tel. #: 905-829-1570, Fax. #: 905-829-8050, Email: [vic@ultratech-labs.com](mailto:vic@ultratech-labs.com), Website: <http://www.ultratech-labs.com>

File #: ICOM-079F90

March 10, 2004

All test results contained in this engineering test report are traceable to National Institute of Standards and Technology (NIST)

Plot # 21:  
Emission Mask B  
Carrier Frequency: 469.9 MHz  
Channel Spacing: 25 kHz  
Power: 4W  
Modulation: FM with 2.5kHz sine wave and scrambler

hp

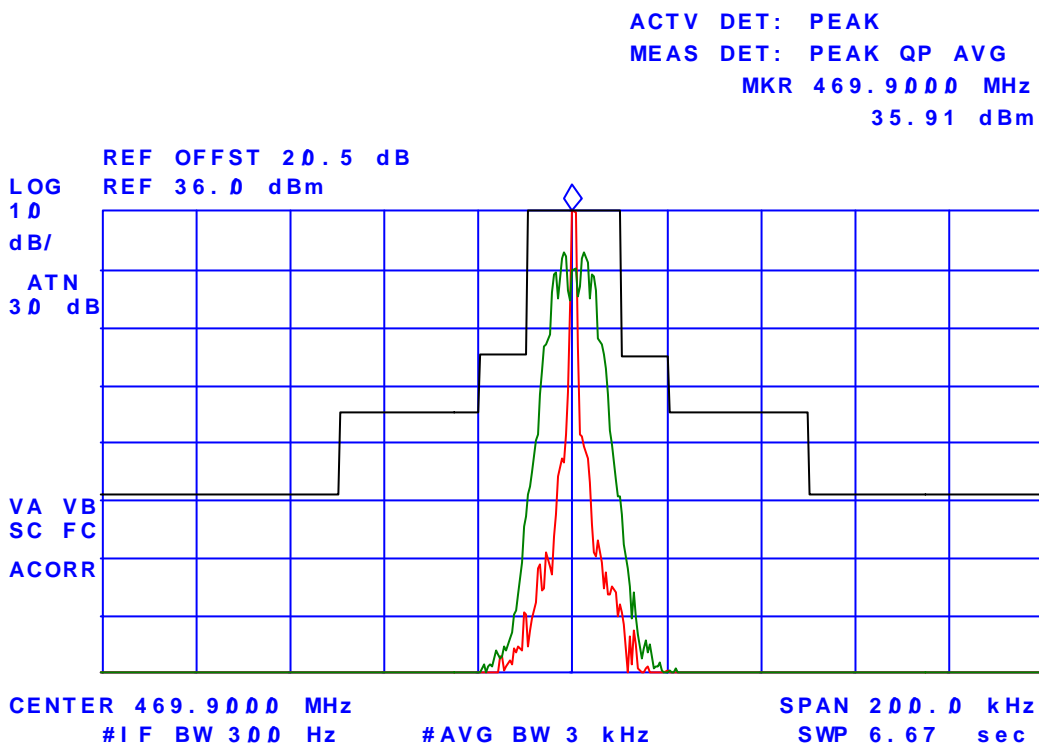

**ULTRATECH GROUP OF LABS**

3000 Bristol Circle, Oakville, Ontario, Canada L6H 6G4  
Tel. #: 905-829-1570, Fax. #: 905-829-8050, Email: [vic@ultratech-labs.com](mailto:vic@ultratech-labs.com), Website: <http://www.ultratech-labs.com>

File #: ICOM-079F90

March 10, 2004

All test results contained in this engineering test report are traceable to National Institute of Standards and Technology (NIST)

Plot # 22:  
Emission Mask B  
Carrier Frequency: 400.1 MHz  
Channel Spacing: 25 kHz  
Power: 1W  
Modulation: FM with 2.5kHz sine wave and scrambler

hp

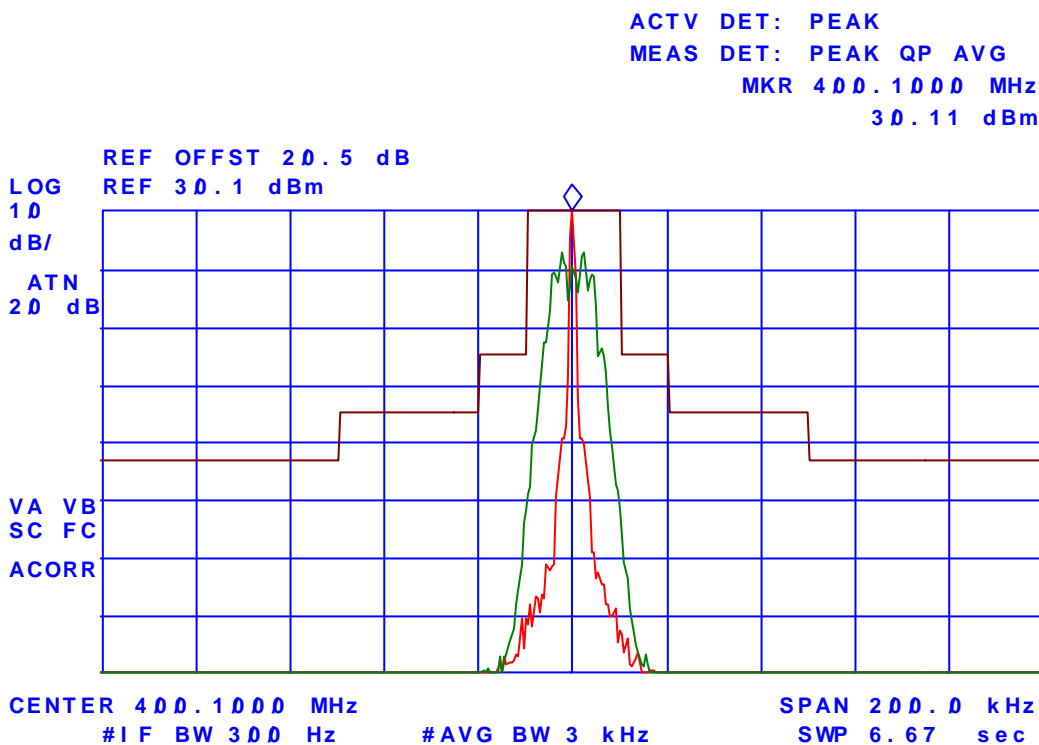

**ULTRATECH GROUP OF LABS**

3000 Bristol Circle, Oakville, Ontario, Canada L6H 6G4  
Tel. #: 905-829-1570, Fax. #: 905-829-8050, Email: [vic@ultratech-labs.com](mailto:vic@ultratech-labs.com), Website: <http://www.ultratech-labs.com>

File #: ICOM-079F90

March 10, 2004

All test results contained in this engineering test report are traceable to National Institute of Standards and Technology (NIST)



Plot # 23:  
Emission Mask B  
Carrier Frequency: 435.1 MHz  
Channel Spacing: 25 kHz  
Power: 1W  
Modulation: FM with 2.5kHz sine wave and scrambler

hp

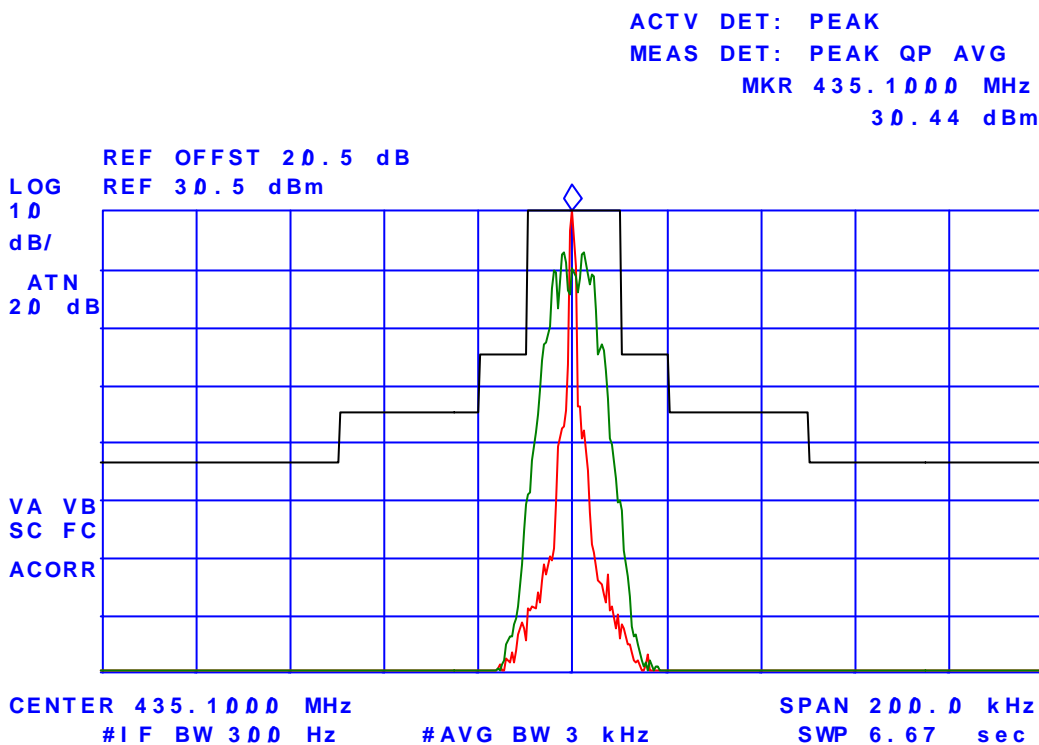

**ULTRATECH GROUP OF LABS**

3000 Bristol Circle, Oakville, Ontario, Canada L6H 6G4  
Tel. #: 905-829-1570, Fax. #: 905-829-8050, Email: [vic@ultratech-labs.com](mailto:vic@ultratech-labs.com), Website: <http://www.ultratech-labs.com>

File #: ICOM-079F90

March 10, 2004

All test results contained in this engineering test report are traceable to National Institute of Standards and Technology (NIST)

Plot # 24:  
Emission Mask B  
Carrier Frequency: 469.9 MHz  
Channel Spacing: 25 kHz  
Power: 1W  
Modulation: FM with 2.5kHz sine wave and scrambler

hp

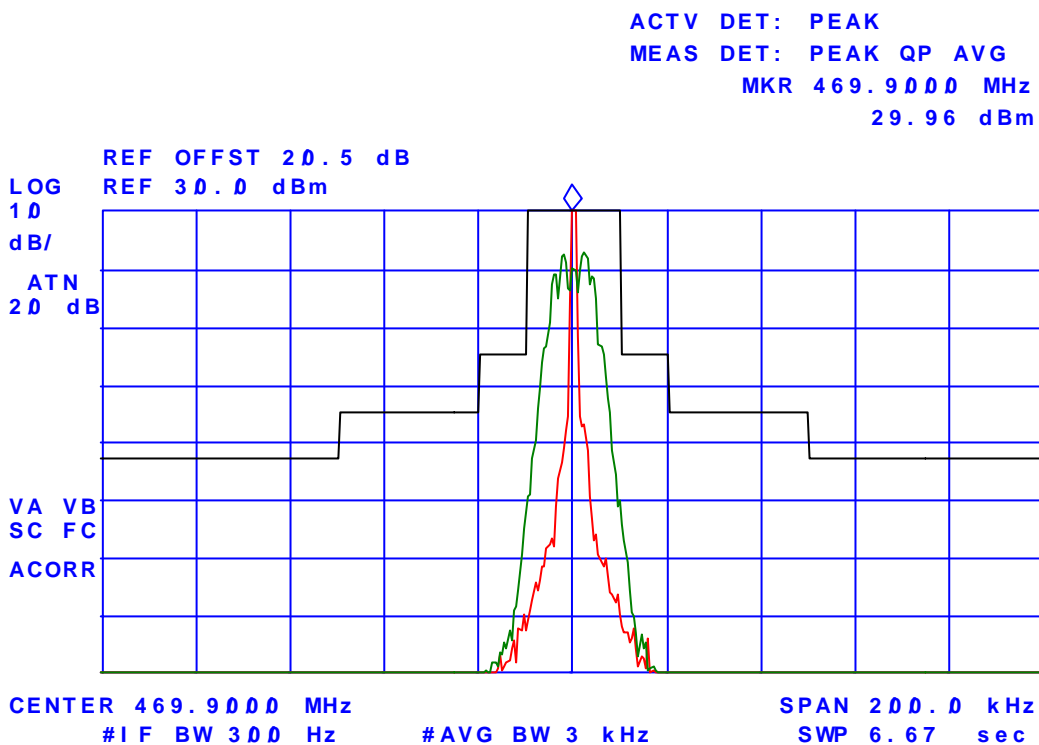

**ULTRATECH GROUP OF LABS**

3000 Bristol Circle, Oakville, Ontario, Canada L6H 6G4  
Tel. #: 905-829-1570, Fax. #: 905-829-8050, Email: [vic@ultratech-labs.com](mailto:vic@ultratech-labs.com), Website: <http://www.ultratech-labs.com>

File #: ICOM-079F90

March 10, 2004

All test results contained in this engineering test report are traceable to National Institute of Standards and Technology (NIST)

Plot # 25:  
Emission Mask D  
Carrier Frequency: 400.1 MHz  
Channel Spacing: 12.5 kHz  
Power: 4 W  
Modulation: FM with 2.5kHz sine wave

*hp*

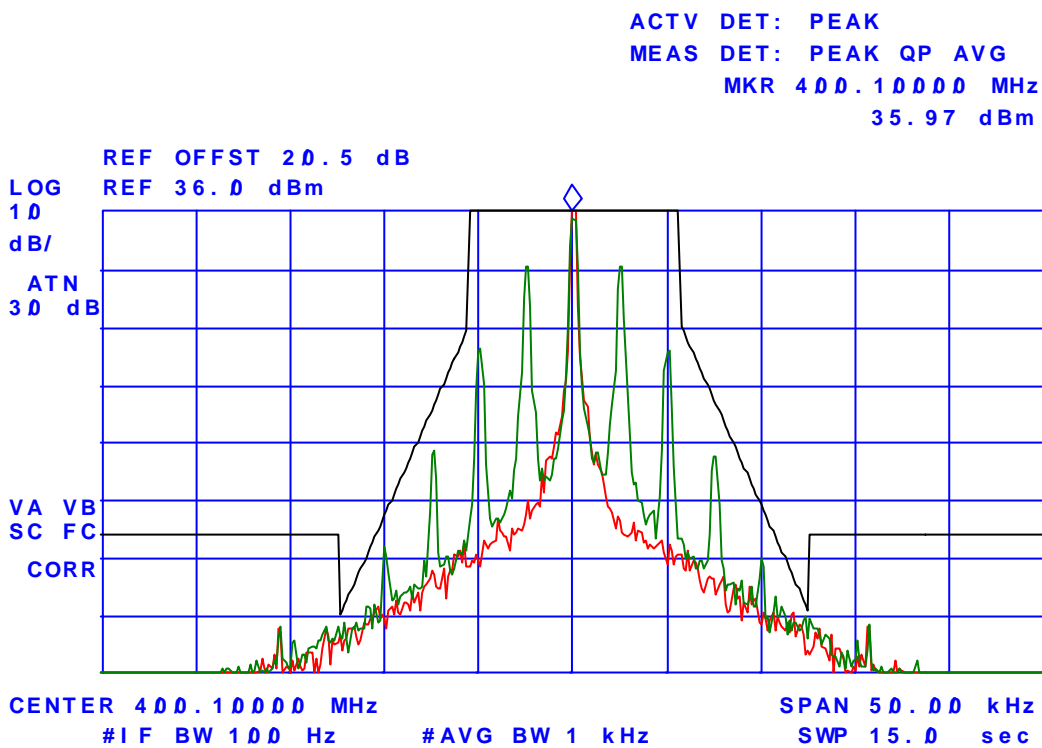

**ULTRATECH GROUP OF LABS**

3000 Bristol Circle, Oakville, Ontario, Canada L6H 6G4  
Tel. #: 905-829-1570, Fax. #: 905-829-8050, Email: [vic@ultratech-labs.com](mailto:vic@ultratech-labs.com), Website: <http://www.ultratech-labs.com>

File #: ICOM-079F90

March 10, 2004

All test results contained in this engineering test report are traceable to National Institute of Standards and Technology (NIST)

Plot # 26:  
Emission Mask D  
Carrier Frequency: 435.1 MHz  
Channel Spacing: 12.5 kHz  
Power: 4 W  
Modulation: FM with 2.5kHz sine wave

*hp*

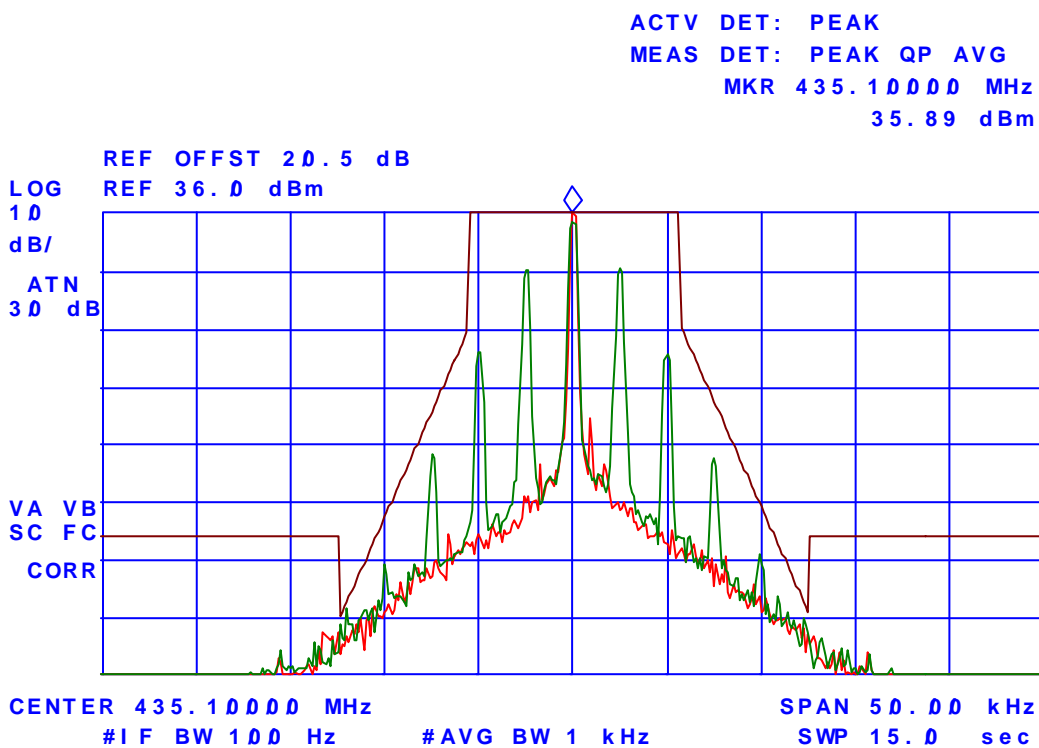

**ULTRATECH GROUP OF LABS**

3000 Bristol Circle, Oakville, Ontario, Canada L6H 6G4  
Tel. #: 905-829-1570, Fax. #: 905-829-8050, Email: [vic@ultratech-labs.com](mailto:vic@ultratech-labs.com), Website: <http://www.ultratech-labs.com>

File #: ICOM-079F90

March 10, 2004

All test results contained in this engineering test report are traceable to National Institute of Standards and Technology (NIST)

Plot # 27:  
Emission Mask D  
Carrier Frequency: 469.9 MHz  
Channel Spacing: 12.5 kHz  
Power: 4 W  
Modulation: FM with 2.5kHz sine wave

h

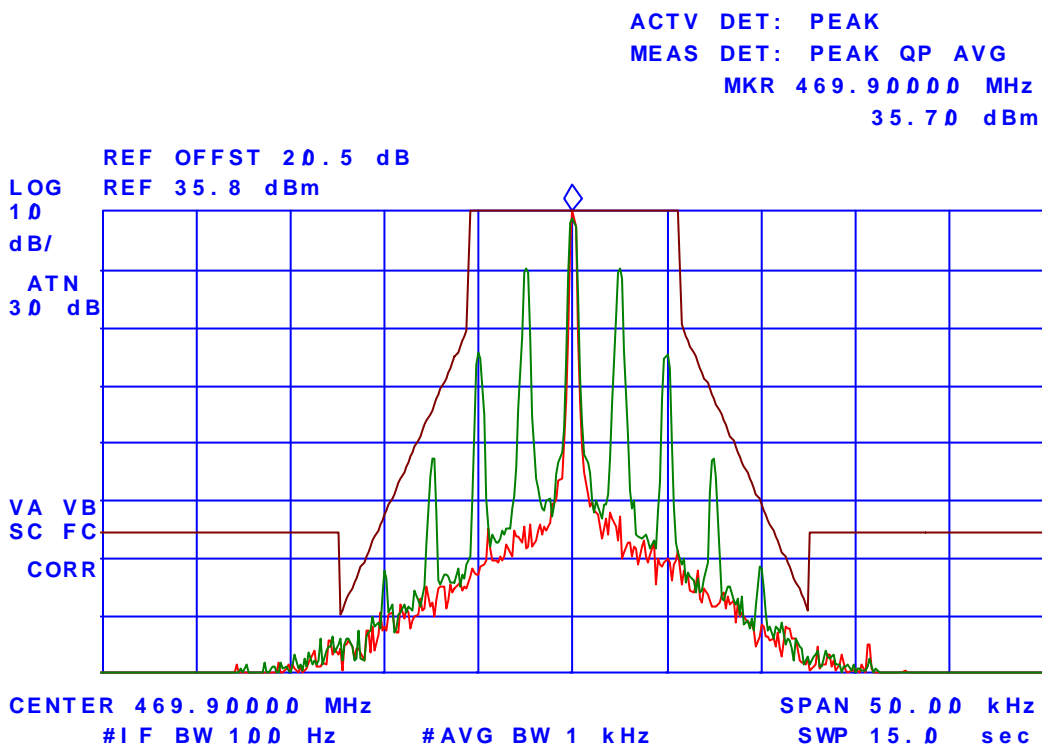

**ULTRATECH GROUP OF LABS**

3000 Bristol Circle, Oakville, Ontario, Canada L6H 6G4  
Tel. #: 905-829-1570, Fax. #: 905-829-8050, Email: [vic@ultratech-labs.com](mailto:vic@ultratech-labs.com), Website: <http://www.ultratech-labs.com>

File #: ICOM-079F90

March 10, 2004

All test results contained in this engineering test report are traceable to National Institute of Standards and Technology (NIST)

Plot # 28:  
Emission Mask D  
Carrier Frequency: 400.1 MHz  
Channel Spacing: 12.5 kHz  
Power: 1 W  
Modulation: FM with 2.5kHz sine wave

h

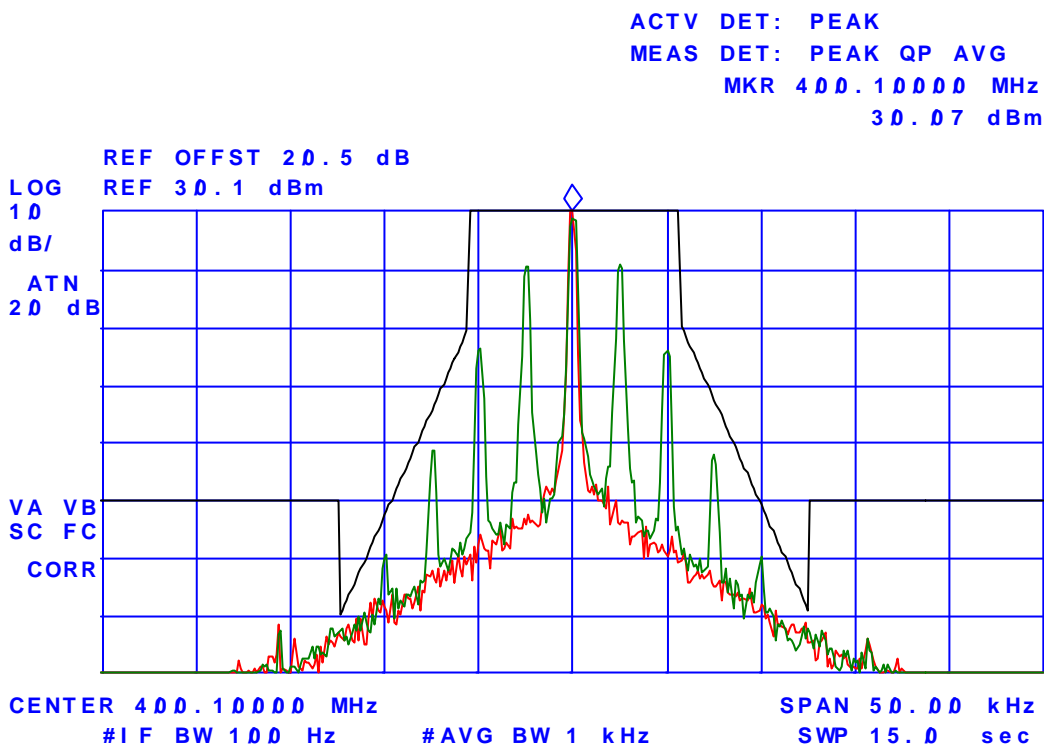

**ULTRATECH GROUP OF LABS**

3000 Bristol Circle, Oakville, Ontario, Canada L6H 6G4  
Tel. #: 905-829-1570, Fax. #: 905-829-8050, Email: [vic@ultratech-labs.com](mailto:vic@ultratech-labs.com), Website: <http://www.ultratech-labs.com>

File #: ICOM-079F90

March 10, 2004

All test results contained in this engineering test report are traceable to National Institute of Standards and Technology (NIST)

Plot # 29:  
Emission Mask D  
Carrier Frequency: 435.1 MHz  
Channel Spacing: 12.5 kHz  
Power: 1 W  
Modulation: FM with 2.5kHz sine wave

*hp*

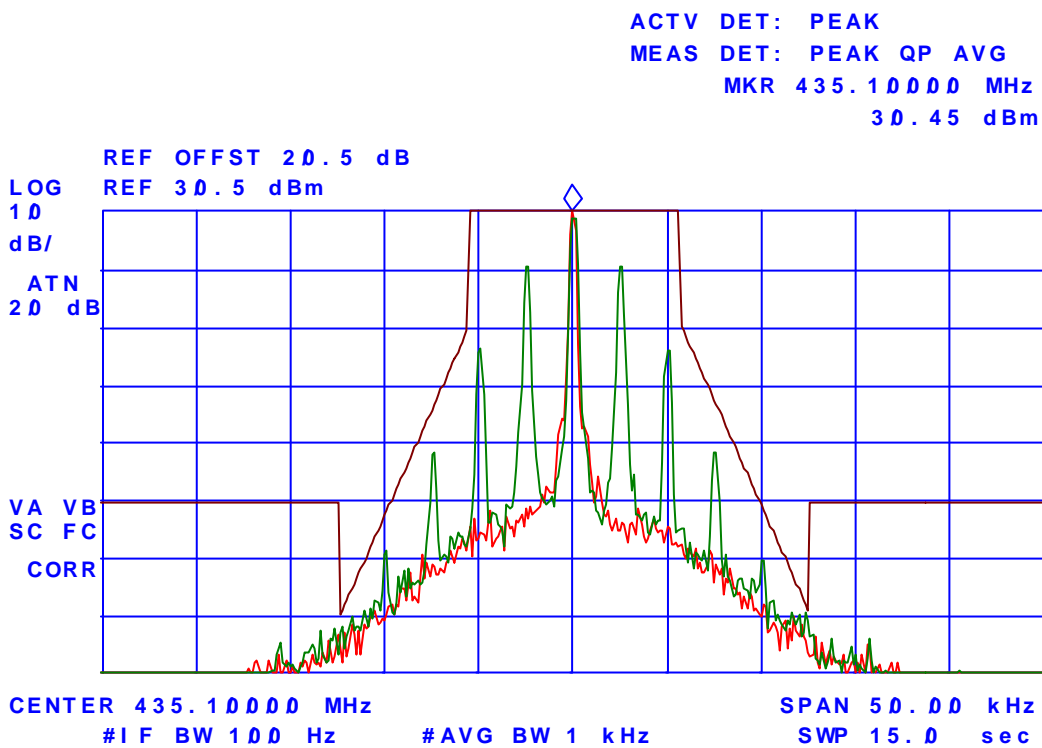

**ULTRATECH GROUP OF LABS**

3000 Bristol Circle, Oakville, Ontario, Canada L6H 6G4  
Tel. #: 905-829-1570, Fax. #: 905-829-8050, Email: [vic@ultratech-labs.com](mailto:vic@ultratech-labs.com), Website: <http://www.ultratech-labs.com>

File #: ICOM-079F90

March 10, 2004

All test results contained in this engineering test report are traceable to National Institute of Standards and Technology (NIST)

Plot # 30:  
Emission Mask D  
Carrier Frequency: 469.9 MHz  
Channel Spacing: 12.5 kHz  
Power: 1 W  
Modulation: FM with 2.5kHz sine wave

*hp*

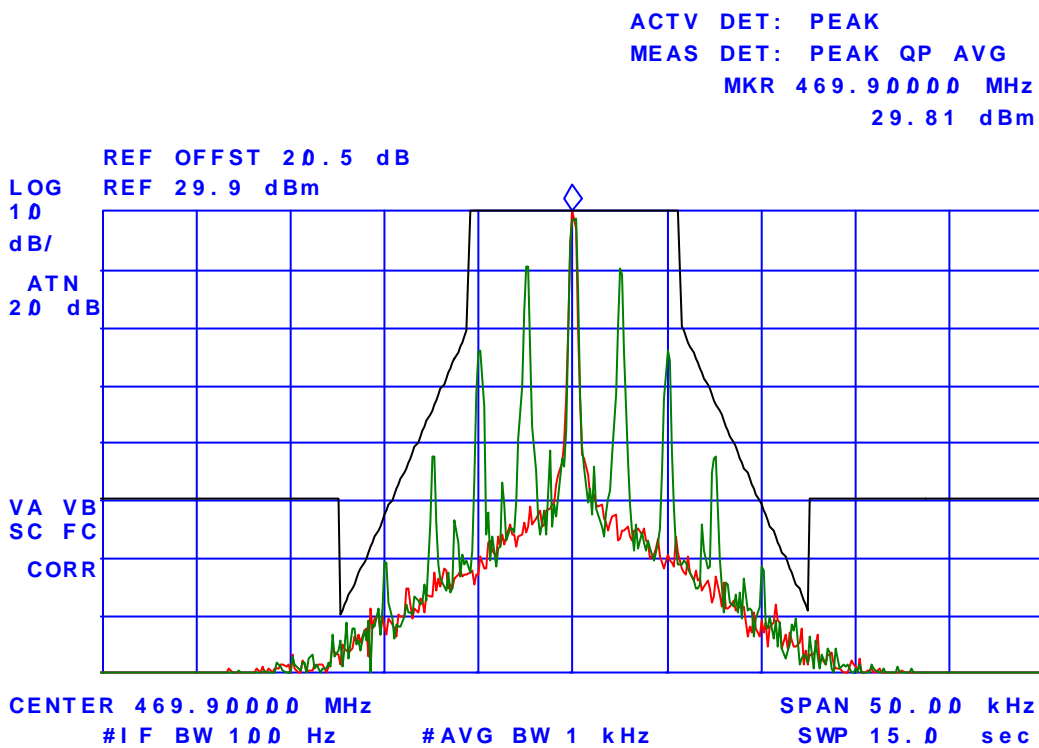

**ULTRATECH GROUP OF LABS**

3000 Bristol Circle, Oakville, Ontario, Canada L6H 6G4  
Tel. #: 905-829-1570, Fax. #: 905-829-8050, Email: [vic@ultratech-labs.com](mailto:vic@ultratech-labs.com), Website: <http://www.ultratech-labs.com>

File #: ICOM-079F90

March 10, 2004

All test results contained in this engineering test report are traceable to National Institute of Standards and Technology (NIST)



Plot # 31:  
Emission Mask D  
Carrier Frequency: 400.1 MHz  
Channel Spacing: 12.5 kHz  
Power: 4W  
Modulation: FM with 2.5kHz sine wave and scrambler

hp

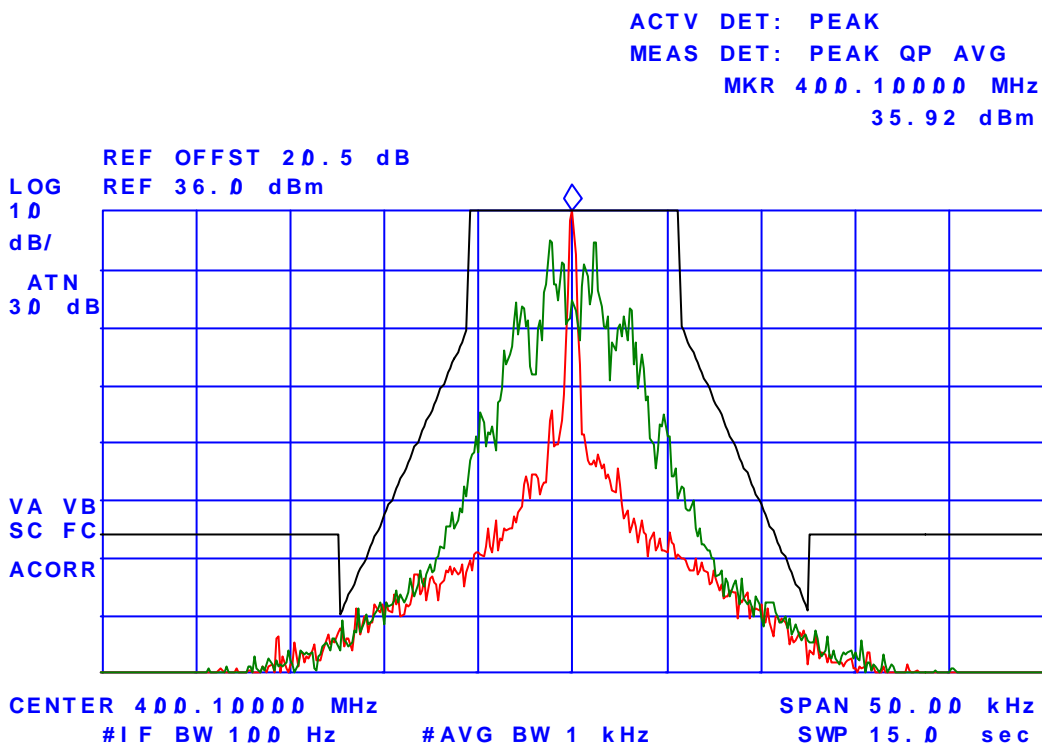

**ULTRATECH GROUP OF LABS**

3000 Bristol Circle, Oakville, Ontario, Canada L6H 6G4  
Tel. #: 905-829-1570, Fax. #: 905-829-8050, Email: [vic@ultratech-labs.com](mailto:vic@ultratech-labs.com), Website: <http://www.ultratech-labs.com>

File #: ICOM-079F90

March 10, 2004

All test results contained in this engineering test report are traceable to National Institute of Standards and Technology (NIST)

Plot # 32:  
Emission Mask D  
Carrier Frequency: 435.1 MHz  
Channel Spacing: 12.5 kHz  
Power: 4W  
Modulation: FM with 2.5kHz sine wave and scrambler

hp

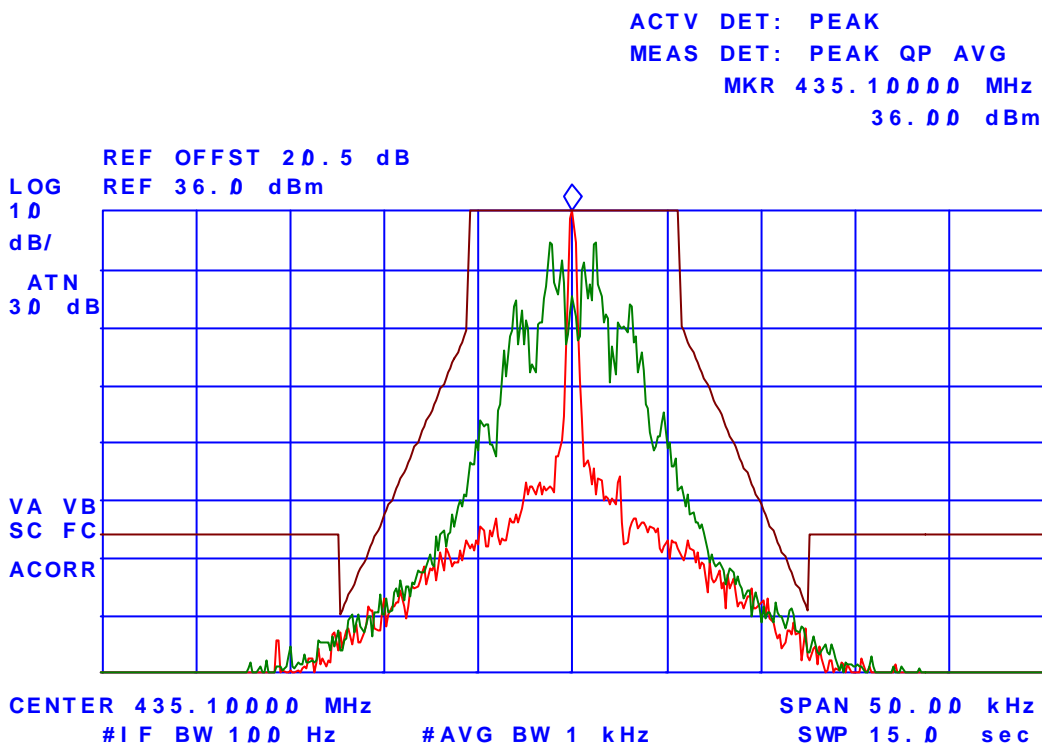

**ULTRATECH GROUP OF LABS**

3000 Bristol Circle, Oakville, Ontario, Canada L6H 6G4  
Tel. #: 905-829-1570, Fax. #: 905-829-8050, Email: [vic@ultratech-labs.com](mailto:vic@ultratech-labs.com), Website: <http://www.ultratech-labs.com>

File #: ICOM-079F90

March 10, 2004

All test results contained in this engineering test report are traceable to National Institute of Standards and Technology (NIST)

Plot # 33:  
Emission Mask D  
Carrier Frequency: 469.9 MHz  
Channel Spacing: 12.5 kHz  
Power: 4W  
Modulation: FM with 2.5kHz sine wave and scrambler

hp

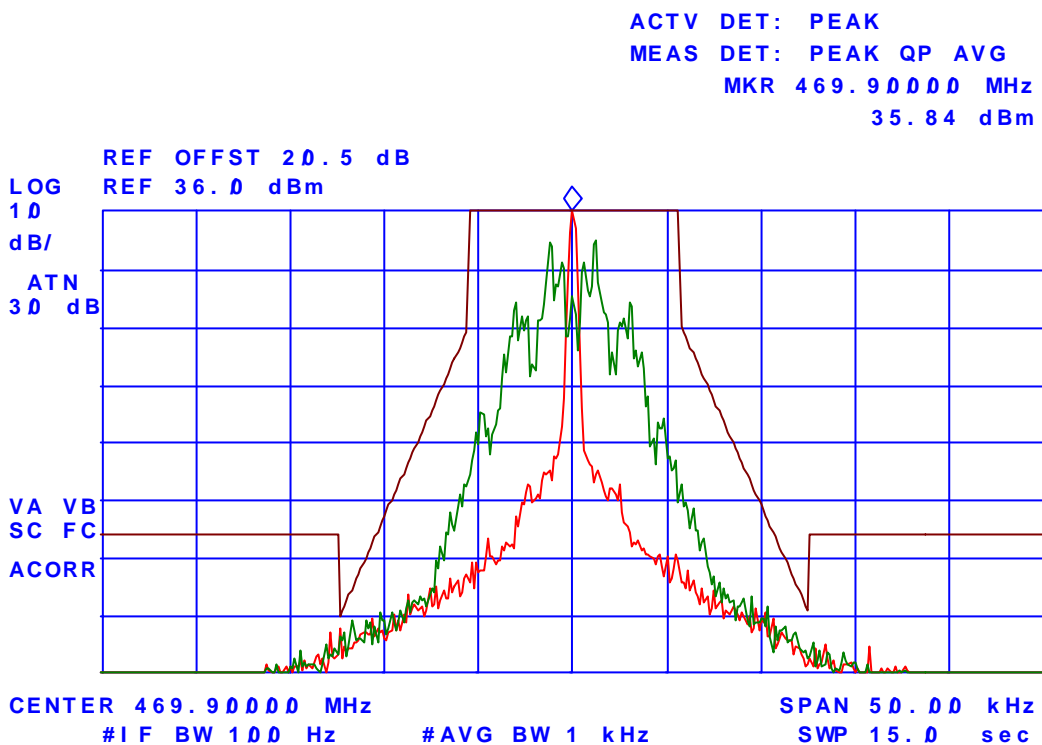

**ULTRATECH GROUP OF LABS**

3000 Bristol Circle, Oakville, Ontario, Canada L6H 6G4  
Tel. #: 905-829-1570, Fax. #: 905-829-8050, Email: [vic@ultratech-labs.com](mailto:vic@ultratech-labs.com), Website: <http://www.ultratech-labs.com>

File #: ICOM-079F90

March 10, 2004

All test results contained in this engineering test report are traceable to National Institute of Standards and Technology (NIST)

Plot # 34:  
Emission Mask D  
Carrier Frequency: 400.1MHz  
Channel Spacing: 12.5 kHz  
Power: 1W  
Modulation: FM with 2.5kHz sine wave and scrambler

hp

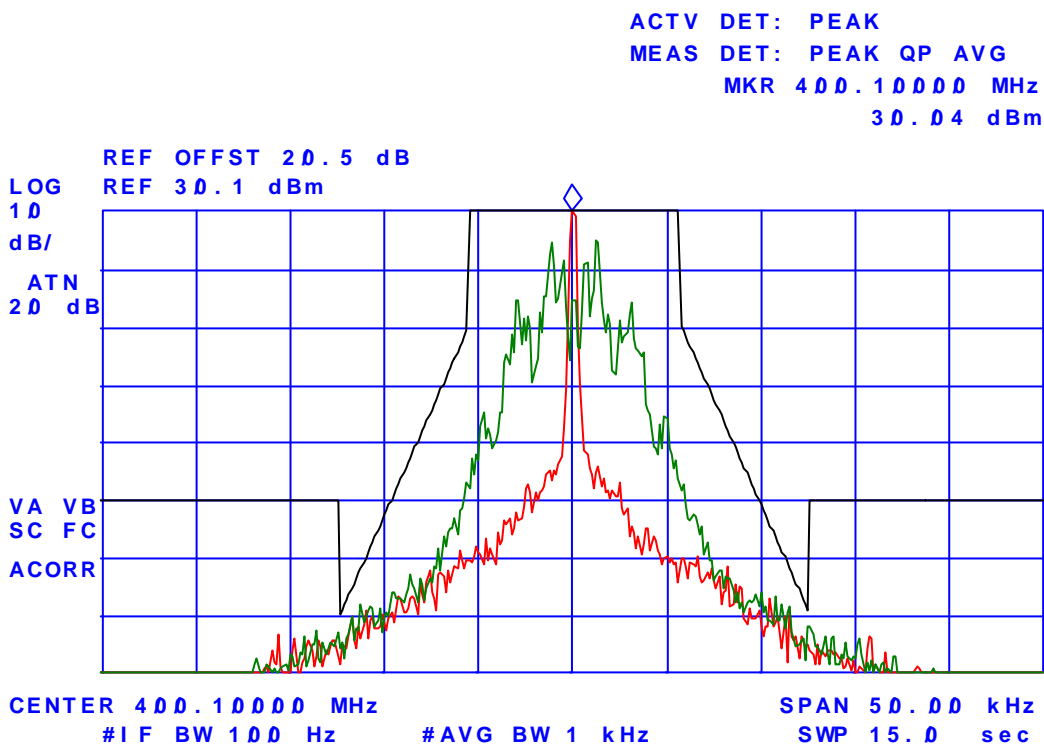

**ULTRATECH GROUP OF LABS**

3000 Bristol Circle, Oakville, Ontario, Canada L6H 6G4  
Tel. #: 905-829-1570, Fax. #: 905-829-8050, Email: [vic@ultratech-labs.com](mailto:vic@ultratech-labs.com), Website: <http://www.ultratech-labs.com>

File #: ICOM-079F90

March 10, 2004

All test results contained in this engineering test report are traceable to National Institute of Standards and Technology (NIST)

Plot # 35:  
Emission Mask D  
Carrier Frequency: 435.1MHz  
Channel Spacing: 12.5 kHz  
Power: 1W  
Modulation: FM with 2.5kHz sine wave and scrambler

hp

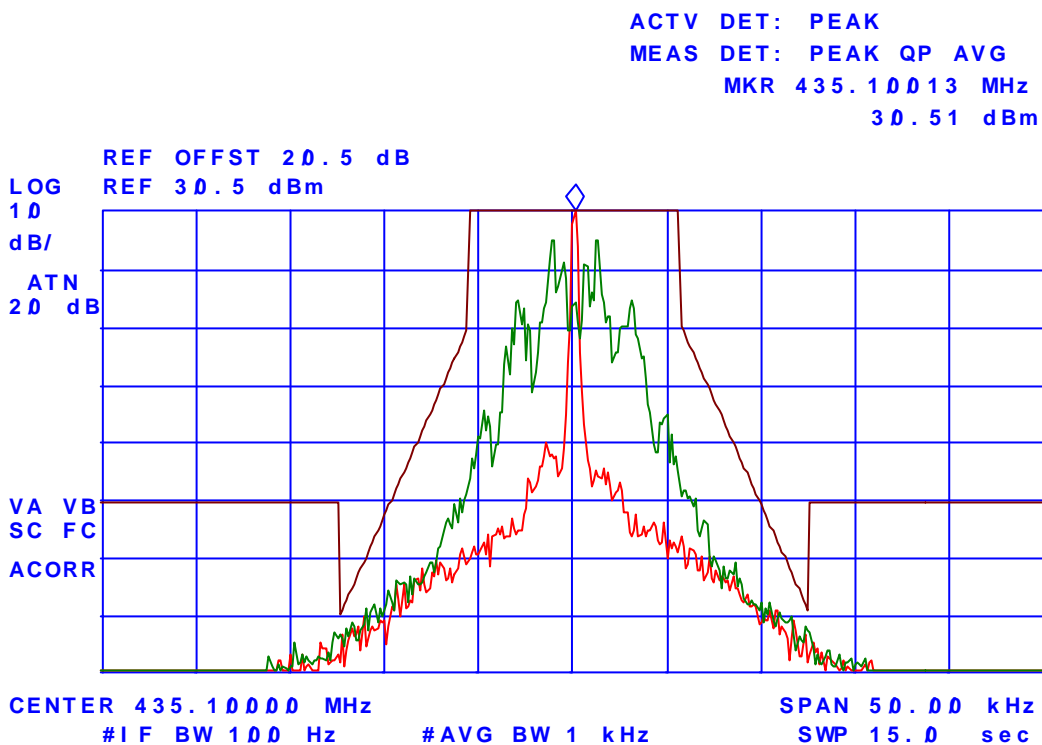

**ULTRATECH GROUP OF LABS**

3000 Bristol Circle, Oakville, Ontario, Canada L6H 6G4  
Tel. #: 905-829-1570, Fax. #: 905-829-8050, Email: [vic@ultratech-labs.com](mailto:vic@ultratech-labs.com), Website: <http://www.ultratech-labs.com>

File #: ICOM-079F90

March 10, 2004

All test results contained in this engineering test report are traceable to National Institute of Standards and Technology (NIST)

Plot # 36:  
Emission Mask D  
Carrier Frequency: 469.9 MHz  
Channel Spacing: 12.5 kHz  
Power: 1W  
Modulation: FM with 2.5kHz sine wave and scrambler

hp

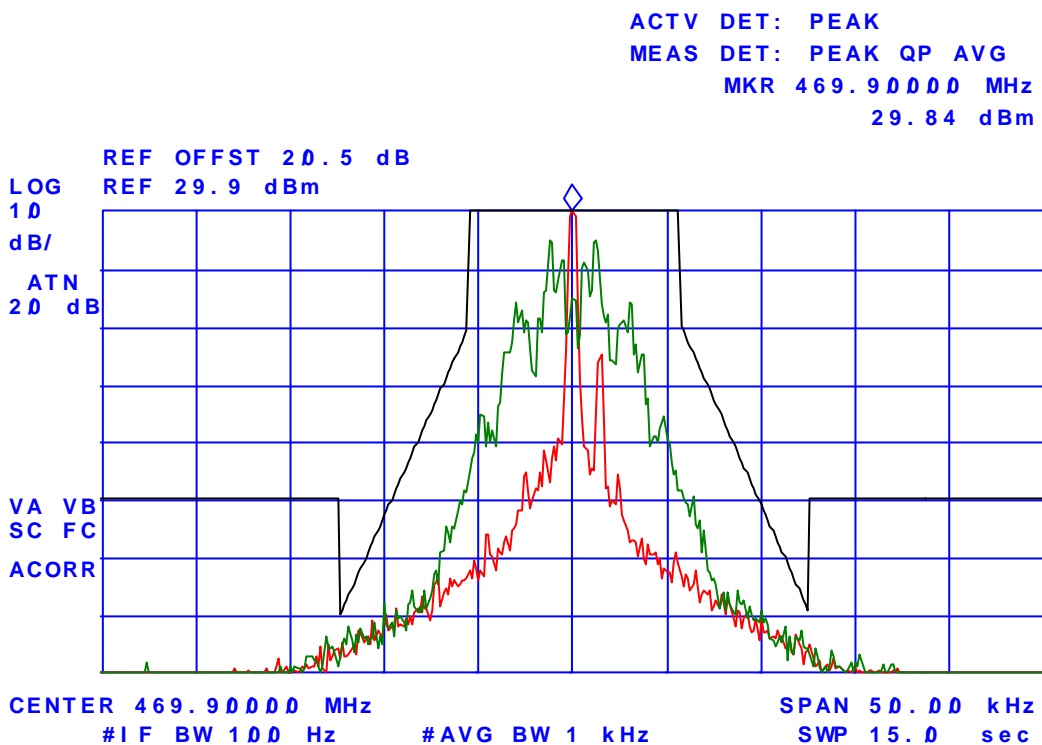

**ULTRATECH GROUP OF LABS**

3000 Bristol Circle, Oakville, Ontario, Canada L6H 6G4  
Tel. #: 905-829-1570, Fax. #: 905-829-8050, Email: [vic@ultratech-labs.com](mailto:vic@ultratech-labs.com), Website: <http://www.ultratech-labs.com>

File #: ICOM-079F90

March 10, 2004

All test results contained in this engineering test report are traceable to National Institute of Standards and Technology (NIST)

## 6.10. TRANSMITTER ANTENNA POWER SPURIOUS/HARMONIC CONDUCTED EMISSIONS [§ 90.210]

### 6.10.1. Limits

Emissions shall be attenuated below the mean output power of the transmitter as follows:

FCC Rules	Frequency Range	Attenuation Limit (dBc)
90.210(b)&(c) – Voice & data	10 MHz to Lowest frequency of the radio to 10 <sup>th</sup> harmonic of the highest frequency of the radio	43+10*log(P) or -13 dBm
90.210(d) – Voice & data	10 MHz to Lowest frequency of the radio to 10 <sup>th</sup> harmonic of the highest frequency of the radio	50+10*log(P) or -20 dBm or 70 dBc whichever is less

### 6.10.2. Method of Measurements

Refer to Exhibit 8 Section 8.5 of this report for measurement details

### 6.10.3. Test Equipment List

Test Instruments	Manufacturer	Model No.	Serial No.	Frequency Range
Spectrum Analyzer	HP	8953EM	3710A00237	9 kHz – 22 GHz
Attenuator(s)	Weinschel Corp	23-20-34	BH7876	DC – 18 GHz
Radio Communication Test Set	Marconi	2955	132037/226	20Hz – 20kHz
High Pass Filter	Mini-Circuits	SHP-600	--	Cut-off Frequency at 560 MHz
Digital Multimeter	Rohde & Schwarz	UDS-5	8729841067	DC-100 kHz

### 6.10.4. Test Arrangement

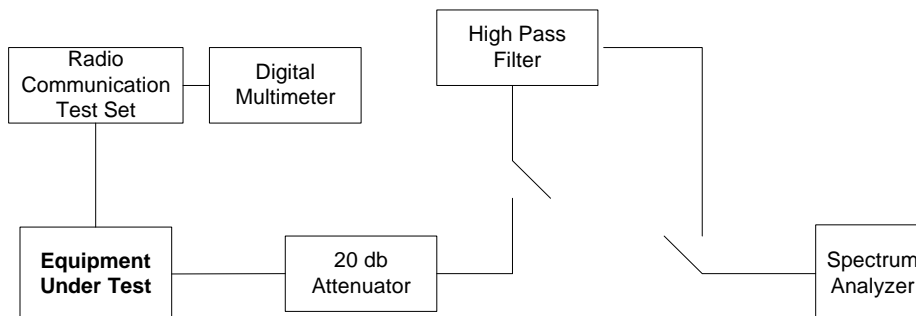

### 6.10.5. Test Data

**Note:** There was no difference in spurious/harmonic emissions on the pre-scans for narrow band and wide band operation. Therefore the rf spurious/harmonic emissions in this section would be performed for 12.5 kHz Channel Spacing and the more stringent limit of  $50 + 10 \cdot \log(P)$  would be applied for worst case.

#### 6.10.5.1. Near Lowest Frequency (400.1 MHz)

Plot # 37:  
Spurious Emissions at Antenna Terminals  
Carrier Frequency: 400.1 MHz  
Channel Spacing: 12.5 kHz  
Power: 4 W  
Modulation: FM with 2.5kHz sine wave

hp

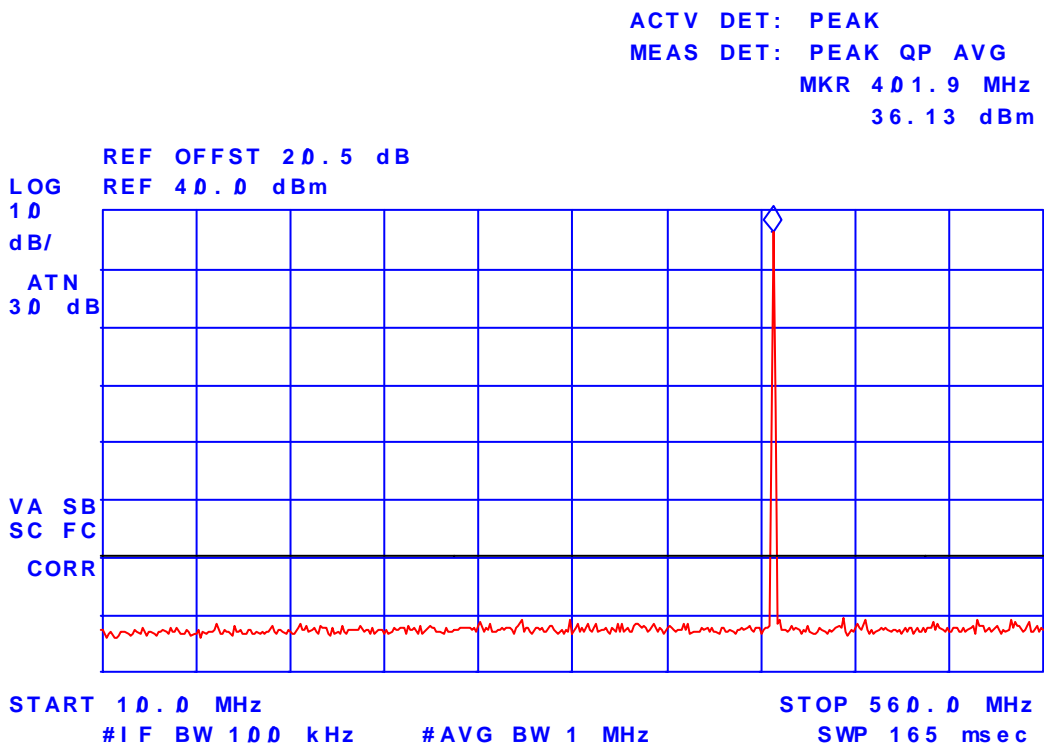



Plot # 38:  
Spurious Emissions at Antenna Terminals  
Carrier Frequency: 400.1 MHz  
Channel Spacing: 12.5 kHz  
Power: 4 W  
Modulation: FM with 2.5kHz sine wave

hp

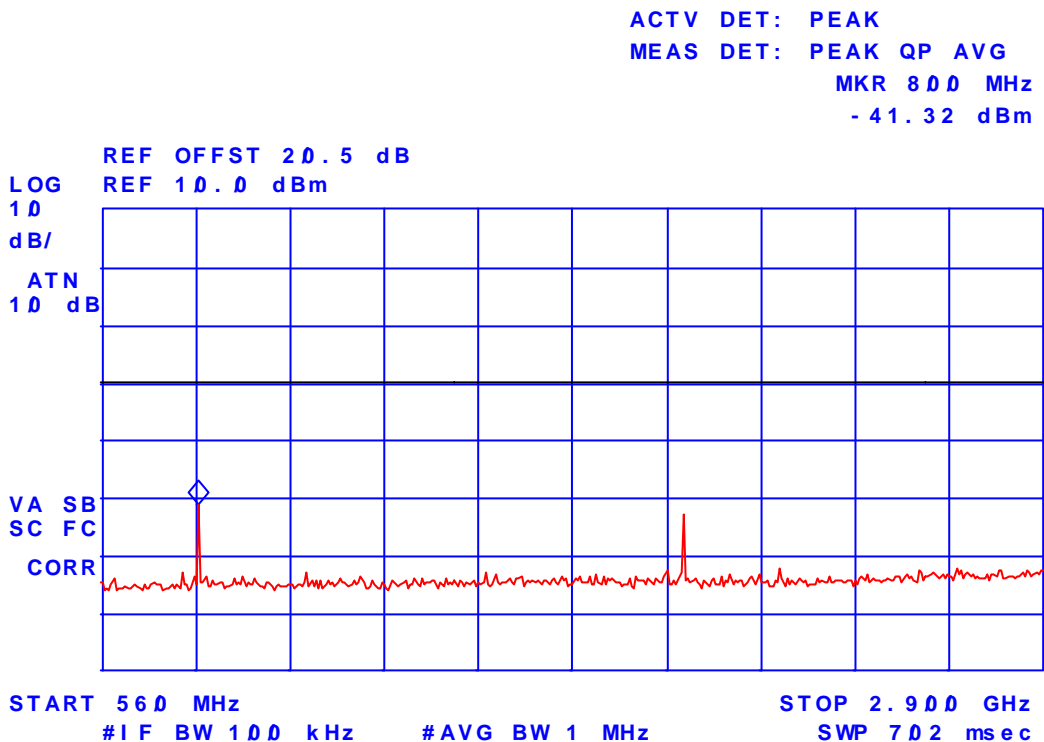

**ULTRATECH GROUP OF LABS**

3000 Bristol Circle, Oakville, Ontario, Canada L6H 6G4  
Tel. #: 905-829-1570, Fax. #: 905-829-8050, Email: [vic@ultratech-labs.com](mailto:vic@ultratech-labs.com), Website: <http://www.ultratech-labs.com>

File #: ICOM-079F90

March 10, 2004

All test results contained in this engineering test report are traceable to National Institute of Standards and Technology (NIST)

Plot # 39:  
Spurious Emissions at Antenna Terminals  
Carrier Frequency: 400.1 MHz  
Channel Spacing: 12.5 kHz  
Power: 4 W  
Modulation: FM with 2.5kHz sine wave

hp

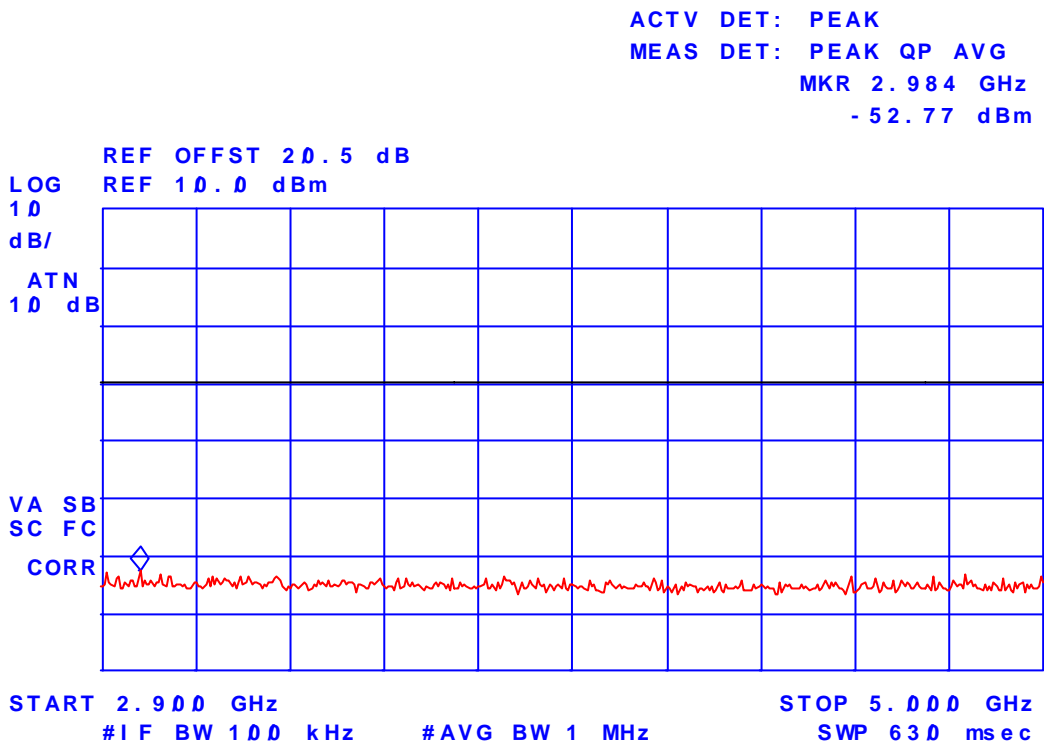

**ULTRATECH GROUP OF LABS**

3000 Bristol Circle, Oakville, Ontario, Canada L6H 6G4  
Tel. #: 905-829-1570, Fax. #: 905-829-8050, Email: [vic@ultratech-labs.com](mailto:vic@ultratech-labs.com), Website: <http://www.ultratech-labs.com>

File #: ICOM-079F90

March 10, 2004

All test results contained in this engineering test report are traceable to National Institute of Standards and Technology (NIST)

Plot # 40:  
Spurious Emissions at Antenna Terminals  
Carrier Frequency: 400.1 MHz  
Channel Spacing: 12.5 kHz  
Power: 1 W  
Modulation: FM with 2.5kHz sine wave

hp

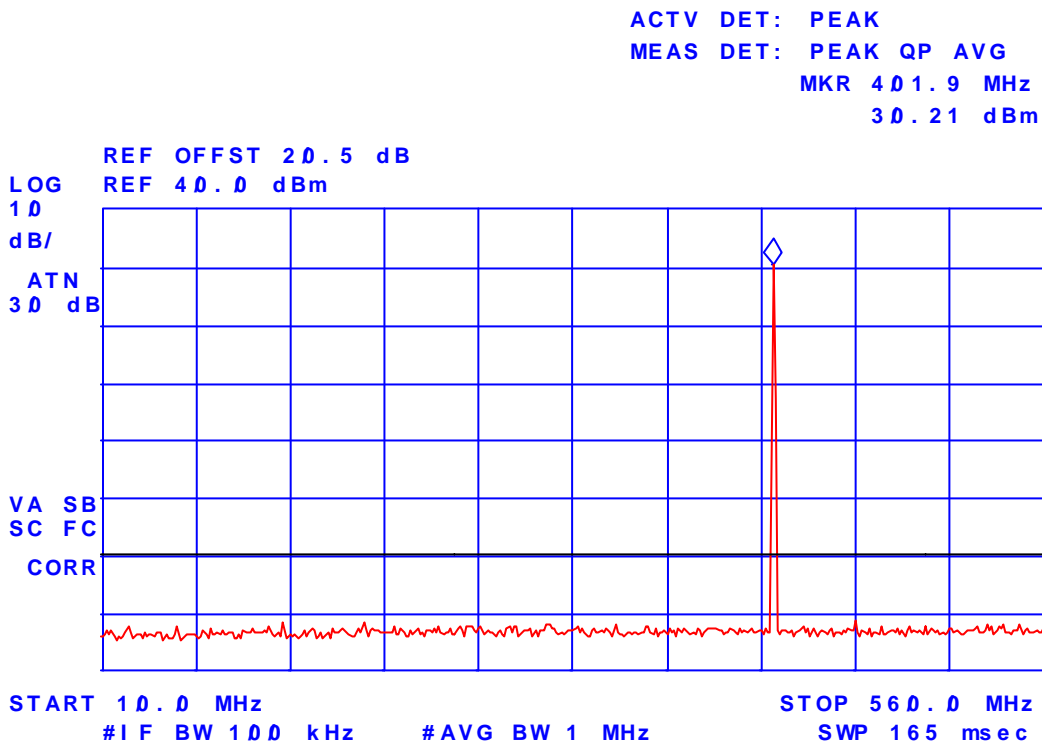

**ULTRATECH GROUP OF LABS**

3000 Bristol Circle, Oakville, Ontario, Canada L6H 6G4  
Tel. #: 905-829-1570, Fax. #: 905-829-8050, Email: [vic@ultratech-labs.com](mailto:vic@ultratech-labs.com), Website: <http://www.ultratech-labs.com>

File #: ICOM-079F90

March 10, 2004

All test results contained in this engineering test report are traceable to National Institute of Standards and Technology (NIST)

Plot # 41:  
Spurious Emissions at Antenna Terminals  
Carrier Frequency: 400.1 MHz  
Channel Spacing: 12.5 kHz  
Power: 1 W  
Modulation: FM with 2.5kHz sine wave

hp

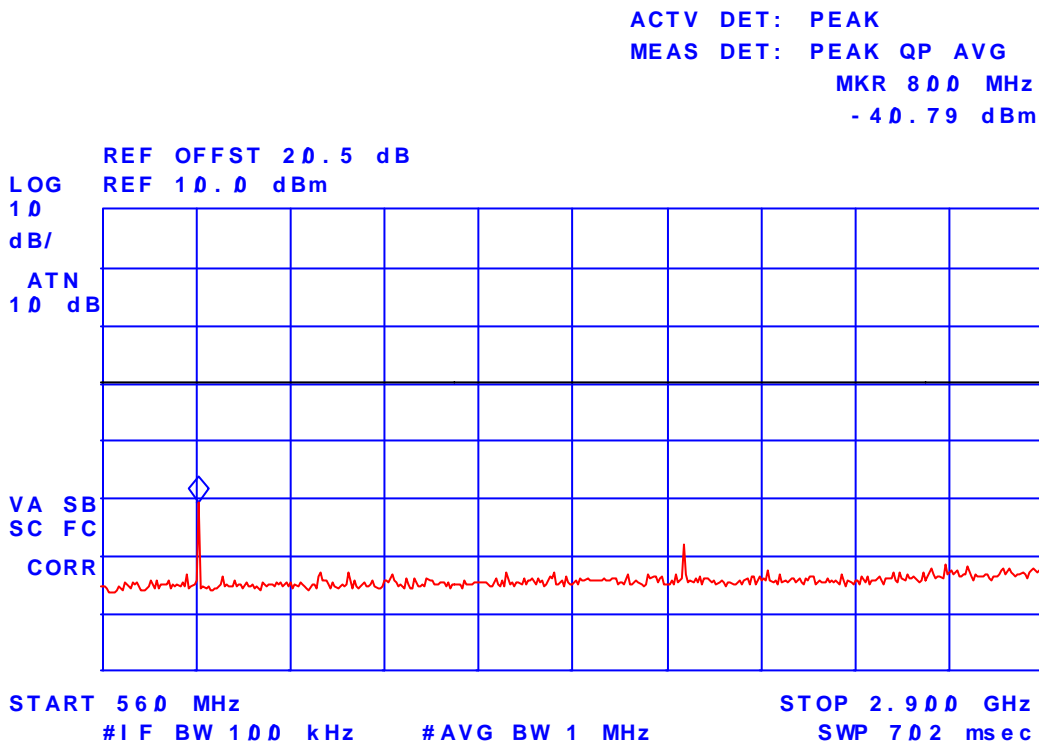

**ULTRATECH GROUP OF LABS**

3000 Bristol Circle, Oakville, Ontario, Canada L6H 6G4  
Tel. #: 905-829-1570, Fax. #: 905-829-8050, Email: [vic@ultratech-labs.com](mailto:vic@ultratech-labs.com), Website: <http://www.ultratech-labs.com>

File #: ICOM-079F90

March 10, 2004

All test results contained in this engineering test report are traceable to National Institute of Standards and Technology (NIST)

Plot # 42:  
Spurious Emissions at Antenna Terminals  
Carrier Frequency: 400.1 MHz  
Channel Spacing: 12.5 kHz  
Power: 1 W  
Modulation: FM with 2.5kHz sine wave

hp

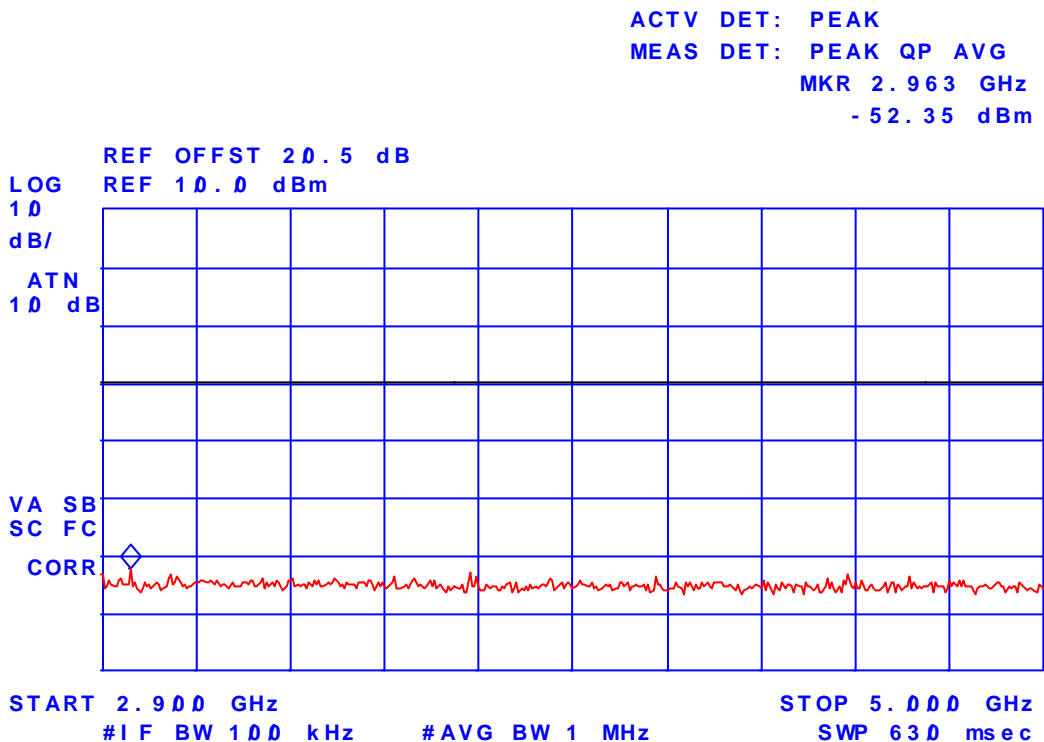

**ULTRATECH GROUP OF LABS**

3000 Bristol Circle, Oakville, Ontario, Canada L6H 6G4  
Tel. #: 905-829-1570, Fax. #: 905-829-8050, Email: [vic@ultratech-labs.com](mailto:vic@ultratech-labs.com), Website: <http://www.ultratech-labs.com>

File #: ICOM-079F90

March 10, 2004

All test results contained in this engineering test report are traceable to National Institute of Standards and Technology (NIST)

**6.10.5.2. Near Middle Frequency (435.1 MHz)**

Plot # 43:  
Spurious Emissions at Antenna Terminals  
Carrier Frequency: 435.1 MHz  
Channel Spacing: 12.5 kHz  
Power: 4 W  
Modulation: FM with 2.5kHz sine wave

*177*

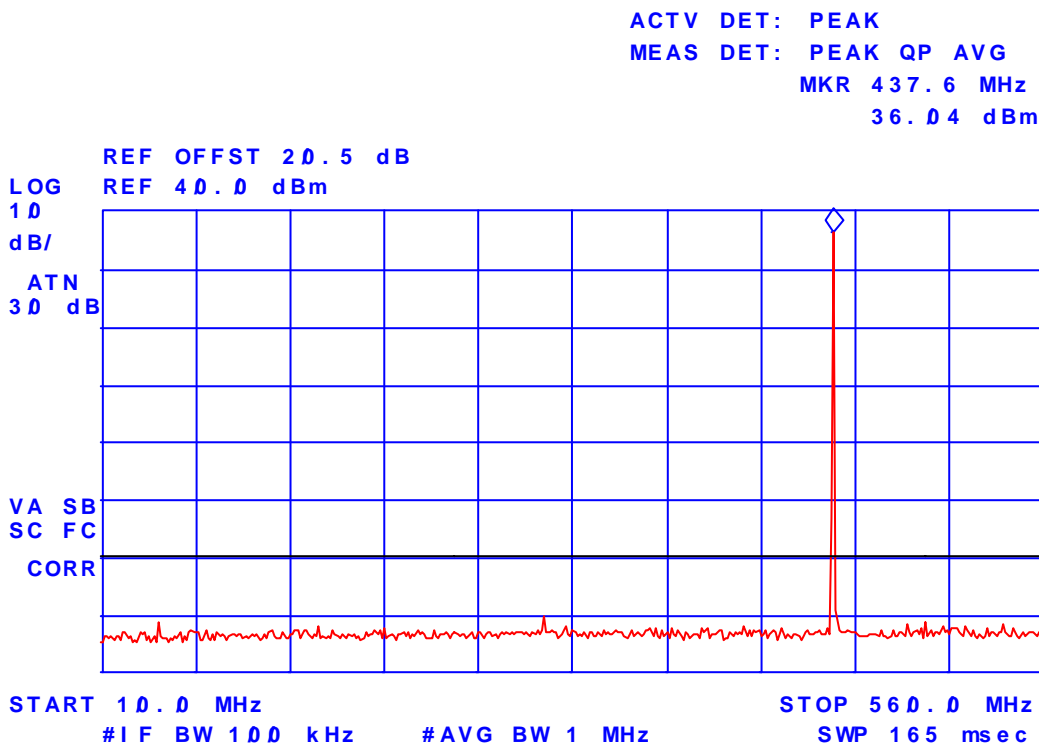

**ULTRATECH GROUP OF LABS**

3000 Bristol Circle, Oakville, Ontario, Canada L6H 6G4  
Tel. #: 905-829-1570, Fax. #: 905-829-8050, Email: [vic@ultratech-labs.com](mailto:vic@ultratech-labs.com), Website: <http://www.ultratech-labs.com>

File #: ICOM-079F90

March 10, 2004

All test results contained in this engineering test report are traceable to National Institute of Standards and Technology (NIST)

Plot # 44:  
Spurious Emissions at Antenna Terminals  
Carrier Frequency: 435.1 MHz  
Channel Spacing: 12.5 kHz  
Power: 4 W  
Modulation: FM with 2.5kHz sine wave

hp

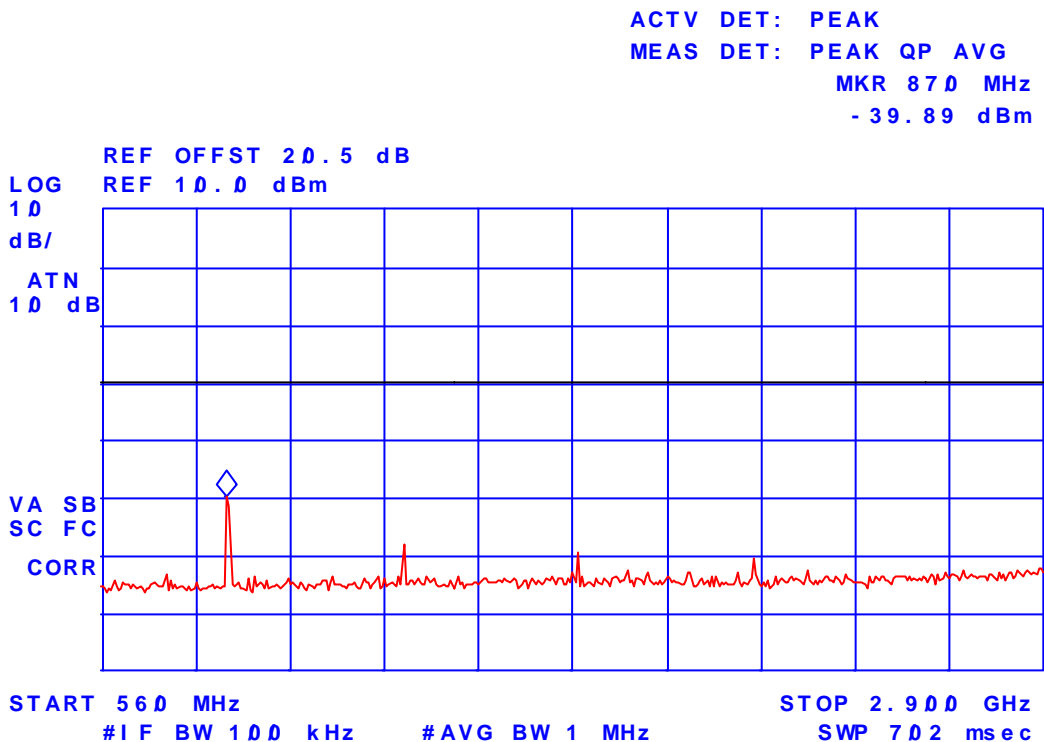

**ULTRATECH GROUP OF LABS**

3000 Bristol Circle, Oakville, Ontario, Canada L6H 6G4  
Tel. #: 905-829-1570, Fax. #: 905-829-8050, Email: [vic@ultratech-labs.com](mailto:vic@ultratech-labs.com), Website: <http://www.ultratech-labs.com>

File #: ICOM-079F90  
March 10, 2004

All test results contained in this engineering test report are traceable to National Institute of Standards and Technology (NIST)

Plot # 45:  
Spurious Emissions at Antenna Terminals  
Carrier Frequency: 435.1 MHz  
Channel Spacing: 12.5 kHz  
Power: 4 W  
Modulation: FM with 2.5kHz sine wave

*hp*

ACTV DET: PEAK  
MEAS DET: PEAK QP AVG  
MKR 3.483 GHz  
- 52.38 dBm

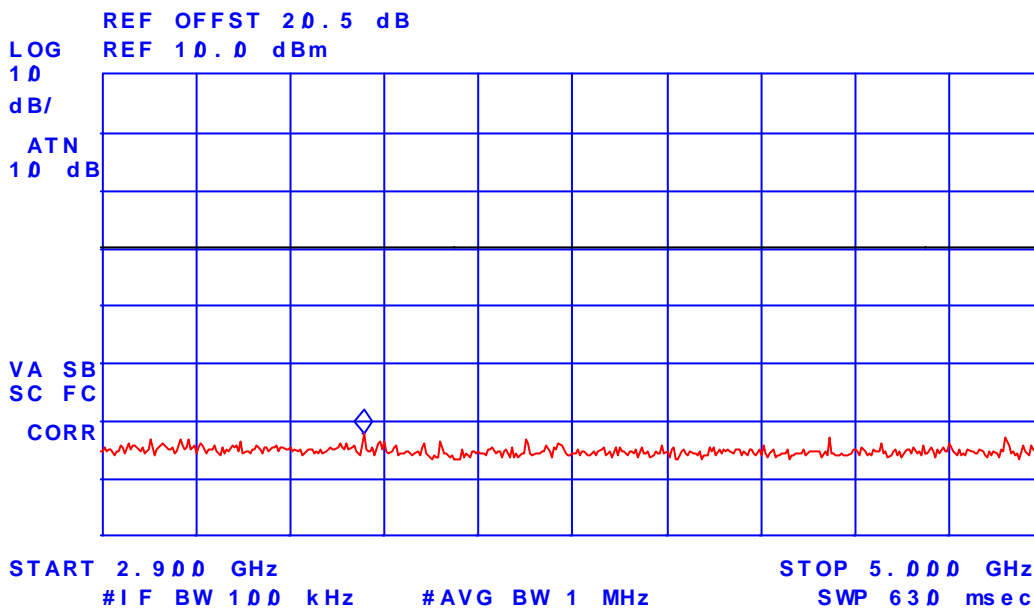

**ULTRATECH GROUP OF LABS**

3000 Bristol Circle, Oakville, Ontario, Canada L6H 6G4  
Tel. #: 905-829-1570, Fax. #: 905-829-8050, Email: [vic@ultratech-labs.com](mailto:vic@ultratech-labs.com), Website: <http://www.ultratech-labs.com>

File #: ICOM-079F90

March 10, 2004

All test results contained in this engineering test report are traceable to National Institute of Standards and Technology (NIST)



Plot # 46:  
Spurious Emissions at Antenna Terminals  
Carrier Frequency: 435.1 MHz  
Channel Spacing: 12.5 kHz  
Power: 1 W  
Modulation: FM with 2.5kHz sine wave

hp

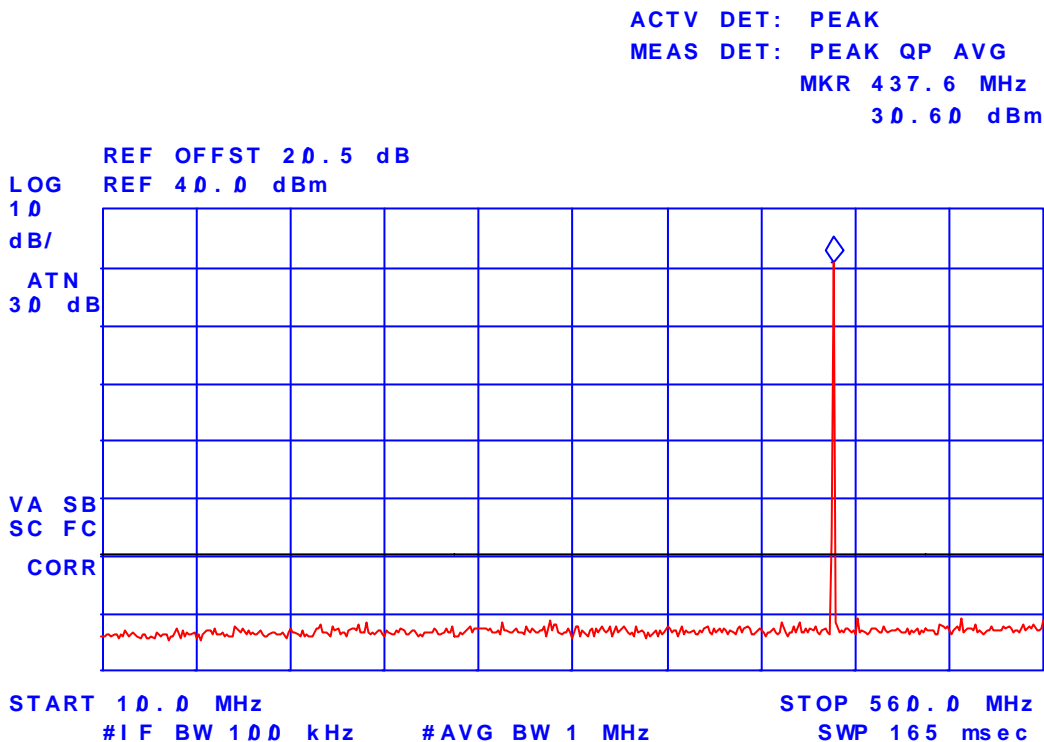

**ULTRATECH GROUP OF LABS**

3000 Bristol Circle, Oakville, Ontario, Canada L6H 6G4  
Tel. #: 905-829-1570, Fax. #: 905-829-8050, Email: [vic@ultratech-labs.com](mailto:vic@ultratech-labs.com), Website: <http://www.ultratech-labs.com>

File #: ICOM-079F90

March 10, 2004

All test results contained in this engineering test report are traceable to National Institute of Standards and Technology (NIST)

Plot # 47:  
Spurious Emissions at Antenna Terminals  
Carrier Frequency: 435.1 MHz  
Channel Spacing: 12.5 kHz  
Power: 1 W  
Modulation: FM with 2.5kHz sine wave

hp

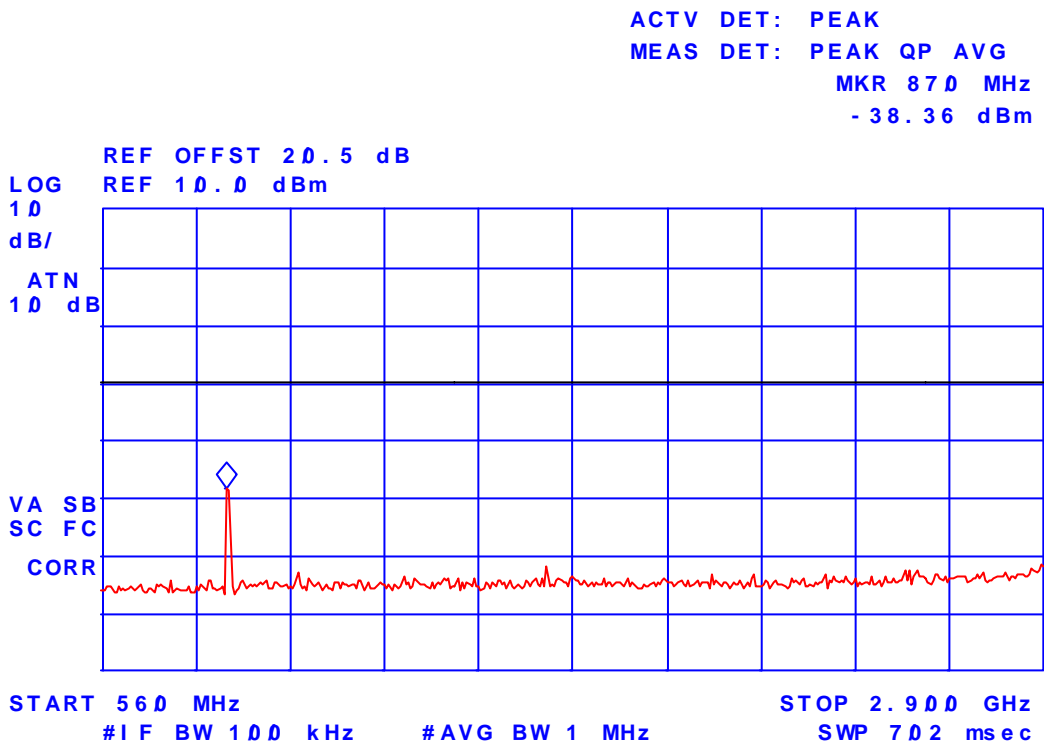

**ULTRATECH GROUP OF LABS**

3000 Bristol Circle, Oakville, Ontario, Canada L6H 6G4  
Tel. #: 905-829-1570, Fax. #: 905-829-8050, Email: [vic@ultratech-labs.com](mailto:vic@ultratech-labs.com), Website: <http://www.ultratech-labs.com>

File #: ICOM-079F90

March 10, 2004

All test results contained in this engineering test report are traceable to National Institute of Standards and Technology (NIST)

Plot # 48:  
Spurious Emissions at Antenna Terminals  
Carrier Frequency: 435.1 MHz  
Channel Spacing: 12.5 kHz  
Power: 1 W  
Modulation: FM with 2.5kHz sine wave

*hp*

ACTV DET: PEAK  
MEAS DET: PEAK QP AVG  
MKR 3.199 GHz  
- 52.39 dBm

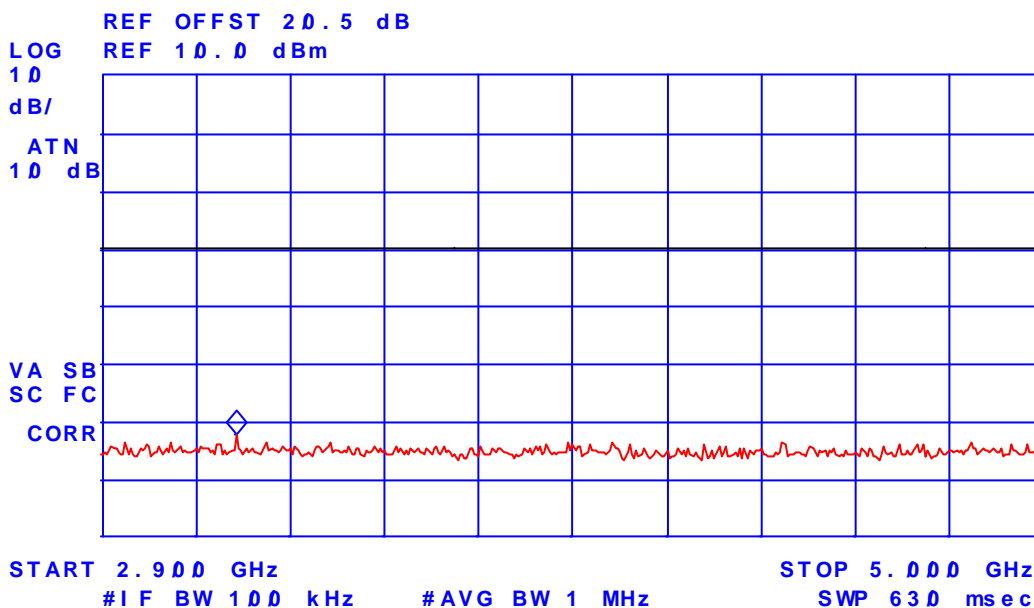

**ULTRATECH GROUP OF LABS**

3000 Bristol Circle, Oakville, Ontario, Canada L6H 6G4  
Tel. #: 905-829-1570, Fax. #: 905-829-8050, Email: [vic@ultratech-labs.com](mailto:vic@ultratech-labs.com), Website: <http://www.ultratech-labs.com>

File #: ICOM-079F90

March 10, 2004

All test results contained in this engineering test report are traceable to National Institute of Standards and Technology (NIST)

**6.10.5.3. Near Highest Frequency (469.9 MHz)**

Plot # 49:  
Spurious Emissions at Antenna Terminals  
Carrier Frequency: 469.9 MHz  
Channel Spacing: 12.5 kHz  
Power: 4 W  
Modulation: FM with 2.5kHz sine wave

*hp*

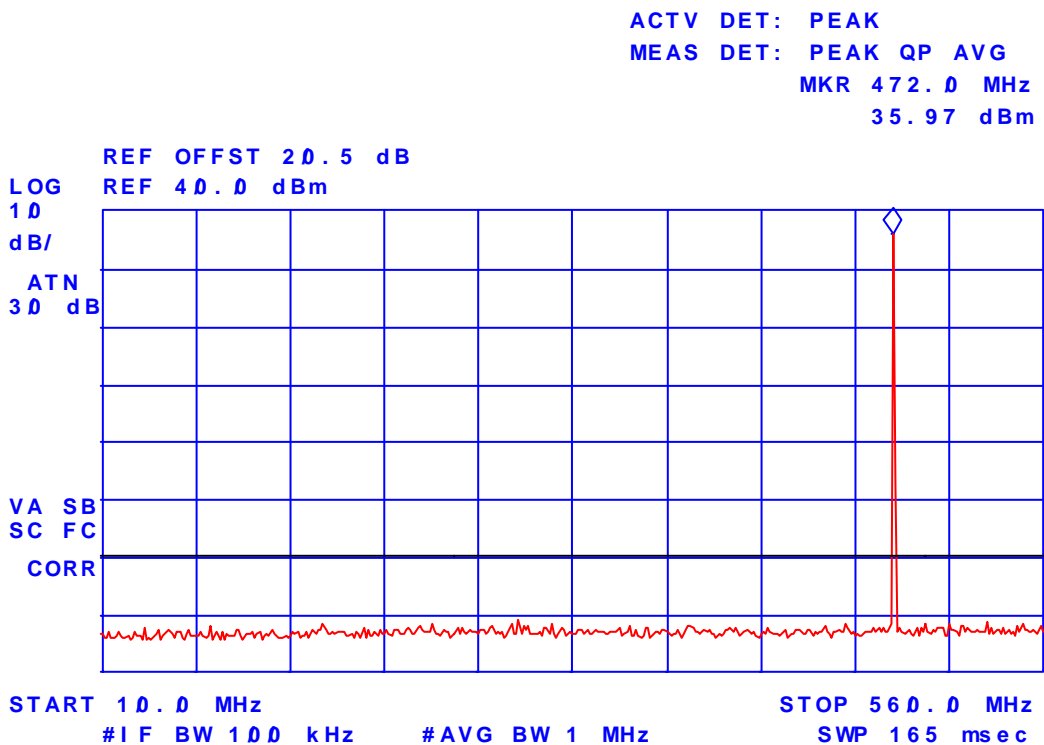

Plot # 50:  
Spurious Emissions at Antenna Terminals  
Carrier Frequency: 469.9 MHz  
Channel Spacing: 12.5 kHz  
Power: 4 W  
Modulation: FM with 2.5kHz sine wave

*hp*

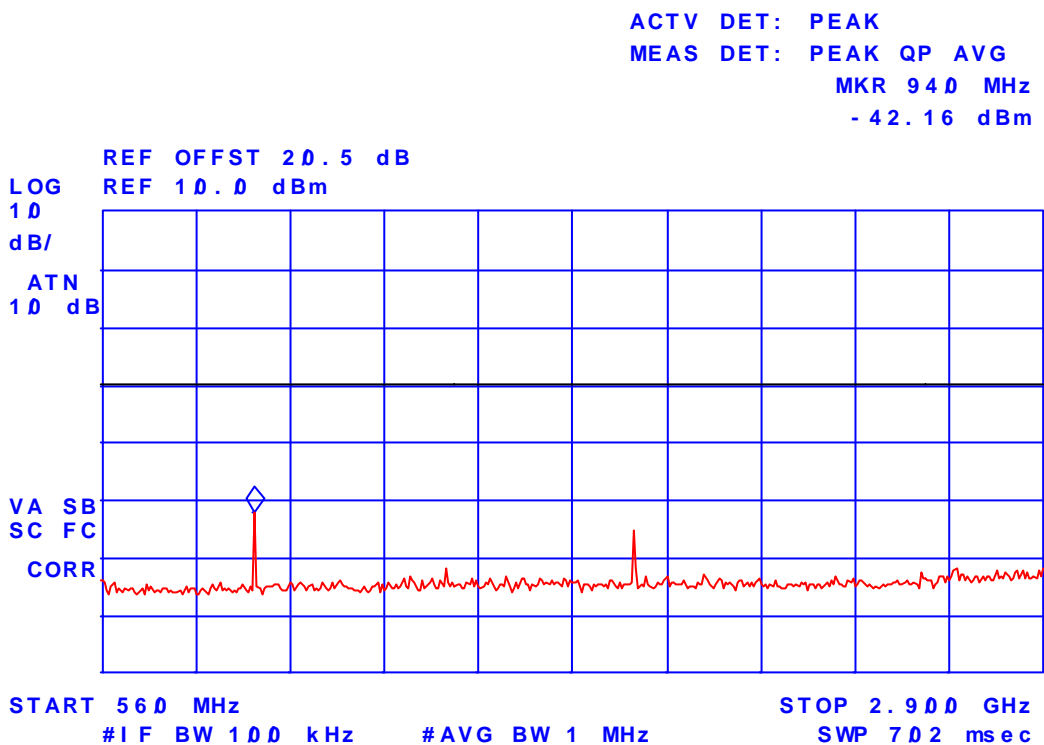

**ULTRATECH GROUP OF LABS**

3000 Bristol Circle, Oakville, Ontario, Canada L6H 6G4  
Tel. #: 905-829-1570, Fax. #: 905-829-8050, Email: [vic@ultratech-labs.com](mailto:vic@ultratech-labs.com), Website: <http://www.ultratech-labs.com>

File #: ICOM-079F90

March 10, 2004

All test results contained in this engineering test report are traceable to National Institute of Standards and Technology (NIST)

Plot # 51:  
Spurious Emissions at Antenna Terminals  
Carrier Frequency: 469.9 MHz  
Channel Spacing: 12.5 kHz  
Power: 4 W  
Modulation: FM with 2.5kHz sine wave

*hp*

ACTV DET: PEAK  
MEAS DET: PEAK QP AVG  
MKR 4.228 GHz  
- 53.26 dBm

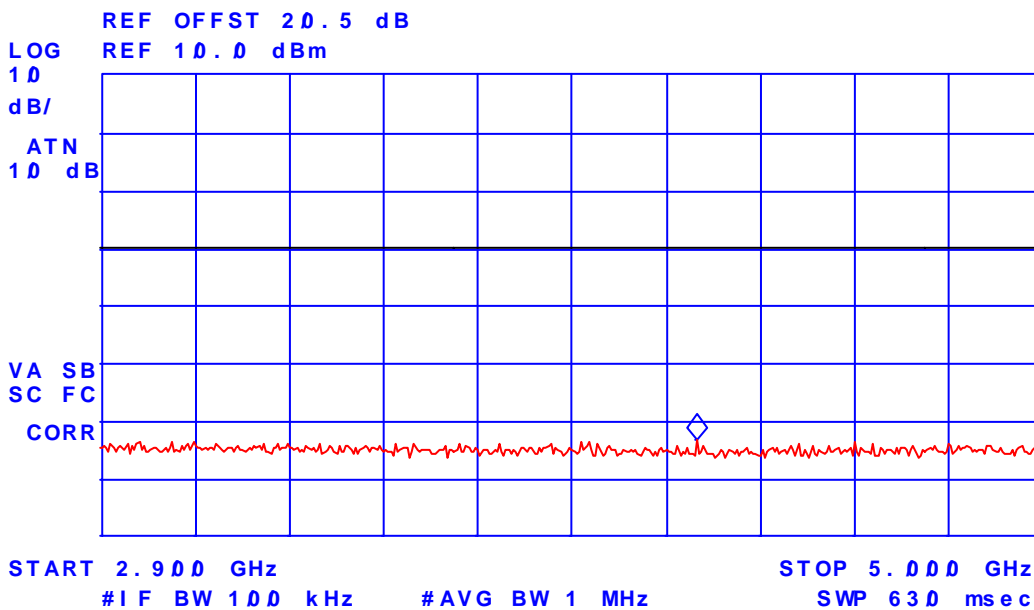

**ULTRATECH GROUP OF LABS**

3000 Bristol Circle, Oakville, Ontario, Canada L6H 6G4  
Tel. #: 905-829-1570, Fax. #: 905-829-8050, Email: [vic@ultratech-labs.com](mailto:vic@ultratech-labs.com), Website: <http://www.ultratech-labs.com>

File #: ICOM-079F90

March 10, 2004

All test results contained in this engineering test report are traceable to National Institute of Standards and Technology (NIST)

Plot # 52:  
Spurious Emissions at Antenna Terminals  
Carrier Frequency: 469.9 MHz  
Channel Spacing: 12.5 kHz  
Power: 1 W  
Modulation: FM with 2.5kHz sine wave

*hp*

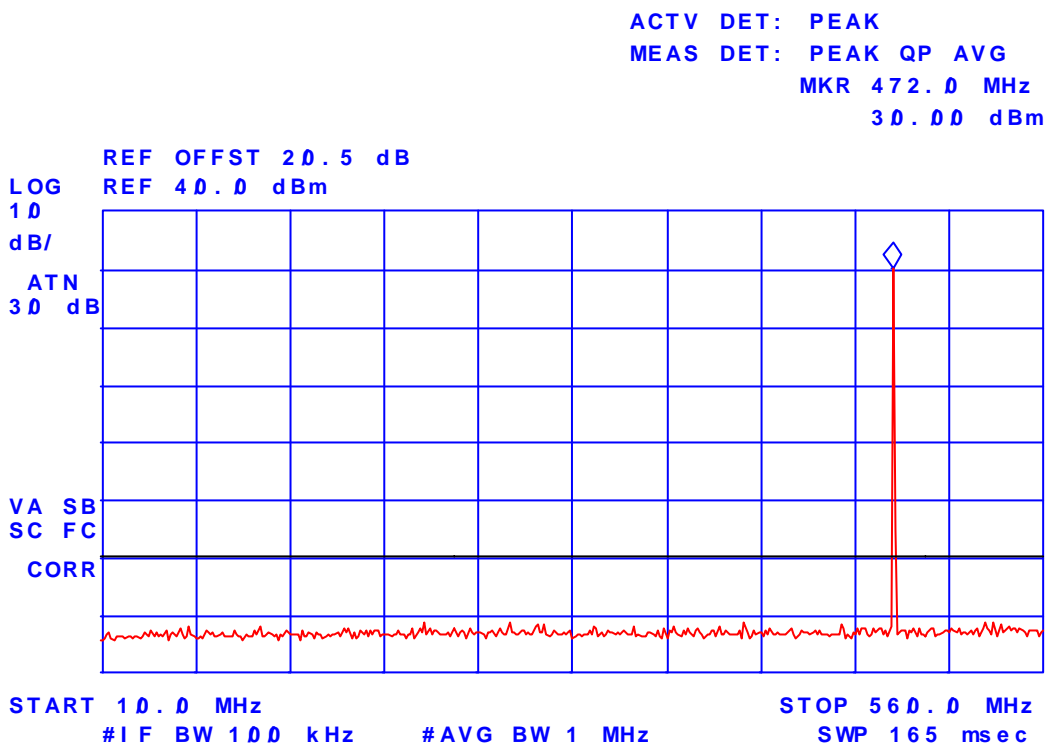

**ULTRATECH GROUP OF LABS**

3000 Bristol Circle, Oakville, Ontario, Canada L6H 6G4  
Tel. #: 905-829-1570, Fax. #: 905-829-8050, Email: [vic@ultratech-labs.com](mailto:vic@ultratech-labs.com), Website: <http://www.ultratech-labs.com>

File #: ICOM-079F90  
March 10, 2004

All test results contained in this engineering test report are traceable to National Institute of Standards and Technology (NIST)

Plot # 53:  
Spurious Emissions at Antenna Terminals  
Carrier Frequency: 469.9 MHz  
Channel Spacing: 12.5 kHz  
Power: 1 W  
Modulation: FM with 2.5kHz sine wave

177

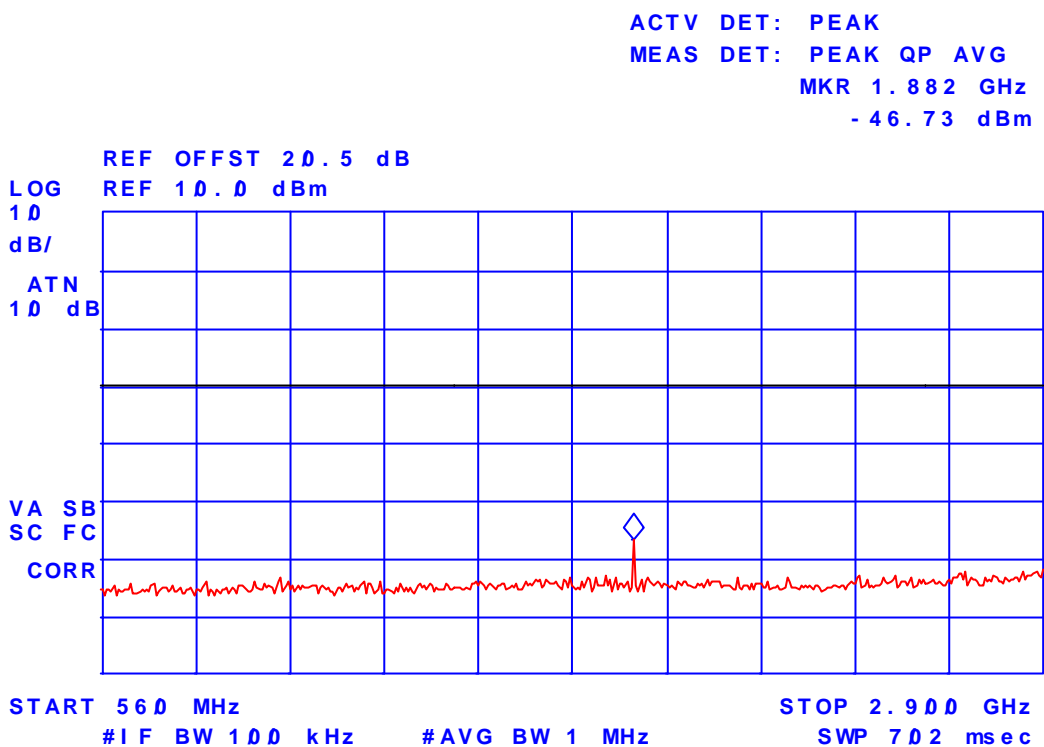

**ULTRATECH GROUP OF LABS**

3000 Bristol Circle, Oakville, Ontario, Canada L6H 6G4  
Tel. #: 905-829-1570, Fax. #: 905-829-8050, Email: [vic@ultratech-labs.com](mailto:vic@ultratech-labs.com), Website: <http://www.ultratech-labs.com>

File #: ICOM-079F90

March 10, 2004

All test results contained in this engineering test report are traceable to National Institute of Standards and Technology (NIST)



Plot # 54:  
Spurious Emissions at Antenna Terminals  
Carrier Frequency: 469.9 MHz  
Channel Spacing: 12.5 kHz  
Power: 1 W  
Modulation: FM with 2.5kHz sine wave

177

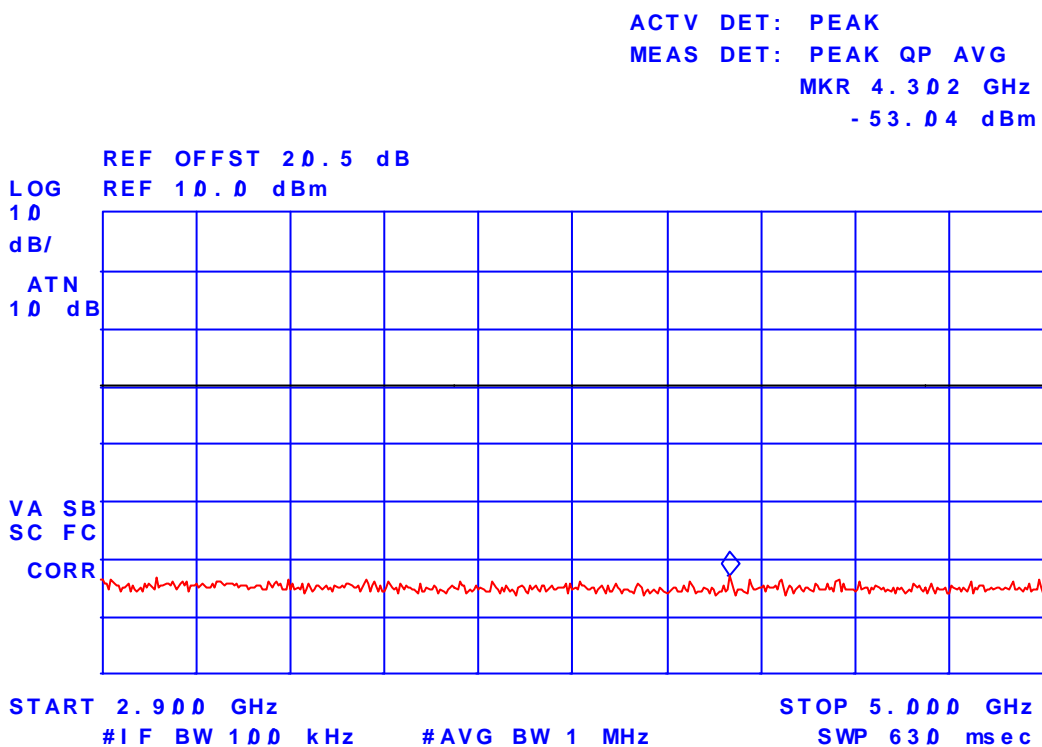

**ULTRATECH GROUP OF LABS**

3000 Bristol Circle, Oakville, Ontario, Canada L6H 6G4  
Tel. #: 905-829-1570, Fax. #: 905-829-8050, Email: [vic@ultratech-labs.com](mailto:vic@ultratech-labs.com), Website: <http://www.ultratech-labs.com>

File #: ICOM-079F90

March 10, 2004

All test results contained in this engineering test report are traceable to National Institute of Standards and Technology (NIST)

## 6.11. TRANSMITTER SPURIOUS/HARMONIC RADIATED EMISSIONS [§ 90.210]

### 6.11.1. Limits

Emissions shall be attenuated below the mean output power of the transmitter as follows:

FCC Rules	Frequency Range	Attenuation Limit (dBc)
90.210(b)&(c) – Voice & data	10 MHz to Lowest frequency of the radio to 10 <sup>th</sup> harmonic of the highest frequency of the radio	43+10*log(P) or -13 dBm
90.210(d) – Voice & data	10 MHz to Lowest frequency of the radio to 10 <sup>th</sup> harmonic of the highest frequency of the radio	50+10*log(P) or -20 dBm or 70 dBc whichever is less

### 6.11.2. Method of Measurements

The spurious/harmonic ERP measurements are using substitution method specified in Exhibit 8, § 8.2 of this report and its value in dBc is calculated as follows:

- (1) If the transmitter's antenna is an integral part of the EUT, the ERP is measured using substitution method.
- (2) If the transmitter's antenna is non-integral and diverse, the lowest ERP of the carrier with 0 dBi antenna gain is used for calculation of the spurious/harmonic emissions in dBc:  
 Lowest ERP of the carrier = EIRP – 2.15 dB = P<sub>c</sub> + G - 2.15 dB = P<sub>c</sub> dBm (conducted) + 0 dBi – 2.15 dB
- (3) Spurious /harmonic emissions levels expressed in dBc (dB below carrier) are as follows:

$$\text{ERP of spurious/harmonic (dBc)} = \text{ERP of carrier (dBm)} - \text{ERP of spurious/harmonic emission (dBm)}$$

### 6.11.3. Test Equipment List

Test Instruments	Manufacturer	Model No.	Serial No.	Frequency Range
Spectrum Analyzer	Rohde&Schwarz	FSEK20/B4/B21	834157/005	9 kHz to 40 GHz
RF Amplifier	Com-Power	PA-102		1 MHz to 1 GHz, 30 dB gain nominal
Microwave Amplifier	Hewlett Packard	HP 8449B	3008A00769	1 GHz to 26.5 GHz, 30 dB nominal
Biconilog Antenna	EMCO	3142	10005	30 MHz to 2 GHz
Dipole Antenna	EMCO	3121C	8907-434	30 GHz – 1 GHz
Dipole Antenna	EMCO	3121C	8907-440	30 GHz – 1 GHz
Horn Antenna	EMCO	3155	9701-5061	1 GHz – 18 GHz
Horn Antenna	EMCO	3155	9911-5955	1 GHz – 18 GHz
RF Signal Generator	Hewlett Packard	HP 83752B	3610A00457	0.01 – 20 GHz

#### ULTRATECH GROUP OF LABS

3000 Bristol Circle, Oakville, Ontario, Canada L6H 6G4  
 Tel. #: 905-829-1570, Fax. #: 905-829-8050, Email: [vic@ultratech-labs.com](mailto:vic@ultratech-labs.com), Website: <http://www.ultratech-labs.com>

File #: ICOM-079F90  
 March 10, 2004

All test results contained in this engineering test report are traceable to National Institute of Standards and Technology (NIST)

### 6.11.4. Test Data

**Remarks:**

- The RF spurious/harmonic emission characteristics for narrow band and wide band operation are indistinguishable. Therefore, the following radiated emissions were performed at 12.5 kHz channel spacing (narrow band) operation, and the results were compared with the more stringent limit of  $50+10*\log(P)$  in Watts) for the worst-case.
- The radiated emissions were performed with high power setting (4 Watts) at 3 meters distance to represents the worst-case test configuration.
- The emissions were scanned from 30 MHz to 5 GHz; all emissions within 20 dB below the limits were recorded.

#### 6.11.4.1. Near Lowest Frequency (400.1 MHz)

Frequency (MHz)	E-Field @3m (dBμV/m)	ERP measured by Substitution Method		EMI Detector (Peak/QP)	Antenna Polarization (H/V)	Limit (dBc)	Margin (dB)	Pass/Fail
		(dBm)	(dBc)					
1200.3	70.77	-32.49	-68.5	Peak	V	-55.96	-12.5	Pass
1200.3	70.26	-30.84	-66.8	Peak	H	-55.96	-10.8	Pass
1600.4	70.31	-32.72	-68.7	Peak	V	-55.96	-12.7	Pass
1600.4	68.23	-34.22	-70.2	Peak	H	-55.96	-14.2	Pass

#### 6.11.4.2. Near Middle Frequency (435.1 MHz)

Frequency (MHz)	E-Field @3m (dBμV/m)	ERP measured by Substitution Method		EMI Detector (Peak/QP)	Antenna Polarization (H/V)	Limit (dBc)	Margin (dB)	Pass/Fail
		(dBm)	(dBc)					
1305.3	76.40	-24.98	-60.9	Peak	V	-55.96	-5.0	Pass
1305.3	72.15	-28.73	-64.7	Peak	H	-55.96	-8.7	Pass
1740.4	62.12	-39.39	-75.4	Peak	V	-55.96	-19.4	Pass
1740.4	63.53	-39.17	-75.1	Peak	H	-55.96	-19.2	Pass

#### 6.11.4.3. Near Highest Frequency (469.9 MHz)

Frequency (MHz)	E-Field @3m (dBμV/m)	ERP measured by Substitution Method		EMI Detector (Peak/QP)	Antenna Polarization (H/V)	Limit (dBc)	Margin (dB)	Pass/Fail
		(dBm)	(dBc)					
1409.7	62.87	-39.40	-75.2	Peak	V	-55.78	-19.4	Pass
1409.7	62.55	-38.91	-74.7	Peak	H	-55.78	-18.9	Pass
1879.6	64.83	-36.64	-72.4	Peak	V	-55.78	-16.6	Pass
1879.6	67.82	-34.39	-70.2	Peak	H	-55.78	-14.4	Pass

## 6.12. TRANSIENT FREQUENCY BEHAVIOR [§ 90.214]

### 6.12.1. Limits

Transient frequencies must be within the maximum frequency difference limits during the time intervals indicated:

Time intervals <sup>1, 2</sup>	Maximum frequency difference <sup>3</sup>	All equipment	
		150 to 174 MHz	421 to 512MHz
Transient Frequency Behavior for Equipment Designed to Operate on 25 kHz Channels			
t <sub>1</sub> <sup>4</sup> .....	± 25.0 kHz	5.0 ms	10.0 ms
t <sub>2</sub> .....	± 12.5 kHz	20.0 ms	25.0 ms
t <sub>3</sub> <sup>4</sup> .....	± 25.0 kHz	5.0 ms	10.0 ms
Transient Frequency Behavior for Equipment Designed to Operate on 12.5 kHz Channels			
t <sub>1</sub> <sup>4</sup> .....	± 12.5 kHz	5.0 ms	10.0 ms
t <sub>2</sub> .....	± 6.25 kHz	20.0 ms	25.0 ms
t <sub>3</sub> <sup>4</sup> .....	± 12.5 kHz	5.0 ms	10.0 ms

- t<sub>on</sub> is the instant when a 1 kHz test signal is completely suppressed, including any capture time due to phasing.  
 t<sub>1</sub> is the time period immediately following t<sub>on</sub>.  
 t<sub>2</sub> is the time period immediately following t<sub>1</sub>.  
 t<sub>3</sub> is the time period from the instant when the transmitter is turned off until t<sub>off</sub>.  
 t<sub>off</sub> is the instant when the 1 kHz test signal starts to rise.
- During the time from the end of t<sub>2</sub> to the beginning of t<sub>3</sub>, the frequency difference must not exceed the limits specified in § 90.213.
- Difference between the actual transmitter frequency and the assigned transmitter frequency.
- If the transmitter carrier output power rating is 6 watts or less, the frequency difference during this time period may exceed the maximum frequency difference for this time period.

### 6.12.2. Method of Measurements

Refer to Exhibit 8, Section 8.6 of this test report and ANSI/TIA/EIA-603-B-2002, Section 2.2.19.

### 6.12.3. Test Equipment List

Test Instruments	Manufacturer	Model No.	Serial No.	Frequency Range
Radio Communication Test Set	Marconi	2955	132037/226	20 Hz – 20 kHz
RF Synthesized Signal Generator	Gigatronic	6061A	5130408	10 kHz – 1050 MHz
Combiner	Mini-Circuit	ZFSC-3-4	15542	1 MHz – 1000 MHz
Infinium Digitizing Oscilloscope	Hewlett Packard	54810A	US38380192	DC - 500 MHz
RF Detector	Narda	503A-03	0105	10 MHz – 18 GHz
Attenuator	Weinschel Corp	23-20-34	BH7876	DC – 18 GHz
Modulation Analyzer	Hewlett Packard	8901B	3226A04606	150 kHz – 1300 MHz
Digital Multimeter	Rohde & Schwarz	UDS-5	8729841067	DC-100 kHz

### 6.12.4. Test Arrangement

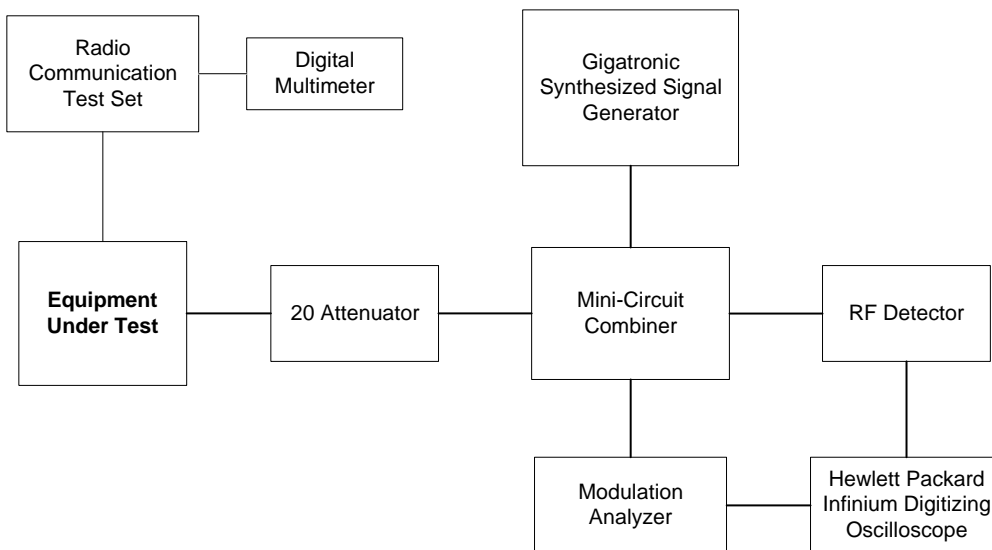

### 6.12.5. Test Data

#### 6.12.5.1. 12.5 kHz Channel Spacing Operation

Plot # 55:  
Transient Frequency Behavior  
Carrier Frequency: 400.1 MHz  
Channel Spacing: 12.5 kHz  
Power: 4 W  
Modulation: Unmodulated  
Description: Switch on condition  $t_{on}$ ,  $t_1$ , and  $t_2$

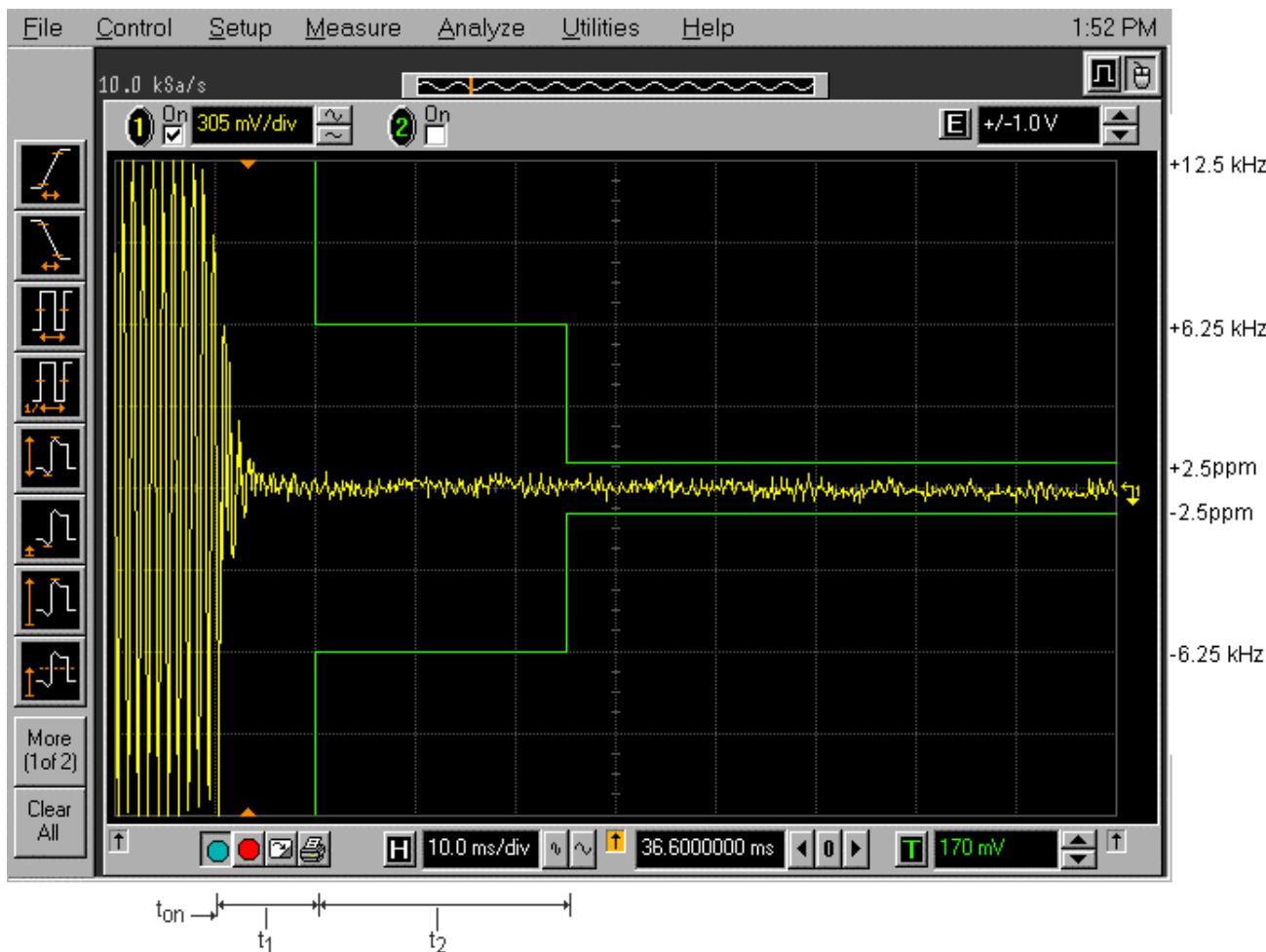

### ULTRATECH GROUP OF LABS

3000 Bristol Circle, Oakville, Ontario, Canada L6H 6G4  
Tel. #: 905-829-1570, Fax. #: 905-829-8050, Email: [vic@ultratech-labs.com](mailto:vic@ultratech-labs.com), Website: <http://www.ultratech-labs.com>

File #: ICOM-079F90  
March 10, 2004

All test results contained in this engineering test report are traceable to National Institute of Standards and Technology (NIST)

Plot # 56:  
Transient Frequency Behavior  
Carrier Frequency: 400.1 MHz  
Channel Spacing: 12.5 kHz  
Power: 4 W  
Modulation: Unmodulated  
Description: Switch off condition  $t_3$ ,  $t_{off}$

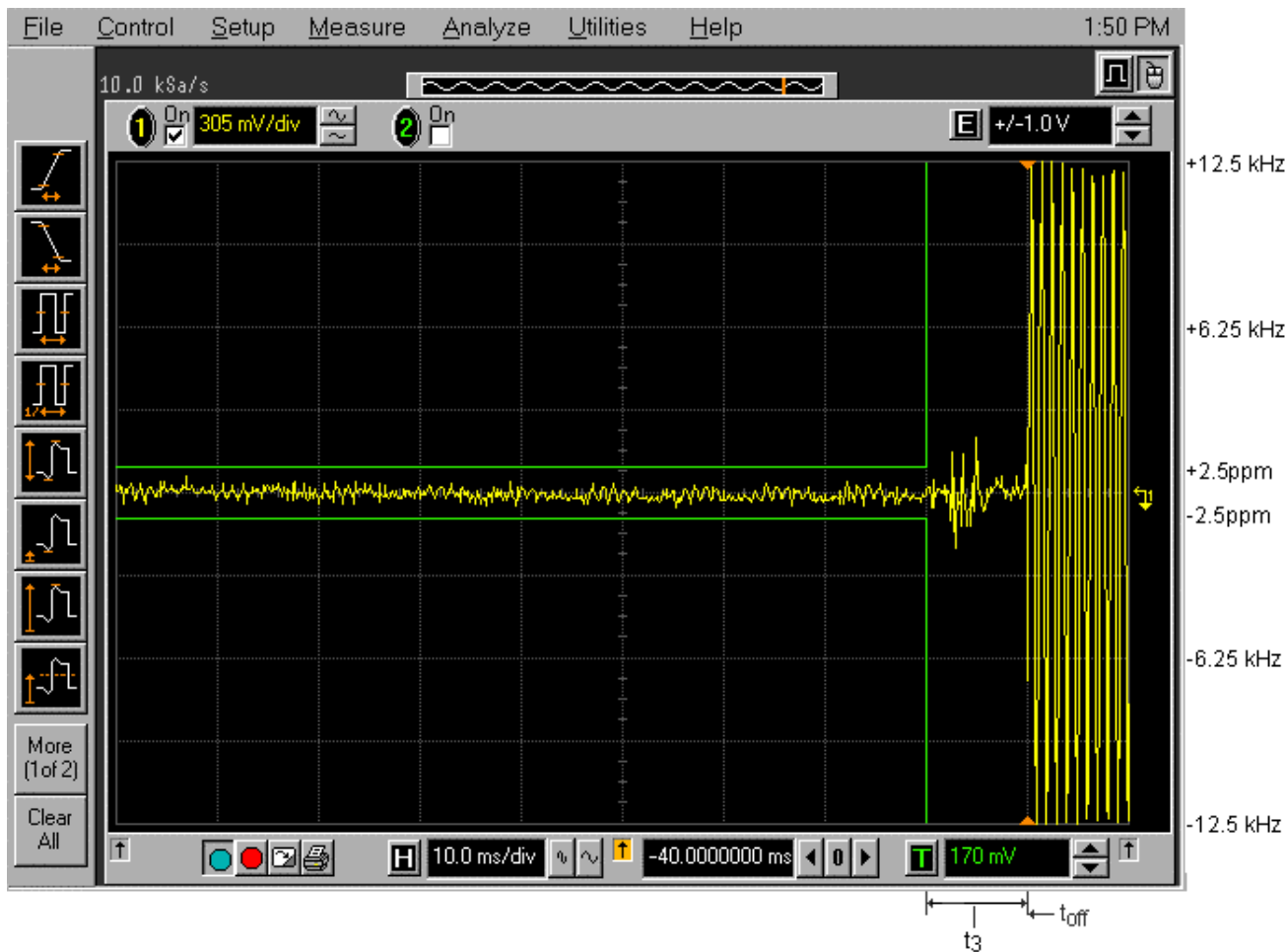

**ULTRATECH GROUP OF LABS**

3000 Bristol Circle, Oakville, Ontario, Canada L6H 6G4  
Tel. #: 905-829-1570, Fax. #: 905-829-8050, Email: [vic@ultratech-labs.com](mailto:vic@ultratech-labs.com), Website: <http://www.ultratech-labs.com>

File #: ICOM-079F90  
March 10, 2004

All test results contained in this engineering test report are traceable to National Institute of Standards and Technology (NIST)

Plot # 57:  
Transient Frequency Behavior  
Carrier Frequency: 400.1 MHz  
Channel Spacing: 12.5 kHz  
Power: 4 W  
Modulation: FM modulation with 2.5 kHz sine wave signal  
Description: Switch on condition  $t_{on}$ ,  $t_1$ , and  $t_2$

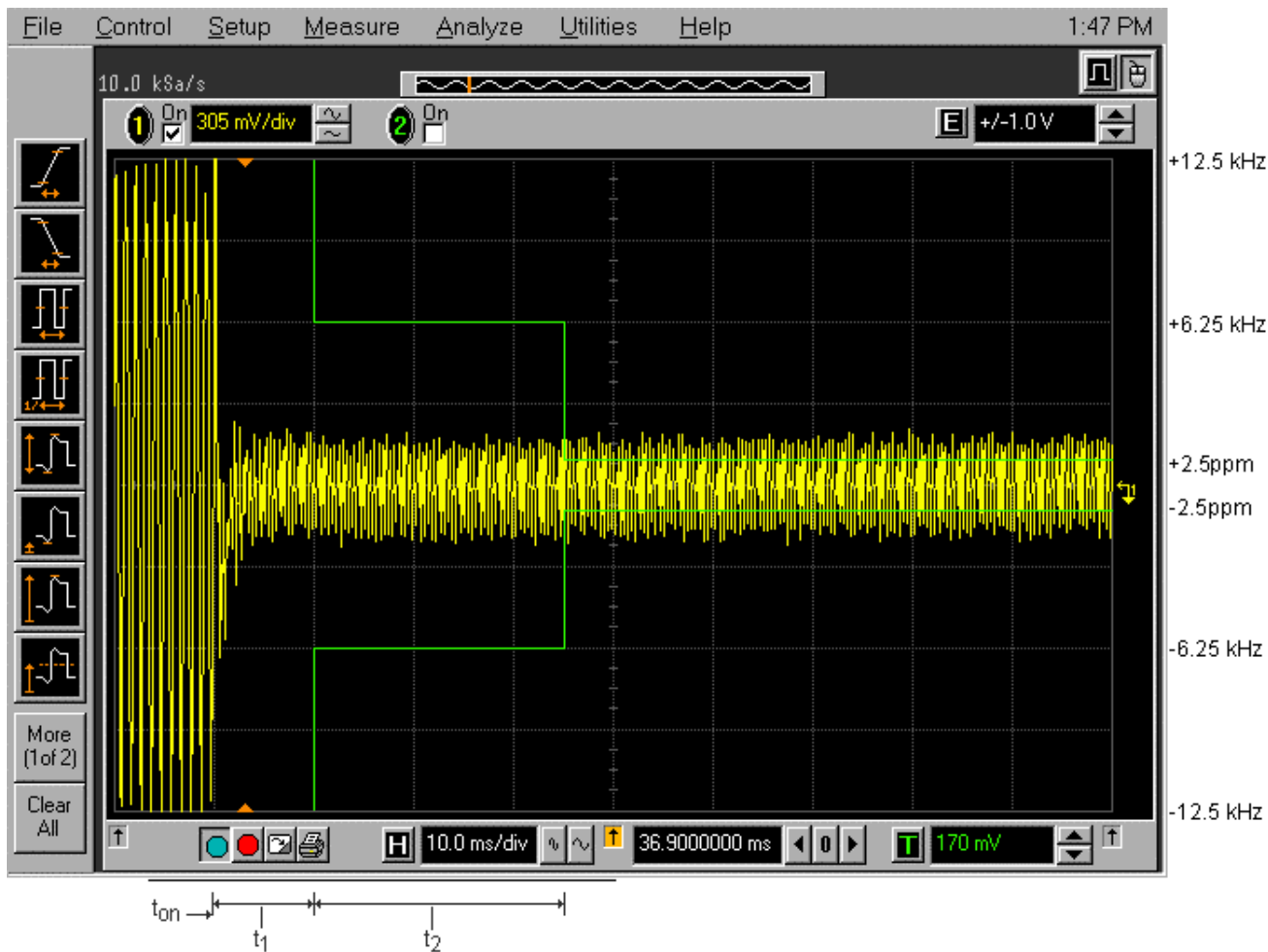

**ULTRATECH GROUP OF LABS**

3000 Bristol Circle, Oakville, Ontario, Canada L6H 6G4  
Tel. #: 905-829-1570, Fax. #: 905-829-8050, Email: [vic@ultratech-labs.com](mailto:vic@ultratech-labs.com), Website: <http://www.ultratech-labs.com>

File #: ICOM-079F90  
March 10, 2004

All test results contained in this engineering test report are traceable to National Institute of Standards and Technology (NIST)



Plot # 58:  
Transient Frequency Behavior  
Carrier Frequency: 400.1 MHz  
Channel Spacing: 12.5 kHz  
Power: 4 W  
Modulation: FM modulation with 2.5 kHz sine wave signal  
Description: Switch off condition  $t_3$ ,  $t_{off}$

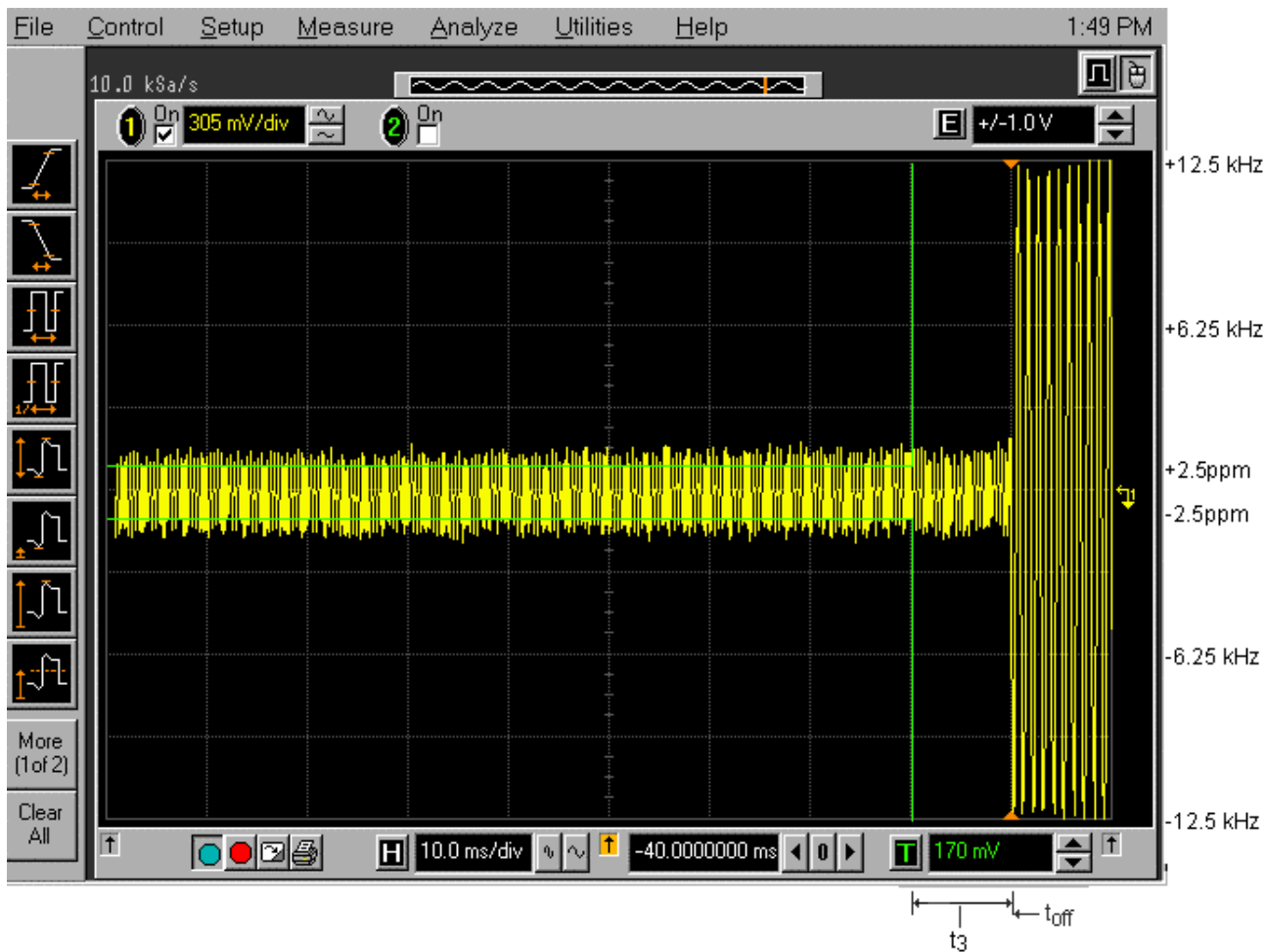

**ULTRATECH GROUP OF LABS**

3000 Bristol Circle, Oakville, Ontario, Canada L6H 6G4  
Tel. #: 905-829-1570, Fax. #: 905-829-8050, Email: [vic@ultratech-labs.com](mailto:vic@ultratech-labs.com), Website: <http://www.ultratech-labs.com>

File #: ICOM-079F90  
March 10, 2004

All test results contained in this engineering test report are traceable to National Institute of Standards and Technology (NIST)

### 6.12.5.2. 25 kHz Channel Spacing Operation

Plot # 59:  
Transient Frequency Behavior  
Carrier Frequency: 400.1 MHz  
Channel Spacing: 25 kHz  
Power: 4 W  
Modulation: Unmodulated  
Description: Switch on condition  $t_{on}$ ,  $t_1$ , and  $t_2$

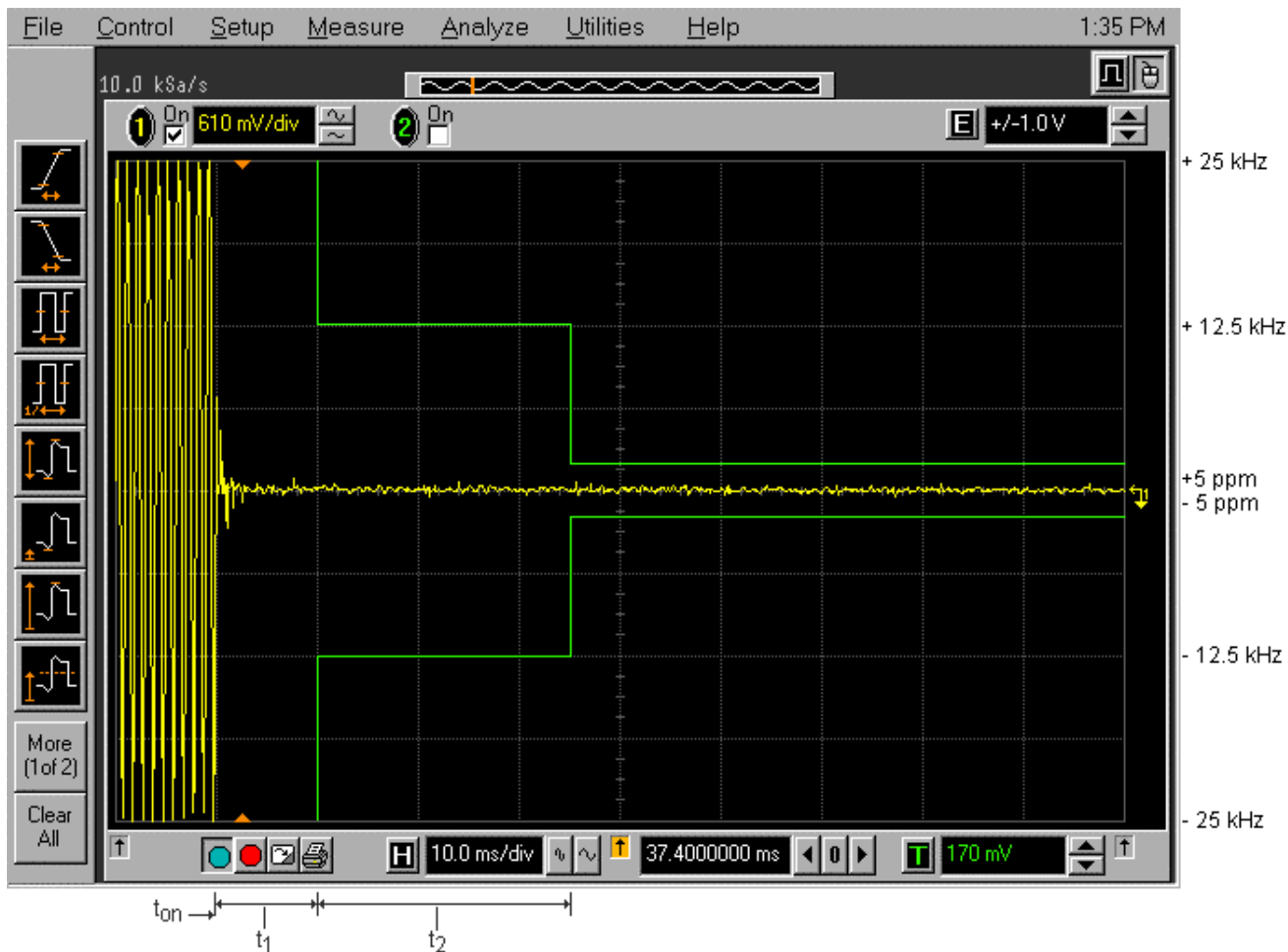

Plot # 60:  
Transient Frequency Behavior  
Carrier Frequency: 400.1 MHz  
Channel Spacing: 25 kHz  
Power: 4 W  
Modulation: Unmodulated  
Description: Switch off condition  $t_3$ ,  $t_{off}$

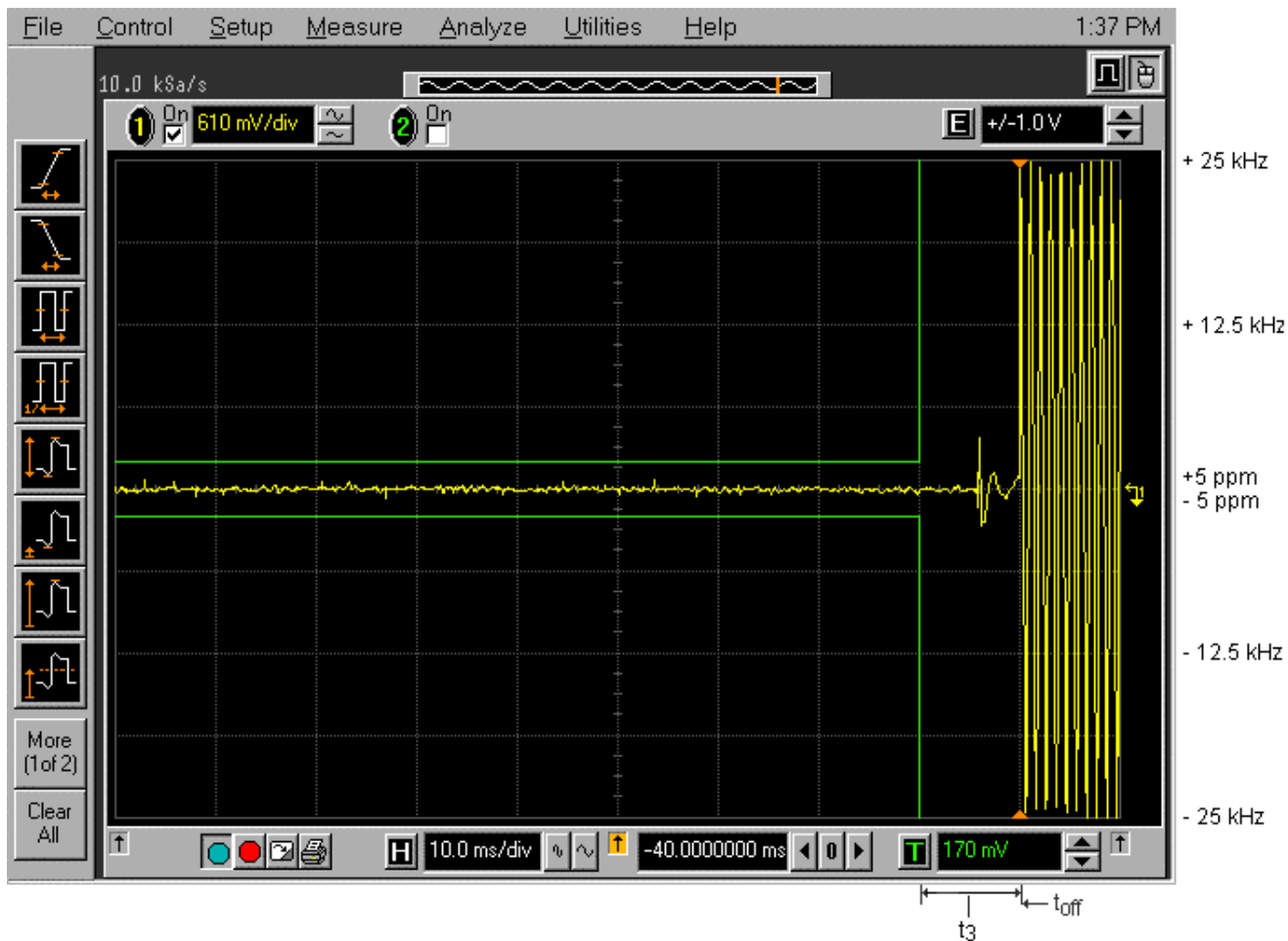

**ULTRATECH GROUP OF LABS**

3000 Bristol Circle, Oakville, Ontario, Canada L6H 6G4  
Tel. #: 905-829-1570, Fax. #: 905-829-8050, Email: [vic@ultratech-labs.com](mailto:vic@ultratech-labs.com), Website: <http://www.ultratech-labs.com>

File #: ICOM-079F90  
March 10, 2004

All test results contained in this engineering test report are traceable to National Institute of Standards and Technology (NIST)

Plot # 61:  
Transient Frequency Behavior  
Carrier Frequency: 400.1 MHz  
Channel Spacing: 25 kHz  
Power: 4 W  
Modulation: FM modulation with 2.5 kHz sine wave signal  
Description: Switch on condition  $t_{on}$ ,  $t_1$ , and  $t_2$

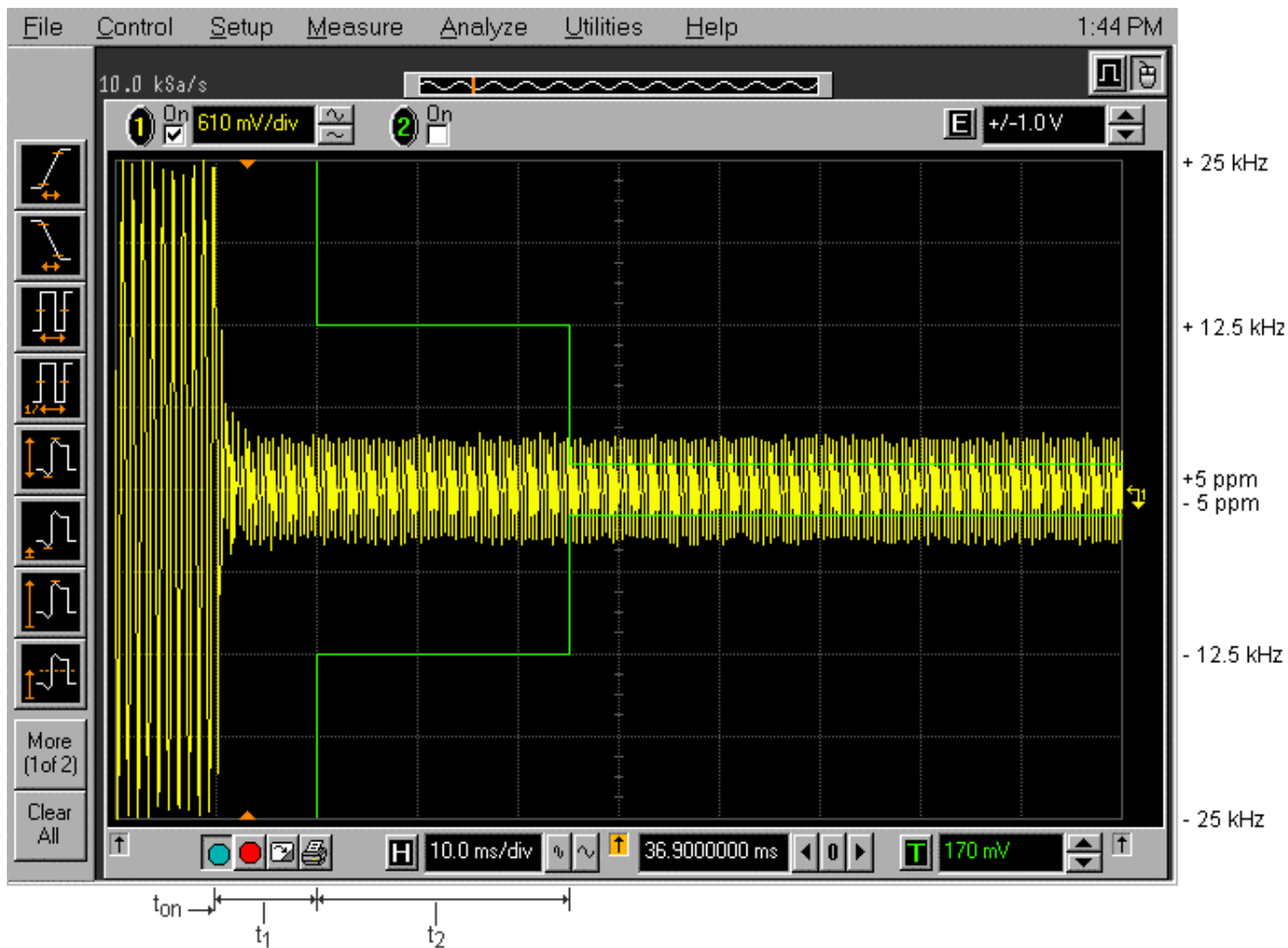

**ULTRATECH GROUP OF LABS**

3000 Bristol Circle, Oakville, Ontario, Canada L6H 6G4  
Tel. #: 905-829-1570, Fax. #: 905-829-8050, Email: [vic@ultratech-labs.com](mailto:vic@ultratech-labs.com), Website: <http://www.ultratech-labs.com>

File #: ICOM-079F90  
March 10, 2004

All test results contained in this engineering test report are traceable to National Institute of Standards and Technology (NIST)

Plot # 62:  
Transient Frequency Behavior  
Carrier Frequency: 400.1 MHz  
Channel Spacing: 25 kHz  
Power: 4 W  
Modulation: FM modulation with 2.5 kHz sine wave signal  
Description: Switch off condition  $t_3$ ,  $t_{off}$



**ULTRATECH GROUP OF LABS**

3000 Bristol Circle, Oakville, Ontario, Canada L6H 6G4  
Tel. #: 905-829-1570, Fax. #: 905-829-8050, Email: [vic@ultratech-labs.com](mailto:vic@ultratech-labs.com), Website: <http://www.ultratech-labs.com>

File #: ICOM-079F90  
March 10, 2004

All test results contained in this engineering test report are traceable to National Institute of Standards and Technology (NIST)

## EXHIBIT 7. MEASUREMENT UNCERTAINTY

The measurement uncertainties stated were calculated in accordance with the requirements of NIST Technical Note 1297 and NIS 81 (1994).

### 7.1. RADIATED EMISSION MEASUREMENT UNCERTAINTY

CONTRIBUTION (Radiated Emissions)	PROBABILITY DISTRIBUTION	UNCERTAINTY (+ dB)	
		3 m	10 m
Antenna Factor Calibration	Normal (k=2)	$\pm 1.0$	$\pm 1.0$
Cable Loss Calibration	Normal (k=2)	$\pm 0.3$	$\pm 0.5$
EMI Receiver specification	Rectangular	$\pm 1.5$	$\pm 1.5$
Antenna Directivity	Rectangular	+0.5	+0.5
Antenna factor variation with height	Rectangular	$\pm 2.0$	$\pm 0.5$
Antenna phase center variation	Rectangular	0.0	$\pm 0.2$
Antenna factor frequency interpolation	Rectangular	$\pm 0.25$	$\pm 0.25$
Measurement distance variation	Rectangular	$\pm 0.6$	$\pm 0.4$
Site imperfections	Rectangular	$\pm 2.0$	$\pm 2.0$
Mismatch: Receiver VRC $\Gamma_1 = 0.2$ Antenna VRC $\Gamma_R = 0.67(Bi) 0.3 (Lp)$ Uncertainty limits $20\text{Log}(1 \pm \Gamma_1 \Gamma_R)$	U-Shaped	+1.1 -1.25	$\pm 0.5$
System repeatability	Std. Deviation	$\pm 0.5$	$\pm 0.5$
Repeatability of EUT		-	-
Combined standard uncertainty	Normal	+2.19 / -2.21	+1.74 / -1.72
Expanded uncertainty U	Normal (k=2)	+4.38 / -4.42	+3.48 / -3.44

Calculation for maximum uncertainty when 3m biconical antenna including a factor of k = 2 is used:

$$U = 2u_c(y) = 2x(+2.19) = +4.38 \text{ dB} \quad \text{And} \quad U = 2u_c(y) = 2x(-2.21) = -4.42 \text{ dB}$$

## EXHIBIT 8. MEASUREMENT METHODS

### 8.1. CONDUCTED POWER MEASUREMENTS

- The following shall be applied to the combination(s) of the radio device and its intended antenna(e).
- If the RF level is user adjustable, all measurements shall be made with the highest power level available to the user for that combination.
- The following method of measurement shall apply to both conducted and radiated measurements.
- The radiated measurements are performed at the Ultratech Calibrated Open Field Test Site.
- The measurement shall be performed using normal operation of the equipment with modulation.

Test procedure shall be as follows:

**Step 1:** Duty Cycle measurements if the transmitter's transmission is transient

- Using a EMI Receiver with the frequency span set to 0 Hz and the sweep time set at a suitable value to capture the envelope peaks and the duty cycle of the transmitter output signal;
- The duty cycle of the transmitter,  $x = T_x \text{ on} / (T_x \text{ on} + T_x \text{ off})$  with  $0 < x < 1$ , is measure and recorded in the test report. For the purpose of testing, the equipment shall be operated with a duty cycle that is equal or more than 0.1.

**Step 2:** Calculation of Average EIRP. See Figure 1

- The average output power of the transmitter shall be determined using a wideband, calibrated RF average power meter with the power sensor with an integration period that exceeds the repetition period of the transmitter by a factor 5 or more. The observed value shall be recorded as "A" (in dBm);
- The e.i.r.p. shall be calculated from the above measured power output "A", the observed duty cycle x, and the applicable antenna assembly gain "G" in dBi, according to the formula:

$$\text{EIRP} = \text{A} + \text{G} + 10\log(1/x)$$

{X = 1 for continuous transmission =>  $10\log(1/x) = 0 \text{ dB}$ }

**Figure 1.**

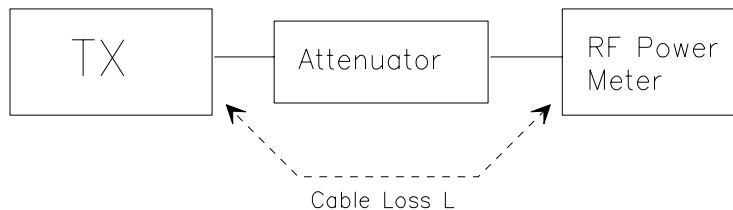

## 8.2. RADIATED POWER MEASUREMENTS (ERP & EIRP) USING SUBSTITUTION METHOD

### 8.2.1. MAXIMIZING RF EMISSION LEVEL (E-FIELD)

- (a) The measurements were performed with full rf output power and modulation.
- (b) Test was performed at listed 3m open area test site (listed with FCC, IC, ITI, NVLAP, ACA & VCCI).
- (c) The transmitter under test was placed at the specified height on a non-conducting turntable (80 cm height)
- (d) The BICONILOG antenna (20 MHz to 1 GHz) or HORN antenna (1 GHz to 18 GHz) was used for measuring.
- (e) Load an appropriate correction factors file in EMI Receiver for correcting the field strength reading level

Total Correction Factor recorded in the EMI Receiver = Cable Loss + Antenna Factor  
 $E \text{ (dB}\mu\text{V/m)} = \text{Reading (dB}\mu\text{V)} + \text{Total Correction Factor (dB/m)}$

- (f) Set the EMI Receiver and #2 as follows:

Center Frequency: test frequency  
Resolution BW: 100 kHz  
Video BW: same  
Detector Mode: positive  
Average: off  
Span: 3 x the signal bandwidth

- (g) The test antenna was lowered or raised from 1 to 4 meters until the maximum signal level was detected.
- (h) The transmitter was rotated through  $360^\circ$  about a vertical axis until a higher maximum signal was received.
- (i) The test antenna was lowered or raised again from 1 to 4 meters until a maximum was obtained. This level was recorded.
- (j) The recorded reading was corrected to the true field strength level by adding the antenna factor, cable loss and subtracting the pre-amplifier gain.
- (k) The above steps were repeated with both transmitters' antenna and test receiving antenna placed in vertical and horizontal polarization. Both readings with the antennas placed in vertical and horizontal polarization shall be recorded.
- (l) Repeat for all different test signal frequencies.



### 8.2.2. Measuring the EIRP of Spurious/Harmonic Emissions using Substitution Method

- (a) Set the EMI Receiver (for measuring E-Field) and Receiver #2 (for measuring EIRP) as follows:

Center Frequency: equal to the signal source  
Resolution BW: 10 kHz  
Video BW: same  
Detector Mode: positive  
Average: off  
Span: 3 x the signal bandwidth

- (b) Load an appropriate correction factors file in EMI Receiver for correcting the field strength reading level

Total Correction Factor recorded in the EMI Receiver = Cable Loss + Antenna Factor  
 $E \text{ (dBuV/m)} = \text{Reading (dBuV)} + \text{Total Correction Factor (dB/m)}$

- (c) Select the frequency and E-field levels obtained in the Section 8.2.1 for ERP/EIRP measurements.  
(d) Substitute the EUT by a signal generator and one of the following transmitting antenna (substitution antenna):
  - ◆ DIPOLE antenna for frequency from 30-1000 MHz or
  - ◆ HORN antenna for frequency above 1 GHz }.(e) Mount the transmitting antenna at 1.5 meter high from the ground plane.  
(f) Use one of the following antenna as a receiving antenna:
  - ◆ DIPOLE antenna for frequency from 30-1000 MHz or
  - ◆ HORN antenna for frequency above 1 GHz }.(g) If the DIPOLE antenna is used, tune it's elements to the frequency as specified in the calibration manual.  
(h) Adjust both transmitting and receiving antenna in a VERTICAL polarization.  
(i) Tune the EMI Receivers to the test frequency.  
(j) Lower or raise the test antenna from 1 to 4 meters until the maximum signal level was detected.  
(k) The transmitter was rotated through 360° about a vertical axis until a higher maximum signal was received.  
(l) Lower or raise the test antenna from 1 to 4 meters until the maximum signal level was detected.  
(m) Adjust input signal to the substitution antenna until an equal or a known related level to that detected from the transmitter was obtained in the test receiver.  
(n) Record the power level read from the Average Power Meter and calculate the ERP/EIRP as follows:

$$P = P1 - L1 = (P2 + L2) - L1 = P3 + A + L2 - L1$$

$$EIRP = P + G1 = P3 + L2 - L1 + A + G1$$

$$ERP = EIRP - 2.15 \text{ dB}$$

$$\text{Total Correction factor in EMI Receiver \# 2} = L2 - L1 + G1$$

Where: P: Actual RF Power fed into the substitution antenna port after corrected.  
P1: Power output from the signal generator  
P2: Power measured at attenuator A input  
P3: Power reading on the Average Power Meter  
EIRP: EIRP after correction  
ERP: ERP after correction

- (o) Adjust both transmitting and receiving antenna in a HORIZONTAL polarization, then repeat step (k) to (o)  
(p) Repeat step (d) to (o) for different test frequency  
(q) Repeat steps (c) to (j) with the substitution antenna oriented in horizontal polarization.  
(r) Actual gain of the EUT's antenna is the difference of the measured EIRP and measured RF power at the RF port. Correct the antenna gain if necessary.

Figure 2

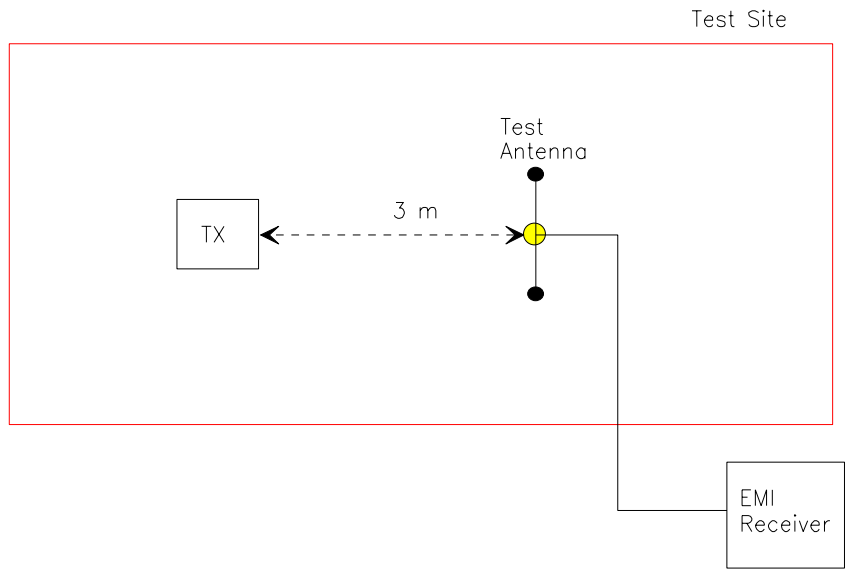
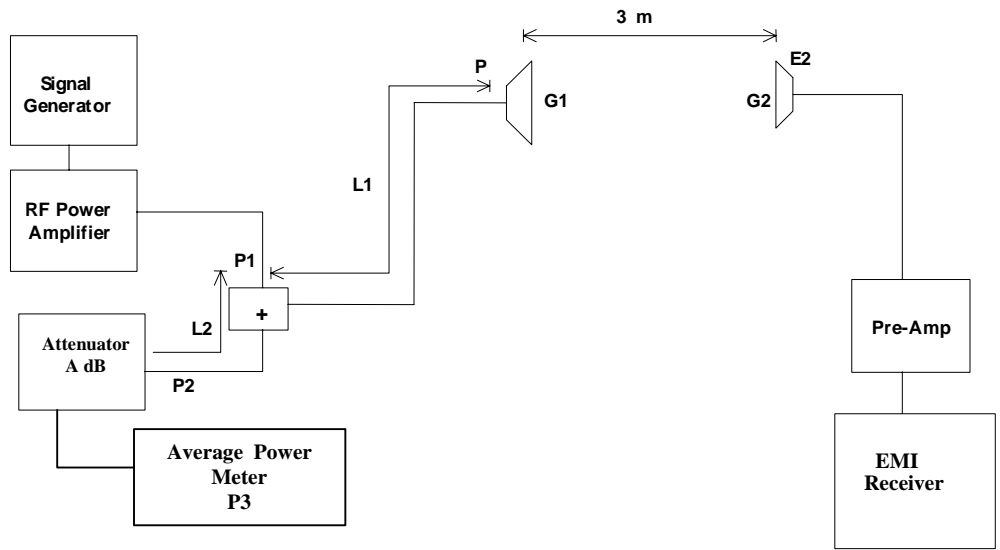

Figure 3



### 8.3. FREQUENCY STABILITY

Refer to FCC @ 2.1055.

- (a) The frequency stability shall be measured with variation of ambient temperature as follows: From -30 to +50 centigrade except that specified in subparagraph (2) & (3) of this paragraph.
- (b) Frequency measurements shall be made at extremes of the specified temperature range and at intervals of not more than 10 centigrade through the range. A period of time sufficient to stabilize all of the components of the oscillator circuit at each temperature level shall be allowed prior to frequency measurement. The short-term transient effects on the frequency of the transmitter due to keying (except for broadcast transmitters) and any heating element cycling normally occurring at each ambient temperature level also shall be shown. Only the portion or portions of the transmitter containing the frequency determining and stability circuitry need be subjected to the temperature variation test.
- (d) The frequency stability supply shall be measured with variation of primary supply voltage as follows:
  - (1) Vary primary supply voltage from 85 to 115 percent of the nominal value for other than hand carried battery equipment.
  - (2) For hand carried, battery powered equipment, reduce primary supply voltage to the battery operating end point which shall be specified by the manufacturer.
  - (3) The supply voltage shall be measured at the input to the cable normally provide with the equipment, or at the power supply terminals if cables are not normally provided. Effects on frequency of transmitter keying (except for broadcast transmitters) and any heating element cycling at the nominal supply voltage and at each extreme also shall be shown.
- (e) When deemed necessary, the Commission may require tests of frequency stability under conditions in addition to those specifically set out in paragraphs (a), (b), (c) and (d) of this section. (For example, measurements showing the effect of proximity to large metal objects, or of various types of antennas, may be required for portable equipment).

## 8.4. EMISSION MASK

**Voice or Digital Modulation Through a Voice Input Port @ 2.1049(c)(i)**:- The transmitter was modulated by a 2.5 KHz tone signal at an input level 16 dB greater than that required to produce 50% modulation (e.g.:  $\pm 2.5$  KHz peak deviation at 1 KHz modulating frequency). The input level was established at the frequency of maximum response of the audio modulating circuit.

**Digital Modulation Through a Data Input Port @ 2.1049(h)**:- Transmitters employing digital modulation techniques - when modulated by an input signal such that its amplitude and symbol rate represent the maximum rated conditions under which the equipment will be operated. The signal shall be applied through any filter networks, pseudo-random generators or other devices required in normal service. Additionally, the Emission Masks shall be shown for operation with any devices used for modifying the spectrum when such devices are operational at the discretion of the user.

The following EMI Receiver bandwidth shall be used for measurement of Emission Mask/Out-of-Band Emission Measurements:

- (1) For 25 kHz Channel Spacing: RBW = 300 Hz
- (2) For 12.5 kHz or 6.25 kHz Channel Spacings: RBW = 100 Hz

The all cases the Video Bandwidth shall be equal or greater than the measuring bandwidth.

## 8.5. SPURIOUS EMISSIONS (CONDUCTED)

With transmitter modulation characteristics described in Out-of-Band Emissions measurements @ 2.1049, the transmitter spurious and harmonic emissions were scanned. The spurious and harmonic emissions were measured with the EMI Receiver controls set as RBW = 30 kHz minimum , VBW  $\geq$  RBW and SWEEP TIME = AUTO). The transmitter was operated at a full rated power output, and modulated as follows:

**FCC 47 CFR 2.1057 - Frequency spectrum to be investigated:** The spectrum was investigated from the lowest radio generated in the equipment up to at least the 10<sup>th</sup> harmonic of the carrier frequency or to the highest frequency practicable in the present state of the art of measuring techniques, whichever is lower. Particular attention should be paid to harmonics and subharmonics of the carrier frequency. Radiation at the frequencies of multiplier stages should be checked. The amplitude of spurious emissions which are attenuated more than 20 dB below the permissible value need not be reported.

**FCC 47 CFR 2.1051 - Spurious Emissions at Antenna Terminal:** The radio frequency voltage or powers generated within the equipment and appearing on a spurious frequency shall be checked at the equipment output terminals when properly loaded with a suitable artificial antenna. Curves or equivalent data shall show the magnitude of the harmonic and other spurious emission that can be detected when the equipment is operated under the conditions specified in 2.1049 as appropriate. The magnitude of spurious emissions, which are attenuated more than 20 dB below the permissible value, need not be specified.

## 8.6. TRANSIENT FREQUENCY BEHAVIOR

1. Connect the transmitter under tests as shown in the above block diagram
2. Set the signal generator to the assigned frequency and modulate with a 1 kHz tone at  $\pm 12.5$  kHz deviation and its output level to be 50 dB below the transmitter rf output at the test receiver end.
3. Set the horizontal sweep rate on the storage scope to 10 milliseconds per division and adjust the display to continuously view the 1000 Hz tone from the Demodulator Output Port (DOP) of the Test Receiver. Adjust the vertical scale amplitude control of the scope to display the 1000 Hz at  $\pm 4$  divisions vertical Center at the display.
4. Adjust the scope so it will trigger on an increasing magnitude from the RF trigger signal of the transmitter under test when the transmitter was turned on. Set the controls to store the display.
5. The output at the DOP, due to the change in the ratio of the power between the signal generator input power and transmitter output power will, because of the capture effect of the test receiver, produce a change in display: For the first part of the sweep it will show the 1 kHz test signal. Then once the receiver's demodulator has been captured by the transmitter power, the display will show the frequency difference from the assigned frequency to the actual transmitter frequency versus time. The instant when the 1 kHz test signal is completely suppressed (including any capture time due to phasing) is considered to be  $t_{on}$ . The trace should be maintained within the allowed divisions during the period  $t_1$  and  $t_2$ .
6. During the time from the end of  $t_2$  to the beginning of  $t_3$  the frequency difference should not exceed the limits set by the FCC in Part 90.214 and the outlined in the Carrier Frequency Stability sections. The allowed limit is equal to FCC frequency tolerance limits specified in FCC 90.213.
7. Repeat the above steps when the transmitter was turned off for measuring  $t_3$ .