

ENGINEERING TEST REPORT

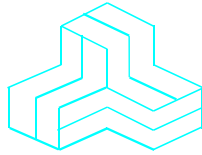

VHF Marine Transceiver Model No.: IC-M502A

FCC ID: AFJ269700

Applicant:

Icom Incorporated
1-1-32, Kamiminami, Hirano-ku
Osaka
Japan, 547-0003

Tested in Accordance With

**Federal Communications Commission (FCC)
47 CFR Parts 2 and 80 (Marine in 156.025-157.425 MHz)**

UltraTech's File No.: ICOM-071F80

This Test report is Issued under the Authority of
Tri M. Luu, Professional Engineer,
Vice President of Engineering
UltraTech Group of Labs

Date: October 7, 2003



Report Prepared by: Dan Huynh

Tested by: Wayne Wu, RFI/EMI Technician

Issued Date: October 7, 2003

Test Dates: September 4-18, 2003

- *The results in this Test Report apply only to the sample(s) tested, and the sample tested is randomly selected.*
- *This report must not be used by the client to claim product endorsement by NVLAP or any agency of the US Government.*

UltraTech

3000 Bristol Circle, Oakville, Ontario, Canada, L6H 6G4
Tel.: (905) 829-1570 Fax.: (905) 829-8050
Website: www.ultratech-labs.com, Email: vic@ultratech-labs.com, Email: tri@ultratech-labs.com



TABLE OF CONTENTS

EXHIBIT 1.	SUBMITTAL CHECK LIST	1
EXHIBIT 2.	INTRODUCTION.....	2
2.1.	SCOPE	2
2.2.	RELATED SUBMITTAL(S)/GRANT(S).....	2
2.3.	NORMATIVE REFERENCES	2
EXHIBIT 3.	PERFORMANCE ASSESSMENT	3
3.1.	CLIENT INFORMATION	3
3.2.	EQUIPMENT UNDER TEST (EUT) INFORMATION.....	3
3.3.	EUT'S TECHNICAL SPECIFICATIONS	4
3.4.	LIST OF EUT'S PORTS.....	5
3.5.	ANCILLARY EQUIPMENT	5
EXHIBIT 4.	EUT OPERATING CONDITIONS AND CONFIGURATIONS DURING TESTS.....	6
4.1.	CLIMATE TEST CONDITIONS	6
4.2.	OPERATIONAL TEST CONDITIONS & ARRANGEMENT FOR TEST SIGNALS	6
EXHIBIT 5.	SUMMARY OF TEST RESULTS.....	7
5.1.	LOCATION OF TESTS.....	7
5.2.	APPLICABILITY & SUMMARY OF EMC EMISSION TEST RESULTS	7
5.3.	MODIFICATIONS INCORPORATED IN THE EUT FOR COMPLIANCE PURPOSES.....	7
5.4.	DEVIATION OF STANDARD TEST PROCEDURES	7
EXHIBIT 6.	MEASUREMENTS, EXAMINATIONS & TEST DATA FOR EMC EMISSIONS	8
6.1.	TEST PROCEDURES	8
6.2.	MEASUREMENT UNCERTAINTIES	8
6.3.	MEASUREMENT EQUIPMENT USED	8
6.4.	ESSENTIAL/PRIMARY FUNCTIONS AS DECLARED BY THE MANUFACTURER	8
6.5.	RF POWER OUTPUT [§§ 2.1046 & 80.215]	9
6.6.	EXPOSURE OF HUMANS TO RADIO FREQUENCY FIELDS [§ 2.1091]	10
6.7.	FREQUENCY STABILITY [§§ 2.1055, 80.209]	12
6.8.	AUDIO FREQUENCY RESPONSE [§§ 2.1047(A) & 80.213]	14
6.9.	MODULATION LIMITING [§ 2.1047(B)]	17
6.10.	EMISSION MASK [§§ 2.1049 AND 80.211(F)]	20
6.11.	TRANSMITTER ANTENNA POWER SPURIOUS/HARMONIC CONDUCTED EMISSIONS [§ 80.211(F)]	33
6.12.	TRANSMITTER SPURIOUS/HARMONIC RADIATED EMISSIONS [§ 80.211(F)]	42
EXHIBIT 7.	MEASUREMENT UNCERTAINTY	44
7.1.	RADIATED EMISSION MEASUREMENT UNCERTAINTY	44
EXHIBIT 8.	MEASUREMENT METHODS.....	45
8.1.	CONDUCTED POWER MEASUREMENTS	45
8.2.	RADIATED POWER MEASUREMENTS (ERP & EIRP) USING SUBSTITUTION METHOD.....	46
8.3.	FREQUENCY STABILITY	49
8.4.	EMISSION MASK	50
8.5.	SPURIOUS EMISSIONS (CONDUCTED).....	50

EXHIBIT 1. SUBMITTAL CHECK LIST

Annex No.	Exhibit Type	Description of Contents	Quality Check (OK)
--	Test Report	<ul style="list-style-type: none"> ▪ Exhibit 1: Submittal check lists ▪ Exhibit 2: Introduction ▪ Exhibit 3: Performance Assessment ▪ Exhibit 4: EUT Operation and Configuration during Tests ▪ Exhibit 5: Summary of test Results ▪ Exhibit 6: Measurement Data ▪ Exhibit 7: Measurement Uncertainty ▪ Exhibit 8: Measurement Methods 	OK
1	Test Setup Photos	Radiated Emissions Setup Photos	OK
2	External EUT Photos	External EUT Photos	OK
3	Internal EUT Photos	Internal EUT Photos	OK
4	Cover Letters	<ul style="list-style-type: none"> ▪ Letter from Ultratech for Certification Request ▪ Letter from the Applicant to appoint Ultratech to act as an agent ▪ Letter from the Applicant to request for Confidentiality Filing 	OK
5	Attestation Statements	Part 80.203 (b) 3	OK
6	ID Label/Location Info	ID Label and Location of ID Label	OK
7	Block Diagrams	Block Diagram	OK
8	Schematic Diagrams	Schematic	OK
9	Parts List/Tune Up Info	Parts List/Tune Up Info	OK
10	Operational Description	Operational Description	OK
11	RF Exposure Info	See section 6.6 of this test report for MPE evaluation.	OK
12	User's Manual	Instruction Manual	OK

ULTRATECH GROUP OF LABS

3000 Bristol Circle, Oakville, Ontario, Canada L6H 6G4
Tel. #: 905-829-1570, Fax. #: 905-829-8050, Email: vic@ultratech-labs.com, Website: http://www.ultratech-labs.com

File #: ICOM-071F80
October 7, 2003

All test results contained in this engineering test report are traceable to National Institute of Standards and Technology (NIST)

EXHIBIT 2. INTRODUCTION

2.1. SCOPE

Reference:	FCC Parts 2 and 80
Title:	Telecommunication – 47 Code of Federal Regulations (CFR), Parts 2 & 80
Purpose of Test:	To gain FCC Certification Authorization for Radio operating in the frequency bands
Test Procedures:	Both conducted and radiated emissions measurements were conducted in accordance with American National Standards Institute ANSI C63.4 - American National Standard for Methods of Measurement of Radio-Noise Emissions from Low-Voltage Electrical and Electronic Equipment in the Range of 9 kHz to 40 GHz.
Categories of Station:	Ship Station in 156.025-157.425 MHz

2.2. RELATED SUBMITTAL(S)/GRANT(S)

None.

2.3. NORMATIVE REFERENCES

Publication	Year	Title
FCC CFR Parts 0-19, 80-End	2002	Code of Federal Regulations – Telecommunication
ANSI C63.4	1992	American National Standard for Methods of Measurement of Radio-Noise Emissions from Low-Voltage Electrical and Electronic Equipment in the Range of 9 kHz to 40 GHz
CISPR 22 & EN 55022	1997 1998	Limits and Methods of Measurements of Radio Disturbance Characteristics of Information Technology Equipment
CISPR 16-1	1999	Specification for Radio Disturbance and Immunity measuring apparatus and methods

ULTRATECH GROUP OF LABS

3000 Bristol Circle, Oakville, Ontario, Canada L6H 6G4
Tel. #: 905-829-1570, Fax. #: 905-829-8050, Email: vic@ultratech-labs.com, Website: http://www.ultratech-labs.com

File #: ICOM-071F80
October 7, 2003

All test results contained in this engineering test report are traceable to National Institute of Standards and Technology (NIST)

EXHIBIT 3. PERFORMANCE ASSESSMENT

3.1. CLIENT INFORMATION

APPLICANT	
Name:	Icom Incorporated
Address:	1-1-32, Kamiminami, Hirano-ku Oaska Japan, 547-0003
Contact Person:	Mr. Takashi Aoki Phone #: +81-66-793-5302 Fax #: +81-66-793-0013 Email Address: export@icom.co.jp

MANUFACTURER	
Name:	Icom Incorporated
Address:	1-1-32, Kamiminami, Hirano-ku Oaska Japan, 547-0003
Contact Person:	Mr. Takashi Aoki Phone #: +81-66-793-5302 Fax #: +81-66-793-0013 Email Address: export@icom.co.jp

3.2. EQUIPMENT UNDER TEST (EUT) INFORMATION

The following information (with the exception of the Date of Receipt) has been supplied by the applicant.

Brand Name:	ICOM Incorporated
Product Name:	VHF Marine Transceiver
Model Name or Number:	IC-M502A
Serial Number:	0000003
Type of Equipment:	Licensed Non-broadcast Station Transmitter
Power Supply Requirement:	13.8 VDC
Transmitting/Receiving Antenna Type:	Non-integral
Primary User Functions of EUT:	Voice wireless communication for marine ship station.

ULTRATECH GROUP OF LABS

3000 Bristol Circle, Oakville, Ontario, Canada L6H 6G4
Tel. #: 905-829-1570, Fax. #: 905-829-8050, Email: vic@ultratech-labs.com, Website: <http://www.ultratech-labs.com>

File #: ICOM-071F80
October 7, 2003

All test results contained in this engineering test report are traceable to National Institute of Standards and Technology (NIST)

3.3. EUT'S TECHNICAL SPECIFICATIONS

TRANSMITTER	
Equipment Type:	Mobile
Intended Operating Environment:	Marine Ship Station
Power Supply Requirement:	13.8 VDC
RF Output Power Rating:	25 Watts (High) and 1 Watt (Low)
Operating Frequency Range:	156.025-157.425 MHz
RF Output Impedance:	50 Ohms
Channel Spacing:	25 kHz
Emission Designation*:	16K0G3E, 16K0G2B
Antenna Connector Type:	N

* For an average case of commercial telephony, the Necessary Bandwidth is calculated as follows:

For FM Voice Modulation:

Channel Spacing = 25 KHz, D = 5 KHz max., K = 1, M = 3 KHz

$$B_n = 2M + 2DK = 2(3) + 2(5)(1) = \mathbf{16\ KHz}$$

Emission Designation: 16K0G3E and 16K0G2B

RECEIVER	
Operating Frequency Range:	156.050-163.275 MHz
RF Input Impedance:	50 Ohms
Channel Spacing:	25 kHz
IF Frequencies	21.7MHz, 450 kHz
Audio Output Power	4.5 W (typical)
Audio Output Impedance:	4 Ohms

3.4. LIST OF EUT'S PORTS

Port Number	EUT's Port Description	Number of Identical Ports	Connector Type	Cable Type (Shielded/Non-shielded)
1	DC Power Connector	1	Wireleads	Non-shielded
2	External Microphone Jack	1	8-Pin CPC	Non-shielded
3	Antenna Connector	1	PL-259	Shielded
4	NMEA IN (Red) JACK	1	RCA	Non-shielded
5	NMEA OUT (White) JACKS	1	RCA	Non-shielded
6	External Speaker Jack	1	Plug-In Jack	Non-shielded

3.5. ANCILLARY EQUIPMENT

None.

EXHIBIT 4. EUT OPERATING CONDITIONS AND CONFIGURATIONS DURING TESTS

4.1. CLIMATE TEST CONDITIONS

The climate conditions of the test environment are as follows:

Temperature:	21°C
Humidity:	51%
Pressure:	102 kPa
Power input source:	13.8 VDC

4.2. OPERATIONAL TEST CONDITIONS & ARRANGEMENT FOR TEST SIGNALS

Operating Modes:	The transmitter was operated in a continuous transmission mode with the carrier modulated as specified in the Test Data.
Special Test Software:	N/A
Special Hardware Used:	N/A
Transmitter Test Antenna:	The EUT is tested with the transmitter antenna port terminated to a 50 Ohms RF Load.

Transmitter Test Signals	
Frequency Band(s):	156.025-157.425 MHz
Test Frequency:	<ul style="list-style-type: none">▪ 156.050 MHz▪ 157.425 MHz
Transmitter Wanted Output Test Signals:	
<ul style="list-style-type: none">▪ Transmitter Power (measured maximum output power):	25 Watts High & 1 Watt Low
<ul style="list-style-type: none">▪ Normal Test Modulation:	FM, DSC
<ul style="list-style-type: none">▪ Modulating signal source:	External

EXHIBIT 5. SUMMARY OF TEST RESULTS

5.1. LOCATION OF TESTS

All of the measurements described in this report were performed at Ultratech Group of Labs located in the city of Oakville, Province of Ontario, Canada.

- AC Power Line Conducted Emissions were performed in UltraTech's shielded room, 24'(L) by 16'(W) by 8'(H).
- Radiated Emissions were performed at the Ultratech's 3 Meter Open Field Test Site (OFTS) situated in the Town of Oakville, province of Ontario.

The above sites have been calibrated in accordance with ANSI C63.4, and found to be in compliance with the requirements of Sec. 2.948 of the FCC Rules. The descriptions and site measurement data of the Oakville Open Field Test Site has been filed with FCC office (FCC File No.: 31040/SIT 1300B3) and Industry Canada office (Industry Canada File No.: IC2049). Last Date of Site Calibration: Aug. 10, 2002.

5.2. APPLICABILITY & SUMMARY OF EMC EMISSION TEST RESULTS

FCC Section(s)	Test Requirements	Applicability (Yes/No)
80.215 & 2.1046	RF Power Output	Yes
1.1307, 1.1310, 2.1091 & 2.1093	RF Exposure Limit	Yes
80.209 & 2.1055	Frequency Stability	Yes
80.213 & 2.1047(a)	Audio Frequency Response	Yes
2.1047(b)	Modulation Limiting	Yes
80.211 & 2.1049	Emission Limitation / Emission Mask	Yes
80.211, 2.1057 & 2.1051	Emission Limits - Spurious Emissions at Antenna Terminal	Yes
80.211, 2.1057 & 2.1053	Emission Limits - Field Strength of Spurious Emissions	Yes
80.217	Suppression of Interference aboard ships	Yes

VHF MARINE TRANSCEIVER, Model No.: IC-M502A by **ICOM Incorporated** has also been tested and found to comply with **FCC Part 15, Subpart B - Radio Receivers and Class A Digital Devices**. The engineering test report has been documented and kept in file and it is available upon FCC request.

5.3. MODIFICATIONS INCORPORATED IN THE EUT FOR COMPLIANCE PURPOSES

None.

5.4. DEVIATION OF STANDARD TEST PROCEDURES

None.

ULTRATECH GROUP OF LABS

3000 Bristol Circle, Oakville, Ontario, Canada L6H 6G4
Tel. #: 905-829-1570, Fax. #: 905-829-8050, Email: vic@ultratech-labs.com, Website: http://www.ultratech-labs.com

File #: ICOM-071F80
October 7, 2003

All test results contained in this engineering test report are traceable to National Institute of Standards and Technology (NIST)

EXHIBIT 6. MEASUREMENTS, EXAMINATIONS & TEST DATA FOR EMC EMISSIONS

6.1. TEST PROCEDURES

This section contains test results only. Details of test methods and procedures can be found in Exhibit 8 of this report.

6.2. MEASUREMENT UNCERTAINTIES

The measurement uncertainties stated were calculated in accordance with requirements of UKAS Document NIS 81 with a confidence level of 95%. Please refer to Exhibit 7 for Measurement Uncertainties.

6.3. MEASUREMENT EQUIPMENT USED

The measurement equipment used complied with the requirements of the Standards referenced in the Methods & Procedures ANSI C63.4:1992 and CISPR 16-1.

6.4. ESSENTIAL/PRIMARY FUNCTIONS AS DECLARED BY THE MANUFACTURER

The essential function of the EUT is to correctly communicate data to and from radios over RF link.

6.5. RF POWER OUTPUT [§§ 2.1046 & 80.215]

6.5.1. Limits

FCC § 80.215:

- **Coast Stations in 156.025-157.425 MHz:** 50 Watts (at the input terminal of the station antenna). The frequencies 156.375 and 156.65 are primarily intership frequencies. When authorized for coast station on secondary basis, the normal output power must not exceed 1 Watt and the maximum output power must not exceed 10 Watts.
- **Marine Utility Stations & Handheld Portable in 156.025-157.425 MHz:** 10 Watts (at the input terminal of the station antenna)
- **Ship Stations in 156.025-157.425 MHz:** 25 Watts (at the input terminal of the station antenna)

6.5.2. Method of Measurements

Please refer to Exhibit 8, § 8.1 (Conducted) and/or § 8.2 (Radiated) for test procedures and test setup.

6.5.3. Test Equipment List

Test Instruments	Manufacturer	Model No.	Serial No.	Frequency Range
Attenuator	Weinschel Corp	24-20-34	BJ2364	DC – 8.5 GHz
Power Meter	Hewlett Packard	436A	1725A02249	10 kHz – 50 GHz, sensor dependent
Power Sensor	Hewlett Packard	8481A	2702A68983	10 MHz – 18 GHz

6.5.4. Test Arrangement

Power at RF Power Output Terminals

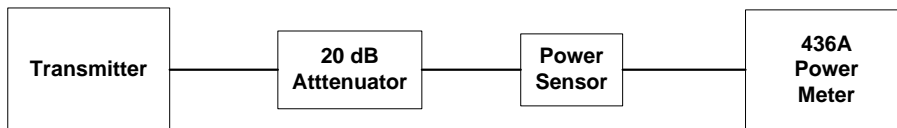

6.5.5. Test Data

Transmitter Channel Output	Fundamental Frequency (MHz)	Measured (Average) Conducted Power (Watts)	Power Rating (Watts)
Power Setting: High			
Lowest	156.050	24.7	25
Highest	157.425	24.6	25
Power Setting: Low			
Lowest	156.050	0.8	1
Highest	157.425	0.8	1

ULTRATECH GROUP OF LABS

3000 Bristol Circle, Oakville, Ontario, Canada L6H 6G4
Tel. #: 905-829-1570, Fax. #: 905-829-8050, Email: vic@ultratech-labs.com, Website: http://www.ultratech-labs.com

File #: ICOM-071F80
October 7, 2003

All test results contained in this engineering test report are traceable to National Institute of Standards and Technology (NIST)

6.6. EXPOSURE OF HUMANS TO RADIO FREQUENCY FIELDS [§ 2.1091]

The following criteria shall be used to evaluate the environmental impact of human exposure to RF radiation:

FCC 1.1310:- The criteria listed in the following table shall be used to evaluate the environmental impact of human exposure to radio-frequency (RF) radiation as specified in 1.1307(b).

TABLE 1—LIMITS FOR MAXIMUM PERMISSIBLE EXPOSURE (MPE)

Frequency range (MHz)	Electric field strength (V/m)	Magnetic field strength (A/m)	Power density (mW/cm ²)	Averaging time (minutes)
(A) Limits for Occupational/Controlled Exposures				
0.3–3.0	614	1.63	*(100)	6
3.0–30	1842/f	4.89/f	*(900/f ²)	6
30–300	61.4	0.163	1.0	6
300–1500	f/300	6
1500–100,000	5	6
(B) Limits for General Population/Uncontrolled Exposure				
0.3–1.34	614	1.63	*(100)	30
1.34–30	824/f	2.19/f	*(180/f ²)	30
30–300	27.5	0.073	0.2	30
300–1500	f/1500	30
1500–100,000	1.0	30

f = frequency in MHz

* = Plane-wave equivalent power density

NOTE 1 TO TABLE 1: Occupational/controlled limits apply in situations in which persons are exposed as a consequence of their employment provided those persons are fully aware of the potential for exposure and can exercise control over their exposure. Limits for occupational/controlled exposure also apply in situations when an individual is transient through a location where occupational/controlled limits apply provided he or she is made aware of the potential for exposure.

NOTE 2 TO TABLE 1: General population/uncontrolled exposures apply in situations in which the general public may be exposed, or in which persons that are exposed as a consequence of their employment may not be fully aware of the potential for exposure or can not exercise control over their exposure.

Calculation Method of RF Safety Distance:

$$S = PG/4\pi r^2 = EIRP/4\pi r^2 \implies r = \sqrt{PG/4\pi S} = \sqrt{EIRP/4\pi S}$$

- Where:
- P: power input to the antenna in mW
 - EIRP: Equivalent (effective) isotropic radiated power.
 - S: power density mW/cm²
 - G: numeric gain of antenna relative to isotropic radiator
 - r: distance to center of radiation in cm

MPE Evaluation

Antenna Gain Limit specified by Manufacturer: 9 dBi

Frequency (MHz)	Measured RF Conducted (Watts)	Calculated EIRP (Watts)	Laboratory's Recommended Minimum RF Safety Distance r (meters)	Manufacturer's Minimum RF Safety Distance (meters)
156.050	24.7	196.2	2.8	3
157.425	24.6	195.4	2.8	3

Note 1: RF EXPOSURE DISTANCE LIMITS: $r = (PG/4\pi S)^{1/2} = (EIRP/4\pi S)^{1/2}$
 $S = 0.2 \text{ mW/cm}^2$ (specified limits for general population/uncontrolled exposure)

$$r = \sqrt{EIRP / 4\pi S} = \sqrt{196200 / (4\pi(0.2))} = 279.4 \text{ cm} \approx 2.8 \text{ m}$$

Evaluation of RF Exposure Compliance Requirements	
RF Exposure Requirements	Compliance with FCC Rules
Minimum calculated separation distance between antenna and persons required: 2.8 meters	Manufacturer's instruction for separation distance between antenna and persons required: 3 meters.

6.7. FREQUENCY STABILITY [§§ 2.1055, 80.209]

6.7.1. Limits

Please refer to FCC 47 CFR, Part 80, Subpart I, Para. 80.209 for specification details.

Operating Frequency Band (MHz)	Coast Stations			Ship Stations
	Below 3 W	3 to 100 W	Above 100W	
156.025-157.425 MHz	10 ppm	5 ppm	2.5 ppm	10 ppm

6.7.2. Method of Measurements

Refer to Exhibit 8, § 8.3 of this report for measurement details

6.7.3. Test Equipment List

Test Instruments	Manufacturer	Model No.	Serial No.	Frequency Range
Spectrum Analyzer/EMI Receiver	Hewlett Packard	HP 8593EM	3412A00103	9 kHz – 26.5 GHz
Attenuator	Weinschel Corp	24-20-34	BJ2364	DC – 8.5 GHz
Temperature & Humidity Chamber	Tenney	T5	9723B	-40° to +60° C range

6.7.4. Test Arrangement

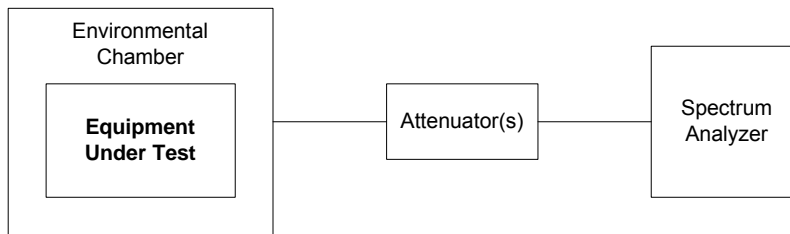

6.7.5. Test Data

6.7.5.1. Frequency Tolerance versus Ambient Temperature

Product Name:	VHF Marine Transceiver
Model No.:	IC-M502A
Center Frequency:	156.050
Full Power Level:	25 Watts
Frequency Tolerance Limit (Worst Case):	10 ppm or 1560.5
Max. Frequency Tolerance Measured:	+754Hz or +4.8 ppm
Input Voltage Rating:	13.8 VDC

Ambient Temperature (°C)	CENTER FREQUENCY & RF POWER OUTPUT VARIATION		
	Supply Voltage (Nominal) 13.8 Volts	Supply Voltage (85% of Nominal) 11.73 Volts	Supply Voltage (115% of Nominal) 15.87 Volts
	Hz	Hz	Hz
-20	+434	n/a	n/a
-10	+640	n/a	n/a
0	+583	n/a	n/a
+10	+217	n/a	n/a
+20	-12	-69	-69
+30	+114	n/a	n/a
+40	+388	n/a	n/a
+50	+754	n/a	n/a

6.8. AUDIO FREQUENCY RESPONSE [§§ 2.1047(a) & 80.213]

6.8.1. Limits

The recommended audio filter attenuation characteristics are given below:

RF Band	Audio band	Minimum Attenuation Rel. to 1 kHz Attenuation
156.025-157.425 MHz	3 –20 kHz above 20 kHz	$60 \log_{10}(f/3)$ dB where f is in kHz 50dB

6.8.2. Method of Measurements

The rated audio input signal was applied to the input of the audio lowpass filter (or of all modulation stages) using an audio oscillator, this input signal level and its corresponding output signal were then measured and recorded using the FFT (Audio) spectrum analyzer. Tests were repeated at different audio signal frequencies from 0 to 50 kHz.

6.8.3. Test Equipment List

Test Instruments	Manufacturer	Model No.	Serial No.	Frequency Range
FFT (audio) Spectrum Analyzer	Advantest	R9211E	82020336	10 mHz – 100 kHz, 1 MHz Input Impedance
Audio Oscillator	Hewlett Packard	HP 204C	0989A08798	DC to 1.2 MHz
Digital Multimeter	Rohde & Schawrz	UDS-5	872984/067	DC – 200 kHz
Modulation Analyzer	Hewlett Packard	HP-8901B	3226A04606	150 kHz – 1.3 GHz
Attenuator	Weinschel Corp	24-20-34	BJ2364	DC – 8.5 GHz

6.8.4. Test Arrangement

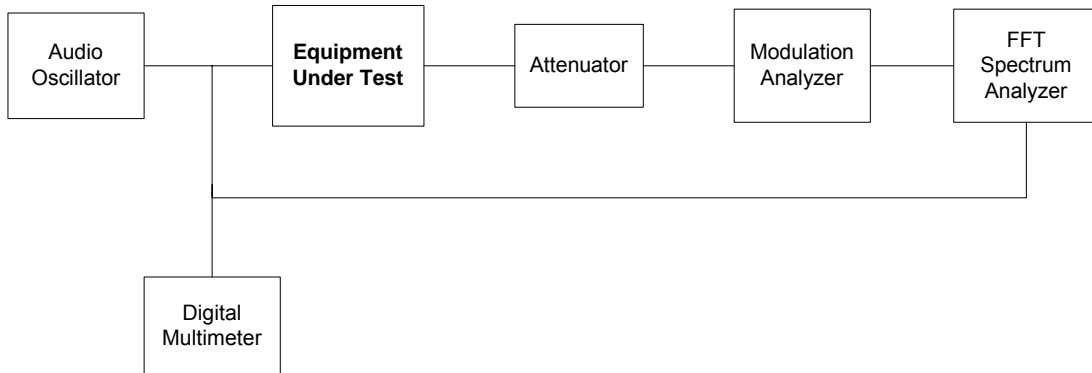

6.8.5. Test Data

Note: Due to the difficulty of measuring the Frequency Response of the internal lowpass filter, the Frequency Response of All Modulation States are performed to show the roll-off at 3 kHz in comparison with FCC Limit for audio lowpass filter.

Frequency of All Modulation States

Frequency (kHz)	Audio In (dBV)	Audio Out (dBV)	Atten. (Out - In) (dB)	Atten. wrt. 1 kHz (dB)	FCC Limit (dB)
0.10	-47.28	-20.36	26.92	-27.09	--
0.20	-47.28	-10.64	36.64	-17.37	--
0.40	-47.28	-2.40	44.88	-9.13	--
0.60	-47.28	1.55	48.83	-5.18	--
0.80	-47.28	4.28	51.56	-2.45	--
1.00	-47.28	6.73	54.01	0.00	--
1.50	-47.28	8.47	55.75	1.74	--
2.00	-47.28	9.65	56.93	2.92	--
2.50	-47.28	9.81	57.09	3.08	--
3.00	-47.28	8.35	55.63	1.62	0.0
3.50	-47.28	5.11	52.39	-1.62	-4.0
4.00	-47.28	1.43	48.71	-5.30	-7.5
4.50	-47.28	-2.09	45.19	-8.82	-10.6
5.00	-47.28	-5.19	42.09	-11.92	-13.3
6.00	-47.28	-10.81	36.47	-17.54	-18.1
7.00	-47.28	-15.86	31.42	-22.59	-22.1
8.00	-47.28	-20.32	26.96	-27.05	-25.6
9.00	-47.28	-24.23	23.05	-30.96	-28.6
10.00	-47.28	-27.84	19.44	-34.57	-31.4
12.00	-47.28	-35.77	11.51	-42.50	-36.1
14.00	-47.28	-45.08	2.20	-51.81	-40.1
16.00	-47.28	<-50.00	<-2.72	<-56.73	-43.6
18.00	-47.28	<-50.00	<-2.72	<-56.73	-46.7
20.00	-47.28	<-50.00	<-2.72	<-56.73	-49.4
25.00	-47.28	<-50.00	<-2.72	<-56.73	-50.0
30.00	-47.28	<-50.00	<-2.72	<-56.73	-50.0
35.00	-47.28	<-50.00	<-2.72	<-56.73	-50.0
40.00	-47.28	<-50.00	<-2.72	<-56.73	-50.0

AUDIO FREQUENCY REPSONSE OF ALL MODULATION STAGES
ICOM VHF Radio Transceiver, Model IC-M502A (25 kHz Channel Spacing)

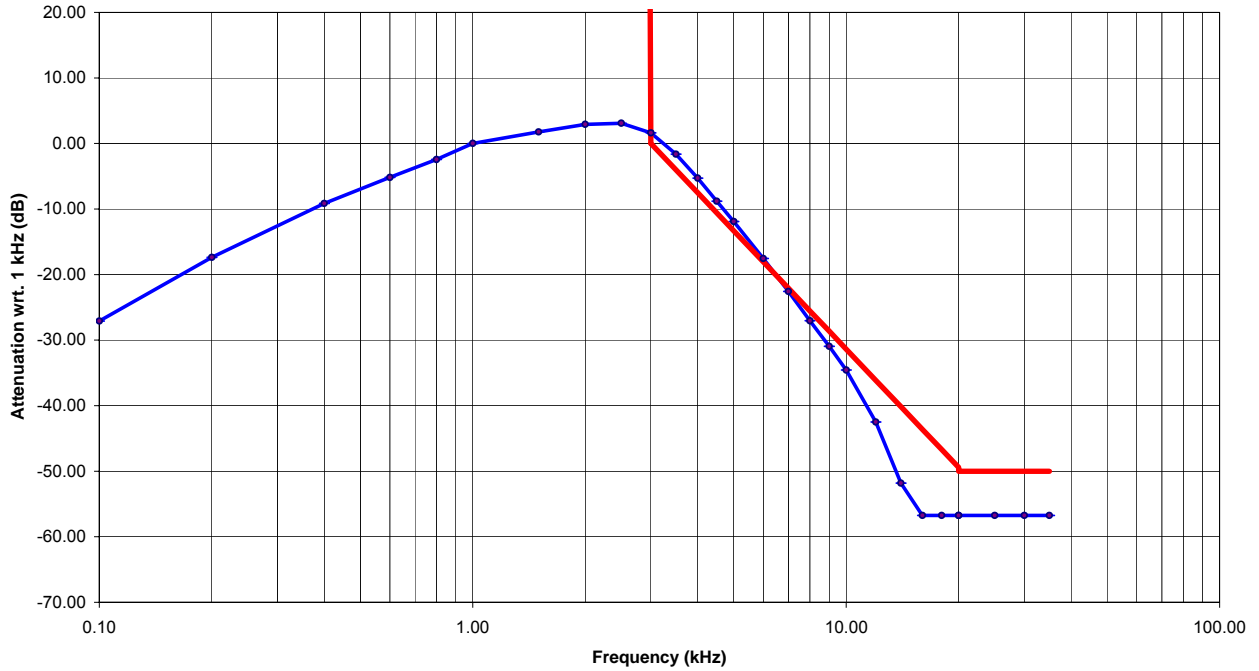

ULTRATECH GROUP OF LABS

3000 Bristol Circle, Oakville, Ontario, Canada L6H 6G4
Tel. #: 905-829-1570, Fax. #: 905-829-8050, Email: vic@ultratech-labs.com, Website: http://www.ultratech-labs.com

File #: ICOM-071F80
October 7, 2003

All test results contained in this engineering test report are traceable to National Institute of Standards and Technology (NIST)

6.9. MODULATION LIMITING [§ 2.1047(b)]

6.9.1. Limits @ FCC 2.1047(b)

Recommended frequency deviation characteristics are given below:

Frequency Range (MHz)	Maximum Authorized BW (KHz)	Channel Spacing (KHz)	Recommended Frequency Deviation (KHz)
156.025-157.425 MHz (Marine)	20.0	25.0	5.0

6.9.2. Method of Measurements

For Audio Transmitter:- The carrier frequency deviation was measured with the tone input signal level varied from 0 Vp to audio input rating level plus 16 dB at frequencies 0.1, 0.5, 1.0, 3.0 and 5.0 kHz. The maximum deviation was recorded at each test condition.

For Data Transmitter with Maximum Frequency Deviation set by Factory:- The EUT was set at maximum frequency deviation, and its peak frequency deviation was then measured using EUT's internal random data source.

6.9.3. Test Equipment List

Test Instruments	Manufacturer	Model No.	Serial No.	Frequency Range
Audio Oscillator	Hewlett Packard	HP 204C	0989A08798	DC to 1.2 MHz
Digital Multimeter	Rohde & Schawrz	UDS-5	872984/067	DC – 200 kHz
Modulation Analyzer	Hewlett Packard	HP-8901B	3226A04606	150 kHz – 1.3 GHz
Attenuator	Weinschel Corp	24-20-34	BJ2364	DC – 8.5 GHz

6.9.4. Test Arrangement

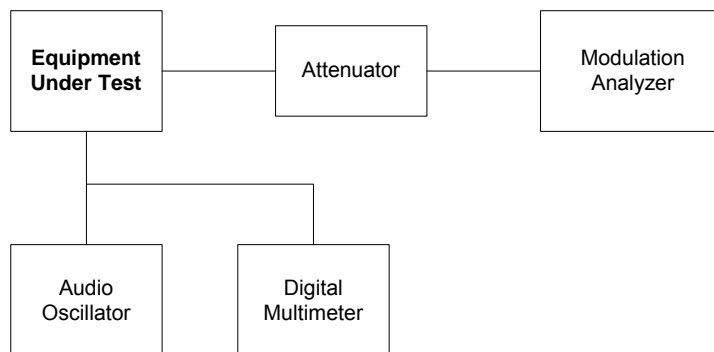

ULTRATECH GROUP OF LABS

3000 Bristol Circle, Oakville, Ontario, Canada L6H 6G4
 Tel. #: 905-829-1570, Fax. #: 905-829-8050, Email: vic@ultratech-labs.com, Website: http://www.ultratech-labs.com

File #: ICOM-071F80
 October 7, 2003

All test results contained in this engineering test report are traceable to National Institute of Standards and Technology (NIST)

6.9.5. Test Data

6.9.5.1. Voice Modulation Limiting for 25 kHz Channel Spacing Operation:

MODULATING SIGNAL LEVEL (mVrms)	PEAK FREQUENCY DEVIATION (kHz) at the following modulating frequency:					MAXIMUM LIMIT (kHz)
	0.1 kHz	0.5 kHz	1.0 kHz	3.0 kHz	5.0 kHz	
1	0.12	0.38	0.85	2.07	0.60	5.0
2	0.15	0.74	1.51	3.39	0.73	5.0
4	0.23	1.46	3.05	3.72	0.77	5.0
6	0.26	2.12	3.57	3.80	0.79	5.0
8	0.37	2.81	3.82	3.84	0.79	5.0
10	0.45	3.13	3.94	3.86	0.80	5.0
12	0.52	3.17	4.01	3.87	0.79	5.0
14	0.58	3.25	4.06	3.88	0.79	5.0
16	0.63	3.33	4.08	3.90	0.80	5.0
18	0.66	3.39	4.12	3.91	0.81	5.0
20	0.72	3.47	4.14	3.92	0.81	5.0
25	0.94	3.63	4.17	3.93	0.81	5.0
30	1.08	3.75	4.18	3.93	0.81	5.0
35	1.29	3.85	4.19	3.93	0.81	5.0
40	2.08	3.94	4.21	3.93	0.81	5.0
45	2.64	3.97	4.22	3.96	0.82	5.0
50	3.11	4.01	4.22	3.96	0.82	5.0

Voice Signal Input Level = STD MOD Level + 16 dB
= 12.04 dB(mVrms) + 16 dB
= 28.04 dB(mVrms) or 25.23 mVrms

MODULATING FREQUENCY (KHz)	PEAK FREQUENCY DEVIATION (KHz)	MAXIMUM LIMIT (KHz)
0.1	0.94	5.0
0.2	3.20	5.0
0.4	3.36	5.0
0.6	3.90	5.0
0.8	4.11	5.0
1.0	4.17	5.0
1.2	4.14	5.0
1.4	4.10	5.0
1.6	4.18	5.0
1.8	4.30	5.0
2.0	4.40	5.0
2.5	4.31	5.0
3.0	3.93	5.0
3.5	2.66	5.0
4.0	1.73	5.0
4.5	1.16	5.0
5.0	0.81	5.0
6.0	0.43	5.0
7.0	0.26	5.0
8.0	0.16	5.0
9.0	0.11	5.0
10.0	0.08	5.0

6.10. EMISSION MASK [§§ 2.1049 and 80.211(f)]

6.10.1. Limits

Emissions shall be attenuated below the mean output power of the transmitter as follows:

Frequency Range (MHz)	Maximum Authorized BW (KHz)	Channel Spacing (KHz)	Recommended Frequency Deviation (KHz)	FCC Applicable Mask
156.025-157.425	20.0	25.0	5.0	§80.211(f)

6.10.2. Method of Measurements

Refer to Exhibit 8, § 8.4 of this report for measurement details

6.10.3. Test Equipment List

Test Instruments	Manufacturer	Model No.	Serial No.	Frequency Range
Audio Oscillator	Hewlett Packard	HP 204C	0989A08798	DC to 1.2 MHz
Digital Multimeter	Rohde & Schawrz	UDS-5	872984/067	DC – 200 kHz
Spectrum Analyzer/ EMI Receiver	Hewlett Packard	HP 8593EM	3412A00103	9 kHz – 26.5 GHz
Attenuator	Weinschel Corp	24-20-34	BJ2364	DC – 8.5 GHz

6.10.4. Test Arrangement

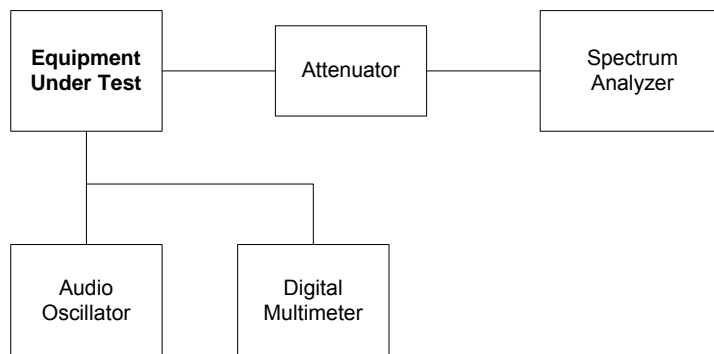

6.10.5. Test Data

See the following test data plots (1 to 12) for details:

Plot 1: Emission Mask
Test Frequency: 156.050 MHz
Power Output: 1 W (Low)
Modulation: FM, 2.5kHz sine wave

11:31:17 SEP 05, 2003

ACTV DET: PEAK
MEAS DET: PEAK QP AVG
MKR 156.0500 MHz
29.08 dBm

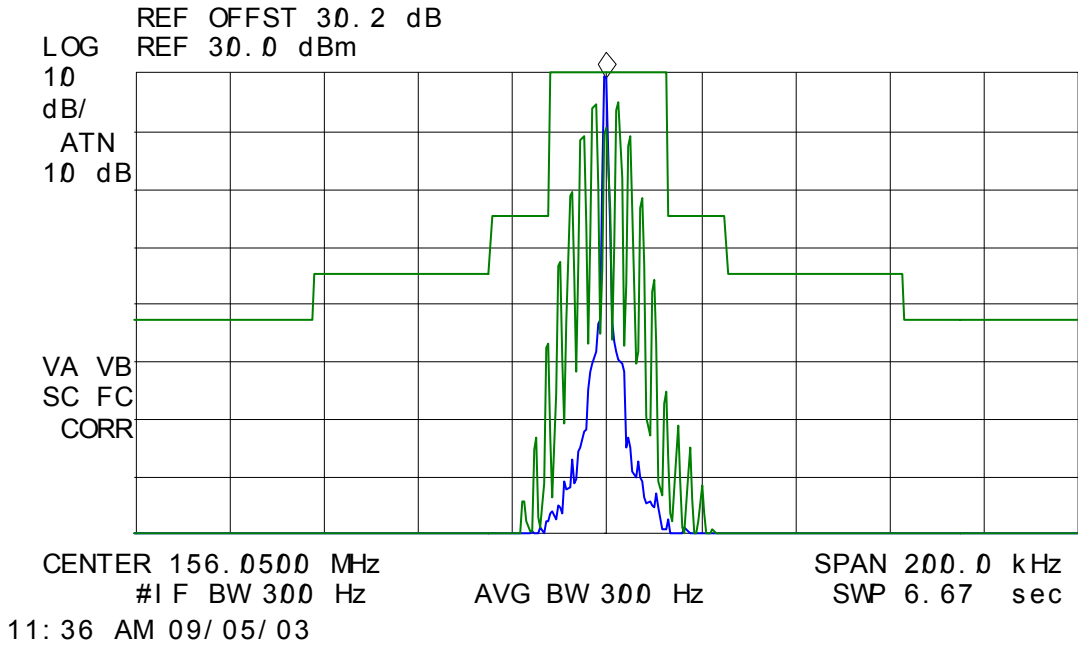

Plot 2: Emission Mask
Test Frequency: 157.425 MHz
Power Output: 1 W (Low)
Modulation: FM, 2.5kHz sine wave

11:30:54 SEP 05, 2003

ACTV DET: PEAK
MEAS DET: PEAK QP AVG
MKR 157.4245 MHz
29.24 dBm

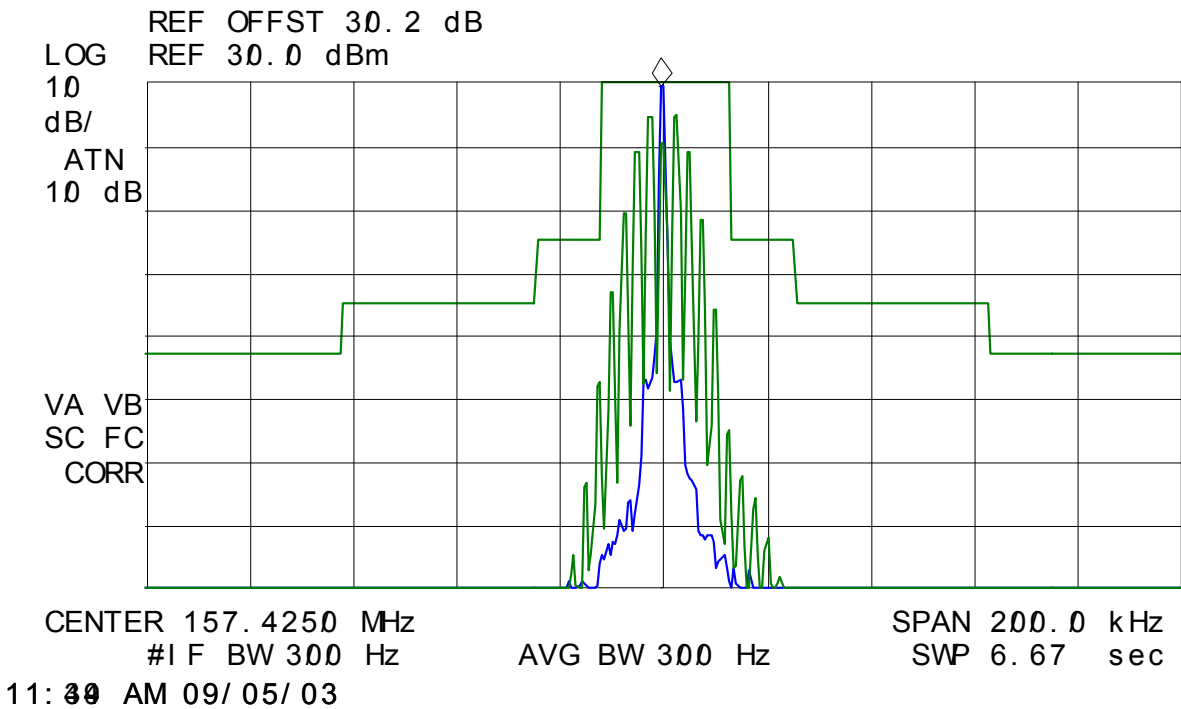

Plot 3: Emission Mask
Test Frequency: 156.050 MHz
Power Output: 1 W (Low)
Modulation: FM, DSC

11: 18: 28 SEP 05, 2003

ACTV DET: PEAK
MEAS DET: PEAK QP AVG
MKR 156.0500 MHz
29.25 dBm

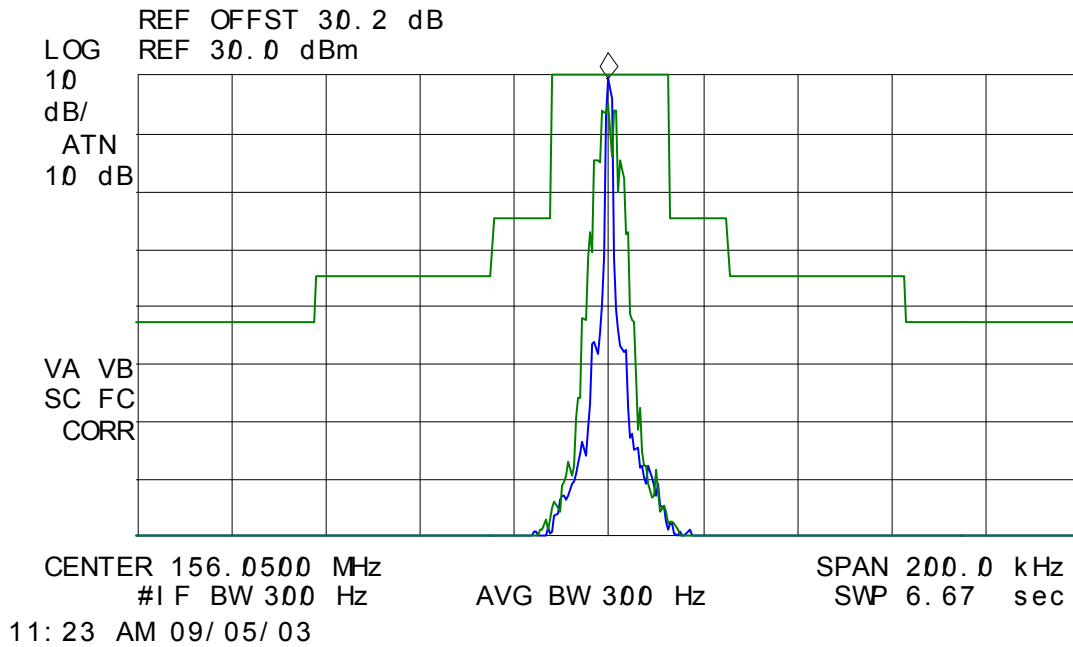

Plot 4: Emission Mask
Test Frequency: 157.425 MHz
Power Output: 1 W (Low)
Modulation: FM, DSC

11:09:54 SEP 05, 2003

ACTV DET: PEAK
MEAS DET: PEAK QP AVG
MKR 157.4250 MHz
29.24 dBm

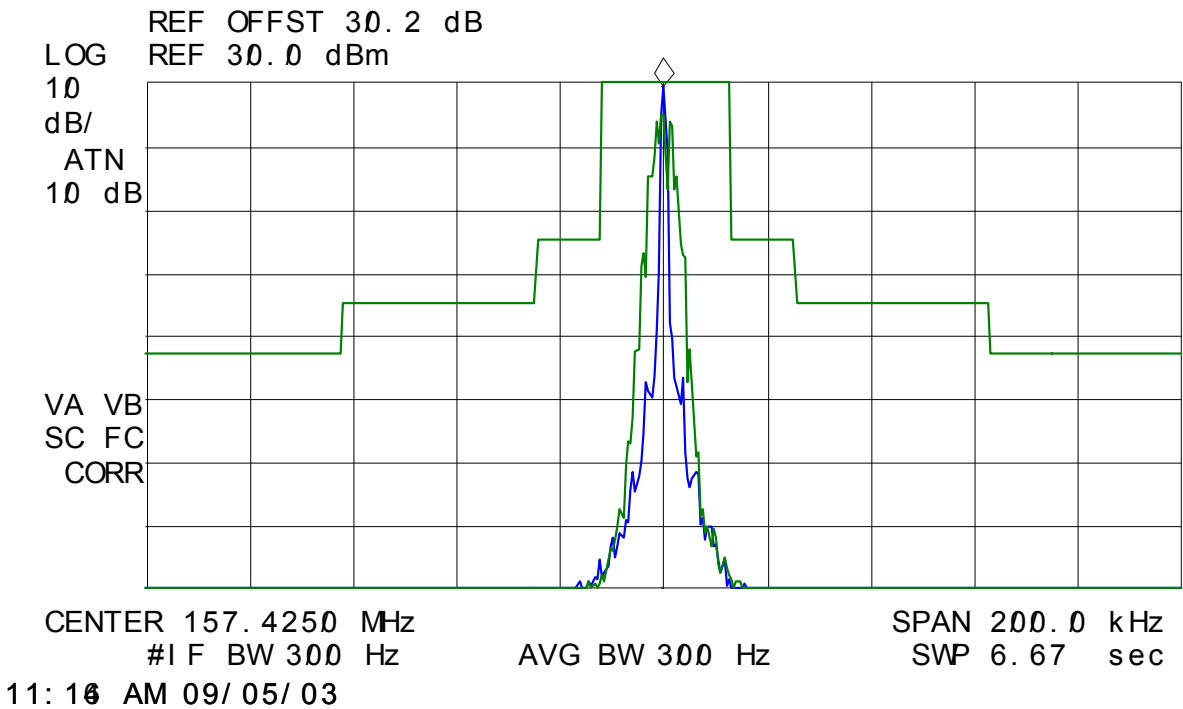

ULTRATECH GROUP OF LABS

3000 Bristol Circle, Oakville, Ontario, Canada L6H 6G4
Tel. #: 905-829-1570, Fax. #: 905-829-8050, Email: vic@ultratech-labs.com, Website: http://www.ultratech-labs.com

File #: ICOM-071F80
October 7, 2003

All test results contained in this engineering test report are traceable to National Institute of Standards and Technology (NIST)

Plot 5: Emission Mask
Test Frequency: 156.050 MHz
Power Output: 1 W (Low)
Modulation: FM, 2.5kHz sine wave with scrambler

14:57:10 SEP 05, 2003

ACTV DET: PEAK
MEAS DET: PEAK QP AVG
MKR 156.0500 MHz
29.37 dBm

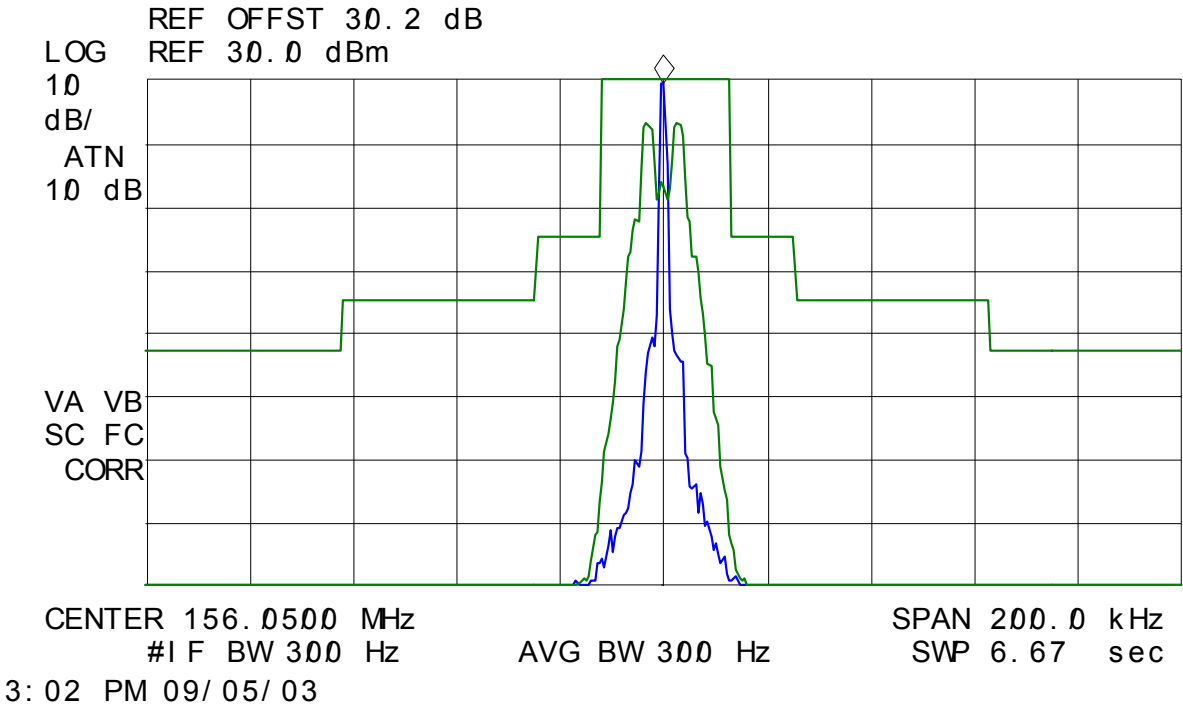

Plot 6: Emission Mask
Test Frequency: 157.425 MHz
Power Output: 1 W (Low)
Modulation: FM, 2.5kHz sine wave with scrambler

15:08:30 SEP 05, 2003

ACTV DET: PEAK
MEAS DET: PEAK QP AVG
MKR 157.4245 MHz
29.31 dBm

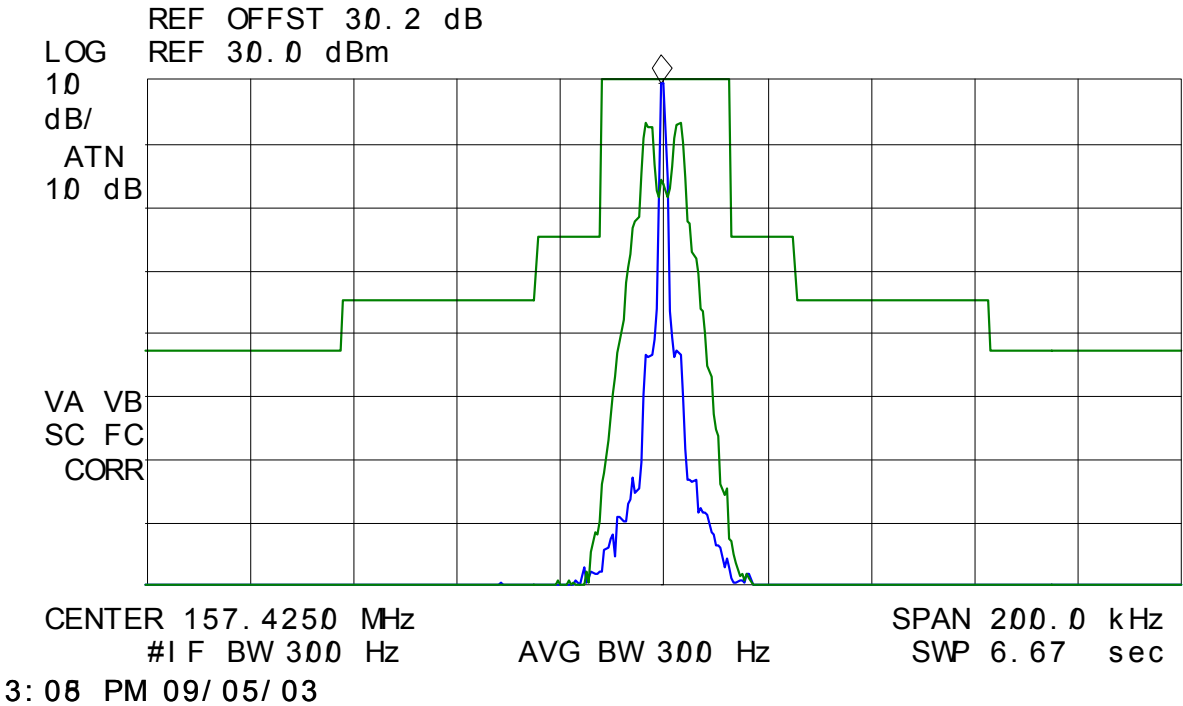

Plot 7: Emission Mask
Test Frequency: 156.050 MHz
Power Output: 25 W (High)
Modulation: FM, 2.5kHz sine wave

11:54:53 SEP 05, 2003

ACTV DET: PEAK
MEAS DET: PEAK QP AVG
MKR 156.0500 MHz
44.22 dBm

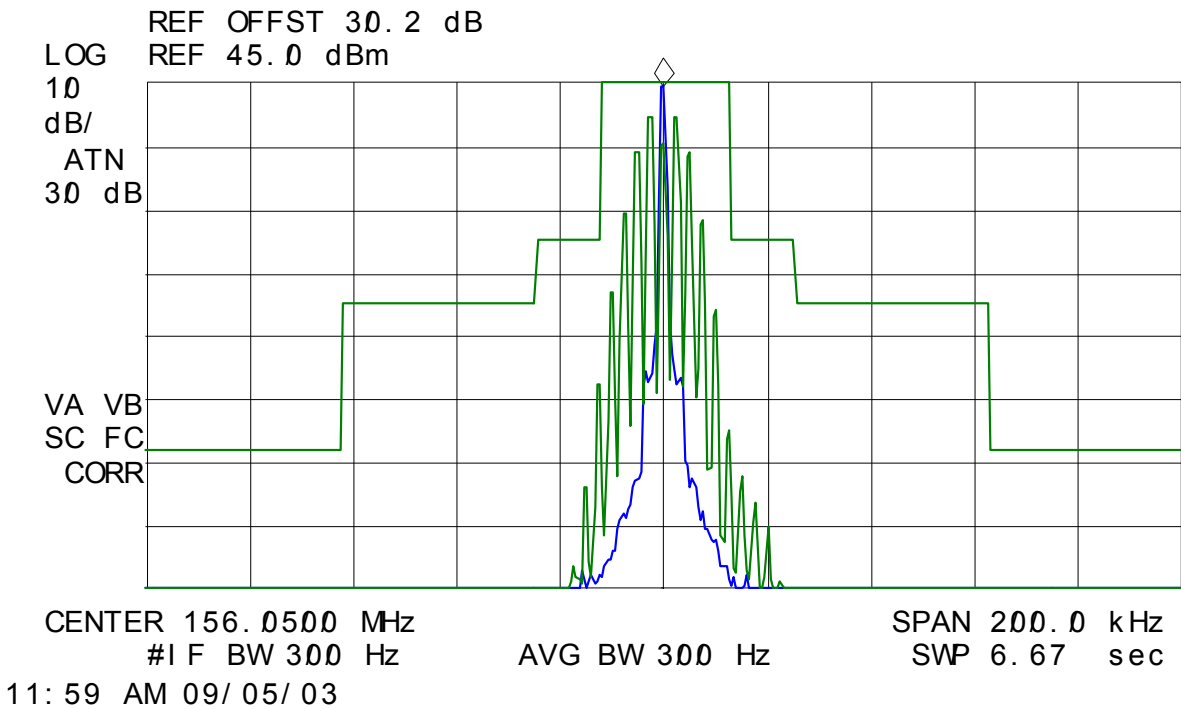

Plot 8: Emission Mask
Test Frequency: 157.425 MHz
Power Output: 25 W (High)
Modulation: FM, 2.5kHz sine wave

13:58:50 SEP 05, 2003

ACTV DET: PEAK
MEAS DET: PEAK QP AVG
MKR 157.4250 MHz
44.14 dBm

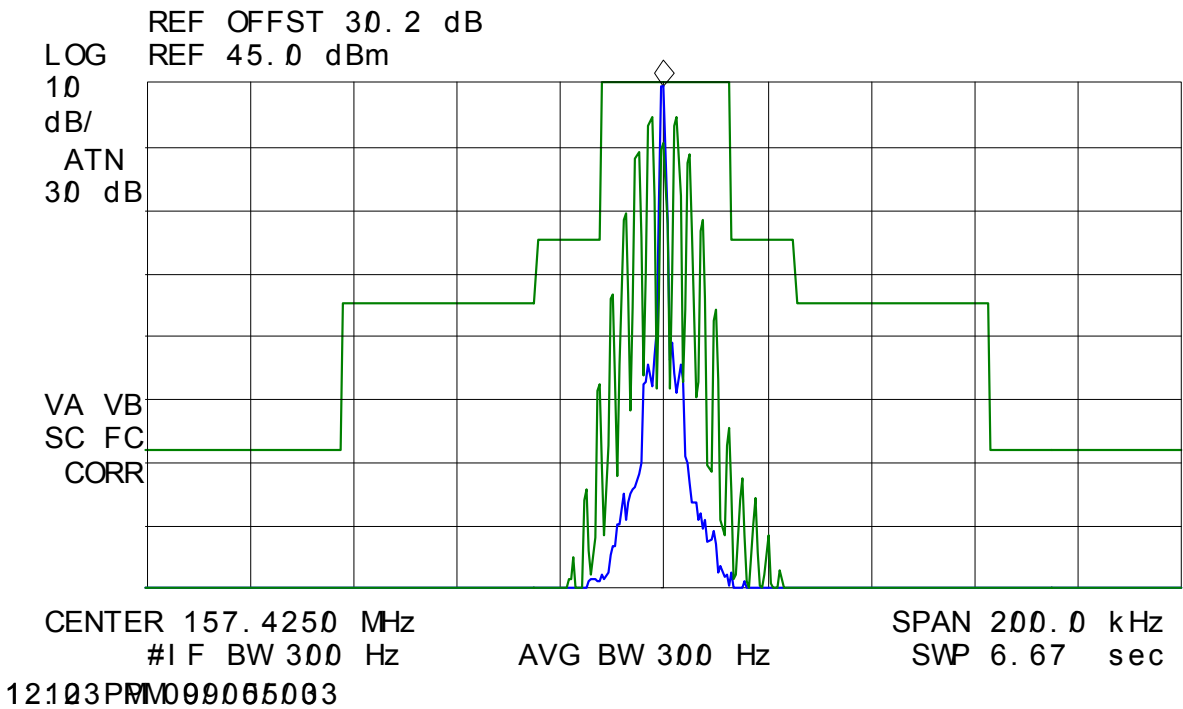

Plot 9: Emission Mask
Test Frequency: 156.050 MHz
Power Output: 25 W (High)
Modulation: FM, DSC

10:14:32 SEP 05, 2003

ACTV DET: PEAK
MEAS DET: PEAK QP AVG
MKR 156.0500 MHz
44.24 dBm

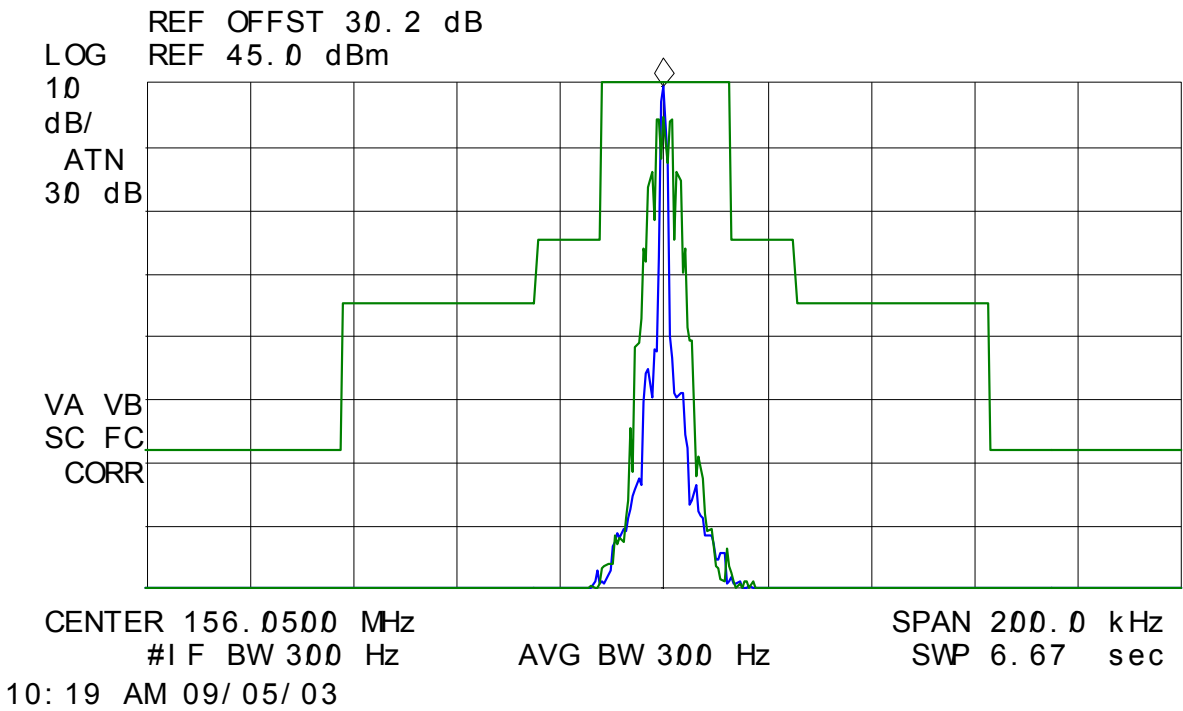

ULTRATECH GROUP OF LABS

3000 Bristol Circle, Oakville, Ontario, Canada L6H 6G4
Tel. #: 905-829-1570, Fax. #: 905-829-8050, Email: vic@ultratech-labs.com, Website: http://www.ultratech-labs.com

File #: ICOM-071F80

October 7, 2003

All test results contained in this engineering test report are traceable to National Institute of Standards and Technology (NIST)

Plot 10: Emission Mask
Test Frequency: 157.425 MHz
Power Output: 25 W (High)
Modulation: FM, DSC

~~10: 56: 56~~ SEP 05, 2003

ACTV DET: PEAK
MEAS DET: PEAK QP AVG
MKR 157.4250 MHz
44.23 dBm

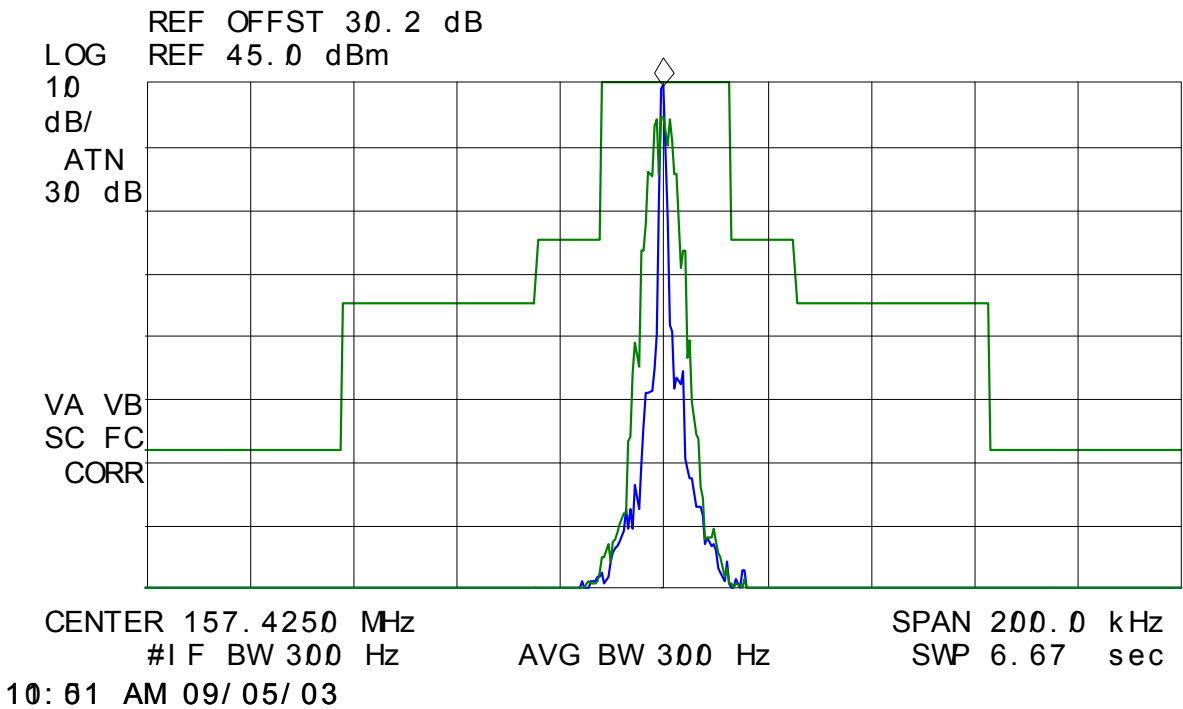

ULTRATECH GROUP OF LABS

3000 Bristol Circle, Oakville, Ontario, Canada L6H 6G4
Tel. #: 905-829-1570, Fax. #: 905-829-8050, Email: vic@ultratech-labs.com, Website: http://www.ultratech-labs.com

File #: ICOM-071F80
October 7, 2003

All test results contained in this engineering test report are traceable to National Institute of Standards and Technology (NIST)

Plot 11: Emission Mask
Test Frequency: 156.050 MHz
Power Output: 25 W (High)
Modulation: FM, 2.5kHz sine wave with scrambler

14:37:28 SEP 05, 2003

ACTV DET: PEAK
MEAS DET: PEAK QP AVG
MKR 156.0500 MHz
44.34 dBm

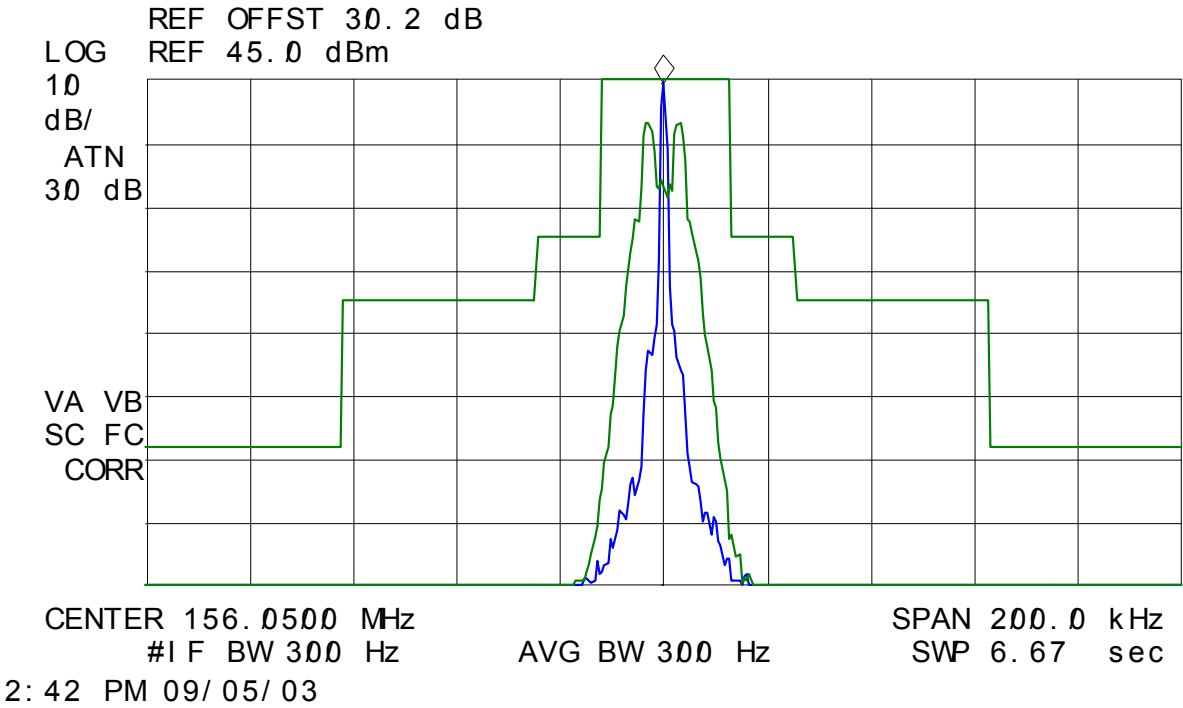

Plot 12: Emission Mask
Test Frequency: 157.425 MHz
Power Output: 25 W (High)
Modulation: FM, 2.5kHz sine wave with scrambler

13:58:20 SEP 05, 2003

ACTV DET: PEAK
MEAS DET: PEAK QP AVG
MKR 157.4250 MHz
44.14 dBm

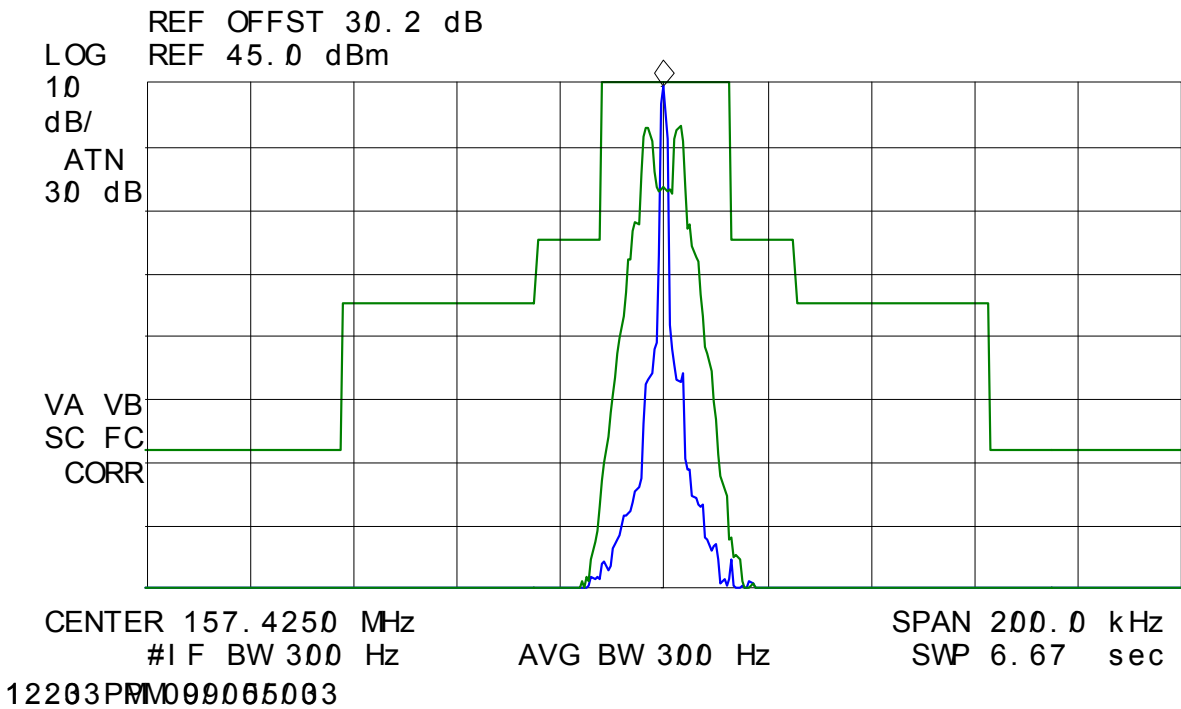

6.11. TRANSMITTER ANTENNA POWER SPURIOUS/HARMONIC CONDUCTED EMISSIONS [§ 80.211(f)]

6.11.1. Limits

Emissions shall be attenuated below the mean output power of the transmitter as follows:

FCC Rules	Frequency Range	Attenuation Limit (dBc)
80.211(f)	Shall be from the lowest frequency internally generated or used in the device (local oscillator, intermediated or carrier frequency), or from 10 MHz, whichever is the lowest frequency, to the 10 th harmonic of the highest generated or used frequency.	43+10*log(mean power in watts) dB

6.11.2. Method of Measurements

Refer to Exhibit 8 § 8.5 of this report for measurement details

6.11.3. Test Equipment List

Test Instruments	Manufacturer	Model No.	Serial No.	Frequency Range
Spectrum Analyzer/EMI Receiver	Hewlett Packard	HP 8593EM	3412A00103	9 kHz – 26.5 GHz
Attenuator	Weinschel Corp	24-20-34	BJ2364	DC – 8.5 GHz
Audio Oscillator	Hewlett Packard	HP 204C	0989A08798	DC to 1.2 MHz
High Pass Filter	Mini-Circuits	SHP-250	--	Cut-off Frequency at 220 MHz
Digital Multimeter	Rohde & Schawrz	UDS-5	872984/067	DC – 200 kHz

6.11.4. Test Arrangement

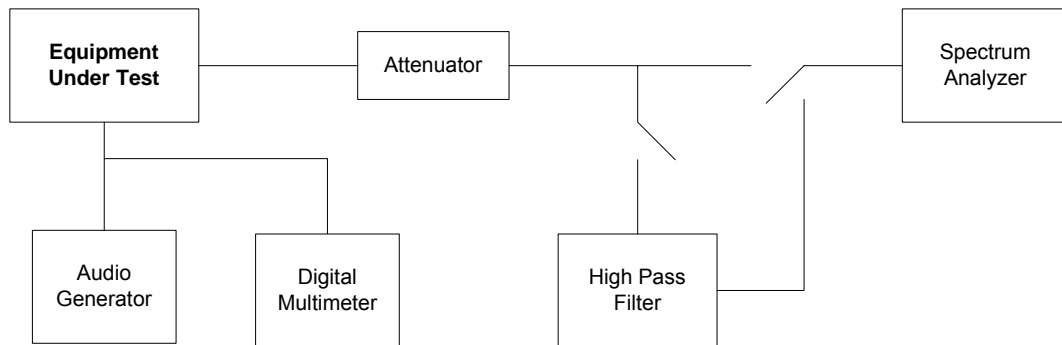

6.11.5. Test Data

6.11.5.1. Lowest Channel Frequency [156.050 MHz, FM with 2.5kHz Sine Wave Signal, RF Power Setting: 1 W (Low)]

The emissions were scanned from 10 MHz to 2 GHz, see the following test data plots (13 - 14) for details.

Plot 13: Spurious Emissions at Antenna Terminal
Test Frequency: 156.050 MHz
Output Power: 1 W (Low)
Modulation: FM, 2.5kHz sine wave

11:13:17 SEP 04, 2003

ACTV DET: PEAK
MEAS DET: PEAK QP AVG
MKR 156.3 MHz
29.20 dBm

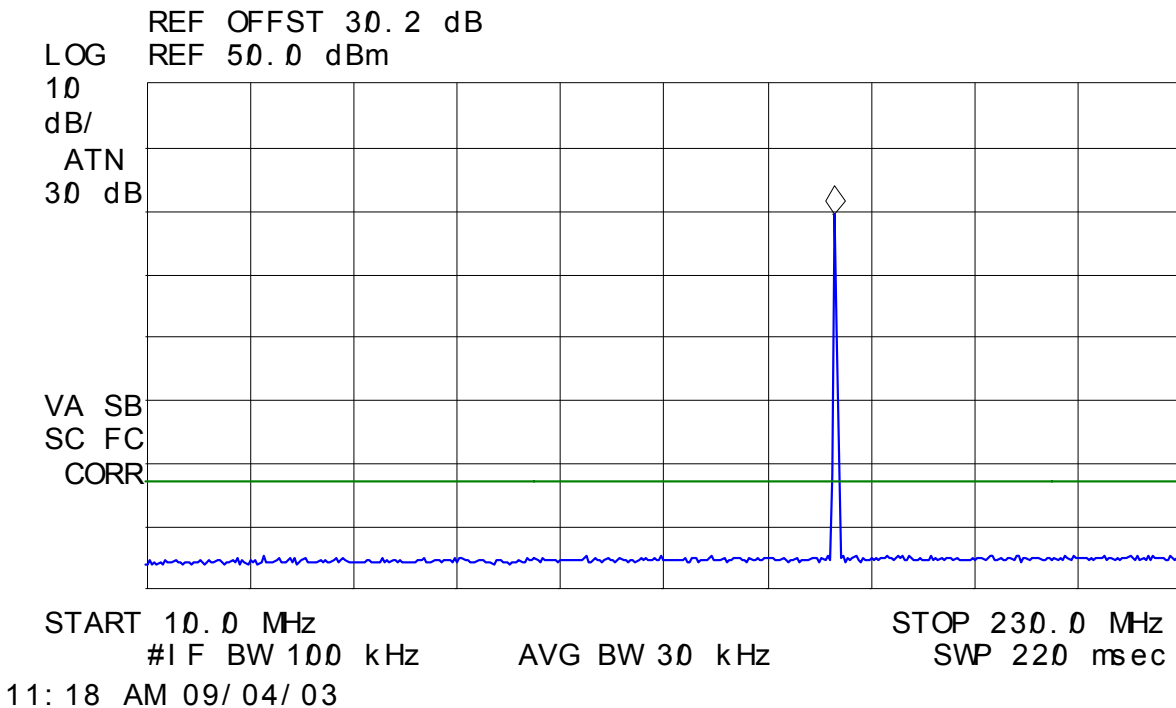

Plot 14: Spurious Emissions at Antenna Terminal
Test Frequency: 156.050 MHz
Output Power: 1 W (Low)
Modulation: FM with 2.5kHz sine wave

11: 29: 32 SEP 04, 2003

ACTV DET: PEAK
MEAS DET: PEAK QP AVG
MKR 314 MHz
- 44.74 dBm

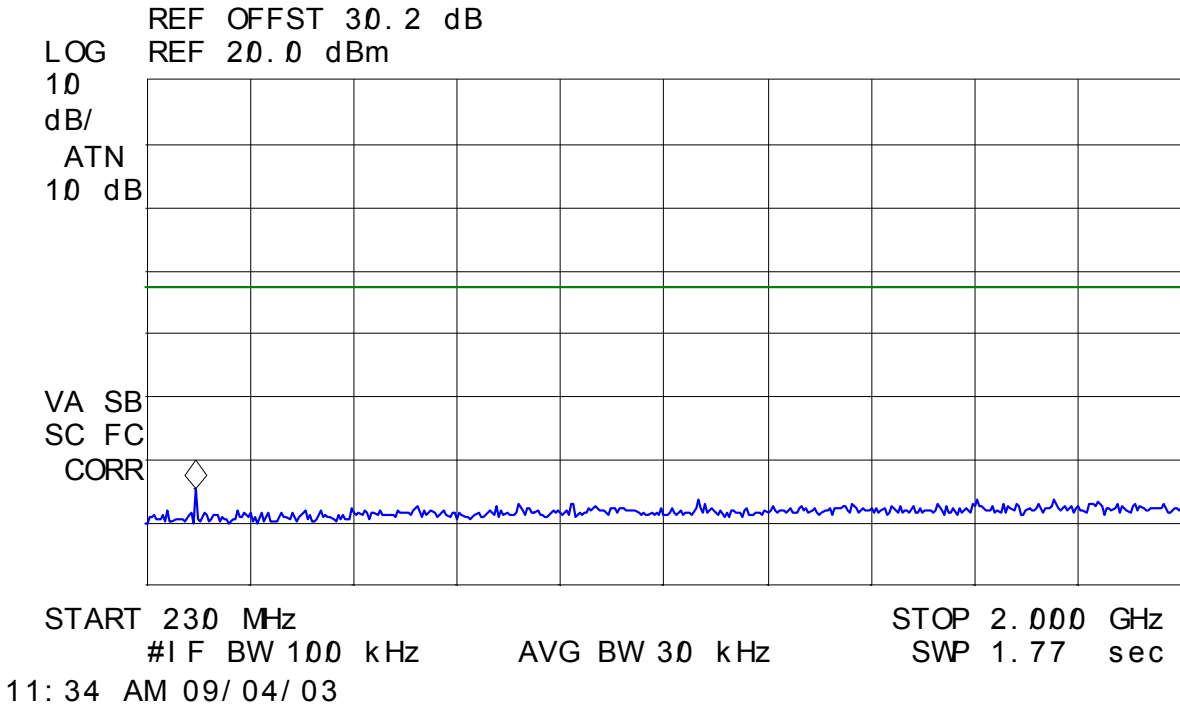

6.11.5.2. Highest Channel Frequency [157.425 MHz, FM with 2.5 kHz Sine Wave Signal, RF Power Setting: 1 W (Low)]

The emissions were scanned from 10 MHz to 2 GHz, see the following test data plots (15 - 16) for details.

Plot 15: Spurious Emissions at Antenna Terminal
Test Frequency: 157.425 MHz
Output Power: 1 W (Low)
Modulation: FM with 2.5kHz sine wave

10:58:29 SEP 04, 2003

ACTV DET: PEAK
MEAS DET: PEAK QP AVG
MKR 158.0 MHz
29.20 dBm

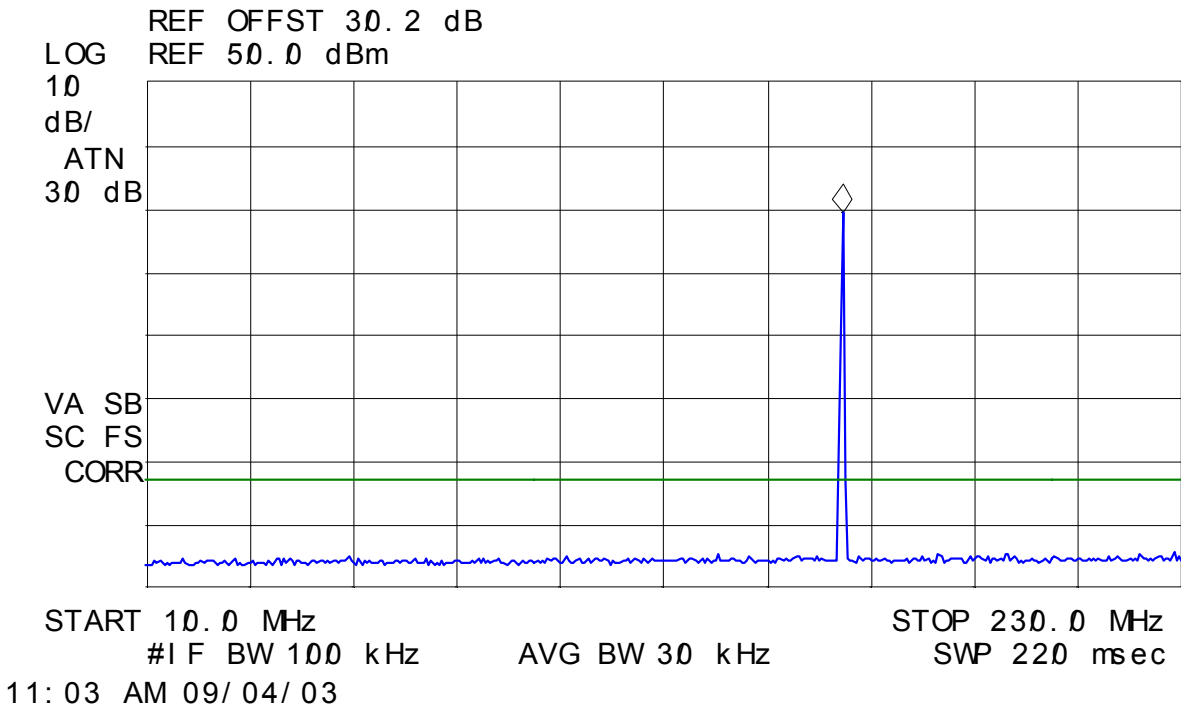

Plot 16: Spurious Emissions at Antenna Terminal
Test Frequency: 157.425 MHz
Output Power: 1 W (Low)
Modulation: FM with 2.5kHz sine wave

11: 32: 16 SEP 04, 2003

ACTV DET: PEAK
MEAS DET: PEAK QP AVG
MKR 319 MHz
- 46.20 dBm

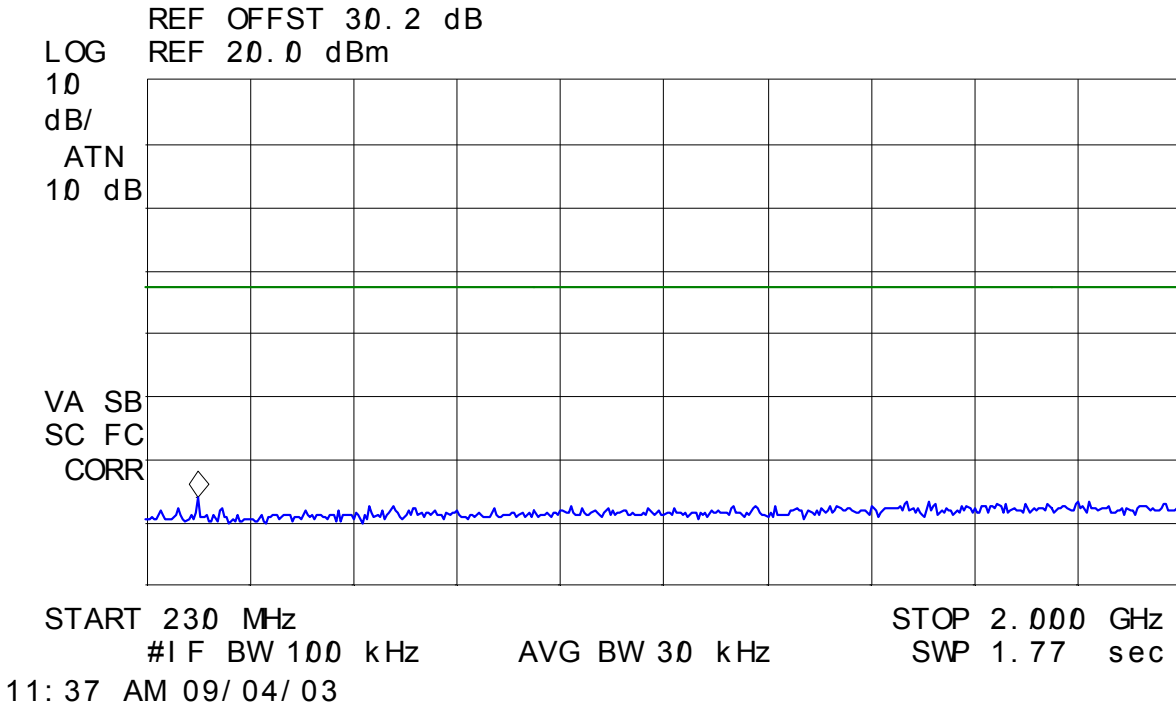

6.11.5.3. Lowest Channel Frequency [156.050 MHz, FM with 2.5 kHz Sine Wave Signal, RF Power Setting: 25 W (High)]

The emissions were scanned from 10 MHz to 2 GHz, see the following test data plots (17 - 18) for details.

Plot 17: Spurious Emissions at Antenna Terminal
Test Frequency: 156.050 MHz
Output Power: 25 W (High)
Modulation: FM with 2.5kHz sine wave

10:38:38 SEP 04, 2003

ACTV DET: PEAK
MEAS DET: PEAK QP AVG
MKR 156.3 MHz
44.32 dBm

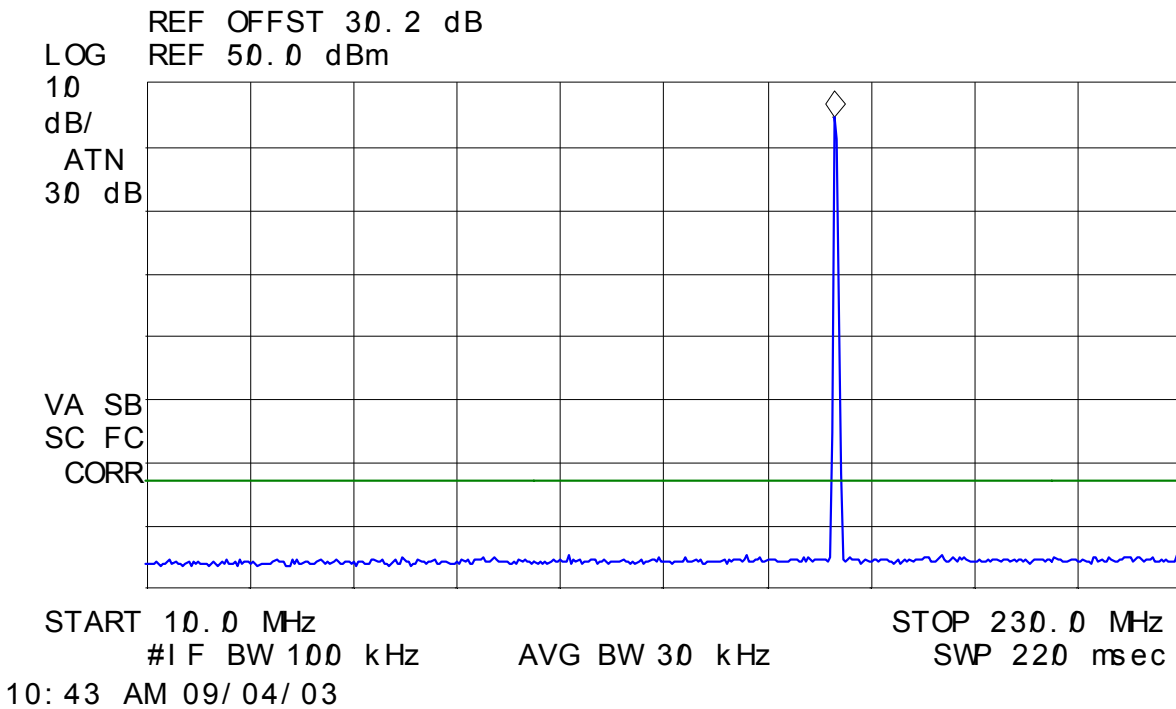

Plot 18: Spurious Emissions at Antenna Terminal
Test Frequency: 156.050 MHz
Output Power: 25 W (High)
Modulation: FM with 2.5kHz sine wave

11:39:08 SEP 04, 2003

ACTV DET: PEAK
MEAS DET: PEAK QP AVG
MKR 469 MHz
- 33.71 dBm

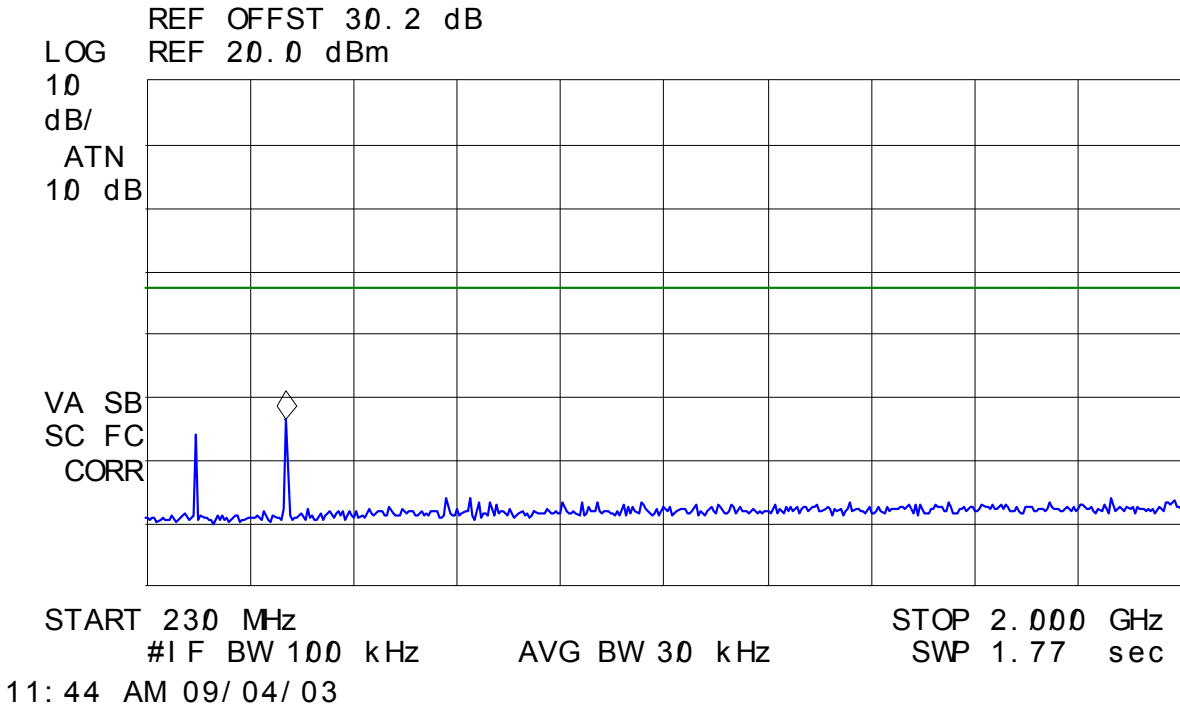

6.11.5.4. Highest Channel Frequency [157.425 MHz, FM with 2.5 kHz Sine Wave Signal, RF Power Setting: 25 W (High)]

The emissions were scanned from 10 MHz to 2 GHz, see the following test data plots (19 - 20) for details.

Plot 19: Spurious Emissions at Antenna Terminal
Test Frequency: 157.425 MHz
Output Power: 25 W (High)
Modulation: FM with 2.5kHz sine wave

10: 53: 39 SEP 04, 2003

ACTV DET: PEAK
MEAS DET: PEAK QP AVG
MKR 158.0 MHz
44.27 dBm

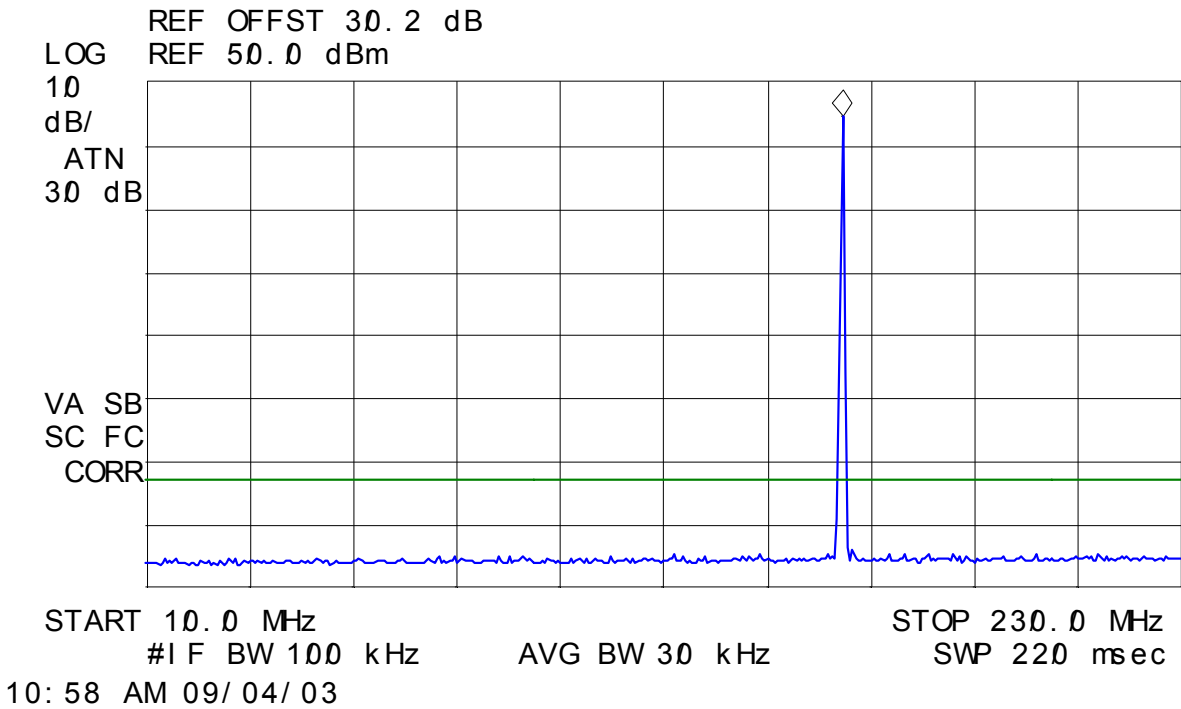

Plot 20: Spurious Emissions at Antenna Terminal
Test Frequency: 157.425 MHz
Output Power: 25 W (High)
Modulation: FM with 2.5kHz sine wave

11:42:34 SEP 04, 2003

ACTV DET: PEAK
MEAS DET: PEAK QP AVG
MKR 319 MHz
- 35.59 dBm

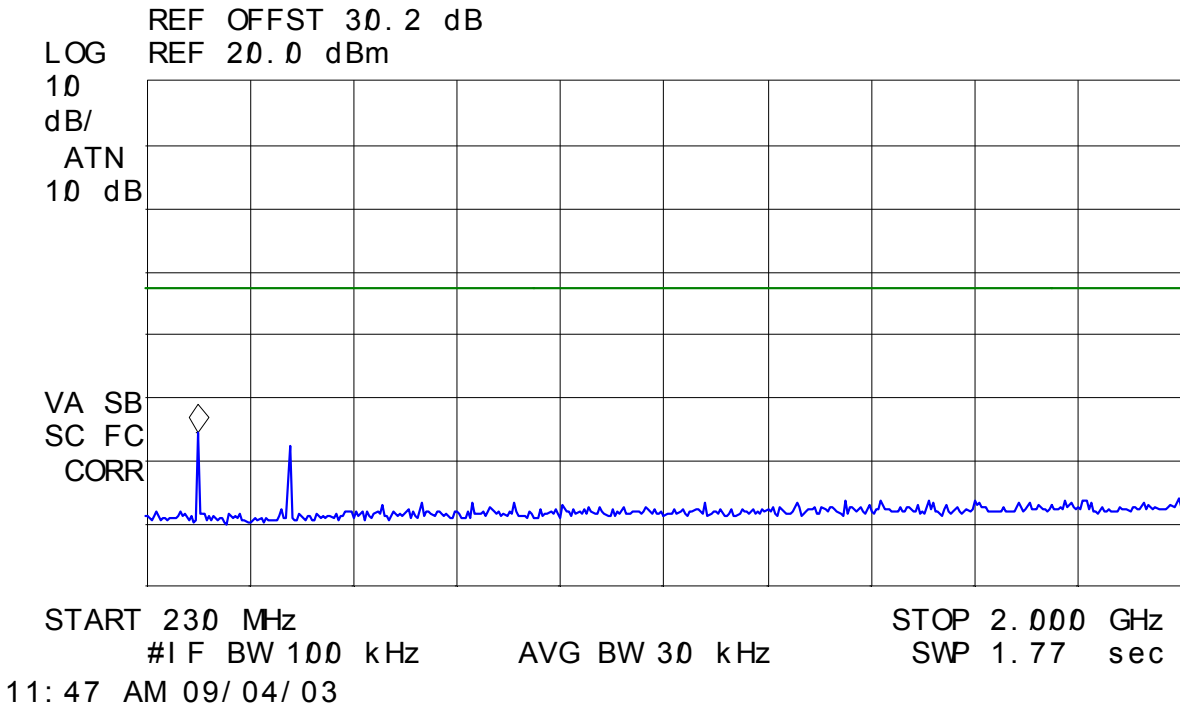

6.12. TRANSMITTER SPURIOUS/HARMONIC RADIATED EMISSIONS [§ 80.211(f)]

6.12.1. Limits

Emissions shall be attenuated below the mean output power of the transmitter as follows:

FCC Rules	Frequency Range	Attenuation Limit (dBc)
80.211(f)	Shall be from the lowest frequency internally generated or used in the device (local oscillator, intermediated or carrier frequency), or from 10 MHz, whichever is the lowest frequency, to the 10 th harmonic of the highest generated or used frequency.	43+10*log(mean power in watts) dB

6.12.2. Method of Measurements

The spurious/harmonic ERP measurements are using substitution method specified in Exhibit 8, § 8.2 of this report and its value in dBc is calculated as follows:

- If the transmitter's antenna is an integral part of the EUT, the ERP is measured using substitution method.
- If the transmitter's antenna is non-integral and diverse, the lowest ERP of the carrier with 0 dBi antenna gain is used for calculation of the spurious/harmonic emissions in dBc:

$$\text{Lowest ERP of the carrier} = \text{EIRP} - 2.15 \text{ dB} = P_c + G - 2.15 \text{ dB} = P_c \text{ in dBm (conducted)} + 0 \text{ dBi} - 2.15 \text{ dB}$$

- Spurious /harmonic emissions levels expressed in dBc (dB below carrier) are as follows:

$$\text{ERP of spurious/harmonic (dBc)} = \text{ERP of carrier (dBm)} - \text{ERP of spurious/harmonic emission (dBm)}$$

6.12.3. Test Equipment List

Test Instruments	Manufacturer	Model No.	Serial No.	Frequency Range
Spectrum Analyzer/ EMI Receiver	Advantest	R3271	15050203	100 Hz to 32 GHz with external mixer for frequency above 32 GHz
Microwave Amplifier	Hewlett Packard	HP 83017A	3116A00661	1 GHz to 26.5 GHz
Active Loop Antenna	EMCO	6507	8906-1167	1 kHz – 30 MHz
Biconilog Antenna	EMCO	3143	1029	20 MHz to 2 GHz
Horn Antenna	EMCO	3155	9701-5061	1 GHz – 18 GHz
Horn Antenna with Mixer	EMCO	3160-09	1007	18 GHz – 26.5 GHz
Horn Antenna with Mixer	EMCO	3160-10	1001	26.5 GHz – 40 GHz

ULTRATECH GROUP OF LABS

3000 Bristol Circle, Oakville, Ontario, Canada L6H 6G4
Tel. #: 905-829-1570, Fax. #: 905-829-8050, Email: vic@ultratech-labs.com, Website: http://www.ultratech-labs.com

File #: ICOM-071F80
October 7, 2003

All test results contained in this engineering test report are traceable to National Institute of Standards and Technology (NIST)

6.12.4. Test Data

Remark:

Based on the Spurious Emissions at Antenna Terminal, high power yields the worst case spurious emission. Therefore, radiated emissions were performed at High RF Output Power (25 Watts) setting to represents the worst-case test configuration.

6.12.4.1. Lowest Channel Frequency (156.050 MHz)

Test Frequency:	156.050 MHz
RF Output Power:	25 Watts
Limit:	57 dBc
Modulation:	FM with 2.5 sine wave signal
Frequency Test Range:	10 MHz – 2 GHz

All spurious emissions and harmonics were more than 20 dB below the limit.

6.12.4.2. Highest Channel Frequency (157.425 MHz)

Test Frequency:	157.425 MHz
RF Output Power:	25 Watts
Limit:	57 dBc
Modulation:	FM with 2.5 sine wave signal
Frequency Test Range:	10 MHz – 2 GHz

All spurious emissions and harmonics were more than 20 dB below the limit.

EXHIBIT 7. MEASUREMENT UNCERTAINTY

The measurement uncertainties stated were calculated in accordance with the requirements of NIST Technical Note 1297 and NIS 81 (1994)

7.1. RADIATED EMISSION MEASUREMENT UNCERTAINTY

CONTRIBUTION (Radiated Emissions)	PROBABILITY DISTRIBUTION	UNCERTAINTY (+ dB)	
		3 m	10 m
Antenna Factor Calibration	Normal (k=2)	± 1.0	± 1.0
Cable Loss Calibration	Normal (k=2)	± 0.3	± 0.5
EMI Receiver specification	Rectangular	± 1.5	± 1.5
Antenna Directivity	Rectangular	+0.5	+0.5
Antenna factor variation with height	Rectangular	± 2.0	± 0.5
Antenna phase center variation	Rectangular	0.0	± 0.2
Antenna factor frequency interpolation	Rectangular	± 0.25	± 0.25
Measurement distance variation	Rectangular	± 0.6	± 0.4
Site imperfections	Rectangular	± 2.0	± 2.0
Mismatch: Receiver VRC $\Gamma_1 = 0.2$ Antenna VRC $\Gamma_R = 0.67(Bi) 0.3 (Lp)$ Uncertainty limits $20\text{Log}(1 \pm \Gamma_1 \Gamma_R)$	U-Shaped	+1.1 -1.25	± 0.5
System repeatability	Std. Deviation	± 0.5	± 0.5
Repeatability of EUT		-	-
Combined standard uncertainty	Normal	+2.19 / -2.21	+1.74 / -1.72
Expanded uncertainty U	Normal (k=2)	+4.38 / -4.42	+3.48 / -3.44

Calculation for maximum uncertainty when 3m biconical antenna including a factor of k = 2 is used:

$$U = 2u_c(y) = 2x(+2.19) = +4.38 \text{ dB} \quad \text{And} \quad U = 2u_c(y) = 2x(-2.21) = -4.42 \text{ dB}$$

EXHIBIT 8. MEASUREMENT METHODS

8.1. CONDUCTED POWER MEASUREMENTS

The following shall be applied to the combination(s) of the radio device and its intended antenna(e).

- If the RF level is user adjustable, all measurements shall be made with the highest power level available to the user for that combination.
- The following method of measurement shall apply to both conducted and radiated measurements.
 - The radiated measurements are performed at the Ultratech Calibrated Open Field Test Site.
 - The measurement shall be performed using normal operation of the equipment with modulation.
- Test procedure shall be as follows:

Step 1: Duty Cycle measurements if the transmitter's transmission is transient

- Using a EMI Receiver with the frequency span set to 0 Hz and the sweep time set at a suitable value to capture the envelope peaks and the duty cycle of the transmitter output signal;
- The duty cycle of the transmitter, $x = T_x \text{ on} / (T_x \text{ on} + T_x \text{ off})$ with $0 < x < 1$, is measure and recorded in the test report. For the purpose of testing, the equipment shall be operated with a duty cycle that is equal or more than 0.1.

Step 2: Calculation of Average EIRP. See Figure 1

- The average output power of the transmitter shall be determined using a wideband, calibrated RF average power meter with the power sensor with an integration period that exceeds the repetition period of the transmitter by a factor 5 or more. The observed value shall be recorded as "A" (in dBm);
- The e.i.r.p. shall be calculated from the above measured power output "A", the observed duty cycle x , and the applicable antenna assembly gain "G" in dBi, according to the formula:

$$\text{EIRP} = A + G + 10\log(1/x)$$

{ $X = 1$ for continuous transmission $\Rightarrow 10\log(1/x) = 0 \text{ dB}$ }

Figure 1.

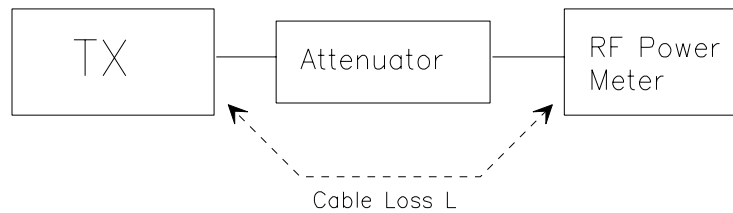

8.2. RADIATED POWER MEASUREMENTS (ERP & EIRP) USING SUBSTITUTION METHOD

8.2.1. Maximizing RF Emission Level (E-Field)

- The measurements was performed with full rf output power and modulation.
- Test was performed at listed 3m open area test site (listed with FCC, IC, ITI, NVLAP, ACA & VCCI).
- The transmitter under test was placed at the specified height on a non-conducting turntable (80 cm height)
- The BICONILOG antenna (20 MHz to 1 GHz) or HORN antenna (1 GHz to 18 GHz) was used for measuring.
- Load an appropriate correction factors file in EMI Receiver for correcting the field strength reading level

Total Correction Factor recorded in the EMI Receiver = Cable Loss + Antenna Factor
E (dBuV/m) = Reading (dBuV) + Total Correction Factor (dB/m)

- Set the EMI Receiver #1 and #2 as follows:

Center Frequency:	test frequency
Resolution BW:	100 kHz
Video BW:	same
Detector Mode:	positive
Average:	off
Span:	3 x the signal bandwidth

- The test antenna was lowered or raised from 1 to 4 meters until the maximum signal level was detected.
- The transmitter was rotated through 360° about a vertical axis until a higher maximum signal was received.
- The test antenna was lowered or raised again from 1 to 4 meters until a maximum was obtained. This level was recorded.
- The recorded reading was corrected to the true field strength level by adding the antenna factor, cable loss and subtracting the pre-amplifier gain.
- The above steps were repeated with both transmitters' antenna and test receiving antenna placed in vertical and horizontal polarization. Both readings with the antennas placed in vertical and horizontal polarization shall be recorded.
- Repeat for all different test signal frequencies

8.2.2. Measuring the EIRP of Spurious/Harmonic Emissions using Substitution Method

- Set the EMI Receiver (for measuring E-Field) and Receiver #2 (for measuring EIRP) as follows:

Center Frequency: equal to the signal source
Resolution BW: 10 kHz
Video BW: same
Detector Mode: positive
Average: off
Span: 3 x the signal bandwidth

- Load an appropriate correction factors file in EMI Receiver for correcting the field strength reading level

Total Correction Factor recorded in the EMI Receiver = Cable Loss + Antenna Factor
 $E \text{ (dBuV/m)} = \text{Reading (dBuV)} + \text{Total Correction Factor (dB/m)}$

- Select the frequency and E-field levels obtained in the Section 8.2.1 for ERP/EIRP measurements.
- Substitute the EUT by a signal generator and one of the following transmitting antenna (substitution antenna):
 - DIPOLE antenna for frequency from 30-1000 MHz or
 - HORN antenna for frequency above 1 GHz }.
- Mount the transmitting antenna at 1.5 meter high from the ground plane.
- Use one of the following antenna as a receiving antenna:
 - DIPOLE antenna for frequency from 30-1000 MHz or
 - HORN antenna for frequency above 1 GHz }.
- If the DIPOLE antenna is used, tune it's elements to the frequency as specified in the calibration manual.
- Adjust both transmitting and receiving antenna in a VERTICAL polarization.
- Tune the EMI Receivers to the test frequency.
- Lower or raise the test antenna from 1 to 4 meters until the maximum signal level was detected.
- The transmitter was rotated through 360° about a vertical axis until a higher maximum signal was received.
- Lower or raise the test antenna from 1 to 4 meters until the maximum signal level was detected.
- Adjust input signal to the substitution antenna until an equal or a known related level to that detected from the transmitter was obtained in the test receiver.
- Record the power level read from the Average Power Meter and calculate the ERP/EIRP as follows:

$$P = P1 - L1 = (P2 + L2) - L1 = P3 + A + L2 - L1$$

$$EIRP = P + G1 = P3 + L2 - L1 + A + G1$$

$$ERP = EIRP - 2.15 \text{ dB}$$

$$\text{Total Correction factor in EMI Receiver \# 2} = L2 - L1 + G1$$

Where: P: Actual RF Power fed into the substitution antenna port after corrected.
P1: Power output from the signal generator
P2: Power measured at attenuator A input
P3: Power reading on the Average Power Meter
EIRP: EIRP after correction
ERP: ERP after correction

- Adjust both transmitting and receiving antenna in a HORIZONTAL polarization, then repeat step (k) to (o)
- Repeat step (d) to (o) for different test frequency
- Repeat steps (c) to (j) with the substitution antenna oriented in horizontal polarization.
- Actual gain of the EUT's antenna is the difference of the measured EIRP and measured RF power at the RF port. Correct the antenna gain if necessary.:

Figure 2

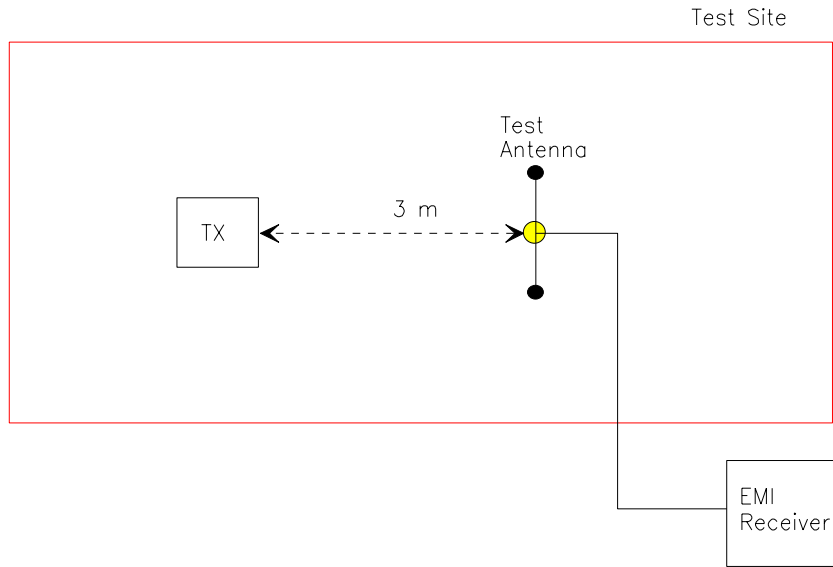
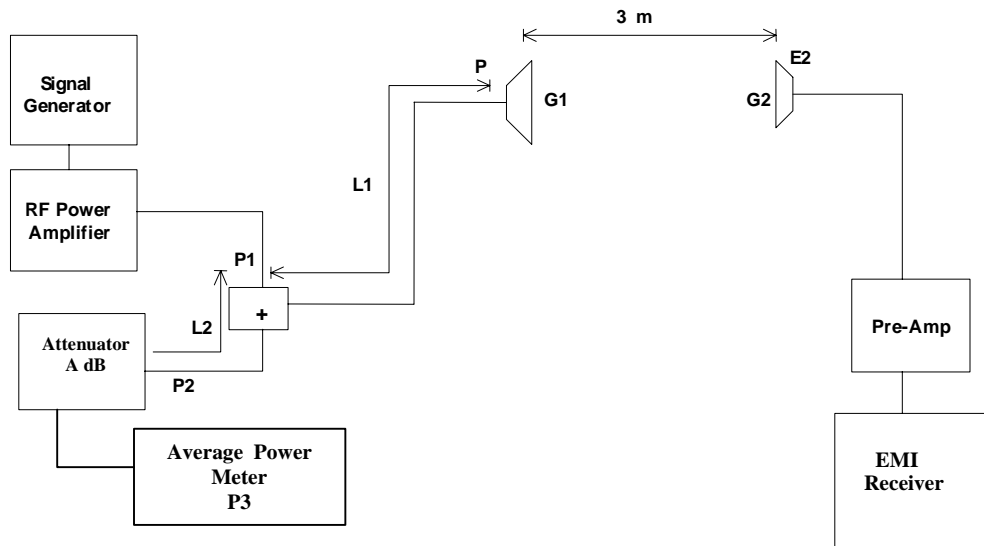

Figure 3



8.3. FREQUENCY STABILITY

Refer to FCC @ 2.1055.

- (a) The frequency stability shall be measured with variation of ambient temperature as follows: From -30 to +50 centigrade except that specified in subparagraph (2) & (3) of this paragraph.
- (b) Frequency measurements shall be made at extremes of the specified temperature range and at intervals of not more than 10 centigrade through the range. A period of time sufficient to stabilize all of the components of the oscillator circuit at each temperature level shall be allowed prior to frequency measurement. The short-term transient effects on the frequency of the transmitter due to keying (except for broadcast transmitters) and any heating element cycling normally occurring at each ambient temperature level also shall be shown. Only the portion or portions of the transmitter containing the frequency determining and stability circuitry need be subjected to the temperature variation test.
- (d) The frequency stability supply shall be measured with variation of primary supply voltage as follows:
 - (1) Vary primary supply voltage from 85 to 115 percent of the nominal value for other than hand carried battery equipment.
 - (2) For hand carried, battery powered equipment, reduce primary supply voltage to the battery operating end point which shall be specified by the manufacturer.
 - (3) The supply voltage shall be measured at the input to the cable normally provide with the equipment, or at the power supply terminals if cables are not normally provided. Effects on frequency of transmitter keying (except for broadcast transmitters) and any heating element cycling at the nominal supply voltage and at each extreme also shall be shown.
- (e) When deemed necessary, the Commission may require tests of frequency stability under conditions in addition to those specifically set out in paragraphs (a), (b), (c) and (d) of this section. (For example, measurements showing the effect of proximity to large metal objects, or of various types of antennas, may be required for portable equipment).

8.4. EMISSION MASK

Voice or Digital Modulation Through a Voice Input Port @ 2.1049(c)(i):- The transmitter was modulated by a 2.5 KHz tone signal at an input level 16 dB greater than that required to produce 50% modulation (e.g.: ± 2.5 KHz peak deviation at 1 KHz modulating frequency). The input level was established at the frequency of maximum response of the audio modulating circuit.

Digital Modulation Through a Data Input Port @ 2.1049(h):- Transmitters employing digital modulation techniques - when modulated by an input signal such that its amplitude and symbol rate represent the maximum rated conditions under which the equipment will be operated. The signal shall be applied through any filter networks, pseudo-random generators or other devices required in normal service. Additionally, the Emission Masks shall be shown for operation with any devices used for modifying the spectrum when such devices are operational at the discretion of the user.

The following EMI Receiver bandwidth shall be used for measurement of Emission Mask/Out-of-Band Emission Measurements:

For 25 kHz Channel Spacing: RBW = 300 Hz
For 12.5 kHz or 6.25 kHz Channel Spacings: RBW = 100 Hz

The all cases the Video Bandwidth shall be equal or greater than the measuring bandwidth.

8.5. SPURIOUS EMISSIONS (CONDUCTED)

With transmitter modulation characteristics described in Out-of-Band Emissions measurements @ 2.1049, the transmitter spurious and harmonic emissions were scanned. The spurious and harmonic emissions were measured with the EMI Receiver controls set as RBW = 30 kHz minimum, VBW \geq RBW and SWEEP TIME = AUTO). The transmitter was operated at a full rated power output, and modulated as follows:

FCC CFR 47, Para. 2.1057 - Frequency spectrum to be investigated:- The spectrum was investigated from the lowest radio generated in the equipment up to at least the 10th harmonic of the carrier frequency or to the highest frequency practicable in the present state of the art of measuring techniques, whichever is lower. Particular attention should be paid to harmonics and subharmonics of the carrier frequency. Radiation at the frequencies of multiplier stages should be checked. The amplitude of spurious emissions which are attenuated more than 20 dB below the permissible value need not be reported.

FCC CFR 47, Para. 2.1051 - Spurious Emissions at Antenna Terminal:- The radio frequency voltage or powers generated within the equipment and appearing on a spurious frequency shall be checked at the equipment output terminals when properly loaded with a suitable artificial antenna. Curves or equivalent data shall show the magnitude of the harmonic and other spurious emission that can be detected when the equipment is operated under the conditions specified in 2.1049 as appropriate. The magnitude of spurious emissions which are attenuated more than 20 dB below the permissible value need not be specified.