



31040/SIT



C-1376

Canada
46390-2049

NVLAP
200093-0



00-034



entela

3000 Bristol Circle,
Oakville, Ontario,
Canada L6H 6G4

Tel.: (905) 829-1570
Fax: (905) 829-8050

Website: www.ultratech-labs.com
Email: vic@ultratech-labs.com

Jan. 24, 2003

ICOM Incorporated
1-1-32, Kamiminami
Hirano-ku, Osaka
Japan, 547-0003

Attn.: Mr. Takahasi Aoki

Subject: Certification Testing in accordance with FCC CFR 47, Parts 2 and 90 (Subpart I) - Non-Broadcast Radio Transceivers Operating in the frequency bands 440-490 MHz (12.5 kHz and 25 kHz Channel Spacings).

Product: MOBILE UHF TRANSCEIVER
Model: IC-F221
FCC ID: AFJ262301

Dear Mr. Aoki,

The product sample has been tested in accordance with **FCC CFR 47, Parts 2 and 90 (Subpart I) - Non-Broadcast Radio Transceivers Operating in the frequency bands 440-490 MHz (12.5 kHz and 25 kHz Channel Spacings)**, and the results and observation were recorded in the engineering report, Our File No.: ICOM-045FCC90

Enclosed you will find copy of the engineering report. If you have any queries, please do not hesitate to contact us.

Yours truly,



Tri Minh Luu, P.Eng
Vice President - Engineering

Encl.

ENGINEERING TEST REPORT

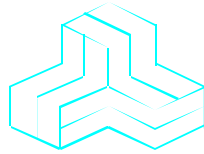

MOBILE UHF TRANSCEIVER (440-490 MHz)

Model No.: IC-F221

FCC ID: AFJ262301

Applicant: **ICOM Incorporated**
1-1-32, Kamiminami
Hirano-ku, Osaka
Japan, 547-0003

Tested in Accordance With

Federal Communications Commission (FCC)
CFR 47, PARTS 2 and 90 (Subpart I)

UltraTech's File No.: ICOM-045FCC90

This Test report is Issued under the Authority of
Tri M. Luu, Professional Engineer,
Vice President of Engineering
UltraTech Group of Labs

Date: Jan. 24, 2003



Report Prepared by: Tri M. Luu, P.Eng.

Tested by: Wayne Wu, RFI Engineer

Issued Date: Jan. 24, 2003

Test Dates: Jan. 19-23, 2003

- The results in this Test Report apply only to the sample(s) tested, and the sample tested is randomly selected.
- This report must not be used by the client to claim product endorsement by NVLAP or any agency of the US Government.

UltraTech

3000 Bristol Circle, Oakville, Ontario, Canada, L6H 6G4

Tel.: (905) 829-1570 Fax.: (905) 829-8050

Website: www.ultratech-labs.com Email: vic@ultratech-labs.com, Email: tri@ultratech-labs.com



31040/SIT



C-1376



46390-2049



200093-0



00-034



TABLE OF CONTENTS

EXHIBIT 1.	SUBMITTAL CHECK LIST.....	4
EXHIBIT 2.	INTRODUCTION	5
2.1.	SCOPE.....	5
2.2.	RELATED SUBMITAL(S)/GRANT(S).....	5
2.3.	NORMATIVE REFERENCES.....	5
EXHIBIT 3.	PERFORMANCE ASSESSMENT	6
3.1.	CLIENT INFORMATION.....	6
3.2.	EQUIPMENT UNDER TEST (EUT) INFORMATION	6
3.3.	EUT'S TECHNICAL SPECIFICATIONS	7
3.4.	LIST OF EUT'S PORTS.....	8
3.5.	ANCILLARY EQUIPMENT	8
3.6.	BLOCK DIAGRAM.....	9
EXHIBIT 4.	EUT OPERATING CONDITIONS AND CONFIGURATIONS DURING TESTS	10
4.1.	CLIMATE TEST CONDITIONS.....	10
4.2.	OPERATIONAL TEST CONDITIONS & ARRANGEMENT FOR TEST SIGNALS	10
EXHIBIT 5.	SUMMARY OF TEST RESULTS.....	11
5.1.	LOCATION OF TESTS	11
5.2.	APPLICABILITY & SUMMARY OF EMISSION TEST RESULTS.....	11
5.3.	MODIFICATIONS INCORPORATED IN THE EUT FOR COMPLIANCE PURPOSES	11
5.4.	DEVIATION OF STANDARD TEST PROCEDURES	11
EXHIBIT 6.	MEASUREMENTS, EXAMINATIONS & TEST DATA FOR EMC EMISSIONS	12
6.1.	TEST PROCEDURES.....	12
6.2.	MEASUREMENT UNCERTAINTIES.....	12
6.3.	MEASUREMENT EQUIPMENT USED:.....	12
6.4.	ESSENTIAL/PRIMARY FUNCTIONS AS DECLARED BY THE MANUFACTURER:.....	12
6.5.	RF POWER OUTPUT @ FCC 2.1046 & 90.205.....	13
6.5.1.	<i>Limits @ FCC 90.205.....</i>	<i>13</i>
6.5.2.	<i>Method of Measurements.....</i>	<i>13</i>
6.5.3.	<i>Test Equipment List</i>	<i>13</i>
6.5.4.	<i>Test Arrangement.....</i>	<i>13</i>
6.5.5.	<i>Test Data.....</i>	<i>14</i>
CONDUCTED POWER AT THE ANTENNA PORT		14
6.6.	RF EXPOSURE REQUIRMENTS @ 1.1310 & 2.1091	15
6.6.1.	<i>Limits.....</i>	<i>15</i>
6.6.2.	<i>Method of Measurements.....</i>	<i>15</i>
6.6.3.	<i>Test Data.....</i>	<i>17</i>
6.7.	FREQUENCY STABILITY @ FCC 2.1055 & 90.213	18
6.7.1.	<i>Limits @ FCC 90.213.....</i>	<i>18</i>
6.7.2.	<i>Method of Measurements.....</i>	<i>18</i>

ULTRATECH GROUP OF LABS

3000 Bristol Circle, Oakville, Ontario, Canada L6H 6G4

Tel. #: 905-829-1570, Fax. #: 905-829-8050, Email: vic@ultratech-labs.com, Website: <http://www.ultratech-labs.com>

File #: ICOM-045FCC90

Jan. 24, 2003

- All test results contained in this engineering test report are traceable to National Institute of Standards and Technology (NIST)

6.7.3.	Test Equipment List	18
6.7.4.	Test Arrangement	18
6.7.5.	Test Data.....	19
6.8.	AUDIO FREQUENCY RESPONSE @ FCC 2.1047(A) & 90.242(B)(8).....	20
6.8.1.	Limits @ FCC 2.1047(a) and 90.242(b)(8).....	20
6.8.2.	Method of Measurements.....	20
6.8.3.	Test Equipment List	20
6.8.4.	Test Arrangement	20
6.8.5.	Test Data.....	21
6.9.	MODULATION LIMITING @ FCC 2.1047(B) & 90.210.....	25
6.9.1.	Limits @ FCC 2.1047(b) and 90.210	25
6.9.2.	Method of Measurements.....	25
6.9.3.	Test Equipment List	25
6.9.4.	Test Arrangement	25
6.9.5.	Test Data.....	26
6.10.	EMISSION MASK @ FCC 2.1049, 90.208 & 90.210.....	30
6.10.1.	Limits @ FCC 90.209 & 90.210	30
6.10.2.	Method of Measurements.....	30
6.10.3.	Test Equipment List	30
6.10.4.	Test Arrangement	30
6.10.5.	Test Data.....	31
6.11.	TRANSMITTER ANTENNA POWER SPURIOUS/HARMONIC CONDUCTED EMISSIONS @ FCC 90.210.....	32
6.11.1.	Limits @ 90.210	32
6.11.2.	Method of Measurements.....	32
6.11.3.	Test Equipment List	32
6.11.4.	Test Arrangement	32
6.11.5.	Test Data.....	33
6.12.	TRANSMITTER SPURIOUS/HARMONIC RADIATED EMISSIONS @ FCC 90.210.....	36
6.12.1.	Limits @ FCC 90.210.....	36
6.12.2.	Method of Measurements.....	36
6.12.3.	Test Equipment List	36
6.12.4.	Test Setup	37
6.12.5.	Test Data.....	37
6.13.	TRANSIENT FREQUENCY BEHAVIOR @ 90.214.....	41
6.13.1.	Limits.....	41
6.13.2.	Method of Measurements.....	41
6.13.3.	Test Equipment List	42
6.13.4.	Test Arrangement	42
6.13.5.	Test Data.....	43
EXHIBIT 7.	MEASUREMENT UNCERTAINTY.....	45
7.1.	RADIATED EMISSION MEASUREMENT UNCERTAINTY.....	45
EXHIBIT 8.	MEASUREMENT METHODS.....	46
8.1.	CONDUCTED POWER MEASUREMENTS.....	46
8.2.	RADIATED POWER MEASUREMENTS (ERP & EIRP) USING SUBSTITUTION METHOD.....	47
8.2.1.	Maximizing RF Emission Level (E-Field)	47
8.2.2.	Measuring the EIRP of Spurious/Harmonic Emissions using Substitution Method.....	48
8.3.	FREQUENCY STABILITY.....	50
8.4.	EMISSION MASK.....	51

ULTRATECH GROUP OF LABS

3000 Bristol Circle, Oakville, Ontario, Canada L6H 6G4

Tel. #: 905-829-1570, Fax. #: 905-829-8050, Email: vic@ultratech-labs.com, Website: <http://www.ultratech-labs.com>

File #: ICOM-045FCC90

Jan. 24, 2003

▪ All test results contained in this engineering test report are traceable to National Institute of Standards and Technology (NIST)

8.5.	SPURIOUS EMISSIONS (CONDUCTED).....	51
8.6.	TRANSIENT FREQUENCY BEHAVIOR.....	52

ULTRATECH GROUP OF LABS

3000 Bristol Circle, Oakville, Ontario, Canada L6H 6G4

Tel. #: 905-829-1570, Fax. #: 905-829-8050, Email: vic@ultratech-labs.com, Website: <http://www.ultratech-labs.com>

File #: ICOM-045FCC90

Jan. 24, 2003

- *All test results contained in this engineering test report are traceable to National Institute of Standards and Technology (NIST)*

EXHIBIT 1. SUBMITTAL CHECK LIST

Annex No.	Exhibit Type	Description of Contents	Quality Check (OK)
--	Test Report	<ul style="list-style-type: none"> Exhibit 1: Submittal check lists Exhibit 2: Introduction Exhibit 3: Performance Assessment Exhibit 4: EUT Operation and Configuration during Tests Exhibit 5: Summary of test Results Exhibit 6: Measurement Data Exhibit 7: Measurement Uncertainty Exhibit 8: Measurement Methods 	OK
1	Test Report - Plots of Measurement Data	Plots # 1 to 44	OK
2	Test Setup Photos	Photos # 1 to 2	OK
3	External Photos of EUT	Photos # 1 to 7	OK
4	Internal Photos of EUT	Photos of 1 to 7	OK
5	Cover Letters	Cover Letters	OK
6	Attestation Statements	<ul style="list-style-type: none"> Letter from the Applicant to appoint Ultratech to act as an agent Letter from the Applicant to request for Confidentiality Filing 	OK
7	ID Label/Location Info	ID Label Location of ID Label	OK OK
8	Block Diagrams	Block diagrams # 1 of 1	OK
9	Schematic Diagrams	Schematic diagrams # 3 of 3	OK
10	Parts List/Tune Up Info	Parts List/Tune Up Info	OK
11	Operational Description	Operational Description	OK
12	RF Exposure Info	RF Exposure Info	OK
13	Users Manual	Users Manual	OK

ULTRATECH GROUP OF LABS

3000 Bristol Circle, Oakville, Ontario, Canada L6H 6G4

Tel. #: 905-829-1570, Fax. #: 905-829-8050, Email: vic@ultratech-labs.com, Website: <http://www.ultratech-labs.com>

File #: ICOM-045FCC90

Jan. 24, 2003

- All test results contained in this engineering test report are traceable to National Institute of Standards and Technology (NIST)

EXHIBIT 2. INTRODUCTION

2.1. SCOPE

Reference:	FCC Parts 2 and 90
Title:	Telecommunication - Code of Federal Regulations, CFR 47, Parts 2 & 90
Purpose of Test:	To gain FCC Certification Authorization for Radio operating in the Frequency Band 440-490 MHz (12.5 kHz and 25 kHz Channel Spacings).
Test Procedures:	Both conducted and radiated emissions measurements were conducted in accordance with American National Standards Institute ANSI C63.4 - American National Standard for Methods of Measurement of Radio-Noise Emissions from Low-Voltage Electrical and Electronic Equipment in the Range of 9 kHz to 40 GHz.

2.2. RELATED SUBMITAL(S)/GRANT(S)

None

2.3. NORMATIVE REFERENCES

Publication	Year	Title
FCC CFR Parts 0-19, 80-End	2001	Code of Federal Regulations – Telecommunication
ANSI C63.4	1992	American National Standard for Methods of Measurement of Radio-Noise Emissions from Low-Voltage Electrical and Electronic Equipment in the Range of 9 kHz to 40 GHz
CISPR 22 & EN 55022	1997 1998	Limits and Methods of Measurements of Radio Disturbance Characteristics of Information Technology Equipment
CISPR 16-1		Specification for Radio Disturbance and Immunity measuring apparatus and methods

ULTRATECH GROUP OF LABS

3000 Bristol Circle, Oakville, Ontario, Canada L6H 6G4

Tel. #: 905-829-1570, Fax. #: 905-829-8050, Email: vic@ultratech-labs.com, Website: <http://www.ultratech-labs.com>

File #: ICOM-045FCC90

Jan. 24, 2003

- All test results contained in this engineering test report are traceable to National Institute of Standards and Technology (NIST)

EXHIBIT 3. PERFORMANCE ASSESSMENT

3.1. CLIENT INFORMATION

APPLICANT	
Name:	Icom Incorporated
Address:	1-1-32, Kamiminami Hirano-ku, Oaska Japan, 547-0003
Contact Person:	Mr. Takashi Aoki Phone #: +81-66-793-5302 Fax #: +81-66-793-0013 Email Address: export@icom.co.jp

MANUFACTURER	
Name:	Icom Incorporated
Address:	1-1-32, Kamiminami Hirano-ku, Oaska Japan, 547-0003
Contact Person:	Mr. Takashi Aoki Phone #: +81-66-793-5302 Fax #: +81-66-793-0013 Email Address: export@icom.co.jp

3.2. EQUIPMENT UNDER TEST (EUT) INFORMATION

The following information (with the exception of the Date of Receipt) has been supplied by the applicant.

Brand Name:	ICOM Incorporated
Product Name:	MOBILE UHF TRANSCEIVER
Model Name or Number:	IC-F221
Serial Number:	008
Type of Equipment:	Non-broadcast Radio Communication Equipment
External Power Supply:	N/A
Transmitting/Receiving Antenna Type:	Non-integral
Primary User Functions of EUT:	Mobile voice communication for occupational use

ULTRATECH GROUP OF LABS

3000 Bristol Circle, Oakville, Ontario, Canada L6H 6G4

Tel. #: 905-829-1570, Fax. #: 905-829-8050, Email: vic@ultratech-labs.com, Website: <http://www.ultratech-labs.com>

File #: ICOM-045FCC90

Jan. 24, 2003

- All test results contained in this engineering test report are traceable to National Institute of Standards and Technology (NIST)

3.3. EUT'S TECHNICAL SPECIFICATIONS

TRANSMITTER	
Equipment Type:	Mobile
Intended Operating Environment:	Commercial, Light Industry & Heavy Industry
Power Supply Requirement:	13.6 Vdc
RF Output Power Rating:	45 Watts High and 4.5 Watts Low
Operating Frequency Range:	440-490 MHz
Number of Channels	128
Output Impedance (RF):	50 Ohms
Channel Spacing:	12.5 kHz and 25 kHz
Occupied Bandwidth (99%):	<ul style="list-style-type: none"> • 7.43 kHz (for 12.5 kHz Channel Spacing) • 11.45 kHz (for 25 kHz Channel Spacing)
Emission Designation*:	11K0F3E and 16K0F3E
Input Impedance (MIC)	600 Ohms
Antenna Connector Type:	BNC

* For an average case of commercial telephony, the Necessary Bandwidth is calculated as follows:

1. For FM Voice Modulation:

Channel Spacing = 12.5 KHz, D = 2.5 KHz max, K = 1, M = 3 KHz

$$B_n = 2M + 2DK = 2(3) + 2(2.5)(1) = \mathbf{11 \text{ KHz}}$$

emission designation: 11K0F3E

Channel Spacing = 25 KHz, D = 5 KHz max, K = 1, M = 3 KHz

$$B_n = 2M + 2DK = 2(3) + 2(5)(1) = \mathbf{16 \text{ KHz}}$$

emission designation: 16K0F3E

RECEIVER	
Power Supply Requirement:	13.6 Vdc
Operating Frequency Range:	440-490 MHz
Number of Channels	128
RF Output Impedance (RF):	50 Ohms
Input Impedance (SP)	600 Ohms
Audio Output Power (Resistive Load)	4.0 W (4 ohms)
Intermediate Frequencies:	1 st : 46.35 MHz, 2 nd : 450 kHz

ULTRATECH GROUP OF LABS

3000 Bristol Circle, Oakville, Ontario, Canada L6H 6G4

Tel. #: 905-829-1570, Fax. #: 905-829-8050, Email: vic@ultratech-labs.com, Website: <http://www.ultratech-labs.com>

File #: ICOM-045FCC90

Jan. 24, 2003

- All test results contained in this engineering test report are traceable to National Institute of Standards and Technology (NIST)

3.4. LIST OF EUT'S PORTS

Port Number	EUT's Port Description	Number of Identical Ports	Connector Type	Cable Type (Shielded/Non-shielded)
1	RF In/Out Port	1	N	Shielded
2	Microphone Port	1	--	Shielded
3	Speaker Port	1	--	Shielded

NOTES:

- (1) *Ports of the EUT which in normal operation were connected to ancillary equipment through interconnecting cables via a representative interconnecting cable to simulate the input/output characteristics. RF input/output was correctly terminated to the 50 Ohm RF Load.*

3.5. ANCILLARY EQUIPMENT

Microphone

- *All test results contained in this engineering test report are traceable to National Institute of Standards and Technology (NIST)*

3.6. BLOCK DIAGRAM

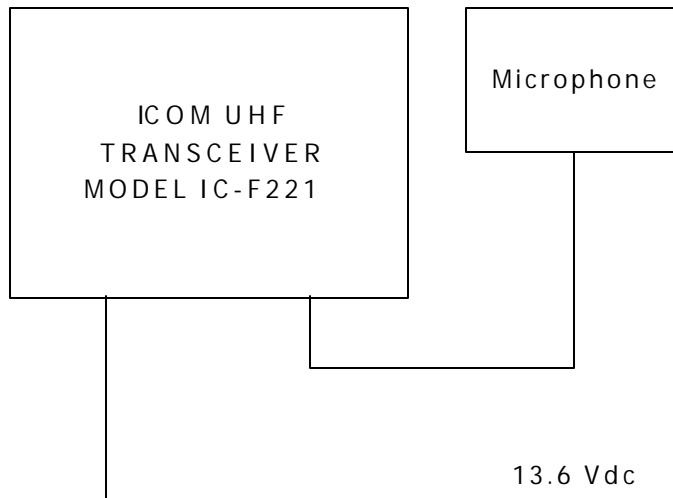

EXHIBIT 4. EUT OPERATING CONDITIONS AND CONFIGURATIONS DURING TESTS

4.1. CLIMATE TEST CONDITIONS

The climate conditions of the test environment are as follows:

Temperature:	21°C
Humidity:	51%
Pressure:	102 kPa
Power input source:	13.6 Vdc

4.2. OPERATIONAL TEST CONDITIONS & ARRANGEMENT FOR TEST SIGNALS

Operating Modes:	The transmitter was operated in a continuous transmission mode with the carrier modulated as specified in the Test Data.
Special Test Software:	N/A
Special Hardware Used:	N/A
Transmitter Test Antenna:	The EUT is tested with the transmitter antenna port terminated to a 50 Ohms RF Load.

Transmitter Test Signals	
Frequency Band(s):	Near lowest, near middle & near highest frequencies in each Frequency Band that the transmitter covers:
<ul style="list-style-type: none"> ▪ 440 - 490 MHz band: 	<ul style="list-style-type: none"> ▪ 440.10, 465.10 and 489.90 MHz
Transmitter Wanted Output Test Signals:	
<ul style="list-style-type: none"> ▪ RF Power Output (measured maximum output power): ▪ Normal Test Modulation ▪ Modulating signal source: 	<ul style="list-style-type: none"> ▪ 45 Watts High and 4.5 Watts Low ▪ FM Voice ▪ external

EXHIBIT 5. SUMMARY OF TEST RESULTS

5.1. LOCATION OF TESTS

All of the measurements described in this report were performed at Ultratech Group of Labs located in the city of Oakville, Province of Ontario, Canada.

- Radiated Emissions were performed at the Ultratech's 3 Meter Open Field Test Site (OFTS) situated in the Town of Oakville, province of Ontario.

The above sites have been calibrated in accordance with ANSI C63.4, and found to be in compliance with the requirements of Sec. 2.948 of the FCC Rules. The descriptions and site measurement data of the Oakville Open Field Test Site has been filed with FCC office (FCC File No.: 31040/SIT 1300B3) and Industry Canada office (Industry Canada File No.: IC2049). Last Date of Site Calibration: Aug. 10, 2002.

5.2. APPLICABILITY & SUMMARY OF EMISSION TEST RESULTS

FCC PARAGRAPH.	TEST REQUIREMENTS	APPLICABILITY (YES/NO)
90.205 & 2.1046	RF Power Output	Yes
1.1307, 1.1310, 2.1091 & 2.1093	RF Exposure Limit	Yes
90.213 & 2.1055	Frequency Stability	Yes
90.242(b)(8) & 2.1047(a)	Audio Frequency Response	Not applicable to new standard. However, tests are conducted under FCC's recommendation.
90.210 & 2.1047(b)	Modulation Limiting	Yes
90.210 & 2.1049	Emission Limitation & Emission Mask	Yes
90.210, 2.1057 & 2.1051	Emission Limits - Spurious Emissions at Antenna Terminal	Yes
90.210, 2.1057 & 2.1053	Emission Limits - Field Strength of Spurious Emissions	Yes
90.214	Transient Frequency Behavior	Yes
MOBILE UHF TRANSCEIVER, Model No.: IC-F221, by ICOM Incorporated has also been tested and found to comply with FCC Part 15, Subpart B - Radio Receivers and Class A Digital Devices. The engineering test report has been documented and kept in file and it is available anytime upon FCC request.		

5.3. MODIFICATIONS INCORPORATED IN THE EUT FOR COMPLIANCE PURPOSES

None

5.4. DEVIATION OF STANDARD TEST PROCEDURES

None

ULTRATECH GROUP OF LABS

3000 Bristol Circle, Oakville, Ontario, Canada L6H 6G4

Tel. #: 905-829-1570, Fax. #: 905-829-8050, Email: vic@ultratech-labs.com, Website: <http://www.ultratech-labs.com>

File #: ICOM-045FCC90

Jan. 24, 2003

- All test results contained in this engineering test report are traceable to National Institute of Standards and Technology (NIST)

EXHIBIT 6. MEASUREMENTS, EXAMINATIONS & TEST DATA FOR EMC EMISSIONS

6.1. TEST PROCEDURES

This section contains test results only. Details of test methods and procedures can be found in Exhibit 8 of this report

6.2. MEASUREMENT UNCERTAINTIES

The measurement uncertainties stated were calculated in accordance with requirements of UKAS Document NIS 81 with a confidence level of 95%. Please refer to Exhibit 7 for Measurement Uncertainties.

6.3. MEASUREMENT EQUIPMENT USED:

The measurement equipment used complied with the requirements of the Standards referenced in the Methods & Procedures ANSI C63.4:1992 and CISPR 16-1.

6.4. ESSENTIAL/PRIMARY FUNCTIONS AS DECLARED BY THE MANUFACTURER:

The essential function of the EUT is to correctly communicate data to and from radios over RF link.

6.5. RF POWER OUTPUT @ FCC 2.1046 & 90.205

6.5.1. Limits @ FCC 90.205

Please refer to FCC CFR 47, Part 90, Subpart I, Para. 90.205 for specification details.

6.5.2. Method of Measurements

Refer to Exhibit 8, § 8.1 (Conducted) and 8.2 (Radiated) of this report for measurement details

6.5.3. Test Equipment List

Test Instruments	Manufacturer	Model No.	Serial No.	Frequency Range
Spectrum Analyzer/ EMI Receiver	Hewlett Packard	HP 8546A	...	9 kHz to 5.6 GHz with built-in 30 dB Gain Pre-selector, QP, Average & Peak Detectors.
Attenuator(s)	Bird	DC – 22 GHz
Power Meter	Hewlett Packard	436A	1725A02249	10 kHz – 50 GHz, sensor dependent
Power Sensor	Hewlett Packard	8481A	2702A68983	10 MHz – 18 GHz

6.5.4. Test Arrangement

- Power at RF Power Output Terminals

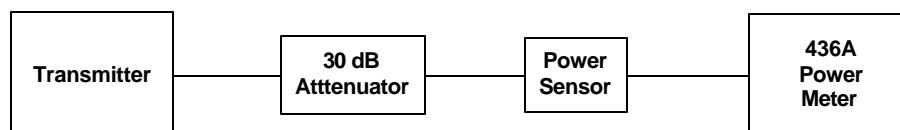

6.5.5. Test Data

Conducted Power at the Antenna Port

Transmitter Channel Output	Fundamental Frequency (MHz)	Measured (Average) Power (Watts)	Power Rating (Watts)
Lowest	440.10	45.0	45.0
Middle	465.10	45.0	45.0
Highest	489.90	44.7	45.0

Transmitter Channel Output	Fundamental Frequency (MHz)	Measured (Average) Power (Watts)	Power Rating (Watts)
Lowest	440.10	4.5	4.5
Middle	465.10	4.8	4.5
Highest	489.90	4.7	4.5

- *All test results contained in this engineering test report are traceable to National Institute of Standards and Technology (NIST)*

6.6. RF EXPOSURE REQUIRMENTS @ 1.1310 & 2.1091

6.6.1. Limits

- **FCC 1.1310**:- The criteria listed in the following table shall be used to evaluate the environmental impact of human exposure to radio-frequency (RF) radiation as specified in 1.1307(b).

LIMITS FOR MAXIMUM PERMISSIBLE EXPOSURE (MPE)				
Frequency Range (MHz)	Electric Field Strength (V/m)	Magnetic Field Strength (A/m)	Power Density (mW/cm ²)	Average Time (minutes)
(A) Limits for Occupational/Control Exposures				
300-1500	F/300	6
(B) Limits for General Population/Uncontrolled Exposure				
300-1500	F/1500	6

F = Frequency in MHz

6.6.2. Method of Measurements

Refer to FCC @ 1.1310, 2.1091 and Public Notice DA 00-705 (March 30, 2000)

- In order to demonstrate compliance with MPE requirements (see Section 2.1091), the following information is typically needed:
 - (1) Calculation that estimates the minimum separation distance (20 cm or more) between an antenna and persons required to satisfy power density limits defined for free space.
 - (2) Antenna installation and device operating instructions for installers (professional/unskilled users), and the parties responsible for ensuring compliance with the RF exposure requirement
 - (3) Any caution statements and/or warning labels that are necessary in order to comply with the exposure limits
 - (4) Any other RF exposure related issues that may affect MPE compliance

- *All test results contained in this engineering test report are traceable to National Institute of Standards and Technology (NIST)*

Calculation Method of RF Safety Distance:

$$S = PG/4\pi r^2 = EIRP/4\pi r^2$$

Where: P: power input to the antenna in mW
EIRP: Equivalent (effective) isotropic radiated power.
S: power density mW/cm²
G: numeric gain of antenna relative to isotropic radiator
r: distance to centre of radiation in cm

FCC radio frequency exposure limits may be exceeded at distances closer than r cm from the antenna of this device

$$r = \sqrt{PG/4\pi S}$$

FCC radio frequency exposure limits may not be exceeded at distances closer than r cm from the antenna of this device

- For portable transmitters (see Section 2.1093), or devices designed to operate next to a person's body, compliance is determined with respect to the SAR limit (define in the body tissues) for near-field exposure conditions. If the maximum average output power, operating condition configurations and exposure conditions are comparable to those of existing cellular and PCS phones., an SAR evaluation may be required in order to determine if such a device complies with SAR limit. When SAR evaluation data is not available, and the additional supporting information cannot assure compliance, the Commission may request that an SAR evaluation be performed, as provided for in Section 1.1307(d)

6.6.3. Test Data

Antenna Gain Limit specified by Manufacturer: 0 dBi

6.6.3.1. Antenna Separation Distance for Operators (Occupational/Control Exposures)

The following separation distance calculation is applied for the trained users or operators:

Frequency Range (MHz)	Peak Measured RF Conducted Power (Watts)	Average Measured RF Conducted Power with 50% Duty Cycle (Watts)	Average Calculated EIRP (Watts)	Laboratory's Recommended Minimum RF Safety Distance r (cm)
440 - 490	45.0	22.5	22.5	34.9

Note 1: RF EXPOSURE DISTANCE LIMITS: $r = (PG/4PS)^{1/2} = (EIRP/4PS)^{1/2}$
 $S = F/300 = 440.10/300 = 1.467 \text{ W/cm}^2$

6.6.3.2. Antenna Separation for Bystanders (General Population/Uncontrolled Exposure)

The following separation distance calculation is applied for the bystanders:

Frequency Range (MHz)	Peak Measured RF Conducted Power (Watts)	Average Measured RF Conducted Power with 50% Duty Cycle (Watts)	Average Calculated EIRP (Watts)	Laboratory's Recommended Minimum RF Safety Distance r (cm)
440 - 490	45.0	22.5	22.5	78.1

Note 1: RF EXPOSURE DISTANCE LIMITS: $r = (PG/4PS)^{1/2} = (EIRP/4PS)^{1/2}$
 $S = F/300 = 440.10/1500 = 0.2934 \text{ W/cm}^2$

Evaluation of RF Exposure Compliance Requirements	
RF Exposure Requirements	Compliance with FCC Rules
Minimum calculated separation distance between antenna and persons required: 34.9 cm for operators and 78.1 cm for bystanders	Manufacturer' instruction for separation distance between antenna and persons required: 79 cm (for both operators and bystanders) Please refer to page # 15 of the Users Manual
Caution statements and/or warning labels that are necessary in order to comply with the exposure limits	Please refer to page # 15 of the Users Manual for RF Safety Training

6.7. FREQUENCY STABILITY @ FCC 2.1055 & 90.213

6.7.1. Limits @ FCC 90.213

Please refer to FCC CFR 47, Part 90, Subpart I, Para. 90.213 for specification details.

FREQUENCY RANGE (MHz)	MOBILE STATIONS (ppm)	
	> 2 W	
	12.5 kHz	25 kHz
403-512 MHz	2.5	5.0

6.7.2. Method of Measurements

Refer to Exhibit 8, § 8.3 of this report for measurement details

6.7.3. Test Equipment List

Test Instruments	Manufacturer	Model No.	Serial No.	Frequency Range
EMI Receiver/ EMI Receiver	Hewlett Packard	HP 8593EM	3412A00103	9 kHz – 26.5 GHz
Attenuator(s)	Bird	DC – 22 GHz
Temperature & Humidity Chamber	Tenney	T5	9723B	-40° to +60° C range

6.7.4. Test Arrangement

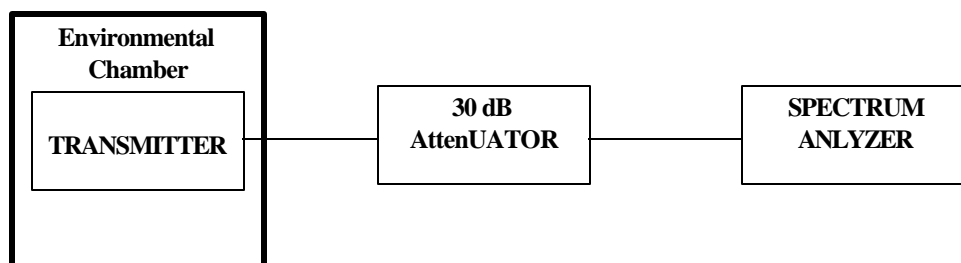

6.7.5. Test Data

Product Name:	MOBILE UHF TRANSCEIVER
Model No.:	IC-F221
Center Frequency:	440.10 MHz
Full Power Level:	45.0 Watts
Frequency Tolerance Limit:	2.5 ppm or 1100 Hz at 440.10 MHz
Max. Frequency Tolerance Measured:	+724 Hz or +1.65 ppm
Input Voltage Rating:	13.6 Vdc

CENTER FREQUENCY & RF POWER OUTPUT VARIATION			
Ambient Temperature (°C)	Supply Voltage (Nominal) 13.6 Volts dc	Supply Voltage (85% of Nominal) 11.6 Volts	Supply Voltage (115% of Nominal) 15.6 Volts dc
	Hz	Hz	Hz
-30	+724	N/A	N/A
-20	+664	N/A	N/A
-10	+335	N/A	N/A
0	+536	N/A	N/A
+10	+290	N/A	N/A
+20	-21	+137	+142
+30	-98	N/A	N/A
+40	-30	N/A	N/A
+50	-373	N/A	N/A

6.8. AUDIO FREQUENCY RESPONSE @ FCC 2.1047(A) & 90.242(B)(8)

6.8.1. Limits @ FCC 2.1047(a) and 90.242(b)(8)

Recommended audio filter attenuation characteristics are give below:

RF Band	Audio band	Minimum Attenuation Rel. to 1 kHz Attenuation
406.1 – 960 MHz	3 –20 kHz 20 – 30 kHz	$60 \log_{10}(f/3)$ dB where f is in kHz 50dB

6.8.2. Method of Measurements

The rated audio input signal was applied to the input of the audio lowpass filter (or of all modulation stages) using an audio oscillator, this input signal level and its corresponding output signal were then measured and recorded using the FFT (Audio) EMI Receiver. Tests were repeated at different audio signal frequencies from 0 to 50 kHz.

6.8.3. Test Equipment List

Test Instruments	Manufacturer	Model No.	Serial No.	Frequency Range
FFT (audio) EMI Receiver	Advantest	R9211E	...	10 mHz – 100 kHz, 1 MHz Input Impedance
Audio Oscillator	Hewlett Packard	HP 204C	0989A08798	DC to 1.2 MHz

6.8.4. Test Arrangement

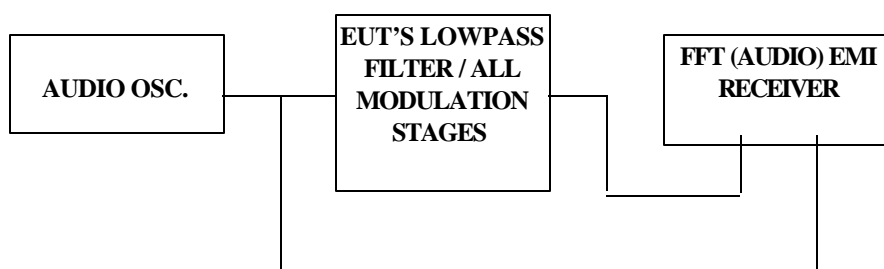

6.8.5. Test Data

6.8.5.1. 12.5 kHz Channel Spacing, F3E, Frequency of All Modulation States*

Note: Because of the difficulty of measuring the Frequency Response of the internal lowpass filter, the Frequency Response of All Modulation States are performed to show the roll-off at 3 kHz in comparison with FCC Limit for audio lowpass filter.

FREQUENCY (kHz)	AUDIO IN (dBV)	AUDIO OUT (dBV)	ATTEN. (OUT - IN) (dB)	ATTEN. wrt. 1 kHz (dB)	FCC LIMIT (dB)	PASS/ FAIL
0.10	-42.7	<-60.0	<-17.3	<-57.4	--	--
0.20	-42.7	-23.5	19.2	-20.9	--	--
0.40	-42.7	-14.4	28.3	-11.8	--	--
0.60	-42.7	-8.5	34.2	-5.9	--	--
0.80	-42.7	-4.8	37.9	-2.2	--	--
1.00	-42.7	-2.6	40.1	0.0	--	--
1.50	-42.7	0.1	42.8	2.7	--	--
2.00	-42.7	2.1	44.8	4.7	--	--
2.50	-42.7	1.1	43.8	3.7	--	--
3.00	-42.7	-2.3	40.4	0.3	0.0	PASS
3.50	-42.7	-7.8	34.9	-5.2	-4.0	PASS
4.00	-42.7	-13.4	29.3	-10.8	-7.5	PASS
4.50	-42.7	-18.7	24.0	-16.1	-10.6	PASS
5.00	-42.7	-23.7	19.0	-21.1	-13.3	PASS
6.00	-42.7	-32.5	10.2	-29.9	-18.1	PASS
7.00	-42.7	<-60.0	<-17.3	<-57.4	-22.1	PASS
8.00	-42.7	<-60.0	<-17.3	<-57.4	-25.6	PASS
9.00	-42.7	<-60.0	<-17.3	<-57.4	-28.6	PASS
10.00	-42.7	<-60.0	<-17.3	<-57.4	-31.4	PASS
16.00	-42.7	<-60.0	<-17.3	<-57.4	-43.6	PASS
18.00	-42.7	<-60.0	<-17.3	<-57.4	-50.0	PASS
20.00	-42.7	<-60.0	<-17.3	<-57.4	-50.0	PASS
25.00	-42.7	<-60.0	<-17.3	<-57.4	-50.0	PASS
30.00	-42.7	<-60.0	<-17.3	<-57.4	-50.0	PASS
35.00	-42.7	<-60.0	<-17.3	<-57.4	-50.0	PASS
40.00	-42.7	<-60.0	<-17.3	<-57.4	-50.0	PASS
50.00	-42.7	<-60.0	<-17.3	<-57.4	-50.0	PASS

AUDIO FREQUENCY RESPONSE OF ALL MODULATION STAGES
@ FCC 2.1047(a) and 90.242(b)(8)
ICOM UHF Transceiver, Model IC-F221 [12.5 kHz Channel Spacing]

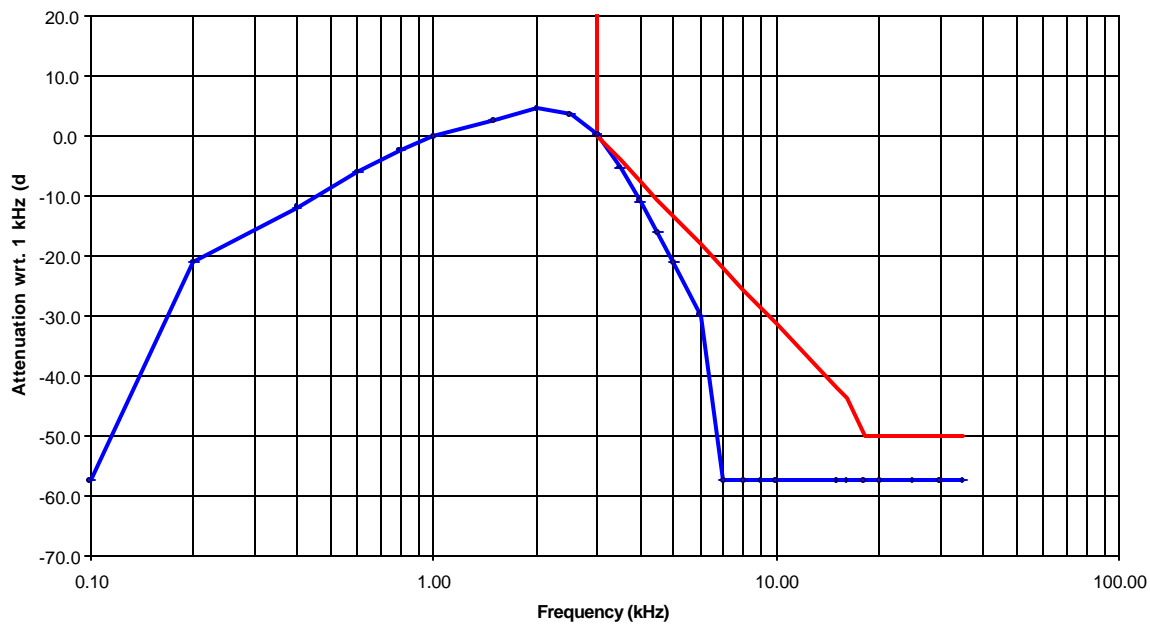

ULTRATECH GROUP OF LABS

3000 Bristol Circle, Oakville, Ontario, Canada L6H 6G4

Tel. #: 905-829-1570, Fax. #: 905-829-8050, Email: vic@ultratech-labs.com, Website: <http://www.ultratech-labs.com>

File #: ICOM-045FCC90

Jan. 24, 2003

- All test results contained in this engineering test report are traceable to National Institute of Standards and Technology (NIST)

6.8.5.2. 25 kHz Channel Spacing, F3E, Frequency of All Modulation States*

Note: Because of the difficulty of measuring the Frequency Response of the internal lowpass filter, the Frequency Response of All Modulation States are performed to show the roll-off at 3 kHz in comparison with FCC Limit for audio lowpass filter.

FREQUENCY (kHz)	AUDIO IN (dBV)	AUDIO OUT (dBV)	ATTEN. (OUT - IN) (dB)	ATTEN. wrt. 1 kHz (dB)	FCC LIMIT (dB)	PASS/ FAIL
0.10	-40.8	-45.1	-4.3	-50.1	--	--
0.20	-40.8	-16.4	24.4	-21.4	--	--
0.40	-40.8	-6.9	33.9	-11.9	--	--
0.60	-40.8	-1.1	39.7	-6.1	--	--
0.80	-40.8	2.6	43.4	-2.4	--	--
1.00	-40.8	5.0	45.8	0.0	--	--
1.50	-40.8	7.8	48.6	2.8	--	--
2.00	-40.8	8.6	49.4	3.6	--	--
2.50	-40.8	7.4	48.2	2.4	--	--
3.00	-40.8	4.9	45.7	-0.1	0.0	PASS
3.50	-40.8	-0.2	40.6	-5.2	-4.0	PASS
4.00	-40.8	-5.5	35.3	-10.5	-7.5	PASS
4.50	-40.8	-10.7	30.1	-15.7	-10.6	PASS
5.00	-40.8	-15.6	25.2	-20.6	-13.3	PASS
6.00	-40.8	-24.4	16.4	-29.4	-18.1	PASS
7.00	-40.8	-32.7	8.1	-37.7	-22.1	PASS
8.00	-40.8	<-60.0	<-19.2	<-65.0	-25.6	PASS
9.00	-40.8	<-60.0	<-19.2	<-65.0	-28.6	PASS
10.00	-40.8	<-60.0	<-19.2	<-65.0	-31.4	PASS
16.00	-40.8	<-60.0	<-19.2	<-65.0	-43.6	PASS
18.00	-40.8	<-60.0	<-19.2	<-65.0	-50.0	PASS
20.00	-40.8	<-60.0	<-19.2	<-65.0	-50.0	PASS
25.00	-40.8	<-60.0	<-19.2	<-65.0	-50.0	PASS
30.00	-40.8	<-60.0	<-19.2	<-65.0	-50.0	PASS
35.00	-40.8	<-60.0	<-19.2	<-65.0	-50.0	PASS
40.00	-40.8	<-60.0	<-19.2	<-65.0	-50.0	PASS
50.00	-40.8	<-60.0	<-19.2	<-65.0	-50.0	PASS

▪ All test results contained in this engineering test report are traceable to National Institute of Standards and Technology (NIST)

AUDIO FREQUENCY RESPONSE OF ALL MODULATION STAGES
@ FCC 2.1047(a) and 90.242(b)(8)
ICOM UHF Transceiver, Model IC-F221 [25 kHz Channel Spacing]

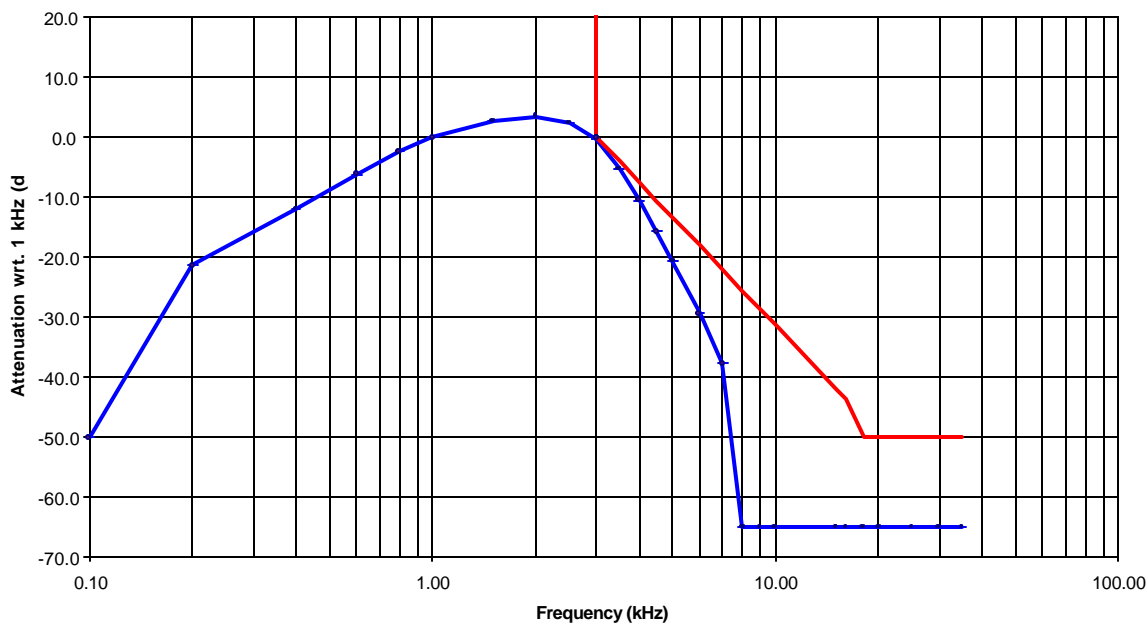

ULTRATECH GROUP OF LABS

3000 Bristol Circle, Oakville, Ontario, Canada L6H 6G4

Tel. #: 905-829-1570, Fax. #: 905-829-8050, Email: vic@ultratech-labs.com, Website: <http://www.ultratech-labs.com>

File #: ICOM-045FCC90

Jan. 24, 2003

- All test results contained in this engineering test report are traceable to National Institute of Standards and Technology (NIST)

6.9. MODULATION LIMITING @ FCC 2.1047(B) & 90.210

6.9.1. Limits @ FCC 2.1047(b) and 90.210

Recommended frequency deviation characteristics are give below:

- 2.5 kHz for 12.5 kHz Channel Spacing
- 5 kHz for 25 kHz Channel Spacing System

6.9.2. Method of Measurements

For Audio Transmitter:- The carrier frequency deviation was measured with the tone input signal level varied from 0 Vp to audio input rating level plus 16 dB at frequencies 0.1, 0.5, 1.0, 3.0 and 5.0 kHz. The maximum deviation was recorded at each test condition.

For Data Transmitter with Maximum Frequency Deviation set by Factory:- The EUT was set at maximum frequency deviation, and its peak frequency deviation was then measured using EUT's internal random data source.

6.9.3. Test Equipment List

Test Instruments	Manufacturer	Model No.	Serial No.	Frequency Range
Communication Analyzer	Rohde & Schawrz	SMF02	879988/057	400 kHz - 1000 MHz including AF & RF Signal Generators, SINAD, DISTORTION, DEVIATION meters and etc

6.9.4. Test Arrangement

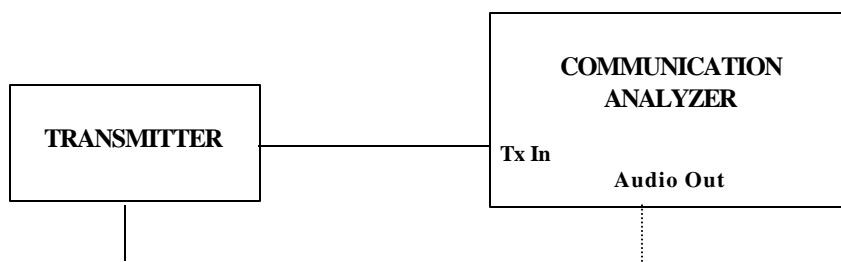

6.9.5. Test Data

6.9.5.1. Voice Modulation Limiting for 12.5 kHz Channel Spacing Operation:

MODULATING SIGNAL LEVEL (mVrms)	PEAK FREQUENCY DEVIATION (kHz) at the following modulating frequency:					MAXIMUM LIMIT (kHz)
	0.1 kHz	0.5 kHz	1.0 kHz	3.0 kHz	5.0 kHz	
2	0.84	0.84	0.92	1.02	0.82	2.5
4	0.85	0.89	1.10	1.20	0.82	2.5
6	0.85	0.94	1.36	1.40	0.83	2.5
8	0.83	1.00	1.60	1.50	0.82	2.5
10	0.83	1.08	1.79	1.57	0.82	2.5
12	0.83	1.14	1.88	1.60	0.78	2.5
14	0.83	1.20	1.95	1.62	0.77	2.5
16	0.82	1.30	1.97	1.56	0.72	2.5
18	0.83	1.35	2.00	1.57	0.68	2.5
20	0.83	1.50	2.01	1.57	0.63	2.5
25	0.83	1.60	2.02	1.57	0.53	2.5
30	0.83	1.89	2.04	1.50	0.48	2.5
35	0.83	1.92	2.04	1.43	0.45	2.5
40	0.83	1.91	2.04	1.43	0.39	2.5
45	0.83	1.91	2.05	1.47	0.39	2.5
50	0.83	1.91	2.05	1.44	0.39	2.5

Voice Signal Input Level = STD MOD Level + 16 dB = 16.9 dBmVrms + 16 = 32.9 dBmVrms

MODULATING FREQUENCY (KHz)	PEAK FREQUENCY DEVIATION (KHz)	MAXIMUM LIMIT (KHz)
0.1	0.83	2.5
0.2	1.10	2.5
0.4	2.00	2.5
0.6	2.02	2.5
0.8	2.09	2.5
1.0	2.05	2.5
1.2	2.00	2.5
1.4	2.00	2.5
1.6	2.06	2.5
1.8	2.08	2.5
2.0	2.7	2.5
2.5	1.79	2.5
3.0	1.47	2.5
3.5	0.91	2.5
4.0	0.61	2.5
4.5	0.47	2.5
5.0	0.39	2.5
6.0	0.32	2.5
7.0	0.42	2.5
8.0	0.58	2.5
9.0	0.79	2.5
10.0	0.78	2.5

ULTRATECH GROUP OF LABS

3000 Bristol Circle, Oakville, Ontario, Canada L6H 6G4

Tel. #: 905-829-1570, Fax. #: 905-829-8050, Email: vic@ultratech-labs.com, Website: <http://www.ultratech-labs.com>

File #: ICOM-045FCC90

Jan. 24, 2003

- All test results contained in this engineering test report are traceable to National Institute of Standards and Technology (NIST)

6.9.5.2. Voice Modulation Limiting for 25 kHz Channel Spacing Operation:

MODULATING SIGNAL LEVEL (mVrms)	PEAK FREQUENCY DEVIATION (kHz) at the following modulating frequency:					MAXIMUM LIMIT (kHz)
	0.1 kHz	0.5 kHz	1.0 kHz	3.0 kHz	5.0 kHz	
2	1.38	1.40	1.50	1.58	1.38	5.0
4	1.38	1.47	1.91	1.94	1.39	5.0
6	1.39	1.55	2.44	2.26	1.38	5.0
8	1.37	1.72	2.88	2.82	1.37	5.0
10	1.38	1.91	3.37	2.90	1.38	5.0
12	1.36	1.94	3.50	2.89	1.30	5.0
14	1.35	2.11	3.64	2.91	1.20	5.0
16	1.34	2.23	3.81	2.89	1.13	5.0
18	1.34	2.51	3.82	2.89	1.02	5.0
20	1.34	2.83	3.89	2.87	0.97	5.0
25	1.33	3.33	3.93	2.80	0.87	5.0
30	1.34	3.85	4.00	2.78	0.78	5.0
35	1.34	3.62	4.00	2.78	0.78	5.0
40	1.36	3.68	4.02	2.79	0.73	5.0
45	1.34	3.66	4.02	2.81	0.70	5.0
50	1.34	3.91	4.03	2.70	0.70	5.0

- All test results contained in this engineering test report are traceable to National Institute of Standards and Technology (NIST)

Voice Signal Input Level = STD MOD Level + 16 dB = 19.08 dBmVrms + 16 = 35.08 dBmVrms

MODULATING FREQUENCY (KHz)	PEAK FREQUENCY DEVIATION (KHz)	MAXIMUM LIMIT (KHz)
0.1	1.36	5.0
0.2	2.07	5.0
0.4	3.94	5.0
0.6	4.04	5.0
0.8	4.11	5.0
1.0	4.01	5.0
1.2	3.90	5.0
1.4	3.89	5.0
1.6	3.99	5.0
1.8	4.03	5.0
2.0	3.96	5.0
2.5	3.36	5.0
3.0	2.64	5.0
3.5	1.68	5.0
4.0	1.11	5.0
4.5	0.81	5.0
5.0	0.64	5.0
6.0	0.52	5.0
7.0	0.55	5.0
8.0	0.73	5.0
9.0	1.10	5.0
10.0	1.23	5.0

ULTRATECH GROUP OF LABS

3000 Bristol Circle, Oakville, Ontario, Canada L6H 6G4

Tel. #: 905-829-1570, Fax. #: 905-829-8050, Email: vic@ultratech-labs.com, Website: <http://www.ultratech-labs.com>

File #: ICOM-045FCC90

Jan. 24, 2003

- All test results contained in this engineering test report are traceable to National Institute of Standards and Technology (NIST)

6.10. EMISSION MASK @ FCC 2.1049, 90.208 & 90.210

6.10.1. Limits @ FCC 90.209 & 90.210

Emissions shall be attenuated below the mean output power of the transmitter as follows:

Frequency Range (MHz)	Maximum Authorized BW (KHz)	Channel Spacing (KHz)	Recommended Frequency Deviation (KHz)	FCC Applicable Mask
403-512	20.0	25.0	5.0	<ul style="list-style-type: none"> Mask B – Voice Mask C – Data
403-512	11.25	12.5	2.5	<ul style="list-style-type: none"> Mask D – Voice & Data
403-512	6.0	6.25	1.25	<ul style="list-style-type: none"> Mask E – Voice & Data

6.10.2. Method of Measurements

Refer to Exhibit 8, § 8.4 of this report for measurement details

6.10.3. Test Equipment List

Test Instruments	Manufacturer	Model No.	Serial No.	Frequency Range
EMI Receiver/ EMI Receiver	Hewlett Packard	HP 8593EM	3412A00103	9 kHz – 26.5 GHz
Attenuator(s)	Bird	DC – 22 GHz
Audio Oscillator	Hewlett Packard	HP 204C	0989A08798	DC to 1.2 MHz

6.10.4. Test Arrangement

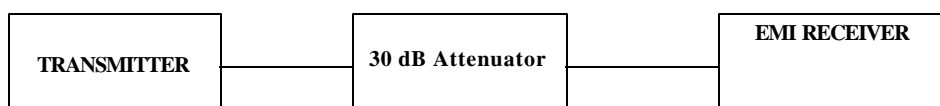

6.10.5. Test Data

6.10.5.1. 99% Occupied Bandwidth

Conform. Please refer to Plots # 1 through # 6 in Annex 1 for Details of measurements

Frequency (MHz)	Channel Spacing (kHz)	Measured 99% OBW (kHz)	Recommended Maximum 99% OBW (kHz)
440.10	12.5	7.3	11.25
465.10	12.5	7.5	11.25
489.90	12.5	7.5	11.25
440.10	25.0	11.5	20.0
465.10	25.0	11.7	20.0
489.90	25.0	11.5	20.0

6.10.5.2. Emission Masks

Conform. Please refer to Plots # 7 through # 18 in Annex 1 for Details of measurements

- Plots 7 to 9 in Annex 1 show Emissions Masks D for operation at lowest, middle and highest channel frequencies at low power setting (4.5 Watts)
- Plots 10 to 12 in Annex 1 show Emissions Masks D for operation at lowest, middle and highest channel frequencies at low power setting (45 Watts)
- Plots 13 to 15 in Annex 1 show Emissions Masks B for operation at lowest, middle and highest channel frequencies at low power setting (4.5 Watts)
- Plots 16 to 18 in Annex 1 show Emissions Masks B for operation at lowest, middle and highest channel frequencies at low power setting (45 Watts)

- All test results contained in this engineering test report are traceable to National Institute of Standards and Technology (NIST)

6.11. TRANSMITTER ANTENNA POWER SPURIOUS/HARMONIC CONDUCTED EMISSIONS @ FCC 90.210

6.11.1. Limits @ 90.210

Emissions shall be attenuated below the mean output power of the transmitter as follows:

FCC Rules	Frequency Range	Attenuation Limit (dBc)
90.210(b)&(c) – Voice & data	10 MHz to Lowest frequency of the radio to 10 th harmonic of the highest frequency of the radio	43+10*log(P) or -13 dBm
90.210(d) – Voice & data	10 MHz to Lowest frequency of the radio to 10 th harmonic of the highest frequency of the radio	50+10*log(P) or -20 dBm or 70 dBc whichever is less

6.11.2. Method of Measurements

Refer to Exhibit 8 § 8.5 of this report for measurement details

6.11.3. Test Equipment List

Test Instruments	Manufacturer	Model No.	Serial No.	Frequency Range
EMI Receiver/ EMI Receiver	Hewlett Packard	HP 8593EM	3412A00103	9 kHz – 26.5 GHz
Attenuator(s)	Bird	DC – 22 GHz
Audio Oscillator	Hewlett Packard	HP 204C	0989A08798	DC to 1.2 MHz
Highpass Filter, Microphase	Microphase	CR220HID	IIT111000AC	Cut-off Frequency at 600 MHz, 1.3 GHz or 4 GHz

6.11.4. Test Arrangement

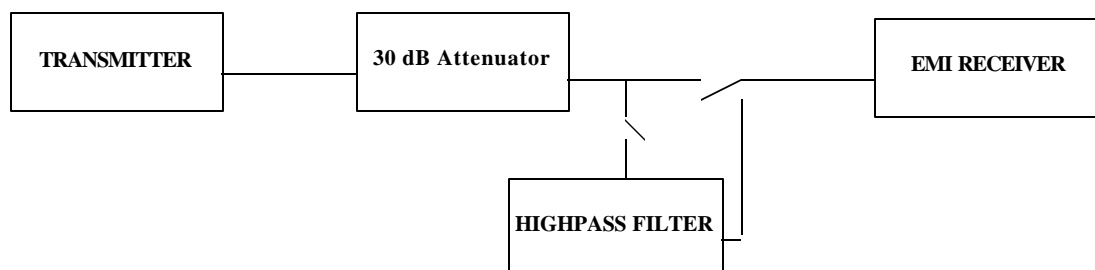

6.11.5. Test Data

Note: Since there was no difference in spurious/harmonic emissions based on our prescans, the rf spurious/harmonic emissions in this section would be performed for 12.5 kHz Channel Spacing and the lower Limit of $50 + 10 \cdot \log(P)$ would be applied for worst case.

6.11.5.1. Lowest Frequency at Low Output Power (Tx Freq: 440.10 MHz, RF Output Power 36.4 dBm, Modulation: FM with 2.5 kHz Sine Wave Signal, Channel Spacing Setting: 12.5 kHz)

FREQUENCY (MHz)	TRANSMITTER CONDUCTED ANTENNA EMISSIONS		LIMIT (dBc)	MARGIN (dB)	PASS/ FAIL
	(dBm)	(dBc)			
440.01	36.4	--	--	--	--
880.11	-42.9	-79.3	-56.4	-22.9	PASS

The emissions were scanned from 10 MHz to 5 GHz. All emissions less than 30 dB below the limits were found. Please refer to Plots 19 and 21 in Annex 1 for detailed measurements.

6.11.5.2. Middle Frequency at Low Output Power (Tx Freq: 465.1 MHz, RF Output Power 36.6 dBm, Modulation: FM with 2.5 kHz Sine Wave Signal, Channel Spacing Setting: 12.5 kHz)

FREQUENCY (MHz)	TRANSMITTER CONDUCTED ANTENNA EMISSIONS		LIMIT (dBc)	MARGIN (dB)	PASS/ FAIL
	(dBm)	(dBc)			
465.10	36.6	--	--	--	--
930.20	-31.5	-68.1	-56.6	-11.5	PASS

The emissions were scanned from 10 MHz to 5 GHz. All emissions less than 30 dB below the limits were found. Please refer to Plots 22 and 24 in Annex 1 for detailed measurements.

6.11.5.3. Highest Frequency at Low Output Power (Tx Freq: 489.9 MHz, RF Output Power 36.3 dBm, Modulation: FM with 2.5 kHz Sine Wave Signal, Channel Spacing Setting: 12.5 kHz)

FREQUENCY (MHz)	TRANSMITTER CONDUCTED ANTENNA EMISSIONS		LIMIT (dBc)	MARGIN (dB)	PASS/ FAIL
	(dBm)	(dBc)			
489.90	36.3	--	--	--	--
979.80	-42.8	-79.1	-56.3	-22.8	PASS

The emissions were scanned from 10 MHz to 5 GHz. All emissions less than 30 dB below the limits were found. Please refer to Plots 25 and 27 in Annex 1 for detailed measurements.

6.11.5.4. Lowest Frequency at High Output Power (Tx Freq: 440.10 MHz, RF Output Power 46.5 dBm, Modulation: FM with 2.5 kHz Sine Wave Signal, Channel Spacing Setting: 12.5 kHz)

FREQUENCY (MHz)	TRANSMITTER CONDUCTED ANTENNA EMISSIONS		LIMIT (dBc)	MARGIN (dB)	PASS/ FAIL
	(dBm)	(dBc)			
440.01	46.5	--	--	--	--
880.02	-42.8	-89.3	-66.5	-22.8	PASS

The emissions were scanned from 10 MHz to 5 GHz. All emissions less than 30 dB below the limits were found. Please refer to Plots 28 and 30 in Annex 1 for detailed measurements.

6.11.5.5. Middle Frequency at High Output Power (Tx Freq: 465.1 MHz, RF Output Power 46.5 dBm, Modulation: FM with 2.5 kHz Sine Wave Signal, Channel Spacing Setting: 12.5 kHz)

FREQUENCY (MHz)	TRANSMITTER CONDUCTED ANTENNA EMISSIONS		LIMIT (dBc)	MARGIN (dB)	PASS/ FAIL
	(dBm)	(dBc)			
465.10	46.5	--	--	--	--
930.20	-32.5	-79.0	-66.5	-12.5	PASS
1395.30	-39.8	-86.3	-66.5	-19.8	PASS

The emissions were scanned from 10 MHz to 5 GHz. All emissions less than 30 dB below the limits were found. Please refer to Plots 31 and 33 in Annex 1 for detailed measurements.

6.11.5.6. Highest Frequency at High Output Power (Tx Freq: 489.9 MHz, RF Output Power 46.3 dBm, Modulation: FM with 2.5 kHz Sine Wave Signal, Channel Spacing Setting: 12.5 kHz)

FREQUENCY (MHz)	TRANSMITTER CONDUCTED ANTENNA EMISSIONS		LIMIT (dBc)	MARGIN (dB)	PASS/ FAIL
	(dBm)	(dBc)			
489.90	46.3	--	--	--	--
979.80	-32.5	-78.8	-66.3	-12.5	PASS
1469.70	-39.8	-86.1	-66.3	-19.8	PASS

The emissions were scanned from 10 MHz to 5 GHz. All emissions less than 30 dB below the limits were found. Please refer to Plots 34 and 36 in Annex 1 for detailed measurements.

6.12. TRANSMITTER SPURIOUS/HARMONIC RADIATED EMISSIONS @ FCC 90.210

6.12.1. Limits @ FCC 90.210

Emissions shall be attenuated below the mean output power of the transmitter as follows:

FCC Rules	Frequency Range	Attenuation Limit (dBc)
90.210(b)&(c) – Voice & data	10 MHz to Lowest frequency of the radio to 10 th harmonic of the highest frequency of the radio	43+10*log(P) or -13 dBm
90.210(d) – Voice & data	10 MHz to Lowest frequency of the radio to 10 th harmonic of the highest frequency of the radio	50+10*log(P) or -20 dBm or 70 dBc whichever is less

6.12.2. Method of Measurements

The spurious/harmonic ERP measurements are using substitution method specified in Exhibit 8, § 8.2 of this report and its value in dBc is calculated as follows:

- (1) If the transmitter's antenna is an integral part of the EUT, the ERP is measured using substitution method.
- (2) If the transmitter's antenna is non-integral and diverse, the lowest ERP of the carrier with 0 dBi antenna gain is used for calculation of the spurious/harmonic emissions in dBc:
 Lowest ERP of the carrier = EIRP – 2.15 dB = P_c + G - 2.15 dB = xxx dBm (conducted) + 0 dBi – 2.15 dB
- (3) Spurious /harmonic emissions levels expressed in dBc (dB below carrier) are as follows:

$$\text{ERP of spurious/harmonic (dBc)} = \text{ERP of carrier (dBm)} - \text{ERP of spurious/harmonic emission (dBm)}$$

6.12.3. Test Equipment List

Test Instruments	Manufacturer	Model No.	Serial No.	Frequency Range
Spectrum Analyzer/ EMI Receiver	Hewlett Packard	HP 8546A	...	9 kHz to 5.6 GHz with built-in 30 dB Gain Pre-selector, QP, Average & Peak Detectors.
RF Amplifier	Com-Power	PA-102		1 MHz to 1 GHz, 30 dB gain nominal
Microwave Amplifier	Hewlett Packard	HP 83017A		1 GHz to 26.5 GHz, 30 dB nominal
Biconilog Antenna	EMCO	3142	10005	30 MHz to 2 GHz
Dipole Antenna	EMCO	3121C	8907-434	30 GHz – 1 GHz
Dipole Antenna	EMCO	3121C	8907-440	30 GHz – 1 GHz
Horn Antenna	EMCO	3155	9701-5061	1 GHz – 18 GHz
Horn Antenna	EMCO	3155	9911-5955	1 GHz – 18 GHz
RF Signal Generator	Hewlett Packard	HP 83752B	3610A00457	0.01 – 20 GHz

6.12.4. Test Setup

Please refer to Photos # 1 and 2 in Annex 2 for detailed of test setup.

6.12.5. Test Data

Remarks:

- The rf spurious/harmonic emission characteristics between 2 different channel spacing operations are identical. Therefore, the following radiated emissions were performed on the radio set with 12.5 kHz Channel Spacing operation, and the results were compared with the lowest limit of $50+10*\log(P \text{ in Watts})$ for the worst case.
- The Radiated emissions with High Power Settings were measured at 3 meters distance and represented the worst case

- *All test results contained in this engineering test report are traceable to National Institute of Standards and Technology (NIST)*

6.12.5.1. Lowest Frequency at High Output Power (Tx Freq: 440.10 MHz, RF Output Power 45 Watts, Modulation: FM with 2.5 kHz Sine Wave Signal, Channel Spacing Setting: 12.5 kHz)

FREQUENCY (MHz)	E-FIELD @3m (dBuV/m)	ERP measured by Substitution Method		EMI DETECTOR (Peak/QP)	ANTENNA POLARIZATION (H/V)	LIMIT (dBc)	MARGIN (dB)	PASS/FAIL
		(dBm)	(dBc)					
880.10	59.0	-40.4	-86.9	PEAK	V	-66.5	-20.4	PASS
880.10	60.2	-41.1	-87.6	PEAK	H	-66.5	-21.1	PASS
1320.15	56.1	-49.7	-96.2	PEAK	V	-66.5	-29.7	PASS
1320.15	63.8	-41.7	-88.2	PEAK	H	-66.5	-21.7	PASS
1760.20	58.4	-46.5	-93.0	PEAK	V	-66.5	-26.5	PASS
1760.20	63.6	-39.0	-85.5	PEAK	H	-66.5	-19.0	PASS
3520.40	65.4	-39.9	-86.4	PEAK	V	-66.5	-19.9	PASS
3520.40	59.6	-43.7	-90.2	PEAK	H	-66.5	-23.7	PASS
3960.45	60.1	-46.2	-92.7	PEAK	V	-66.5	-26.2	PASS
3960.45	55.3	-45.5	-92.0	PEAK	H	-66.5	-25.5	PASS

The emissions were scanned from 10 MHz to 5 GHz and all emissions within 30 dB below the limits were recorded.

**Radiated Emissions Measurements at 3 Meter OFTS
 ICOM UHF Transceiver, Model IC-F221S**

Tx Freq. = 440.05 MHz, RF Output: 45 Watts (conducted) to 50 Ohm Load, Channel Spacing: 12.5 kHz

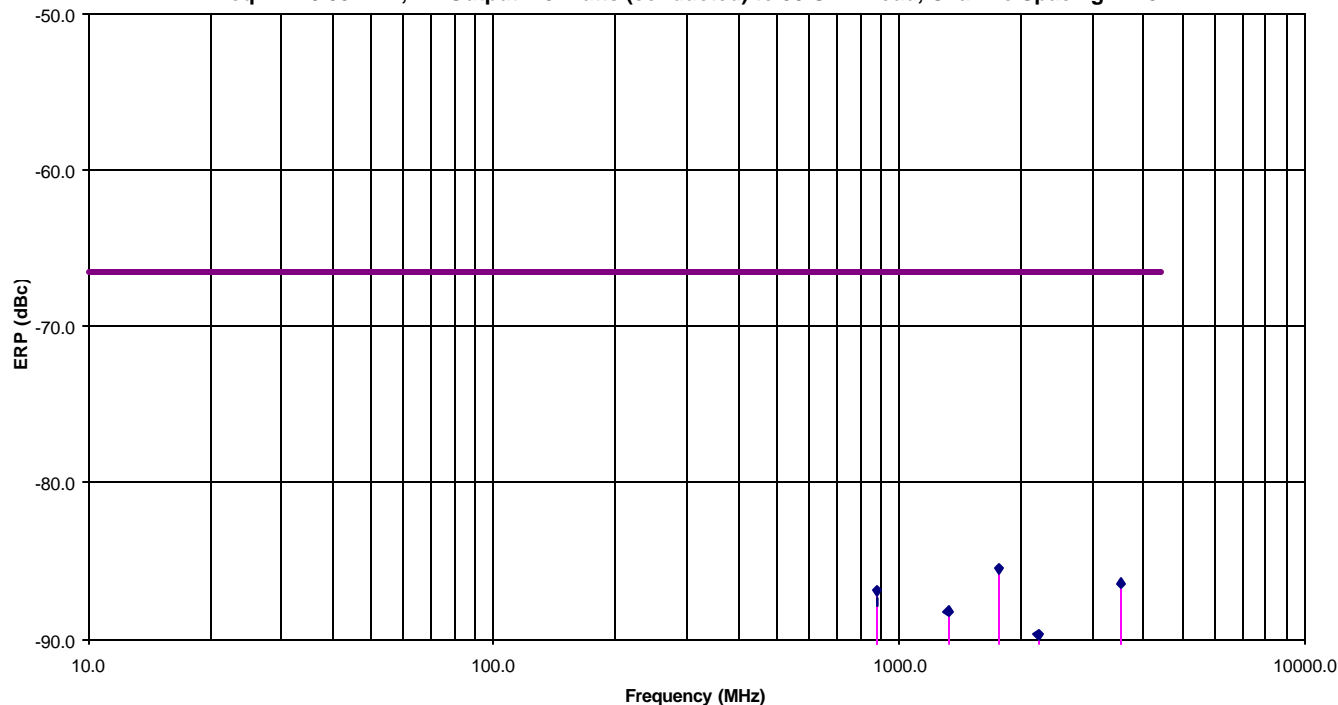

ULTRATECH GROUP OF LABS

3000 Bristol Circle, Oakville, Ontario, Canada L6H 6G4

Tel. #: 905-829-1570, Fax. #: 905-829-8050, Email: vic@ultratech-labs.com, Website: <http://www.ultratech-labs.com>

File #: ICOM-045FCC90

Jan. 24, 2003

- All test results contained in this engineering test report are traceable to National Institute of Standards and Technology (NIST)

6.12.5.2. Middle Frequency at High Output Power (Tx Freq: 465.10 MHz, RF Output Power 45 Watts, Modulation: FM with 2.5 kHz Sine Wave Signal, Channel Spacing Setting: 12.5 kHz)

FREQUENCY (MHz)	E-FIELD @3m (dBuV/m)	ERP measured by Substitution Method		EMI DETECTOR (Peak/QP)	ANTENNA POLARIZATION (H/V)	LIMIT (dBc)	MARGIN (dB)	PASS/FAIL
		(dBm)	(dBc)					
930.10	59.0	-40.4	-86.9	PEAK	V	-66.5	-20.4	PASS
930.10	55.7	-41.1	-87.6	PEAK	H	-66.5	-21.1	PASS
2790.30	60.9	-46.0	-92.5	PEAK	V	-66.5	-26.0	PASS
2790.30	58.7	-46.9	-93.4	PEAK	H	-66.5	-26.9	PASS

The emissions were scanned from 10 MHz to 5 GHz and all emissions within 30 dB below the limits were recorded.

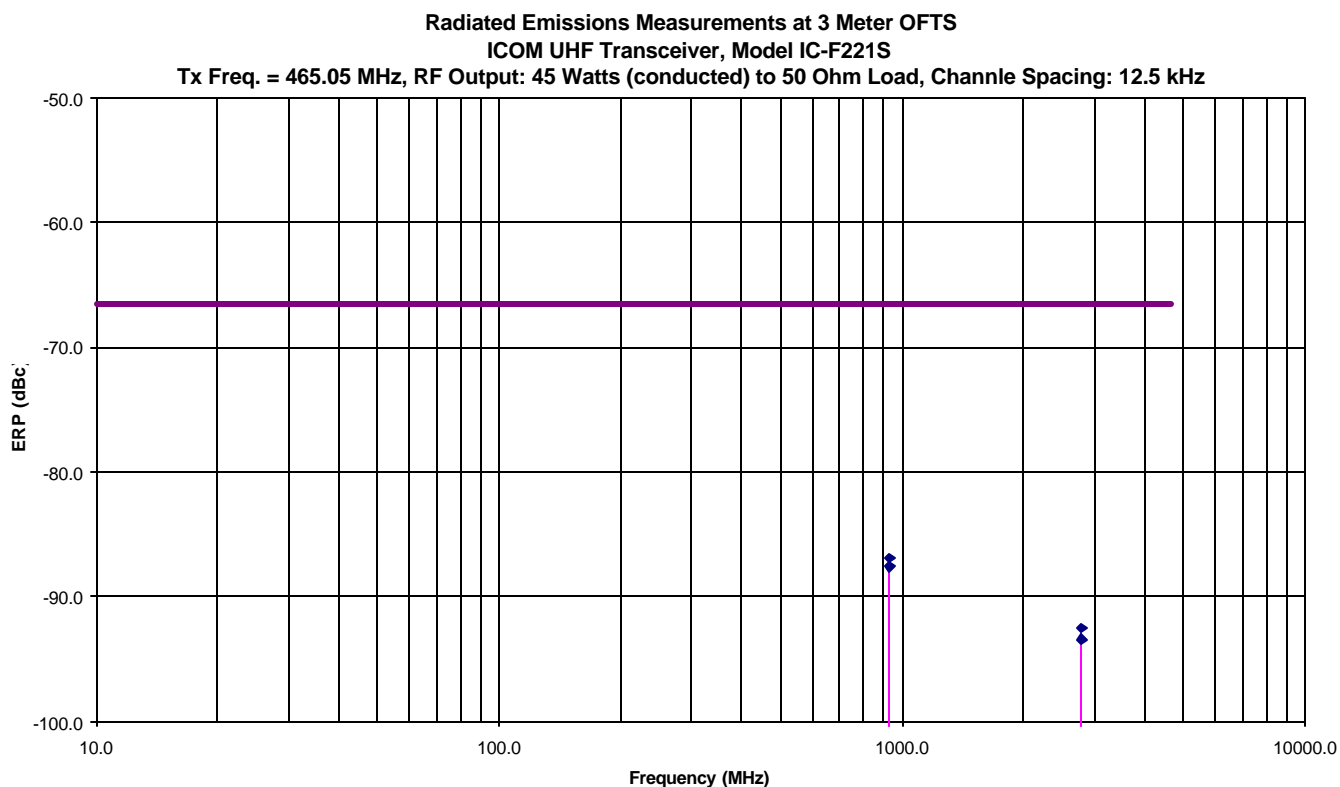

ULTRATECH GROUP OF LABS

3000 Bristol Circle, Oakville, Ontario, Canada L6H 6G4

Tel. #: 905-829-1570, Fax. #: 905-829-8050, Email: vic@ultratech-labs.com, Website: <http://www.ultratech-labs.com>

File #: ICOM-045FCC90

Jan. 24, 2003

- All test results contained in this engineering test report are traceable to National Institute of Standards and Technology (NIST)

6.12.5.3. Highest Frequency at High Output Power (Tx Freq: 489.90 MHz, RF Output Power 44.7 Watts, Modulation: FM with 2.5 kHz Sine Wave Signal, Channel Spacing Setting: 12.5 kHz)

FREQUENCY (MHz)	E-FIELD @3m (dBuV/m)	ERP measured by Substitution Method		EMI DETECTOR (Peak/QP)	ANTENNA POLARIZATION (H/V)	LIMIT (dBc)	MARGIN (dB)	PASS/FAIL
		(dBm)	(dBc)					
979.90	61.7	-40.4	-86.9	PEAK	V	-66.5	-20.4	PASS
979.90	59.9	-41.1	-87.6	PEAK	H	-66.5	-21.1	PASS
3429.65	60.6	-39.0	-85.5	PEAK	V	-66.5	-19.0	PASS
3429.65	56.1	-43.2	-89.7	PEAK	H	-66.5	-23.2	PASS
3919.60	61.2	-39.9	-86.4	PEAK	V	-66.5	-19.9	PASS
3919.60	61.3	-43.7	-90.2	PEAK	H	-66.5	-23.7	PASS

The emissions were scanned from 10 MHz to 5 GHz and all emissions within 30 dB below the limits were recorded.

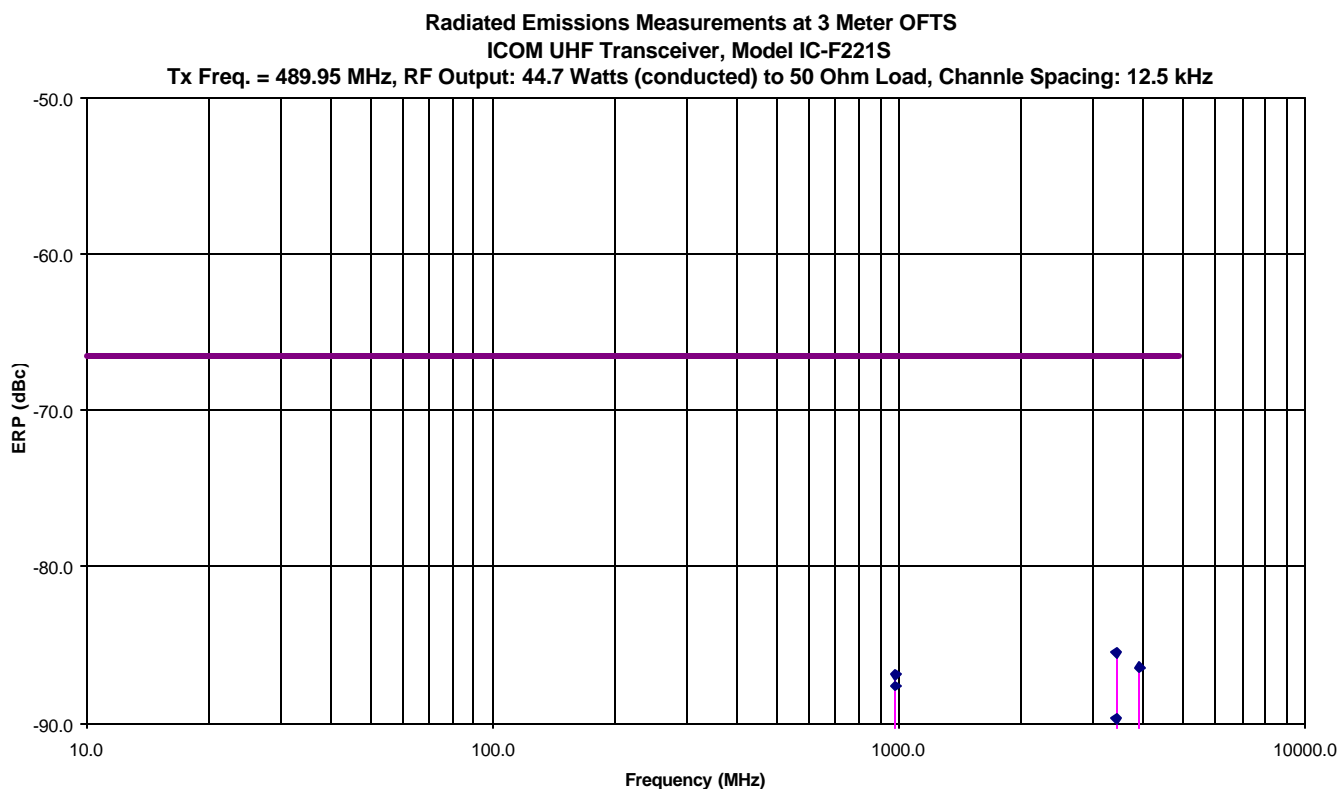

▪ All test results contained in this engineering test report are traceable to National Institute of Standards and Technology (NIST)

6.13. TRANSIENT FREQUENCY BEHAVIOR @ 90.214

6.13.1. Limits

Transient frequencies must be within the maximum frequency difference limits during the time intervals indicated:

Time intervals ^{1, 2}	Maximum frequency difference ³	All equipment
		421 to 512 MHz
Transient Frequency Behavior for Equipment Designed to Operate on 25 kHz Channels		
t_1 ⁴	± 25.0 kHz	10.0 ms
t_2	± 12.5 kHz	25.0 ms
t_3 ⁴	± 25.0 kHz	10.0 ms
Transient Frequency Behavior for Equipment Designed to Operate on 12.5 kHz Channels		
t_1 ⁴	± 12.5 kHz	10.0 ms
t_2	± 6.25 kHz	25.0 ms
t_3 ⁴	± 12.5 kHz	10.0 ms
Transient Frequency Behavior for Equipment Designed to Operate on 6.25 kHz Channels		
t_1 ⁴	± 6.25 kHz	10.0 ms
t_2	± 3.125 kHz	25.0 ms
t_3 ⁴	± 6.25 kHz	10.0 ms

- 1 t_{on} is the instant when a 1 kHz test signal is completely suppressed, including any capture time due to phasing.
 t_1 is the time period immediately following t_{on} .
 t_2 is the time period immediately following t_1 .
 t_3 is the time period from the instant when the transmitter is turned off until t_{off} .
 t_{off} is the instant when the 1 kHz test signal starts to rise.
- 2 During the time from the end of t_2 to the beginning of t_3 , the frequency difference must not exceed the limits specified in § 90.213.
- 3 Difference between the actual transmitter frequency and the assigned transmitter frequency.
- 4 If the transmitter carrier output power rating is 6 watts or less, the frequency difference during this time period may exceed the maximum frequency difference for this time period.

6.13.2. Method of Measurements

Refer to Exhibit 8, § 8.6 of this test report and ANSI/TIA/EIA - 603 - 1992, Sec. 2.2.19, Page 83

6.13.3. Test Equipment List

Test Instruments	Manufacturer	Model No.	Serial No.	Frequency Range
RF Synthesized Signal Generator	Fluke	6061A	...	10 kHz – 1GHz 13 dBm output max. @ 50 Ohms
Communication Analyzer (Test Receiver)	Rohde & Schwarz	SMFP2	879988/057	GHz including SINAD, S/N, Modulation meters, AF & RF signal generators and etc....
Network Combiner	Mini-circuit	15542	...	DC to 22 GHz (7 dB insertion loss)
Digital Storage Scope	Phillips	3320A	DQ 646	DC - 5 MHz
67297 RF Detector,	Herotex	DZ122-553	63400	..

6.13.4. Test Arrangement

The following drawings show details of the test setup for radiated emissions measurements

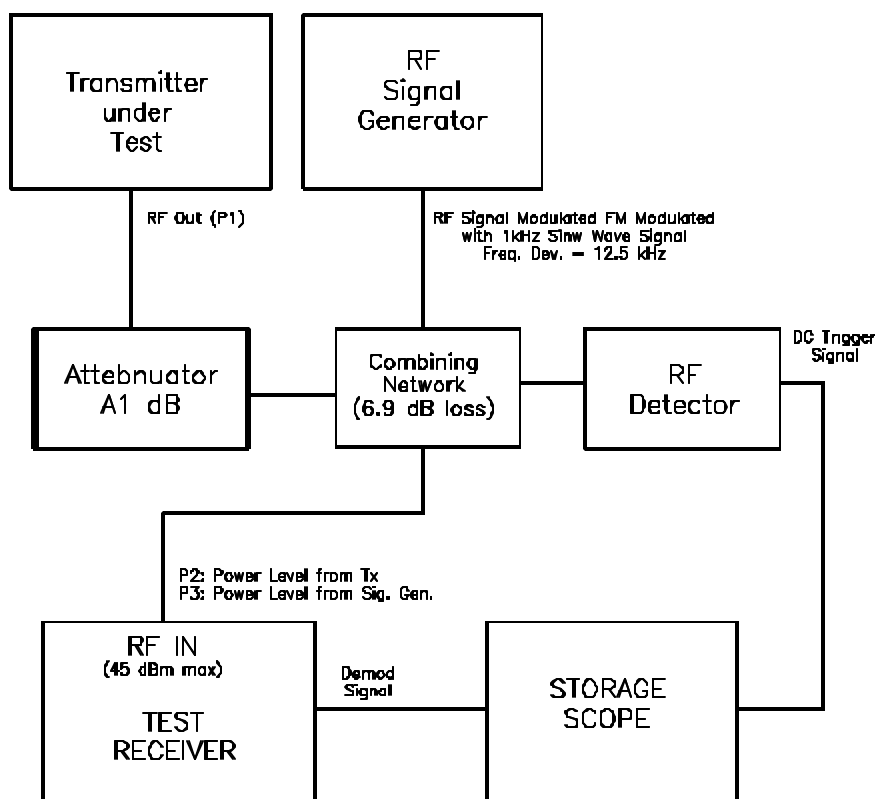

6.13.5. Test Data

6.13.5.1. 12.5 kHz Channel Spacing Operation: Refer to Plots # 37 to 40 in Annex 1 for detailed measurements

Test Configuration #1: Unmodulated		
Time Interval	Transient Frequency	Transient Frequency Limit
t ₁ (10 ms) Switch ON Condition	-1.3 kHz	12.5 kHz
t ₂ (25 ms) Switch On Condition	0	6.25 kHz
After t ₂ (10 ms) Switch On Condition	0	FCC Limit = ± 1100 Hz (2.5 ppm @ 440.10 MHz)
Before t ₃ (10 ms) Switch Off Condition	0	FCC Limit = ± 1100 Hz (2.5 ppm @440.10 MHz)
t ₃ (10 ms) Switch Off Condition	0	12.5 kHz
Test Configuration #2: FM modulation with 2.5 KHz Sine Wave, Freq. Dev.: 2.4 kHz		
t ₁ (10 ms) Switch ON Condition	+2.5 kHz	12.5 kHz
t ₂ (25 ms) Switch On Condition	0	6.25 kHz
After t ₂ (10 ms) Switch On Condition	0	FCC Limit = ± 1100 Hz (2.5 ppm @ 440.10 MHz)
Before t ₃ (10 ms) Switch Off Condition	0	FCC Limit = ± 1100 Hz (2.5 ppm @440.10 MHz)
t ₃ (10 ms) Switch Off Condition	0	12.5 kHz

6.13.5.2. 25 kHz Channel Spacing Operation: Refer to Plots # 41 to 44 in Annex 1 for detailed measurements

Test Configuration #1: Unmodulated		
Time Interval	Transient Frequency	Transient Frequency Limit
t ₁ (10 ms) Switch ON Condition	-2.6 kHz	25 kHz
t ₂ (25 ms) Switch On Condition	0	12.5 kHz
After t ₂ (10 ms) Switch On Condition	0	FCC Limit = ± 2200 Hz (5 ppm @ 440.10 MHz)
Before t ₃ (10 ms) Switch Off Condition	0	FCC Limit = ± 2200 Hz (5 ppm @ 440.10 MHz)
t ₃ (10 ms) Switch Off Condition	0	25 kHz
Test Configuration #2: FM modulation with 2.5 KHz Sine Wave, Freq. Dev.: 4.8 KHz		
t ₁ (10 ms) Switch ON Condition	+8.8 kHz	25 kHz
t ₂ (25 ms) Switch On Condition	0	12.5 kHz
After t ₂ (10 ms) Switch On Condition	0	FCC Limit = ± 2200 Hz (5 ppm @ 440.10 MHz)
Before t ₃ (10 ms) Switch Off Condition	0	FCC Limit = ± 2200 Hz (5 ppm @ 440.10 MHz)
t ₃ (10 ms) Switch Off Condition	0	25 kHz

EXHIBIT 7. MEASUREMENT UNCERTAINTY

The measurement uncertainties stated were calculated in accordance with the requirements of NIST Technical Note 1297 and NIS 81 (1994)

7.1. RADIATED EMISSION MEASUREMENT UNCERTAINTY

CONTRIBUTION (Radiated Emissions)	PROBABILITY DISTRIBUTION	UNCERTAINTY (\pm dB)	
		3 m	10 m
Antenna Factor Calibration	Normal (k=2)	± 1.0	± 1.0
Cable Loss Calibration	Normal (k=2)	± 0.3	± 0.5
EMI Receiver specification	Rectangular	± 1.5	± 1.5
Antenna Directivity	Rectangular	+0.5	+0.5
Antenna factor variation with height	Rectangular	± 2.0	± 0.5
Antenna phase center variation	Rectangular	0.0	± 0.2
Antenna factor frequency interpolation	Rectangular	± 0.25	± 0.25
Measurement distance variation	Rectangular	± 0.6	± 0.4
Site imperfections	Rectangular	± 2.0	± 2.0
Mismatch: Receiver VRC $\Gamma_1 = 0.2$ Antenna VRC $\Gamma_R = 0.67$ (Bi) 0.3 (Lp) Uncertainty limits $20\text{Log}(1 \pm \Gamma_1 \Gamma_R)$	U-Shaped	+1.1 -1.25	± 0.5
System repeatability	Std. Deviation	± 0.5	± 0.5
Repeatability of EUT		-	-
Combined standard uncertainty	Normal	+2.19 / -2.21	+1.74 / -1.72
Expanded uncertainty U	Normal (k=2)	+4.38 / -4.42	+3.48 / -3.44

Calculation for maximum uncertainty when 3m biconical antenna including a factor of k=2 is used:

$$U = 2u_c(y) = 2x(+2.19) = +4.38 \text{ dB} \quad \text{And} \quad U = 2u_c(y) = 2x(-2.21) = -4.42 \text{ dB}$$

EXHIBIT 8. MEASUREMENT METHODS

8.1. CONDUCTED POWER MEASUREMENTS

- The following shall be applied to the combination(s) of the radio device and its intended antenna(e).
- If the RF level is user adjustable, all measurements shall be made with the highest power level available to the user for that combination.
- The following method of measurement shall apply to both conducted and radiated measurements.
- The radiated measurements are performed at the Ultratech Calibrated Open Field Test Site.
- The measurement shall be performed using normal operation of the equipment with modulation.

Test procedure shall be as follows:

Step 1: Duty Cycle measurements if the transmitter's transmission is transient

- Using a EMI Receiver with the frequency span set to 0 Hz and the sweep time set at a suitable value to capture the envelope peaks and the duty cycle of the transmitter output signal;
- The duty cycle of the transmitter, $x = \text{Tx on} / (\text{Tx on} + \text{Tx off})$ with $0 < x < 1$, is measure and recorded in the test report. For the purpose of testing, the equipment shall be operated with a duty cycle that is equal or more than 0.1.

Step 2: Calculation of Average EIRP. See Figure 1

- The average output power of the transmitter shall be determined using a wideband, calibrated RF average power meter with the power sensor with an integration period that exceeds the repetition period of the transmitter by a factor 5 or more. The observed value shall be recorded as "A" (in dBm);
- The e.i.r.p. shall be calculated from the above measured power output "A", the observed duty cycle x, and the applicable antenna assembly gain "G" in dBi, according to the formula:

$$\text{EIRP} = \text{A} + \text{G} + 10\log(1/x)$$

{ X = 1 for continuous transmission => $10\log(1/x) = 0 \text{ dB}$ }

Figure 1.

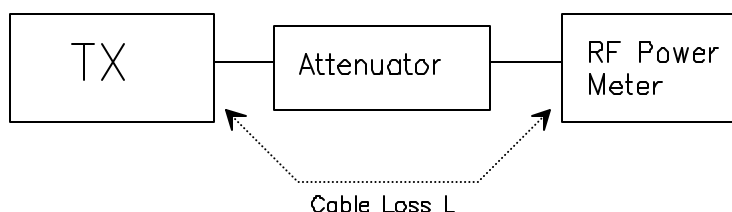

- All test results contained in this engineering test report are traceable to National Institute of Standards and Technology (NIST)

8.2. RADIATED POWER MEASUREMENTS (ERP & EIRP) USING SUBSTITUTION METHOD

8.2.1. Maximizing RF Emission Level (E-Field)

- (a) The measurements was performed with full rf output power and modulation.
- (b) Test was performed at listed 3m open area test site (listed with FCC, IC, ITI, NVLAP, ACA & VCCI).
- (c) The transmitter under test was placed at the specified height on a non-conducting turntable (80 cm height)
- (d) The BICONILOG antenna (20 MHz to 1 GHz) or HORN antenna (1 GHz to 18 GHz) was used for measuring.
- (e) Load an appropriate correction factors file in EMI Receiver for correcting the field strength reading level

Total Correction Factor recorded in the EMI Receiver = Cable Loss + Antenna Factor
E (dBuV/m) = Reading (dBuV) + Total Correction Factor (dB/m)

- (f) Set the EMI Receiver and #2 as follows:

Center Frequency:	test frequency
Resolution BW:	100 kHz
Video BW:	same
Detector Mode:	positive
Average:	off
Span:	3 x the signal bandwidth

- (g) The test antenna was lowered or raised from 1 to 4 meters until the maximum signal level was detected.
- (h) The transmitter was rotated through 360° about a vertical axis until a higher maximum signal was received.
- (i) The test antenna was lowered or raised again from 1 to 4 meters until a maximum was obtained. This level was recorded.
- (j) The recorded reading was corrected to the true field strength level by adding the antenna factor, cable loss and subtracting the pre-amplifier gain.
- (k) The above steps were repeated with both transmitters' antenna and test receiving antenna placed in vertical and horizontal polarization. Both readings with the antennas placed in vertical and horizontal polarization shall be recorded.
- (l) Repeat for all different test signal frequencies

8.2.2. Measuring the EIRP of Spurious/Harmonic Emissions using Substitution Method

- (a) Set the EMI Receiver (for measuring E-Field) and Receiver #2 (for measuring EIRP) as follows:

Center Frequency: equal to the signal source
Resolution BW: 10 kHz
Video BW: same
Detector Mode: positive
Average: off
Span: 3 x the signal bandwidth

- (b) Load an appropriate correction factors file in EMI Receiver for correcting the field strength reading level

Total Correction Factor recorded in the EMI Receiver = Cable Loss + Antenna Factor
 $E \text{ (dBuV/m)} = \text{Reading (dBuV)} + \text{Total Correction Factor (dB/m)}$

- (c) Select the frequency and E-field levels obtained in the Section 8.2.1 for ERP/EIRP measurements.
(d) Substitute the EUT by a signal generator and one of the following transmitting antenna (substitution antenna):
♦ DIPOLE antenna for frequency from 30-1000 MHz or
♦ HORN antenna for frequency above 1 GHz }.
(e) Mount the transmitting antenna at 1.5 meter high from the ground plane.
(f) Use one of the following antenna as a receiving antenna:
♦ DIPOLE antenna for frequency from 30-1000 MHz or
♦ HORN antenna for frequency above 1 GHz }.
(g) If the DIPOLE antenna is used, tune it's elements to the frequency as specified in the calibration manual.
(h) Adjust both transmitting and receiving antenna in a VERTICAL polarization.
(i) Tune the EMI Receivers to the test frequency.
(j) Lower or raise the test antenna from 1 to 4 meters until the maximum signal level was detected.
(k) The transmitter was rotated through 360° about a vertical axis until a higher maximum signal was received.
(l) Lower or raise the test antenna from 1 to 4 meters until the maximum signal level was detected.
(m) Adjust input signal to the substitution antenna until an equal or a known related level to that detected from the transmitter was obtained in the test receiver.
(n) Record the power level read from the Average Power Meter and calculate the ERP/EIRP as follows:

$$P = P1 - L1 = (P2 + L2) - L1 = P3 + A + L2 - L1$$

$$EIRP = P + G1 = P3 + L2 - L1 + A + G1$$

$$ERP = EIRP - 2.15 \text{ dB}$$

$$\text{Total Correction factor in EMI Receiver \# 2} = L2 - L1 + G1$$

Where: P: Actual RF Power fed into the substitution antenna port after corrected.
P1: Power output from the signal generator
P2: Power measured at attenuator A input
P3: Power reading on the Average Power Meter
EIRP: EIRP after correction
ERP: ERP after correction

- (o) Adjust both transmitting and receiving antenna in a HORIZONTAL polarization, then repeat step (k) to (o)
(p) Repeat step (d) to (o) for different test frequency
(q) Repeat steps (c) to (j) with the substitution antenna oriented in horizontal polarization.
(r) Actual gain of the EUT's antenna is the difference of the measured EIRP and measured RF power at the RF port. Correct the antenna gain if necessary.:

Figure 2

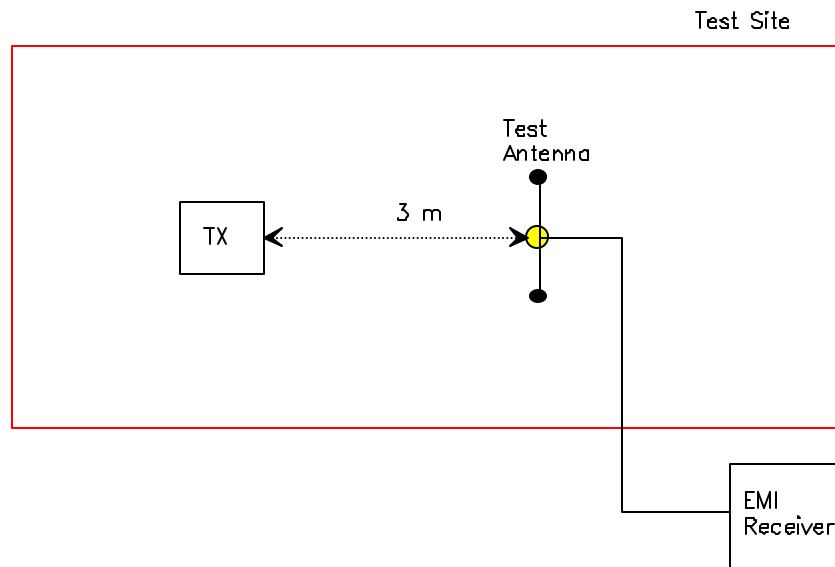
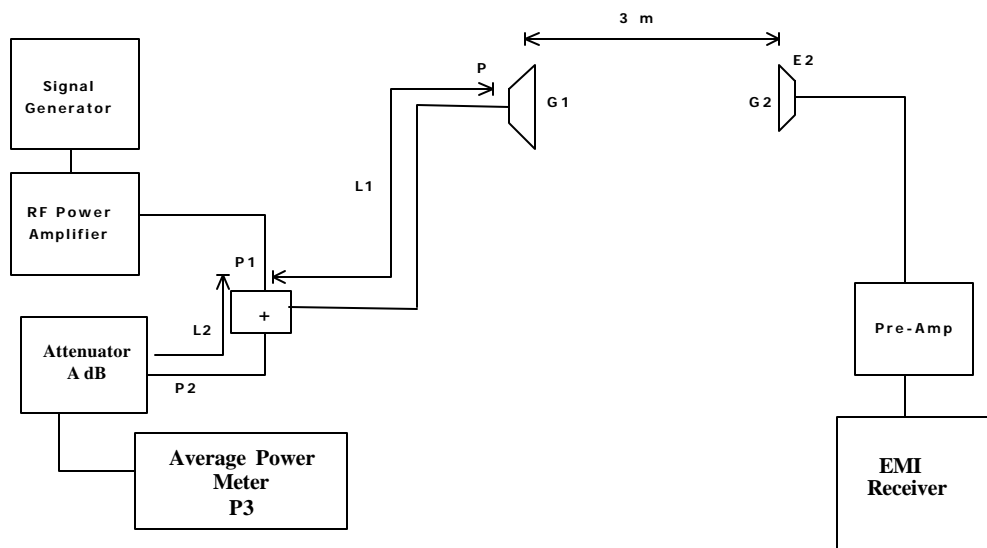

Figure 3



8.3. FREQUENCY STABILITY

Refer to FCC @ 2.1055.

- (a) The frequency stability shall be measured with variation of ambient temperature as follows: From -30 to +50 centigrade except that specified in subparagraph (2) & (3) of this paragraph.
- (b) Frequency measurements shall be made at extremes of the specified temperature range and at intervals of not more than 10 centigrade through the range. A period of time sufficient to stabilize all of the components of the oscillator circuit at each temperature level shall be allowed prior to frequency measurement. The short-term transient effects on the frequency of the transmitter due to keying (except for broadcast transmitters) and any heating element cycling normally occurring at each ambient temperature level also shall be shown. Only the portion or portions of the transmitter containing the frequency determining and stability circuitry need be subjected to the temperature variation test.
- (d) The frequency stability supply shall be measured with variation of primary supply voltage as follows:
 - (1) Vary primary supply voltage from 85 to 115 percent of the nominal value for other than hand carried battery equipment.
 - (2) For hand carried, battery powered equipment, reduce primary supply voltage to the battery operating end point which shall be specified by the manufacturer.
 - (3) The supply voltage shall be measured at the input to the cable normally provide with the equipment, or at the power supply terminals if cables are not normally provided. Effects on frequency of transmitter keying (except for broadcast transmitters) and any heating element cycling at the nominal supply voltage and at each extreme also shall be shown.
- (e) When deemed necessary, the Commission may require tests of frequency stability under conditions in addition to those specifically set out in paragraphs (a), (b), (c) and (d) of this section. (For example, measurements showing the effect of proximity to large metal objects, or of various types of antennas, may be required for portable equipment).

8.4. EMISSION MASK

Voice or Digital Modulation Through a Voice Input Port @ 2.1049(c)(i):- The transmitter was modulated by a 2.5 KHz tone signal at an input level 16 dB greater than that required to produce 50% modulation (e.g.: ± 2.5 KHz peak deviation at 1 KHz modulating frequency). The input level was established at the frequency of maximum response of the audio modulating circuit.

Digital Modulation Through a Data Input Port @ 2.1049(h):- Transmitters employing digital modulation techniques - when modulated by an input signal such that its amplitude and symbol rate represent the maximum rated conditions under which the equipment will be operated. The signal shall be applied through any filter networks, pseudo-random generators or other devices required in normal service. Additionally, the Emission Masks shall be shown for operation with any devices used for modifying the spectrum when such devices are operational at the discretion of the user.

The following EMI Receiver bandwidth shall be used for measurement of Emission Mask/Out-of-Band Emission Measurements:

- (1) For 25 kHz Channel Spacing: RBW = 300 Hz
- (2) For 12.5 kHz or 6.25 kHz Channel Spacings: RBW = 100 Hz

The all cases the Video Bandwidth shall be equal or greater than the measuring bandwidth.

8.5. SPURIOUS EMISSIONS (CONDUCTED)

With transmitter modulation characteristics described in Out-of-Band Emissions measurements @ 2.1049, the transmitter spurious and harmonic emissions were scanned. The spurious and harmonic emissions were measured with the EMI Receiver controls set as RBW = 30 kHz minimum, VBW \geq RBW and SWEEP TIME = AUTO). The transmitter was operated at a full rated power output, and modulated as follows:

FCC CFR 47, Para. 2.1057 - Frequency spectrum to be investigated:- The spectrum was investigated from the lowest radio generated in the equipment up to at least the 10th harmonic of the carrier frequency or to the highest frequency practicable in the present state of the art of measuring techniques, whichever is lower. Particular attention should be paid to harmonics and subharmonics of the carrier frequency. Radiation at the frequencies of multiplier stages should be checked. The amplitude of spurious emissions which are attenuated more than 20 dB below the permissible value need not be reported.

FCC CFR 47, Para. 2.1051 - Spurious Emissions at Antenna Terminal:- The radio frequency voltage or powers generated within the equipment and appearing on a spurious frequency shall be checked at the equipment output terminals when properly loaded with a suitable artificial antenna. Curves or equivalent data shall show the magnitude of the harmonic and other spurious emission that can be detected when the equipment is operated under the conditions specified in 2.1049 as appropriate. The magnitude of spurious emissions which are attenuated more than 20 dB below the permissible value need not be specified.

8.6. TRANSIENT FREQUENCY BEHAVIOR

1. Connect the transmitter under tests as shown in the above block diagram
2. Set the signal generator to the assigned frequency and modulate with a 1 kHz tone at ± 12.5 kHz deviation and its output level to be 50 dB below the transmitter rf output at the test receiver end.
3. Set the horizontal sweep rate on the storage scope to 10 milliseconds per division and adjust the display to continuously view the 1000 Hz tone from the Demodulator Output Port (DOP) of the Test Receiver. Adjust the vertical scale amplitude control of the scope to display the 1000 Hz at ± 4 divisions vertical Center at the display.
4. Adjust the scope so it will trigger on an increasing magnitude from the RF trigger signal of the transmitter under test when the transmitter was turned on. Set the controls to store the display.
5. The output at the DOP, due to the change in the ratio of the power between the signal generator input power and transmitter output power will, because of the capture effect of the test receiver, produce a change in display: For the first part of the sweep it will show the 1 kHz test signal. Then once the receiver's demodulator has been captured by the transmitter power, the display will show the frequency difference from the assigned frequency to the actual transmitter frequency versus time. The instant when the 1 kHz test signal is completely suppressed (including any capture time due to phasing) is considered to be t_{on} . The trace should be maintained within the allowed divisions during the period t_1 and t_2 .
6. During the time from the end of t_2 to the beginning of t_3 the frequency difference should not exceed the limits set by the FCC in Part 90.214 and the outlined in the Carrier Frequency Stability sections. The allowed limit is equal to FCC frequency tolerance limits specified in FCC 90.213.
7. Repeat the above steps when the transmitter was turned off for measuring t_3 .