

ENGINEERING TEST REPORT

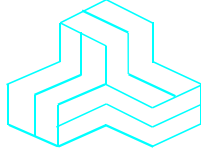

HF/50 MHz - ALL MODE TRANSCEIVER Model No.: IC-756PROIII

FCC ID: AFJ217800

Applicant:

ICOM Incorporated
*1-1-32, Kamiminami
Hirano-ku, Osaka
Japan, 547-003*

Tested in Accordance With

**Federal Communications Commission (FCC)
47 CFR, Part 15, Subpart B
Scanning Receivers Operating in the Frequency Band 0.030 - 60.000 MHz**

UltraTech's File No.: ICOM-090FCC15RX

This Test report is Issued under the Authority of
Tri M. Luu, Professional Engineer,
Vice President of Engineering
UltraTech Group of Labs

Date: August 31, 2004



Report Prepared by: Dharmajit Solanki, RFI Engineer

Issued Date: August 31, 2004

Tested by: Wayne Wu, RFI Engineer

Test Dates: August 13 - 30, 2004

- *The results in this Test Report apply only to the sample(s) tested, and the sample tested is randomly selected.*
- *This report must not be used by the client to claim product endorsement by NVLAP or any agency of the US Government.*

UltraTech

3000 Bristol Circle, Oakville, Ontario, Canada, L6H 6G4
Tel.: (905) 829-1570 Fax.: (905) 829-8050

Website: www.ultratech-labs.com, Email: vic@ultratech-labs.com, Email: tri@ultratech-labs.com



31040/SIT



C-1376



46390-2049



200093-0



SL2-IN-E-1119R



00-034



TABLE OF CONTENTS

EXHIBIT 1.	SUBMITTAL CHECK LIST.....	2
EXHIBIT 2.	INTRODUCTION	3
2.1.	SCOPE.....	3
2.2.	RELATED SUBMITTAL(S)/GRANT(S)	3
2.3.	NORMATIVE REFERENCES	3
EXHIBIT 3.	PERFORMANCE ASSESSMENT	4
3.1.	CLIENT INFORMATION.....	4
3.2.	EQUIPMENT UNDER TEST (EUT) INFORMATION	4
3.3.	EUT'S TECHNICAL SPECIFICATIONS	5
3.4.	LIST OF EUT'S PORTS.....	5
3.5.	ANCILLARY EQUIPMENT	6
3.6.	BLOCK DIAGRAM OF TEST SETUP.....	7
EXHIBIT 4.	EUT OPERATING CONDITIONS AND CONFIGURATIONS DURING TESTS.....	6
4.1.	CLIMATE TEST CONDITIONS	6
4.2.	OPERATIONAL TEST CONDITIONS & ARRANGEMENT FOR TEST SIGNALS.....	6
EXHIBIT 5.	SUMMARY OF TEST RESULTS.....	7
5.1.	LOCATION OF TESTS.....	7
5.2.	APPLICABILITY & SUMMARY OF EMC EMISSION TEST RESULTS	7
5.3.	MODIFICATIONS REQUIRED FOR COMPLIANCE.....	7
EXHIBIT 6.	MEASUREMENTS, EXAMINATIONS & TEST DATA FOR EMC EMISSIONS.....	8
6.1.	TEST PROCEDURES.....	8
6.2.	MEASUREMENT UNCERTAINTIES	8
6.3.	MEASUREMENT EQUIPMENT USED	8
6.4.	ESSENTIAL/PRIMARY FUNCTIONS AS DECLARED BY THE MANUFACTURER.....	8
6.5.	AC POWERLINE CONDUCTED EMISSIONS [47 CFR 15.107 (A)]	9
6.6.	RECEIVER ANTENNA POWER SPURIOUS/HARMONIC CONDUCTED EMISSIONS [47 CFR 15.111(A)] 13	
6.7.	RECEIVER SPURIOUS/HARMONIC RADIATED EMISSIONS [47 CFR 15.109(A)]	20
6.8.	RADIATED EMISSIONS FROM CLASS B UNINTENTIONAL RADIATION (DIGITAL DEVICE) [47 CFR 15.109 (A)].....	24
6.9.	REQUIREMENTS FOR SCANNING RECEIVERS [47 CFR 15.121]	27
6.10.	SCANNING RECEIVERS CELLULAR BAND REJECTION [47 CFR 15.121(B)].....	30
EXHIBIT 7.	MEASUREMENT UNCERTAINTY.....	32
7.1.	LINE CONDUCTED EMISSION MEASUREMENT UNCERTAINTY	32
7.2.	RADIATED EMISSION MEASUREMENT UNCERTAINTY	33
EXHIBIT 8.	MEASUREMENT METHODS.....	34
8.1.	GENERAL TEST CONDITIONS	34

EXHIBIT 1. SUBMITTAL CHECK LIST

Annex No.	Exhibit Type	Description of Contents	Quality Check (OK)
--	Test Report	<ul style="list-style-type: none"> ▪ Exhibit 1: Submittal check lists ▪ Exhibit 2: Introduction ▪ Exhibit 3: Performance Assessment ▪ Exhibit 4: EUT Operation and Configuration during Tests ▪ Exhibit 5: Summary of test Results ▪ Exhibit 6: Measurement Data ▪ Exhibit 7: Measurement Uncertainty ▪ Exhibit 8: Measurement Methods 	OK
1	Test Setup Photos	Test Setup Photos	OK
2	External Photos of EUT	External EUT Photos	OK
3	Internal Photos of EUT	Internal EUT Photos	OK
4	Cover Letters	<ul style="list-style-type: none"> ▪ Cover Letter for Certification Request. ▪ Letter from the Applicant to appoint Ultratech to act as an agent ▪ Letter from the Applicant to request for Confidentiality Filing 	OK
5	Attestation Statements	<ul style="list-style-type: none"> ▪ Manufacturer Attestation Letter ▪ Part 2.1033(b)(10) for Scanning Receiver 	OK
6	ID Label/Location Info	<ul style="list-style-type: none"> ▪ ID Label ▪ Location of ID Label 	OK
7	Block Diagrams	Block Diagrams	OK
8	Schematic Diagrams	Schematics	OK
9	Operational Description	IC-756PROIII Circuit Description	OK
10	RF Exposure Info	N/A	N/A
11	Users Manual	Instruction Manual	OK

EXHIBIT 2. INTRODUCTION

2.1. SCOPE

Reference:	FCC Part 15, Subpart B, Sections 15.107, 15.109, 15.111 & 15.121
Title:	Code of Federal Regulations (CFR), Title 47, Telecommunication, Part 15
Purpose of Test:	To gain FCC Certification Authorization for Scanning Receivers operating in 0.030 – 60.000 MHz.
Test Procedures:	Both conducted and radiated emissions measurements were conducted in accordance with American National Standards Institute ANSI C63.4 - American National Standard for Methods of Measurement of Radio-Noise Emissions from Low-Voltage Electrical and Electronic Equipment in the Range of 9 kHz to 40 GHz.
Environmental Classification:	Commercial, industrial or business environment.

2.2. RELATED SUBMITTAL(S)/GRANT(S)

None.

2.3. NORMATIVE REFERENCES

Publication	Year	Title
FCC CFR Parts 0-19	2003	Code of Federal Regulations – Telecommunication
ANSI C63.4	2003	American National Standard for Methods of Measurement of Radio-Noise Emissions from Low-Voltage Electrical and Electronic Equipment in the Range of 9 kHz to 40 GHz
CISPR 22 & EN 55022	2002 2003	Limits and Methods of Measurements of Radio Disturbance Characteristics of Information Technology Equipment
CISPR 16-1	1999	Specification for Radio Disturbance and Immunity measuring apparatus and methods

EXHIBIT 3. PERFORMANCE ASSESSMENT

3.1. CLIENT INFORMATION

APPLICANT	
Name:	ICOM Incorporated
Address:	1-1-32, Kamiminami Hirano-ku, Osaka Japan, 547-003
Contact Person:	Mr. Takashi Aoki Phone #: +81-66-793-5302 Fax #: +81-66-793-0013 Email Address: export@icom.co.jp

MANUFACTURER	
Name:	ICOM Incorporated
Address:	1-1-32, Kamiminami Hirano-ku, Osaka Japan, 547-0003
Contact Person:	Mr. Takashi Aoki Phone #: +81-66-793-5302 Fax #: +81-66-793-0013 Email Address: export@icom.co.jp

3.2. EQUIPMENT UNDER TEST (EUT) INFORMATION

The following information (with the exception of the Date of Receipt) has been supplied by the applicant.

Brand Name:	ICOM Incorporated
Product Name:	HF/50 MHz - ALL MODE TRANSCEIVER
Model Name or Number:	IC-756PROIII
Serial Number:	0000002
Type of Equipment:	Scanning Receivers
External Power Supply:	N/A
Power input source:	13.8 V DC \pm 15% (with AC adaptor, PS-125)

3.3. EUT'S TECHNICAL SPECIFICATIONS

RECEIVER	
Equipment Type:	Fixed/Mobile
Power Supply Requirement:	13.8 V DC \pm 15% (with AC adaptor, PS-125)
Operating Frequency Range:	0.030 – 60.000 MHz
RF Input Impedance:	50 Ohms

3.4. LIST OF EUT'S PORTS

Port Number	EUT's Port Description	Number of Identical Ports	Connector Type	Cable Type (Shielded/Non-shielded)
1	Antenna # 1& 2	2	VHF Female	Shielded
2	DC Power	1	4 wire	Non-shielded
3	External Speaker	1	1/8" Mini Jack	Non-shielded
4	RX ANT	1	RCA	Non-shielded
5	XVERT	1	RCA	Non-shielded
6	TUNER	1	4 wire	Non-shielded
7	ACC 1	1	8 wire	Non-shielded
8	ACC 2	1	7 wire	Non-shielded
9	KEY	1	3 wire	Non-shielded
10	REMOTE	1	1/8" Mini Jack	Non-shielded
11	ALC	1	RCA Jack	Non-shielded
12	SEND	1	RCA Jack	Non-shielded
13	MIC	1	8 pin	Non-shielded
14	PHONES	1	1/8" Mini Jack	Non-shielded
15	ELEC KEY	1	3 wire	Non-shielded
16	GND	1	Screw Nut	Shielded

3.5. ANCILLARY EQUIPMENT

The EUT was tested while connected to the following representative configuration of ancillary equipment necessary to exercise the ports during tests:

Ancillary Equipment # 1	
Description:	AC Adapter
Brand name:	ICOM
Model Name or Number:	PS-125
Serial Number:	0204798
Cable Type:	Non-shielded

Ancillary Equipment # 2	
Description:	Headphone
Brand name:	Denon
Cable Type:	Non-shielded

Ancillary Equipment # 3	
Description:	Desk Top Microphone
Brand name:	ICOM
Model Name or Number:	SM-20
Serial Number:	Kish-168
Cable Type:	Non-shielded

Ancillary Equipment # 4	
Description:	External Speaker
Brand name:	ICOM
Model Name or Number:	SP-23
Cable Type:	Non-shielded

Ancillary Equipment # 5	
Description:	Coaxial Attenuator
Brand name:	Tenuline
Model Name or Number:	8323
Serial Number:	428
Cable Type:	Shielded

Ancillary Equipment # 6	
Description:	Coaxial Resistor
Brand name:	Termaline
Model Name or Number:	8201
Serial Number:	10914
Cable Type:	Shielded

3.6. BLOCK DIAGRAM OF TEST SETUP

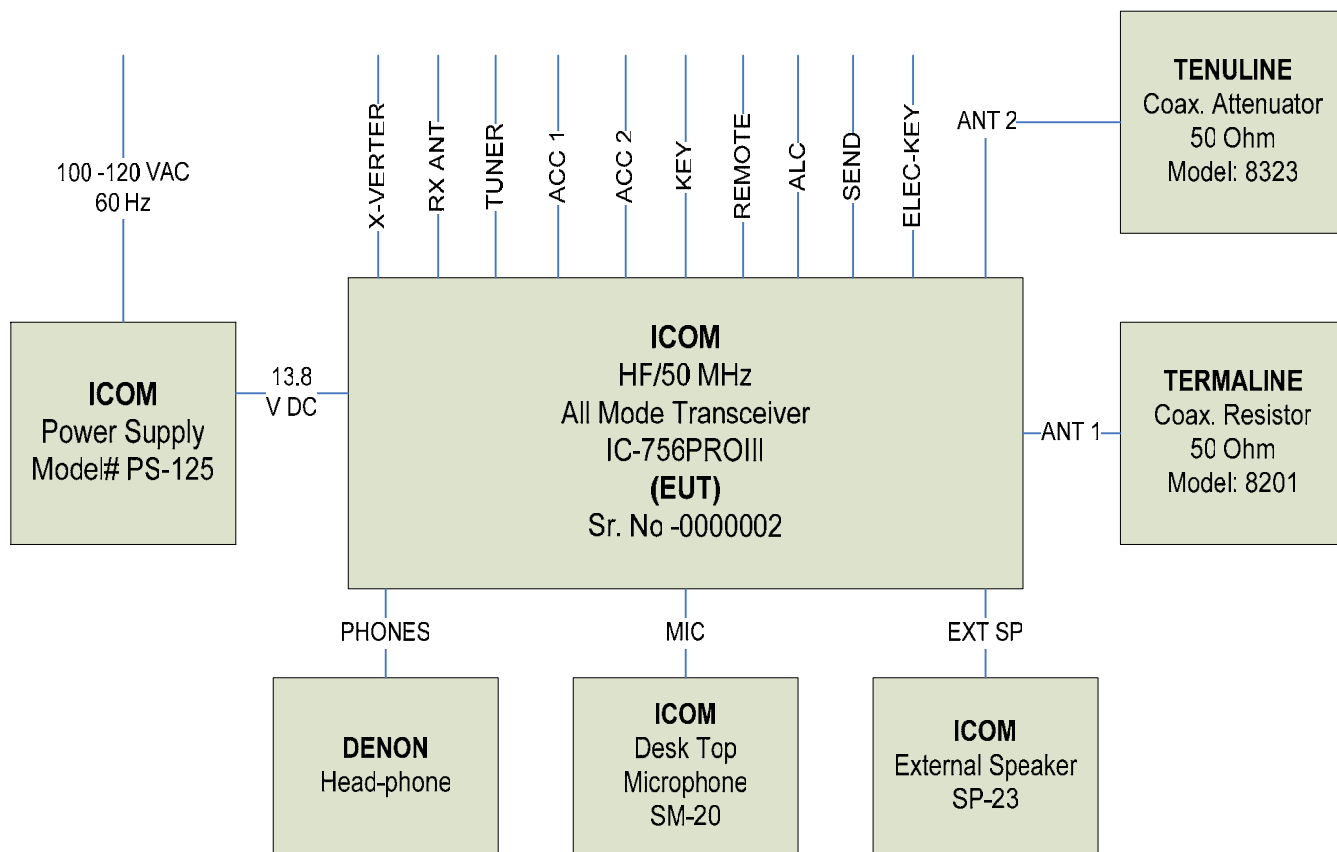

EXHIBIT 4. EUT OPERATING CONDITIONS AND CONFIGURATIONS DURING TESTS

4.1. CLIMATE TEST CONDITIONS

The climate conditions of the test environment are as follows:

Temperature:	21°C
Humidity:	51%
Pressure:	102 kPa
Power input source:	13.8 V DC via BC-149A AC adaptor

4.2. OPERATIONAL TEST CONDITIONS & ARRANGEMENT FOR TEST SIGNALS

Operating Modes:	The receiver was operated in the normal intended mode during testing
Special Test Software:	None
Special Hardware Used:	None
Receiver Test Antenna:	The EUT's was tested with its antenna attached for radiated emissions.

Receiver Test Signals	
Frequency Band(s):	30 KHz - 60 MHz
Test Frequency(ies): (Near lowest, near middle & near highest frequencies in the frequency range of operation.)	30, 45 and 60 MHz

EXHIBIT 5. SUMMARY OF TEST RESULTS

5.1. LOCATION OF TESTS

All of the measurements described in this report were performed at Ultratech Group of Labs located in the city of Oakville, Province of Ontario, Canada.

- AC Powerline Conducted Emissions were performed in UltraTech's shielded room, 16'(L) by 12'(W) by 12'(H).
- Radiated Emissions were performed at the Ultratech's 3 Meter Open Field Test Site (OFTS) situated in the Town of Oakville, province of Ontario.

The above sites have been calibrated in accordance with ANSI C63.4, and found to be in compliance with the requirements of Sec. 2.948 of the FCC Rules. The descriptions and site measurement data of the Oakville Open Field Test Site has been filed with FCC office (FCC File No.: 31040/SIT 1300B3) and Industry Canada office (Industry Canada File No.: IC2049). Last Date of Site Calibration: Feb. 17, 2004.

5.2. APPLICABILITY & SUMMARY OF EMC EMISSION TEST RESULTS

FCC Part 15, Subpart B	Test Requirements	Compliance (Yes/No)
15.107(a), Class B	AC Power Line Conducted Emissions Measurements	Yes
15.111(a)	Receiver Antenna Power Conducted Emissions for Non-Integral Antenna Port	Yes
15.109(a)	Radiated Emissions from Scanning Receivers & Class B Digital Device	Yes
15.121	Requirements for Scanning Receivers	Yes

5.3. MODIFICATIONS REQUIRED FOR COMPLIANCE

None.

EXHIBIT 6. MEASUREMENTS, EXAMINATIONS & TEST DATA FOR EMC EMISSIONS

6.1. TEST PROCEDURES

This section contains test results only. Details of test methods and procedures can be found in Exhibit 8 of this report.

6.2. MEASUREMENT UNCERTAINTIES

The measurement uncertainties stated were calculated in accordance with requirements of UKAS Document NIS 81 with a confidence level of 95%. Please refer to Exhibit 7 for Measurement Uncertainties.

6.3. MEASUREMENT EQUIPMENT USED

The measurement equipment used complied with the requirements of the Standards referenced in the Methods & Procedures ANSI C63.4:2003, CISPR 22 and CISPR 16-1.

6.4. ESSENTIAL/PRIMARY FUNCTIONS AS DECLARED BY THE MANUFACTURER

The Scanning Receivers was operated as its normal intended mode during testing.

6.5. AC POWERLINE CONDUCTED EMISSIONS [47 CFR 15.107 (a)]

6.5.1. Limits

The equipment shall meet the limits of the following table:

Frequency of Emission MHz)	Class B Conducted Limit (dB μ V)	
	Quasi-peak	Average
0.15-0.5	66 to 56	56 to 46
0.5-5	56	46
5-30	60	50

6.5.2. Method of Measurements

ANSI C63-4: 2003

6.5.3. Test Equipment List

Test Instruments	Manufacturer	Model No.	Serial No.	Frequency Range
Spectrum Analyzer/ EMI Receiver	Hewlett Packard	HP 8593EM	3412A00103	9 kHz – 26.5 GHz
Transient Limiter	Hewlett Packard	11947A	310701998	9 kHz – 200 MHz 10 dB attenuation
L.I.S.N.	EMCO	3825/2	89071531	9 kHz – 200 MHz 50 Ohms / 50 μ H
12'x16'x12' RF Shielded Chamber	RF Shielding

6.5.4. Test Data

Frequency (MHz)	RF Level (dBuV)	Receiver Detector (P/QP/AVG)	QP Limit (dBuV)	AVG Limit (dBuV)	Margin (dB)	Pass/Fail	Line Tested (L1/L2)
0.23340	51.5	QP	62.4	52.4	-10.9	Pass	L1
0.23340	50.3	AVG	62.4	52.4	-2.1	Pass	L1
0.33027	47.4	QP	59.5	49.5	-13.6	Pass	L1
0.33027	45.9	AVG	59.5	49.5	-3.6	Pass	L1
0.42362	45.4	QP	57.4	47.4	-12.0	Pass	L1
0.42362	43.2	AVG	57.4	47.4	-4.2	Pass	L1
0.51625	42.5	QP	56.0	46.0	-13.5	Pass	L1
0.51625	39.2	AVG	56.0	46.0	-6.8	Pass	L1
0.60975	40.8	QP	56.0	46.0	-15.2	Pass	L1
0.60975	37.4	AVG	56.0	46.0	-8.6	Pass	L1
0.23565	53.1	QP	62.3	52.3	-9.2	Pass	L2
0.23565	52.0	AVG	62.3	52.3	-0.3	Pass	L2
0.33287	49.9	QP	59.4	49.4	-9.5	Pass	L2
0.33287	48.8	AVG	59.4	49.4	-0.6	Pass	L2
0.42699	47.8	QP	57.3	47.3	-9.5	Pass	L2
0.42699	45.9	AVG	57.3	47.3	-1.4	Pass	L2
0.52000	45.9	QP	56.0	46.0	-10.1	Pass	L2
0.52000	43.5	AVG	56.0	46.0	-2.5	Pass	L2
0.61838	45.2	QP	56.0	46.0	-10.8	Pass	L2
0.61838	42.6	AVG	56.0	46.0	-3.4	Pass	L2
The emissions were scanned from 150 kHz to 30 MHz at AC mains terminal via a LISN, please refer to Plots # 1 and 2 for detailed measurement information.							

Plot 1: AC Power Line Conducted Emissions
 Line tested: L1

1/1

Signal	Freq (MHz)	PK Amp	QP Amp	AV Amp	AV Δ L2
1	0.233400	52.6	51.5	50.3	-2.1
2	0.330270	49.0	47.4	45.9	-3.6
3	0.423625	47.0	45.4	43.2	-4.2
4	0.516250	44.8	42.5	39.2	-6.8
5	0.609750	43.3	40.8	37.4	-8.6

ACTV DET: PEAK
 MEAS DET: PEAK QP AVG
 MKR 230 kHz
 51.28 dB μ V

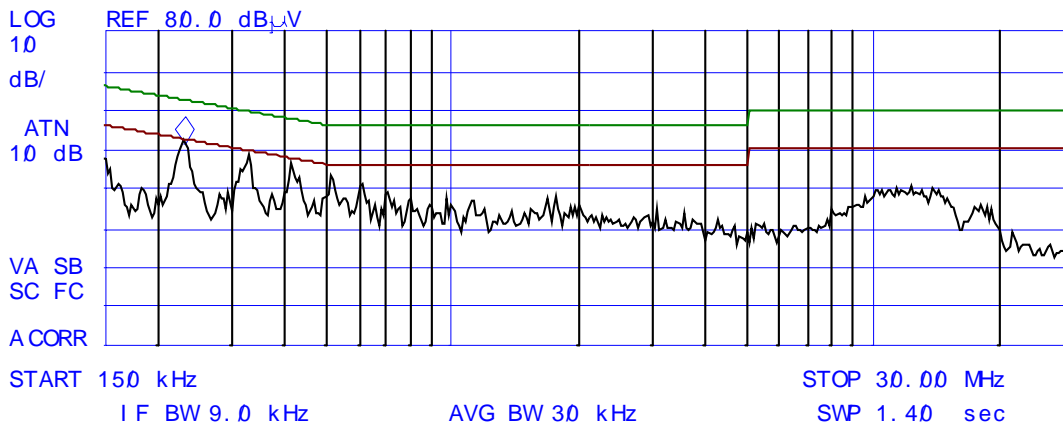

Plot 2: AC Power Line Conducted Emissions
 Line tested: L2



Signal	Freq (MHz)	PK Amp	QP Amp	AV Amp	AV Δ L2
1	0.235650	54.3	53.1	52.0	-0.3
2	0.332875	51.5	49.9	48.8	-0.6
3	0.426995	49.7	47.8	45.9	-1.4
4	0.520000	47.5	45.9	43.5	-2.5
5	0.618385	47.1	45.2	42.6	-3.4

ACTV DET: PEAK
 MEAS DET: PEAK QP AVG
 MKR 230 kHz
 49.30 dB μ V

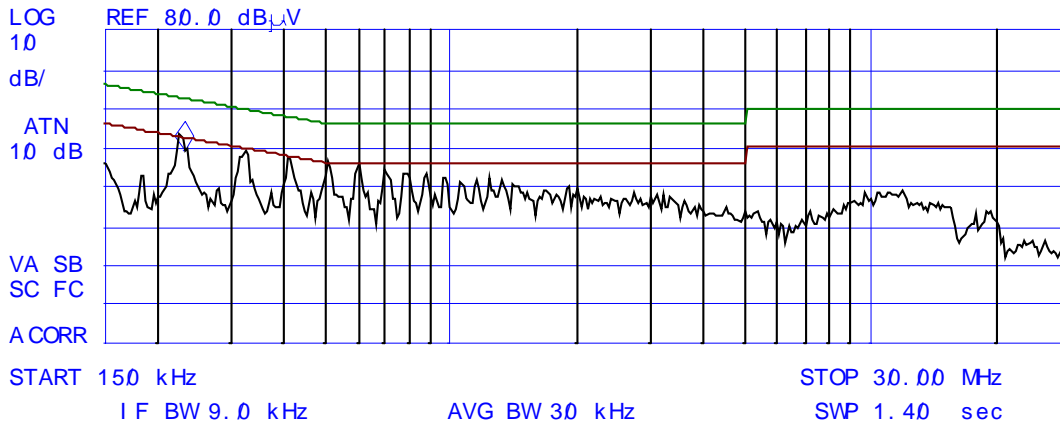

6.6. RECEIVER ANTENNA POWER SPURIOUS/HARMONIC CONDUCTED EMISSIONS [47 CFR 15.111(a)]

6.6.1. Limits

Receivers that operate (tune) in the frequency range 30 to 960 MHz and CB receivers that provides terminals for the connection of an external antenna may be tested to demonstrate compliance with the provisions of §15.109 with the antenna terminals shielded and terminated with a resistive termination equal to the impedance specified for the antenna, provided these receivers also comply with the following: ***With the receiver antenna terminal connected to a resistive termination equal to the impedance specified or employed for the antenna, the power at the antenna terminal at frequency within the range from 30 Mhz to 5th harmonic of the highest frequency shall not exceed 2.0 nanowatts (or -57 dBm @ 50 Ohm).***

6.6.2. Method of Measurements

TIA-603-B

6.6.3. Test Equipment List

Test Instruments	Manufacturer	Model No.	Serial No.	Frequency Range
Spectrum Analyzer	Advantest	R3271	15050203	9 kHz – 26.5 GHz

6.6.4. Test Arrangement

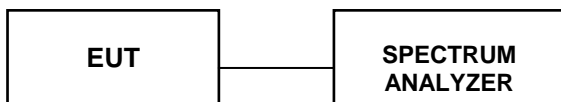

6.6.5. Test Data

Conform. The rf emissions were scanned from 30 MHz to 5 GHz at the Receiver antenna port; see the following plots (# 3-8) for details.

Plot # 3: Receiver Antenna Port # 1 Power Conducted Emissions
Receive Frequency: 30 MHz

hp

ACTV DET: PEAK
MEAS DET: PEAK QP AVG
MKR 277.3 MHz
- 80.10 dBm

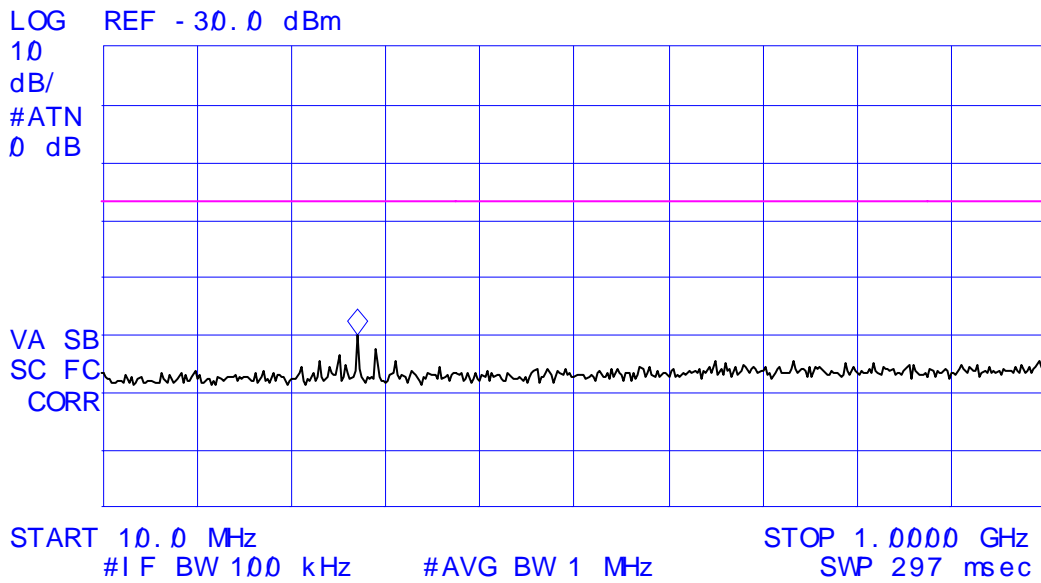

Plot # 4: Receiver Antenna Port # 1 Power Conducted Emissions
Receive Frequency: 45 MHz

hp

ACTV DET: PEAK
MEAS DET: PEAK QP AVG
MKR 279.8 MHz
- 80.49 dBm

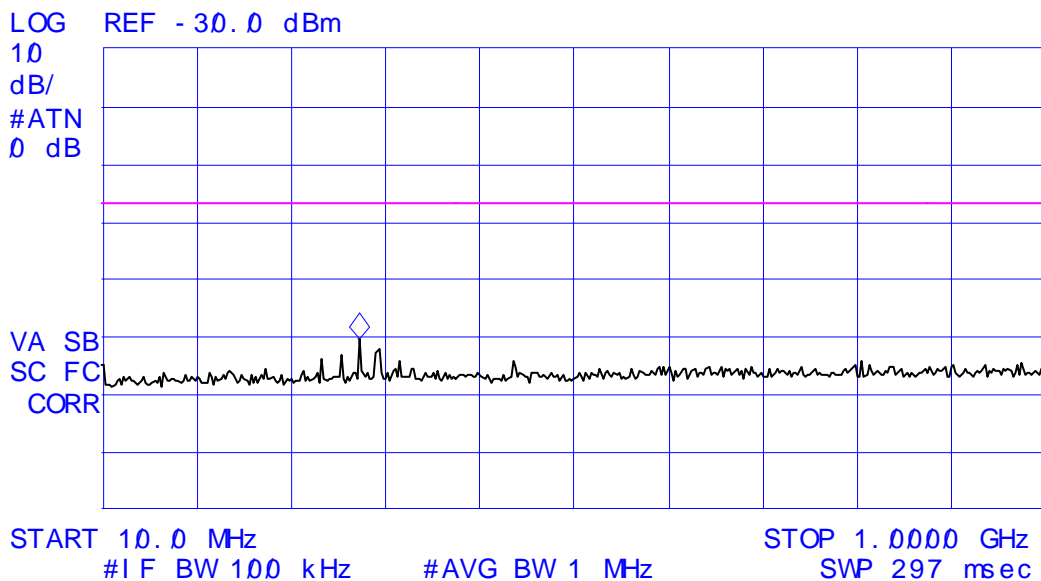

Plot # 5: Receiver Antenna Port # 1 Power Conducted Emissions
Receive Frequency: 60 MHz

hp

ACTV DET: PEAK
MEAS DET: PEAK QP AVG
MKR 279.8 MHz
- 80.05 dBm

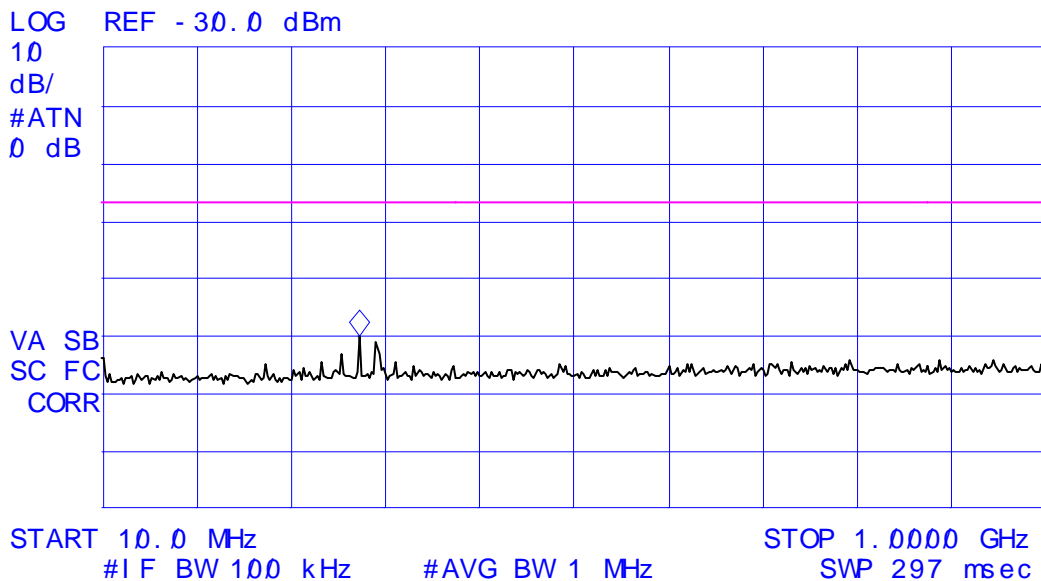

Plot # 6: Receiver Antenna Port # 2 Power Conducted Emissions
Receive Frequency: 30 MHz

typ

ACTV DET: PEAK
MEAS DET: PEAK QP AVG
MKR 277.3 MHz
- 79.85 dBm

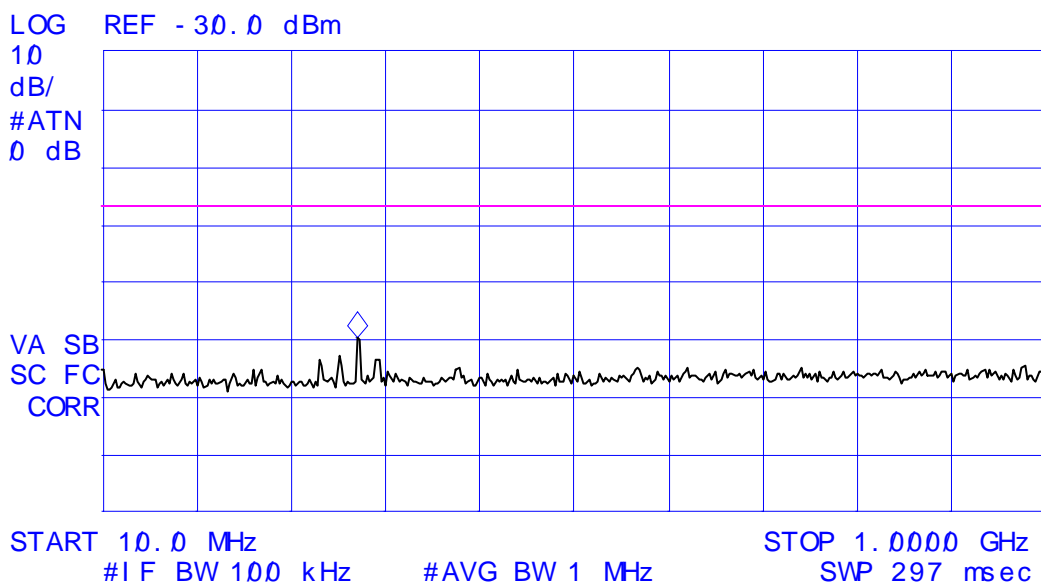

Plot # 7: Receiver Antenna Port # 2 Power Conducted Emissions
Receive Frequency: 45 MHz

hp

ACTV DET: PEAK
MEAS DET: PEAK QP AVG
MKR 279.8 MHz
- 79.86 dBm

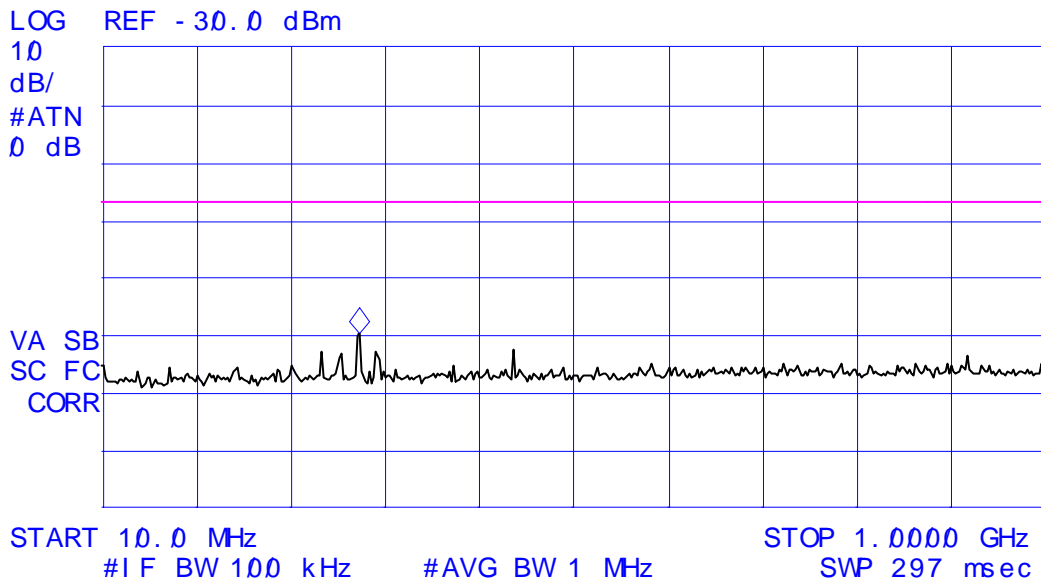

Plot # 8: Receiver Antenna Port # 2 Power Conducted Emissions
Receive Frequency: 60 MHz

hp

ACTV DET: PEAK
MEAS DET: PEAK QP AVG
MKR 277.3 MHz
- 78.89 dBm

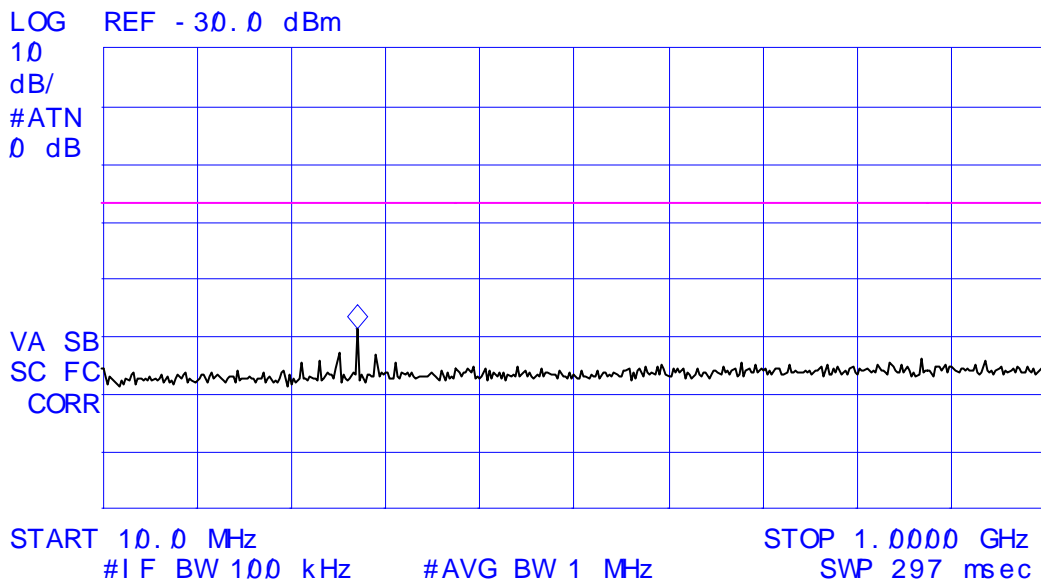

6.7. RECEIVER SPURIOUS/HARMONIC RADIATED EMISSIONS [47 CFR 15.109(a)]

6.7.1. Limits

The equipment shall meet the limits of the following table:

Test Frequency Range (MHz)	Limits @ 3 m (dB μ V/m)	EMI Detector Used	Measuring Bandwidth (kHz)
30 – 88	40.0	Quasi-Peak	RBW = 120 kHz, VBW \geq 120 kHz
88 – 216	43.5	Quasi-Peak	RBW = 120 kHz, VBW \geq 120 kHz
216 – 960	46.0	Quasi-Peak	RBW = 120 kHz, VBW \geq 120 kHz
Above 960	54.0	Average	RBW = 1 MHz, VBW \geq 1 Hz

6.7.2. Method of Measurements

Please refer to the Exhibit 8 of this test report and ANSI C63-4:2003 for radiated emissions test method.

The EUT shall be scanned from 30 MHz to the 5th harmonic of the highest oscillator frequency in the Scanning Receivers or 1 GHz whichever is higher.

6.7.3. Test Equipment List

Test Instruments	Manufacturer	Model No.	Serial No.	Frequency Range
Spectrum Analyzer	Advantest	R3271	15050203	9 kHz – 26.5 GHz
Microwave Amplifier	Hewlett Packard	HP 83017A	3116A00661	1 GHz to 26.5 GHz
Active Loop Antenna	EMCO	6507	8906-1167	1 kHz – 30 MHz
Biconilog Antenna	EMCO	3143	1029	20 MHz to 2 GHz
Horn Antenna	EMCO	3155	9701-5061	1 GHz – 18 GHz
Horn Antenna with Mixer	EMCO	3160-09	1007	18 GHz – 26.5 GHz
Horn Antenna with Mixer	EMCO	3160-10	1001	26.5 GHz – 40 GHz

6.7.4. Test Data

6.7.4.1. Radiated Emissions from the Receiver @ 94.455 MHz

The emissions were scanned from 30 MHz to 1.0 GHz at 3 meters distance and all emissions less than 20 dB below the limits were recorded.

FREQUENCY (MHz)	RF LEVEL @ 3M (dBuV/m)	DETECTOR USED (PEAK/QP)	ANTENNA PLANE (H/V)	LIMIT @ 3M (dBuV/m)	MARGIN (dB)	PASS/ FAIL
94.46	22.4	PEAK	V	43.5	-21.1	PASS
188.91	20.6	PEAK	V	43.5	-22.9	PASS
188.91	19.6	PEAK	H	43.5	-23.9	PASS
377.82	28.6	PEAK	V	46.0	-17.4	PASS
377.82	29.8	PEAK	H	46.0	-16.3	PASS
566.73	27.7	PEAK	V	46.0	-18.3	PASS
566.73	26.6	PEAK	H	46.0	-19.4	PASS
944.55	30.2	PEAK	V	46.0	-15.8	PASS
944.55	30.8	PEAK	H	46.0	-15.2	PASS

Radiated Emissions Measurements @ 3m OFTS
 ICOM All Mode Transceiver, Model: IC-756PROIII

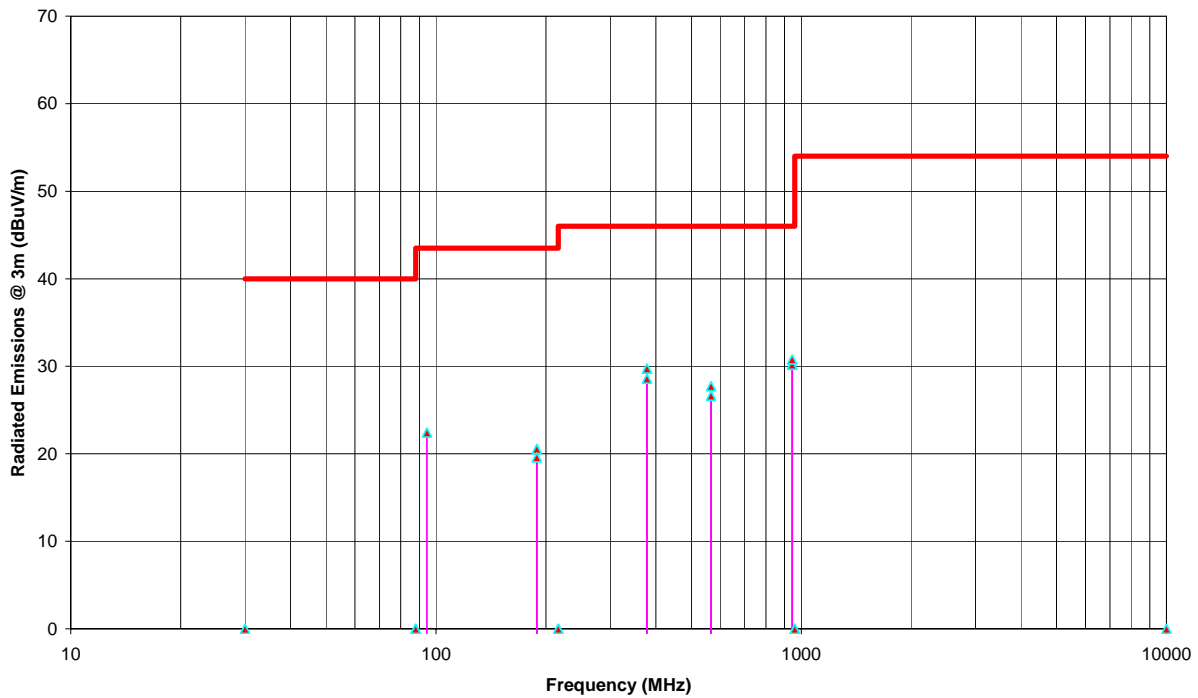

6.7.4.2. Radiated Emissions from the Receiver @ 109.455 MHz

The emissions were scanned from 30 MHz to 1.0 GHz at 3 meters distance and all emissions less than 20 dB below the limits were recorded.

FREQUENCY (MHz)	RF LEVEL @ 3M (dBuV/m)	DETECTOR USED (PEAK/QP)	ANTENNA PLANE (H/V)	LIMIT @ 3M (dBuV/m)	MARGIN (dB)	PASS/FAIL
109.46	24.2	PEAK	V	43.5	-19.3	PASS
109.46	20.2	PEAK	V	43.5	-23.3	PASS
328.36	27.6	PEAK	V	46.0	-18.4	PASS
328.36	30.6	PEAK	H	46.0	-15.4	PASS
437.82	32.6	PEAK	V	46.0	-13.4	PASS
437.82	31.2	PEAK	H	46.0	-14.8	PASS
656.73	29.6	PEAK	V	46.0	-16.4	PASS
656.73	28.8	PEAK	H	46.0	-17.2	PASS
875.64	35.9	PEAK	V	46.0	-10.1	PASS
875.64	34.4	PEAK	H	46.0	-11.6	PASS

**Radiated Emissions Measurements @ 3m OFTS
 ICOM All Mode Transceiver, Model: IC-756PROIII**

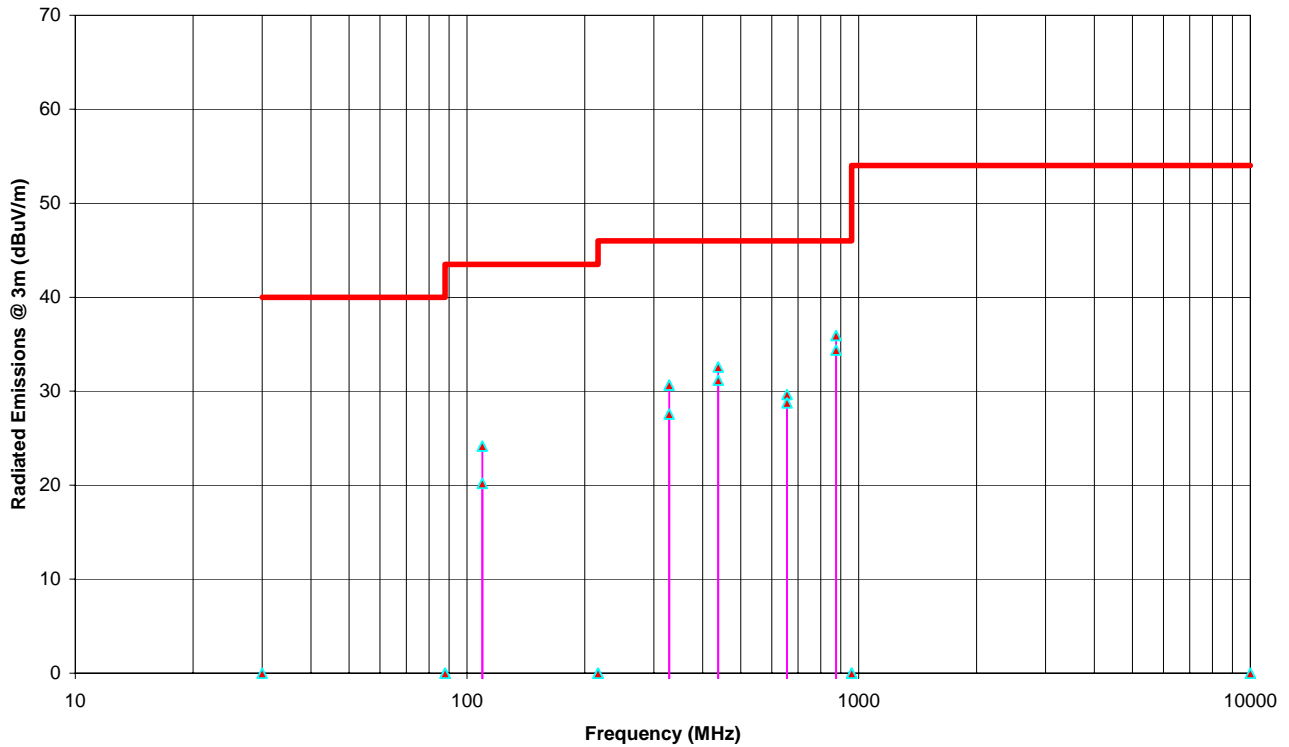

6.7.4.3. Radiated Emissions from the Receiver @ 124.455 MHz

The emissions were scanned from 30 MHz to 1.0 GHz at 3 meters distance and all emissions less than 20 dB below the limits were recorded.

FREQUENCY (MHz)	RF LEVEL @ 3M (dBuV/m)	DETECTOR USED (PEAK/QP)	ANTENNA PLANE (H/V)	LIMIT @ 3M (dBuV/m)	MARGIN (dB)	PASS/FAIL
124.46	24.6	PEAK	V	43.5	-18.9	PASS
124.46	20.8	PEAK	V	43.5	-22.7	PASS
248.91	25.7	PEAK	V	46.0	-20.3	PASS
248.91	31.9	PEAK	H	46.0	-14.1	PASS
871.18	31.3	PEAK	V	46.0	-14.8	PASS
871.18	32.0	PEAK	H	46.0	-14.1	PASS
995.64	32.0	PEAK	V	54.0	-22.0	PASS
995.64	33.2	PEAK	H	54.0	-20.8	PASS

Radiated Emissions Measurements @ 3m OFTS
 ICOM All Mode Transceiver, Model: IC-756PROIII

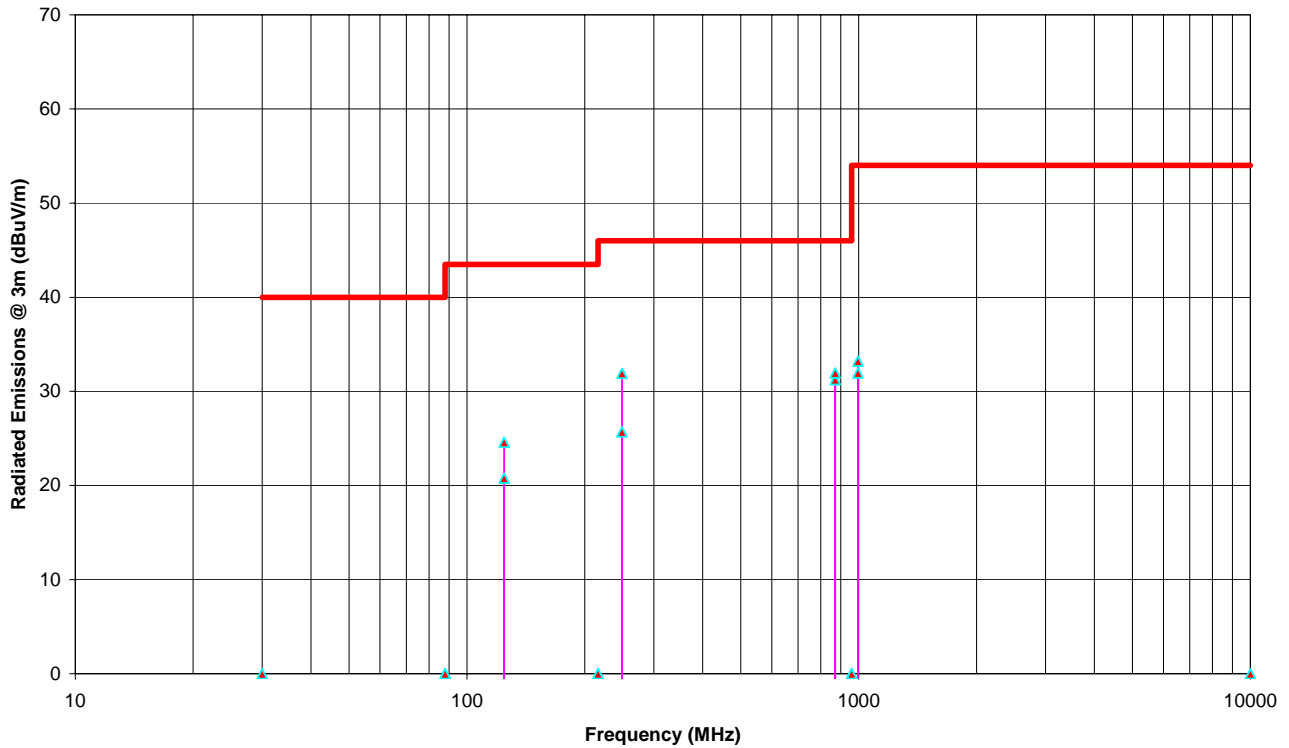

6.8. RADIATED EMISSIONS FROM CLASS B UNINTENTIONAL RADIATION (DIGITAL DEVICE) [47 CFR 15.109 (a)]

6.8.1. Limits

The equipment shall meet the limits of the following table:

Test Frequency Range (MHz)	Class B Limits @ 3 m (dB μ V/m)	EMI Detector Used	Measuring Bandwidth (kHz)
30 – 88	40.0	Quasi-Peak	RBW = 120 kHz, VBW \geq 120 kHz
88 – 216	43.5	Quasi-Peak	RBW = 120 kHz, VBW \geq 120 kHz
216 – 960	46.0	Quasi-Peak	RBW = 120 kHz, VBW \geq 120 kHz
Above 960	54.0	Average	RBW = 1 MHz, VBW \geq 1 Hz

6.8.2. Method of Measurements

Please refer to the Exhibit 5 of this test report and ANSI C63-4:2003 for radiated emissions test method.

The EUT shall be scanned from 30 MHz to the 5th harmonic of the highest oscillator frequency in the Scanning Receivers or 1 GHz whichever is higher.

6.8.3. Test Equipment List

Test Instruments	Manufacturer	Model No.	Serial No.	Frequency Range
Spectrum Analyzer	Advantest	R3271	15050203	9 kHz – 26.5 GHz
Microwave Amplifier	Hewlett Packard	HP 83017A	3116A00661	1 GHz to 26.5 GHz
Active Loop Antenna	EMCO	6507	8906-1167	1 kHz – 30 MHz
Biconilog Antenna	EMCO	3143	1029	20 MHz to 2 GHz
Horn Antenna	EMCO	3155	9701-5061	1 GHz – 18 GHz
Horn Antenna with Mixer	EMCO	3160-09	1007	18 GHz – 26.5 GHz
Horn Antenna with Mixer	EMCO	3160-10	1001	26.5 GHz – 40 GHz

6.8.4. Test Data

The emissions were scanned from 30 MHz to 1.0 GHz at 3 meters distance and all emissions less than 20 dB below the limits were recorded.

FREQUENCY (MHz)	RF LEVEL@ 3M (dBuV/m)	DETECTOR USED (PEAK/QP)	ANTENNA PLANE (H/V)	LIMIT @ 3M (dBuV/m)	MARGIN (dB)	PASS/ FAIL
94.80	22.9	PEAK	V	43.5	-20.7	PASS
118.40	22.7	PEAK	V	43.5	-20.8	PASS
177.40	22.0	PEAK	V	43.5	-21.5	PASS
177.40	24.2	PEAK	H	43.5	-19.3	PASS
197.00	29.0	PEAK	V	43.5	-14.5	PASS
197.00	30.9	PEAK	H	43.5	-12.6	PASS
215.98	30.4	PEAK	V	43.5	-13.2	PASS
215.98	32.0	PEAK	H	43.5	-11.5	PASS
315.30	32.9	PEAK	V	46.0	-13.1	PASS
315.30	32.4	PEAK	H	46.0	-13.6	PASS
344.00	37.0	PEAK	V	46.0	-9.0	PASS
344.00	40.9	PEAK	H	46.0	-5.1	PASS
393.70	34.9	PEAK	V	46.0	-11.1	PASS
393.70	31.5	PEAK	H	46.0	-14.5	PASS
640.00	34.2	PEAK	V	46.0	-11.8	PASS
640.00	33.6	PEAK	H	46.0	-12.4	PASS

Radiated Emissions Measurements @ 3m OFTS
ICOM All Mode Transceiver, Model: IC-756PROIII

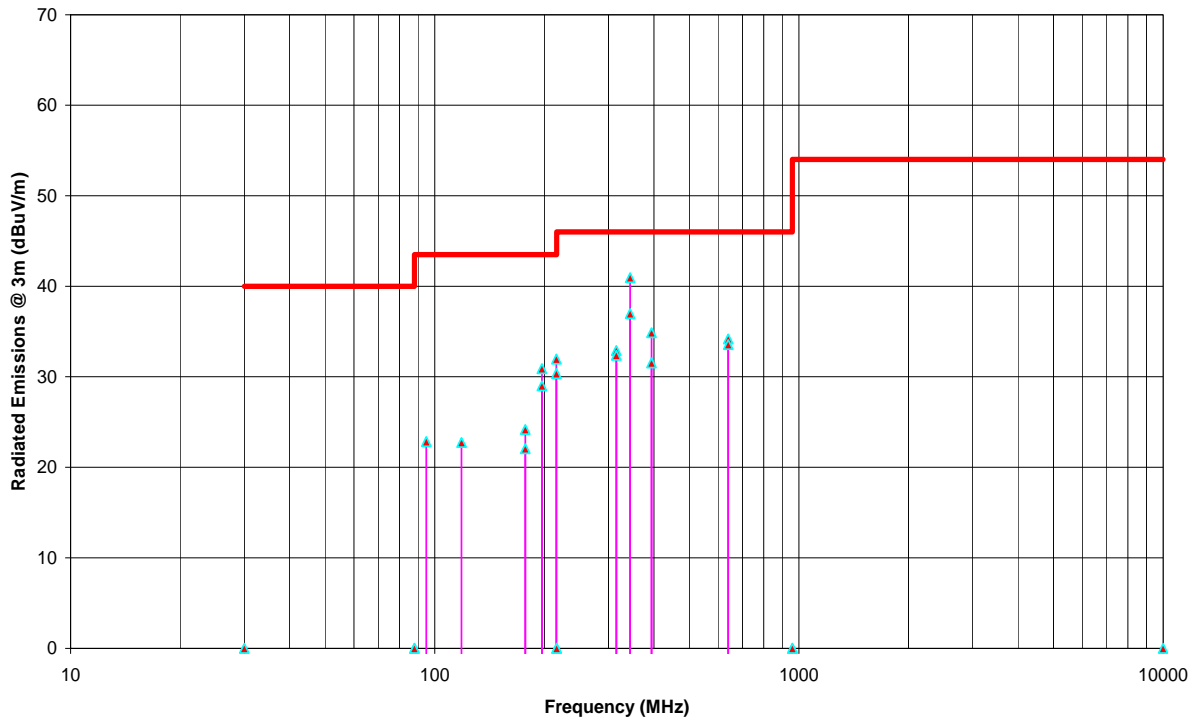

6.9. REQUIREMENTS FOR SCANNING RECEIVERS [47 CFR 15.121]

6.9.1. FCC Rules

- a. Except as provided in paragraph (c) of this section, scanning receivers and frequency converters designed or marketed for use with scanning receivers, shall:
 - (1) Be incapable of operating (tuning), or readily being altered by the user to operate, within the frequency bands allocated to the Cellular Radiotelephone Service in part 22 of this chapter (cellular telephone bands). Scanning receivers capable of "readily being altered by the user" include, but are not limited to, those for which the ability to receive transmissions in the cellular telephone bands can be added by clipping the leads of, or installing, a simple component such as a diode, resistor or jumper wire; replacing a plug-in semiconductor chip; or programming a semiconductor chip using special access codes or an external device, such as a personal computer. Scanning receivers, and frequency converters designed for use with scanning receivers, also shall be incapable of converting digital cellular communication transmissions to analog voice audio.
 - (2) Be designed so that the tuning, control and filtering circuitry is inaccessible. The design must be such that any attempts to modify the equipment to receive transmissions from the Cellular Radiotelephone Service likely will render the receiver inoperable.
- b. Except as provided in paragraph (c) of this section, scanning receivers shall reject any signals from the Cellular Radiotelephone Service frequency bands that are 38 dB or lower based upon a 12 dB SINAD measurement, which is considered the threshold where a signal can be clearly discerned from any interference that may be present.
- c. Scanning receivers and frequency converters designed or marketed for use with scanning receivers, are not subject to the requirements of paragraphs (a) and (b) of this section provided that they are manufactured exclusively for, and marketed exclusively to, entities described in 18 U.S.C. 2512(2), or are marketed exclusively as test equipment pursuant to Sec. 15.3(dd)
- d. Modification of a scanning receiver to receive transmissions from Cellular Radiotelephone Service frequency bands will be considered to constitute manufacture of such equipment. This includes any individual, individuals, entity or organization that modifies one or more scanners. Any modification to a scanning receiver to receive transmissions from the Cellular Radiotelephone Service frequency bands voids the certification of the scanning receiver, regardless of the date of manufacture of the original unit. In addition, the provisions of Sec. 15.23 shall not be interpreted as permitting modification of a scanning receiver to receive Cellular Radiotelephone Service transmissions.
- e. Scanning receivers and frequency converters designed for use with scanning receivers shall not be assembled from kits or marketed in kit form unless they comply with the requirements in paragraph (a) through (c) of this section.

- f. Scanning receivers shall have a label permanently affixed to the product, and this label shall be readily visible to the purchaser at the time of purchase. The label shall read as follows: WARNING: MODIFICATION OF THIS DEVICE TO RECEIVE CELLULAR RADIOTELEPHONE SERVICE SIGNALS IS PROHIBITED UNDER FCC RULES AND FEDERAL LAW.
- (3) ``Permanently affixed" means that the label is etched, engraved, stamped, silkscreened, indelible printed or otherwise permanently marked on a permanently attached part of the equipment or on a nameplate of metal, plastic or other material fastened to the equipment by welding, riveting, or permanent adhesive. The label shall be designed to last the expected lifetime of the equipment in the environment in which the equipment may be operated and must not be readily detachable. The label shall not be a stick-on, paper label.
- (4) When the device is so small that it is not practicable to place the warning label on it, the information required by [[Page 711]] this paragraph shall be placed in a prominent location in the instruction manual or pamphlet supplied to the user and shall also be placed on the container in which the device is marketed. However, the FCC identifier must be displayed on the device.

6.9.2. Declaration for Compliance with FCC §15.121

- Comply with FCC 121(a)(1) – This Scanning Receiver is incapable of operating (tuning), or readily being altered by the user to operate, within the frequency bands allocated to the Cellular Radiotelephone Service in part 22 of this chapter (cellular telephone bands).

Please refer to attached manufacturer's declaration for compliance with this Rule.

- Comply with FCC 121(a)(2) – This Scanning Receiver is designed so that the tuning, control and filtering circuitry is inaccessible. The design is such that any attempts to modify the equipment to receive transmissions from the Cellular Radiotelephone Service likely will render the receiver inoperable.

Please refer to attached manufacturer's declaration for compliance with this Rule.

- Comply with FCC 121(b) – Please refer to Section 6.10 for Scanning Receivers Cellular Band Rejection in the next Section of this Test Report.
- Comply with FCC 121(c) – Not applicable.
- Comply with FCC 121(d) – The Users Manual of this Scanning Receiver is provided with the Warning statement as below on Page No. ii.

Warning: Changes or modifications not expressly approved by ICOM Incorporated could void the user's authority to operate the equipment.

- Comply with FCC 121(e) – This Scanning Receiver will not be assembled from kits or marketed in kit form.
- Comply with FCC 121(f) – This Scanning Receiver has a label permanently affixed to the product and this label is readily visible to the purchaser at the time of purchase. The label reads as follows: WARNING: MODIFICATION OF THIS DEVICE TO RECEIVE CELLULAR RADIOTELEPHONE SERVICE SIGNALS IS PROHIBITED UNDER FCC RULES AND FEDERAL LAW.

6.10. SCANNING RECEIVERS CELLULAR BAND REJECTION [47 CFR 15.121(b)]

6.10.1. Limits

Except as provided in paragraph (c) of this section, scanning receivers shall reject any signals from the Cellular Radiotelephone Service frequency bands that are 38 dB or lower based upon a 12 dB SINAD measurement, which is considered the threshold where a signal can be clearly discerned from any interference that may be present.

6.10.2. Method of Measurements

- (1) Connected the EUT as shown in the following block diagram
- (2) Apply a standard RF signal to the receiver input port
- (3) Adjust the audio output signal of the receiver to it's rated value with the distortion less than 10%
- (4) Adjust the RF Signal Generator Output Power to produce 12 dB SINAD without the audio output power dropping by more than 3 dB
- (5) Repeat step (4) at lowest, middle and highest channel frequencies across all cellular base station band to establish a reference sensitivity level. The reference sensitivity taken was the lowest, or worse-case sensitivity for all of the bands.
- (6) Adjust the RF Signal Generator output to a level of +60 dB above the reference sensitivity obtained in step (5)
- (7) Set the Receiver squelch threshold (the signal required to open the squelch) no greater than +20 dB above the reference sensitivity level.
- (8) Put the receiver in a scanning mode and allow it to scan across it's complete receive range
- (9) If the receiver un-squelched or stopped on any frequency, the display frequency is recorded. The signal generator output level was then adjusted until 12 dB SINAD from the receiver was produced. The signal generator level associated with this response was also noted.
- (10) Repeat this procedure for 3 frequencies in the each cellular base station transmit band.
- (11) The difference between the signal generator output for any response recorded and reference sensitivity is the rejection ratio

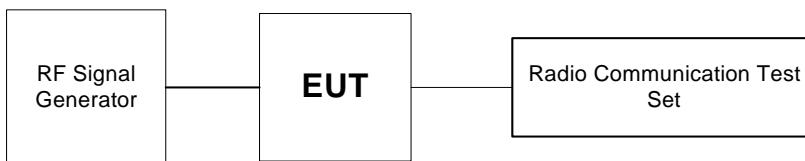

6.10.3. Test Equipment List

Test Instruments	Manufacturer	Model No.	Serial No.	Frequency Range
Radio Communication Test Set	Marconi Instruments	2955	132037/226	10 kHz - 1000 MHz including AF & RF Signal Generators, SINAD, Distortion, Deviation meters and etc...
RF Signal Generator	Fluke	6061A	4770301	10 kHz – 1050 MHz

6.10.3.1. Test Data

Reference Sensitivity Level measured in step (5) = -110 dBm

EUT's Scanning Frequency Band (MHz)	Cellular Base Station Transmitter Band (MHz)	RF Signal Level for 12 dB SINAD (dBm)	Rejection Ratio (dB)	Maximum Rejection Ratio Limit (dB)
0.03 - 60.0	824.04, 836.4, 848.97 869.04, 882.4 & 893.97	-110	< -50.0	-38.0
There is no spurious response detected within the above frequency band with the Rejection Ratio of at least 50 dB.				

EXHIBIT 7. MEASUREMENT UNCERTAINTY

The measurement uncertainties stated were calculated in accordance with the requirements of NIST Technical Note 1297 and NIS 81 (1994).

7.1. LINE CONDUCTED EMISSION MEASUREMENT UNCERTAINTY

CONTRIBUTION (Line Conducted)	PROBABILITY DISTRIBUTION	UNCERTAINTY (dB)	
		9-150 kHz	0.15-30 MHz
EMI Receiver specification	Rectangular	± 1.5	± 1.5
LISN coupling specification	Rectangular	± 1.5	± 1.5
Cable and Input Transient Limiter calibration	Normal (k=2)	± 0.3	± 0.5
Mismatch: Receiver VRC $\Gamma_1 = 0.03$ LISN VRC $\Gamma_R = 0.8(9 \text{ kHz}) 0.2 (30 \text{ MHz})$ Uncertainty limits $20\text{Log}(1+\Gamma_1\Gamma_R)$	U-Shaped	± 0.2	± 0.3
System repeatability	Std. deviation	± 0.2	± 0.05
Repeatability of EUT	--	--	--
Combined standard uncertainty	Normal	± 1.25	± 1.30
Expanded uncertainty U	Normal (k=2)	± 2.50	± 2.60

Sample Calculation for Measurement Accuracy in 150 kHz to 30 MHz Band:

$$u_c(y) = \sqrt{\sum_{i=1}^m u_i^2(y)} = \pm \sqrt{(1.5^2 + 1.5^2)/3 + (0.5/2)^2 + (0.05/2)^2 + 0.35^2} = \pm 1.30 \text{ dB}$$

$$U = 2u_c(y) = \pm 2.6 \text{ dB}$$

7.2. RADIATED EMISSION MEASUREMENT UNCERTAINTY

CONTRIBUTION (Radiated Emissions)	PROBABILITY DISTRIBUTION	UNCERTAINTY (+ dB)	
		3 m	10 m
Antenna Factor Calibration	Normal (k=2)	± 1.0	± 1.0
Cable Loss Calibration	Normal (k=2)	± 0.3	± 0.5
EMI Receiver specification	Rectangular	± 1.5	± 1.5
Antenna Directivit	Rectangular	+0.5	+0.5
Antenna factor variation with height	Rectangular	± 2.0	± 0.5
Antenna phase center variation	Rectangular	0.0	± 0.2
Antenna factor frequency interpolation	Rectangular	± 0.25	± 0.25
Measurement distance variation	Rectangular	± 0.6	± 0.4
Site imperfections	Rectangular	± 2.0	± 2.0
Mismatch: Receiver VRC $\Gamma_1 = 0.2$ Antenna VRC $\Gamma_R = 0.67(Bi) 0.3 (Lp)$ Uncertainty limits $20\text{Log}(1 \pm \Gamma_1 \Gamma_R)$	U-Shaped	+1.1 -1.25	± 0.5
System repeatability	Std. Deviation	± 0.5	± 0.5
Repeatability of EUT		-	-
Combined standard uncertainty	Normal	+2.19 / -2.21	+1.74 / -1.72
Expanded uncertainty U	Normal (k=2)	+4.38 / -4.42	+3.48 / -3.44

Calculation for maximum uncertainty when 3m biconical antenna including a factor of k = 2 is used:

$$U = 2u_c(y) = 2x(+2.19) = +4.38 \text{ dB} \quad \text{And} \quad U = 2u_c(y) = 2x(-2.21) = -4.42 \text{ dB}$$

EXHIBIT 8. MEASUREMENT METHODS

8.1. GENERAL TEST CONDITIONS

8.1.1. Test Conditions

- The measurement shall be made in the operational mode producing the largest emission in the frequency band being investigated consistent with normal applications.
- An attempt shall be made to maximize the detected radiated emissions, for example moving cables of the equipment, rotating the equipment by 360° and moving the measuring receiving antenna up and down within 1 to 4 meters high.
- Where appropriate, a single tone or a bit stream shall be used to modulate the receiver. The manufacturer shall define the modulation with the highest emission in transmit mode.

8.1.2. Method of Measurements - AC Mains Conducted Emissions

- AC Mains conducted emissions measurements were performed in accordance with the standard against appropriate limits for each detector function.
- The test was performed in the shielded room, 16'(L) by 16'(W) by 12'(H).
- The test was performed were made over the frequency range from 150 kHz to 30 MHz to determine the line-to-ground radio noise voltage which was conducted from the EUT power-input terminals that were directly connected to a public power network.
- The EUT normally received power from another device that connects to the public utility ac power lines, measurements would be made on that device with the EUT in operation to ensure that the device continues to comply with the appropriate limits while providing the EUT with power.
- If the EUT operates only from internal or dedicated batteries, with no provisions for connection to the public utility ac power lines, AC Mains conducted measurements are not required.
- Table-top devices were placed on a platform of nominal size 1 m by 1.5m raised 80 cm above the conducting ground plane.
- The EUT current-carrying power lead, except the ground (safety) lead, was individually connected through a LISN to the power source. All unused 50-Ohm connectors of the LISN was terminated in 50-ohm when not connected to the measuring instruments.
- The line cord of the EUT connected to one LISN which was connected to the measuring instrument. Those power cords for the units of devices not under measurement were connected to a separate multiple ac outlet. Drawings and photographs of typically conducted emission test setups were shown in the Test Report. Each current-carrying conductor of the EUT shall be individually tested.
- The EUT was normally operated with a ground (safety) connection, the EUT was connected to the ground at the LISN through a conductor provided in the lead from the ac power mains to the LISN.
- The excess length of the power cord was folded back and forth in an 8-shape on a wooden strip with a vertical prong located on the top of the LISN case.
- The EUT was set-up in its typical configuration and operated in its various modes as described in this test report.
- A preliminary scan was made by using spectrum analyzer system with the detector function set to PEAK mode (9 KHz RBW, VBW > RBW), frequency span 150KHz - 30MHz.

- The maximum conducted emission for a given mode of operation was found by using the following step-by-step procedure:

Step 1. Monitor the frequency range of interest at a fixed EUT azimuth.

Step 2. Manipulate the system cables and peripheral devices to produce highest amplitude signal relative to the limit. Note the amplitude and frequency of the suspect signal.

Step 3. The effects of various modes of operation is examined. This is done by varying equipment operation modes as step 2 is being performed.

Step 4. After completing step 1 through 3, record EUT and peripheral device configuration, mode of operation, cable configuration, signal levels and frequencies for final test.

- Each highest signal level at the maximized test configuration was zoomed in a small frequency span on the spectrum analyzer's display (the manipulation of cables and peripheral devices and EUT operation modes might have to be repeated to obtain the highest signal level with the spectrum analyzer set to PEAK detector mode 9 KHz RBW and VBW > RBW). The spectrum analyzer was then set to CISPR QUASI-PEAK detector mode (10 KHz RBW, 1 MHz VBW) and AVERAGE detector mode (9 kHz RBW, 1 Hz VBW). The final highest RF signal levels and frequencies were record.

8.1.3. Method of Measurements - Electric Field Radiated Disturbance

- The radiated emission measurements were performed at the UltraTech's 3 Meter Open Field Test Site (OFTS) situated in the Town of Oakville, province of Ontario. The Attenuation Characteristics of OFTS have been filed to FCC, Industry Canada, ACA/Austel, NVLap and ITI.
- Radiated emissions measurements were made using the following test instruments:

1. Calibrated EMCO BiconiLog antenna in the frequency range from 30 MHz to 2000 MHz.
2. Calibrated Emco Horn antennas in the frequency range above 1000 MHz (1GHz - 40 GHz).
3. Calibrated Advantest spectrum analyzer and pre-selector. In general, the spectrum analyzer would be used as follows:
 - The rf electric field levels were measured with the spectrum analyzer set to PEAK detector (120 KHz VBW and VBW \geq RBW).
 - If any rf emission was observed to be a broadband noise, the spectrum analyzer's CISPR QUASI-PEAK detector (120 KHz RBW and VBW \geq RBW) was then set to measure the signal level.
 - If the signal being measured was narrowband and the ambient field was broadband, the bandwidth of the spectrum analyzer was reduced.

- The EUT was set-up in its typical configuration and operated in its various modes as described in this test report.
- The frequencies of emissions was first detected. Then the amplitude of the emissions was measured at the specified measurement distance using required antenna height, polarization, and detector characteristics.
- During this process, cables and peripheral devices were manipulated within the range of likely configuration.

- For each mode of operation required to be tested, the frequency spectrum was monitored. Variations in antenna heights (from 1 meter to 4 meters above the ground plane), antenna polarization (horizontal plane and vertical plane), cable placement and peripheral placement were explored to produce the highest amplitude signal relative to the limit.

The maximum radiated emission for a given mode of operation was found by using the following step-by-step procedure:

- Step 1: Monitor the frequency range of interest at a fixed antenna height and EUT azimuth.
- Step 2: Manipulate the system cables to produce highest amplitude signal relative to the limit. Note the amplitude and frequency of the suspect signal.
- Step 3: Rotate the EUT 360 degrees to maximize the suspected highest amplitude signal. If the signal or another at a different frequency is observed to exceed the previously noted highest amplitude signal by 1 dB or more, go back to the azimuth and repeat Step 2. Otherwise, orient the EUT azimuth to repeat the highest amplitude observation and proceed.
- Step 4: Move the antenna over its full allowed range of travel (1 to 4 meters) to maximize the suspected highest amplitude signal. If the signal or another at a different frequency is observed to exceed the previously noted highest amplitude signal by 1 dB or more, return to Step 2 with the highest amplitude observation and proceed.
- Step 5: Change the polarization of the antenna and repeat Step 2 through 4. Compare the resulting suspected highest amplitude signal with that found for the other polarization. Select and note the higher of the two signals. This signal is termed the highest observed signal with respect to the limit for this EUT operational mode.
- Step 6: The effects of various modes of operation is examined. This is done by varying the equipment modes as steps 2 through 5 are being performed.
- Step 7: After completing steps 1 through 6, record the final highest emission level, frequency, antenna polarization and detector mode of the measuring instrument.

Calculation of Field Strength:

The field strength is calculated by adding the calibrated antenna factor and cable factor, and subtracting the Amplifier gain (if any) from the measured reading. The basic equation with a sample calculation is as follows:

$$FS = RA + AF + CF - AG$$

Where FS = Field Strength
RA = Receiver/Analyzer Reading
AF = Antenna Factor
CF = Cable Attenuation Factor
AG = Amplifier Gain

Example: If a receiver reading of 60.0 dB μ V is obtained, the antenna factor of 7.0 dB/m and cable factor of 1.0 dB are added, and the amplifier gain of 30 dB is subtracted. The actual field strength will be:

Field Level = 60 + 7.0 + 1.0 - 30 = 38.0 dB μ V/m.

Field Level = $10^{(38/20)}$ = 79.43 μ V/m.