



PCTEST Engineering Laboratory, Inc.
 6660-B Dobbin Road (Columbia, MD 21045 (U.S.A.
 TEL (410) 290-6652 (FAX (410) 290-6654
<http://www.pctestlab.com>



CERTIFICATE OF COMPLIANCE FCC Parts 24/22 Certification

SANYO ELECTRIC CO., LTD.
 c/o Sanyo Sales & Supply (USA) Corp.
 900 North Arlington Heights Road, Suite 300
 Itasca, IL 60143-2844
 Attn: Mr. Koichi Takahashi, V.P. Marketing
 SANYO Fisher (USA) Corporation

Dates of Tests: Nov. 19-27, 2001
 Test Report S/N: SAR.211119660.AEZ
 Test Site: PCTEST Lab, Columbia, MD USA

FCC ID

AEZSCP-62H

APPLICANT

SANYO ELECTRIC CO., LTD.

Classification:	Licensed Portable Transmitter Held to Ear (PCE)
FCC Rule Part(s):	§24(E), §22(H), §2
EUT Type:	Dual-Band Analog/PCS Phone (AMPS/CDMA)
Trade Name/Model:	SANYO SCP-6200
Tx Frequency Range:	824.04MHz – 848.97MHz (AMPS)/ 1851.25MHz – 1908.75MHz (CDMA)
Rx Frequency Range:	869.04MHz – 893.97MHz (AMPS)/ 1931.25MHz – 1988.75MHz (CDMA)
Max. RF Output Power:	0.387 W ERP AMPS (25.873 dBm) / 0.211 W EIRP PCS CDMA (23.251 dBm)
Max. SAR Measurements:	0.9325 mW/g (1g) AMPS Brain SAR; 1.2057 W/kg AMPS Body SAR; 1.4657 mW/g (1g) PCS Brain SAR; 1.2673 W/kg PCS Body SAR
Emission Designator(s):	40K0F8W, 40K0F1D, 1M25F9W

This equipment has been shown to be capable of compliance with the applicable technical standards as indicated in the measurement report and was tested in accordance with the measurement procedures specified in §2.947.

I attest to the accuracy of data. All measurements reported herein were performed by me or were made under my supervision and are correct to the best of my knowledge and belief. I assume full responsibility for the completeness of these measurements and vouch for the qualifications of all persons taking them.

PCTEST certifies that no party to this application has been denied the FCC benefits pursuant to Section 5301 of the Anti-Drug Abuse Act of 1988, 21 U.S.C. 862.

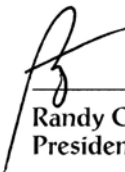
 Randy Ortanez
 President



NVLAP[®]
 LAB CODE 100431-0

TABLE OF CONTENTS

ATTACHMENT A: COVER LETTER(S)	
ATTACHMENT B: ATTESTATION STATEMENT(S)	
ATTACHMENT C: TEST REPORT	
1.1 SCOPE	1
2.1 INTRODUCTION	2
3.1 INSERTS PER §2.1033(d)	3
4.1 DESCRIPTION OF TESTS	4-7
5.1 EFFECTIVE RADIATED POWER OUTPUT	8
6.1 EQUIVALENT ISOTROPIC RADIATED POWER	9
7.1 RADIATED MEASUREMENTS	10-15
8.1 FREQUENCY STABILITY	16-19
9.1 PLOTS OF EMISSIONS	20
10.1 LIST OF TEST EQUIPMENT	21
11.1 SAMPLE CALCULATIONS	22
12.1 CONCLUSION	23
ATTACHMENT D: TEST PLOTS	
ATTACHMENT E: FCC ID LABEL / LOCATION	
ATTACHMENT F: TEST SETUP PHOTOGRAPHS	
ATTACHMENT G: EXTERNAL PHOTOGRAPHS	
ATTACHMENT H: INTERNAL PHOTOGRAPHS	
ATTACHMENT I: BLOCK DIAGRAM(S)	
ATTACHMENT J: SCHEMATIC DIAGRAM(S)	
ATTACHMENT K: OPERATIONAL DESCRIPTION	
ATTACHMENT L: PARTS LIST/TUNE UP PROCEDURE	
ATTACHMENT M: USER'S MANUAL	
ATTACHMENT N: SAR MEASUREMENT REPORT	
ATTACHMENT O: SAR TEST DATA	
ATTACHMENT P: SAR TEST SETUP PHOTOGRAPHS	

MEASUREMENT REPORT

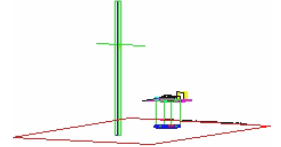
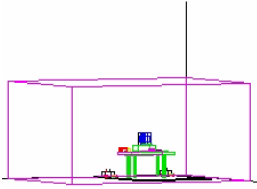

1.1 Scope

Measurement and determination of electromagnetic emissions (EME) of radio frequency devices including intentional and/or unintentional radiators for compliance with the technical rules and regulations of the Federal Communications Commission.

General Information

Applicant Name:	SANYO ELECTRIC CO., LTD. c/o Sanyo Sales & Supply (USA) Corp.
Address:	900 North Arlington Heights Road, Suite 300 Itasca, IL 60143-2844
Attention:	Mr. Koichi Takahashi, V.P. Marketing SANYO Fisher (USA) Corporation

- FCC ID: **AEZSCP-62H**
- Quantity: Quantity production is planned
- Emission Designator: 1M25F9W, 40K0F8W, 40K0F1D
- Tx Freq. Range: 824.04 – 848.97 MHz (AMPS)
1851.25 – 1908.75 MHz (CDMA)
- Rx Freq. Range: 869.04 – 893.97 MHz (AMPS)
1931.25- 1988.75 MHz (CDMA)
- Max. RF Power Rating: 0.387 W ERP AMPS (25.873 dBm)
0.211 W EIRP PCS CDMA (23.251dBm)
- Max. SAR Measurements: 0.9325 mW/g (1g) AMPS Brain SAR;
1.4657 mW/g (1g) PCS CDMA Brain SAR
1.2057 mW/g (1g) AMPS Body SAR;
1.2673 mW/g (1g) PCS CDMA Body SAR
- FCC Classification(s): Licensed Portable Tx Held to Ear (PCE)
- Equipment (EUT) Type: Dual Band Analog/PCS Phone (AMPS/CDMA)
- Frequency Tolerance: $\pm 0.00025\%$ (2.5 ppm)
- FCC Rule Part(s): § 24(E), §22(H), §2
- Dates of Tests: Nov. 19-27, 2001
- Place of Tests: PCTEST Lab, Columbia, MD U.S.A.
- Test Report S/N: 24/22.211119660.AEZ

2.1 INTRODUCTION

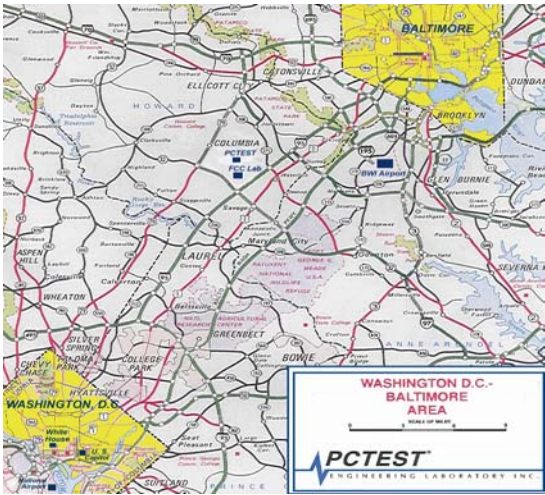

Figure 1. Map of the Greater Baltimore and Metropolitan Washington, D.C. area.

These measurement tests were conducted at **PCTEST Engineering Laboratory, Inc.** facility in New Concept Business Park, Guilford Industrial Park, Columbia, Maryland. The site address is 6660-B Dobbin Road, Columbia, MD 21045. The test site is one of the highest points in the Columbia area with an elevation of 390 feet above mean sea level. The site coordinates are 39° 11'15" N latitude and 76° 49'38" W longitude. The facility is 1.5 miles North of the FCC laboratory, and the ambient signal and ambient signal strength are approximately equal to those of the FCC laboratory. There are no FM or TV transmitters within 15 miles of the site. The detailed description of the measurement facility was found to be in compliance with the requirements of § 2.948 according to ANSI C63.4 on October 19, 1992.

Measurement Procedure

The radiated and spurious measurements were made outdoors at a 3-meter test range (see Figure 2). The equipment under testing was placed on a wooden turntable, 3-meters from the receive antenna. The receive antenna height and turntable rotations was adjusted for the highest reading on the receive spectrum analyzer. A half-wave dipole was substituted in place of the EUT. This dipole antenna was driven by a signal generator and the level of the signal generator was adjusted to obtain the same receive spectrum analyzer reading. This level was recorded.

For readings above 1 GHz, the above procedure would be repeated using horn antennas and the difference between the gain of the horn and an isotropic antenna are taken into consideration.

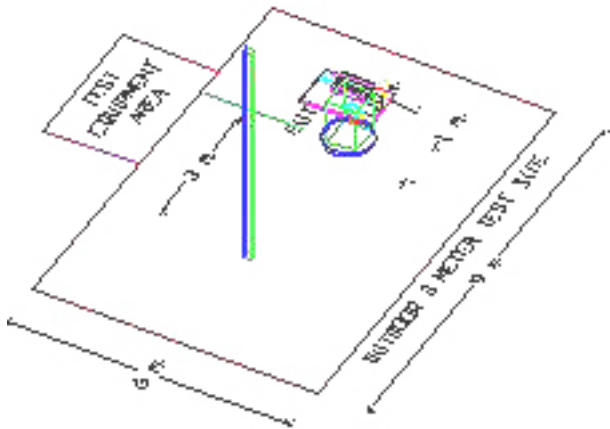

Figure 2. 3-meter Outdoor Test Site

3.1 INSERTS

Function of Active Devices

The Function of active devices is shown in Attachment K.

Block Diagram & Schematics (Confidential)

The Block Diagram(s) are shown in Attachment I, and the schematic diagrams are shown in Attachment J.

Operating Instructions

The instruction manual is shown in Attachment M.

Parts List & Tune-Up Procedure

The parts list & tune-up procedure is shown in Attachment L.

Description of Freq. Stabilization Circuit

The description of frequency stabilization circuit is shown in Attachment K.

Description for Suppression of Spurious Radiation, for Limiting Modulation, and Harmonic Suppression Circuits

The descriptions of suppression stabilization circuits are shown in Attachment K.

4.1 DESCRIPTION OF TESTS

4.2 Transmitter Audio Frequency Response

The frequency response of the audio modulating circuit over the frequency range 100 – 5000 Hz is measured. The audio signal generator is connected to the audio input circuit/microphone of the EUT. The audio signal input is adjusted to obtain 50% modulation at 1kHz and this point is taken as the 0dB reference. With the input held constant and below the limit at all frequencies, the audio signal generator is varied from 100 to 50 kHz.

4.3 Audio Low Pass Filter Frequency Response

The response in dB relative to 1kHz is measured using the HP8901 a Modulation Analyzer. For the frequency response of the audio low-pass filter, the audio input is connected at the input to the modulation limiter and the modulated stage. The audio output is connected at the output of the modulated stage. The corresponding plots are shown herein.

4.4 Modulation Limiting

The audio signal generator is connected to the audio input circuit/microphone of the EUT. The modulation response is measured for each of the three modulating frequencies (300Hz, 1000 Hz, and 3000Hz), and the input voltage is varied from 30% modulation (± 3.6 kHz deviation) to at least 20dB higher than the saturation point. Measurements of modulation and the plots are attached herein. Measurements were performed for ST, SAT, and wide-band data modulations. The corresponding results are shown herein.

Note: ST, SAT, & Wide-Band data were internally generated by the EUT.

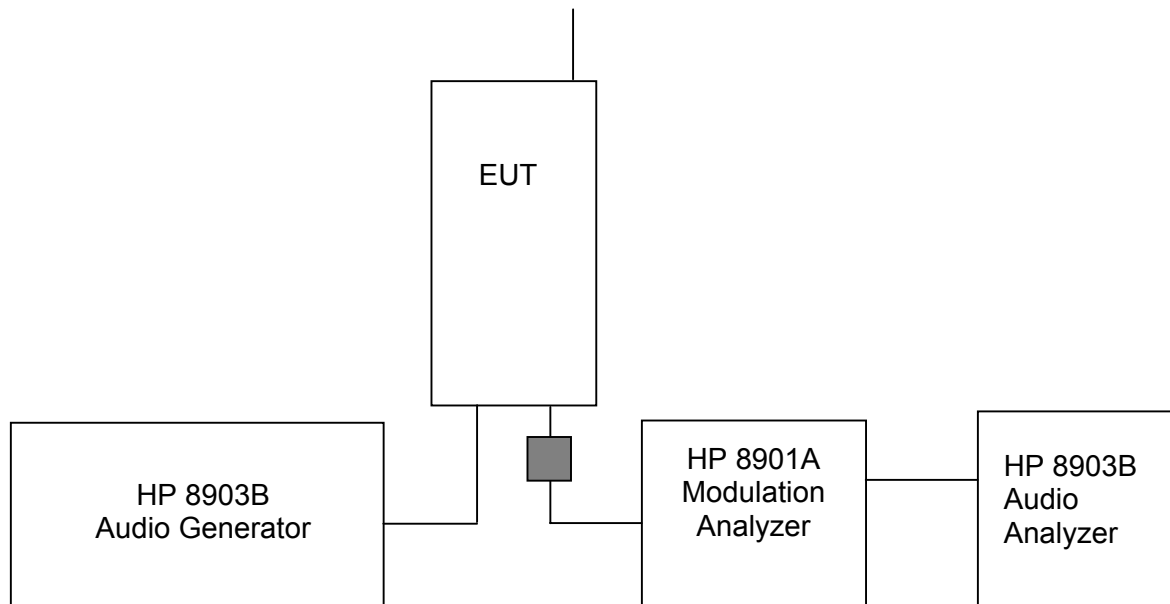

Fig. 3. Transmitter Audio Frequency & Tone Modulation Test Setup.

4.1 DESCRIPTION OF TESTS (CONTINUED)

4.4 Occupied Bandwidth Emission Limits

- (a) On any frequency outside a licensee's frequency block, the power of any emission shall be attenuated below the transmitter power (P) by at least $43 + 10 \log(P)$ dB.
- (b) Compliance with these provisions is based on the use of measurement instrumentation employing a resolution bandwidth of 1 MHz or greater. However, in the 1 MHz bands immediately outside and adjacent to the frequency block a resolution bandwidth of at least one percent of the emission bandwidth of the fundamental emission of the transmitter may be employed. The emission bandwidth is defined as the width of the signal between two points, one below the carrier center frequency and one above the carrier center frequency, outside of which all emission are attenuated at least 26 dB below the transmitter power.
- (c) When measuring the emission limits, the nominal carrier frequency shall be adjusted as close to the licensee's frequency block edges, both upper and lower, as the design permits.
- (d) The measurement of emission power can be expressed in peak or average values, provided they are expressed in the same parameters as the transmitter power.

BLOCK	Freq. Range (MHz) Transmitter (Tx)	Freq. Range (MHz) Receiver (Rx)
A	1850 - 1865	1930 - 1945
B	1870 - 1885	1950 - 1965
C	1895 - 1910	1975 - 1990
D	1865 - 1870	1945 - 1950
E	1885 - 1890	1965 - 1970
F	1890 - 1895	1970 - 1975

Table 1. Broadband PCS Service Frequency Blocks.

4.1 DESCRIPTION OF TESTS (CONTINUED)

4.4 Occupied Bandwidth

The audio signal generator is adjusted to 1kHz. The output level is set to ± 6 kHz deviation. With the level constant, the frequency is set to 2500Hz. Then the audio signal level is increased by 16dB. The occupied bandwidth data is obtained for the SAT (Supervisory Audio Tone), ST (Signaling Tone), WBD (Wideband data), and DTMF (Dual Tone Multi Frequencies). The results are shown on the attached graphs.

Specified Limits:

- a. On any frequency removed from the assigned carrier frequency by more than 20 kHz, up to and including 45kHz, the sideband is at least 26dB below the carrier.
- b. On any frequency removed from the assigned carrier frequency by more than 45 kHz, up to and including 90kHz, the sideband is at least 45dB below the carrier.
- c. On any frequency removed from the assigned carrier frequency by more than 90 kHz, up to the first multiple of the carrier frequency, the sideband is at least 60dB below the carrier or $40 + \log_{10}$ (mean power output in Watts) dB, whichever is the smaller attenuation.

4.5 Spurious and Harmonic Emissions at Antenna Terminal

The level of the carrier and the various conducted spurious and harmonic frequencies is measured by means of a calibrated spectrum analyzer. The spectrum is scanned from the lowest frequency generated in the equipment up to 10 GHz. The transmitter is modulated with a 2500Hz tone at a level of 16dB greater than that required to provide 50% modulation.

At the input terminals of the spectrum analyzer, an isolator (RF circulator with one port terminated with 50 ohms) and an 870 MHz to 890 MHz bandpass filter is connected between the test transceiver (for conducted tests) or the receive antenna (for radiated tests) and the analyzer. The rejection of the bandpass filter to signals in the 825 – 845 MHz range is adequate to limit the transmit energy from the test transceiver which appears to a level which will allow the analyzer to measure signals less than -90 dBm. Calibration of the test receiver is performed in the 870 – 890 MHz range to insure accuracy to allow variation in the passband filter insertion loss to be calibrated.

4.6 Frequencies

At the input terminals of the spectrum analyzer, an isolator (RF pad) and a high-pass filter are connected between the test transceiver (for conducted tests) or the receive antenna (for radiated tests) and the analyzer. The high-pass filter (signals below 2 GHz) is to limit the fundamental frequency from interfering with the measurement of low level spurious and harmonic emissions and to ensure that the preamplifier is not saturated.

4.7 Radiation Spurious and Harmonic Emissions

Radiation and harmonic emissions above 1 GHz is measured outdoors at our 3-meter test range. The equipment under test is placed on a wooden turntable 3-meters from the receive antenna. The receive antenna height and turntable rotations were adjusted for the highest reading on the receive spectrum analyzer. A half-wave dipole was substituted in place of the EUT. This dipole antenna was driven by a signal generator with the level of the signal generator being adjusted to obtain the same receive spectrum analyzer reading. This level is recorded. For readings above 1GHz, the above procedure is repeated using horn antennas and the difference between the gain of the horn and an isotropic antenna are taken into consideration.

4.8 Frequency Stability/Temperature Variation

The frequency stability of the transmitter is measured by:

- a.) **Temperature:** The temperature is varied from -30°C to +60°C using an environmental chamber.
- b.) **Primary Supply Voltage:** The primary supply voltage is varied from 85% to 115% of the voltage normally at the input to the device or at the power supply terminals if cables are not normally supplied.

Specification – The frequency stability shall be sufficient to ensure that the fundamental emission stays within the authorized frequency block. The frequency stability of the transmitter shall be maintained within ± 0.0001 (± 1 ppm) of the center frequency.

Time Period and Procedure:

1. The carrier frequency of the transmitter and the individual oscillators is measured at room temperature (25°C to 27°C to provide a reference).
2. The equipment is subjected to an overnight "soak" at -30°C without any power applied.
3. After the overnight "soak" at 30°C (usually 14-16 hours), the equipment is turned on in a "standby" condition for one minute before applying power to the transmitter. Measurement of the carrier frequency of the transmitter and the individual oscillators is made within a three minute interval after applying power to the transmitter.
4. Frequency measurements are made at 10°C interval up to room temperature. At least a period of one and one half-hour is provided to allow stabilization of the equipment at each temperature level.
5. Again the transmitter carrier frequency and the individual oscillators is measured at room temperature to begin measurement of the upper temperature levels.
6. Frequency were made at 10 intervals starting at 30°C up to +50°C allowing at least two hours at each temperature for stabilization. In all measurements the frequency is measured within three minutes after applying power to the transmitter.
7. The artificial load is mounted external to the temperature chamber.

NOTE: The EUT is tested down to the battery endpoint.

5.1 Test Data

5.2 Effective Radiated Power Output

A. POWER: Low (Analog Mode)

Freq. Tuned (MHz)	LEVEL (dBm)	POL (H /V)	ERP (W)	ERP (dBm)
824.04	-35.400	V	0.004	5.873
836.49	-36.400	V	0.003	5.029
848.97	-36.700	V	0.003	4.885

B. POWER: High (Analog Mode)

Freq. Tuned (MHz)	LEVEL (dBm)	POL (H /V)	ERP (W)	ERP (dBm)	BATTERY
824.04	-15.400	V	0.38666	25.873	Standard
836.49	-16.400	V	0.31834	25.029	Standard
848.97	-16.700	V	0.30796	24.885	Standard

Note: Standard and Extended batteries are both battery options for this phone

NOTES:

Effective Radiated Power Output Measurements by Substitution Method
 according to ANSI/TIA/EIA-603 (rev.1998):

The EUT was placed on a wooden turn table 3-meters from the receive antenna. The receive antenna height and turntable rotation was adjusted for the highest reading on the receive spectrum analyzer. A half-wave dipole was substituted in place of the EUT. This dipole antenna was driven by a signal generator and the level of the signal generator was adjusted to obtain the same receive spectrum analyzer reading. The conducted power at the terminals of the dipole is measured. The ERP is recorded.

6.1 Test Data

6.2 Equivalent Isotropic Radiated Power (E.I.R.P.)

Radiated measurements at 3 meters

Supply Voltage: 3.6 VDC

Modulation: PCS CDMA

FREQ . (MHz)	LEVEL (dBm)	POL (H/V)	Azimuth (o angle)	EIRP (dBm)	EIRP (W)	Battery
1851.25	-20.000	H	60	23.081	0.204	Standard
1880.00	-20.000	H	60	23.251	0.212	Standard
1908.75	-20.600	H	60	22.821	0.192	Standard

Note: Standard and Extended batteries are both battery options for this phone

NOTES:

Equivalent Isotropic Radiated Power Measurements by Substitution Method according to ANSI/TIA/EIA-603 (rev.1998):

The EUT was placed on a wooden turn table 3-meters from the receive antenna. The receive antenna height and turntable rotation was adjusted for the highest reading on the receive spectrum analyzer. A Horn antenna was substituted in place of the EUT. This Horn antenna was driven by a signal generator and the level of the signal generator was adjusted to obtain the same receive spectrum analyzer reading. The conducted power at the terminals of the Horn antenna is measured. The difference between the gain of the horn and an isotropic antenna is taken into consideration and the EIRP is recorded.

7.1 Test Data (Continued)

7.5 PCS CDMA Radiated Measurements

Field Strength of SPURIOUS Radiation

OPERATING FREQUENCY: 1851.25 MHz
 CHANNEL: 0025 (Low)
 MEASURED OUTPUT POWER: 23.251 dBm = 0.211 W
 MODULATION SIGNAL: CDMA (Internal)
 DISTANCE: 3 meters
 LIMIT: $43 + 10 \log_{10}(W) =$ 36.25 dBc

FREQ . (MHz)	LEVEL (dBm)	POL (H /V)	(dBc)
3702.50	-92.50	V	59.6
5553.75	-98.50	V	60.3
7405.00	-115.50	V	73.3
9256.25	-126.00	V	80.3
11107.50	< -130		

NOTES:

Radiated Spurious Emission Measurements by Substitution Method
according to ANSI/TIA/EIA-603 (rev.1998):

The EUT was placed on a wooden turn table 3-meters from the receive antenna. The receive antenna height and turntable rotation was adjusted for the highest reading on the receive spectrum analyzer. A half-wave dipole was substituted in place of the EUT. This dipole antenna was driven by a signal generator and the level of the signal generator was adjusted to obtain the same receive spectrum analyzer reading. This spurious level is recorded. For readings above 1GHz, the above procedure is repeated using horn antennas and the difference between the gain of the horn and an isotropic or dipole antenna are taken into consideration.

7.1 Test Data (Continued)

7.6 PCS CDMA Radiated Measurements

Field Strength of SPURIOUS Radiation

OPERATING FREQUENCY: 1880.00 MHz
 CHANNEL: 0600 (Mid)
 MEASURED OUTPUT POWER: 23.251 dBm = 0.211 W
 MODULATION SIGNAL: CDMA (Internal)
 DISTANCE: 3 meters
 LIMIT: $43 + 10 \log_{10}(W) =$ 36.25 dBc

FREQ . (MHz)	LEVEL (dBm)	POL (H /V)	(dBc)
3760.00	-92.00	V	58.8
5640.00	-98.00	V	59.6
7520.00	-114.30	V	71.8
9400.00	-125.00	V	79.1
11280.00	< -130		

NOTES:

Radiated Spurious Emission Measurements by Substitution Method
according to ANSI/TIA/EIA-603 (rev.1998):

The EUT was placed on a wooden turn table 3-meters from the receive antenna. The receive antenna height and turntable rotation was adjusted for the highest reading on the receive spectrum analyzer. A half-wave dipole was substituted in place of the EUT. This dipole antenna was driven by a signal generator and the level of the signal generator was adjusted to obtain the same receive spectrum analyzer reading. This spurious level is recorded. For readings above 1GHz, the above procedure is repeated using horn antennas and the difference between the gain of the horn and an isotropic or dipole antenna are taken into consideration.

7.1 Test Data (Continued)

7.7 PCS CDMA Radiated Measurements

Field Strength of SPURIOUS Radiation

OPERATING FREQUENCY: 1908.75 MHz
 CHANNEL: 1175 (High)
 MEASURED OUTPUT POWER: 23.251 dBm = 0.211 W
 MODULATION SIGNAL: CDMA (Internal)
 DISTANCE: 3 meters
 LIMIT: $43 + 10 \log_{10}(W) =$ 36.25 dBc

FREQ . (MHz)	LEVEL (dBm)	POL (H /V)	(dBc)
3817.50	-93.50	V	60.0
5726.25	-99.30	V	60.7
7635.00	-115.00	V	72.3
9543.75	-127.40	V	81.2
11452.50	< -130		

NOTES:

Radiated Spurious Emission Measurements by Substitution Method
according to ANSI/TIA/EIA-603 (rev.1998):

The EUT was placed on a wooden turn table 3-meters from the receive antenna. The receive antenna height and turntable rotation was adjusted for the highest reading on the receive spectrum analyzer. A half-wave dipole was substituted in place of the EUT. This dipole antenna was driven by a signal generator and the level of the signal generator was adjusted to obtain the same receive spectrum analyzer reading. This spurious level is recorded. For readings above 1GHz, the above procedure is repeated using horn antennas and the difference between the gain of the horn and an isotropic or dipole antenna are taken into consideration.

7.1 Test Data (Continued)

7.5 PCS CDMA Radiated Measurements

Field Strength of SPURIOUS Radiation

OPERATING FREQUENCY: 1851.25 MHz
 CHANNEL: 0025 (Low)
 MEASURED OUTPUT POWER: 23.251 dBm = 0.211 W
 MODULATION SIGNAL: CDMA (Internal)
 DISTANCE: 3 meters
 LIMIT: $43 + 10 \log_{10}(W) =$ 36.25 dBc

FREQ . (MHz)	LEVEL (dBm)	POL (H/V)	(dBc)
3702.50	-92.50	V	59.6
5553.75	-98.50	V	60.3
7405.00	-115.50	V	73.3
9256.25	< -130		
11107.50	< -130		

NOTES:

Radiated Spurious Emission Measurements by Substitution Method
according to ANSI/TIA/EIA-603 (rev.1998):

The EUT was placed on a wooden turn table 3-meters from the receive antenna. The receive antenna height and turntable rotation was adjusted for the highest reading on the receive spectrum analyzer. A half-wave dipole was substituted in place of the EUT. This dipole antenna was driven by a signal generator and the level of the signal generator was adjusted to obtain the same receive spectrum analyzer reading. This spurious level is recorded. For readings above 1GHz, the above procedure is repeated using horn antennas and the difference between the gain of the horn and an isotropic or dipole antenna are taken into consideration.

7.1 Test Data (Continued)

7.6 PCS CDMA Radiated Measurements

Field Strength of SPURIOUS Radiation

OPERATING FREQUENCY: 1880.00 MHz
CHANNEL: 0600 (Mid)
MEASURED OUTPUT POWER: 23.251 dBm = 0.211 W
MODULATION SIGNAL: CDMA (Internal)
DISTANCE: 3 meters
LIMIT: $43 + 10 \log_{10}(W) =$ 36.25 dBc

FREQ . (MHz)	LEVEL (dBm)	POL (H/V)	(dBc)
3760.00	-92.00	V	58.8
5640.00	-98.00	V	59.6
7520.00	-114.30	V	71.8
9400.00	< -130		
11280.00	< -130		

NOTES:

Radiated Spurious Emission Measurements by Substitution Method
according to ANSI/TIA/EIA-603 (rev.1998):

The EUT was placed on a wooden turn table 3-meters from the receive antenna. The receive antenna height and turntable rotation was adjusted for the highest reading on the receive spectrum analyzer. A half-wave dipole was substituted in place of the EUT. This dipole antenna was driven by a signal generator and the level of the signal generator was adjusted to obtain the same receive spectrum analyzer reading. This spurious level is recorded. For readings above 1GHz, the above procedure is repeated using horn antennas and the difference between the gain of the horn and an isotropic or dipole antenna are taken into consideration.

7.1 Test Data (Continued)

7.7 PCS CDMA Radiated Measurements

Field Strength of SPURIOUS Radiation

OPERATING FREQUENCY: 1908.75 MHz
 CHANNEL: 1175 (High)
 MEASURED OUTPUT POWER: 23.251 dBm = 0.211 W
 MODULATION SIGNAL: CDMA (Internal)
 DISTANCE: 3 meters
 LIMIT: $43 + 10 \log_{10}(W) =$ 36.25 dBc

FREQ . (MHz)	LEVEL (dBm)	POL (H/V)	(dBc)
3817.50	-93.50	V	60.0
5726.25	-99.30	V	60.7
7635.00	-115.00	V	72.3
9543.75	< -130		
11452.50	< -130		

NOTES:

Radiated Spurious Emission Measurements by Substitution Method
according to ANSI/TIA/EIA-603 (rev.1998):

The EUT was placed on a wooden turn table 3-meters from the receive antenna. The receive antenna height and turntable rotation was adjusted for the highest reading on the receive spectrum analyzer. A half-wave dipole was substituted in place of the EUT. This dipole antenna was driven by a signal generator and the level of the signal generator was adjusted to obtain the same receive spectrum analyzer reading. This spurious level is recorded. For readings above 1GHz, the above procedure is repeated using horn antennas and the difference between the gain of the horn and an isotropic or dipole antenna are taken into consideration.

8.1 Test Data

8.2 FREQUENCY STABILITY (AMPS)

OPERATING FREQUENCY: 836,490,008 Hz
 CHANNEL: 0363
 REFERENCE VOLTAGE: 3.7 VDC
 DEVIATION LIMIT: ± 0.00025 % or 2.5 ppm

VOLTAGE (%)	POWER (VDC)	TEMP (°C)	FREQ. (Hz)	Deviation (%)
100 %	3.70	+ 20 (Ref)	836,490,008	0.000000
100 %		- 30	836,489,857	0.000018
100 %		- 20	836,489,891	0.000014
100 %		- 10	836,489,924	0.000010
100 %		0	836,489,983	0.000003
100 %		+ 10	836,489,958	0.000006
100 %		+ 20	836,490,008	0.000000
100 %		+ 25	836,489,949	0.000007
100 %		+ 30	836,490,025	-0.000002
100 %		+ 40	836,490,083	-0.000009
100 %		+ 50	836,490,092	-0.000010
100 %		+ 60	836,490,108	-0.000012
85 %		3.15	+ 20	836,490,008
115 %	4.26	+ 20	836,490,008	0.000000
BATT. ENDPOINT	2.93	+ 20	836,490,008	0.000000

8.1 Test Data (Continued)

8.3 FREQUENCY STABILITY (AMPS)

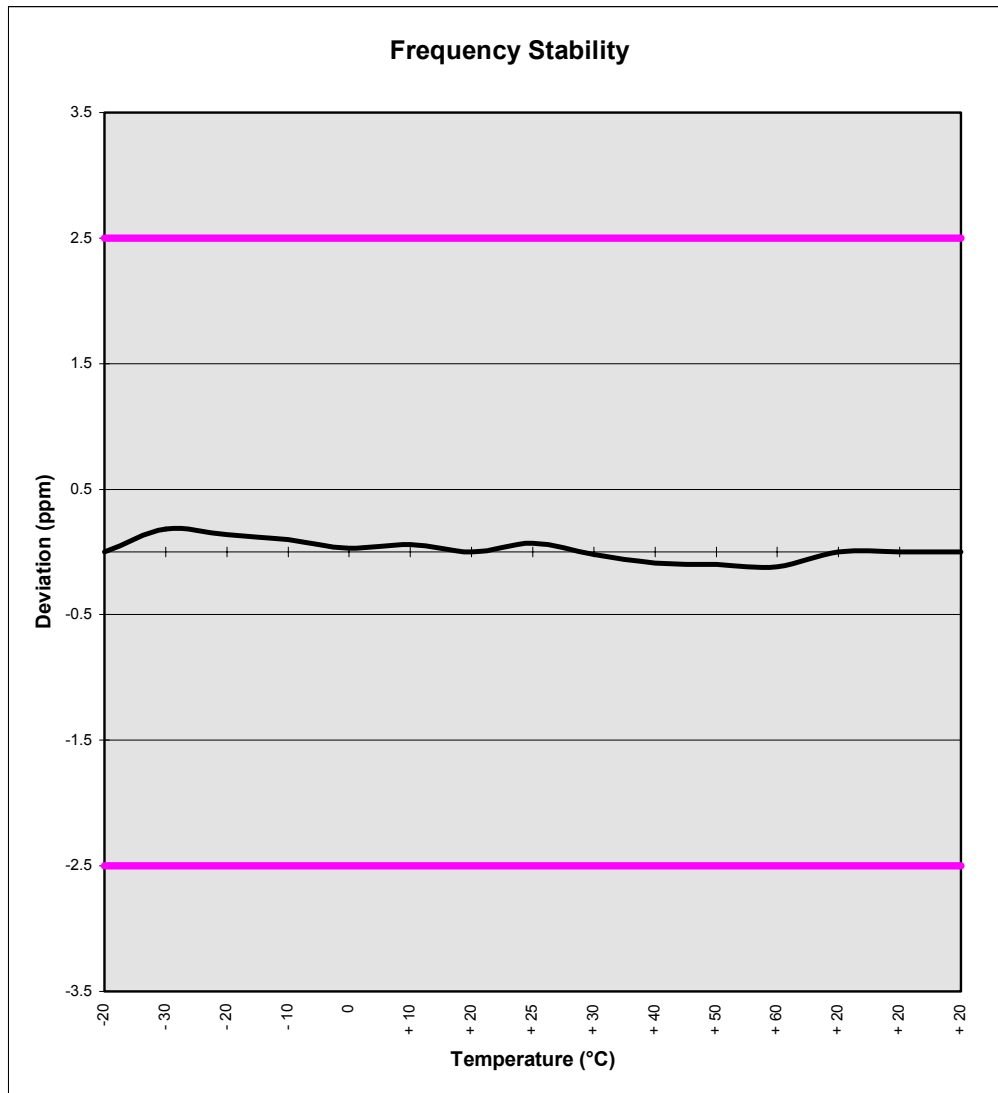

8.1 Test Data (Continued)

8.4 FREQUENCY STABILITY (PCS CDMA)

OPERATING FREQUENCY: 1,880,000,006 Hz
 CHANNEL: 0600
 REFERENCE VOLTAGE: 3.7 VDC
 DEVIATION LIMIT: ± 0.00025 % or 2.5 ppm

VOLTAGE (%)	POWER (VDC)	TEMP (°C)	FREQ. (Hz)	Deviation (%)
100 %	3.60	+ 20 (Ref)	1,880,000,006	0.000000
100 %		- 30	1,879,999,799	0.000011
100 %		- 20	1,879,999,837	0.000009
100 %		- 10	1,879,999,912	0.000005
100 %		0	1,879,999,856	0.000008
100 %		+ 10	1,879,999,968	0.000002
100 %		+ 20	1,880,000,006	0.000000
100 %		+ 25	1,879,999,874	0.000007
100 %		+ 30	1,879,999,837	0.000009
100 %		+ 40	1,880,000,232	-0.000012
100 %		+ 50	1,880,000,213	-0.000011
100 %		+ 60	1,880,000,194	-0.000010
85 %		3.06	+ 20	1,880,000,006
115 %	4.14	+ 20	1,880,000,006	0.000000
BATT. ENDPOINT	2.93	+ 20	1,880,000,006	0.000000

8.1 Test Data (Continued)

8.5 FREQUENCY STABILITY (PCS CDMA)

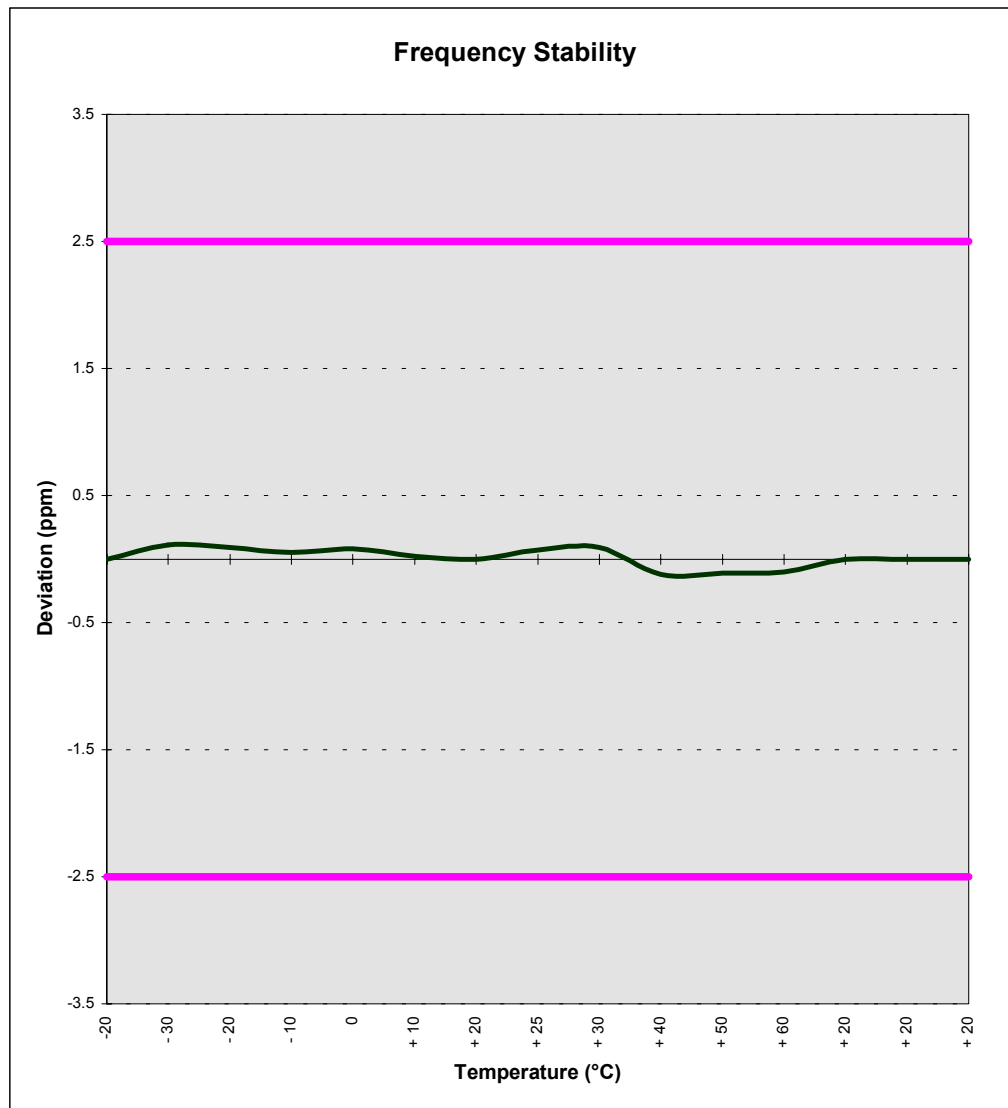

9.1 PLOT(S) OF EMISSIONS

(SEE ATTACHMENT D)

10.1 TEST EQUIPMENT

10.2 Type	Model	Cal. Due Date	S/N
Microwave Spectrum Analyzer	HP 8566B (100Hz-22GHz)	08/15/02	3638A08713
Microwave Spectrum Analyzer	HP 8566B (100Hz-22GHz)	04/17/02	2542A11898
Spectrum Analyzer/Tracking Gen.	HP 8591A (100Hz-1.8GHz)	08/10/02	3144A02458
Signal Generator*	HP 8640B (500Hz-1GHz)	06/03/02	2232A19558
Signal Generator*	HP 8640B (500Hz-1GHz)	06/03/02	1851A09816
Signal Generator*	Rohde & Schwarz (0.1-1000MHz)	09/11/02	894215/012
Ailtech/Eaton Receiver	NM 37/57A-SL (30-1000MHz)	04/12/02	0792-03271
Ailtech/Eaton Receiver	NM 37/57A (30-1000MHz)	03/11/02	0805-03334
Ailtech/Eaton Receiver	NM 17/27A (0.1-32MHz)	09/17/02	0608-03241
Quasi-Peak Adapter	HP 85650A	08/15/02	2043A00301
Ailtech/Eaton Adapter	CCA-7 CISPR/ANSI QP Adapter	03/11/02	0194-04082
Gigatronics Universal Power Meter	8657A		1835256
Gigatronics Power Sensor	80701A (0.05-18GHz)		1833460
Signal Generator	HP 8648D (9kHz-4GHz)		3613A00315
Amplifier Research	5S1G4 (5W, 800MHz-4.2GHz)		22322
Network Analyzer	HP 8753E (30kHz-3GHz)		JP38020182
Audio Analyzer	HP 8903B		3011A09025
Modulation Analyzer	HP 8901A		2432A03467
Power Meter	HP 437B		3125U24437
Power Sensor	HP 8482H (30 μ W-3W)		2237A02084
Harmonic/Flicker Test System	HP 6841A (IEC 555-2/3)		3531A00115
Broadband Amplifier (2)	HP 8447D		1145A00470, 1937A03348
Broadband Amplifier	HP 8447F		2443A03784
Horn Antenna	EMCO Model 3115 (1-18GHz)		9704-5182
Horn Antenna	EMCO Model 3115 (1-18GHz)		9205-3874
Horn Antenna	EMCO Model 3116 (18-40GHz)		9203-2178
Biconical Antenna (4)	Eaton 94455/Eaton 94455-1/Singer 94455-1/Compliance Design		1295, 1332, 0355
Log-Spiral Antenna (3)	Ailtech/Eaton 93490-1		0608, 1103, 1104
Roberts Dipoles	Compliance Design (1 set)		
Ailtech Dipoles	DM-105A (1 set)		33448-111
EMCO LISN (6)	3816/2		1079
Microwave Preamplifier 40dB Gain	HP 83017A (0.5-26.5GHz)		3123A00181
Microwave Cables	MicroCoax (1.0-26.5GHz)		
Ailtech/Eaton Receiver	NM37/57A-SL		0792-03271
Spectrum Analyzer	HP 8594A		3051A00187
Spectrum Analyzer (2)	HP 8591A		3034A01395, 3108A02053
Microwave Survey Meter	Holaday Model 1501 (2.450GHz)		80931
Digital Thermometer	Extech Instruments 421305		426966
Attenuator	HP 8495A (0-70dB) DC-4GHz		
Bi-Directional Coax Coupler	Narda 3020A (50-1000MHz)		
Shielded Screen Room	RF Lindgren Model 26-2/2-0		6710 (PCT270)
Shielded Semi-Anechoic Chamber	Ray Proof Model S81		R2437 (PCT278)
Environmental Chamber	Associated Systems Model 1025 (Temperature/Humidity)		PCT285

* Calibration traceable to the National Institute of Standards and Technology (NIST).

11.1 SAMPLE CALCULATIONS

A. Emission Designator

CDMA Sample

2M + 2DK

CDMA BW = 1.25 MHz

F = Frequency Modulation

9 = Composite Digital Info

W = Combination (Audio/Data)

Emission Designator = 1M25F9W

12.1 CONCLUSION

The data collected shows that the **SANYO Dual-Band Analog/PCS (AMPS/CDMA) Phone FCC ID: AEZSCP-6200** complies with all the requirements of Parts 2, 22, and 24 of the FCC rules.