

CERTIFICATE OF COMPLIANCE (SAR EVALUATION)

APPLICANT NAME & ADDRESS:
SANYO ELECTRIC Co., Ltd.
 c/o Sanyo Sales & Supply (USA) Corp.
 900 North Arlington Heights Road, Suite 300
 Itasca, IL 60143-2844

DATE & LOCATION OF TESTING:
 Dates of Tests: June 27-29, 2005
 Test Report S/N: 0506270475
 Test Site: PCTEST Lab, Columbia MD

FCC ID:	AEZSCP-4930
APPLICANT:	SANYO ELECTRIC CO., LTD.

EUT Type: Tri-Mode Dual-Band Analog/PCS Phone (AMPS/CDMA)
Tx Frequency: 824.04 – 848.97 MHz (AMPS) / 824.70 – 848.31 MHz (CDMA)
 1851.25 – 1908.75 MHz (PCS CDMA)
Rx Frequency: 869.04 – 893.97 MHz (AMPS) / 869.70 – 893.31 MHz (CDMA)
 1931.25 – 1988.75 MHz (PCS CDMA)
Max. RF Output Power: 0.400 W ERP AMPS (26.023 dBm) / 24.5 dBm Conducted
 0.318 W ERP CDMA (25.023 dBm) / 23.5 dBm Conducted
 0.661 W EIRP PCS CDMA (28.201 dBm) / 23.5 dBm Conducted
Max. SAR Measurement: 1.01 W/kg AMPS Head SAR; 0.516 W/kg AMPS Body SAR;
 0.753 W/kg CDMA Head SAR; 0.364 W/kg CDMA Body SAR;
 0.374 W/kg PCS CDMA Head SAR; 1.150 W/kg PCS CDMA Body SAR;
 0.061 W/kg PTT Flip Open
Trade Name/Model(s): RL-4930
FCC Classification: Licensed Portable Transmitter Held to Ear (PCE)
FCC Rule Part(s): §2.1093; FCC/OET Bulletin 65 Supplement C [July 2001]
Application Type: Certification
Test Device Serial No.: *identical* prototype [S/N: F798E65C]

This wireless portable device has been shown to be capable of compliance for localized specific absorption rate (SAR) for uncontrolled environment/general population exposure limits specified in ANSI/IEEE Std. C95.1-1992 and had been tested in accordance with the measurement procedures specified in FCC/OET Bulletin 65 Supplement C (2001) and IEEE Std. P1528 D1.2 (April 2003). I attest to the accuracy of data. All measurements reported herein were performed by me or were made under my supervision and are correct to the best of my knowledge and belief. I assume full responsibility for the completeness of these measurements and vouch for the qualifications of all persons taking them.



Grant Conditions: Power output listed is ERP for Part 22 and EIRP for Part 24. SAR compliance for body-worn operating configuration is based on a separation distance of 1.9 cm between the back of the unit and the body of the user. End-users must be informed of the body-worn operating requirements for satisfying RF exposure compliance. Belt clips or holsters may not contain metallic components.

PCTEST certifies that no party to this application has been denied the FCC benefits pursuant to Section 5301 of the Anti-Drug Abuse Act of 1988, 21 U.S.C. 862.

 Alfred Cirwithian
 Vice President Engineering







PCTEST SAR REPORT		FCC CERTIFICATION		Reviewed by: Quality Manager
SAR Filename: 0506270475	Test Dates: June 27-29, 2005	Phone Type: Tri-Mode Dual-Band Phone	FCC ID: AEZSCP-4930	Page 1 of 36

TABLE OF CONTENTS

1.	INTRODUCTION / SAR DEFINITION.....	3
2.	SAR MEASUREMENT SETUP	4
3.	DASY4 E-FIELD PROBE SYSTEM.....	5
4.	Probe Calibration Process.....	6
5.	PHANTOM & EQUIVALENT TISSUES	7
6.	TEST SYSTEM SPECIFICATIONS.....	8
7.	DOSIMETRIC ASSESSMENT & PHANTOM SPECS	9
8.	DEFINITION OF REFERENCE POINTS	10
9.	TEST CONFIGURATION POSITIONS	11
10.	ANSI/IEEE C95.1 - 1992 RF EXPOSURE LIMITS.....	14
11.	MEASUREMENT UNCERTAINTIES.....	15
12.	SYSTEM VERIFICATION.....	16
13.	SAR TEST DATA SUMMARY	17-33
15.	SAR TEST EQUIPMENT.....	34
16.	CONCLUSION.....	35
17.	REFERENCES.....	36

PCTEST SAR REPORT		FCC CERTIFICATION		Reviewed by: Quality Manager
SAR Filename: 0506270475	Test Dates: June 27-29, 2005	Phone Type: Tri-Mode Dual-Band Phone	FCC ID: AEZSCP-4930	Page 2 of 36

1. INTRODUCTION / SAR DEFINITION

The FCC has adopted the guidelines for evaluating the environmental effects of radiofrequency radiation in ET Docket 93-62 on Aug. 6, 1996 to protect the public and workers from the potential hazards of RF emissions due to FCC-regulated portable devices.[1]

The safety limits used for the environmental evaluation measurements are based on the criteria published by the American National Standards Institute (ANSI) for localized specific absorption rate (SAR) in *IEEE/ANSI C95.1-1992 Standard for Safety Levels with Respect to Human Exposure to Radio Frequency Electromagnetic Fields, 3 kHz to 300 GHz*. (c) 1992 by the Institute of Electrical and Electronics Engineers, Inc., New York, New York 10017.[2] The measurement procedure described in *IEEE/ANSI C95.3-1992 Recommended Practice for the Measurement of Potentially Hazardous Electromagnetic Fields - RF and Microwave*[3] is used for guidance in measuring SAR due to the RF radiation exposure from the Equipment Under Test (EUT). These criteria for SAR evaluation are similar to those recommended by the National Council on Radiation Protection and Measurements (NCRP) in *Biological Effects and Exposure Criteria for Radiofrequency Electromagnetic Fields*, NCRP Report No. 86 (c) NCRP, 1986, Bethesda, MD 20814.[6] SAR is a measure of the rate of energy absorption due to exposure to an RF transmitting source. SAR values have been related to threshold levels for potential biological hazards.

SAR Definition

Specific Absorption Rate (SAR) is defined as the time derivative (rate) of the incremental energy (dU) absorbed by (dissipated in) an incremental mass (dm) contained in a volume element (dV) of a given density (r). It is also defined as the rate of RF energy absorption per unit mass at a point in an absorbing body (see Fig. 1.1).

$$SAR = \frac{d}{dt} \left(\frac{dU}{dm} \right) = \frac{d}{dt} \left(\frac{dU}{r dV} \right)$$

Figure 1.1
SAR Mathematical Equation



SAR is expressed in units of Watts per Kilogram (W/kg).

$$SAR = s E^2 / r$$

where:

- S = conductivity of the tissue-simulant material (S/m)
- r = mass density of the tissue-simulant material (kg/m³)
- E = Total RMS electric field strength (V/m)

NOTE: The primary factors that control rate of energy absorption were found to be the wavelength of the incident field in relations to the dimensions and geometry of the irradiated organism, the orientation of the organism in relation to the polarity of field vectors, the presence of reflecting surfaces, and whether conductive contact is made by the organism with a ground plane.[6]

PCTEST SAR REPORT		FCC CERTIFICATION		Reviewed by: Quality Manager
SAR Filename: 0506270475	Test Dates: June 27-29, 2005	Phone Type: Tri-Mode Dual-Band Phone	FCC ID: AEZSCP-4930	Page 3 of 36

2. SAR MEASUREMENT SETUP

Robotic System

Measurements are performed using the DASY4 automated dosimetric assessment system. The DASY4 is made by Schmid & Partner Engineering AG (SPEAG) in Zurich, Switzerland and consists of high precision robotics system (Staubli), robot controller, Pentium III computer, near-field probe, probe alignment sensor, and the generic twin phantom containing the brain equivalent material. The robot is a six-axis industrial robot performing precise movements to position the probe to the location (points) of maximum electromagnetic field (EMF) (see Fig. 2.1).

System Hardware

A cell controller system contains the power supply, robot controller, teach pendant (joystick), and a remote control used to drive the robot motors. The PC consists of the Gateway Pentium 4 2.53 GHz computer with Windows XP system and SAR Measurement Software DASY4, A/D interface card, monitor, mouse, and keyboard. The Staubli Robot is connected to the cell controller to allow software manipulation of the robot. A data acquisition electronic (DAE) circuit that performs the signal amplification, signal multiplexing, AD-conversion, offset measurements, mechanical surface detection, collision detection, etc. is connected to the Electro-optical coupler (EOC). The EOC performs the conversion from the optical into digital electric signal of the DAE and transfers data to the PC plug-in card.

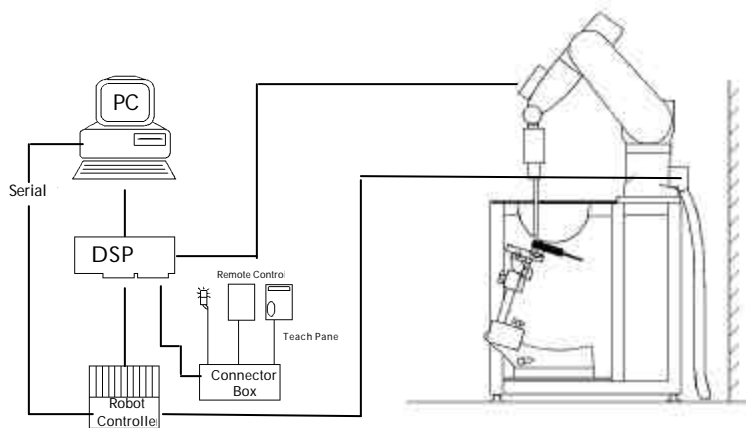



Figure 2.1 SAR Measurement System Setup

System Electronics

The DAE4 consists of a highly sensitive electrometer-grade preamplifier with auto-zeroing, a channel and gain-switching multiplexer, a fast 16 bit AD-converter and a command decoder and control logic unit. Transmission to the PC-card is accomplished through an optical downlink for data and status information and an optical uplink for commands and clock lines. The mechanical probe mounting device includes two different sensor systems for frontal and sidewise probe contacts. They are also used for mechanical surface detection and probe collision detection. The robot uses its own controller with a built in VME-bus computer. The system is described in detail in [7].

PCTEST SAR REPORT		FCC CERTIFICATION		Reviewed by: Quality Manager
SAR Filename: 0506270475	Test Dates: June 27-29, 2005	Phone Type: Tri-Mode Dual-Band Phone	FCC ID: AEZSCP-4930	Page 4 of 36

3. DASY4 E-FIELD PROBE SYSTEM

Probe Measurement System



Figure 3.1 DAE System

The SAR measurements were conducted with the dosimetric probe ET3DV6, designed in the classical triangular configuration [7] (see Fig. 3.2) and optimized for dosimetric evaluation. The probe is constructed using the thick film technique; with printed resistive lines on ceramic substrates. The probe is equipped with an optical multifiber line ending at the front of the probe tip (see Fig. 3.3). It is connected to the EOC box on the robot arm and provides an automatic detection of the phantom surface. Half of the fibers are connected to a pulsed infrared transmitter, the other half to a synchronized receiver. As the probe approaches the surface, the reflection from the surface produces a coupling from the transmitting to the receiving fibers. This reflection increases first during the approach, reaches maximum and then decreases. If the probe is flatly touching the surface, the coupling is zero. The distance of the coupling maximum to the surface is independent of the surface reflectivity and largely independent of the surface to probe angle. The DASY4 software reads the reflection during a software approach and looks for the maximum using a 2nd order fitting (see Fig.3.1). The approach is stopped at reaching the maximum.

Probe Specifications

- Calibration: In air from 10 MHz to 6 GHz
In brain and muscle simulating tissue at
Frequencies of 150 MHz, 450 MHz, 835 MHz,
900 MHz, 1900MHz, 2450MHz, 5300MHz,
& 5800MHz
- Frequency: 10 MHz to > 6 GHz; Linearity: ± 0.2 dB
(30 MHz to 6 GHz)
- Directivity: ± 0.2 dB in HSL (rotation around probe axis)
± 0.4 dB in HSL (rotation normal probe axis)
- Dynamic: 5 :W/g to > 100 mW/g;
- Range: Linearity: ± 0.2 dB
- Dimensions: Overall length: 330 mm
Tip length: 16 mm
Body diameter: 12 mm
Tip diameter: 3 mm
Distance from probe tip to dipole centers: 2 mm
- Application: General dosimetry up to 6 GHz
Compliance tests of mobile phones
Fast automatic scanning in arbitrary phantoms

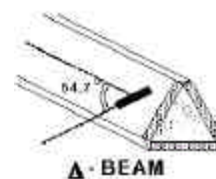



Figure 3.1 Triangular Probe Configuration



Figure 3.2 Probe Thick-Film Technique

PCTEST SAR REPORT	 		Reviewed by: Quality Manager
SAR Filename: 0506270475	Test Dates: June 27-29, 2005	Phone Type: Tri-Mode Dual-Band Phone	FCC ID: AEZSCP-4930

4. Probe Calibration Process

Dosimetric Assessment Procedure

Each probe is calibrated according to a dosimetric assessment procedure described in [8] with accuracy better than +/- 10%. The spherical isotropy was evaluated with the procedure described in [9] and found to be better than +/-0.25dB. The sensitivity parameters (NormX, NormY, NormZ), the diode compression parameter (DCP) and the conversion factor (ConvF) of the probe is tested.

Free Space Assessment

The free space Efield from amplified probe outputs is determined in a test chamber. This is performed in a TEM cell for frequencies below 1 GHz (see Fig. 4.1), and in a waveguide above 1 GHz for free space. For the free space calibration, the probe is placed in the volumetric center of the cavity at the proper orientation with the field. The probe is then rotated 360 degrees.

Temperature Assessment *

E-field temperature correlation calibration is performed in a flat phantom filled with the appropriate simulated brain tissue. The measured free space E-field in the medium correlates to temperature rise in a dielectric medium. For temperature correlation calibration a RF transparent thermistor-based temperature probe is used in conjunction with the E-field probe (see Fig. 4.2).

$$SAR = C \frac{\Delta T}{\Delta t}$$

where:

Δt = exposure time (30 seconds),

C = heat capacity of tissue (brain or muscle),

ΔT = temperature increase due to RF exposure.

SAR is proportional to $\Delta T / \Delta t$, the initial rate of tissue heating, before thermal diffusion takes place. Now it's possible to quantify the electric field in the simulated tissue by equating the thermally derived SAR to the E - field;

$$SAR = \frac{|E|^2 \cdot \sigma}{r}$$

where:

σ = simulated tissue conductivity,

ρ = Tissue density (1.25 g/cm³ for brain tissue)

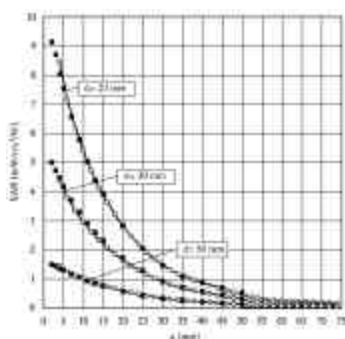

Figure 4.1 E-Field and Temperature measurements at 900MHz [7]

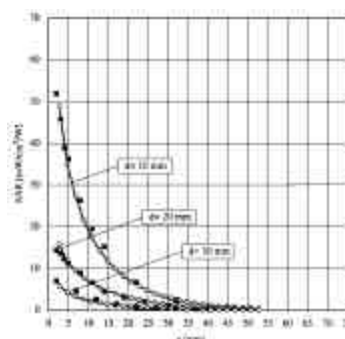



Figure 4.2 E-Field and temperature measurements at 1.9GHz [7]

*NOTE: The temperature calibration was not performed by PCTEST. For information use only.

PCTEST SAR REPORT		FCC CERTIFICATION		Reviewed by: Quality Manager
SAR Filename: 0506270475	Test Dates: June 27-29, 2005	Phone Type: Tri-Mode Dual-Band Phone	FCC ID: AEZSCP-4930	Page 6 of 36

5. PHANTOM & EQUIVALENT TISSUES

SAM Phantom

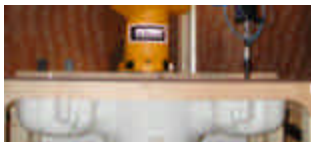

Figure 5.1 SAM Twin Phantom

The SAM Twin Phantom V4.0 is constructed of a fiberglass shell integrated in a wooden table. The shape of the shell is based on data from an anatomical study designed to determine the maximum exposure in at least 90% of all users [11][12]. It enables the dosimetric evaluation of left and right hand phone usage as well as body mounted usage at the flat phantom region. A cover prevents the evaporation of the liquid. Reference markings on the Phantom allow the complete setup of all predefined phantom positions and measurement grids by manually teaching three points in the robot. (see Fig. 5.1)

Brain & Muscle Simulating Mixture Characterization



Figure 5.2 Simulated Tissue

The brain and muscle mixtures consist of a viscous gel using hydroxyethylcellulose (HEC) gelling agent and saline solution (see Table 6.1). Preservation with a bacteriacide is added and visual inspection is made to make sure air bubbles are not trapped during the mixing process. The mixture is calibrated to obtain proper dielectric constant (permittivity) and conductivity of the desired tissue. The head tissue dielectric parameters recommended by the IEEE SCC-34/SC-2 have been incorporated in the following table. Other head and body tissue parameters that have not been specified in P1528 are derived from the issue dielectric parameters computed from the 4-Cole-Cole equations. The mixture characterizations used for the brain and muscle tissue simulating liquids are according to the data by C. Gabriel and G. Hartsgrove [13]. (see Fig. 5.2)

Table 5.1 Composition of the Brain & Muscle Tissue Equivalent Matter

INGREDIENTS		SIMULATING TISSUE			
		835MHz Brain	835MHz Muscle	1900MHz Brain	1900MHz Muscle
Mixture Percentage					
WATER		41.45	52.50	54.90	40.40
DGBE		0.000	0.000	44.92	0.000
SUGAR		56.00	45.00	0.000	58.00
SALT		1.450	1.400	0.180	0.500
BACTERIACIDE		0.100	0.100	0.000	0.100
HEC		1.000	1.000	0.000	1.000
Dielectric Constant	Target	41.50	55.20	40.00	53.30
Conductivity (S/m)	Target	0.900	0.970	1.400	1.520



Device Holder for Transmitters



Figure 5.2 Mounting Device

In combination with the SAM Twin Phantom V4.0, the Mounting Device (see Fig. 5.2) enables the rotation of the mounted transmitter in spherical coordinates whereby the rotation point is the ear opening. The devices can be easily, accurately, and repeatably be positioned according to the FCC specifications. The device holder can be locked at different phantom locations (left head, right head, flat phantom).

* Note: A simulating human hand is not used due to the complex anatomical and geometrical structure of the hand that may produce infinite number of configurations [12]. To produce the worst-case condition (the hand absorbs antenna output power), the hand is omitted during the tests.

PCTEST SAR REPORT			FCC CERTIFICATION		Reviewed by: Quality Manager
SAR Filename: 0506270475	Test Dates: June 27-29, 2005	Phone Type: Tri-Mode Dual-Band Phone	FCC ID: AEZSCP-4930	Page 7 of 36	

7. DOSIMETRIC ASSESSMENT & PHANTOM SPECS

Measurement Procedure

The evaluation was performed using the following procedure:

1. The SAR measurement was taken at a selected spatial reference point to monitor power variations during testing. This fixed location point was measured and used as a reference value.
2. The SAR distribution at the exposed side of the head was measured at a distance of 3.9mm from the inner surface of the shell. The area covered the entire dimension of the head and the horizontal grid spacing was 15mm x 15mm.
3. Based on the area scan data, the area of the maximum absorption was determined by spline interpolation. Around this point, a volume of 32mm x 32mm x 34mm (fine resolution volume scan, zoom scan) was assessed by measuring 7 x 7 x 7 points. On this basis of this data set, the spatial peak SAR value was evaluated with the following procedure (see Fig. 7.1):
 - a. The data at the surface was extrapolated, since the center of the dipoles is 2.7mm away from the tip of the probe and the distance between the surface and the lowest measuring point is 1.2mm. The extrapolation was based on a least square algorithm [15]. A polynomial of the fourth order was calculated through the points in z-axes. This polynomial was then used to evaluate the points between the surface and the probe tip.
 - b. The maximum interpolated value was searched with a straight-forward algorithm. Around this maximum the SAR values averaged over the spatial volumes (1g or 10g) were computed using the 3D-Spline interpolation algorithm. The 3D-spline is composed of three one-dimensional splines with the "Not a knot" condition (in x, y, and z directions) [15][16]. The volume was integrated with the trapezoidal algorithm. One thousand points (10 x 10 x 10) were interpolated to calculate the average.
 - c. All neighboring volumes were evaluated until no neighboring volume with a higher average value was found.
4. The SAR reference value, at the same location as procedure #1, was re-measured. If the value changed by more than 5%, the evaluation is repeated.





Figure 7.1 Sample SAR Area Scan

Specific Anthropomorphic Mannequin (SAM) Specifications

The phantom for handset SAR assessment testing is a low-loss dielectric shell, with shape and dimensions derived from the anthropometric data of the 90th percentile adult male head dimensions as tabulated by the US Army. The SAM Twin Phantom shell is bisected along the mid-sagittal plane into right and left halves (see Fig. 7.2). The perimeter sidewalls of each phantom halves are extended to allow filling with liquid to a depth that is sufficient to minimized reflections from the upper surface. The liquid depth is maintained at a minimum depth of 15cm to minimize reflections from the upper surface.



Figure 7.2 SAM Twin Phantom shell

PCTEST SAR REPORT			FCC CERTIFICATION		Reviewed by: Quality Manager
SAR Filename: 0506270475	Test Dates: June 27-29, 2005	Phone Type: Tri-Mode Dual-Band Phone	FCC ID: AEZSCP-4930	Page 9 of 36	

8. DEFINITION OF REFERENCE POINTS

EAR Reference Point

Figure 8.1 shows the front, back and side views of the SAM Twin Phantom. The point "M" is the reference point for the center of the mouth, "LE" is the left ear reference point (ERP), and "RE" is the right ERP. The ERPs are 15mm posterior to the entrance to the ear canal (EEC) along the B-M line (Back-Mouth), as shown in Figure 9.2. The plane passing through the two ear canals and M is defined as the Reference Plane. The line N-F (Neck-Front) is perpendicular to the reference plane and passing through the RE (or LE) is called the Reference Pivoting Line (see Figure 8.2). Line B-M is perpendicular to the N-F line. Both N-F and B-M lines are marked on the external phantom shell to facilitate handset positioning [5].

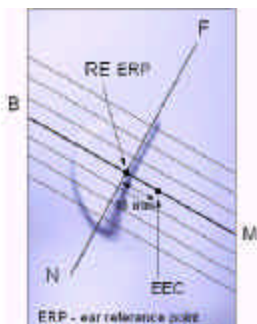

Figure 8.2 Close-up side view of ERPs



Figure 8.1 Front, back and side view of SAM Twin Phantom

Handset Reference Points

Two imaginary lines on the handset were established: the vertical centerline and the horizontal line. The test device was placed in a normal operating position with the "test device reference point" located along the "vertical centerline" on the front of the device aligned to the "ear reference point" (See Fig. 8.3). The "test device reference point" was then located at the same level as the center of the ear reference point. The test device was positioned so that the "vertical centerline" was bisecting the front surface of the handset at it's top and bottom edges, positioning the "ear reference point" on the outer surface of the both the left and right head phantoms on the ear reference point.

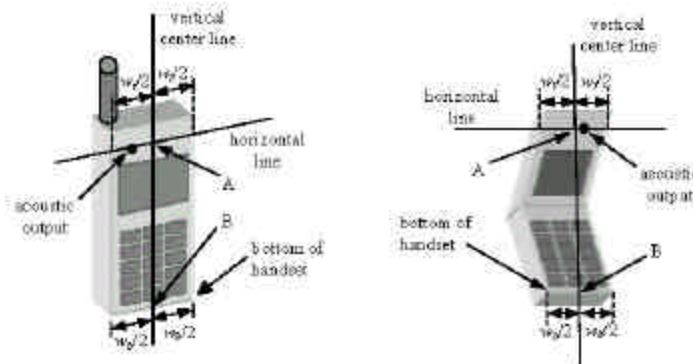



Figure 8.3 Handset Vertical Center & Horizontal Line Reference Points

PCTEST SAR REPORT			FCC CERTIFICATION		Reviewed by: Quality Manager
SAR Filename: 0506270475	Test Dates: June 27-29, 2005	Phone Type: Tri-Mode Dual-Band Phone	FCC ID: AEZSCP-4930	Page 10 of 36	

9. TEST CONFIGURATION POSITIONS

Positioning for Cheek/Touch

- The test device was positioned with the handset close to the surface of the phantom such that point A is on the (virtual) extension of the line passing through points RE and LE on the phantom (see Figure 9.1), such that the plane defined by the vertical center line and the horizontal line of the phone is approximately parallel to the sagittal plane of the phantom.



Figure 9.1 Front, Side and Top View of Cheek/Touch Position

- The handset was translated towards the phantom along the line passing through RE & LE until the handset touches the ear.
- While maintaining the handset in this plane, the handset was rotated around the LE-RE line until the vertical centerline was in the plane normal to MB-NF including the line MB (reference plane).
- The phone was then rotated around the vertical centerline until the phone (horizontal line) was symmetrical with respect to the line NF.
- While maintaining the vertical centerline in the reference plane, keeping point A on the line passing through RE and LE, and maintaining the phone contact with the ear, the handset was rotated about the line NF until any point on the handset made contact with a phantom point below the ear (cheek). See Figure 9.2)

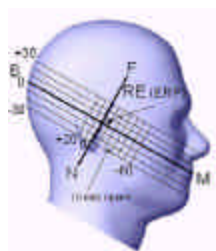

Figure 9.2 Side view w/ relevant markings

PCTEST SAR REPORT	FCC CERTIFICATION			Reviewed by: Quality Manager
SAR Filename: 0506270475	Test Dates: June 27-29, 2005	Phone Type: Tri-Mode Dual-Band Phone	FCC ID: AEZSCP-4930	Page 11 of 36

9. TEST CONFIGURATION POSITIONS (Continued)

Positioning for Ear / 15° Tilt

With the test device aligned in the “Cheek/Touch Position”:

1. While maintaining the orientation of the phone, the phone was retracted parallel to the reference plane far enough to enable a rotation of the phone by 15degree.
2. The phone was then rotated around the horizontal line by 15 degree.
3. While maintaining the orientation of the phone, the phone was moved parallel to the reference plane until any part of the phone touches the head. (In this position, point A was located on the line RE-LE). The tilted position is obtained when the contact is on the pinna. If the contact was at any location other than the pinna, the angle of the phone would then be reduced. The tilted position was obtained when any part of the phone was in contact of the ear as well as a second part of the phone was in contact with the head (see Figure 9.3).

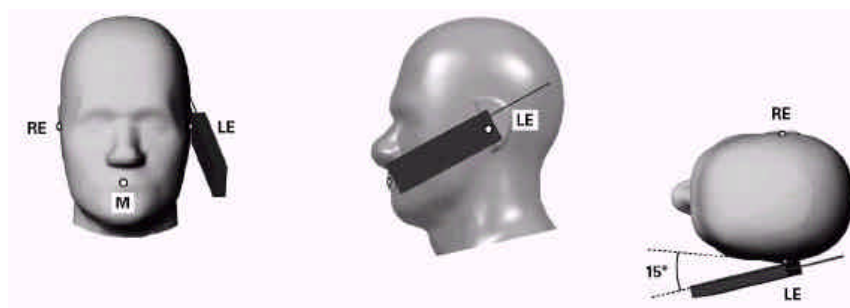

Figure 9.3 Front, Side and Top View of Ear/15° Tilt Position

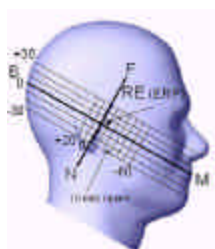

Figure 9.4 Side view w/ relevant markings

PCTEST SAR REPORT	FCC CERTIFICATION			Reviewed by: Quality Manager
SAR Filename: 0506270475	Test Dates: June 27-29, 2005	Phone Type: Tri-Mode Dual-Band Phone	FCC ID: AEZSCP-4930	Page 12 of 36

9. TEST CONFIGURATION POSITIONS (Continued)

Body Holster /Belt Clip Configurations

Body-worn operating configurations are tested with the belt-clips and holsters attached to the device and positioned against a flat phantom in a normal use configuration (see Figure 9.5). A device with a headset output is tested with a headset connected to the device. Body dielectric parameters are used.

Accessories for Body-worn operation configurations are divided into two categories: those that do not contain metallic components and those that do contain metallic components. When multiple accessories that do not contain metallic components are supplied with the device, the device is tested with only the accessory that dictates the closest spacing to the body. Then multiple accessories that contain metallic components are supplied with the device, the device is tested with each accessory that contains a unique metallic component. If multiple accessories share an identical metallic component (i.e. the same metallic belt-clip used with different holsters with no other metallic components) only the accessory that dictates the closest spacing to the body is tested.

Body-worn accessories may not always be supplied or available as options for some devices intended to be authorized for body-worn use. In this case, a test configuration where a separation distance between the back of the device and the flat phantom is used. All test position spacings are documented.

Transmitters that are designed to operate in front of a person's face, as in push-to-talk configurations, are tested for SAR compliance with the front of the device positioned to face the flat phantom. For devices that are carried next to the body such as a shoulder, waist or chest-worn transmitters, SAR compliance is tested with the accessory(ies), including headsets and microphones, attached to the device and positioned against a flat phantom in a normal use configuration.

In all cases SAR measurements are performed to investigate the worst-case positioning. Worst-case positioning is then documented and used to perform Body SAR testing.

In order for users to be aware of the body-worn operating requirements for meeting RF exposure compliance, operating instructions and cautions statements are included in the user's manual.



Figure 9.5 Body Belt Clip & Holster Configurations

PCTEST SAR REPORT				FCC CERTIFICATION	Reviewed by: Quality Manager
SAR Filename: 0506270475	Test Dates: June 27-29, 2005	Phone Type: Tri-Mode Dual-Band Phone	FCC ID: AEZSCP-4930	Page 13 of 36	

10. ANSI/IEEE C95.1 - 1992 RF EXPOSURE LIMITS

Uncontrolled Environment

UNCONTROLLED ENVIRONMENTS are defined as locations where there is the exposure of individuals who have no knowledge or control of their exposure. The general population/uncontrolled exposure limits are applicable to situations in which the general public may be exposed or in which persons who are exposed as a consequence of their employment may not be made fully aware of the potential for exposure or cannot exercise control over their exposure. Members of the general public would come under this category when exposure is not employment-related; for example, in the case of a wireless transmitter that exposes persons in its vicinity.

Controlled Environment

CONTROLLED ENVIRONMENTS are defined as locations where there is exposure that may be incurred by persons who are aware of the potential for exposure, (i.e. as a result of employment or occupation). In general, occupational/controlled exposure limits are applicable to situations in which persons are exposed as a consequence of their employment, who have been made fully aware of the potential for exposure and can exercise control over their exposure. This exposure category is also applicable when the exposure is of a transient nature due to incidental passage through a location where the exposure levels may be higher than the general population/uncontrolled limits, but the exposed person is fully aware of the potential for exposure and can exercise control over his or her exposure by leaving the area or by some other appropriate means.



Table 10.1. Safety Limits for Partial Body Exposure [2]

	HUMAN EXPOSURE LIMITS	
	UNCONTROLLED ENVIRONMENT General Population (W/kg) or (mW/g)	CONTROLLED ENVIRONMENT General Population (W/kg) or (mW/g)
SPATIAL PEAK SAR ¹ Brain	1.60	8.00
SPATIAL AVERAGE SAR ² Whole Body	0.08	0.40
SPATIAL PEAK SAR ³ Hands, Feet, Ankles, Wrists	4.00	20.00

1 The Spatial Peak value of the SAR averaged over any 1 gram of tissue (defined as a tissue volume in the shape of a cube) and over the appropriate averaging time.

2 The Spatial Average value of the SAR averaged over the whole body.

3 The Spatial Peak value of the SAR averaged over any 10 grams of tissue (defined as a tissue volume in the shape of a cube) and over the appropriate averaging time.

PCTEST SAR REPORT	 		Reviewed by: Quality Manager
SAR Filename: 0506270475	Test Dates: June 27-29, 2005	Phone Type: Tri-Mode Dual-Band Phone	FCC ID: AEZSCP-4930 Page 14 of 36

11. MEASUREMENT UNCERTAINTIES

a	b	c	d	e= f(d,k)	f	g	h = cxf/e	i = cxg/e	k
Uncertainty Component	Sec.	Tol. (± %)	Prob. Dist.	Div.	c_i (1 - g)	c_i (10 - g)	1 - g u_i (± %)	10 - g u_i (± %)	v_i
Measurement System									
Probe Calibration	E1.1	4.8	N	1	1	1	4.8	4.8	∞
Axial Isotropy	E1.2	4.7	R	$\sqrt{3}$	0.7	0.7	1.9	1.9	∞
Hemishperical Isotropy	E1.2	9.6	R	$\sqrt{3}$	0.7	0.7	3.9	3.9	∞
Boundary Effect	E1.3	1.0	R	$\sqrt{3}$	1	1	0.6	0.6	∞
Linearity	E1.4	4.7	R	$\sqrt{3}$	1	1	2.7	2.7	∞
System Detection Limits	E1.5	1.0	R	$\sqrt{3}$	1	1	0.6	0.6	∞
Readout Electronics	E1.6	1.0	N	1	1	1	1.0	1.0	∞
Response Time	E1.7	0.8	R	$\sqrt{3}$	1	1	0.5	0.5	∞
Integration Time	E1.8	2.6	R	$\sqrt{3}$	1	1	1.5	1.5	∞
RF Ambient Conditions	E5.1	3.0	R	$\sqrt{3}$	1	1	1.7	1.7	∞
Probe Positioner Mechanical Tolerance	E5.2	0.4	R	$\sqrt{3}$	1	1	0.2	0.2	∞
Probe Positioning w/ respect to Phantom	E5.3	2.9	R	$\sqrt{3}$	1	1	1.7	1.7	∞
Extrapolation, Interpolation & Integration Algorithms for Max. SAR Evaluation	E4.2	1.0	R	$\sqrt{3}$	1	1	0.6	0.6	∞
Test Sample Related									
Test Sample Positioning	E3.2.1	2.9	N	1	1	1	2.9	2.9	145
Device Holder Uncertainty	E3.1.1	3.6	N	1	1	1	3.6	3.6	5
Output Power Variation - SAR drift measurement	5.6.2	5.0	R	$\sqrt{3}$	1	1	2.9	2.9	∞
Phantom & Tissue Parameters									
Phantom Uncertainty (Shape & Thickness tolerances)	E2.1	4.0	R	$\sqrt{3}$	1	1	2.3	2.3	∞
Liquid Conductivity - deviation from target values	E2.2	5.0	R	$\sqrt{3}$	0.64	0.43	1.8	1.2	∞
Liquid Conductivity - measurement uncertainty	E2.2	2.5	N	1	0.64	0.43	1.6	1.1	∞
Liquid Permittivity - deviation from target values	E2.2	5.0	R	$\sqrt{3}$	0.6	0.5	1.7	1.4	∞
Liquid Permittivity - measurement uncertainty	E2.2	2.5	N	1	0.6	0.5	1.5	1.2	∞
Combined Standard Uncertainty (k=1)			RSS				10.3	10.0	
Expanded Uncertainty (k=2) (95% CONFIDENCE LEVEL)							20.6	20.1	

The above measurement uncertainties are according to IEEE Std. 1528 - 2003.

PCTEST SAR REPORT	FCC CERTIFICATION				Reviewed by: Quality Manager
SAR Filename: 0506270475	Test Dates: June 27-29, 2005	Phone Type: Tri-Mode Dual-Band Phone	FCC ID: AEZSCP-4930	Page 15 of 36	

12. SYSTEM VERIFICATION

Tissue Verification

Table 12.1 Simulated Tissue Verification [5]

MEASURED TISSUE PARAMETERS									
Date(s)	06/27/2005	835MHz Brain		835MHz Muscle		1900MHz Brain		1900MHz Muscle	
Liquid Temperature (°C)		Target	Measured	Target	Measured	Target	Measured	Target	Measured
Dielectric Constant: ϵ		41.50	42.30	55.20	53.00	40.00	41.60	53.30	53.20
Conductivity: σ		0.900	0.88	0.970	0.98	1.400	1.36	1.520	1.58

Prior to assessment, the system is verified to the $\pm 10\%$ of the specifications at 835MHz and 1900MHz by using the system validation kit(s). (Graphic Plots Attached)

Table 12.2 System Validation [5]

SYSTEM VALIDATION TARGET & MEASURED							
Date:	Amb. Temp (°C)	Liquid Temp (°C)	Input Power (W)	Tissue	Targeted SAR _{1g} (mW/g)	Measured SAR _{1g} (mW/g)	Deviation (%)
06/27/05	23.6	20.5	0.250	835 MHz Brain	2.375	2.43	2.31
06/28/05	23.8	20.6				2.45	3.15
06/28/05	23.8	20.2	0.100	1900 MHz Brain	3.970	4.08	2.77
06/29/05	23.9	20.4				4.13	4.03

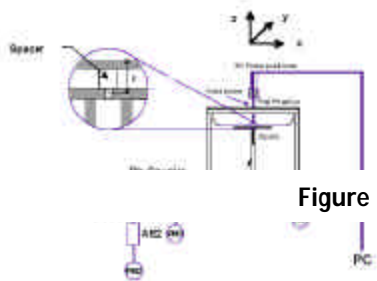



Figure 12.1 Dipole Valid



PCTEST SAR REPORT		FCC CERTIFICATION		Reviewed by: Quality Manager
SAR Filename: 0506270475	Test Dates: June 27-29, 2005	Phone Type: Tri-Mode Dual-Band Phone	FCC ID: AEZSCP-4930	Page 16 of 36

13. SAR TEST DATA SUMMARY



See Measurement Result Data Pages

Procedures Used To Establish Test Signal

The handset was placed into simulated call mode (AMPS, Cellular CDMA & PCS CDMA modes) using manufacturers test codes. Such test signals offer a consistent means for testing SAR and are recommended for evaluating SAR [4]. When test modes are not available or inappropriate for testing a handset, the actual transmission is activated through a base station simulator or similar equipment. See data pages for actual procedure used in measurement.

Device Test Conditions

The handset is battery operated. Each SAR measurement was taken with a fully charged battery. In order to verify that the device was tested at full power, conducted output power measurements were performed before and after each SAR measurement to confirm the output power. If a conducted power deviation of more than 5% occurred, the test was repeated.

PCTEST SAR REPORT			FCC CERTIFICATION		Reviewed by: Quality Manager
SAR Filename: 0506270475	Test Dates: June 27-29, 2005	Phone Type: Tri-Mode Dual-Band Phone	FCC ID: AEZSCP-4930	Page 17 of 36	

SAR DATA SUMMARY

Mixture Type: 835MHz Brain

14.1 MEASUREMENT RESULTS (AMPS Right Head SAR – Touch)								
FREQUENCY		Modulation	Begin / End POWER [†]			Device Test Position	Antenna Position	SAR (W/kg)
MHz	Ch.		(dBm)		Battery			
836.49	0383	AMPS	24.50	24.50	Standard	Cheek / Touch	In	0.729
836.49	0383	AMPS	24.51	24.53	Standard	Cheek / Touch	Out	0.799
ANSI / IEEE C95.1 1992 - SAFETY LIMIT Spatial Peak Uncontrolled Exposure/General Population						Brain 1.6 W/kg (mW/g) averaged over 1 gram		

NOTES:

1. The test data reported are the worst-case SAR value with the antenna-head position set in a typical configuration. Test procedures used are according to FCC/OET Bulletin 65, Supp.C [July 2001].
 2. All modes of operation were investigated, and worst-case results are reported.
 3. Battery is fully charged for all readings. Standard batteries are the only options.
- | | | | | | | |
|---------------------------|-------------------------------------|------------------|--------------------------|------------------------|-------------------------------------|------------|
| †Power Measured | <input checked="" type="checkbox"/> | Conducted | <input type="checkbox"/> | ERP | <input type="checkbox"/> | EIRP |
| 4. SAR Measurement System | <input checked="" type="checkbox"/> | DASY4 | <input type="checkbox"/> | IDX | | |
| Phantom Configuration | <input type="checkbox"/> | Left Head | <input type="checkbox"/> | Flat Phantom | <input checked="" type="checkbox"/> | Right Head |
| 5. SAR Configuration | <input checked="" type="checkbox"/> | Head | <input type="checkbox"/> | Body | <input type="checkbox"/> | Hand |
| 6. Test Signal Call Mode | <input checked="" type="checkbox"/> | Manu. Test Codes | <input type="checkbox"/> | Base Station Simulator | | |
7. Tissue parameters and temperatures are listed on the SAR plots.
 8. Liquid tissue depth is 15.1 cm. ± 0.1



Alfred Cirwithian
Vice President Engineering

PCTEST SAR REPORT	FCC CERTIFICATION			Reviewed by: Quality Manager
SAR Filename: 0506270475	Test Dates: June 27-29, 2005	Phone Type: Tri-Mode Dual-Band Phone	FCC ID: AEZSCP-4930	Page 18 of 36

SAR DATA SUMMARY (Continued)

Mixture Type: 835MHz Brain



14.2 MEASUREMENT RESULTS (AMPS Right Head SAR – Tilt)								
FREQUENCY		Modulation	Begin / End POWER [†]			Device Test Position	Antenna Position	SAR (W/kg)
MHz	Ch.		(dBm)		Battery			
836.49	0383	AMPS	24.54	24.56	Standard	Ear / 15° Tilt	In	0.691
836.49	0383	AMPS	24.56	24.57	Standard	Ear / 15° Tilt	Out	0.782
ANSI / IEEE C95.1 1992 - SAFETY LIMIT Spatial Peak Uncontrolled Exposure/General Population						Brain 1.6 W/kg (mW/g) <small>averaged over 1 gram</small>		

NOTES:

1. The test data reported are the worst-case SAR value with the antenna-head position set in a typical configuration. Test procedures used are according to FCC/OET Bulletin 65, Supp.C [July 2001].
 2. All modes of operation were investigated, and worst-case results are reported.
 3. Battery is fully charged for all readings. Standard batteries are the only options.
- †Power Measured Conducted ERP EIRP
4. SAR Measurement System DASY4 IDX
 Phantom Configuration Left Head Flat Phantom Right Head
 5. SAR Configuration Head Body Hand
 6. Test Signal Call Mode Manu. Test Codes Base Station Simulator
7. Tissue parameters and temperatures are listed on the SAR plots.
 8. Liquid tissue depth is 15.1 cm. ± 0.1
 9. Justification for reduced test configurations: Per FCC/OET Bulletin 65 Supplement C (July, 2001), if the SAR measured at the middle channel for each test configuration (left, right, cheek/touch, tilt/ear, extended and retracted) is at least 3.0 dB lower than the SAR limit, testing at the high and low channels is optional for such test configuration(s).



Alfred Cirwihian
Vice President Engineering

PCTEST SAR REPORT	 FCC CERTIFICATION 			Reviewed by: Quality Manager
SAR Filename: 0506270475	Test Dates: June 27-29, 2005	Phone Type: Tri-Mode Dual-Band Phone	FCC ID: AEZSCP-4930	Page 19 of 36

SAR DATA SUMMARY (Continued)

Mixture Type: 835MHz Brain



14.3 MEASUREMENT RESULTS (AMPS Left Head SAR - Touch)								
FREQUENCY		Modulation	Begin / End POWER [†]			Device Test Position	Antenna Position	SAR (W/kg)
MHz	Ch.		(dBm)		Battery			
824.04	0991	AMPS	24.50	24.51	Standard	Cheek / Touch	In	1.010
824.04	0991	AMPS	24.51	24.53	Standard	Cheek / Touch	Out	0.941
836.49	0383	AMPS	24.53	24.52	Standard	Cheek / Touch	In	0.905
836.49	0383	AMPS	24.50	24.49	Standard	Cheek / Touch	Out	0.869
848.97	0799	AMPS	24.50	24.47	Standard	Cheek / Touch	In	0.914
848.97	0799	AMPS	24.53	24.54	Standard	Cheek / Touch	Out	0.789
ANSI / IEEE C95.1 1992 - SAFETY LIMIT						Brain		
Spatial Peak						1.6 W/kg (mW/g)		
Uncontrolled Exposure/General Population						averaged over 1 gram		

NOTES:

1. The test data reported are the worst-case SAR value with the antenna-head position set in a typical configuration. Test procedures used are according to FCC/OET Bulletin 65, Supp.C [July 2001].
 2. All modes of operation were investigated, and worst-case results are reported.
 3. Battery is fully charged for all readings. Standard batteries are the only options.
- | | | | | | | |
|---------------------------|-------------------------------------|------------------|--------------------------|------------------------|--------------------------|------------|
| *Power Measured | <input checked="" type="checkbox"/> | Conducted | <input type="checkbox"/> | ERP | <input type="checkbox"/> | EIRP |
| 4. SAR Measurement System | <input checked="" type="checkbox"/> | DASY4 | <input type="checkbox"/> | IDX | | |
| Phantom Configuration | <input checked="" type="checkbox"/> | Left Head | <input type="checkbox"/> | Flat Phantom | <input type="checkbox"/> | Right Head |
| 5. SAR Configuration | <input checked="" type="checkbox"/> | Head | <input type="checkbox"/> | Body | <input type="checkbox"/> | Hand |
| 6. Test Signal Call Mode | <input checked="" type="checkbox"/> | Manu. Test Codes | <input type="checkbox"/> | Base Station Simulator | | |
7. Tissue parameters and temperatures are listed on the SAR plots.
 8. Liquid tissue depth is 15.1 cm. ± 0.1



Alfred Cirwithian
Vice President Engineering

PCTEST SAR REPORT	 FCC CERTIFICATION 			Reviewed by: Quality Manager
SAR Filename: 0506270475	Test Dates: June 27-29, 2005	Phone Type: Tri-Mode Dual-Band Phone	FCC ID: AEZSCP-4930	Page 20 of 36

SAR DATA SUMMARY (Continued)



Mixture Type: 835MHz Brain

14.4 MEASUREMENT RESULTS (AMPS Left Head SAR – Tilt)								
FREQUENCY		Modulation	Begin / End POWER [†]			Device Test Position	Antenna Position	SAR (W/kg)
MHz	Ch.		(dBm)		Battery			
824.04	0991	AMPS	24.56	24.58	Standard	Ear / 15° Tilt	In	0.990
824.04	0991	AMPS	24.58	24.59	Standard	Ear / 15° Tilt	Out	0.979
836.49	0383	AMPS	24.54	24.53	Standard	Ear / 15° Tilt	In	0.825
836.49	0383	AMPS	24.52	24.52	Standard	Ear / 15° Tilt	Out	0.884
848.97	0799	AMPS	24.51	24.46	Standard	Ear / 15° Tilt	In	0.844
848.97	0799	AMPS	24.54	24.53	Standard	Ear / 15° Tilt	Out	0.739
ANSI / IEEE C95.1 1992 - SAFETY LIMIT						Brain		
Spatial Peak						1.6 W/kg (mW/g)		
Uncontrolled Exposure/General Population						averaged over 1 gram		

NOTES:

1. The test data reported are the worst-case SAR value with the antenna-head position set in a typical configuration. Test procedures used are according to FCC/OET Bulletin 65, Supp.C [July 2001].
 2. All modes of operation were investigated, and worst-case results are reported.
 3. Battery is fully charged for all readings. Standard batteries are the only options.
- | | | | | | | |
|---------------------------|-------------------------------------|------------------|--------------------------|------------------------|--------------------------|------------|
| †Power Measured | <input checked="" type="checkbox"/> | Conducted | <input type="checkbox"/> | ERP | <input type="checkbox"/> | EIRP |
| 4. SAR Measurement System | <input checked="" type="checkbox"/> | DASY4 | <input type="checkbox"/> | IDX | | |
| Phantom Configuration | <input checked="" type="checkbox"/> | Left Head | <input type="checkbox"/> | Flat Phantom | <input type="checkbox"/> | Right Head |
| 5. SAR Configuration | <input checked="" type="checkbox"/> | Head | <input type="checkbox"/> | Body | <input type="checkbox"/> | Hand |
| 6. Test Signal Call Mode | <input checked="" type="checkbox"/> | Manu. Test Codes | <input type="checkbox"/> | Base Station Simulator | | |
7. Tissue parameters and temperatures are listed on the SAR plots.
 8. Liquid tissue depth is 15.1 cm. ± 0.1
 9. Justification for reduced test configurations: Per FCC/OET Bulletin 65 Supplement C (July, 2001), if the SAR measured at the middle channel for each test configuration (left, right, cheek/touch, tilt/ear, extended and retracted) is at least 3.0 dB lower than the SAR limit, testing at the high and low channels is optional for such test configuration(s).

 Alfred Cirwilhian
 Vice President Engineering

PCTEST SAR REPORT	 			Reviewed by: Quality Manager
SAR Filename: 0506270475	Test Dates: June 27-29, 2005	Phone Type: Tri-Mode Dual-Band Phone	FCC ID: AEZSCP-4930	Page 21 of 36

SAR DATA SUMMARY (Continued)

Mixture Type: 835MHz Brain



14.5 MEASUREMENT RESULTS (CDMA Right Head SAR – Touch)								
FREQUENCY		Modulation	Begin / End POWER [†]			Device Test Position	Antenna Position	SAR (W/kg)
MHz	Ch.		(dBm)		Battery			
836.49	0383	CDMA	23.50	23.52	Standard	Cheek / Touch	In	0.606
836.49	0383	CDMA	23.52	23.56	Standard	Cheek / Touch	Out	0.644
ANSI / IEEE C95.1 1992 - SAFETY LIMIT Spatial Peak Uncontrolled Exposure/General Population						Brain 1.6 W/kg (mW/g) averaged over 1 gram		

NOTES:

1. The test data reported are the worst-case SAR value with the antenna-head position set in a typical configuration. Test procedures used are according to FCC/OET Bulletin 65, Supp.C [July 2001].
 2. All modes of operation were investigated, and worst-case results are reported.
 3. Battery is fully charged for all readings. Standard batteries are the only options.
- | | | | | | | |
|---------------------------|-------------------------------------|------------------|--------------------------|------------------------|-------------------------------------|------------|
| *Power Measured | <input checked="" type="checkbox"/> | Conducted | <input type="checkbox"/> | ERP | <input type="checkbox"/> | EIRP |
| 4. SAR Measurement System | <input checked="" type="checkbox"/> | DASY4 | <input type="checkbox"/> | IDX | | |
| Phantom Configuration | <input type="checkbox"/> | Left Head | <input type="checkbox"/> | Flat Phantom | <input checked="" type="checkbox"/> | Right Head |
| 5. SAR Configuration | <input checked="" type="checkbox"/> | Head | <input type="checkbox"/> | Body | <input type="checkbox"/> | Hand |
| 6. Test Signal Call Mode | <input checked="" type="checkbox"/> | Manu. Test Codes | <input type="checkbox"/> | Base Station Simulator | | |
7. Tissue parameters and temperatures are listed on the SAR plots.
 8. Liquid tissue depth is 15.1 cm. ± 0.1



Alfred Cirwithian
Vice President Engineering

PCTEST SAR REPORT	 FCC CERTIFICATION 			Reviewed by: Quality Manager
SAR Filename: 0506270475	Test Dates: June 27-29, 2005	Phone Type: Tri-Mode Dual-Band Phone	FCC ID: AEZSCP-4930	Page 22 of 36

SAR DATA SUMMARY (Continued)

Mixture Type: 835MHz Brain



14.6 MEASUREMENT RESULTS (CDMA Right Head SAR - Tilt)								
FREQUENCY		Modulation	Begin / End POWER [†]			Device Test Position	Antenna Position	SAR (W/kg)
MHz	Ch.		(dBm)		Battery			
836.49	0383	CDMA	23.56	23.58	Standard	Ear / 15° Tilt	In	0.556
836.49	0383	CDMA	23.58	23.54	Standard	Ear / 15° Tilt	Out	0.624
ANSI / IEEE C95.1 1992 - SAFETY LIMIT Spatial Peak Uncontrolled Exposure/General Population						Brain 1.6 W/kg (mW/g) averaged over 1 gram		

NOTES:

1. The test data reported are the worst-case SAR value with the antenna-head position set in a typical configuration. Test procedures used are according to FCC/OET Bulletin 65, Supp.C [July 2001].
 2. All modes of operation were investigated, and worst-case results are reported.
 3. Battery is fully charged for all readings. Standard batteries are the only options.
- | | | | | | | |
|---------------------------|-------------------------------------|------------------|--------------------------|------------------------|-------------------------------------|------------|
| *Power Measured | <input checked="" type="checkbox"/> | Conducted | <input type="checkbox"/> | ERP | <input type="checkbox"/> | EIRP |
| 4. SAR Measurement System | <input checked="" type="checkbox"/> | DASY4 | <input type="checkbox"/> | IDX | | |
| Phantom Configuration | <input type="checkbox"/> | Left Head | <input type="checkbox"/> | Flat Phantom | <input checked="" type="checkbox"/> | Right Head |
| 5. SAR Configuration | <input checked="" type="checkbox"/> | Head | <input type="checkbox"/> | Body | <input type="checkbox"/> | Hand |
| 6. Test Signal Call Mode | <input checked="" type="checkbox"/> | Manu. Test Codes | <input type="checkbox"/> | Base Station Simulator | | |
7. Tissue parameters and temperatures are listed on the SAR plots.
 8. Liquid tissue depth is 15.1 cm. ± 0.1
 9. Justification for reduced test configurations: Per FCC/OET Bulletin 65 Supplement C (July, 2001), if the SAR measured at the middle channel for each test configuration (left, right, cheek/touch, tilt/ear, extended and retracted) is at least 3.0 dB lower than the SAR limit, testing at the high and low channels is optional for such test configuration(s).



Alfred Cirwithian
Vice President Engineering

PCTEST SAR REPORT	 			Reviewed by: Quality Manager
SAR Filename: 0506270475	Test Dates: June 27-29, 2005	Phone Type: Tri-Mode Dual-Band Phone	FCC ID: AEZSCP-4930	Page 23 of 36

SAR DATA SUMMARY (Continued)

Mixture Type: 835MHz Brain



14.7 MEASUREMENT RESULTS (CDMA Left Head SAR – Touch)								
FREQUENCY		Modulation	Begin / End POWER [†]			Device Test Position	Antenna Position	SAR (W/kg)
MHz	Ch.		(dBm)		Battery			
836.49	0383	CDMA	23.50	23.51	Standard	Cheek / Touch	In	0.702
836.49	0383	CDMA	23.51	23.52	Standard	Cheek / Touch	Out	0.753
ANSI / IEEE C95.1 1992 - SAFETY LIMIT Spatial Peak Uncontrolled Exposure/General Population						Brain 1.6 W/kg (mW/g) <small>averaged over 1 gram</small>		

NOTES:

1. The test data reported are the worst-case SAR value with the antenna-head position set in a typical configuration. Test procedures used are according to FCC/OET Bulletin 65, Supp.C [July 2001].
 2. All modes of operation were investigated, and worst-case results are reported.
 3. Battery is fully charged for all readings. Standard batteries are the only options.
- | | | | | | | |
|---------------------------|-------------------------------------|------------------|--------------------------|------------------------|-------------------------------------|------------|
| *Power Measured | <input checked="" type="checkbox"/> | Conducted | <input type="checkbox"/> | ERP | <input type="checkbox"/> | EIRP |
| 4. SAR Measurement System | <input checked="" type="checkbox"/> | DASY4 | <input type="checkbox"/> | IDX | | |
| Phantom Configuration | <input type="checkbox"/> | Left Head | <input type="checkbox"/> | Flat Phantom | <input checked="" type="checkbox"/> | Right Head |
| 5. SAR Configuration | <input checked="" type="checkbox"/> | Head | <input type="checkbox"/> | Body | <input type="checkbox"/> | Hand |
| 6. Test Signal Call Mode | <input checked="" type="checkbox"/> | Manu. Test Codes | <input type="checkbox"/> | Base Station Simulator | | |
7. Tissue parameters and temperatures are listed on the SAR plots.
 8. Liquid tissue depth is 15.1 cm. ± 0.1



Alfred Cirwithian
Vice President Engineering

PCTEST SAR REPORT	 FCC CERTIFICATION 			Reviewed by: Quality Manager
SAR Filename: 0506270475	Test Dates: June 27-29, 2005	Phone Type: Tri-Mode Dual-Band Phone	FCC ID: AEZSCP-4930	Page 24 of 36

SAR DATA SUMMARY (Continued)

Mixture Type: 835MHz Brain

14.8 MEASUREMENT RESULTS (CDMA Left Head SAR - Tilt)								
FREQUENCY		Modulation	Begin / End POWER [†]			Device Test Position	Antenna Position	SAR (W/kg)
MHz	Ch.		(dBm)		Battery			
836.49	0383	CDMA	23.51	23.54	Standard	Ear / 15° Tilt	In	0.646
836.49	0383	CDMA	23.54	23.56	Standard	Ear / 15° Tilt	Out	0.704
ANSI / IEEE C95.1 1992 - SAFETY LIM Spatial Peak Uncontrolled Exposure/General Population						Brain 1.6 W/kg (mW/g) <small>averaged over 1 gram</small>		

NOTES:

1. The test data reported are the worst-case SAR value with the antenna-head position set in a typical configuration. Test procedures used are according to FCC/OET Bulletin 65, Supp.C [July 2001].
 2. All modes of operation were investigated, and worst-case results are reported.
 3. Battery is fully charged for all readings. Standard batteries are the only options.
- | | | | | | | |
|---------------------------|-------------------------------------|------------------|--------------------------|------------------------|--------------------------|------------|
| †Power Measured | <input checked="" type="checkbox"/> | Conducted | <input type="checkbox"/> | ERP | <input type="checkbox"/> | EIRP |
| 4. SAR Measurement System | <input checked="" type="checkbox"/> | DASY4 | <input type="checkbox"/> | IDX | | |
| Phantom Configuration | <input checked="" type="checkbox"/> | Left Head | <input type="checkbox"/> | Flat Phantom | <input type="checkbox"/> | Right Head |
| 5. SAR Configuration | <input checked="" type="checkbox"/> | Head | <input type="checkbox"/> | Body | <input type="checkbox"/> | Hand |
| 6. Test Signal Call Mode | <input checked="" type="checkbox"/> | Manu. Test Codes | <input type="checkbox"/> | Base Station Simulator | | |
7. Tissue parameters and temperatures are listed on the SAR plots.
 8. Liquid tissue depth is 15.1 cm. ± 0.1
 9. Justification for reduced test configurations: Per FCC/OET Bulletin 65 Supplement C (July, 2001), if the SAR measured at the middle channel for each test configuration (left, right, cheek/touch, tilt/ear, extended and retracted) is at least 3.0 dB lower than the SAR limit, testing at the high and low channels is optional for such test configuration(s).



Alfred Cirwithian
Vice President Engineering

PCTEST SAR REPORT				Reviewed by: Quality Manager
SAR Filename: 0506270475	Test Dates: June 27-29, 2005	Phone Type: Tri-Mode Dual-Band Phone	FCC ID: AEZSCP-4930	Page 25 of 36

SAR DATA SUMMARY (Continued)

Mixture Type: 1900MHz Brain



14.9 MEASUREMENT RESULTS (PCS CDMA Right Head SAR – Touch)								
FREQUENCY		Modulation	Begin / End POWER [†]			Device Test Position	Antenna Position	SAR (W/kg)
MHz	Ch.		(dBm)		Battery			
1880.00	0600	PCS CDMA	23.57	23.60	Standard	Cheek / Touch	In	0.165
1880.00	0600	PCS CDMA	23.60	23.62	Standard	Cheek / Touch	Out	0.203
ANSI / IEEE C95.1 1992 - SAFETY LIMIT Spatial Peak Uncontrolled Exposure/General Population						Brain 1.6 W/kg (mW/g) <small>averaged over 1 gram</small>		

NOTES:

1. The test data reported are the worst-case SAR value with the antenna-head position set in a typical configuration. Test procedures used are according to FCC/OET Bulletin 65, Supp.C [July 2001].
 2. All modes of operation were investigated, and worst-case results are reported.
 3. Battery is fully charged for all readings. Standard batteries are the only options.
- | | | | | | | |
|---------------------------|-------------------------------------|------------------|--------------------------|------------------------|-------------------------------------|------------|
| †Power Measured | <input checked="" type="checkbox"/> | Conducted | <input type="checkbox"/> | ERP | <input type="checkbox"/> | EIRP |
| 4. SAR Measurement System | <input checked="" type="checkbox"/> | DASY4 | <input type="checkbox"/> | IDX | | |
| Phantom Configuration | <input type="checkbox"/> | Left Head | <input type="checkbox"/> | Flat Phantom | <input checked="" type="checkbox"/> | Right Head |
| 5. SAR Configuration | <input checked="" type="checkbox"/> | Head | <input type="checkbox"/> | Body | <input type="checkbox"/> | Hand |
| 6. Test Signal Call Mode | <input checked="" type="checkbox"/> | Manu. Test Codes | <input type="checkbox"/> | Base Station Simulator | | |
7. Tissue parameters and temperatures are listed on the SAR plots.
 8. Liquid tissue depth is 15.1 cm. ± 0.1



Alfred Cirwithian
Vice President Engineering

PCTEST SAR REPORT		FCC CERTIFICATION		Reviewed by: Quality Manager
SAR Filename: 0506270475	Test Dates: June 27-29, 2005	Phone Type: Tri-Mode Dual-Band Phone	FCC ID: AEZSCP-4930	Page 26 of 36

SAR DATA SUMMARY (Continued)

Mixture Type: 1900MHz Brain



14.10 MEASUREMENT RESULTS (PCS CDMA Right Head SAR – Tilt)								
FREQUENCY		Modulation	Begin / End POWER [†]			Device Test Position	Antenna Position	SAR (W/kg)
MHz	Ch.		(dBm)		Battery			
1880.00	0600	PCS CDMA	23.62	23.63	Standard	Ear / 15° Tilt	In	0.128
1880.00	0600	PCS CDMA	23.63	23.64	Standard	Ear / 15° Tilt	Out	0.186
ANSI / IEEE C95.1 1992 - SAFETY LIMIT Spatial Peak Uncontrolled Exposure/General Population						Brain 1.6 W/kg (mW/g) averaged over 1 gram		

NOTES:

1. The test data reported are the worst-case SAR value with the antenna-head position set in a typical configuration. Test procedures used are according to FCC/OET Bulletin 65, Supp.C [July 2001].
 2. All modes of operation were investigated, and worst-case results are reported.
 3. Battery is fully charged for all readings. Standard batteries are the only options.
- | | | | | | | |
|---------------------------|-------------------------------------|------------------|--------------------------|------------------------|-------------------------------------|------------|
| †Power Measured | <input checked="" type="checkbox"/> | Conducted | <input type="checkbox"/> | ERP | <input type="checkbox"/> | EIRP |
| 4. SAR Measurement System | <input checked="" type="checkbox"/> | DASY4 | <input type="checkbox"/> | IDX | | |
| Phantom Configuration | <input type="checkbox"/> | Left Head | <input type="checkbox"/> | Flat Phantom | <input checked="" type="checkbox"/> | Right Head |
| 5. SAR Configuration | <input checked="" type="checkbox"/> | Head | <input type="checkbox"/> | Body | <input type="checkbox"/> | Hand |
| 6. Test Signal Call Mode | <input checked="" type="checkbox"/> | Manu. Test Codes | <input type="checkbox"/> | Base Station Simulator | | |
7. Tissue parameters and temperatures are listed on the SAR plots.
 8. Liquid tissue depth is 15.1 cm. ± 0.1
 9. Justification for reduced test configurations: Per FCC/OET Bulletin 65 Supplement C (July, 2001), if the SAR measured at the middle channel for each test configuration (left, right, cheek/touch, tilt/ear, extended and retracted) is at least 3.0 dB lower than the SAR limit, testing at the high and low channels is optional for such test configuration(s).



Alfred Cirwithian
Vice President Engineering

PCTEST SAR REPORT	 FCC CERTIFICATION				Reviewed by: Quality Manager
SAR Filename: 0506270475	Test Dates: June 27-29, 2005	Phone Type: Tri-Mode Dual-Band Phone	FCC ID: AEZSCP-4930	Page 27 of 36	

SAR DATA SUMMARY (Continued)

Mixture Type: 1900MHz Brain



14.11 MEASUREMENT RESULTS (PCS CDMA Left Head SAR – Touch)								
FREQUENCY		Modulation	Begin / End POWER [†]			Device Test Position	Antenna Position	SAR (W/kg)
MHz	Ch.		(dBm)		Battery			
1880.00	0600	PCS CDMA	23.59	23.64	Standard	Cheek / Touch	In	0.287
1880.00	0600	PCS CDMA	23.64	23.65	Standard	Cheek / Touch	Out	0.374
ANSI / IEEE C95.1 1992 - SAFETY LIMIT Spatial Peak Uncontrolled Exposure/General Population						Brain 1.6 W/kg (mW/g) averaged over 1 gram		

NOTES:

1. The test data reported are the worst-case SAR value with the antenna-head position set in a typical configuration. Test procedures used are according to FCC/OET Bulletin 65, Supp.C [July 2001].
 2. All modes of operation were investigated, and worst-case results are reported.
 3. Battery is fully charged for all readings. Standard batteries are the only options.
- | | | | | | | |
|---------------------------|-------------------------------------|------------------|--------------------------|------------------------|--------------------------|------------|
| †Power Measured | <input checked="" type="checkbox"/> | Conducted | <input type="checkbox"/> | ERP | <input type="checkbox"/> | EIRP |
| 4. SAR Measurement System | <input checked="" type="checkbox"/> | DASY4 | <input type="checkbox"/> | IDX | | |
| Phantom Configuration | <input checked="" type="checkbox"/> | Left Head | <input type="checkbox"/> | Flat Phantom | <input type="checkbox"/> | Right Head |
| 5. SAR Configuration | <input checked="" type="checkbox"/> | Head | <input type="checkbox"/> | Body | <input type="checkbox"/> | Hand |
| 6. Test Signal Call Mode | <input checked="" type="checkbox"/> | Manu. Test Codes | <input type="checkbox"/> | Base Station Simulator | | |
7. Tissue parameters and temperatures are listed on the SAR plots.
 8. Liquid tissue depth is 15.1 cm. ± 0.1



Alfred Cirwithian
Vice President Engineering

PCTEST SAR REPORT		FCC CERTIFICATION		Reviewed by: Quality Manager
SAR Filename: 0506270475	Test Dates: June 27-29, 2005	Phone Type: Tri-Mode Dual-Band Phone	FCC ID: AEZSCP-4930	Page 28 of 36

SAR DATA SUMMARY (Continued)

Mixture Type: 1900MHz Brain

14.12 MEASUREMENT RESULTS (PCS CDMA Left Head SAR – Tilt)								
FREQUENCY		Modulation	Begin / End POWER [†]			Device Test Position	Antenna Position	SAR (W/kg)
MHz	Ch.		(dBm)		Battery			
1880.00	0600	PCS CDMA	23.62	23.66	Standard	Ear / 15° Tilt	In	0.193
1880.00	0600	PCS CDMA	23.66	23.68	Standard	Ear / 15° Tilt	Out	0.329
ANSI / IEEE C95.1 1992 - SAFETY LIMIT Spatial Peak Uncontrolled Exposure/General Population						Brain 1.6 W/kg (mW/g) averaged over 1 gram		

NOTES:

1. The test data reported are the worst-case SAR value with the antenna-head position set in a typical configuration. Test procedures used are according to FCC/OET Bulletin 65, Supp.C [July 2001].
 2. All modes of operation were investigated, and worst-case results are reported.
 3. Battery is fully charged for all readings. Standard batteries are the only options.
- | | | | |
|-----------------|---|------------------------------|-------------------------------|
| †Power Measured | <input checked="" type="checkbox"/> Conducted | <input type="checkbox"/> ERP | <input type="checkbox"/> EIRP |
|-----------------|---|------------------------------|-------------------------------|
4. SAR Measurement System

<input checked="" type="checkbox"/> DASY4	<input type="checkbox"/> IDX
---	------------------------------
 - Phantom Configuration



<input checked="" type="checkbox"/> Left Head	<input type="checkbox"/> Flat Phantom	<input type="checkbox"/> Right Head
---	---------------------------------------	-------------------------------------
 5. SAR Configuration

<input checked="" type="checkbox"/> Head	<input type="checkbox"/> Body	<input type="checkbox"/> Hand
--	-------------------------------	-------------------------------
 6. Test Signal Call Mode

<input checked="" type="checkbox"/> Manu. Test Codes	<input type="checkbox"/> Base Station Simulator
--	---
 7. Tissue parameters and temperatures are listed on the SAR plots.
 8. Liquid tissue depth is 15.1 cm. ± 0.1
 9. Justification for reduced test configurations: Per FCC/OET Bulletin 65 Supplement C (July, 2001), if the SAR measured at the middle channel for each test configuration (left, right, cheek/touch, tilt/ear, extended and retracted) is at least 3.0 dB lower than the SAR limit, testing at the high and low channels is optional for such test configuration(s).



Alfred Cirwihian
Vice President Engineering

PCTEST SAR REPORT	 FCC CERTIFICATION			Reviewed by: Quality Manager
SAR Filename: 0506270475	Test Dates: June 27-29, 2005	Phone Type: Tri-Mode Dual-Band Phone	FCC ID: AEZSCP-4930	Page 29 of 36

SAR DATA SUMMARY (Continued)

Mixture Type: 835MHz Muscle



14.13 MEASUREMENT RESULTS (AMPS Body SAR w/o Holster)								
FREQUENCY		Modulation	Begin / End POWER [†]			Separation Distance (cm) ^{‡‡}	Antenna Position	SAR (W/kg)
MHz	Ch.		(dBm)		Battery			
836.49	0383	AMPS	24.51	24.53	Standard	1.9 [w/o Holster]	In	0.485
836.49	0383	AMPS	24.53	24.00	Standard	1.9 [w/o Holster]	Out	0.516
ANSI / IEEE C95.1 1992 - SAFETY LIMIT						Muscle 1.6 W/kg (mW/g) averaged over 1 gram		
Spatial Peak								
Uncontrolled Exposure/General Population								

NOTES:

1. The test data reported are the worst-case SAR value with the antenna-head position set in a typical configuration. Test procedures used are according to FCC/OET Bulletin 65, Supp.C [July 2001].
 2. All modes of operation were investigated, and worst-case results are reported.
 3. Battery is fully charged for all readings. Standard batteries are the only options.
- | | | | | | | |
|---------------------------|-------------------------------------|------------------|-------------------------------------|------------------------|--------------------------|------------|
| *Power Measured | <input checked="" type="checkbox"/> | Conducted | <input type="checkbox"/> | ERP | <input type="checkbox"/> | EIRP |
| 4. SAR Measurement System | <input checked="" type="checkbox"/> | DASY4 | <input type="checkbox"/> | IDX | | |
| Phantom Configuration | <input type="checkbox"/> | Left Head | <input checked="" type="checkbox"/> | Flat Phantom | <input type="checkbox"/> | Right Head |
| 5. SAR Configuration | <input type="checkbox"/> | Head | <input checked="" type="checkbox"/> | Body | <input type="checkbox"/> | Hand |
| 6. Test Signal Call Mode | <input checked="" type="checkbox"/> | Manu. Test Codes | <input type="checkbox"/> | Base Station Simulator | | |
| 7. **Test Configuration | <input type="checkbox"/> | With Holster | <input checked="" type="checkbox"/> | Without Holster | | |
8. Tissue parameters and temperatures are listed on the SAR plots.
 9. Both sides of the phone were tested and the worst-case side is reported.
 10. Liquid tissue depth is 15.1 cm. ± 0.1



Alfred Cirwithian
Vice President Engineering

PCTEST SAR REPORT		FCC CERTIFICATION		Reviewed by: Quality Manager
SAR Filename: 0506270475	Test Dates: June 27-29, 2005	Phone Type: Tri-Mode Dual-Band Phone	FCC ID: AEZSCP-4930	Page 30 of 36

SAR DATA SUMMARY (Continued)

Mixture Type: 835MHz Muscle



14.14 MEASUREMENT RESULTS (CDMA Body SAR w/o Holster)								
FREQUENCY		Modulation	Begin / End POWER [†]			Separation Distance (cm) ^{##}	Antenna Position	SAR (W/kg)
MHz	Ch.		(dBm)		Battery			
836.49	0383	CDMA	24.50	24.53	Standard	1.9 [w/o Holster]	In	0.323
836.49	0383	CDMA	24.53	24.55	Standard	1.9 [w/o Holster]	Out	0.364
ANSI / IEEE C95.1 1992 - SAFETY LIMIT Spatial Peak Uncontrolled Exposure/General Population						Muscle 1.6 W/kg (mW/g) averaged over 1 gram		

NOTES:

1. The test data reported are the worst-case SAR value with the antenna-head position set in a typical configuration. Test procedures used are according to FCC/OET Bulletin 65, Supp.C [July 2001].
 2. All modes of operation were investigated, and worst-case results are reported.
 3. Battery is fully charged for all readings. Standard batteries are the only options.
- | | | | | | | |
|---------------------------|-------------------------------------|------------------|-------------------------------------|------------------------|--------------------------|------------|
| *Power Measured | <input checked="" type="checkbox"/> | Conducted | <input type="checkbox"/> | ERP | <input type="checkbox"/> | EIRP |
| 4. SAR Measurement System | <input checked="" type="checkbox"/> | DASY4 | <input type="checkbox"/> | IDX | | |
| Phantom Configuration | <input type="checkbox"/> | Left Head | <input checked="" type="checkbox"/> | Flat Phantom | <input type="checkbox"/> | Right Head |
| 5. SAR Configuration | <input type="checkbox"/> | Head | <input checked="" type="checkbox"/> | Body | <input type="checkbox"/> | Hand |
| 6. Test Signal Call Mode | <input checked="" type="checkbox"/> | Manu. Test Codes | <input type="checkbox"/> | Base Station Simulator | | |
| 7. ##Test Configuration | <input type="checkbox"/> | With Holster | <input checked="" type="checkbox"/> | Without Holster | | |
8. Tissue parameters and temperatures are listed on the SAR plots.
 9. Both sides of the phone were tested and the worst-case side is reported.
 10. Liquid tissue depth is 15.1 cm. ± 0.1



Alfred Cirwihian
 Vice President Engineering

PCTEST SAR REPORT	 FCC CERTIFICATION			Reviewed by: Quality Manager
SAR Filename: 0506270475	Test Dates: June 27-29, 2005	Phone Type: Tri-Mode Dual-Band Phone	FCC ID: AEZSCP-4930	Page 31 of 36

SAR DATA SUMMARY (Continued)

Mixture Type: 1900MHz Muscle



14.15 MEASUREMENT RESULTS (PCS CDMA Body SAR w/o Holster)								
FREQUENCY		Modulation	Begin / End POWER [†]			Separation Distance (cm) ^{##}	Antenna Position	SAR (W/kg)
MHz	Ch.		(dBm)		Battery			
1851.25	0025	PCS CDMA	23.64	23.66	Standard	1.9 [w/o Holster]	In	0.893
1851.25	0025	PCS CDMA	23.66	23.69	Standard	1.9 [w/o Holster]	Out	1.150
1880.00	0600	PCS CDMA	23.63	23.65	Standard	1.9 [w/o Holster]	In	0.659
1880.00	0600	PCS CDMA	23.65	23.67	Standard	1.9 [w/o Holster]	Out	1.100
1908.75	1175	PCS CDMA	23.62	23.64	Standard	1.9 [w/o Holster]	In	0.606
1908.75	1175	PCS CDMA	23.64	23.63	Standard	1.9 [w/o Holster]	Out	0.783
ANSI / IEEE C95.1 1992 - SAFETY LIMIT Spatial Peak Uncontrolled Exposure/General Population						Muscle 1.6 W/kg (mW/g) averaged over 1 gram		

NOTES:

1. The test data reported are the worst-case SAR value with the antenna-head position set in a typical configuration. Test procedures used are according to FCC/OET Bulletin 65, Supp.C [July 2001].
 2. All modes of operation were investigated, and worst-case results are reported.
 3. Battery is fully charged for all readings. Standard batteries are the only options.
- | | | | | | | |
|---------------------------|-------------------------------------|------------------|-------------------------------------|------------------------|--------------------------|------------|
| *Power Measured | <input checked="" type="checkbox"/> | Conducted | <input type="checkbox"/> | ERP | <input type="checkbox"/> | EIRP |
| 4. SAR Measurement System | <input checked="" type="checkbox"/> | DASY4 | <input type="checkbox"/> | IDX | | |
| Phantom Configuration | <input type="checkbox"/> | Left Head | <input checked="" type="checkbox"/> | Flat Phantom | <input type="checkbox"/> | Right Head |
| 5. SAR Configuration | <input type="checkbox"/> | Head | <input checked="" type="checkbox"/> | Body | <input type="checkbox"/> | Hand |
| 6. Test Signal Call Mode | <input checked="" type="checkbox"/> | Manu. Test Codes | <input type="checkbox"/> | Base Station Simulator | | |
| 7. ##Test Configuration | <input type="checkbox"/> | With Holster | <input checked="" type="checkbox"/> | Without Holster | | |
8. Tissue parameters and temperatures are listed on the SAR plots.
 9. Both sides of the phone were tested and the worst-case side is reported.
 10. Liquid tissue depth is 15.1 cm. ± 0.1



Alfred Cirwithian
Vice President Engineering

PCTEST SAR REPORT	 FCC CERTIFICATION			Reviewed by: Quality Manager
SAR Filename: 0506270475	Test Dates: June 27-29, 2005	Phone Type: Tri-Mode Dual-Band Phone	FCC ID: AEZSCP-4930	Page 32 of 36

SAR DATA SUMMARY (Continued)

Mixture Type: 1900MHz Brain



14.16 MEASUREMENT RESULTS (PCS/ FACE/ Push-to-Talk)								
FREQUENCY		Modulation	Begin / End POWER [†]			Separation Distance (cm) ^{††}	Antenna Position	SAR (W/kg)
MHz	Ch.		(dBm)		Battery			
1880.00	0600	PCS CDMA	23.52	23.54	Standard	2.5	In	0.046
1880.00	0600	PCS CDMA	23.54	23.57	Standard	2.5	Out	0.061
ANSI / IEEE C95.1 1992 - SAFETY LIMIT Spatial Peak Uncontrolled Exposure/General Population						Brain 1.6 W/kg (mW/g) averaged over 1 gram		

NOTES:

1. The test data reported are the worst-case SAR value with the antenna-head position set in a typical configuration. Test procedures used are according to FCC/OET Bulletin 65, Supp.C [July 2001].
 2. All modes of operation were investigated, and worst-case results are reported.
 3. Battery is fully charged for all readings. Standard batteries are the only options.
- | | | | | | | |
|---------------------------|-------------------------------------|------------------|--------------------------|------------------------|--------------------------|------------|
| *Power Measured | <input checked="" type="checkbox"/> | Conducted | <input type="checkbox"/> | ERP | <input type="checkbox"/> | EIRP |
| 4. SAR Measurement System | <input checked="" type="checkbox"/> | DASY4 | <input type="checkbox"/> | IDX | | |
| Phantom Configuration | <input checked="" type="checkbox"/> | Left Head | <input type="checkbox"/> | Flat Phantom | <input type="checkbox"/> | Right Head |
| 5. SAR Configuration | <input checked="" type="checkbox"/> | Face | <input type="checkbox"/> | Body | <input type="checkbox"/> | Hand |
| 6. Test Signal Call Mode | <input checked="" type="checkbox"/> | Manu. Test Codes | <input type="checkbox"/> | Base Station Simulator | | |
7. Tissue parameters and temperatures are listed on the SAR plots.
 8. Liquid tissue depth is 15.1 cm. ± 0.1



Alfred Cirwithian
 Vice President Engineering

PCTEST SAR REPORT		FCC CERTIFICATION		Reviewed by: Quality Manager
SAR Filename: 0506270475	Test Dates: June 27-29, 2005	Phone Type: Tri-Mode Dual-Band Phone	FCC ID: AEZSCP-4930	Page 33 of 36

15. SAR TEST EQUIPMENT



Equipment Calibration

Table 15.1 Test Equipment Calibration

EQUIPMENT SPECIFICATIONS			
Type	Calibration Date	Serial Number	
Stäubli Robot RX60L	October 2004	599131-01	
Stäubli Robot Controller	October 2004	PCT592	
Stäubli Teach Pendant (Joystick)	October 2004	3323-00161	
Micron Computer, 450 MHz Pentium III, Windows NT	October 2004	PCT577	
SPEAG EDC3	October 2004	321	
SPEAG DAE4	October 2004	637	
SPEAG E-Field Probe EX3DV4	October 2004	3550	
SPEAG Dummy Probe	October 2004	PCT583	
SPEAG SAM Twin Phantom V4.0	October 2004	PCT666	
SPEAG Light Alignment Sensor	October 2004	205	
PCTEST Validation Dipole D300V2	September 2004	PCT301	
SPEAG Validation Dipole D835V2	June 2005	PCT512	
SPEAG Validation Dipole D1900V2	June 2005	PCT613	
Brain Equivalent Matter (300MHz)	June 2005	PCTBEM601	
Brain Equivalent Matter (835MHz)	June 2005	PCTBEM101	
Brain Equivalent Matter (1900MHz)	June 2005	PCTBEM301	
Muscle Equivalent Matter (300MHz)	June 2005	PCTMEM701	
Muscle Equivalent Matter (835MHz)	June 2005	PCTMEM201	
Muscle Equivalent Matter (1900MHz)	June 2005	PCTMEM401	
Microwave Amp. Model: 5S1G4, (800MHz - 4.2GHz)	January 2005	22332	
Gigatronics 8651A Power Meter	January 2005	1835299	
HP-8648D (9kHz ~ 4GHz) Signal Generator	January 2005	PCT530	
Amplifier Research 5S1G4 Power Amp	January 2005	PCT540	
HP-8753E (30kHz ~ 3GHz) Network Analyzer	January 2005	PCT552	
HP85070B Dielectric Probe Kit	January 2005	PCT501	
Ambient Noise/Reflection, etc.	<12mW/kg/<3%of SAR	January 2005	Anechoic Room PCT01

NOTE:

The Efield probe was calibrated by SPEAG, by waveguide technique procedure. Dipole Validation measurement is performed by PCTEST Lab. before each test. The brain simulating material is calibrated by PCTEST using the dielectric probe system and network analyzer to determine the conductivity and permittivity (dielectric constant) of the brain-equivalent material.



PCTEST SAR REPORT			FCC CERTIFICATION		Reviewed by: Quality Manager
SAR Filename: 0506270475	Test Dates: June 27-29, 2005	Phone Type: Tri-Mode Dual-Band Phone	FCC ID: AEZSCP-4930		Page 34 of 36

16. CONCLUSION

Measurement Conclusion

The SAR measurement indicates that the EUT complies with the RF radiation exposure limits of the FCC. These measurements are taken to simulate the RF effects exposure under worst-case conditions. Precise laboratory measures were taken to assure repeatability of the tests. The tested device complies with the requirements in respect to all parameters subject to the test. The test results and statements relate only to the item(s) tested.

Please note that the absorption and distribution of electromagnetic energy in the body are very complex phenomena that depend on the mass, shape, and size of the body, the orientation of the body with respect to the field vectors, and the electrical properties of both the body and the environment. Other variables that may play a substantial role in possible biological effects are those that characterize the environment (e.g. ambient temperature, air velocity, relative humidity, and body insulation) and those that characterize the individual (e.g. age, gender, activity level, debilitation, or disease). Because innumerable factors may interact to determine the specific biological outcome of an exposure to electromagnetic fields, any protection guide shall consider maximal amplification of biological effects as a result of field-body interactions, environmental conditions, and physiological variables.[3]

PCTEST SAR REPORT	 FCC CERTIFICATION			Reviewed by: Quality Manager
SAR Filename: 0506270475	Test Dates: June 27-29, 2005	Phone Type: Tri-Mode Dual-Band Phone	FCC ID: AEZSCP-4930	Page 35 of 36

17. REFERENCES

- [1] Federal Communications Commission, ET Docket 93-62, Guidelines for Evaluating the Environmental Effects of Radiofrequency Radiation, Aug. 1996.
- [2] ANSI/IEEE C95.1 - 1991, *American National Standard safety levels with respect to human exposure to radio frequency electromagnetic fields, 300kHz to 100GHz*, New York: IEEE, Aug. 1992.
- [3] ANSI/IEEE C95.3 - 1991, *IEEE Recommended Practice for the Measurement of Potentially Hazardous Electromagnetic Fields - RF and Microwave*, New York: IEEE, 1992.
- [4] Federal Communications Commission, OET Bulletin 65 (Edition 97-01), Supplement C (Edition 01-01), *Evaluating Compliance with FCC Guidelines for Human Exposure to Radiofrequency Electromagnetic Fields*, July 2001.
- [5] IEEE Standards Coordinating Committee 34 – IEEE Std. P1528 D1.2 (April 2003), *Recommended Practice for Determining the Peak Spatial-Average Specific Absorption Rate (SAR) in the Human Body Due to Wireless Communications Devices*.
- [6] NCRP, National Council on Radiation Protection and Measurements, *Biological Effects and Exposure Criteria for RadioFrequency Electromagnetic Fields*, NCRP Report No. 86, 1986. Reprinted Feb. 1995.
- [7] T. Schmid, O. Egger, N. Kuster, *Automated E-field scanning system for dosimetric assessments*, IEEE Transaction on Microwave Theory and Techniques, vol. 44, Jan. 1996, pp. 105-113.
- [8] K. Pokovic, T. Schmid, N. Kuster, *Robust setup for precise calibration of E-field probes in tissue simulating liquids at mobile communications frequencies*, ICECOM97, Oct. 1997, pp. 120-124.
- [9] K. Poković, T. Schmid, and N. Kuster, *E-field Probe with improved isotropy in brain simulating liquids*, Proceedings of the ELMAR, Zadar, Croatia, June 23-25, 1996, pp. 172-175.
- [10] Schmid & Partner Engineering AG, Application Note: Data Storage and Evaluation, June 1998, p2.
- [11] V. Hombach, K. Meier, M. Burkhardt, E. Kuhn, N. Kuster, *The Dependence of EM Energy Absorption upon Human Head Modeling at 900 MHz*, IEEE Transaction on Microwave Theory and Techniques, vol. 44 no. 10, Oct. 1996, pp. 1865-1873.
- [12] N. Kuster and Q. Balzano, *Energy absorption mechanism by biological bodies in the near field of dipole antennas above 300MHz*, IEEE Transaction on Vehicular Technology, vol. 41, no. 1, Feb. 1992, pp. 17-23.
- [13] G. Hartsgrove, A. Kraszewski, A. Surowiec, *Simulated Biological Materials for Electromagnetic Radiation Absorption Studies*, University of Ottawa, Bioelectromagnetics, Canada: 1987, pp. 29-36.
- [14] Q. Balzano, O. Garay, T. Manning Jr., *Electromagnetic Energy Exposure of Simulated Users of Portable Cellular Telephones*, IEEE Transactions on Vehicular Technology, vol. 44, no.3, Aug. 1995.
- [15] W. Gander, *Computermathematick*, Birkhaeuser, Basel, 1992.
- [16] W.H. Press, S.A. Teukolsky, W.T. Vetterling, and B.P. Flannery, *Numerical Recepies in C*, The Art of Scientific Computing, Second edition, Cambridge University Press, 1992.
- [17] Federal Communications Commission, OET Bulletin 65, Evaluating Compliance with FCC Guidelines for Human Exposure to Radiofrequency Electromagnetic Fields. Supplement C, Dec. 1997.
- [18] N. Kuster, R. Kastle, T. Schmid, *Dosimetric evaluation of mobile communications equipment with known precision*, IEEE Transaction on Communications, vol. E80-B, no. 5, May 1997, pp. 645-652.
- [19] CENELEC CLC/SC111B, European Prestandard (prENV 50166-2), Human Exposure to Electromagnetic Fields High-frequency: 10kHz-300GHz, Jan. 1995.
- [20] Prof. Dr. Niels Kuster, ETH, Eidgenössische Technische Hochschule Zürich, Dosimetric Evaluation of the Cellular Phone.

PCTEST SAR REPORT	FCC CERTIFICATION		SANYO	Reviewed by: Quality Manager
SAR Filename: 0506270475	Test Dates: June 27-29, 2005	Phone Type: Tri-Mode Dual-Band Phone	FCC ID: AEZSCP-4930	Page 36 of 36

APPENDIX A: SAR TEST DATA

PCTEST ENGINEERING LABORATORY, INC.

DUT: Sanyo SCP-4930; Type: Tri Mode Mobile Phone; SN: F798E65C

Communication System: AMPS; Frequency: 836.49 MHz; Duty Cycle: 1:1

Medium: 835 Brain ($\sigma = 0.88$ mho/m, $\epsilon_r = 42.30$, $\rho = 1000$ kg/m³)

Phantom section: Right Section

Test Date: 06-27-2005; Ambient Temp: 23.6°C; Tissue Temp: 20.5°C

Probe: EX3DV4 - SN3550; ConvF(8.12, 8.12, 8.12); Calibrated: 10/26/2004

Sensor-Surface: 3mm (Mechanical Surface Detection)

Electronics: DAE4 Sn909; Calibrated: 3/31/2005

Phantom: SAM Main; Type: SAM 4.0; Serial: TP:1197

Measurement SW: DASY4, V4.5 Build 19; Postprocessing SW: SEMCAD, V1.8 Build 146

Touch, Ch.0383, Antenna Out, Standard Battery

Area Scan (7x17x1): Measurement grid: dx=15mm, dy=15mm

Zoom Scan (5x5x7)/Cube 0: Measurement grid: dx=8mm, dy=8mm, dz=5mm

Reference Value = 31.6 V/m

Peak SAR (extrapolated) = 1.13 W/kg

SAR(1 g) = 0.799 mW/g; SAR(10 g) = 0.576 mW/g

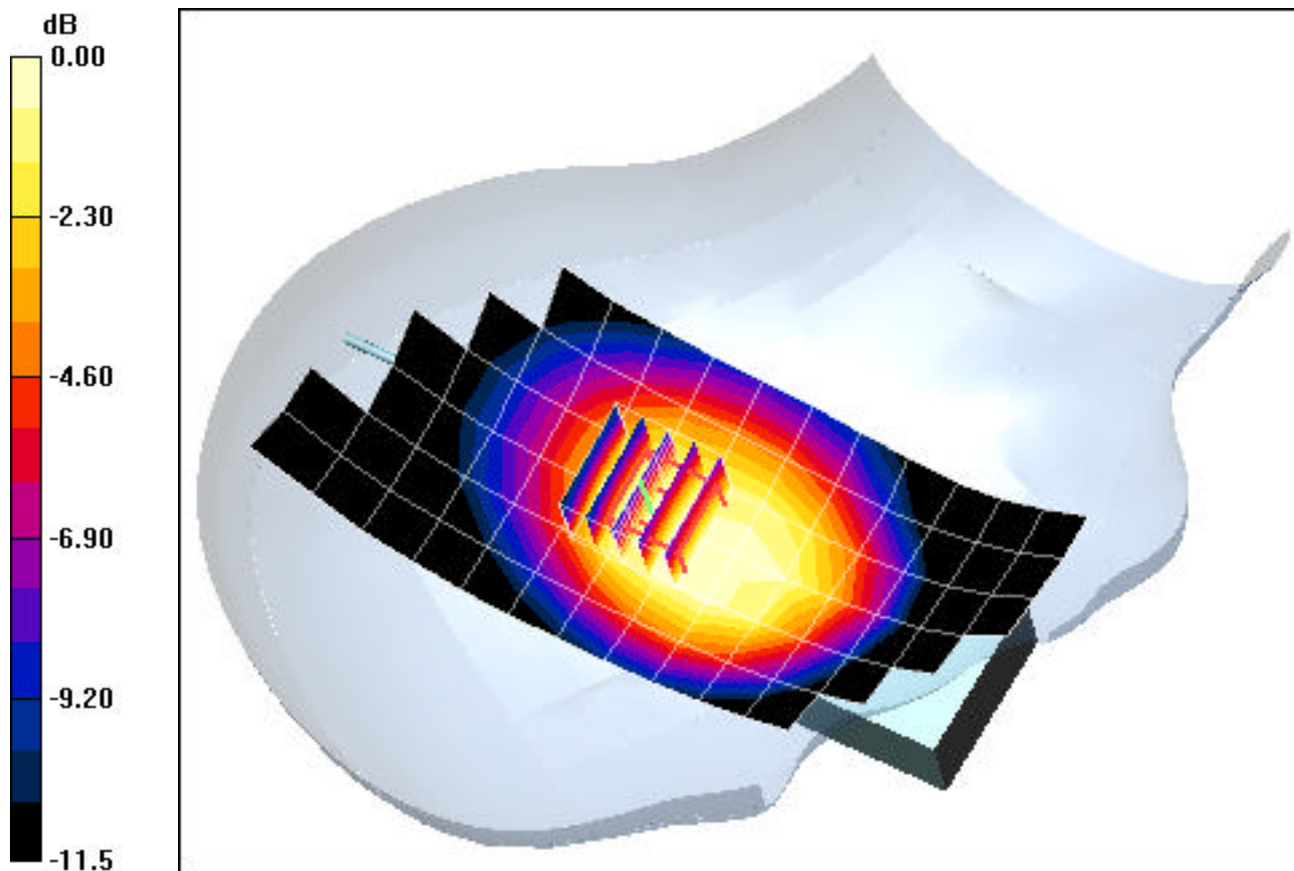

0 dB = 0.925mW/g

PCTEST ENGINEERING LABORATORY, INC.

DUT: Sanyo SCP-4930; Type: Tri Mode Mobile Phone; SN: F798E65C

Communication System: AMPS; Frequency: 836.49 MHz; Duty Cycle: 1:1

Medium: 835 Brain ($\sigma = 0.88$ mho/m, $\epsilon_r = 42.30$, $\rho = 1000$ kg/m³)

Phantom section: Right Section

Test Date: 06-27-2005; Ambient Temp: 23.6°C; Tissue Temp: 20.5°C

Probe: EX3DV4 - SN3550; ConvF(8.12, 8.12, 8.12); Calibrated: 10/26/2004

Sensor-Surface: 3mm (Mechanical Surface Detection)

Electronics: DAE4 Sn909; Calibrated: 3/31/2005

Phantom: SAM Main; Type: SAM 4.0; Serial: TP:1197

Measurement SW: DASY4, V4.5 Build 19; Postprocessing SW: SEMCAD, V1.8 Build 146

Tilt, Ch.0383, Antenna Out, Standard Battery

Area Scan (7x17x1): Measurement grid: dx=15mm, dy=15mm

Zoom Scan (5x5x7)/Cube 0: Measurement grid: dx=8mm, dy=8mm, dz=5mm

Reference Value = 28.3 V/m

Peak SAR (extrapolated) = 1.20 W/kg

SAR(1 g) = 0.782 mW/g; SAR(10 g) = 0.497 mW/g

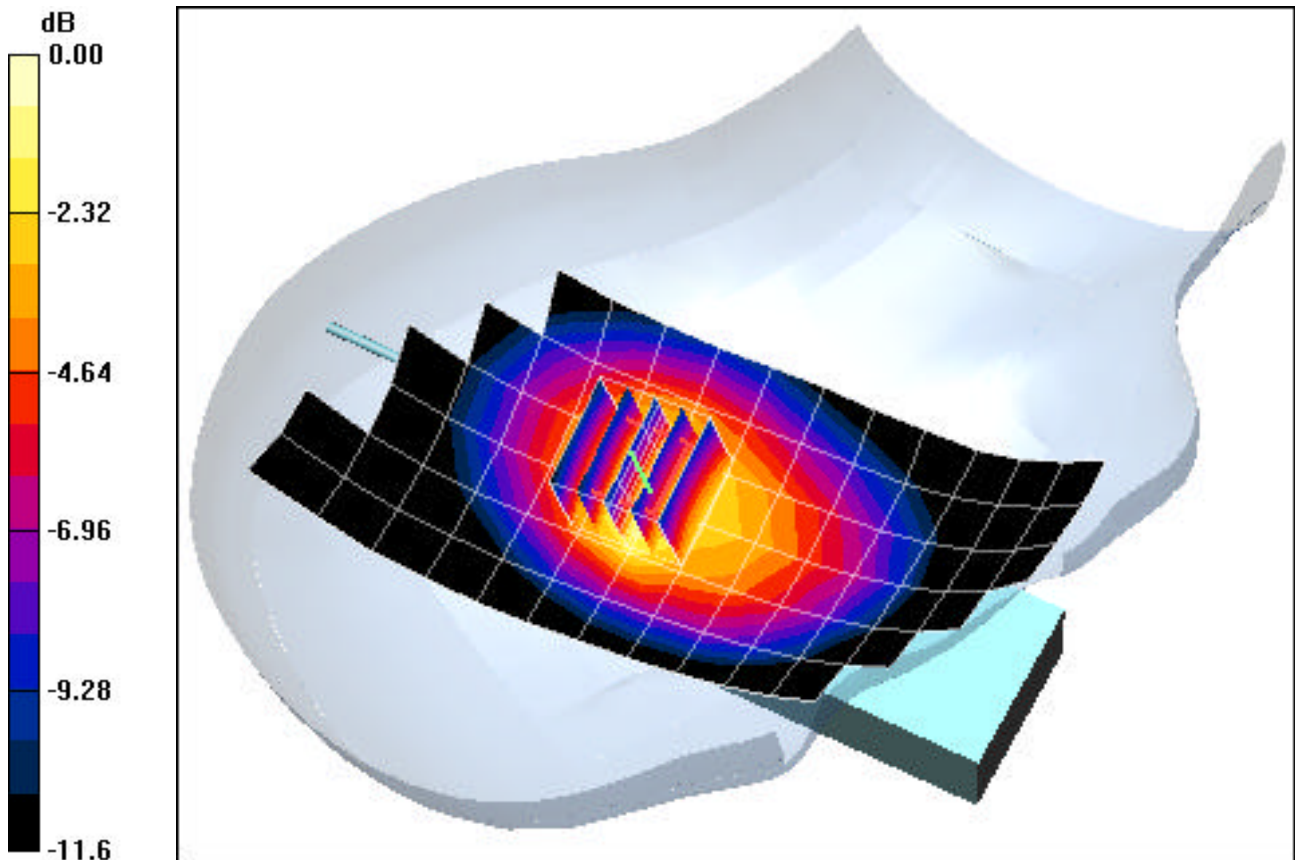

0 dB = 0.924mW/g

PCTEST ENGINEERING LABORATORY, INC.

DUT: Sanyo SCP-4930; Type: Tri Mode Mobile Phone; SN: F798E65C

Communication System: AMPS; Frequency: 824.04 MHz; Duty Cycle: 1:1

Medium: 835 Brain ($\sigma = 0.88$ mho/m, $\epsilon_r = 42.30$, $\rho = 1000$ kg/m³)

Phantom section: Left Section

Test Date: 06-27-2005; Ambient Temp: 23.6°C; Tissue Temp: 20.5°C

Probe: EX3DV4 - SN3550; ConvF(8.12, 8.12, 8.12); Calibrated: 10/26/2004

Sensor-Surface: 3mm (Mechanical Surface Detection)

Electronics: DAE4 Sn909; Calibrated: 3/31/2005

Phantom: SAM Main; Type: SAM 4.0; Serial: TP:1197

Measurement SW: DASY4, V4.5 Build 19; Postprocessing SW: SEMCAD, V1.8 Build 146

Touch, Ch.0991, Antenna In, Standard Battery

Area Scan (7x12x1): Measurement grid: dx=15mm, dy=15mm

Zoom Scan (5x5x7)/Cube 0: Measurement grid: dx=8mm, dy=8mm, dz=5mm

Reference Value = 33.8 V/m

Peak SAR (extrapolated) = 1.54 W/kg

SAR(1 g) = 1.01 mW/g; SAR(10 g) = 0.710 mW/g

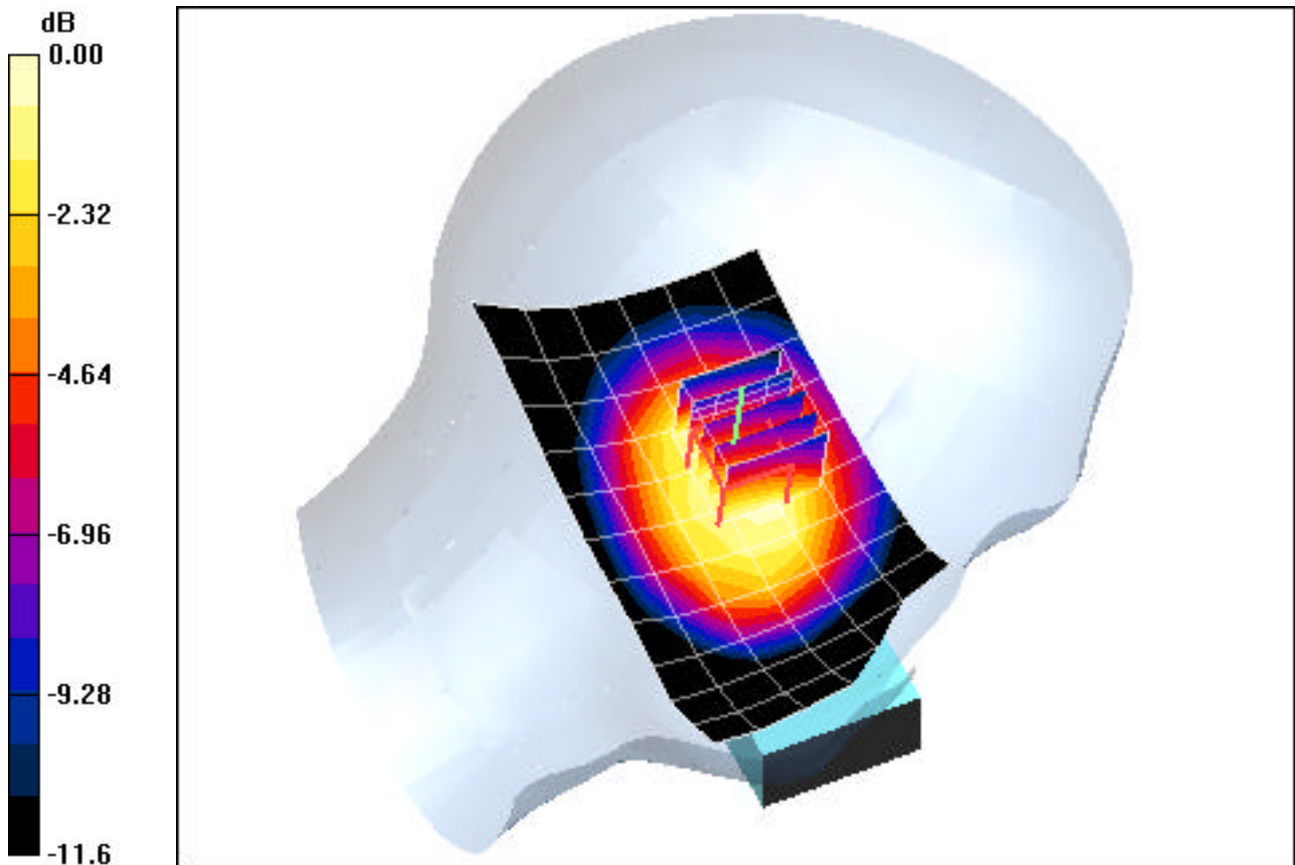

0 dB = 1.15mW/g

PCTEST ENGINEERING LABORATORY, INC.

DUT: Sanyo SCP-4930; Type: Tri Mode Mobile Phone; SN: F798E65C

Communication System: AMPS; Frequency: 824.04 MHz; Duty Cycle: 1:1

Medium: 835 Brain ($\sigma = 0.88$ mho/m, $\epsilon_r = 42.30$, $\rho = 1000$ kg/m³)

Phantom section: Left Section

Test Date: 06-27-2003; Ambient Temp: 23.6°C; Tissue Temp: 20.5°C

Probe: EX3DV4 - SN3550; ConvF(8.12, 8.12, 8.12); Calibrated: 10/26/2004

Sensor-Surface: 3mm (Mechanical Surface Detection)

Electronics: DAE4 Sn909; Calibrated: 3/31/2005

Phantom: SAM Main; Type: SAM 4.0; Serial: TP:1197

Measurement SW: DASY4, V4.5 Build 19; Postprocessing SW: SEMCAD, V1.8 Build 146

Tilt, Ch.0991, Antenna In, Standard Battery

Area Scan (7x12x1): Measurement grid: dx=15mm, dy=15mm

Zoom Scan (5x5x7)/Cube 0: Measurement grid: dx=8mm, dy=8mm, dz=5mm

Reference Value = 31.9 V/m

Peak SAR (extrapolated) = 1.62 W/kg

SAR(1 g) = 0.990 mW/g; SAR(10 g) = 0.609 mW/g

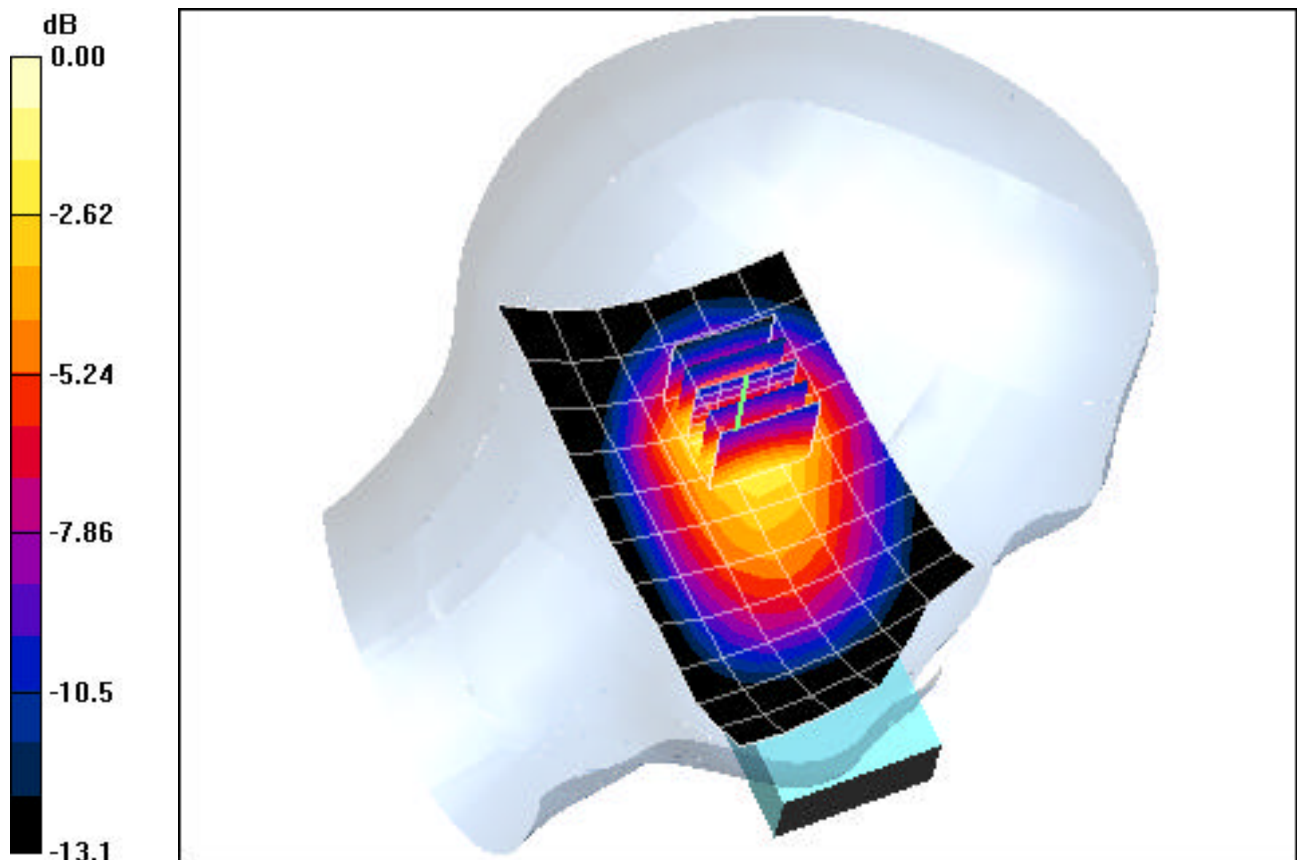

0 dB = 1.22mW/g

PCTEST ENGINEERING LABORATORY, INC.

DUT: Sanyo SCP-4930; Type: Tri Mode Mobile Phone; SN: F798E65C

Communication System: Cellular CDMA; Frequency: 836.49 MHz; Duty Cycle: 1:1

Medium: 835 Brain ($\sigma = 0.88$ mho/m, $\epsilon_r = 42.30$, $\rho = 1000$ kg/m³)

Phantom section: Right Section

Test Date: 06-27-2005; Ambient Temp: 23.6°C; Tissue Temp: 20.5°C

Probe: EX3DV4 - SN3550; ConvF(8.12, 8.12, 8.12); Calibrated: 10/26/2004

Sensor-Surface: 3mm (Mechanical Surface Detection)

Electronics: DAE4 Sn909; Calibrated: 3/31/2005

Phantom: SAM Main; Type: SAM 4.0; Serial: TP:1197

Measurement SW: DASY4, V4.5 Build 19; Postprocessing SW: SEMCAD, V1.8 Build 146

Touch, Ch.0383, Antenna Out, Standard Battery

Area Scan (6x17x1): Measurement grid: dx=15mm, dy=15mm

Zoom Scan (5x5x7)/Cube 0: Measurement grid: dx=8mm, dy=8mm, dz=5mm

Reference Value = 28.9 V/m

Peak SAR (extrapolated) = 0.927 W/kg

SAR(1 g) = 0.644 mW/g; SAR(10 g) = 0.448 mW/g

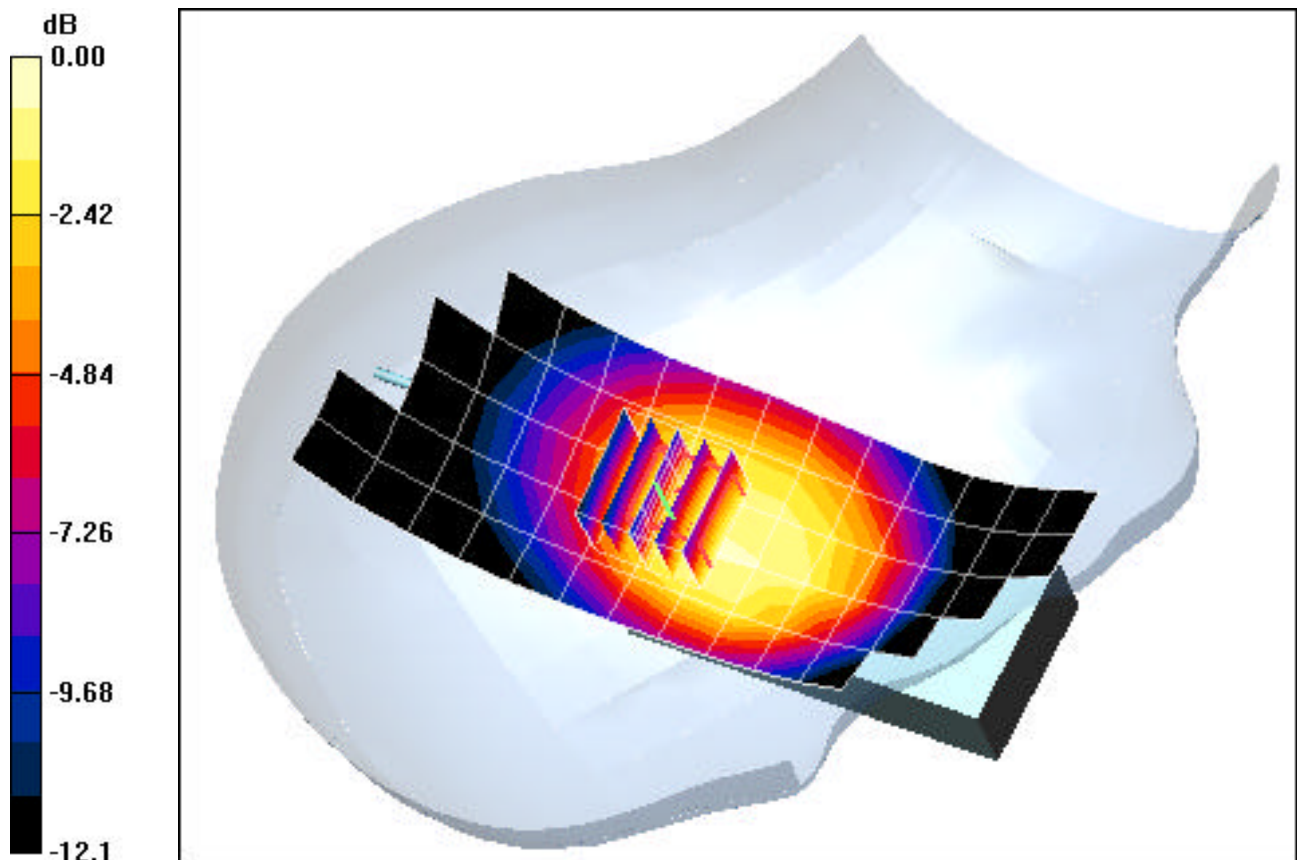

0 dB = 0.751mW/g

PCTEST ENGINEERING LABORATORY, INC.

DUT: Sanyo SCP-4930; Type: Tri Mode Mobile Phone; SN: F798E65C

Communication System: Cellular CDMA; Frequency: 836.49 MHz; Duty Cycle: 1:1

Medium: 835 Brain ($\sigma = 0.88$ mho/m, $\epsilon_r = 42.30$, $\rho = 1000$ kg/m³)

Phantom section: Right Section

Test Date: 06-27-2005; Ambient Temp: 23.6°C; Tissue Temp: 20.5°C

Probe: EX3DV4 - SN3550; ConvF(8.12, 8.12, 8.12); Calibrated: 10/26/2004

Sensor-Surface: 3mm (Mechanical Surface Detection)

Electronics: DAE4 Sn909; Calibrated: 3/31/2005

Phantom: SAM Main; Type: SAM 4.0; Serial: TP:1197

Measurement SW: DASY4, V4.5 Build 19; Postprocessing SW: SEMCAD, V1.8 Build 146

Tilt, Ch.0383, Antenna Out, Standard Battery

Area Scan (6x17x1): Measurement grid: dx=15mm, dy=15mm

Zoom Scan (5x5x7)/Cube 0: Measurement grid: dx=8mm, dy=8mm, dz=5mm

Reference Value = 26.4 V/m

Peak SAR (extrapolated) = 0.966 W/kg

SAR(1 g) = 0.624 mW/g; SAR(10 g) = 0.396 mW/g

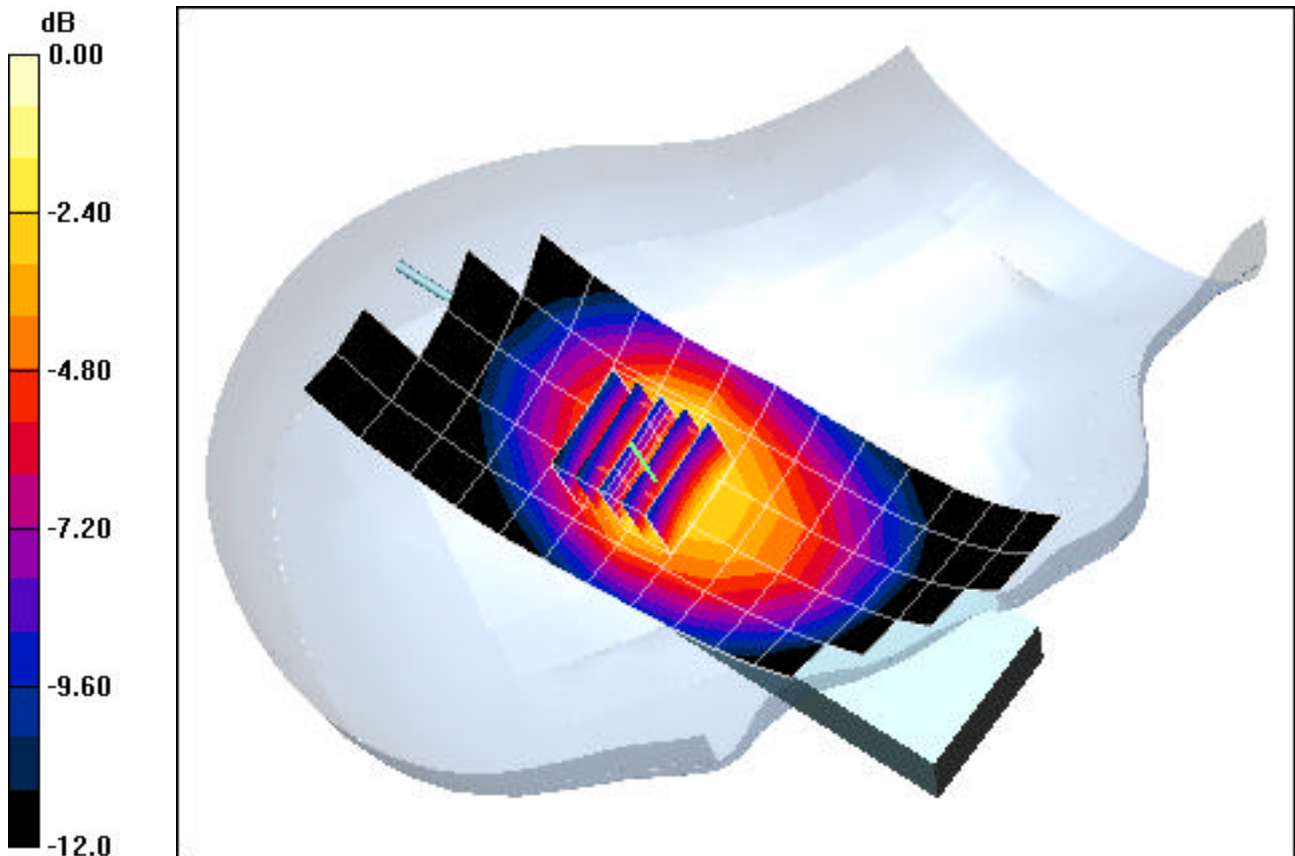

0 dB = 0.750mW/g

PCTEST ENGINEERING LABORATORY, INC.

DUT: Sanyo SCP-4930; Type: Tri Mode Mobile Phone; SN: F798E65C

Communication System: Cellular CDMA; Frequency: 848.31 MHz; Duty Cycle: 1:1

Medium: 835 Brain ($\sigma = 0.88$ mho/m, $\epsilon_r = 42.30$, $\rho = 1000$ kg/m³)

Phantom section: Left Section

Test Date: 06-27-2005; Ambient Temp: 23.6°C; Tissue Temp: 20.5°C

Probe: EX3DV4 - SN3550; ConvF(8.12, 8.12, 8.12); Calibrated: 10/26/2004

Sensor-Surface: 3mm (Mechanical Surface Detection)

Electronics: DAE4 Sn909; Calibrated: 3/31/2005

Phantom: SAM Main; Type: SAM 4.0; Serial: TP:1197

Measurement SW: DASY4, V4.5 Build 19; Postprocessing SW: SEMCAD, V1.8 Build 146

Touch, Ch.0383, Antenna Out, Standard Battery

Area Scan (7x17x1): Measurement grid: dx=15mm, dy=15mm

Zoom Scan (5x5x7)/Cube 0: Measurement grid: dx=8mm, dy=8mm, dz=5mm

Reference Value = 30.5 V/m

Peak SAR (extrapolated) = 1.19 W/kg

SAR(1 g) = 0.753 mW/g; SAR(10 g) = 0.498 mW/g

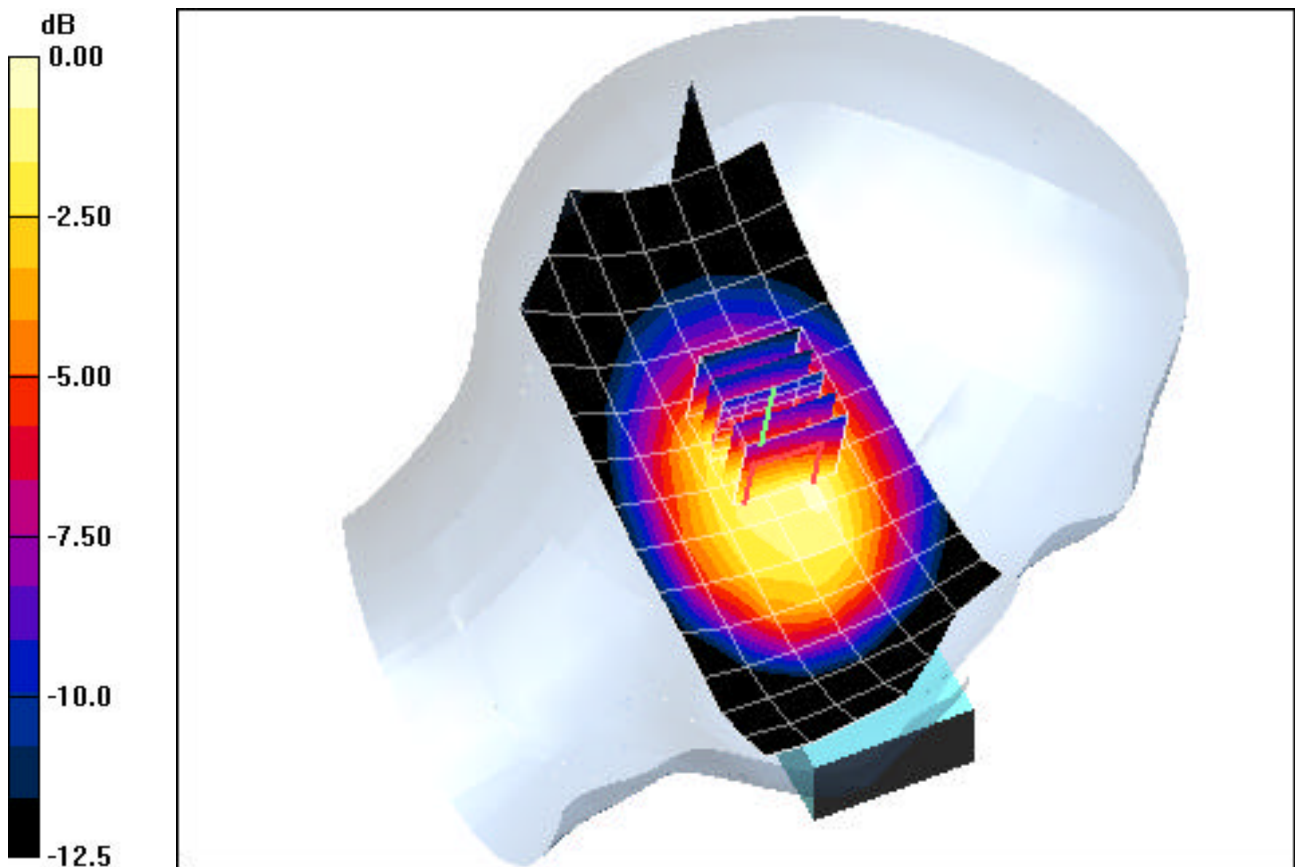

0 dB = 0.898mW/g

PCTEST ENGINEERING LABORATORY, INC.

DUT: Sanyo SCP-4930; Type: Tri Mode Mobile Phone; SN: F798E65C

Communication System: Cellular CDMA; Frequency: 848.31 MHz; Duty Cycle: 1:1

Medium: 835 Brain ($\sigma = 0.88$ mho/m, $\epsilon_r = 42.30$, $\rho = 1000$ kg/m³)

Phantom section: Left Section

Test Date: 06-27-2005; Ambient Temp: 23.6°C; Tissue Temp: 20.5°C

Probe: EX3DV4 - SN3550; ConvF(8.12, 8.12, 8.12); Calibrated: 10/26/2004

Sensor-Surface: 3mm (Mechanical Surface Detection)

Electronics: DAE4 Sn909; Calibrated: 3/31/2005

Phantom: SAM Main; Type: SAM 4.0; Serial: TP:1197

Measurement SW: DASY4, V4.5 Build 19; Postprocessing SW: SEMCAD, V1.8 Build 146

Tilt, Ch.0383, Antenna Out, Standard Battery

Area Scan (7x17x1): Measurement grid: dx=15mm, dy=15mm

Zoom Scan (5x5x7)/Cube 0: Measurement grid: dx=8mm, dy=8mm, dz=5mm

Reference Value = 28.3 V/m

Peak SAR (extrapolated) = 1.11 W/kg

SAR(1 g) = 0.704 mW/g; SAR(10 g) = 0.440 mW/g

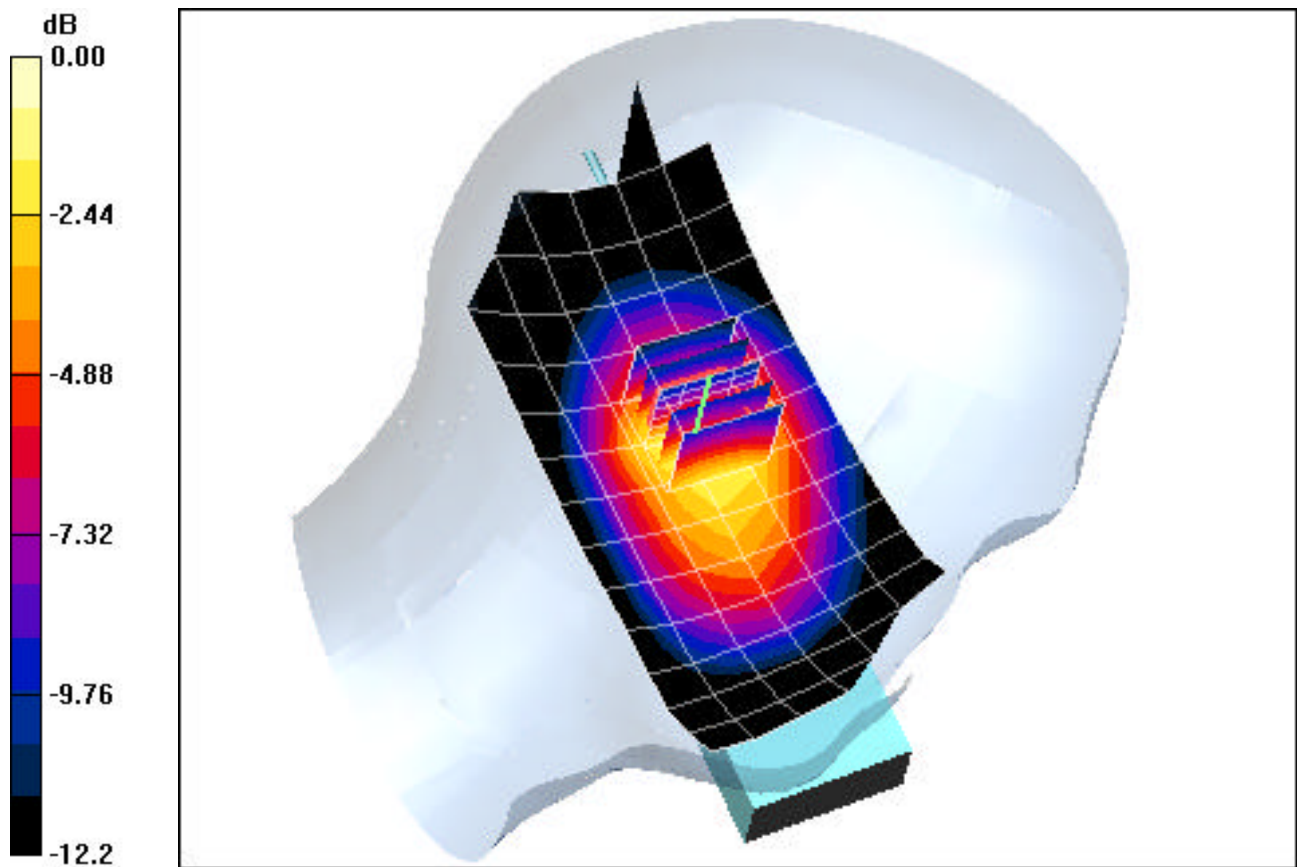

0 dB = 0.844mW/g

PCTEST ENGINEERING LABORATORY, INC.

DUT: Sanyo SCP-4930; Type: Tri Mode Mobile Phone; SN: F798E65C

Communication System: PCS CDMA; Frequency: 1880 MHz; Duty Cycle: 1:1

Medium: 1900 Brain ($\sigma = 1.36$ mho/m, $\epsilon_r = 41.60$, $\rho = 1000$ kg/m³)

Phantom section: Right Section

Test Date: 06-28-2005; Ambient Temp: 23.8°C; Tissue Temp: 20.2°C

Probe: EX3DV4 - SN3550; ConvF(6.75, 6.75, 6.75); Calibrated: 10/26/2004

Sensor-Surface: 3mm (Mechanical Surface Detection)

Electronics: DAE4 Sn909; Calibrated: 3/31/2005

Phantom: SAM Sub; Type: SAM 4.0; Serial: TP:1357

Measurement SW: DASY4, V4.5 Build 19; Postprocessing SW: SEMCAD, V1.8 Build 146

Touch, Ch.0600, Antenna Out, Standard Battery

Area Scan (7x17x1): Measurement grid: dx=15mm, dy=15mm

Zoom Scan (5x5x7)/Cube 0: Measurement grid: dx=8mm, dy=8mm, dz=5mm

Reference Value = 10.1 V/m

Peak SAR (extrapolated) = 0.309 W/kg

SAR(1 g) = 0.203 mW/g; SAR(10 g) = 0.113 mW/g

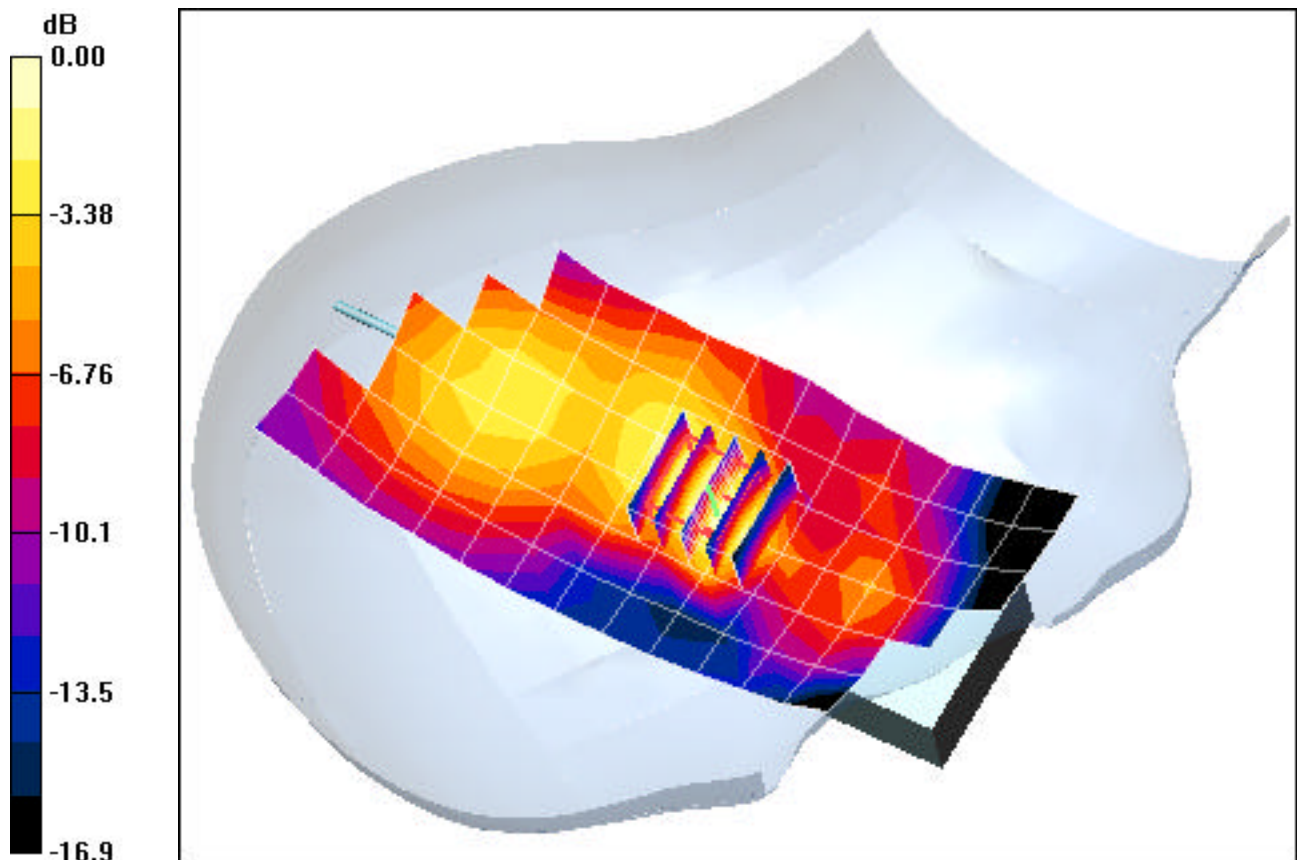

0 dB = 0.238mW/g

PCTEST ENGINEERING LABORATORY, INC.

DUT: Sanyo SCP-4930; Type: Tri Mode Mobile Phone; SN: F798E65C

Communication System: PCS CDMA; Frequency: 1880 MHz; Duty Cycle: 1:1

Medium: 1900 Brain ($\sigma = 1.36$ mho/m, $\epsilon_r = 41.60$, $\rho = 1000$ kg/m³)

Phantom section: Right Section

Test Date: 06-28-2005; Ambient Temp: 23.8°C; Tissue Temp: 20.2°C

Probe: EX3DV4 - SN3550; ConvF(6.75, 6.75, 6.75); Calibrated: 10/26/2004

Sensor-Surface: 3mm (Mechanical Surface Detection)

Electronics: DAE4 Sn909; Calibrated: 3/31/2005

Phantom: SAM Sub; Type: SAM 4.0; Serial: TP:1357

Measurement SW: DASY4, V4.5 Build 19; Postprocessing SW: SEMCAD, V1.8 Build 146

Tilt, Ch.0600, Antenna Out, Standard Battery

Area Scan (7x17x1): Measurement grid: dx=15mm, dy=15mm

Zoom Scan (5x5x7)/Cube 0: Measurement grid: dx=8mm, dy=8mm, dz=5mm

Reference Value = 11.2 V/m

Peak SAR (extrapolated) = 0.267 W/kg

SAR(1 g) = 0.186 mW/g; SAR(10 g) = 0.116 mW/g

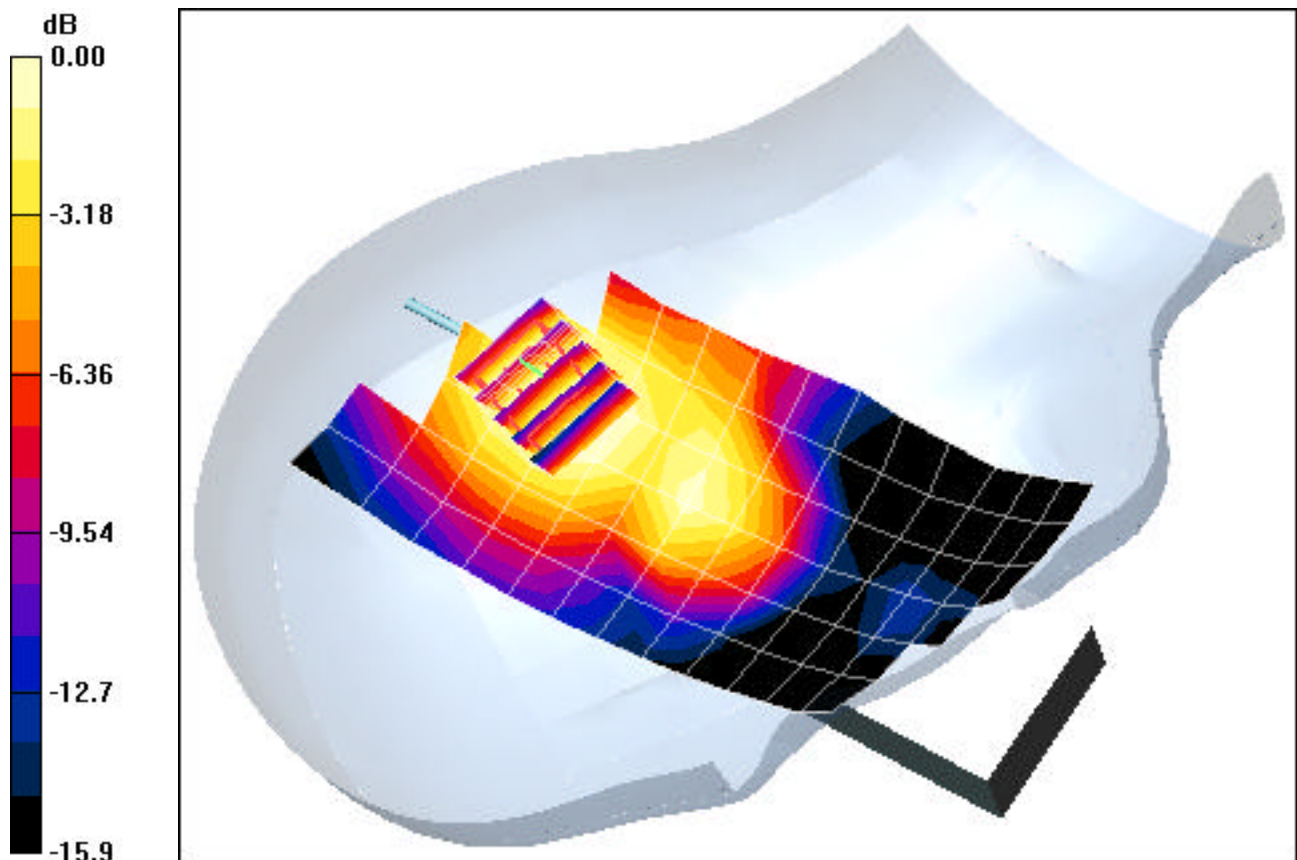

0 dB = 0.214mW/g

PCTEST ENGINEERING LABORATORY, INC.

DUT: Sanyo SCP-4930; Type: Tri Mode Mobile Phone; SN: F798E65C

Communication System: PCS CDMA; Frequency: 1880 MHz; Duty Cycle: 1:1

Medium: 1900 Brain ($\sigma = 1.36$ mho/m, $\epsilon_r = 41.60$, $\rho = 1000$ kg/m³)

Phantom section: Left Section

Test Date: 06-28-2005; Ambient Temp: 23.8°C; Tissue Temp: 20.2°C

Probe: EX3DV4 - SN3550; ConvF(6.75, 6.75, 6.75); Calibrated: 10/26/2004

Sensor-Surface: 3mm (Mechanical Surface Detection)

Electronics: DAE4 Sn909; Calibrated: 3/31/2005

Phantom: SAM Sub; Type: SAM 4.0; Serial: TP:1357

Measurement SW: DASY4, V4.5 Build 19; Postprocessing SW: SEMCAD, V1.8 Build 146

Touch, Ch.0600, Antenna Out, Standard Battery

Area Scan (7x17x1): Measurement grid: dx=15mm, dy=15mm

Zoom Scan (5x5x7)/Cube 0: Measurement grid: dx=8mm, dy=8mm, dz=5mm

Reference Value = 10.9 V/m

Peak SAR (extrapolated) = 0.523 W/kg

SAR(1 g) = 0.374 mW/g; SAR(10 g) = 0.236 mW/g

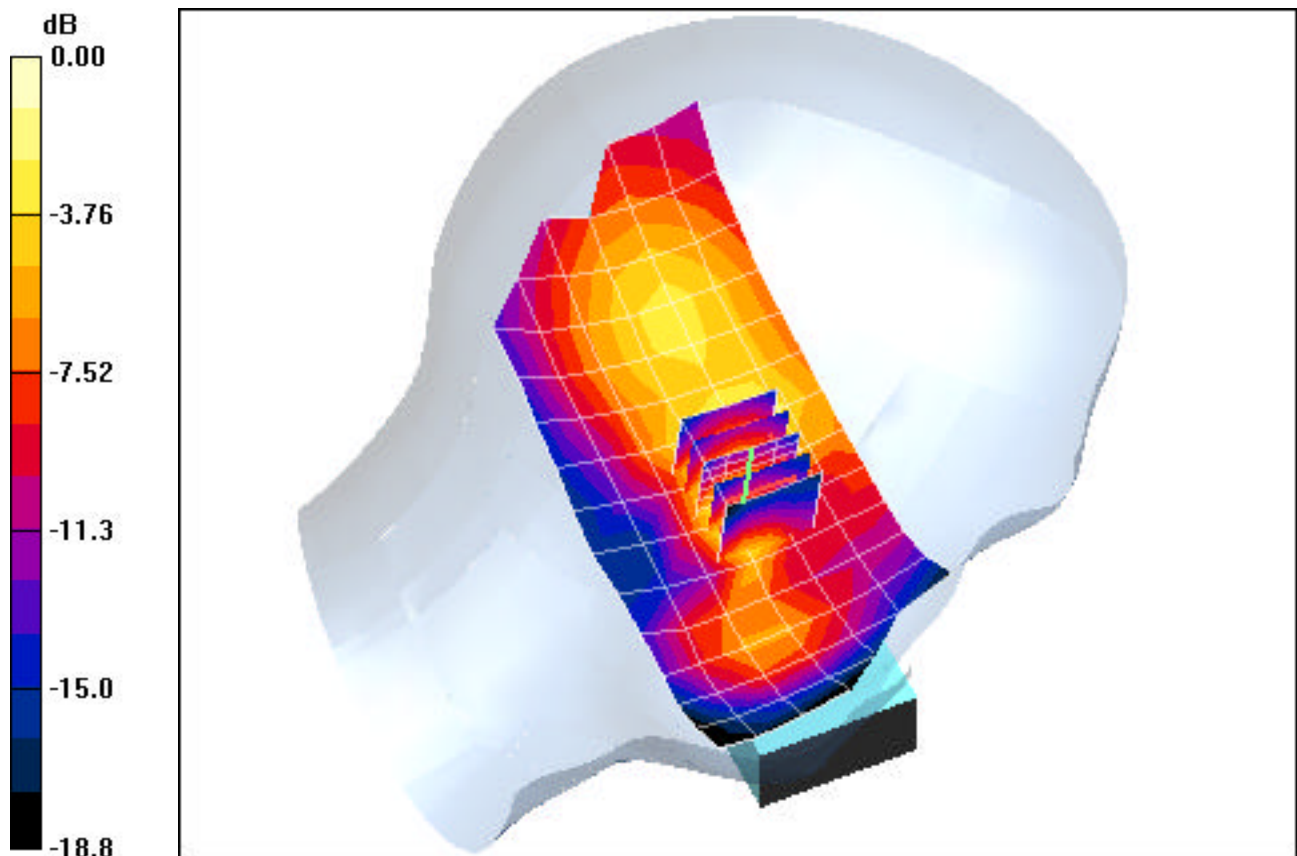

0 dB = 0.427mW/g

PCTEST ENGINEERING LABORATORY, INC.

DUT: Sanyo SCP-4930; Type: Tri Mode Mobile ; SN: F798E65C

Communication System: PCS CDMA; Frequency: 1880 MHz; Duty Cycle: 1:1

Medium: 1900 Brain ($\sigma = 1.36$ mho/m, $\epsilon_r = 41.60$, $\rho = 1000$ kg/m³)

Phantom section: Left Section

Test Date: 06-28-2005; Ambient Temp: 23.8°C; Tissue Temp: 20.2°C

Probe: EX3DV4 - SN3550; ConvF(6.75, 6.75, 6.75); Calibrated: 10/26/2004

Sensor-Surface: 3mm (Mechanical Surface Detection)

Electronics: DAE4 Sn909; Calibrated: 3/31/2005

Phantom: SAM Sub; Type: SAM 4.0; Serial: TP:1357

Measurement SW: DASY4, V4.5 Build 19; Postprocessing SW: SEMCAD, V1.8 Build 146

Tilt, Ch.0600, Antenna Out, Standard Battery

Area Scan (7x17x1): Measurement grid: dx=15mm, dy=15mm

Zoom Scan (5x5x7)/Cube 0: Measurement grid: dx=8mm, dy=8mm, dz=5mm

Reference Value = 14.0 V/m

Peak SAR (extrapolated) = 0.496 W/kg

SAR(1 g) = 0.329 mW/g; SAR(10 g) = 0.237 mW/g

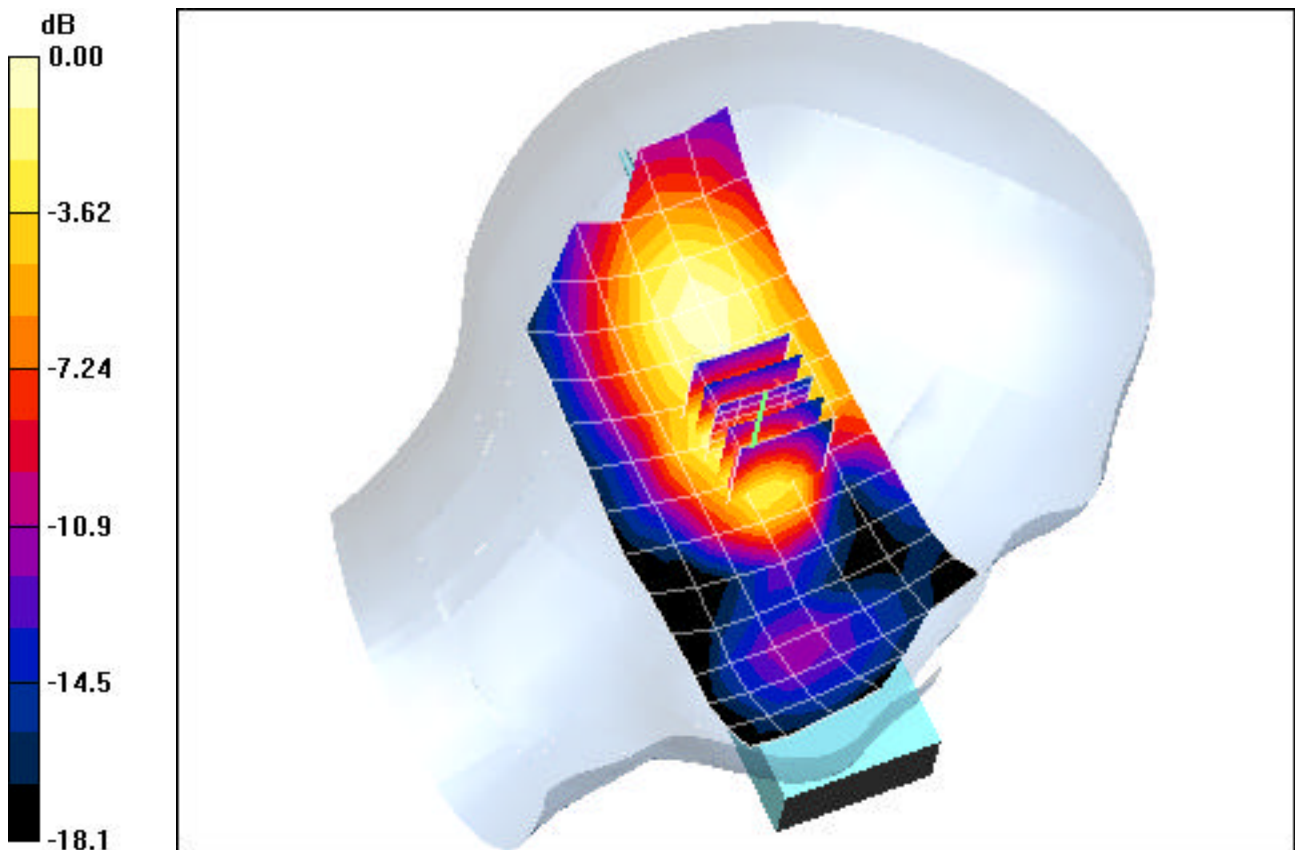

0 dB = 0.425mW/g

PCTEST ENGINEERING LABORATORY, INC.

DUT: Sanyo SCP-4930; Type: Tri Mode Mobile Phone; SN: F798E65C

Communication System: AMPS; Frequency: 836.49 MHz; Duty Cycle: 1:1

Medium: 835 Muscle ($\sigma = 0.98$ mho/m, $\epsilon_r = 53.0$, $\rho = 1000$ kg/m³)

Phantom section: Flat Section: Space: 1.9cm. from DUT to Flat Phantom

Test Date: 06-28-2005; Ambient Temp: 23.8°C; Tissue Temp: 20.6°C

Probe: EX3DV4 - SN3550; ConvF(7.99, 7.99, 7.99); Calibrated: 10/26/2004

Sensor-Surface: 3mm (Mechanical Surface Detection)

Electronics: DAE4 Sn909; Calibrated: 3/31/2005

Phantom: SAM Sub; Type: SAM 4.0; Serial: TP:1357

Measurement SW: DASY4, V4.5 Build 19; Postprocessing SW: SEMCAD, V1.8 Build 146

Body, Ch.0383, Antenna Out, Standard Battery

Area Scan (7x17x1): Measurement grid: dx=15mm, dy=15mm

Zoom Scan (5x5x7)/Cube 0: Measurement grid: dx=8mm, dy=8mm, dz=5mm

Reference Value = 15.5 V/m

Peak SAR (extrapolated) = 0.658 W/kg

SAR(1 g) = 0.516 mW/g; SAR(10 g) = 0.397 mW/g

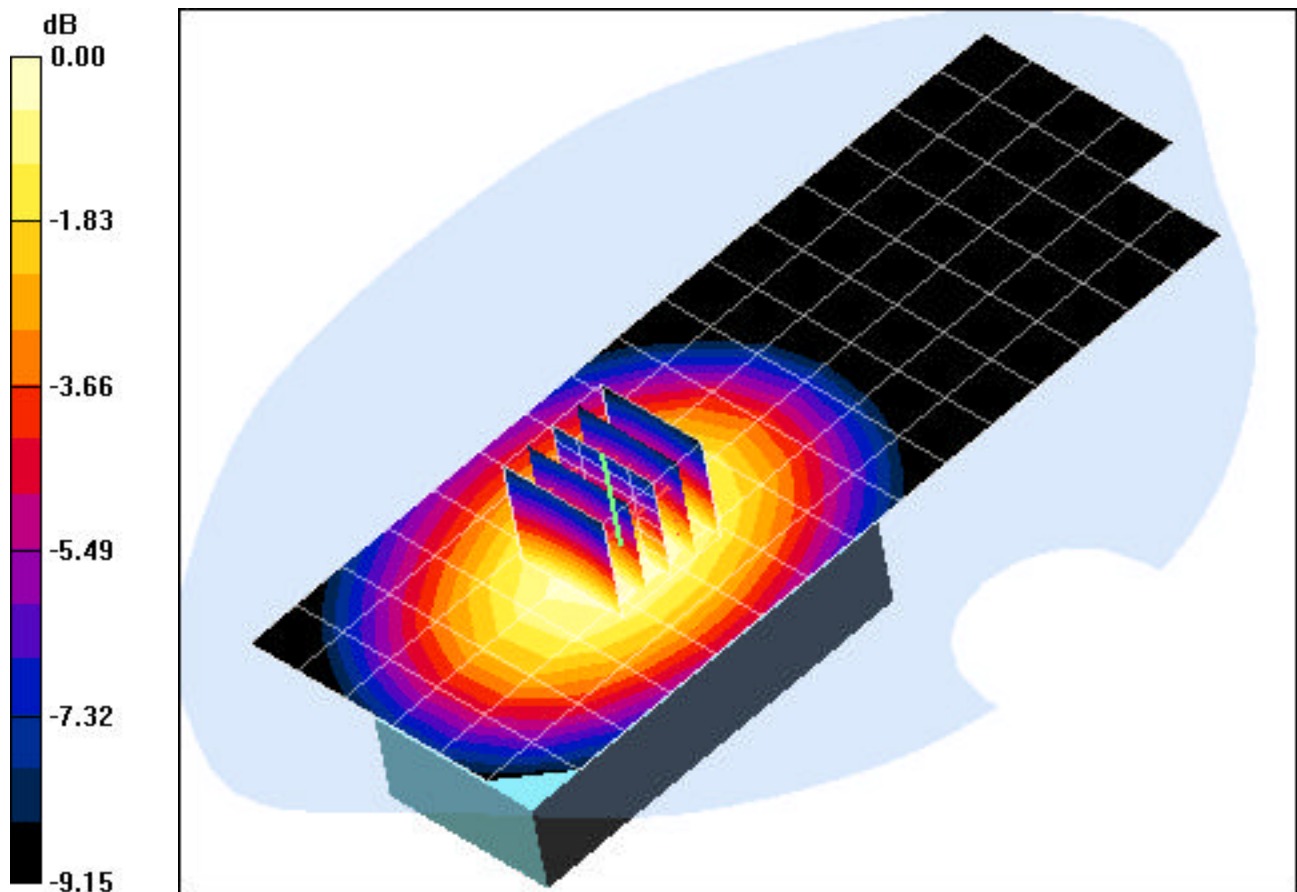

0 dB = 0.642mW/g

PCTEST ENGINEERING LABORATORY, INC.

DUT: Sanyo SCP-4930; Type: Tri Mode Mobile Phone; SN: F798E65C

Communication System: Cellular CDMA; Frequency: 836.49 MHz; Duty Cycle: 1:1

Medium: 835 Muscle ($\sigma = 0.98$ mho/m, $\epsilon_r = 53.0$, $\rho = 1000$ kg/m³)

Phantom section: Flat Section; Space: 1.9cm. from DUT to Flat Phantom

Test Date: 06-28-2005; Ambient Temp: 23.8°C; Tissue Temp: 20.6°C

Probe: EX3DV4 - SN3550; ConvF(7.99, 7.99, 7.99); Calibrated: 10/26/2004

Sensor-Surface: 3mm (Mechanical Surface Detection)

Electronics: DAE4 Sn909; Calibrated: 3/31/2005

Phantom: SAM Sub; Type: SAM 4.0; Serial: TP:1357

Measurement SW: DASY4, V4.5 Build 19; Postprocessing SW: SEMCAD, V1.8 Build 146

Body, Ch.0383, Antenna Out, Standard Battery

Area Scan (7x17x1): Measurement grid: dx=15mm, dy=15mm

Zoom Scan (5x5x7)/Cube 0: Measurement grid: dx=8mm, dy=8mm, dz=5mm

Reference Value = 16.0 V/m

Peak SAR (extrapolated) = 0.479 W/kg

SAR(1 g) = 0.364 mW/g; SAR(10 g) = 0.282 mW/g

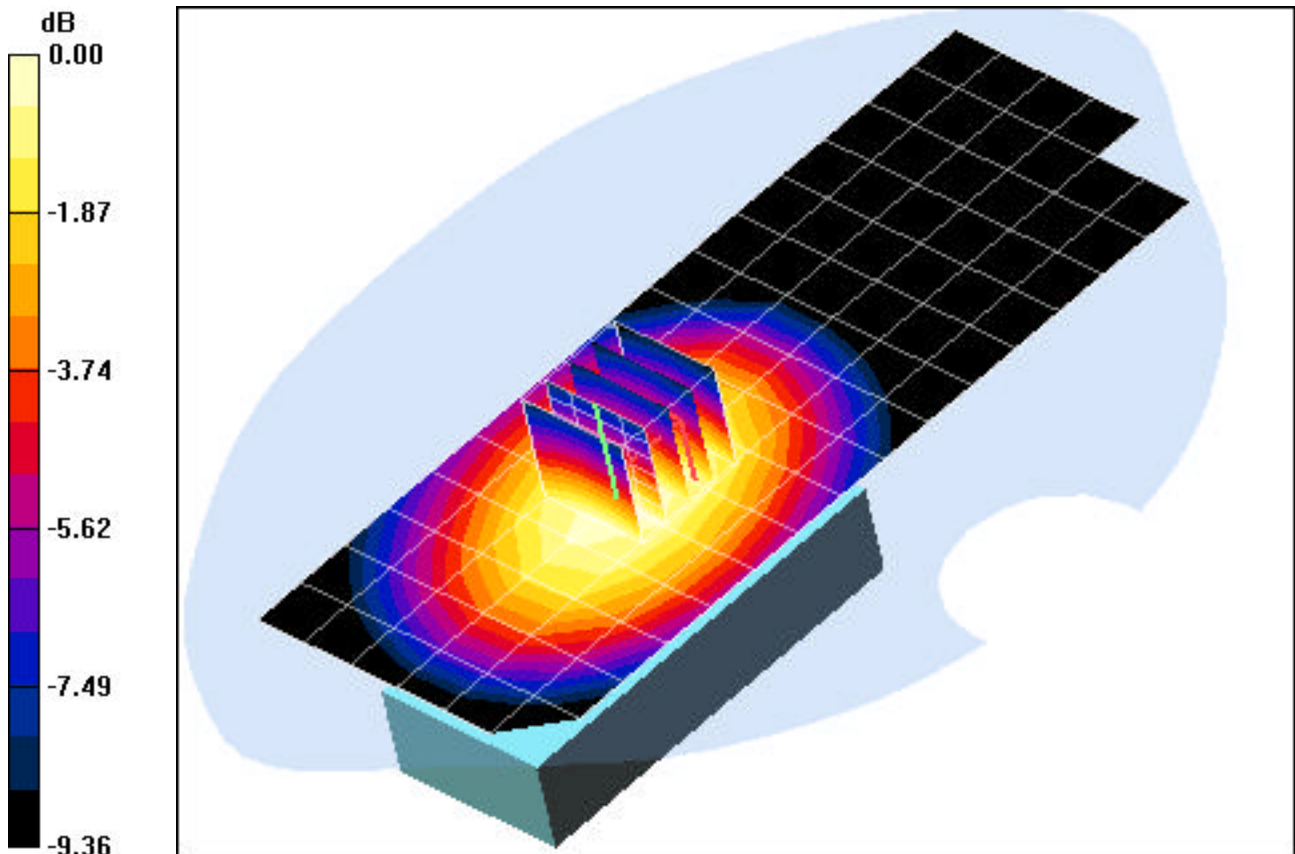

0 dB = 0.394mW/g

PCTEST ENGINEERING LABORATORY, INC.

DUT: Sanyo SCP-4930; Type: Tri Mode Mobile Phone; SN: F798E65C

Communication System: PCS CDMA; Frequency: 1851.25 MHz; Duty Cycle: 1:1

Medium: 1900 Muscle ($\sigma = 1.58$ mho/m, $\epsilon_r = 53.20$, $\rho = 1000$ kg/m³)

Phantom section: Flat Section; Space: 1.9cm. from DUT to Flat Phantom

Test Date: 06-28-2005; Ambient Temp: 23.8°C; Tissue Temp: 20.6°C

Probe: EX3DV4 - SN3550; ConvF(6.35, 6.35, 6.35); Calibrated: 10/26/2004

Sensor-Surface: 3mm (Mechanical Surface Detection)

Electronics: DAE4 Sn909; Calibrated: 3/31/2005

Phantom: SAM Main; Type: SAM 4.0; Serial: TP:1197

Measurement SW: DASY4, V4.5 Build 19; Postprocessing SW: SEMCAD, V1.8 Build 146

Body, Ch.0025, Antenna Out, Standard Battery

Area Scan (7x17x1): Measurement grid: dx=15mm, dy=15mm

Zoom Scan (5x5x7)/Cube 0: Measurement grid: dx=8mm, dy=8mm, dz=5mm

Reference Value = 13.2 V/m

Peak SAR (extrapolated) = 1.78 W/kg

SAR(1 g) = 1.15 mW/g; SAR(10 g) = 0.694 mW/g

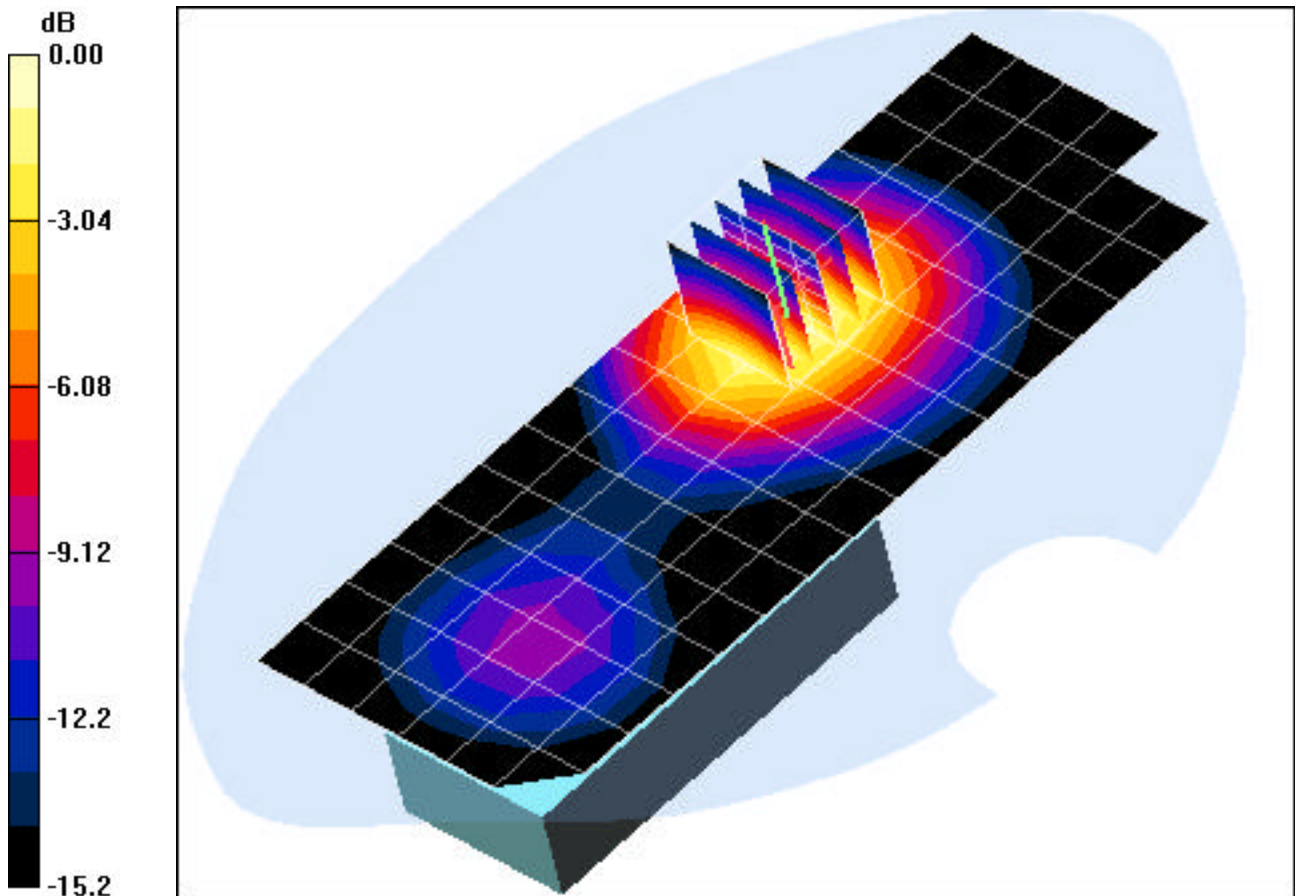

0 dB = 1.38mW/g

PCTEST ENGINEERING LABORATORY, INC.

DUT: Sanyo SCP-4930; Type: Tri Mode Mobile Phone; SN: F798E65C

Communication System: PCS CDMA; Frequency: 1880 MHz; Duty Cycle: 1:1

Medium: 1900 Brain ($\sigma = 1.36$ mho/m, $\epsilon_r = 41.60$, $\rho = 1000$ kg/m³)

Phantom section: Flat Section; Space: 2.5cm. from DUT to Flat Phantom

Test Date: 06-29-2005; Ambient Temp: 23.9°C; Tissue Temp: 20.4°C

Probe: EX3DV4 - SN3550; ConvF(6.75, 6.75, 6.75); Calibrated: 10/26/2004

Sensor-Surface: 3mm (Mechanical Surface Detection)

Electronics: DAE4 Sn909; Calibrated: 3/31/2005

Phantom: SAM Main; Type: SAM 4.0; Serial: TP:1197

Measurement SW: DASY4, V4.5 Build 19; Postprocessing SW: SEMCAD, V1.8 Build 146

Face, Ch.0600, Antenna Out, Standard Battery

Area Scan (7x17x1): Measurement grid: dx=15mm, dy=15mm

Zoom Scan (5x5x7)/Cube 0: Measurement grid: dx=8mm, dy=8mm, dz=5mm

Reference Value = 5.51 V/m

Peak SAR (extrapolated) = 0.089 W/kg

SAR(1 g) = 0.061 mW/g; SAR(10 g) = 0.041 mW/g

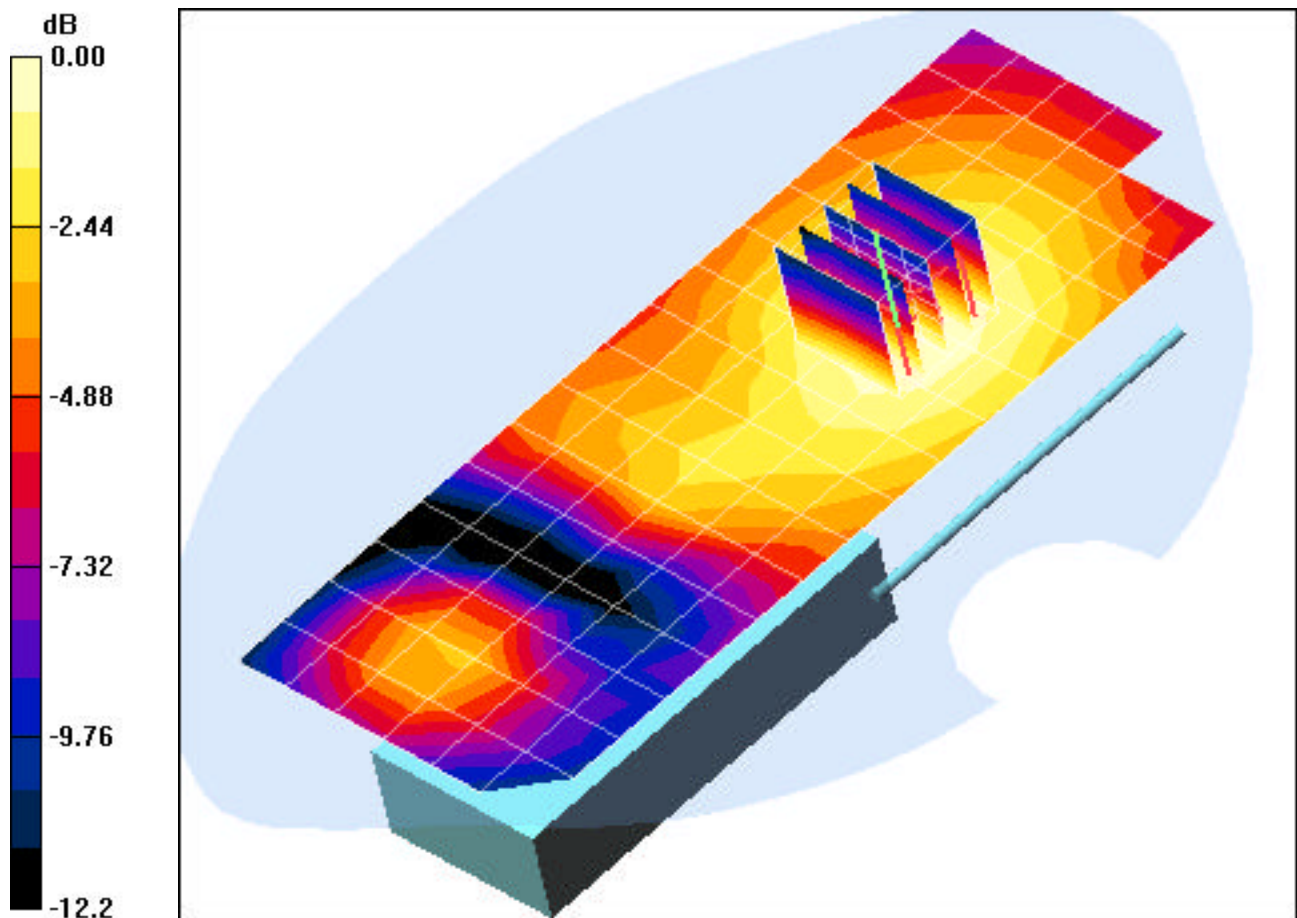

0 dB = 0.070mW/g

PCTEST ENGINEERING LABORATORY, INC.

DUT: Sanyo SCP-4930; Type: Tri Mode Mobile Phone; SN: F798E65C

Communication System: AMPS; Frequency: 824.04 MHz; Duty Cycle: 1:1

Medium: 835 Brain ($\sigma = 0.88$ mho/m, $\epsilon_r = 42.30$, $\rho = 1000$ kg/m³)

Phantom section: Left Section

Test Date: 06-27-2005; Ambient Temp: 23.6°C; Tissue Temp: 20.5°C

Probe: EX3DV4 - SN3550; ConvF(8.12, 8.12, 8.12); Calibrated: 10/26/2004

Sensor-Surface: 3mm (Mechanical Surface Detection)

Electronics: DAE4 Sn909; Calibrated: 3/31/2005

Phantom: SAM Main; Type: SAM 4.0; Serial: TP:1197

Measurement SW: DASY4, V4.5 Build 19; Postprocessing SW: SEMCAD, V1.8 Build 146

Touch, Ch.0991, Antenna In, Standard Battery

Area Scan (7x12x1): Measurement grid: dx=15mm, dy=15mm

Zoom Scan (5x5x7)/Cube 0: Measurement grid: dx=8mm, dy=8mm, dz=5mm

Reference Value = 33.8 V/m

Peak SAR (extrapolated) = 1.54 W/kg

SAR(1 g) = 1.01 mW/g; SAR(10 g) = 0.710 mW/g

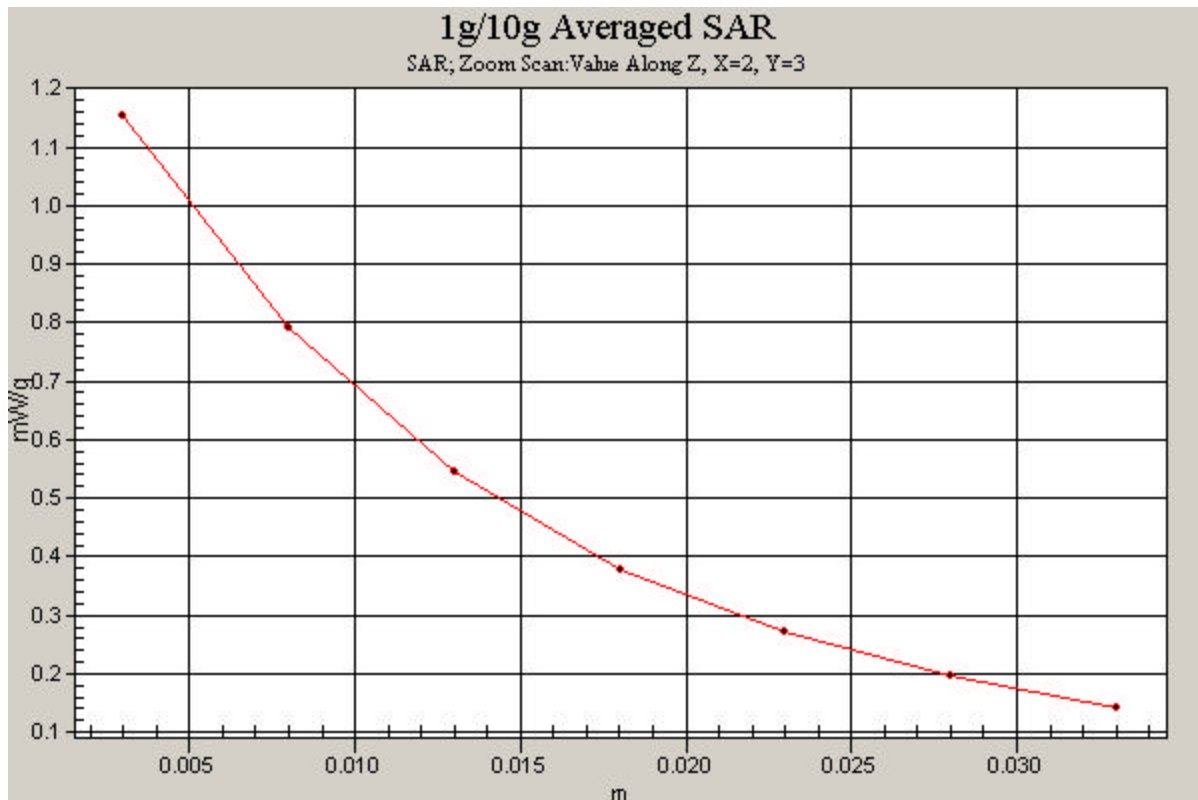

PCTEST ENGINEERING LABORATORY, INC.

DUT: Sanyo SCP-4930; Type: Tri Mode Mobile Phone; SN: F798E65C

Communication System: PCS CDMA; Frequency: 1880 MHz; Duty Cycle: 1:1

Medium: 1900 Brain ($\sigma = 1.36$ mho/m, $\epsilon_r = 41.60$, $\rho = 1000$ kg/m³)

Phantom section: Left Section

Test Date: 06-28-2005; Ambient Temp: 23.8°C; Tissue Temp: 20.2°C

Probe: EX3DV4 - SN3550; ConvF(6.75, 6.75, 6.75); Calibrated: 10/26/2004

Sensor-Surface: 3mm (Mechanical Surface Detection)

Electronics: DAE4 Sn909; Calibrated: 3/31/2005

Phantom: SAM Sub; Type: SAM 4.0; Serial: TP:1357

Measurement SW: DASY4, V4.5 Build 19; Postprocessing SW: SEMCAD, V1.8 Build 146

Touch, Ch.0600, Antenna Out, Standard Battery

Area Scan (7x17x1): Measurement grid: dx=15mm, dy=15mm

Zoom Scan (5x5x7)/Cube 0: Measurement grid: dx=8mm, dy=8mm, dz=5mm

Reference Value = 10.9 V/m

Peak SAR (extrapolated) = 0.523 W/kg

SAR(1 g) = 0.374 mW/g; SAR(10 g) = 0.236 mW/g

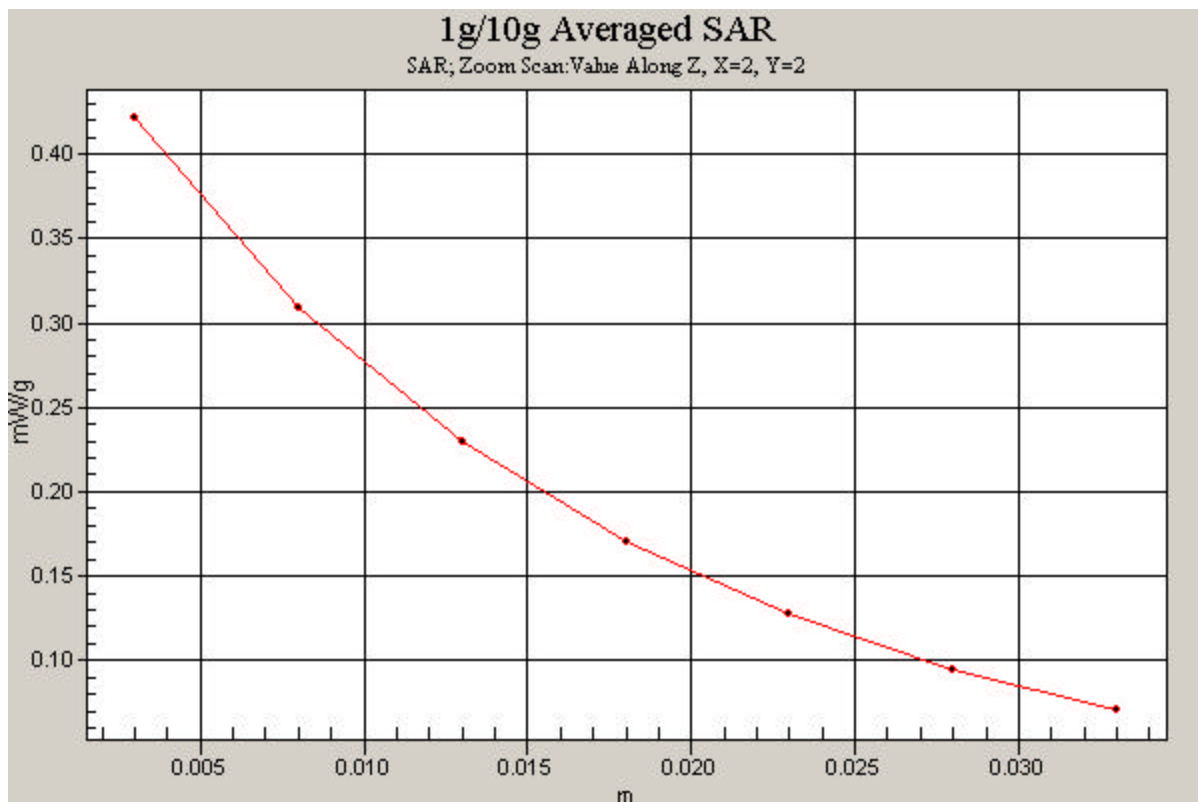

PCTEST ENGINEERING LABORATORY, INC.

DUT: Sanyo SCP-4930; Type: Tri Mode Mobile Phone; SN: F798E65C

Communication System: AMPS; Frequency: 836.49 MHz; Duty Cycle: 1:1

Medium: 835 Muscle ($\sigma = 0.98$ mho/m, $\epsilon_r = 53.0$, $\rho = 1000$ kg/m³)

Phantom section: Flat Section; Space: 1.9cm. from DUT to Flat Phantom

Test Date: 06-28-2005; Ambient Temp: 23.8°C; Tissue Temp: 20.6°C

Probe: EX3DV4 - SN3550; ConvF(7.99, 7.99, 7.99); Calibrated: 10/26/2004

Sensor-Surface: 3mm (Mechanical Surface Detection)

Electronics: DAE4 Sn909; Calibrated: 3/31/2005

Phantom: SAM Sub; Type: SAM 4.0; Serial: TP:1357

Measurement SW: DASY4, V4.5 Build 19; Postprocessing SW: SEMCAD, V1.8 Build 146

Body, Ch.0383, Antenna Out, Standard Battery

Area Scan (7x17x1): Measurement grid: dx=15mm, dy=15mm

Zoom Scan (5x5x7)/Cube 0: Measurement grid: dx=8mm, dy=8mm, dz=5mm

Reference Value = 15.5 V/m

Peak SAR (extrapolated) = 0.658 W/kg

SAR(1 g) = 0.516 mW/g; SAR(10 g) = 0.397 mW/g

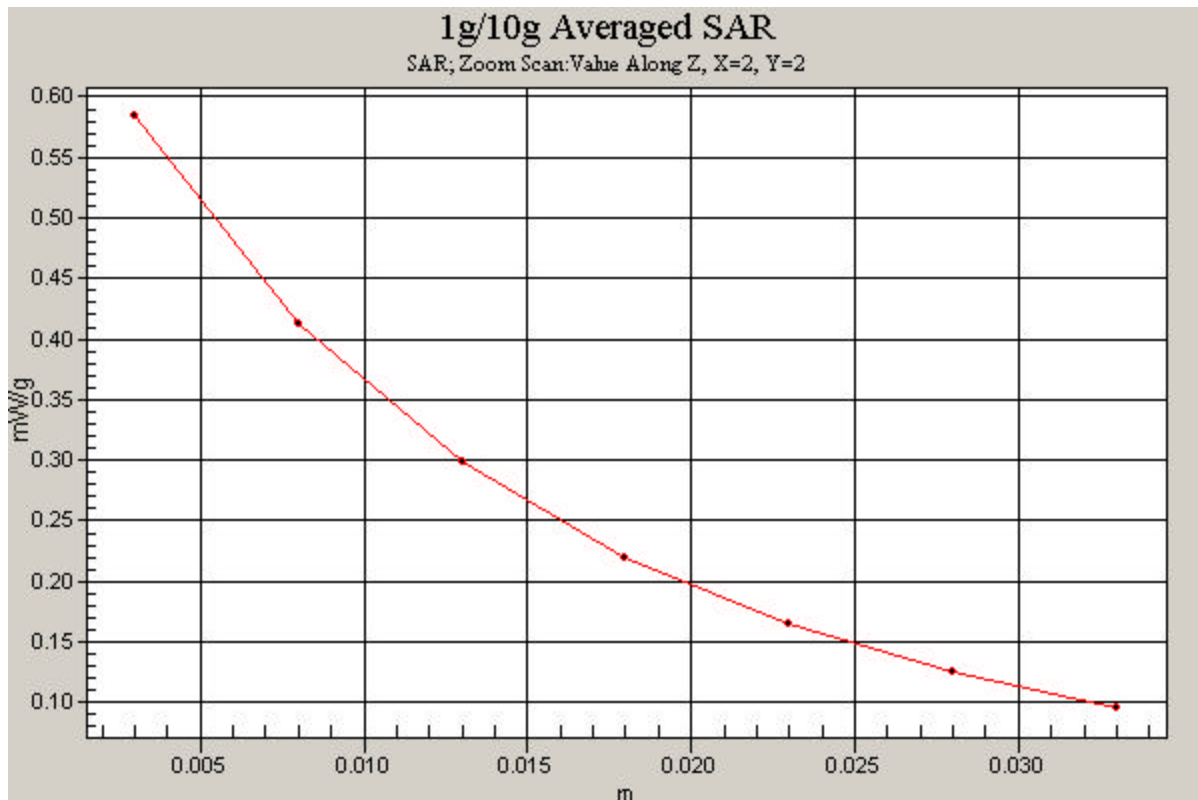

PCTEST ENGINEERING LABORATORY, INC.

DUT: Sanyo SCP-4930; Type: Tri Mode Mobile Phone; SN: F798E65C

Communication System: PCS CDMA; Frequency: 1851.25 MHz; Duty Cycle: 1:1

Medium: 1900 Muscle ($\sigma = 1.58$ mho/m, $\epsilon_r = 53.20$, $\rho = 1000$ kg/m³)

Phantom section: Flat Section; Space: 1.9cm. from DUT to Flat Phantom

Test Date: 06-28-2005; Ambient Temp: 23.8°C; Tissue Temp: 20.6°C

Probe: EX3DV4 - SN3550; ConvF(6.35, 6.35, 6.35); Calibrated: 10/26/2004

Sensor-Surface: 3mm (Mechanical Surface Detection)

Electronics: DAE4 Sn909; Calibrated: 3/31/2005

Phantom: SAM Main; Type: SAM 4.0; Serial: TP:1197

Measurement SW: DASY4, V4.5 Build 19; Postprocessing SW: SEMCAD, V1.8 Build 146

Body, Ch.0025, Antenna Out, Standard Battery

Area Scan (7x17x1): Measurement grid: dx=15mm, dy=15mm

Zoom Scan (5x5x7)/Cube 0: Measurement grid: dx=8mm, dy=8mm, dz=5mm

Reference Value = 13.2 V/m

Peak SAR (extrapolated) = 1.78 W/kg

SAR(1 g) = 1.15 mW/g; SAR(10 g) = 0.694 mW/g

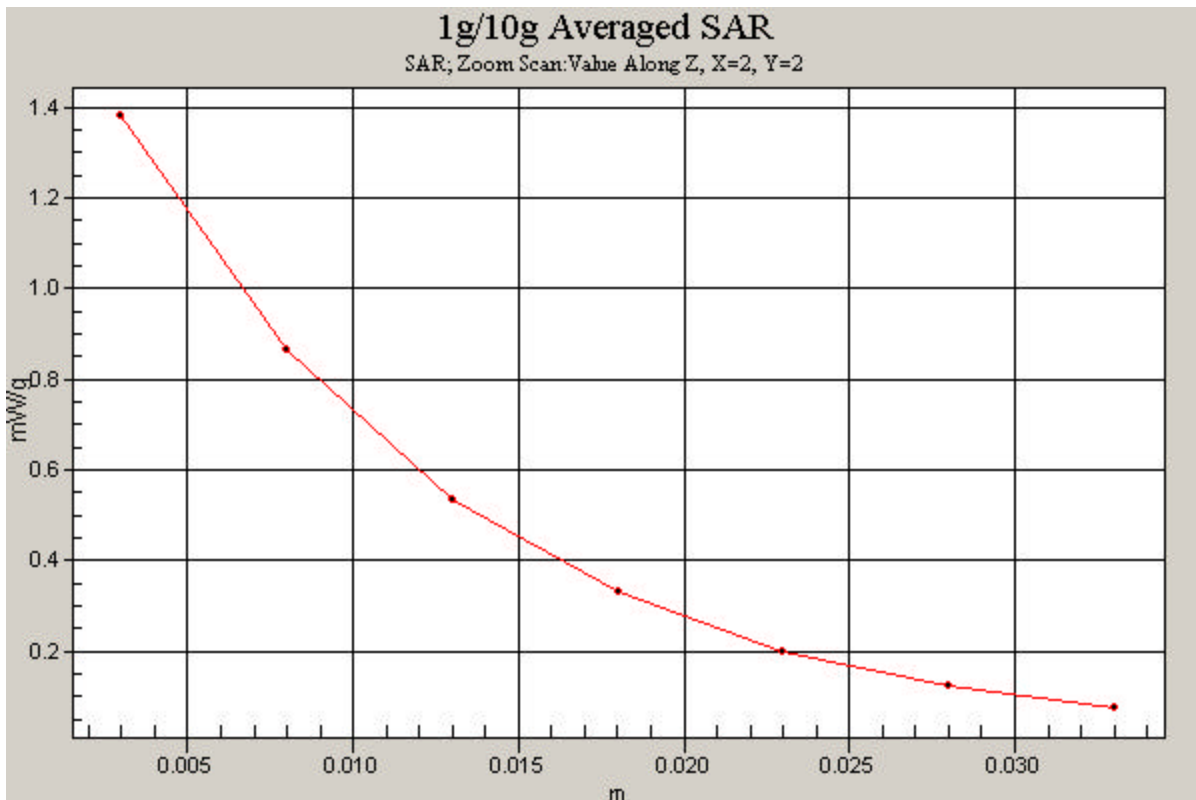

APPENDIX B: DIPOLE VALIDATION

PCTEST ENGINEERING LABORATORY, INC.

DUT: Dipole 835 MHz; Type: D835V2; Serial: 406

Communication System: CW; Frequency: 835 MHz; Duty Cycle: 1:1

Medium: 835 Brain ($\sigma = 0.88$ mho/m, $\epsilon_r = 42.30$, $\rho = 1000$ kg/m³)

Phantom section: Flat Section; Space: 1.5cm.

Test Date: 06-27-2005; Ambient Temp: 23.6°C; Tissue Temp: 20.5°C

Probe: EX3DV4 - SN3550; ConvF(8.12, 8.12, 8.12); Calibrated: 10/26/2004

Sensor-Surface: 3mm (Mechanical Surface Detection)

Electronics: DAE4 Sn909; Calibrated: 3/31/2005

Phantom: SAM Main; Type: SAM 4.0; Serial: TP:1197

Measurement SW: DASY4, V4.5 Build 19; Postprocessing SW: SEMCAD, V1.8 Build 146

835MHz Dipole Validation

Area Scan (7x13x1): Measurement grid: dx=15mm, dy=15mm

Zoom Scan (7x7x7)/Cube 0: Measurement grid: dx=5mm, dy=5mm, dz=5mm

Input Power = 24.0 dBm (250 mW)

SAR(1 g) = 2.43 mW/g; SAR(10 g) = 1.84 mW/g

Target SAR(1g) = 2.375 mW/g; Deviation = + 2.31 %

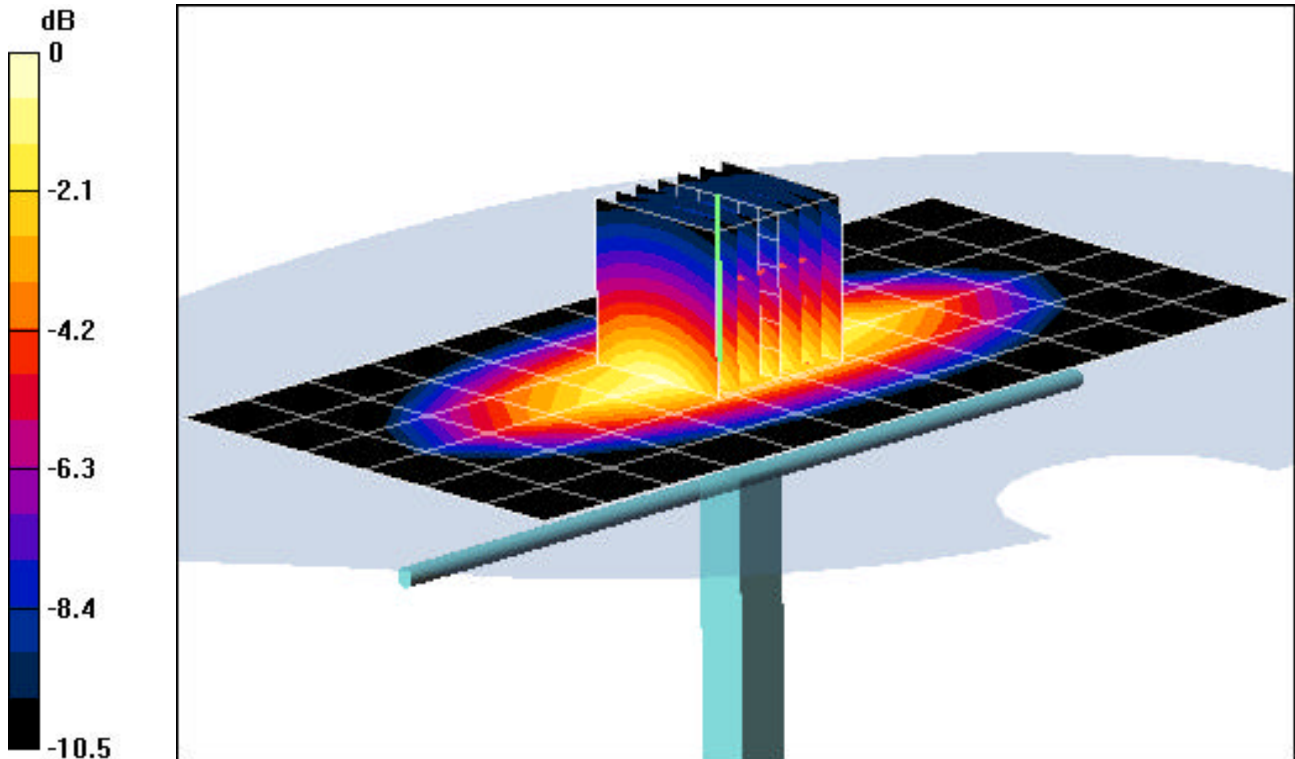

0 dB = 3.82mW/g

PCTEST ENGINEERING LABORATORY, INC.

DUT: Dipole 1900 MHz; Type: D1900V2; Serial: 502

Communication System: CW; Frequency: 1900 MHz; Duty Cycle: 1:1

Medium: 1900 Brain ($\sigma = 1.36$ mho/m, $\epsilon_r = 41.60$, $\rho = 1000$ kg/m³)

Phantom section: Flat Section

Test Date: 06-28-2005; Ambient Temp: 23.8°C; Tissue Temp: 20.2°C

Probe: EX3DV4 - SN3550; ConvF(6.75, 6.75, 6.75); Calibrated: 10/26/2004

Sensor-Surface: 3mm (Mechanical Surface Detection)

Electronics: DAE4 Sn909; Calibrated: 3/31/2005

Phantom: SAM Sub; Type: SAM 4.0; Serial: TP:1357

Measurement SW: DASY4, V4.5 Build 19; Postprocessing SW: SEMCAD, V1.8 Build 146

1900MHz Dipole Validation

Area Scan (5x7x1): Measurement grid: dx=15mm, dy=15mm

Zoom Scan (7x7x7)/Cube 0: Measurement grid: dx=5mm, dy=5mm, dz=5mm

Input Power = 20.0 dBm (100 mW)

SAR(1 g) = 4.08 mW/g; SAR(10 g) = 2.64 mW/g

Target SAR(1g) = 3.97 mW/g; Deviation = +2.77 %

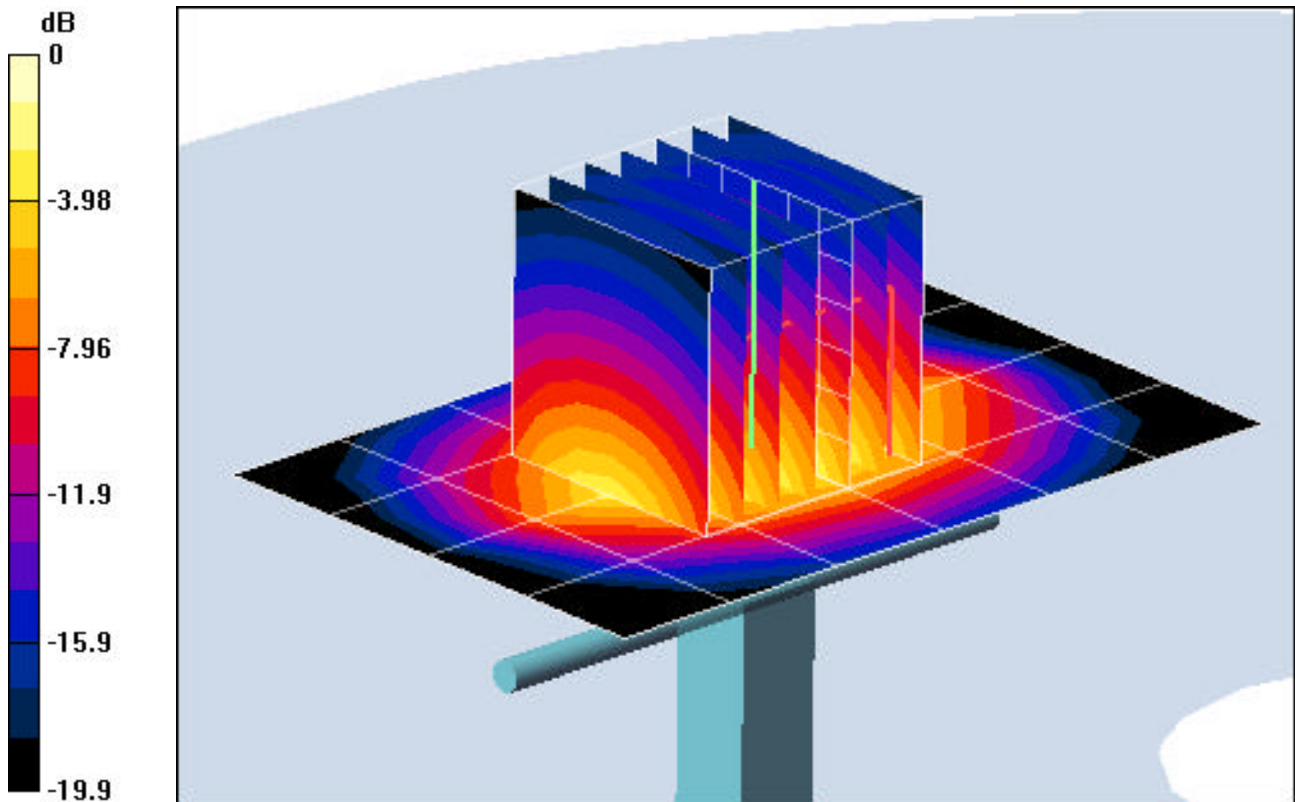

0 dB = 5.33mW/g

PCTEST ENGINEERING LABORATORY, INC.

DUT: Dipole 835 MHz; Type: D835V2; Serial: 406

Communication System: CW; Frequency: 835 MHz; Duty Cycle: 1:1

Medium: 835 Brain ($\sigma = 0.88$ mho/m, $\epsilon_r = 42.30$, $\rho = 1000$ kg/m³)

Phantom section: Flat Section; Space: 1.5cm.

Test Date: 06-28-2005; Ambient Temp: 23.8°C; Tissue Temp: 20.6°C

Probe: EX3DV4 - SN3550; ConvF(8.12, 8.12, 8.12); Calibrated: 10/26/2004

Sensor-Surface: 3mm (Mechanical Surface Detection)

Electronics: DAE4 Sn909; Calibrated: 3/31/2005

Phantom: SAM Main; Type: SAM 4.0; Serial: TP:1197

Measurement SW: DASY4, V4.5 Build 19; Postprocessing SW: SEMCAD, V1.8 Build 146

835MHz Dipole Validation

Area Scan (7x13x1): Measurement grid: dx=15mm, dy=15mm

Zoom Scan (7x7x7)/Cube 0: Measurement grid: dx=5mm, dy=5mm, dz=5mm

Input Power = 24.0 dBm (250 mW)

SAR(1 g) = 2.45 mW/g; SAR(10 g) = 1.96 mW/g

Target SAR(1g) = 2.375 mW/g; Deviation = + 3.15. %

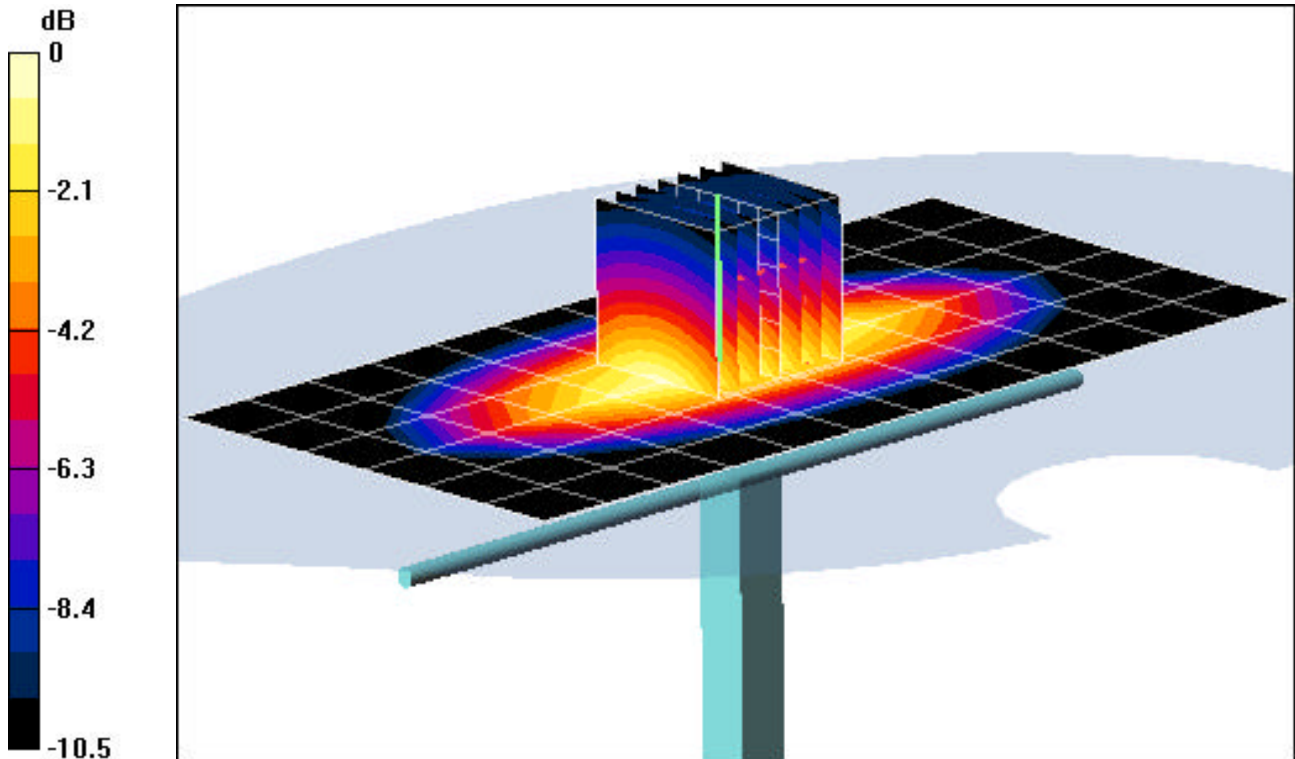

0 dB = 3.98mW/g

PCTEST ENGINEERING LABORATORY, INC.

DUT: Dipole 1900 MHz; Type: D1900V2; Serial: 502

Communication System: CW; Frequency: 1900 MHz; Duty Cycle: 1:1

Medium: 1900 Brain ($\sigma = 1.36$ mho/m, $\epsilon_r = 41.60$, $\rho = 1000$ kg/m³)

Phantom section: Flat Section

Test Date: 06-29-2005; Ambient Temp: 23.9°C; Tissue Temp: 20.4°C

Probe: EX3DV4 - SN3550; ConvF(6.75, 6.75, 6.75); Calibrated: 10/26/2004

Sensor-Surface: 3mm (Mechanical Surface Detection)

Electronics: DAE4 Sn909; Calibrated: 3/31/2005

Phantom: SAM Sub; Type: SAM 4.0; Serial: TP:1357

Measurement SW: DASY4, V4.5 Build 19; Postprocessing SW: SEMCAD, V1.8 Build 146

1900MHz Dipole Validation

Area Scan (5x7x1): Measurement grid: dx=15mm, dy=15mm

Zoom Scan (7x7x7)/Cube 0: Measurement grid: dx=5mm, dy=5mm, dz=5mm

Input Power = 20.0 dBm (100 mW)

SAR(1 g) = 4.13 mW/g; SAR(10 g) = 2.81 mW/g

Target SAR(1g) = 3.97 mW/g; Deviation = +4.03 %

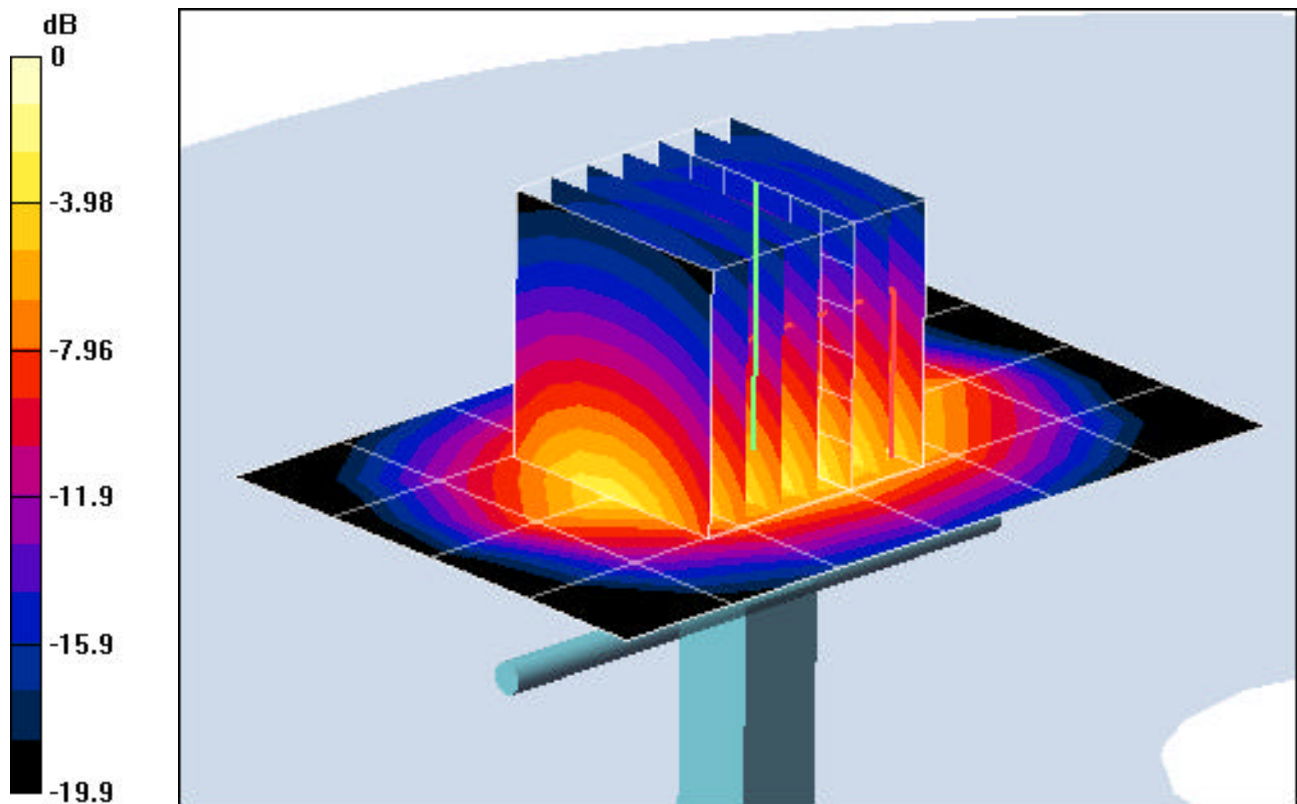

APPENDIX C: PROBE CALIBRATION



Accredited by the Swiss Federal Office of Metrology and Accreditation
The Swiss Accreditation Service is one of the signatories to the EA
Multilateral Agreement for the recognition of calibration certificates

Accreditation No.: **SCS 108**

Client **PC Test**

Certificate No: **EX3-3550_Oct04**

CALIBRATION CERTIFICATE

Object **EX3DV4 - SN:3550**

Calibration procedure(s) **QA CAL-01.v5 and QA CAL-12.v4
Calibration procedure for dosimetric E-field probes**

Calibration date: **October 26, 2004**

Condition of the calibrated item **In Tolerance**

This calibration certificate documents the traceability to national standards, which realize the physical units of measurements (SI).
The measurements and the uncertainties with confidence probability are given on the following pages and are part of the certificate.

All calibrations have been conducted in the closed laboratory facility: environment temperature (22 ± 3)°C and humidity < 70%.

Calibration Equipment used (M&TE critical for calibration)

Primary Standards	ID #	Cal Date (Calibrated by, Certificate No.)	Scheduled Calibration
Power meter E4419B	GB41293874	5-May-04 (METAS, No. 251-00388)	May-05
Power sensor E4412A	MY41495277	5-May-04 (METAS, No. 251-00388)	May-05
Reference 3 dB Attenuator	SN: S5054 (3c)	3-Apr-03 (METAS, No. 251-00403)	Aug-05
Reference 20 dB Attenuator	SN: S5086 (20b)	3-May-04 (METAS, No. 251-00389)	May-05
Reference 30 dB Attenuator	SN: S5129 (30b)	3-Apr-03 (METAS, No. 251-00404)	Aug-05
Reference Probe ES3DV2	SN:3013	8-Jan-04 (SPEAG, No. ES3-3013_Jan04)	Jan-05
DAE4	SN: 617	26-May-04 (SPEAG, No. DAE4-617_May04)	May-05

Secondary Standards	ID #	Check Date (in house)	Scheduled Check
Power sensor HP 8481A	MY41092180	18-Sep-02 (SPEAG, in house check Oct-03)	In house check: Oct 05
RF generator HP 8648C	US3642U01700	4-Aug-99 (SPEAG, in house check Dec-03)	In house check: Dec-05
Network Analyzer HP 8753E	US37390585	18-Oct-01 (SPEAG, in house check Nov-03)	In house check: Nov 04

	Name	Function	Signature
Calibrated by:	Katja Pokovic	Technical Manager	
Approved by:	Niels Kuster	Quality Manager	

Issued: October 30, 2004

This calibration certificate shall not be reproduced except in full without written approval of the laboratory.



Accredited by the Swiss Federal Office of Metrology and Accreditation
The Swiss Accreditation Service is one of the signatories to the EA
Multilateral Agreement for the recognition of calibration certificates

Accreditation No.: **SCS 108**

Glossary:

TSL	tissue simulating liquid
NORM _{x,y,z}	sensitivity in free space
ConF	sensitivity in TSL / NORM _{x,y,z}
DCP	diode compression point
Polarization φ	φ rotation around probe axis
Polarization ϑ	ϑ rotation around an axis that is in the plane normal to probe axis (at measurement center), i.e., $\vartheta = 0$ is normal to probe axis

Calibration is Performed According to the Following Standards:

- IEEE Std 1528-2003, "IEEE Recommended Practice for Determining the Peak Spatial-Averaged Specific Absorption Rate (SAR) in the Human Head from Wireless Communications Devices: Measurement Techniques", December 2003
- CENELEC EN 50361, "Basic standard for the measurement of Specific Absorption Rate related to human exposure to electromagnetic fields from mobile phones (300 MHz - 3 GHz), July 2001

Methods Applied and Interpretation of Parameters:

- NORM_{x,y,z}**: Assessed for E-field polarization $\vartheta = 0$ ($f \leq 900$ MHz in TEM-cell; $f > 1800$ MHz: R22 waveguide). NORM_{x,y,z} are only intermediate values, i.e., the uncertainties of NORM_{x,y,z} does not effect the E^2 -field uncertainty inside TSL (see below *ConvF*).
- NORM(f)_{x,y,z}** = NORM_{x,y,z} * *frequency_response* (see Frequency Response Chart). This linearization is implemented in DASY4 software versions later than 4.2. The uncertainty of the frequency response is included in the stated uncertainty of *ConvF*.
- DCP_{x,y,z}**: DCP are numerical linearization parameters assessed based on the data of power sweep (no uncertainty required). DCP does not depend on frequency nor media.
- ConvF and Boundary Effect Parameters**: Assessed in flat phantom using E-field (or Temperature Transfer Standard for $f \leq 800$ MHz) and inside waveguide using analytical field distributions based on power measurements for $f > 800$ MHz. The same setups are used for assessment of the parameters applied for boundary compensation (alpha, depth) of which typical uncertainty values are given. These parameters are used in DASY4 software to improve probe accuracy close to the boundary. The sensitivity in TSL corresponds to NORM_{x,y,z} * *ConvF* whereby the uncertainty corresponds to that given for *ConvF*. A frequency dependent *ConvF* is used in DASY 4.3 B17 and higher which allows extending the validity from ± 50 MHz to ± 100 MHz.
- Spherical isotropy (3D deviation from isotropy)**: in a field of low gradients realized using a flat phantom exposed by a patch antenna.
- Sensor Offset**: The sensor offset corresponds to the offset of virtual measurement center from the probe tip (on probe axis). No tolerance required.

Probe EX3DV4

SN:3550

Manufactured:	May 19, 2004
Calibrated:	October 26, 2004

Calibrated for DASY Systems

(Note: non-compatible with DASY2 system!)

DASY - Parameters of Probe: EX3DV4 SN:3550

Sensitivity in Free Space ^A			Diode Compression ^B	
NormX	0.47 ± 9.9%	$\mu\text{V}/(\text{V}/\text{m})^2$	DCP X	92 mV
NormY	0.49 ± 9.9%	$\mu\text{V}/(\text{V}/\text{m})^2$	DCP Y	92 mV
NormZ	0.47 ± 9.9%	$\mu\text{V}/(\text{V}/\text{m})^2$	DCP Z	92 mV

Sensitivity in Tissue Simulating Liquid (Conversion Factors)

Please see Page 8.

Boundary Effect

TSL	900 MHz	Typical SAR gradient: 5 % per mm	
	Sensor Center to Phantom Surface Distance	2.0 mm	3.0 mm
	SAR _{be} [%] Without Correction Algorithm	3.8	1.1
	SAR _{be} [%] With Correction Algorithm	0.1	0.4
TSL	1750 MHz	Typical SAR gradient: 10 % per mm	
	Sensor Center to Phantom Surface Distance	2.0 mm	3.0 mm
	SAR _{be} [%] Without Correction Algorithm	4.8	2.4
	SAR _{be} [%] With Correction Algorithm	0.8	0.9

Sensor Offset

Probe Tip to Sensor Center **1.0 mm**

The reported uncertainty of measurement is stated as the standard uncertainty of measurement multiplied by the coverage factor k=2, which for a normal distribution corresponds to a coverage probability of approximately 95%.

^A The uncertainties of NormX,Y,Z do not affect the E²-field uncertainty inside TSL (see Page 8).

^B Numerical linearization parameter: uncertainty not required.

Frequency Response of E-Field

(TEM-Cell:ifi110 EXX, Waveguide: R22)

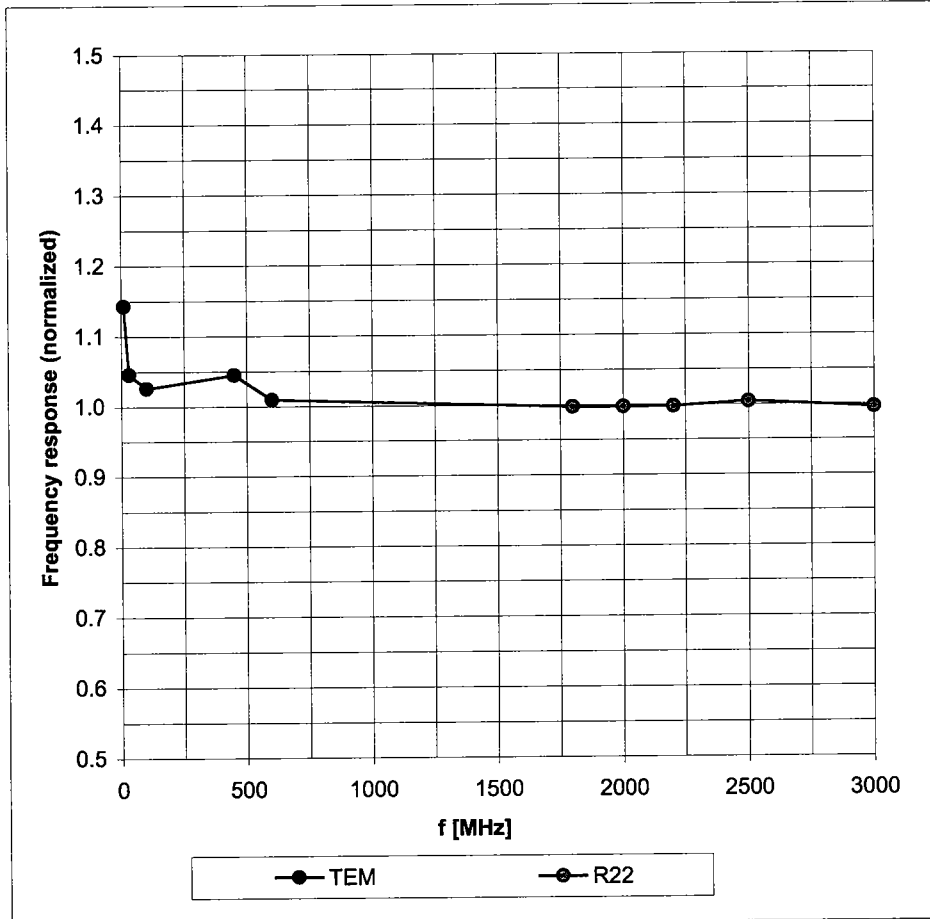

Uncertainty of Frequency Response of E-field: $\pm 6.3\%$ (k=2)

Receiving Pattern (ϕ), $\vartheta = 0^\circ$

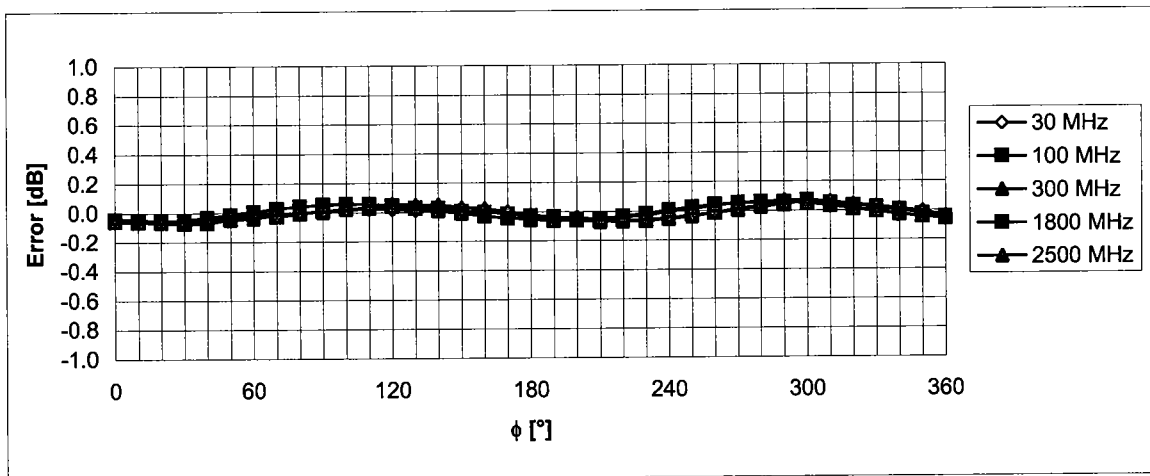
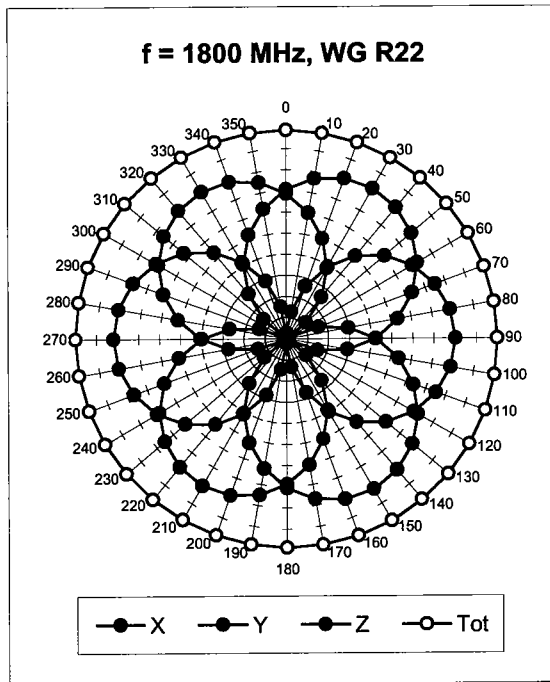
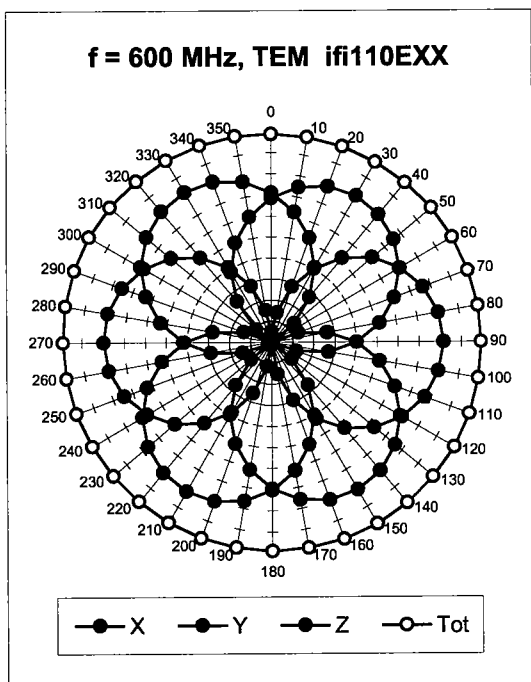

Uncertainty of Axial Isotropy Assessment: $\pm 0.5\%$ (k=2)

Dynamic Range $f(\text{SAR}_{\text{head}})$ (Waveguide R22, $f = 1800 \text{ MHz}$)

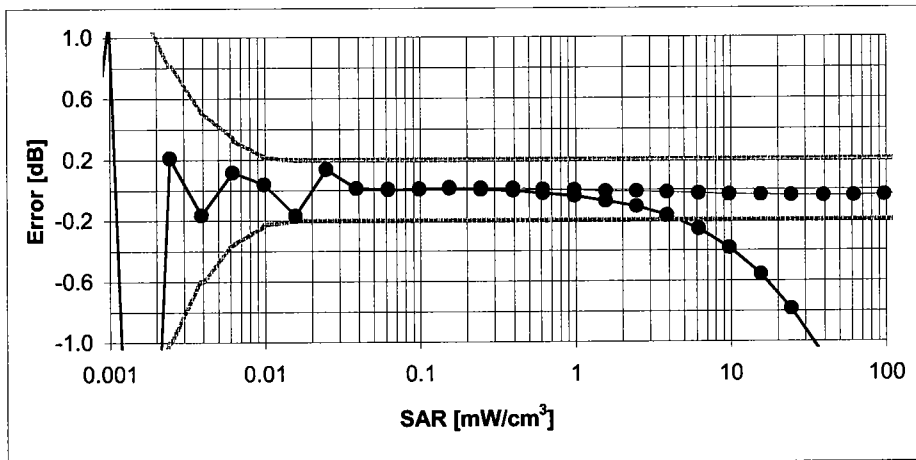
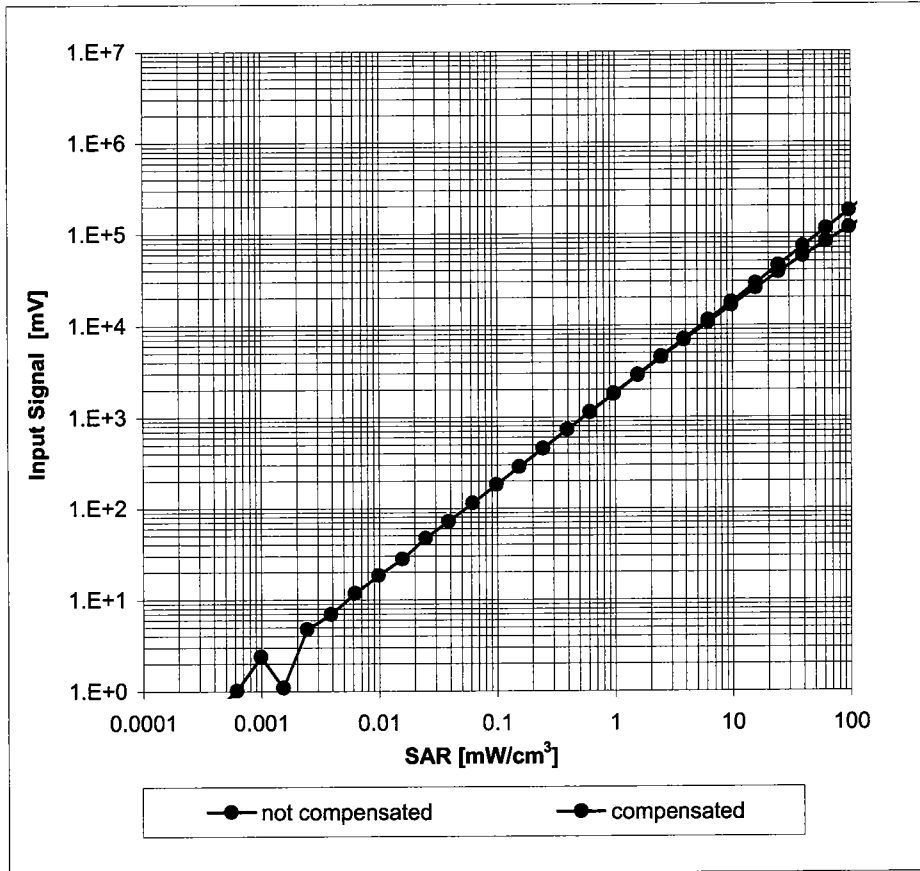

Uncertainty of Linearity Assessment: $\pm 0.6\%$ ($k=2$)

Conversion Factor Assessment

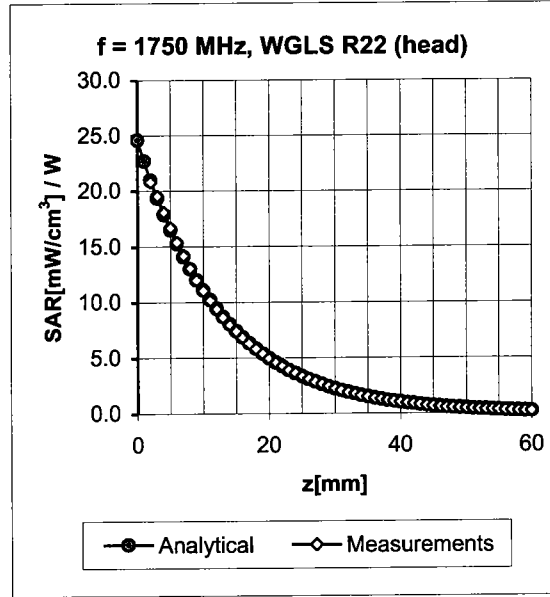
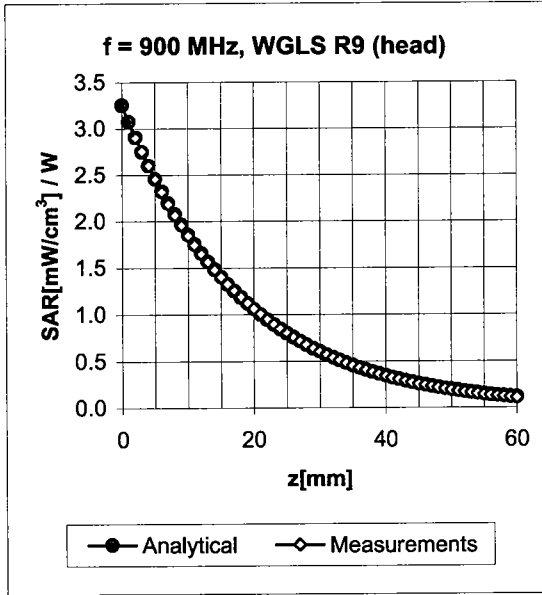

f [MHz]	Validity [MHz] ^c	TSL	Permittivity	Conductivity	Alpha	Depth	ConvF Uncertainty
450	± 50 / ± 100	Head	43.5 ± 5%	0.87 ± 5%	-0.03	2.33	8.28 ± 13.3% (k=2)
835	± 50 / ± 100	Head	41.5 ± 5%	0.90 ± 5%	0.92	0.65	8.12 ± 11.0% (k=2)
900	± 50 / ± 100	Head	41.5 ± 5%	0.97 ± 5%	0.97	0.62	7.76 ± 11.0% (k=2)
1640	± 50 / ± 100	Head	40.3 ± 5%	1.29 ± 5%	0.69	0.73	7.28 ± 11.0% (k=2)
1750	± 50 / ± 100	Head	40.0 ± 5%	1.40 ± 5%	0.64	0.80	6.97 ± 11.0% (k=2)
1900	± 50 / ± 100	Head	40.0 ± 5%	1.40 ± 5%	0.54	0.96	6.75 ± 11.0% (k=2)
1950	± 50 / ± 100	Head	40.0 ± 5%	1.40 ± 5%	0.57	0.88	6.62 ± 11.0% (k=2)
2450	± 50 / ± 100	Head	39.2 ± 5%	1.80 ± 5%	0.61	0.78	6.33 ± 11.8% (k=2)
450	± 50 / ± 100	Body	56.7 ± 5%	0.94 ± 5%	-0.08	2.62	8.05 ± 13.3% (k=2)
835	± 50 / ± 100	Body	55.2 ± 5%	0.97 ± 5%	0.98	0.65	7.99 ± 11.0% (k=2)
900	± 50 / ± 100	Body	55.0 ± 5%	1.05 ± 5%	1.01	0.63	7.75 ± 11.0% (k=2)
1640	± 50 / ± 100	Body	53.8 ± 5%	1.40 ± 5%	0.58	0.99	6.82 ± 11.0% (k=2)
1750	± 50 / ± 100	Body	53.3 ± 5%	1.52 ± 5%	0.50	1.16	6.48 ± 11.0% (k=2)
1900	± 50 / ± 100	Body	53.3 ± 5%	1.52 ± 5%	0.47	1.32	6.35 ± 11.0% (k=2)
1950	± 50 / ± 100	Body	53.3 ± 5%	1.52 ± 5%	0.64	0.83	6.53 ± 11.0% (k=2)
2450	± 50 / ± 100	Body	52.7 ± 5%	1.95 ± 5%	0.83	0.64	6.27 ± 11.8% (k=2)

^c The validity of ± 100 MHz only applies for DASY 4.3 B17 and higher (see Page 2). The uncertainty is the RSS of the ConvF uncertainty at calibration frequency and the uncertainty for the indicated frequency band.

Deviation from Isotropy in HSL

Error (ϕ, ϑ), $f = 900$ MHz

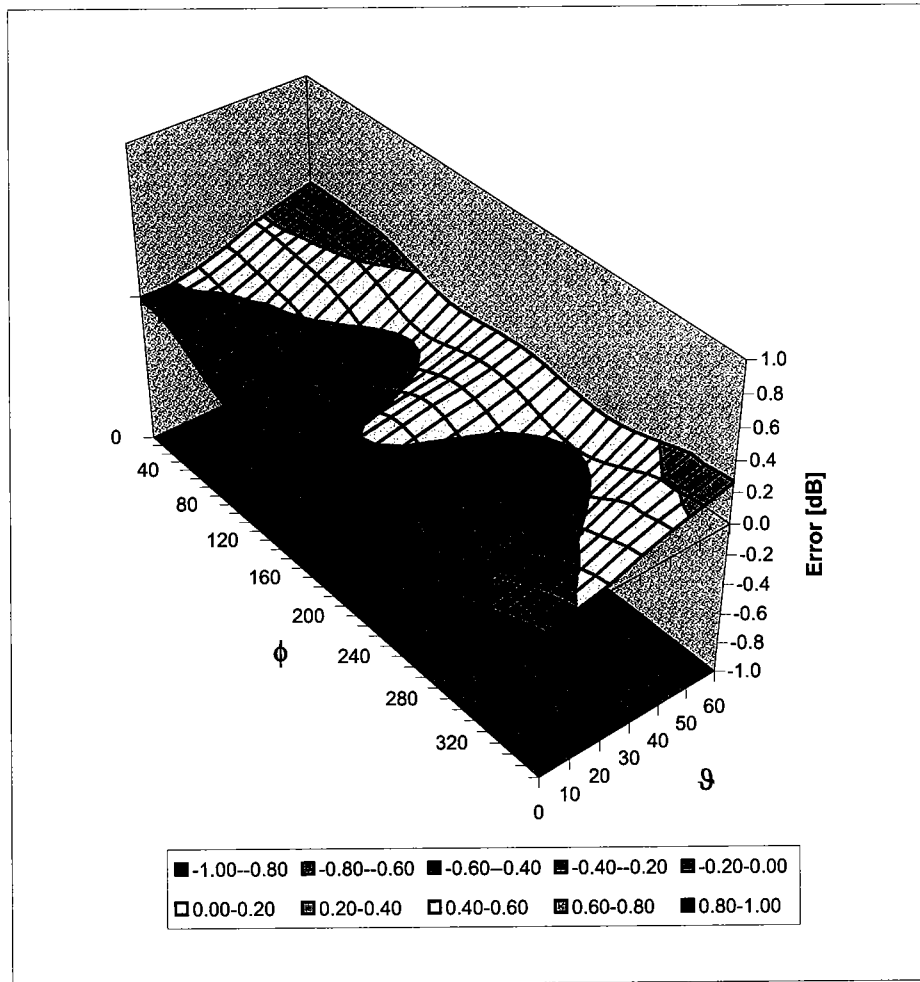

Uncertainty of Spherical Isotropy Assessment: $\pm 2.6\%$ ($k=2$)

Appendix^D

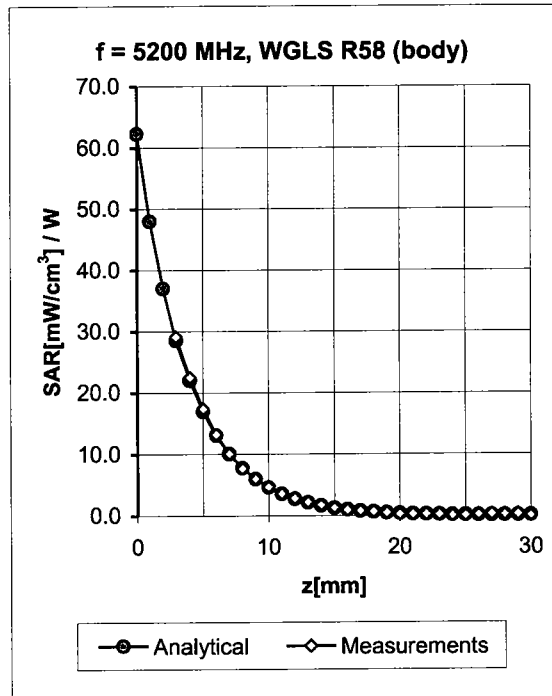
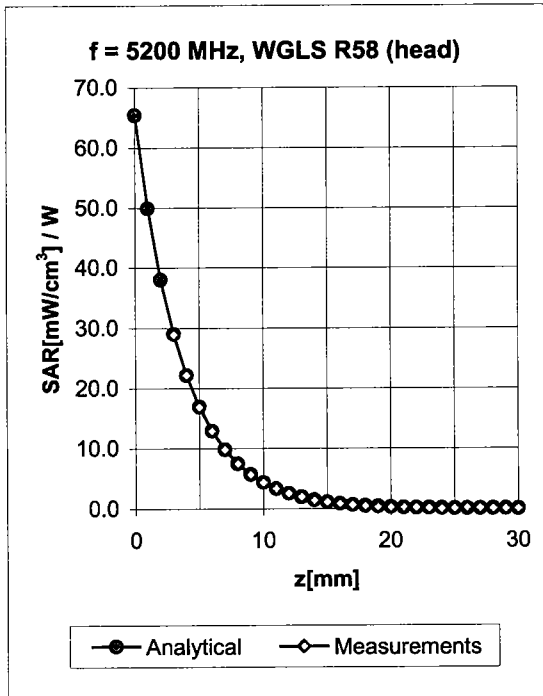

f [MHz] ^D	Validity [MHz]	TSL	Permittivity	Conductivity	Alpha	Depth	ConvF Uncertainty
5200	± 50	Head	36.0 ± 5%	4.76 ± 5%	0.45	1.80	4.17 ± 13.6% (k=2)
5500	± 50	Head	35.6 ± 5%	4.96 ± 5%	0.47	1.80	3.77 ± 13.6% (k=2)
5800	± 50	Head	35.3 ± 5%	5.27 ± 5%	0.48	1.80	3.74 ± 13.6% (k=2)
5200	± 50	Body	49.0 ± 5%	5.30 ± 5%	0.50	1.90	3.72 ± 13.6% (k=2)
5500	± 50	Body	48.6 ± 5%	5.65 ± 5%	0.50	1.95	3.47 ± 13.6% (k=2)
5800	± 50	Body	48.2 ± 5%	6.00 ± 5%	0.50	1.95	3.48 ± 13.6% (k=2)

^D Accreditation for ConvF assessment above 3000 MHz is currently applied for. Accreditation is expected at the beginning of 2005.