



PCTEST ENGINEERING LABORATORY, INC.

6660-B Dobbin Road, Columbia, MD 21045 USA
Tel. 410.290.6652 / Fax 410.290.6554
http://www.pctestlab.com



CERTIFICATE OF COMPLIANCE (SAR EVALUATION)

Applicant Name:
Sanyo Electric Co Ltd
c/o Sanyo Fisher Company 21605 Plummer Street
Chatsworth, CA 91311
USA

Date of Testing:
12/04/06 - 12/06/06
Test Site/Location:
PCTEST Lab, Columbia, MD, USA
Test Report Serial No.:
0612041093

FCC ID: AEZSCP-32H

APPLICANT: SANYO ELECTRIC CO LTD

EUT Type: Tri-Mode Dual-Band Analog/PCS Phone with Bluetooth
Application Type: Certification
FCC Rule Part(s): §2.1093; FCC/OET Bulletin 65 Supplement C [July 2001]
FCC Classification: Licensed Transmitter Held to Ear (PCE)
Model(s): SCP-3200
Tx Frequency: 824.04 - 848.97 MHz (AMPS)
824.70 - 848.31 MHz (Cellular CDMA)
1851.25 - 1908.75 MHz (PCS CDMA)
Conducted Power: 24.5 dBm AMPS / 24.0 dBm Cellular CDMA / 24.0 dBm PCS CDMA
Max. SAR Measurement: 1.40 W/kg AMPS Head SAR / 0.442 W/kg AMPS Body SAR
1.25 W/kg CDMA Head SAR / 0.362 W/kg CDMA Body SAR
1.41 W/kg PCS Head SAR / 0.295 W/kg PCS Body SAR
0.233 W/kg Face SAR
Test Device Serial No.: Pre-Production [S/N: A0000000030FF]

This wireless portable device has been shown to be capable of compliance for localized specific absorption rate (SAR) for uncontrolled environment/general population exposure limits specified in ANSI/IEEE Std. C95.1-2005 and has been tested in accordance with the measurement procedures specified in FCC/OET Bulletin 65 Supplement C (2001) and IEEE Std. 1528-2003.

I attest to the accuracy of data. All measurements reported herein were performed by me or were made under my supervision and are correct to the best of my knowledge and belief. I assume full responsibility for the completeness of these measurements and vouch for the qualifications of all persons taking them.

Grant Conditions: Power output listed is ERP for Part 22 and EIRP for Part 24. SAR compliance for body-worn operating configuration is based on a separation distance 2.2 cm between the back of the unit and the body of the user. End-users must be informed of the body-worn operating requirements for satisfying RF exposure compliance. Belt clips or holsters not specified in this filing may not contain metallic components.

PCTEST certifies that no party to this application has been denied the FCC benefits pursuant to Section 5301 of the Anti-Drug Abuse Act of 1988, 21 U.S.C. 862.



Randy Ortanez
President



FCC ID: AEZSCP-32H		CERTIFICATION REPORT		Reviewed by: Quality Manager
SAR Filename: 06012041093	Test Dates: 12/04/06 - 12/06/06	EUT Type: Tri-Mode Dual-Band Analog/PCS Phone with Bluetooth		Page 1 of 27

T A B L E O F C O N T E N T S

1	INTRODUCTION	3
2	TEST SITE LOCATION	4
3	SAR MEASUREMENT SETUP	5
4	DASY E-FIELD PROBE SYSTEM	7
5	PROBE CALIBRATION PROCESS	8
6	PHANTOM AND EQUIVALENT TISSUES.....	9
7	DOSIMETRIC ASSESSMENT & PHANTOM SPECS.....	10
8	DEFINITION OF REFERENCE POINTS	11
9	TEST CONFIGURATION POSITIONS	12
10	ANSI/IEEE C95.1-2005 RF EXPOSURE LIMITS.....	14
11	MEASUREMENT UNCERTAINTIES	15
12	SYSTEM VERIFICATION.....	16
13	FCC 3G MEASUREMENT PROCEDURES – JUNE 2006	17
14	SAR DATA SUMMARY	19
15	EQUIPMENT LIST.....	24
16	CONCLUSION.....	25
17	REFERENCES	26

FCC ID: AEZSCP-32H	 <small>Complete Wireless Lab</small>	CERTIFICATION REPORT		Reviewed by: Quality Manager
SAR Filename: 06012041093	Test Dates: 12/04/06 - 12/06/06	EUT Type: Tri-Mode Dual-Band Analog/PCS Phone with Bluetooth		Page 2 of 27

1 INTRODUCTION

The FCC has adopted the guidelines for evaluating the environmental effects of radio frequency (RF) radiation in ET Docket 93-62 on Aug. 6, 1996 to protect the public and workers from the potential hazards of RF emissions due to FCC-regulated portable devices.[1]

The safety limits used for the environmental evaluation measurements are based on the criteria published by the American National Standards Institute (ANSI) for localized specific absorption rate (SAR) in IEEE/ANSI C95.1-2005 Standard for Safety Levels with Respect to Human Exposure to Radio Frequency Electromagnetic Fields, 3 kHz to 300 GHz. (c) 2005 by the Institute of Electrical and Electronics Engineers, Inc., New York, New York 10017.[2] The measurement procedure described in IEEE/ANSI C95.3-2002 Recommended Practice for the Measurement of Potentially Hazardous Electromagnetic Fields - RF and Microwave[3] is used for guidance in measuring the Specific Absorption Rate (SAR) due to the RF radiation exposure from the Equipment Under Test (EUT). These criteria for SAR evaluation are similar to those recommended by the International Committee for Non-Ionizing Radiation Protection (ICNIRP) in Biological Effects and Exposure Criteria for Radiofrequency Electromagnetic Fields," Report No. Vol 74. SAR is a measure of the rate of energy absorption due to exposure to an RF transmitting source. SAR values have been related to threshold levels for potential biological hazards.

1.1 SAR Definition

Specific Absorption Rate is defined as the time derivative (rate) of the incremental energy (dU) absorbed by (dissipated in) an incremental mass (dm) contained in a volume element (dV) of a given density (ρ). It is also defined as the rate of RF energy absorption per unit mass at a point in an absorbing body (see Fig. 1-1).

$$SAR = \frac{d}{dt} \left(\frac{dU}{dm} \right) = \frac{d}{dt} \left(\frac{dU}{\rho dV} \right)$$

Figure 1-1
SAR Mathematical Equation



SAR is expressed in units of Watts per Kilogram (W/kg).

$$SAR = \frac{\sigma \cdot E^2}{\rho}$$

where:

- σ = conductivity of the tissue-simulating material (S/m)
- ρ = mass density of the tissue-simulating material (kg/m^3)
- E = Total RMS electric field strength (V/m)

NOTE: The primary factors that control rate of energy absorption were found to be the wavelength of the incident field in relation to the dimensions and geometry of the irradiated organism, the orientation of the organism in relation to the polarity of field vectors, the presence of reflecting surfaces, and whether conductive contact is made by the organism with a ground plane.[6]

FCC ID: AEZSCP-32H	 PCTEST Complete Wireless Lab	CERTIFICATION REPORT	 SANYO	Reviewed by: Quality Manager
SAR Filename: 06012041093	Test Dates: 12/04/06 - 12/06/06	EUT Type: Tri-Mode Dual-Band Analog/PCS Phone with Bluetooth		Page 3 of 27

2 TEST SITE LOCATION

2.1 INTRODUCTION

The map at the right shows the location of the PCTEST LABORATORY in Columbia, Maryland. It is in proximity to the FCC Laboratory, the Baltimore-Washington International (BWI) airport, the city of Baltimore and Washington, DC (See Figure 2).

These measurement tests were conducted at the PCTEST Engineering Laboratory, Inc. facility in New Concept Business Park, Guilford Industrial Park, Columbia, Maryland. The site address is 6660-B Dobbin Road, Columbia, MD 21045. The test site is one of the highest points in the Columbia area with an elevation of 390 feet above mean sea level. The site coordinates are 39° 11'15" N latitude and 76° 49' 38" W longitude. The facility is 1.5 miles north of the FCC laboratory, and the ambient signal and ambient signal strength are approximately equal to those of the FCC laboratory. There are no FM or TV transmitters within 15 miles of the site. The detailed description of the measurement facility was found to be in compliance with the requirements of § 2.948 according to ANSI C63.4 on January 27, 2006 and Industry Canada.

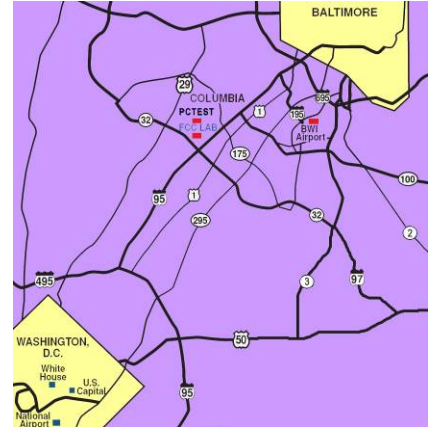
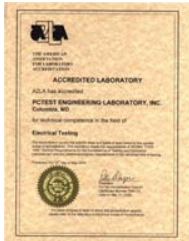



Figure 2-1
Map of the Greater Baltimore and Metropolitan Washington, D.C. area

2.2 Test Facility / Accreditations:

Measurements were performed at an independent accredited PCTEST Engineering Lab located in Columbia, MD 21045, U.S.A.



- PCTEST Lab is accredited to ISO 17025-2005 by the American Association for Laboratory Accreditation (A2LA) in Specific Absorption Rate (SAR) testing, Hearing-Aid Compatibility (HAC), CTIA Test Plans, and wireless testing for FCC and Industry Canada Rules.
- PCTEST Lab is accredited to ISO 17025 by U.S. National Institute of Standards and Technology (NIST) under the National Voluntary Laboratory Accreditation Program (NVLAP Lab code: 100431-0) in EMC, FCC and Telecommunications.
- PCTEST facility is an FCC registered (PCTEST Reg. No. 90864) test facility with the site description report on file and has met all the requirements specified in Section 2.948 of the FCC Rules and Industry Canada (IC-2451).
- PCTEST Lab is a recognized U.S. Conformity Assessment Body (CAB) in EMC and R&TTE (n.b. 0982) under the U.S.-EU Mutual Recognition Agreement (MRA).
- PCTEST TCB is a Telecommunication Certification Body (TCB) accredited to ISO/IEC Guide 65 by the American National Standards Institute (ANSI) in all scopes of FCC Rules and all Industry Canada Standards (RSS).
- PCTEST facility is an IC registered (IC-2451) test laboratory with the site description on file at Industry Canada.
- PCTEST is a CTIA Authorized Test Laboratory (CATL) for AMPS and CDMA, and EvDO mobile phones.
- PCTEST is a CTIA Authorized Test Laboratory (CATL) for Over-the-Air (OTA) Antenna Performance testing for AMPS, CDMA, GSM, GPRS, EGPRS, UMTS (W-CDMA), CDMA 1xEVDO Data, CDMA 1xRTT Data.

FCC ID: AEZSCP-32H		CERTIFICATION REPORT		Reviewed by: Quality Manager
SAR Filename: 06012041093	Test Dates: 12/04/06 - 12/06/06	EUT Type: Tri-Mode Dual-Band Analog/PCS Phone with Bluetooth	Page 4 of 27	

3 SAR MEASUREMENT SETUP

3.1 Robotic System

Measurements are performed using the DASY4 automated dosimetric assessment system. The DASY4 is made by Schmid & Partner Engineering AG (SPEAG) in Zurich, Switzerland and consists of high precision robotics system (Staubli), robot controller, Pentium 4 computer, near-field probe, probe alignment sensor, and the generic twin phantom containing the brain equivalent material. The robot is a six-axis industrial robot performing precise movements to position the probe to the location (points) of maximum electromagnetic field (EMF) (see Figure 3-1).

3.2 System Hardware

A cell controller system contains the power supply, robot controller, teach pendant (Joystick), and a remote control used to drive the robot motors. The PC consists of the Gateway Pentium 4 2.53 GHz computer with Windows XP system and SAR Measurement Software DASY4, A/D interface card, monitor, mouse, and keyboard. The Staubli Robot is connected to the cell controller to allow software manipulation of the robot. A data acquisition electronic (DAE) circuit that performs the signal amplification, signal multiplexing, AD-conversion, offset measurements, mechanical surface detection, collision detection, etc. is connected to the Electro-optical coupler (EOC). The EOC performs the conversion from the optical into digital electric signal of the DAE and transfers data to the PC plug-in card.

3.3 System Electronics

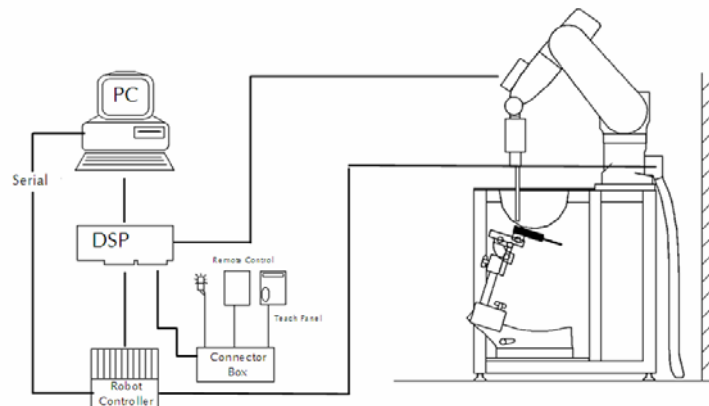



Figure 3-1
SAR Measurement System Setup

The DAE4 consists of a highly sensitive electrometer-grade preamplifier with auto-zeroing, a channel and gain-switching multiplexer, a fast 16 bit AD-converter and a command decoder and control logic unit. Transmission to the PC-card is accomplished through an optical downlink for data and status information and an optical uplink for commands and clock lines. The mechanical probe mounting device includes two different sensor systems for frontal and sidewise probe contacts. They are also used for mechanical surface detection and probe collision detection. The robot uses its own controller with a built in VME-bus computer. The system is described in detail in [7].

FCC ID: AEZSCP-32H	 PCTEST Complete Wireless Lab	CERTIFICATION REPORT	 SANYO	Reviewed by: Quality Manager
SAR Filename: 06012041093	Test Dates: 12/04/06 - 12/06/06	EUT Type: Tri-Mode Dual-Band Analog/PCS Phone with Bluetooth		Page 5 of 27

3.4 Automated Test System Specifications

Positioner

Robot: Stäubli Unimation Corp. Robot RX60L
 Repeatability: 0.02 mm
 No. of Axes: 6

Data Acquisition Electronic System (DAE)

Cell Controller

Processor: Pentium 4
 Clock Speed: 2.53 GHz
 Operating System: Windows XP Professional

Data Converter

Features: Signal Amplifier, multiplexer, A/D converter & control logic
 Software: DASY4, SEMCAD software
 Connecting Lines: Optical Downlink for data and status info
 Optical upload for commands and clock

PC Interface Card



Function: 166MHz low power Pentium MMX 32MB chipdisk
 Link to DAE
 16-bit A/D converter for surface detection system
 Two Serial & Ethernet link to robotics
 Direct emergency stop output for robot

Phantom

Type: SAM Twin Phantom (V4.0)
 Shell Material: Composite
 Thickness: 2.0 ± 0.2 mm



Figure 3-2
DASY4 SAR Measurement System

FCC ID: AEZSCP-32H	 PCTEST Complete Wireless Lab	CERTIFICATION REPORT	 SANYO	Reviewed by: Quality Manager
SAR Filename: 06012041093	Test Dates: 12/04/06 - 12/06/06	EUT Type: Tri-Mode Dual-Band Analog/PCS Phone with Bluetooth	Page 6 of 27	

4.1 Probe Measurement System



Figure 4-1
SAR System

The SAR measurements were conducted with the dosimetric probe EX3DV4, designed in the classical triangular configuration [7] (see Figure 4-3) and optimized for dosimetric evaluation. The probe is constructed using the thick film technique; with printed resistive lines on ceramic substrates. The probe is equipped with an optical multi-fiber line ending at the front of the probe tip. It is connected to the EOC box on the robot arm and provides an automatic detection of the phantom surface. Half of the fibers are connected to a pulsed infrared transmitter, the other half to a synchronized receiver. As the probe approaches the surface, the reflection from the surface produces a coupling from the transmitting to the receiving fibers. This reflection increases first during the approach, reaches maximum and then decreases. If the probe is flatly touching the surface, the coupling is zero. The distance of the coupling maximum to the surface is independent of the surface reflectivity and largely independent of the surface to probe angle. The DASY4 software reads the reflection during a software approach

and looks for the maximum using a 2nd order fitting (see Figure 5-1). The approach is stopped at reaching the maximum.

4.2 Probe Specifications



Model:	EX3DV4
Frequency Range:	10 MHz – 6.0 GHz
Calibration:	In brain and muscle simulating tissue at Frequencies from 835 up to 5800MHz
Linearity:	± 0.2 dB (30 MHz to 6 GHz)
Dynamic Range:	10 mW/kg – 100 W/kg
Probe Length:	330 mm
Probe Tip Length:	20 mm
Body Diameter:	12 mm
Tip Diameter:	2.5 mm
Tip-Center:	1 mm
Application:	SAR Dosimetry Testing Compliance tests of mobile phones



Figure 4-2
Near-Field Probe



Figure 4-3
Triangular Probe Configuration

FCC ID: AEZSCP-32H	 PCTEST Complete Wireless Lab	CERTIFICATION REPORT	 SANYO	Reviewed by: Quality Manager
SAR Filename: 06012041093	Test Dates: 12/04/06 - 12/06/06	EUT Type: Tri-Mode Dual-Band Analog/PCS Phone with Bluetooth		Page 7 of 27

5 PROBE CALIBRATION PROCESS

5.1 Dosimetric Assessment Procedure

Each E-Probe/Probe amplifier combination has unique calibration parameters. A TEM cell calibration procedure is conducted to determine the proper amplifier settings to enter in the probe parameters. The amplifier settings are determined for a given frequency by subjecting the probe to a known E-field density (1 mW/cm²) using an RF Signal generator, TEM cell, and RF Power Meter.

5.2 Free Space Assessment

The free space E-field from amplified probe outputs is determined in a test chamber. This calibration can be performed in a TEM cell if the frequency is below 1 GHz and in a waveguide or other methodologies above 1 GHz for free space. For the free space calibration, the probe is placed in the volumetric center of the cavity and at the proper orientation with the field. The probe is rotated 360 degrees until the three channels show the maximum reading. The power density readings equates to 1 mW/cm².

5.3 Temperature Assessment

E-field temperature correlation calibration is performed in a flat phantom filled with the appropriate simulated brain tissue. The E-field in the medium correlates with the temperature rise in the dielectric medium. For temperature correlation calibration a RF transparent thermistor-based temperature probe is used in conjunction with the E-field probe.

$$SAR = C \frac{\Delta T}{\Delta t}$$

where:

- Δt = exposure time (30 seconds),
- C = heat capacity of tissue (brain or muscle),
- ΔT = temperature increase due to RF exposure.

$$SAR = \frac{|E|^2 \cdot \sigma}{\rho}$$

where:

- σ = simulated tissue conductivity,
- ρ = Tissue density (1.25 g/cm³ for brain tissue)

SAR is proportional to $\Delta T/\Delta t$, the initial rate of tissue heating, before thermal diffusion takes place. Now it's possible to quantify the electric field in the simulated tissue by equating the thermally derived SAR to the E- field;

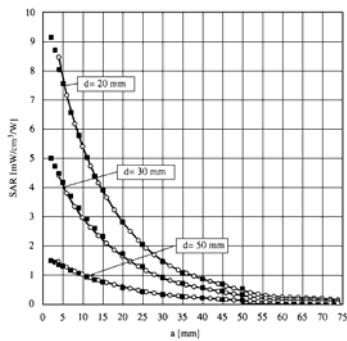

Figure 5-1 E-Field and Temperature measurements at 900MHz [7]

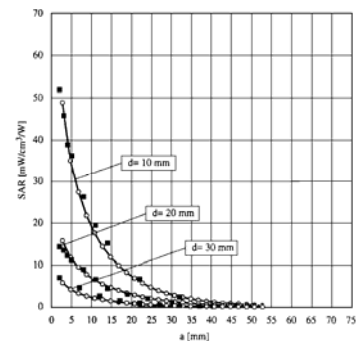



Figure 5-2 E-Field and temperature measurements at 1.9GHz [7]

FCC ID: AEZSCP-32H	 PCTEST Complete Wireless Lab	CERTIFICATION REPORT	 SANYO	Reviewed by: Quality Manager
SAR Filename: 06012041093	Test Dates: 12/04/06 - 12/06/06	EUT Type: Tri-Mode Dual-Band Analog/PCS Phone with Bluetooth		Page 8 of 27

6 PHANTOM AND EQUIVALENT TISSUES

6.1 SAM Phantoms



Figure 6-1
SAM Phantoms

The SAM Twin Phantom V4.0 is constructed of a fiberglass shell integrated in a wooden table. The shape of the shell is based on data from an anatomical study designed to determine the maximum exposure in at least 90% of all users [11][12]. It enables the dosimetric evaluation of left and right hand phone usage as well as body mounted usage at the flat phantom region. A cover prevents the evaporation of the liquid. Reference markings on the Phantom allow the complete setup of all predefined phantom positions and measurement grids by manually teaching three points in the robot. (see Fig. 5.1)

6.2 Brain & Muscle Simulating Mixture Characterization

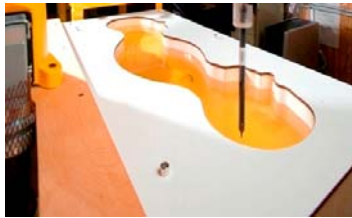

Figure 6-2
Head Simulated



The brain and muscle mixtures consist of a viscous gel using hydroxethylcellulose (HEC) gelling agent and saline solution (see Table 6-1). Preservation with a bactericide is added and visual inspection is made to make sure air bubbles are not trapped during the mixing process. The mixture is calibrated to obtain proper dielectric constant (permittivity) and conductivity of the desired tissue. The head tissue dielectric parameters recommended by the IEEE SCC-34/SC-2 have been incorporated in the following table. Other head and body tissue parameters that have not been specified in IEEE-1528 are derived from the tissue dielectric parameters computed from the 4-Cole-Cole equations. The mixture characterizations used for the brain and muscle tissue simulating liquids are according to the data by C. Gabriel and G. Hartsgrrove [13]. (See Table 6-1)

Table 6-1
Composition of the Brain & Muscle Tissue Equivalent Matter

Frequency (MHz)	300			450			835			900			1450			1800				1900		1950		2000		2100		2450		3000	
Recipe #	1	1	3	1	1	2	3	1	1	2	3	1	1	2	2	3	1	2	4	1	1	2	2	3	2	2	3	2			
Ingredients: (% by weight)																															
1,3-Propanediol								64.81																							
Bactericide	0.19	0.19	0.50	0.10	0.10			0.50									0.50												0.50		
Diaceta			48.90					49.20									49.43												49.75		
DGBE								45.41	47.00	13.84	44.92						44.94	13.84	45.00	50.00	50.00	7.99	7.99					7.99			
HEC	0.98	0.98		1.00	1.00																										
NaCl	5.95	3.95	1.70	1.45	1.48	0.79	1.10	0.67	0.36	0.35	0.18	0.64	0.18	0.35												0.16	0.16	0.16			
Sucrose	55.32	56.32		57.00	56.50																										
Triton X-100														30.45						30.45						19.97	19.97		19.97		
Water	37.56	38.56	48.90	40.45	40.92	34.40	49.20	53.80	52.64	55.36	54.90	49.43	54.90	55.36	55.00	50.00	50.00	50.00	50.00	50.00	50.00	50.00	50.00	71.88	71.88	49.75	71.88				
Measured dielectric parameters																															
ϵ'_r	46.00	43.4	44.3	41.6	41.2	41.8	42.7	40.9	39.3	41	40.4	39.2	39.9	41	40.1	37	36.8	41.1	40.3	39.2	37.9										
σ (S/m)	0.86	0.87	0.9	0.9	0.98	0.97	0.99	1.21	1.39	1.38	1.4	1.42	1.38	1.41	1.4	1.51	1.53	1.88	1.82	2.46											
Temp. (°C)	22	22	20	22	22	22	20	22	22	21	22	20	21	20	21	20	22	20	20	20	20										
Target dielectric parameters (Table 2)																															
ϵ'_r	45.30	43.50	41.5	41.50	40.5								40.0				39.80	39.2	38.5												
σ (S/m)	0.87	0.87	0.9	0.97	1.2								1.4				1.49	1.8	2.4												

NOTE—Multiple columns for any single frequency are optional recipes. Recipe #, reference: 1 (Kanda et al. [B85]), 2 (Vignone [B149]), 3 (Peyman and Gabriel [B119]), 4 (Falcovaga et al. [B50]).

*The formulas containing Triton X-100 and corresponding measured parameters are under review and verification.

FCC ID: AEZSCP-32H		CERTIFICATION REPORT		Reviewed by: Quality Manager
SAR Filename: 06012041093	Test Dates: 12/04/06 - 12/06/06	EUT Type: Tri-Mode Dual-Band Analog/PCS Phone with Bluetooth		Page 9 of 27

7.1 Measurement Procedure

The evaluation was performed using the following procedure:

1. The SAR measurement was taken at a selected spatial reference point to monitor power variations during testing. This fixed point was measured and used as a reference value.
2. The SAR distribution at the exposed side of the head was measured at a distance of 3.0mm from the inner surface of the shell. The area covered the entire dimension of the head and the horizontal grid spacing was 15mm x 15mm.
3. Based on the area scan data, the area of the maximum absorption was determined by spline interpolation. Around this point, a volume of 32mm x 32mm x 30mm (fine resolution volume scan, zoom scan) was assessed by measuring 5 x 5 x 7 points. On this basis of this data set, the spatial peak SAR value was evaluated with the following procedure (see Figure 7-1):
 - a. The data at the surface was extrapolated, since the center of the dipoles is 2.7mm away from the tip of the probe and the distance between the surface and the lowest measuring point is 1.2mm. The extrapolation was based on a least square algorithm [15]. A polynomial of the fourth order was calculated through the points in z-axis. This polynomial was then used to evaluate the points between the surface and the probe tip.
 - b. The maximum interpolated value was searched with a straight-forward algorithm. Around this maximum the SAR values averaged over the spatial volumes (1g or 10g) were computed using the 3D-Spline interpolation algorithm. The 3D-spline is composed of three one-dimensional splines with the "Not a knot" condition (in x, y, and z directions) [15][16]. The volume was integrated with the trapezoidal algorithm. One thousand points (10 x 10 x 10) were interpolated to calculate the average.
 - c. All neighboring volumes were evaluated until no neighboring volume with a higher average value was found.
4. The SAR reference value, at the same location as step 1, was re-measured. If the value changed by more than 5%, the evaluation is repeated.

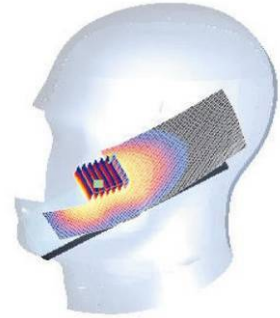



Figure 7-1
Sample SAR Area Scan

7.2 Specific Anthropomorphic Mannequin (SAM) Specifications

The phantom for handset SAR assessment testing is a low-loss dielectric shell, with shape and dimensions derived from the anthropometric data of the 90th percentile adult male head dimensions as tabulated by the US Army. The SAM Twin Phantom shell is bisected along the mid-sagittal plane into right and left halves (see Figure 7-2). The perimeter sidewalls of each phantom halves are extended to allow filling with liquid to a depth that is sufficient to minimized reflections from the upper surface. The liquid depth is maintained at a minimum depth of 15cm to minimize reflections from the upper surface.



Figure 7-2
SAM Twin Phantom Shell

FCC ID: AEZSCP-32H	 PCTEST Complete Wireless Lab	CERTIFICATION REPORT	 SANYO	Reviewed by: Quality Manager
SAR Filename: 06012041093	Test Dates: 12/04/06 - 12/06/06	EUT Type: Tri-Mode Dual-Band Analog/PCS Phone with Bluetooth		Page 10 of 27

8.1 EAR REFERENCE POINT

Figure 8-1 shows the front, back and side views of the SAM Twin Phantom. The point "M" is the reference point for the center of the mouth, "LE" is the left ear reference point (ERP), and "RE" is the right ERP. The ERP is 15mm posterior to the entrance to the ear canal (EEC) along the B-M line (Back-Mouth), as shown in Figure 8-1. The plane passing through the two ear canals and M is defined as the Reference Plane. The line N-F (Neck-Front) is perpendicular to the reference plane and passing through the RE (or LE) is called the Reference Pivoting Line (see Figure 8-2). Line B-M is perpendicular to the N-F line. Both N-F and B-M lines are marked on the external phantom shell to facilitate handset positioning [5].

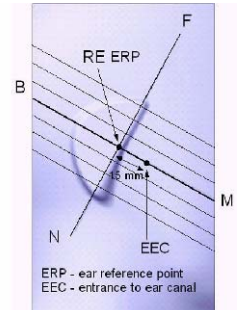

Figure 8-1
Close-Up Side view
of ERP

8.2 HANDSET REFERENCE POINTS

Two imaginary lines on the handset were established: the vertical centerline and the horizontal line. The test device was placed in a normal operating position with the "test device reference point" located along the "vertical centerline" on the front of the device aligned to the "ear reference point" (See Figure 8-3). The "test device reference point" was then located at the same level as the center of the ear reference point. The test device was positioned so that the "vertical centerline" was bisecting the front surface of the handset at its top and bottom edges, positioning the "ear reference point" on the outer surface of the both the left and right head phantoms on the ear reference point.



Figure 8-2
Front, back and side view of SAM Twin Phantom

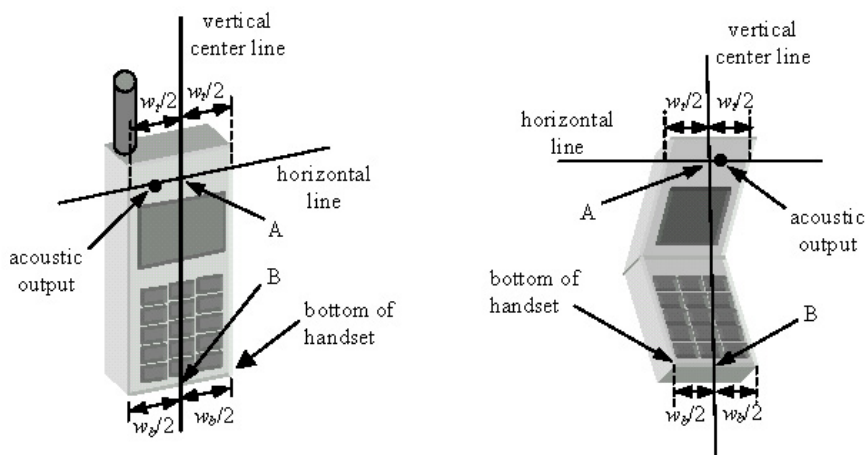



Figure 8-3
Handset Vertical Center & Horizontal Line Reference Points

FCC ID: AEZSCP-32H	 PCTEST Complete Wireless Lab	CERTIFICATION REPORT	 SANYO	Reviewed by: Quality Manager
SAR Filename: 06012041093	Test Dates: 12/04/06 - 12/06/06	EUT Type: Tri-Mode Dual-Band Analog/PCS Phone with Bluetooth		Page 11 of 27

9

TEST CONFIGURATION POSITIONS

9.1 Positioning for Cheek/Touch

1. The test device was positioned with the handset close to the surface of the phantom such that point A is on the (virtual) extension of the line passing through points RE and LE on the phantom (see Figure 9-1), such that the plane defined by the vertical center line and the horizontal line of the phone is approximately parallel to the sagittal plane of the phantom.

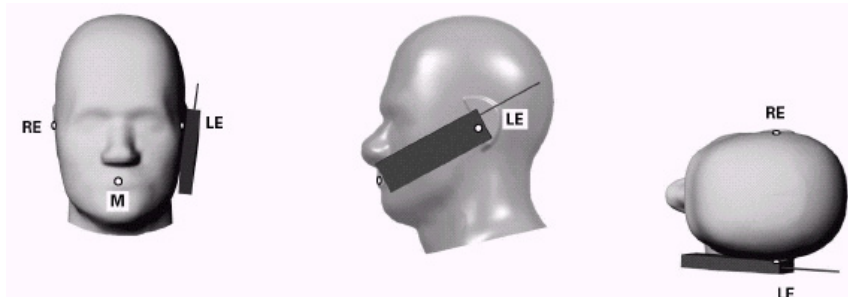

Figure 9-1 Front, Side and Top View of Cheek/Touch Position

2. The handset was translated towards the phantom along the line passing through RE & LE until the handset touches the ear.
3. While maintaining the handset in this plane, the handset was rotated around the LE-RE line until the vertical centerline was in the plane normal to MB-NF including the line MB (reference plane).
4. The phone was then rotated around the vertical centerline until the phone (horizontal line) was symmetrical with respect to the line NF.
5. While maintaining the vertical centerline in the reference plane, keeping point A on the line passing through RE and LE, and maintaining the phone contact with the ear, the handset was rotated about the line NF until any point on the handset made contact with a phantom point below the ear (cheek). See Figure 9-2)

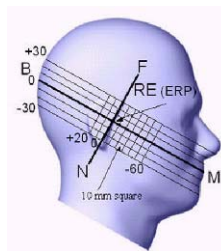



Figure 9-2 Side view w/ relevant markings

9.2 Positioning for Ear / 15° Tilt

With the test device aligned in the “Cheek/Touch Position”:

1. While maintaining the orientation of the phone, the phone was retracted parallel to the reference plane far enough to enable a rotation of the phone by 15 degree.
2. The phone was then rotated around the horizontal line by 15 degree.
3. While maintaining the orientation of the phone, the phone was moved parallel to the reference plane until any part of the phone touches the head. (In this position, point A was located on the line RE-LE). The tilted position is obtained when the contact is on the pinna. If the contact was at any location other than the pinna, the angle of the phone would then be reduced. The tilted

FCC ID: AEZSCP-32H	 PCTEST Complete Wireless Lab	CERTIFICATION REPORT	 SANYO	Reviewed by: Quality Manager
SAR Filename: 06012041093	Test Dates: 12/04/06 - 12/06/06	EUT Type: Tri-Mode Dual-Band Analog/PCS Phone with Bluetooth		Page 12 of 27

position was obtained when any part of the phone was in contact of the ear as well as a second part of the phone was in contact with the head (see Figure 9-3).

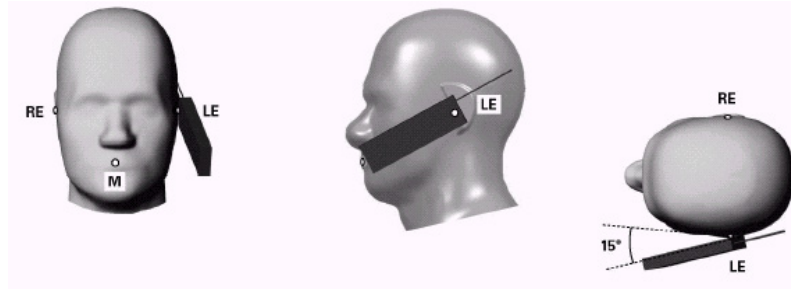

Figure 9-3 Front, Side and Top View of Ear/15° Tilt Position

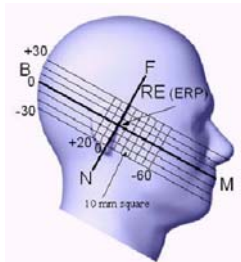

Figure 9-4
Side view w/ relevant markings



Figure 9-5 Body SAR Sample Photo
(Not Actual EUT)



9.3 Body Holster /Belt Clip Configurations

Body-worn operating configurations are tested with the belt-clips and holsters attached to the device and positioned against a flat phantom in a normal use configuration (see Figure 9-5). A device with a headset output is tested with a headset connected to the device.

Accessories for Body-worn operation configurations are divided into two categories: those that do not contain metallic components and those that do contain metallic components. When multiple accessories that do not contain metallic components are supplied with the device, the device is tested with only the accessory that dictates the closest spacing to the body. Then multiple accessories that contain metallic components are tested with the device with each accessory. If multiple accessories share an identical metallic component (i.e. the same metallic belt-clip used with different holsters with no other metallic components) only the accessory that dictates the closest spacing to the body is tested.

Body-worn accessories may not always be supplied or available as options for some devices intended to be authorized for body-worn use. In this case, a test configuration with a separation distance between the back of the device and the flat phantom is used. Test position spacing was documented. Transmitters that are designed to operate in front of a person's face, as in push-to-talk configurations, are tested for SAR compliance with the front of the device positioned to face the flat phantom in brain fluid. For devices that are carried next to the body such as a shoulder, waist or chest-worn transmitters, SAR compliance is tested with the accessories, including headsets and microphones, attached to the device and positioned against a flat phantom in a normal use configuration.

In all cases SAR measurements are performed to investigate the worst-case positioning. Worst-case positioning is then documented and used to perform Body SAR testing.

FCC ID: AEZSCP-32H		CERTIFICATION REPORT		Reviewed by: Quality Manager
SAR Filename: 06012041093	Test Dates: 12/04/06 - 12/06/06	EUT Type: Tri-Mode Dual-Band Analog/PCS Phone with Bluetooth		Page 13 of 27

10 ANSI/IEEE C95.1-2005 RF EXPOSURE LIMITS

10.1 Uncontrolled Environment

UNCONTROLLED ENVIRONMENTS are defined as locations where there is the exposure of individuals who have no knowledge or control of their exposure. The general population/uncontrolled exposure limits are applicable to situations in which the general public may be exposed or in which persons who are exposed as a consequence of their employment may not be made fully aware of the potential for exposure or cannot exercise control over their exposure. Members of the general public would come under this category when exposure is not employment-related; for example, in the case of a wireless transmitter that exposes persons in its vicinity.



10.2 Controlled Environment

CONTROLLED ENVIRONMENTS are defined as locations where there is exposure that may be incurred by persons who are aware of the potential for exposure, (i.e. as a result of employment or occupation). In general, occupational/controlled exposure limits are applicable to situations in which persons are exposed as a consequence of their employment, who have been made fully aware of the potential for exposure and can exercise control over their exposure. This exposure category is also applicable when the exposure is of a transient nature due to incidental passage through a location where the exposure levels may be higher than the general population/uncontrolled limits, but the exposed person is fully aware of the potential for exposure and can exercise control over his or her exposure by leaving the area or by some other appropriate means.

Table 10-1
SAR Human Exposure Specified in ANSI/IEEE C95.1-2005

HUMAN EXPOSURE LIMITS		
	UNCONTROLLED ENVIRONMENT <i>General Population</i> (W/kg) or (mW/g)	CONTROLLED ENVIRONMENT <i>Occupational</i> (W/kg) or (mW/g)
SPATIAL PEAK SAR Brain	1.6	8.0
SPATIAL AVERAGE SAR Whole Body	0.08	0.4
SPATIAL PEAK SAR Hands, Feet, Ankles, Wrists	4.0	20



- 1 The Spatial Peak value of the SAR averaged over any 1 gram of tissue (defined as a tissue volume in the shape of a cube) and over the appropriate averaging time.
- 2 The Spatial Average value of the SAR averaged over the whole body.
- 3 The Spatial Peak value of the SAR averaged over any 10 grams of tissue (defined as a tissue volume in the shape of a cube) and over the appropriate averaging time.

FCC ID: AEZSCP-32H	 PCTEST Complete Wireless Lab	CERTIFICATION REPORT	 SANYO	Reviewed by: Quality Manager
SAR Filename: 06012041093	Test Dates: 12/04/06 - 12/06/06	EUT Type: Tri-Mode Dual-Band Analog/PCS Phone with Bluetooth		Page 14 of 27

11 MEASUREMENT UNCERTAINTIES

a	b	c	d	e= f(d,k)	f	g	h = c x f/e	i = c x g/e	k
Uncertainty Component	IEEE 1528 Sec.	Tol. (± %)	Prob. Dist.	Div.	c _i 1gm	c _i 10 gms	1gm u _i (± %)	10gms u _i (± %)	v _i
Measurement System									
Probe Calibration	E.2.1	6.6	N	1	1.0	1.0	6.6	6.6	∞
Axial Isotropy	E.2.2	0.25	N	1	0.7	0.7	0.2	0.2	∞
Hemishperical Isotropy	E.2.2	1.3	N	1	1.0	1.0	1.3	1.3	∞
Boundary Effect	E.2.3	0.4	N	1	1.0	1.0	0.4	0.4	∞
Linearity	E.2.4	0.3	N	1	1.0	1.0	0.3	0.3	∞
System Detection Limits	E.2.5	5.1	N	1	1.0	1.0	5.1	5.1	∞
Readout Electronics	E.2.6	1.0	N	1	1.0	1.0	1.0	1.0	∞
Response Time	E.2.7	0.8	R	1.73	1.0	1.0	0.5	0.5	∞
Integration Time	E.2.8	2.6	R	1.73	1.0	1.0	1.5	1.5	∞
RF Ambient Conditions	E.6.1	3.0	R	1.73	1.0	1.0	1.7	1.7	∞
Probe Positioner Mechanical Tolerance	E.6.2	0.4	R	1.73	1.0	1.0	0.2	0.2	∞
Probe Positioning w/ respect to Phantom	E.6.3	2.9	R	1.73	1.0	1.0	1.7	1.7	∞
Extrapolation, Interpolation & Integration algorithms for Max. SAR Evaluation	E.5	1.0	R	1.73	1.0	1.0	0.6	0.6	∞
Test Sample Related									
Test Sample Positioning	E.4.2	6.0	N	1	1.0	1.0	6.0	6.0	287
Device Holder Uncertainty	E.4.1	3.32	R	1.73	1.0	1.0	1.9	1.9	∞
Output Power Variation - SAR drift measurement	6.6.2	5.0	R	1.73	1.0	1.0	2.9	2.9	∞
Phantom & Tissue Parameters									
Phantom Uncertainty (Shape & Thickness tolerances)	E.3.1	4.0	R	1.73	1.0	1.0	2.3	2.3	∞
Liquid Conductivity - deviation from target values	E.3.2	5.0	R	1.73	0.64	0.43	1.8	1.2	∞
Liquid Conductivity - measurement uncertainty	E.3.3	3.8	N	1	0.64	0.43	2.4	1.6	6
Liquid Permittivity - deviation from target values	E.3.2	5.0	R	1.73	0.60	0.49	1.7	1.4	∞
Liquid Permittivity - measurement uncertainty	E.3.3	4.5	N	1	0.60	0.49	2.7	2.2	6
Combined Standard Uncertainty (k=1)				RSS			12.4	12.0	299
Expanded Uncertainty (95% CONFIDENCE LEVEL)				k=2			24.7	24.0	

The above measurement uncertainties are according to IEEE Std. 1528-2003

FCC ID: AEZSCP-32H	 PCTEST Complete Wireless Lab	CERTIFICATION REPORT	 SANYO	Reviewed by: Quality Manager
SAR Filename: 06012041093	Test Dates: 12/04/06 - 12/06/06	EUT Type: Tri-Mode Dual-Band Analog/PCS Phone with Bluetooth		Page 15 of 27

12 SYSTEM VERIFICATION

12.1 Tissue Verification

Table 12-1

Calibrated Date:	12/04/06		12/04/06		12/04/06		12/04/06	
	835H		835M		1900H		1900M	
	Target	Measured	Target	Measured	Target	Measured	Target	Measured
Dielectric Constant	41.5	40.4	55.2	54.7	40.0	39.4	53.3	54.4
Conductivity	0.90	0.90	0.97	0.97	1.40	1.44	1.52	1.56

Measured Tissue Properties

12.2 Test System Verification

Prior to assessment, the system is verified to $\pm 10\%$ of the specifications at 835 MHz and 1900 MHz by using the system validation kit(s). (Graphic Plots Attached)

Table 12-2
System Verification Results

System Verification TARGET & MEASURED							
Date:	Amb. Temp (?C)	Liquid Temp(?C)	Input Power (W)	Tissue Frequency (Mhz)	Targeted SAR _{1g} (mW)	Measured SAR _{1g} (mW)	Deviation (%)
12/04/06	23.3	21.4	0.25	835	2.38	2.4	1.1%
12/05/06	23.5	21.6	0.25	835	2.38	2.34	-1.5%
12/06/06	23.2	21	0.25	835	2.38	2.43	2.3%
12/05/06	23.1	21.1	0.1	1900	3.97	4.15	4.5%
12/06/06	23.8	21.4	0.1	1900	3.97	4.07	2.5%

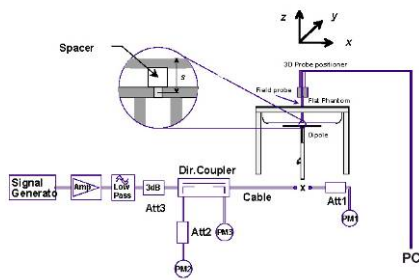



Figure 12-1
System Verification Setup Diagram



Figure 12-2
System Verification Setup Photo

FCC ID: AEZSCP-32H		CERTIFICATION REPORT		Reviewed by: Quality Manager
SAR Filename: 06012041093	Test Dates: 12/04/06 - 12/06/06	EUT Type: Tri-Mode Dual-Band Analog/PCS Phone with Bluetooth		Page 16 of 27

13 FCC 3G MEASUREMENT PROCEDURES – JUNE 2006

Power measurements were performed using a base station simulator under digital average power.

13.1 Procedures Used to Establish RF Signal for SAR

The device was placed into a simulated call using a base station simulator in a shielded chamber. Such test signals offer a consistent means for testing SAR and are recommended for evaluating SAR [4]. SAR measurements were taken with a fully charged battery. In order to verify that the device was tested and maintained at full power, it was configured with the base station simulator. The SAR measurement software calculates a reference point at the start and end of the test to check for power drifts. If conducted power deviations of more than 5% occurred, the tests were repeated.

13.2 SAR Measurement Conditions for CDMA2000

The following procedures were followed according to FCC “SAR Measurement Procedures for 3G Devices”, June 2006.

13.2.1 Output Power Verification

See 3GPP2 C.S0011/TIA-98-E as recommended by “SAR Measurement Procedures for 3G Devices”, June 2006. Maximum output power is verified on the High, Middle and Low channels according to procedures in section 4.4.5.2 of 3GPP2 C.S0011/TIA-98-E. SO55 tests were measured with power control bits in “All Up” condition. .

1. If the mobile station (MS) supports Reverse TCH RC 1 and Forward TCH RC 1, set up a call using Fundamental Channel Test Mode 1 (RC=1/1) with 9600 bps data rate only.
2. Under RC1, C.S0011 Table 4.4.5.2-1, Table 13-1 parameters were applied.
3. If the MS supports the RC 3 Reverse FCH, RC3 Reverse SCH0 and demodulation of RC 3,4, or 5, set up a call using Supplemental Channel Test Mode 3 (RC 3/3) with 9600 bps Fundamental Channel and 9600 bps SCH0 data rate.
4. Under RC3, C.S0011 Table 4.4.5.2-2, Table 13-2 was applied.
5. FCHs were configured at full rate for maximum SAR with “All Up” power control bits.

**Table 13-1
Parameters for Max. Power for RC1**



Parameter	Units	Value
I_{or}	dBm/1.23 MHz	-104
$\frac{Pilot E_c}{I_{or}}$	dB	-7
$\frac{Traffic E_c}{I_{or}}$	dB	-7.4

**Table 13-2
Parameters for Max. Power for RC3**

Parameter	Units	Value
I_{or}	dBm/1.23 MHz	-86
$\frac{Pilot E_c}{I_{or}}$	dB	-7
$\frac{Traffic E_c}{I_{or}}$	dB	-7.4

13.2.2 Head SAR Measurements

SAR for head exposure configurations is measured in RC3 with the DUT configured to transmit at full rate using Loopback Service Option SO55. SAR for RC1 is not required when the maximum average output of each channel is less than ¼ dB higher than that measured in RC3. Otherwise, SAR is measured on the maximum output channel in RC1 using the exposure configuration that results in the highest SAR for that channel in RC3.

FCC ID: AEZSCP-32H	 PCTEST Complete Wireless Lab	CERTIFICATION REPORT	 SANYO	Reviewed by: Quality Manager
SAR Filename: 06012041093	Test Dates: 12/04/06 - 12/06/06	EUT Type: Tri-Mode Dual-Band Analog/PCS Phone with Bluetooth		Page 17 of 27

13.2.3 Body SAR Measurements

SAR for body exposure configurations is measured in RC3 with the DUT configured to transmit at full rate on FCH with all other code channels disabled using TDSO / SO32. SAR for multiple code channels (FCH + SCHn) is not required when the maximum average output of each RF channel is less than ¼ dB higher than that measured with FCH only. Otherwise, SAR is measured on the maximum output channel (FCH + SCHn) with FCH at full rate and SCH0 enabled at 9600 bps using the exposure configuration that results in the highest SAR for that channel with FCH only. When multiple code channels are enabled, the DUT output may shift by more than 0.5 dB and lead to higher SAR drifts and SCH dropouts. Body SAR was measured using TDSO / SO32 with power control bits in the “All Up”

Body SAR in RC1 is not required when the maximum average output of each channel is less than ¼ dB higher than that measured in RC3. Otherwise, SAR is measured on the maximum output channel in RC1; with Loopback Service Option SO55, at full rate, using the body exposure configuration that results in the highest SAR for that channel in RC3.

13.2.4 Handsets with EVDO

For handsets with Ev-Do capabilities, when the maximum average output of each channel in Rev. 0 is less than ¼ dB higher than that measured in RC3 (1x RTT), body SAR for EV-DO is not required.⁷ Otherwise, SAR for Rev. 0 is measured on the maximum output channel at 153.6 kbps using the body exposure configuration that results in the highest SAR for that channel in RC3.⁷ SAR for Rev. A is not required when the maximum average output of each channel is less than that measured in Rev. 0 or less than ¼ dB higher than that measured in RC3. Otherwise, SAR is measured on the maximum output channel for Rev. A using a Reverse Data Channel payload size of 4096 bits and a Termination Target of 16 slots defined for Subtype 2 Physical Layer configurations. A Forward Traffic Channel data rate corresponding to the 2-slot version of 307.2 kbps with the ACK Channel transmitting in all slots should be configured in the downlink for both Rev. 0 and Rev. A.

13.3 Handset Capabilities*:

*See Device Capabilities attachment for applicable device modes and powers.

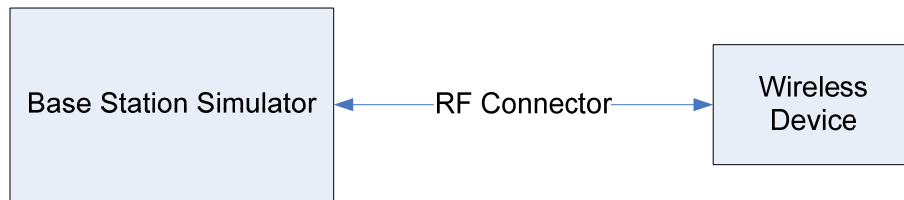



Figure 13-1
Power Measurement Setup

FCC ID: AEZSCP-32H	 PCTEST Complete Wireless Lab	CERTIFICATION REPORT	 SANYO	Reviewed by: Quality Manager
SAR Filename: 06012041093	Test Dates: 12/04/06 - 12/06/06	EUT Type: Tri-Mode Dual-Band Analog/PCS Phone with Bluetooth		Page 18 of 27



14 SAR DATA SUMMARY

14.1 AMPS Head SAR Results

MEASUREMENT RESULTS										
FREQUENCY		Mode	C_Power[dBm]		Side	Test Position	Antenna Type	Battery	Bluetooth	SAR (W/kg)
MHz	Ch.		Start	End						
824.04	991	AMPS	24.28	24.28	Right	Touch	Internal	Standard	off	1.350
836.49	383	AMPS	24.71	24.72	Right	Touch	Internal	Standard	off	1.320
848.97	799	AMPS	24.22	24.14	Right	Touch	Internal	Standard	off	1.400
848.97	799	AMPS	24.22	24.07	Right	Touch	Internal	Extended	off	1.340
848.97	799	AMPS	24.22	24.12	Right	Touch	Internal	Standard	on	1.340
836.49	383	AMPS	24.71	24.73	Right	Tilt	Internal	Standard	off	0.415
824.04	991	AMPS	24.28	24.13	Left	Touch	Internal	Standard	off	1.260
836.49	383	AMPS	24.71	24.88	Left	Touch	Internal	Standard	off	1.210
848.97	799	AMPS	24.22	24.20	Left	Touch	Internal	Standard	off	1.270
848.97	799	AMPS	24.22	24.40	Left	Touch	Internal	Extended	off	1.150
848.97	799	AMPS	24.22	24.34	Left	Touch	Internal	Standard	on	1.230
836.49	383	AMPS	24.71	24.68	Left	Tilt	Internal	Standard	off	0.332
ANSI / IEEE C95.1 2005 - SAFETY LIMIT Spatial Peak Uncontrolled Exposure/General Population						Brain 1.6 W/kg (mW/g) averaged over 1 gram				

Notes:

1. The test data reported are the worst-case SAR value with the position set in a typical configuration. Test procedures used are according to FCC/OET Bulletin 65, Supplement C [July 2001].
2. All modes of operation were investigated, and worst-case results are reported.
3. Batteries are fully charged for all readings. Standard and Extended batteries were investigated..
4. Tissue parameters and temperatures are listed on the SAR plots.
5. Liquid tissue depth is 15.1 cm. ± 0.1.
6. Justification for reduced test configurations: Per FCC/OET Bulletin 65 Supplement C (July, 2001), if the SAR measured at the middle channel for each test configuration (left, right, cheek/touch, tilt/ear, extended and retracted) is at least 3.0 dB lower than the SAR limit, testing at the high and low channels is optional for such test configuration(s).



FCC ID: AEZSCP-32H	 PCTEST Complete Wireless Lab	CERTIFICATION REPORT	 SANYO	Reviewed by: Quality Manager
SAR Filename: 06012041093	Test Dates: 12/04/06 - 12/06/06	EUT Type: Tri-Mode Dual-Band Analog/PCS Phone with Bluetooth		Page 19 of 27

14.2 Cellular Band Head SAR Results

MEASUREMENT RESULTS											
FREQUENCY		Mode	C_Power[dBm]		Side	Test Position	Antenna Type	Battery	Bluetooth	SAR	
MHz	Ch.		Start	End						(W/kg)	
824.70	1013	CDMA	23.85	23.68	Right	Touch	Internal	Standard	off	1.140	
836.49	383	CDMA	24.05	23.94	Right	Touch	Internal	Standard	off	0.953	
848.31	777	CDMA	24.03	24.02	Right	Touch	Internal	Standard	off	1.250	
848.31	777	CDMA	24.03	24.12	Right	Touch	Internal	Extended	off	1.110	
848.31	777	CDMA	24.03	23.91	Right	Touch	Internal	Standard	on	1.220	
836.49	383	CDMA	24.05	24.01	Right	Tilt	Internal	Standard	off	0.303	
824.70	1013	CDMA	23.85	23.75	Left	Touch	Internal	Standard	off	1.070	
836.49	383	CDMA	24.05	24.07	Left	Touch	Internal	Standard	off	0.935	
848.31	777	CDMA	24.03	24.14	Left	Touch	Internal	Standard	off	1.210	
848.31	777	CDMA	24.03	23.92	Left	Touch	Internal	Extended	off	1.110	
848.31	777	CDMA	24.03	24.11	Left	Touch	Internal	Standard	on	1.150	
836.49	383	CDMA	24.05	23.92	Left	Tilt	Internal	Standard	off	0.281	
ANSI / IEEE C95.1 2005 - SAFETY LIMIT						Brain					
Spatial Peak						1.6 W/kg (mW/g)					
Uncontrolled Exposure/General Population						averaged over 1 gram					

Notes:

1. The test data reported are the worst-case SAR value with the position set in a typical configuration. Test procedures used are according to FCC/OET Bulletin 65, Supplement C [July 2001].
2. All modes of operation were investigated, and worst-case results are reported.
3. Batteries are fully charged for all readings. Standard and Extended batteries were investigated..
4. Tissue parameters and temperatures are listed on the SAR plots.
5. Liquid tissue depth is 15.1 cm. \pm 0.1.
6. Justification for reduced test configurations: Per FCC/OET Bulletin 65 Supplement C (July, 2001), if the SAR measured at the middle channel for each test configuration (left, right, cheek/touch, tilt/ear, extended and retracted) is at least 3.0 dB lower than the SAR limit, testing at the high and low channels is optional for such test configuration(s).
7. Head SAR was tested under RC3/SO55



FCC ID: AEZSCP-32H	 PCTEST Complete Wireless Lab	CERTIFICATION REPORT	 SANYO	Reviewed by: Quality Manager
SAR Filename: 06012041093	Test Dates: 12/04/06 - 12/06/06	EUT Type: Tri-Mode Dual-Band Analog/PCS Phone with Bluetooth	Page 20 of 27	

14.3 PCS Band Head SAR Results

MEASUREMENT RESULTS										
FREQUENCY		Mode	C_Power[dBm]		Side	Test Position	Antenna Type	Battery	Bluetooth	SAR
MHz	Ch.		Start	End						(W/kg)
1851.25	25	PCS	24.08	24.07	Right	Touch	Internal	Standard	off	1.300
1880.00	600	PCS	24.02	24.15	Right	Touch	Internal	Standard	off	1.410
1908.75	1175	PCS	23.91	24.06	Right	Touch	Internal	Standard	off	1.330
1880.00	600	PCS	24.02	24.18	Right	Touch	Internal	Extended	off	1.320
1880.00	600	PCS	24.02	23.92	Right	Touch	Internal	Standard	on	1.390
1880.00	600	PCS	24.02	24.13	Right	Tilt	Internal	Standard	off	0.228
1851.25	25	PCS	24.08	23.98	Left	Touch	Internal	Standard	off	1.000
1880.00	600	PCS	24.02	24.08	Left	Touch	Internal	Standard	off	0.837
1908.75	1175	PCS	23.91	24.09	Left	Touch	Internal	Standard	off	1.070
1908.75	1175	PCS	23.91	24.03	Left	Touch	Internal	Extended	off	0.917
1908.75	1175	PCS	23.91	24.10	Left	Touch	Internal	Standard	on	1.070
1880.00	600	PCS	24.02	23.90	Left	Tilt	Internal	Standard	off	0.174
ANSI / IEEE C95.1 2005 - SAFETY LIMIT Spatial Peak Uncontrolled Exposure/General Population						Brain 1.6 W/kg (mW/g) averaged over 1 gram				

Notes:

1. The test data reported are the worst-case SAR value with the position set in a typical configuration. Test procedures used are according to FCC/OET Bulletin 65, Supplement C [July 2001].
2. All modes of operation were investigated, and worst-case results are reported.
3. Batteries are fully charged for all readings. Standard and Extended batteries were investigated..
4. Tissue parameters and temperatures are listed on the SAR plots.
5. Liquid tissue depth is 15.1 cm. ± 0.1.
6. Justification for reduced test configurations: Per FCC/OET Bulletin 65 Supplement C (July, 2001), if the SAR measured at the middle channel for each test configuration (left, right, cheek/touch, tilt/ear, extended and retracted) is at least 3.0 dB lower than the SAR limit, testing at the high and low channels is optional for such test configuration(s).
7. Head SAR was tested under RC3/SO55.



FCC ID: AEZSCP-32H	 PCTEST Complete Wireless Lab	CERTIFICATION REPORT	 SANYO	Reviewed by: Quality Manager
SAR Filename: 06012041093	Test Dates: 12/04/06 - 12/06/06	EUT Type: Tri-Mode Dual-Band Analog/PCS Phone with Bluetooth		Page 21 of 27

14.4 Body SAR Results

MEASUREMENT RESULTS											
FREQUENCY		Mode	C_Power[dBm]		Position	Spacing	Antenna Type	Battery	Bluetooth	Side	SAR
MHz	Ch.		Start	End							(W/kg)
836.49	383	AMPS	24.71	24.66	Body	2.2 cm	Internal	Standard	off	back	0.442
836.49	383	AMPS	24.71	24.64	Body	2.2 cm	Internal	Extended	off	back	0.358
836.49	383	AMPS	24.71	24.88	Body	2.2 cm	Internal	Standard	on	back	0.424
836.49	383	AMPS	24.71	24.79	Body	2.2 cm	Internal	Standard	off	front	0.160
836.49	383	CDMA	24.07	23.88	Body	2.2 cm	Internal	Standard	off	back	0.362
836.49	383	CDMA	24.07	24.07	Body	2.2 cm	Internal	Extended	off	back	0.295
836.49	383	CDMA	24.07	23.89	Body	2.2 cm	Internal	Standard	on	back	0.361
836.49	383	CDMA	24.07	24.05	Body	2.2 cm	Internal	Standard	off	front	0.139
1880.00	600	PCS	24.09	24.11	Body	2.2 cm	Internal	Standard	off	back	0.295
1880.00	600	PCS	24.09	24.08	Body	2.2 cm	Internal	Extended	off	back	0.259
1880.00	600	PCS	24.09	23.80	Body	2.2 cm	Internal	Standard	on	back	0.285
1880.00	600	PCS	24.09	24.01	Body	2.2 cm	Internal	Standard	off	front	0.150
ANSI / IEEE C95.1 2005 - SAFETY LIMIT Spatial Peak Uncontrolled Exposure/General Population						Muscle 1.6 W/kg (mW/g) averaged over 1 gram					

Notes:

1. The test data reported are the worst-case SAR value with the position set in a typical configuration. Test procedures used are according to FCC/OET Bulletin 65, Supplement C [July 2001].
2. All modes of operation were investigated, and worst-case results are reported.
3. Batteries are fully charged for all readings. Standard and Extended batteries were investigated..
4. Tissue parameters and temperatures are listed on the SAR plots.
5. Both sides of the phone were tested, and the worst-case is reported.
6. Liquid tissue depth is 15.1 cm. ± 0.1.
7. Device was tested using a fixed spacing.
8. Body SAR was tested under RC3/SO32



FCC ID: AEZSCP-32H	 PCTEST Complete Wireless Lab www.pctest.com	CERTIFICATION REPORT	 SANYO	Reviewed by: Quality Manager
SAR Filename: 06012041093	Test Dates: 12/04/06 - 12/06/06	EUT Type: Tri-Mode Dual-Band Analog/PCS Phone with Bluetooth	Page 22 of 27	

14.5 Face SAR Results

MEASUREMENT RESULTS											
FREQUENCY		Mode	C_Power[dBm]		Position	Spacing	Flip	Antenna Type	Battery	Bluetooth	SAR
MHz	Ch.		Start	End							(W/kg)
1880.00	600	PCS	24.02	24.19	Face	2.54 cm	Open	Internal	Standard	off	0.233
1880.00	600	PCS	24.02	23.89	Face	2.54 cm	Closed	Internal	Standard	off	0.135
ANSI / IEEE C95.1 2005 - SAFETY LIMIT Spatial Peak Uncontrolled Exposure/General Population						Brain 1.6 W/kg (mW/g) averaged over 1 gram					

Notes:

1. The test data reported are the worst-case SAR value with the position set in a typical configuration. Test procedures used are according to FCC/OET Bulletin 65, Supplement C [July 2001].
2. All modes of operation were investigated, and worst-case results are reported.
3. Batteries are fully charged for all readings.
4. Tissue parameters and temperatures are listed on the SAR plots.
5. Liquid tissue depth is 15.1 cm. \pm 0.1.
6. Justification for reduced test configurations: Per FCC/OET Bulletin 65 Supplement C (July, 2001), if the SAR measured at the middle channel for each test configuration (left, right, cheek/touch, tilt/ear, extended and retracted) is at least 3.0 dB lower than the SAR limit, testing at the high and low channels is optional for such test configuration(s).
7. Face SAR was tested under RC3/SO55.



FCC ID: AEZSCP-32H	 PCTEST Complete Wireless Lab	CERTIFICATION REPORT	 SANYO	Reviewed by: Quality Manager
SAR Filename: 06012041093	Test Dates: 12/04/06 - 12/06/06	EUT Type: Tri-Mode Dual-Band Analog/PCS Phone with Bluetooth		Page 23 of 27

15 EQUIPMENT LIST

Manufacturer	Model / Equipment	Calibration Date	Cal Interval	Calibration Due	Serial No.
Agilent	8753E (30kHz-6GHz) Network Analyzer	5/25/2006	Annual	5/25/2007	JP38020182
Agilent	N4010A Wireless Connectivity Test Set	6/11/2006	Annual	6/11/2007	GB46170464
Agilent	E5515C Wireless Communications Test Set	7/27/2006	Annual	7/27/2007	GB41450275
Agilent	E5515C Wireless Communications Test Set	10/6/2006	Annual	10/6/2007	GB43193972
Agilent	8648D (9kHz-4GHz) Signal Generator	10/1/2006	Annual	10/1/2007	3613A00315
Gigatronics	8657A Universal Power Meter	4/7/2006	Annual	4/7/2007	8650319
Gigatronics	80701A (0.05-18GHz) Power Sensor	4/11/2006	Annual	4/11/2007	1833460
Rohde & Schwarz	NRVS Power Meter	6/1/2005	Biennial	6/1/2007	835360/079
Rohde & Schwarz	NRV-Z53 Power Sensor	6/1/2005	Biennial	6/1/2007	846076/007
Rohde & Schwarz	CMU200 Base Station Simulator	11/8/2006	Annual	11/8/2007	107826
Rohde & Schwarz	CMU200 Base Station Simulator	7/26/2006	Annual	7/26/2007	833855/010
Rohde & Schwarz	CMU200 Base Station Simulator	4/20/2006	Annual	4/20/2007	836371/079
SPEAG	D1900V2 1900 MHz SAR Dipole	3/9/2005	Biennial	3/9/2007	502
SPEAG	D835V2 835MHz SAR Dipole	8/24/2005	Biennial	8/24/2007	4d026
SPEAG	D2450V2 2450 MHz SAR Dipole	9/25/2005	Biennial	9/25/2007	719
SPEAG	D5GHzV2 5 GHz SAR Dipole	10/5/2005	Biennial	10/5/2007	1007
SPEAG	EX3DV4 SAR Probe	1/18/2006	Annual	1/18/2007	3550
SPEAG	DAE4	6/1/2006	Annual	6/1/2007	704
SPEAG	EX3DV4 SAR Probe	7/14/2006	Annual	7/14/2007	3589
SPEAG	DAE4	9/4/2006	Annual	9/4/2007	665
SPEAG	EX3DV4 SAR Probe	11/23/2006	Annual	11/23/2007	3561
SPEAG	ES3DV2 SAR Probe	9/20/2006	Annual	9/20/2007	3022
SPEAG	DAE3	10/16/2006	Annual	10/16/2007	455
Agilent	E8257D (250kHz-20GHz) Signal Generator	2/11/2006	Annual	2/11/2007	MY45470194
Agilent	E8257D (250kHz-20GHz) Signal Generator	3/30/2006	Annual	3/30/2007	MY44320964
Extech	421305 Digital Thermometer	N/A	Annual	N/A	426966

Notes:

The E-field probe was calibrated by SPEAG, by the waveguide technique procedure. Dipole Validation measurement is performed by PCTEST prior to SAR evaluation. The brain simulating material is calibrated by PCTEST using the dielectric probe system and network analyzer to determine the conductivity and permittivity (dielectric constant) of the brain-equivalent material.



FCC ID: AEZSCP-32H	 PCTEST Complete Wireless Lab	CERTIFICATION REPORT	 SANYO	Reviewed by: Quality Manager
SAR Filename: 06012041093	Test Dates: 12/04/06 - 12/06/06	EUT Type: Tri-Mode Dual-Band Analog/PCS Phone with Bluetooth	Page 24 of 27	

16 CONCLUSION

16.1 Measurement Conclusion



The SAR evaluation indicates that the EUT complies with the RF radiation exposure limits of the FCC, with respect to all parameters subject to this test. These measurements were taken to simulate the RF effects of RF exposure under worst-case conditions. Precise laboratory measures were taken to assure repeatability of the tests. The results and statements relate only to the item(s) tested.

Please note that the absorption and distribution of electromagnetic energy in the body are very complex phenomena that depend on the mass, shape, and size of the body, the orientation of the body with respect to the field vectors, and the electrical properties of both the body and the environment. Other variables that may play a substantial role in possible biological effects are those that characterize the environment (e.g. ambient temperature, air velocity, relative humidity, and body insulation) and those that characterize the individual (e.g. age, gender, activity level, debilitation, or disease). Because various factors may interact with one another to vary the specific biological outcome of an exposure to electromagnetic fields, any protection guide should consider maximal amplification of biological effects as a result of field-body interactions, environmental conditions, and physiological variables. [3]

FCC ID: AEZSCP-32H	 PCTEST Complete Wireless Lab	CERTIFICATION REPORT		Reviewed by: Quality Manager
SAR Filename: 06012041093	Test Dates: 12/04/06 - 12/06/06	EUT Type: Tri-Mode Dual-Band Analog/PCS Phone with Bluetooth	Page 25 of 27	

17 REFERENCES

- [1] Federal Communications Commission, ET Docket 93-62, Guidelines for Evaluating the Environmental Effects of Radiofrequency Radiation, Aug. 1996.
- [2] ANSI/IEEE C95.1-2005, American National Standard safety levels with respect to human exposure to radio frequency electromagnetic fields, 300kHz to 100GHz, New York: IEEE, April 2006.
- [3] ANSI/IEEE C95.3-2002, IEEE Recommended Practice for the Measurement of Potentially Hazardous Electromagnetic Fields - RF and Microwave, New York: IEEE, December 2002.
- [4] Federal Communications Commission, OET Bulletin 65 (Edition 97-01), Supplement C (Edition 01-01), Evaluating Compliance with FCC Guidelines for Human Exposure to Radiofrequency Electromagnetic Fields, July 2001.
- [5] IEEE Standards Coordinating Committee 34 – IEEE Std. 1528-2003, Recommended Practice for Determining the Peak Spatial-Average Specific Absorption Rate (SAR) in the Human Body Due to Wireless Communications Devices.
- [6] NCRP, National Council on Radiation Protection and Measurements, Biological Effects and Exposure Criteria for RadioFrequency Electromagnetic Fields, NCRP Report No. 86, 1986. Reprinted Feb. 1995.
- [7] T. Schmid, O. Egger, N. Kuster, Automated E-field scanning system for dosimetric assessments, IEEE Transaction on Microwave Theory and Techniques, vol. 44, Jan. 1996, pp. 105-113.
- [8] K. Pokovic, T. Schmid, N. Kuster, Robust setup for precise calibration of E-field probes in tissue simulating liquids at mobile communications frequencies, ICECOM97, Oct. 1997, pp. 120-124.
- [9] K. Pokovic, T. Schmid, and N. Kuster, E-field Probe with improved isotropy in brain simulating liquids, Proceedings of the ELMAR, Zadar, Croatia, June 23-25, 1996, pp. 172-175.
- [10] Schmid & Partner Engineering AG, Application Note: Data Storage and Evaluation, June 1998, p2.
- [11] V. Hombach, K. Meier, M. Burkhardt, E. Kuhn, N. Kuster, The Dependence of EM Energy Absorption upon Human Head Modeling at 900 MHz, IEEE Transaction on Microwave Theory and Techniques, vol. 44 no. 10, Oct. 1996, pp. 1865-1873.
- [12] N. Kuster and Q. Balzano, Energy absorption mechanism by biological bodies in the near field of dipole antennas above 300MHz, IEEE Transaction on Vehicular Technology, vol. 41, no. 1, Feb. 1992, pp. 17-23.
- [13] G. Hartsgrrove, A. Kraszewski, A. Surowiec, Simulated Biological Materials for Electromagnetic Radiation Absorption Studies, University of Ottawa, Bioelectromagnetics, Canada: 1987, pp. 29-36.
- [14] Q. Balzano, O. Garay, T. Manning Jr., Electromagnetic Energy Exposure of Simulated Users of Portable Cellular Telephones, IEEE Transactions on Vehicular Technology, vol. 44, no.3, Aug. 1995.
- [15] W. Gander, Computermathematick, Birkhaeuser, Basel, 1992.
- [16] W.H. Press, S.A. Teukolsky, W.T. Vetterling, and B.P. Flannery, Numerical Receptions in C, The Art of Scientific Computing, Second edition, Cambridge University Press, 1992.

FCC ID: AEZSCP-32H	 PCTEST Complete Wireless Lab	CERTIFICATION REPORT		Reviewed by: Quality Manager
SAR Filename: 06012041093	Test Dates: 12/04/06 - 12/06/06	EUT Type: Tri-Mode Dual-Band Analog/PCS Phone with Bluetooth		Page 26 of 27

[17] Federal Communications Commission, OET Bulletin 65, Evaluating Compliance with FCC Guidelines for Human Exposure to Radiofrequency Electromagnetic Fields. Supplement C, Dec. 1997.



[18] N. Kuster, R. Kastle, T. Schmid, Dosimetric evaluation of mobile communications equipment with known precision, IEEE Transaction on Communications, vol. E80-B, no. 5, May 1997, pp. 645-652.

[19] CENELEC CLC/SC111B, European Prestandard (prENV 50166-2), Human Exposure to Electromagnetic Fields High-frequency: 10kHz-300GHz, Jan. 1995.

[20] Prof. Dr. Niels Kuster, ETH, Eidgenössische Technische Hochschule Zürich, Dosimetric Evaluation of the Cellular Phone.

[21] FCC SAR Measurement Procedures for 3G Devices, June 2006

[22] SAR Measurement procedures for IEEE 802.11a/b/g rev 1.1, Oct 2006

FCC ID: AEZSCP-32H	 PCTEST Complete Wireless Lab	CERTIFICATION REPORT		Reviewed by: Quality Manager
SAR Filename: 06012041093	Test Dates: 12/04/06 - 12/06/06	EUT Type: Tri-Mode Dual-Band Analog/PCS Phone with Bluetooth		Page 27 of 27

APPENDIX A: SAR TEST DATA

PCTEST ENGINEERING LABORATORY, INC.

DUT: SCP -3200; Type: SANYO Tri Mode Phone; Serial: A0000000030FF; Conducted Power: 24.5 dBm

Communication System: AMPS; Frequency: 848.97 MHz; Duty Cycle: 1:1
Medium: 835 Brain ($\sigma = 0.90$ mho/m, $\epsilon_r = 40.43$, $\rho = 1000$ kg/m³)
Phantom section: Right Section

Test Date: 12-04-2006; Ambient Temp: 23.3°C; Tissue Temp: 21.4°C

Probe: EX3DV4 - SN3561; ConvF(7.94, 7.94, 7.94); Calibrated: 11/23/2006
Sensor-Surface: 3mm (Mechanical Surface Detection)
Electronics: DAE3 Sn455; Calibrated: 10/16/2006
Phantom: SAM Main; Type: SAM 4.0; Serial: TP:1197
Measurement SW: DASY4, V4.7 Build 44; Postprocessing SW: SEMCAD, V1.8 Build 171

Mode: AMPS, Right Head, Touch, High.ch, Standard Battery

Area Scan (7x14x1): Measurement grid: dx=15mm, dy=15mm
Zoom Scan (5x5x7)/Cube 0: Measurement grid: dx=8mm, dy=8mm, dz=5mm
Reference Value = 12.9 V/m
Peak SAR (extrapolated) = 2.21 W/kg
SAR(1 g) = 1.4 mW/g; SAR(10 g) = 0.898 mW/g

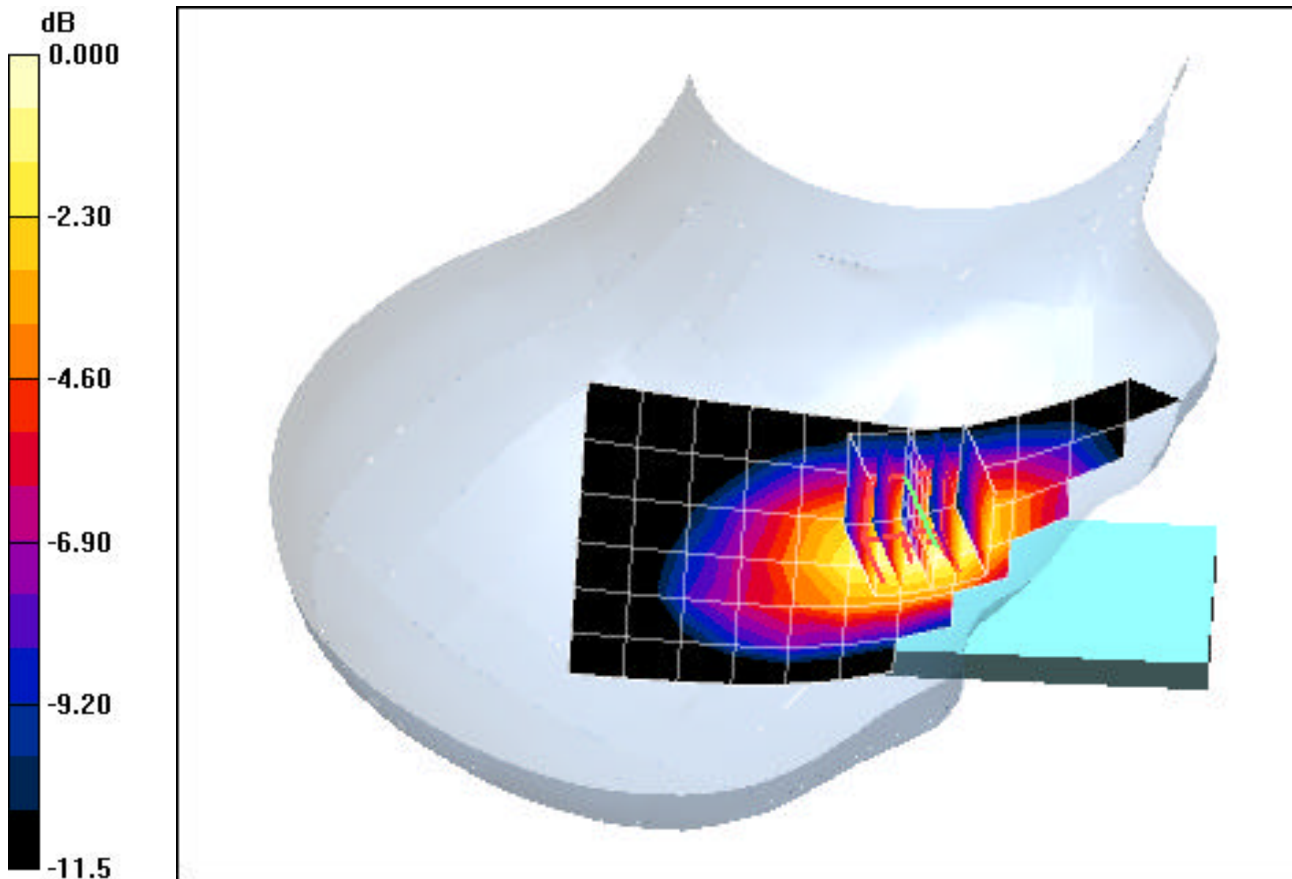

0 dB = 1.67mW/g

PCTEST ENGINEERING LABORATORY, INC.

DUT: SCP -3200; Type: SANYO Tri Mode Phone; Serial: A0000000030FF; Conducted Power: 24.5 dBm

Communication System: AMPS; Frequency: 836.49 MHz; Duty Cycle: 1:1
Medium: 835 Brain ($\sigma = 0.90$ mho/m, $\epsilon_r = 40.43$, $\rho = 1000$ kg/m³)
Phantom section: Right Section

Test Date: 12-04-2006; Ambient Temp: 23.3°C; Tissue Temp: 21.4°C

Probe: EX3DV4 - SN3561; ConvF(7.94, 7.94, 7.94); Calibrated: 11/23/2006
Sensor-Surface: 3mm (Mechanical Surface Detection)
Electronics: DAE3 Sn455; Calibrated: 10/16/2006
Phantom: SAM Main; Type: SAM 4.0; Serial: TP:1197
Measurement SW: DASY4, V4.7 Build 44; Postprocessing SW: SEMCAD, V1.8 Build 171

Mode: AMPS, Right Head, Tilt, Mid.ch, Standard Battery

Area Scan (7x14x1): Measurement grid: dx=15mm, dy=15mm
Zoom Scan (5x5x7)/Cube 0: Measurement grid: dx=8mm, dy=8mm, dz=5mm
Reference Value = 13.4 V/m
Peak SAR (extrapolated) = 0.530 W/kg
SAR(1 g) = 0.415 mW/g; SAR(10 g) = 0.308 mW/g

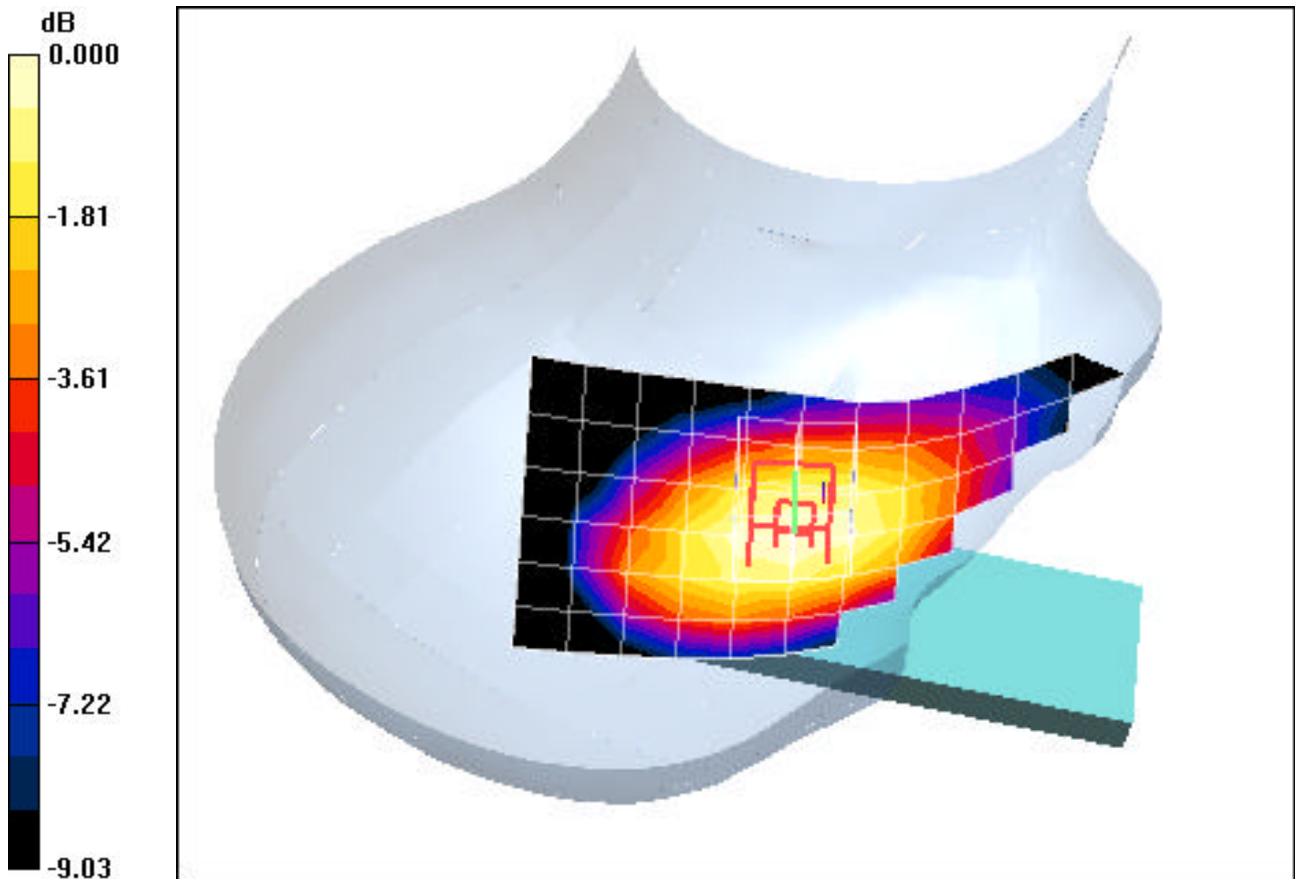

0 dB = 0.461mW/g

PCTEST ENGINEERING LABORATORY, INC.

DUT: SCP -3200; Type: SANYO Tri Mode Phone; Serial: A0000000030FF; Conducted Power: 24.5 dBm

Communication System: AMPS; Frequency: 848.97 MHz; Duty Cycle: 1:1

Medium: 835 Brain ($\sigma = 0.90$ mho/m, $\epsilon_r = 40.43$, $\rho = 1000$ kg/m³)

Phantom section: Left Section

Test Date: 12-04-2006; Ambient Temp: 23.3°C; Tissue Temp: 21.4°C

Probe: EX3DV4 - SN3561; ConvF(7.94, 7.94, 7.94); Calibrated: 11/23/2006

Sensor-Surface: 3mm (Mechanical Surface Detection)

Electronics: DAE3 Sn455; Calibrated: 10/16/2006

Phantom: SAM Main; Type: SAM 4.0; Serial: TP:1197

Measurement SW: DASY4, V4.7 Build 44; Postprocessing SW: SEMCAD, V1.8 Build 171

Mode: AMPS, Left Head, Touch, High.ch, Standard Battery

Area Scan (7x14x1): Measurement grid: dx=15mm, dy=15mm

Zoom Scan (5x5x7)/Cube 0: Measurement grid: dx=8mm, dy=8mm, dz=5mm

Reference Value = 10.7 V/m

Peak SAR (extrapolated) = 1.84 W/kg

SAR(1 g) = 1.27 mW/g; SAR(10 g) = 0.839 mW/g

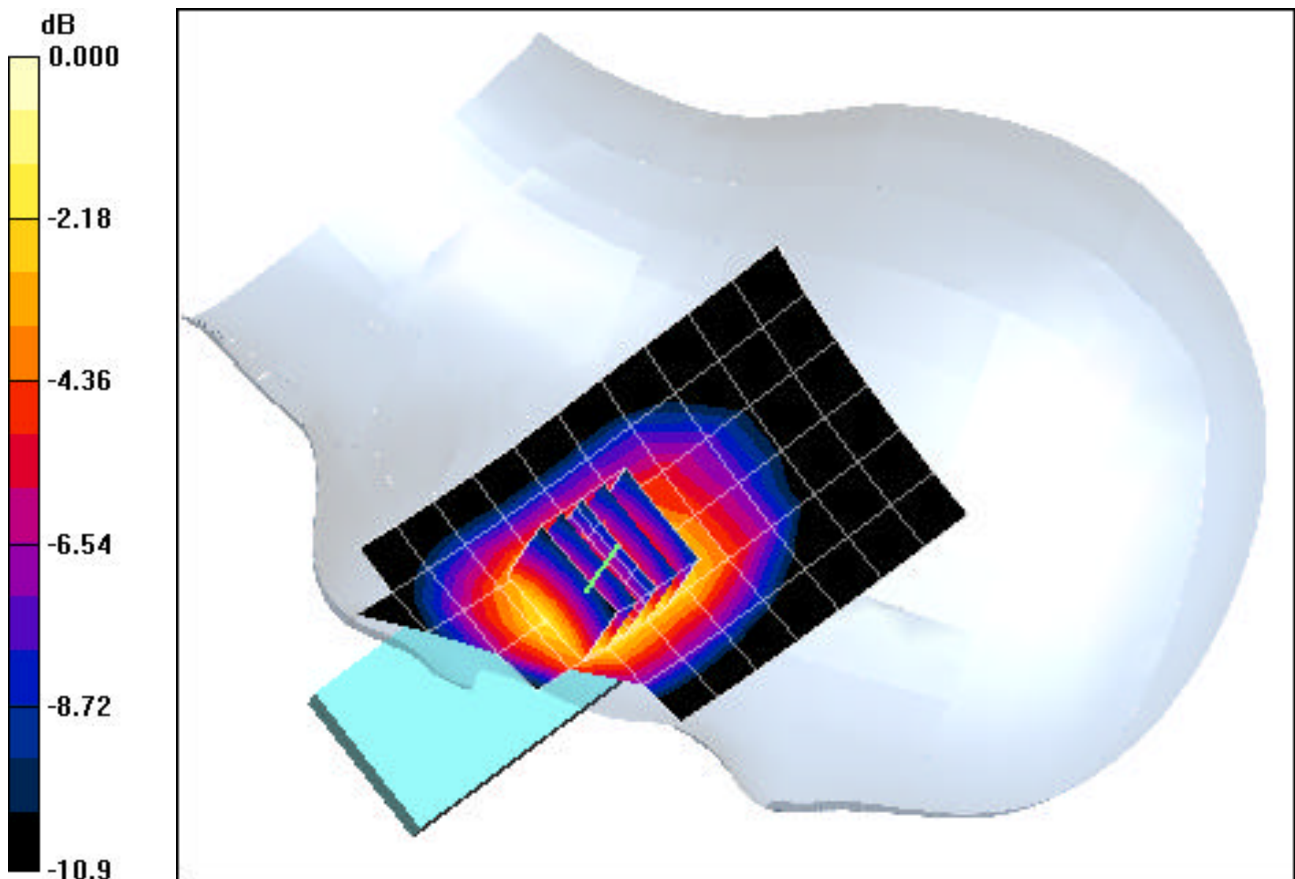

0 dB = 1.48mW/g

PCTEST ENGINEERING LABORATORY, INC.

DUT: SCP -3200; Type: SANYO Tri Mode Phone; Serial: A0000000030FF; Conducted Power: 24.5 dBm

Communication System: AMPS; Frequency: 836.49 MHz; Duty Cycle: 1:1

Medium: 835 Brain ($\sigma = 0.90$ mho/m, $\epsilon_r = 40.43$, $\rho = 1000$ kg/m³)

Phantom section: Left Section

Test Date: 12-05-2006; Ambient Temp: 23.5°C; Tissue Temp: 21.6°C

Probe: EX3DV4 - SN3561; ConvF(7.94, 7.94, 7.94); Calibrated: 11/23/2006

Sensor-Surface: 3mm (Mechanical Surface Detection)

Electronics: DAE3 Sn455; Calibrated: 10/16/2006

Phantom: SAM Main; Type: SAM 4.0; Serial: TP:1197

Measurement SW: DASY4, V4.7 Build 44; Postprocessing SW: SEMCAD, V1.8 Build 171

Mode: AMPS, Left Head, Tilt, Mid.ch, Standard Battery

Area Scan (7x14x1): Measurement grid: dx=15mm, dy=15mm

Zoom Scan (5x5x7)/Cube 0: Measurement grid: dx=8mm, dy=8mm, dz=5mm

Reference Value = 11.7 V/m

Peak SAR (extrapolated) = 0.420 W/kg

SAR(1 g) = 0.332 mW/g; SAR(10 g) = 0.248 mW/g

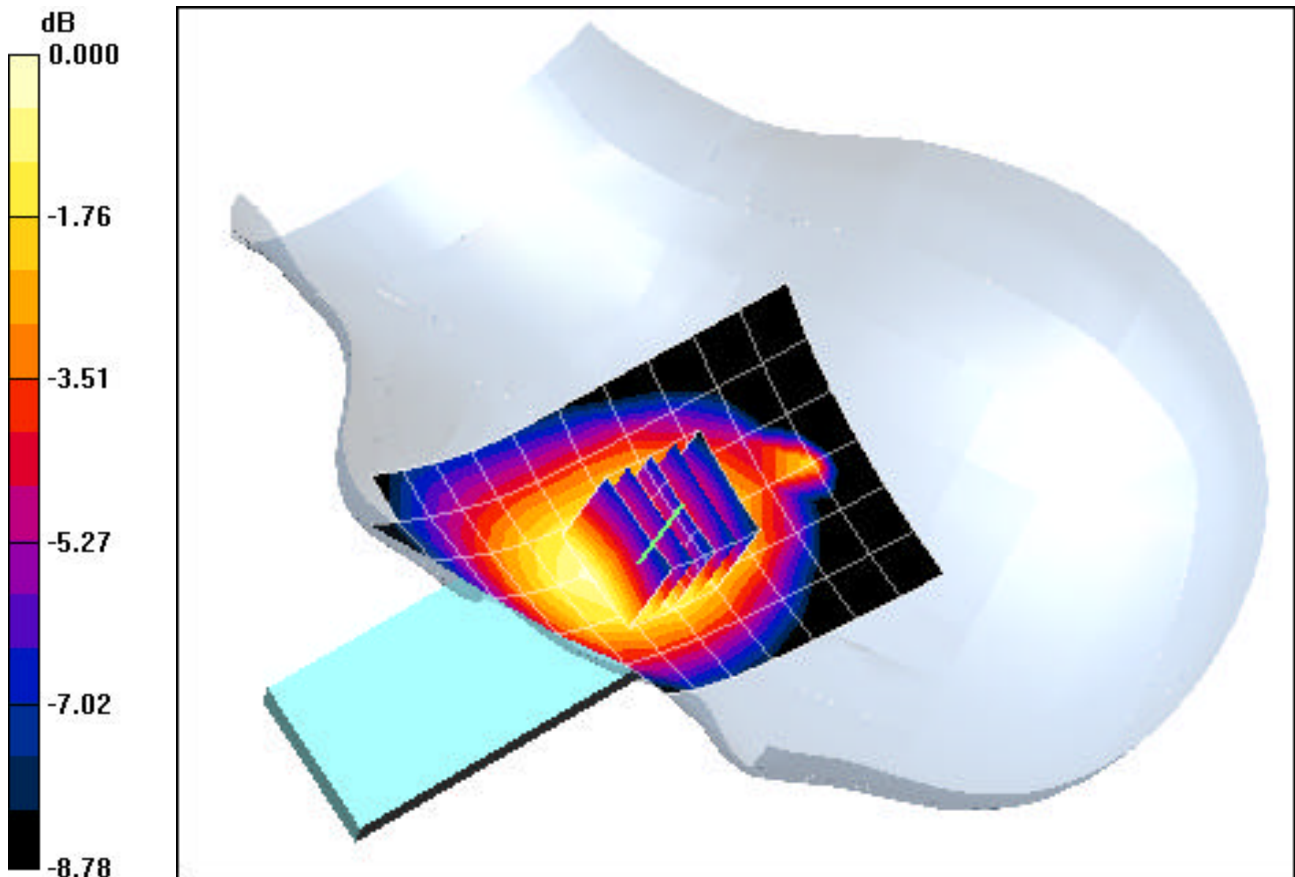

0 dB = 0.365mW/g

PCTEST ENGINEERING LABORATORY, INC.

DUT: SCP -3200; Type: SANYO Tri Mode Phone; Serial: A0000000030FF; Conducted Power: 24.0 dBm

Communication System: Cellular CDMA; Frequency: 848.31 MHz; Duty Cycle: 1:1
Medium: 835 Brain ($\sigma = 0.90$ mho/m, $\epsilon_r = 40.43$, $\rho = 1000$ kg/m³)
Phantom section: Right Section

Test Date: 12-06-2006; Ambient Temp: 23.2°C; Tissue Temp: 21.0°C

Probe: EX3DV4 - SN3561; ConvF(7.94, 7.94, 7.94); Calibrated: 11/23/2006
Sensor-Surface: 3mm (Mechanical Surface Detection)
Electronics: DAE3 Sn455; Calibrated: 10/16/2006
Phantom: SAM Main; Type: SAM 4.0; Serial: TP:1197
Measurement SW: DASY4, V4.7 Build 44; Postprocessing SW: SEMCAD, V1.8 Build 171

Mode: CDMA, Right Head, Touch, High.ch, Standard Battery

Area Scan (7x14x1): Measurement grid: dx=15mm, dy=15mm
Zoom Scan (5x5x7)/Cube 0: Measurement grid: dx=8mm, dy=8mm, dz=5mm
Reference Value = 12.2 V/m
Peak SAR (extrapolated) = 1.91 W/kg
SAR(1 g) = 1.25 mW/g; SAR(10 g) = 0.811 mW/g

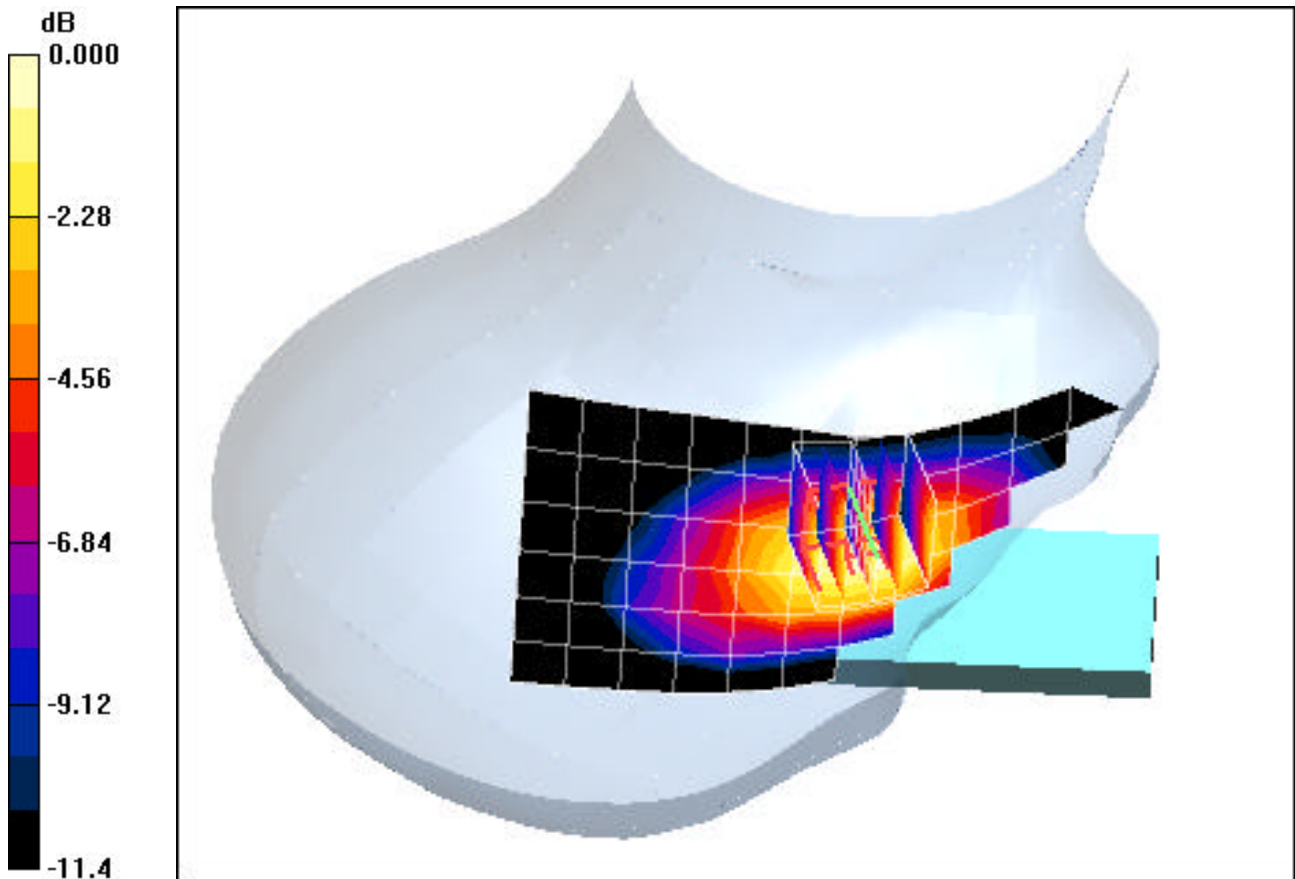

0 dB = 1.48mW/g

PCTEST ENGINEERING LABORATORY, INC.

DUT: SCP -3200; Type: SANYO Tri Mode Phone; Serial: A0000000030FF; Conducted Power: 24.0 dBm

Communication System: Cellular CDMA; Frequency: 836.49 MHz; Duty Cycle: 1:1
Medium: 835 Brain ($\sigma = 0.90$ mho/m, $\epsilon_r = 40.43$, $\rho = 1000$ kg/m³)
Phantom section: Right Section

Test Date: 12-06-2006; Ambient Temp: 23.2°C; Tissue Temp: 21.0°C

Probe: EX3DV4 - SN3561; ConvF(7.94, 7.94, 7.94); Calibrated: 11/23/2006
Sensor-Surface: 3mm (Mechanical Surface Detection)
Electronics: DAE3 Sn455; Calibrated: 10/16/2006
Phantom: SAM Main; Type: SAM 4.0; Serial: TP:1197
Measurement SW: DASY4, V4.7 Build 44; Postprocessing SW: SEMCAD, V1.8 Build 171

Mode: CDMA, Right Head, Tilt, Mid.ch, Standard Battery

Area Scan (7x14x1): Measurement grid: dx=15mm, dy=15mm
Zoom Scan (5x5x7)/Cube 0: Measurement grid: dx=8mm, dy=8mm, dz=5mm
Reference Value = 12.9 V/m
Peak SAR (extrapolated) = 0.380 W/kg
SAR(1 g) = 0.303 mW/g; SAR(10 g) = 0.228 mW/g

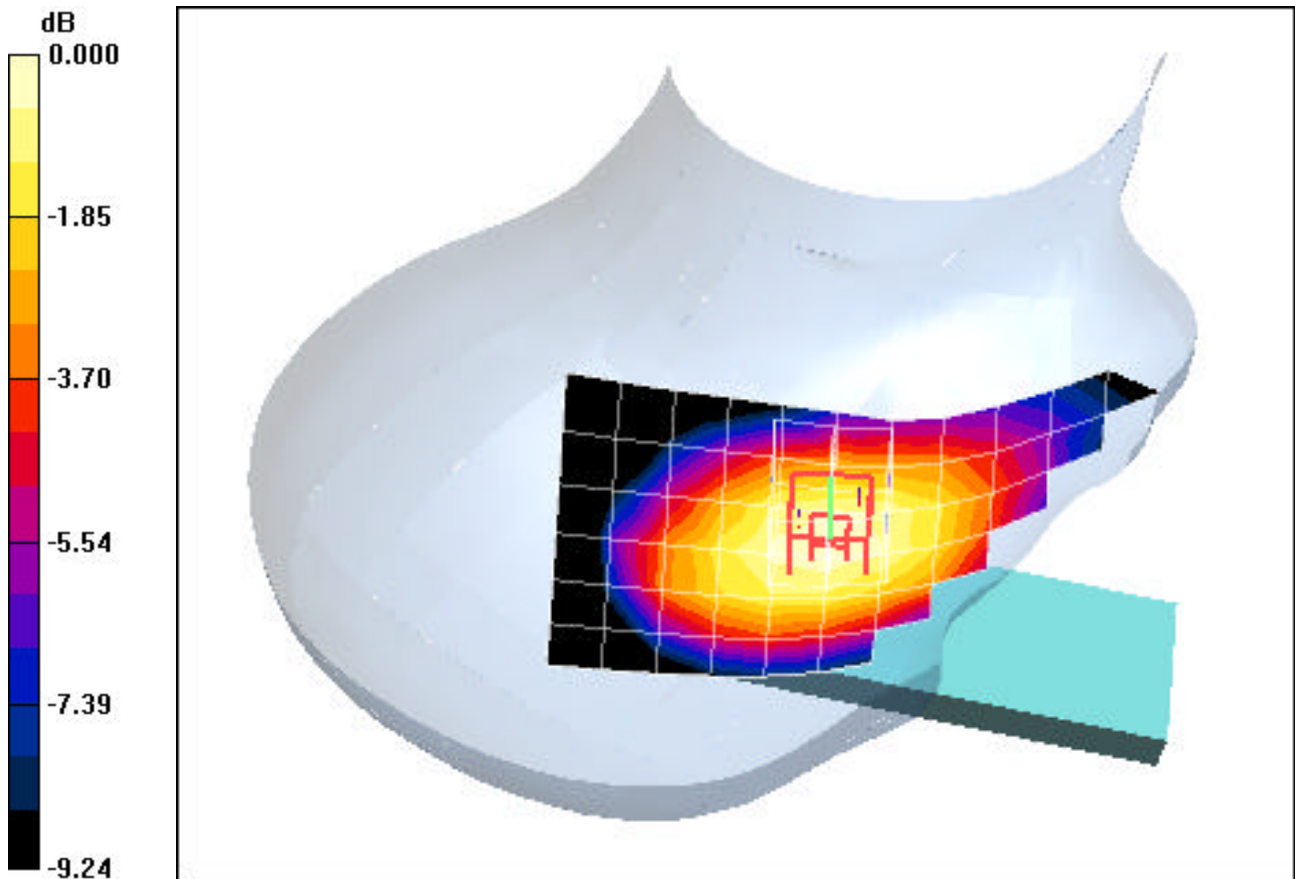

0 dB = 0.332mW/g

PCTEST ENGINEERING LABORATORY, INC.

DUT: SCP -3200; Type: SANYO Tri Mode Phone; Serial: A0000000030FF; Conducted Power: 24.0 dBm

Communication System: Cellular CDMA; Frequency: 848.31 MHz; Duty Cycle: 1:1

Medium: 835 Brain ($\sigma = 0.90$ mho/m, $\epsilon_r = 40.43$, $\rho = 1000$ kg/m³)

Phantom section: Left Section

Test Date: 12-05-2006; Ambient Temp: 23.5°C; Tissue Temp: 21.6°C

Probe: EX3DV4 - SN3561; ConvF(7.94, 7.94, 7.94); Calibrated: 11/23/2006

Sensor-Surface: 3mm (Mechanical Surface Detection)

Electronics: DAE3 Sn455; Calibrated: 10/16/2006

Phantom: SAM Main; Type: SAM 4.0; Serial: TP:1197

Measurement SW: DASY4, V4.7 Build 44; Postprocessing SW: SEMCAD, V1.8 Build 171

Mode: CDMA, Left Head, Touch, High.ch, Standard Battery

Area Scan (7x14x1): Measurement grid: dx=15mm, dy=15mm

Zoom Scan (5x5x7)/Cube 0: Measurement grid: dx=8mm, dy=8mm, dz=5mm

Reference Value = 9.95 V/m

Peak SAR (extrapolated) = 1.77 W/kg

SAR(1 g) = 1.21 mW/g; SAR(10 g) = 0.798 mW/g

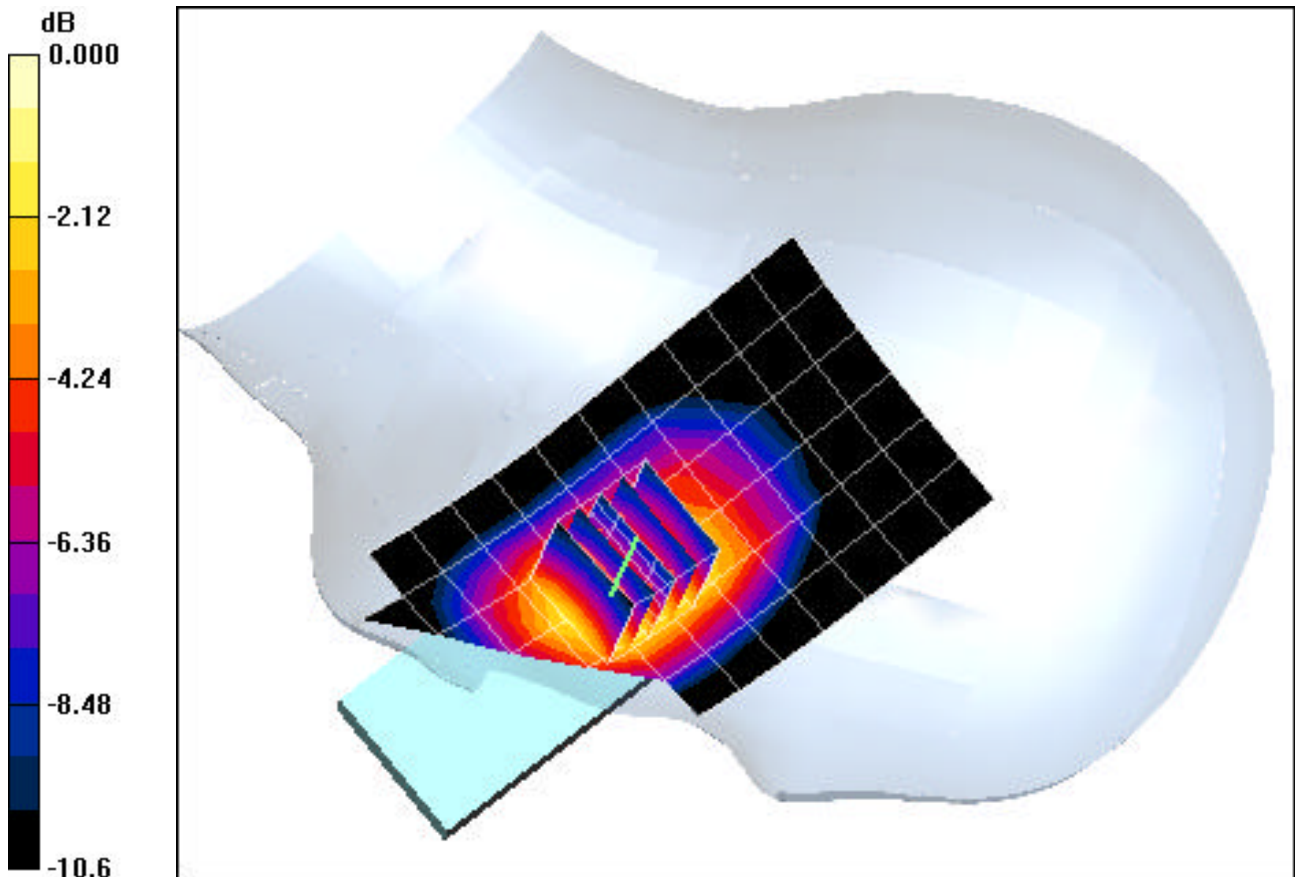

0 dB = 1.40mW/g

PCTEST ENGINEERING LABORATORY, INC.

DUT: SCP -3200; Type: SANYO Tri Mode Phone; Serial: A0000000030FF; Conducted Power: 24.0 dBm

Communication System: Cellular CDMA; Frequency: 836.49 MHz; Duty Cycle: 1:1

Medium: 835 Brain ($\sigma = 0.90$ mho/m, $\epsilon_r = 40.43$, $\rho = 1000$ kg/m³)

Phantom section: Left Section

Test Date: 12-05-2006; Ambient Temp: 23.5°C; Tissue Temp: 21.6°C

Probe: EX3DV4 - SN3561; ConvF(7.94, 7.94, 7.94); Calibrated: 11/23/2006

Sensor-Surface: 3mm (Mechanical Surface Detection)

Electronics: DAE3 Sn455; Calibrated: 10/16/2006

Phantom: SAM Main; Type: SAM 4.0; Serial: TP:1197

Measurement SW: DASY4, V4.7 Build 44; Postprocessing SW: SEMCAD, V1.8 Build 171

Mode: CDMA, Left Head, Tilt, Mid.ch, Standard Battery

Area Scan (7x14x1): Measurement grid: dx=15mm, dy=15mm

Zoom Scan (5x5x7)/Cube 0: Measurement grid: dx=8mm, dy=8mm, dz=5mm

Reference Value = 10.1 V/m

Peak SAR (extrapolated) = 0.358 W/kg

SAR(1 g) = 0.281 mW/g; SAR(10 g) = 0.210 mW/g

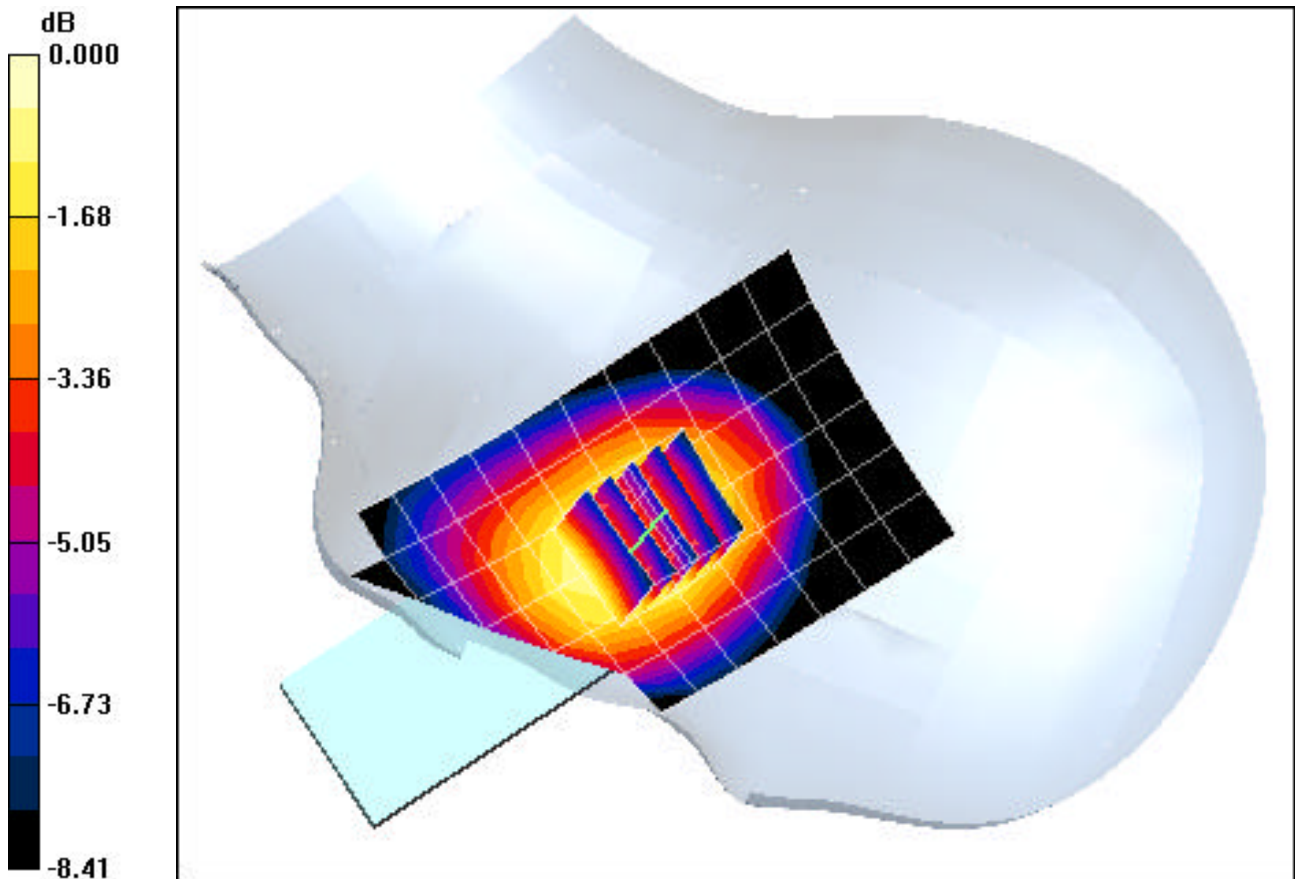

0 dB = 0.314mW/g

PCTEST ENGINEERING LABORATORY, INC.

DUT: SCP -3200; Type: SANYO Tri Mode Phone; Serial: A0000000030FF; Conducted Power: 24.0 dBm

Communication System: PCS CDMA; Frequency: 1880 MHz; Duty Cycle: 1:1
Medium: 1900 Brain ($\sigma = 1.44$ mho/m, $\epsilon_r = 39.39$, $\rho = 1000$ kg/m³)
Phantom section: Right Section

Test Date: 12-05-2006; Ambient Temp: 23.1°C; Tissue Temp: 21.1°C

Probe: EX3DV4 - SN3561; ConvF(6.99, 6.99, 6.99); Calibrated: 11/23/2006
Sensor-Surface: 3mm (Mechanical Surface Detection)
Electronics: DAE3 Sn455; Calibrated: 10/16/2006
Phantom: SAM Sub; Type: SAM 4.0; Serial: TP:1357
Measurement SW: DASY4, V4.7 Build 44; Postprocessing SW: SEMCAD, V1.8 Build 171

Mode: PCS, Right Head, Touch, Mid.ch, Standard Battery

Area Scan (7x14x1): Measurement grid: dx=15mm, dy=15mm
Zoom Scan (5x5x7)/Cube 0: Measurement grid: dx=8mm, dy=8mm, dz=5mm
Reference Value = 10.1 V/m
Peak SAR (extrapolated) = 2.56 W/kg
SAR(1 g) = 1.41 mW/g; SAR(10 g) = 0.706 mW/g

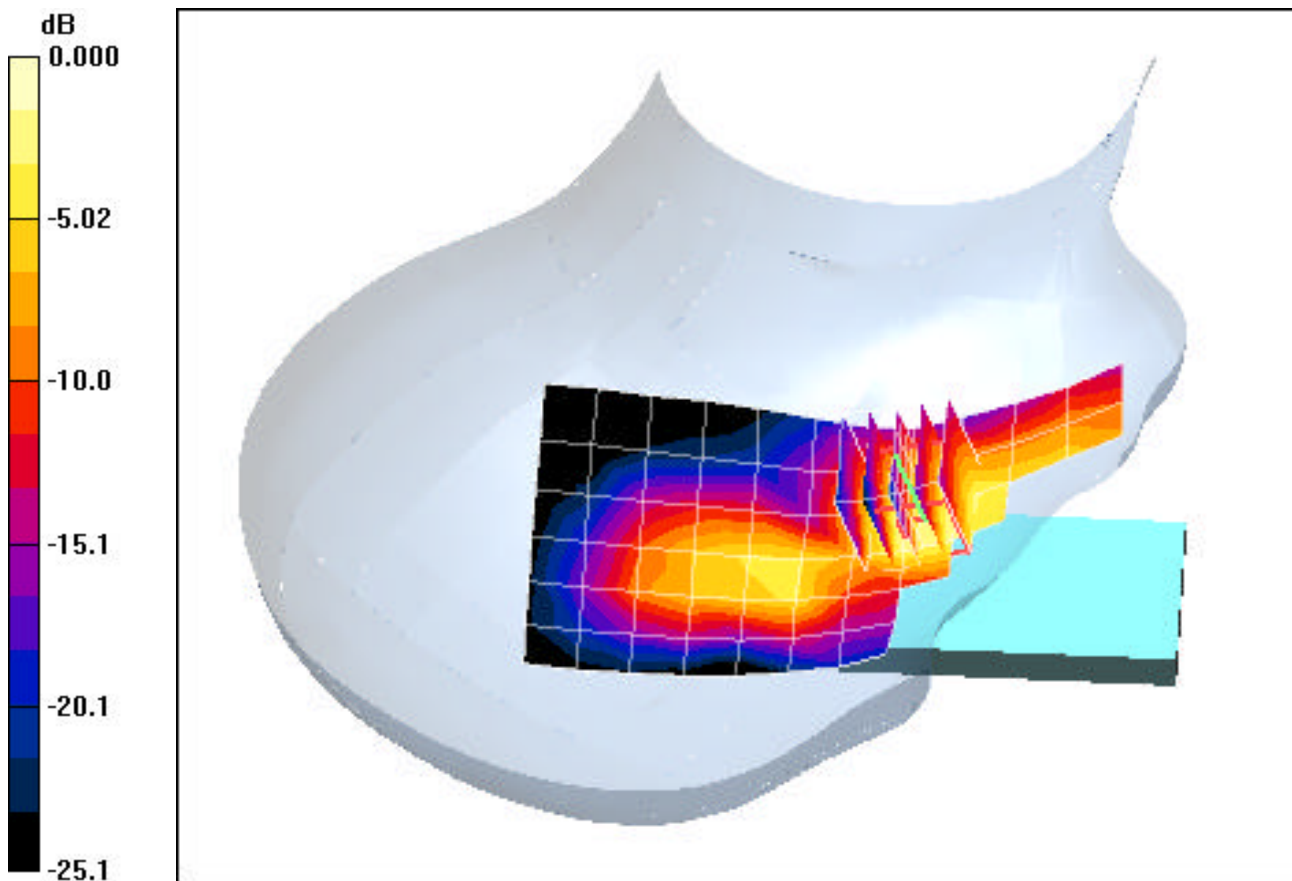

0 dB = 1.78mW/g

PCTEST ENGINEERING LABORATORY, INC.

DUT: SCP -3200; Type: SANYO Tri Mode Phone; Serial: A0000000030FF; Conducted Power: 24.0 dBm

Communication System: PCS CDMA; Frequency: 1880 MHz; Duty Cycle: 1:1
Medium: 1900 Brain ($\sigma = 1.44$ mho/m, $\epsilon_r = 39.39$, $\rho = 1000$ kg/m³)
Phantom section: Right Section

Test Date: 12-05-2006; Ambient Temp: 23.1°C; Tissue Temp: 21.1°C

Probe: EX3DV4 - SN3561; ConvF(6.99, 6.99, 6.99); Calibrated: 11/23/2006
Sensor-Surface: 3mm (Mechanical Surface Detection)
Electronics: DAE3 Sn455; Calibrated: 10/16/2006
Phantom: SAM Sub; Type: SAM 4.0; Serial: TP:1357
Measurement SW: DASY4, V4.7 Build 44; Postprocessing SW: SEMCAD, V1.8 Build 171

Mode: PCS, Right Head, Tilt, Mid.ch, Standard Battery

Area Scan (7x14x1): Measurement grid: dx=15mm, dy=15mm
Zoom Scan (5x5x7)/Cube 0: Measurement grid: dx=8mm, dy=8mm, dz=5mm
Reference Value = 9.72 V/m
Peak SAR (extrapolated) = 0.358 W/kg
SAR(1 g) = 0.228 mW/g; SAR(10 g) = 0.136 mW/g

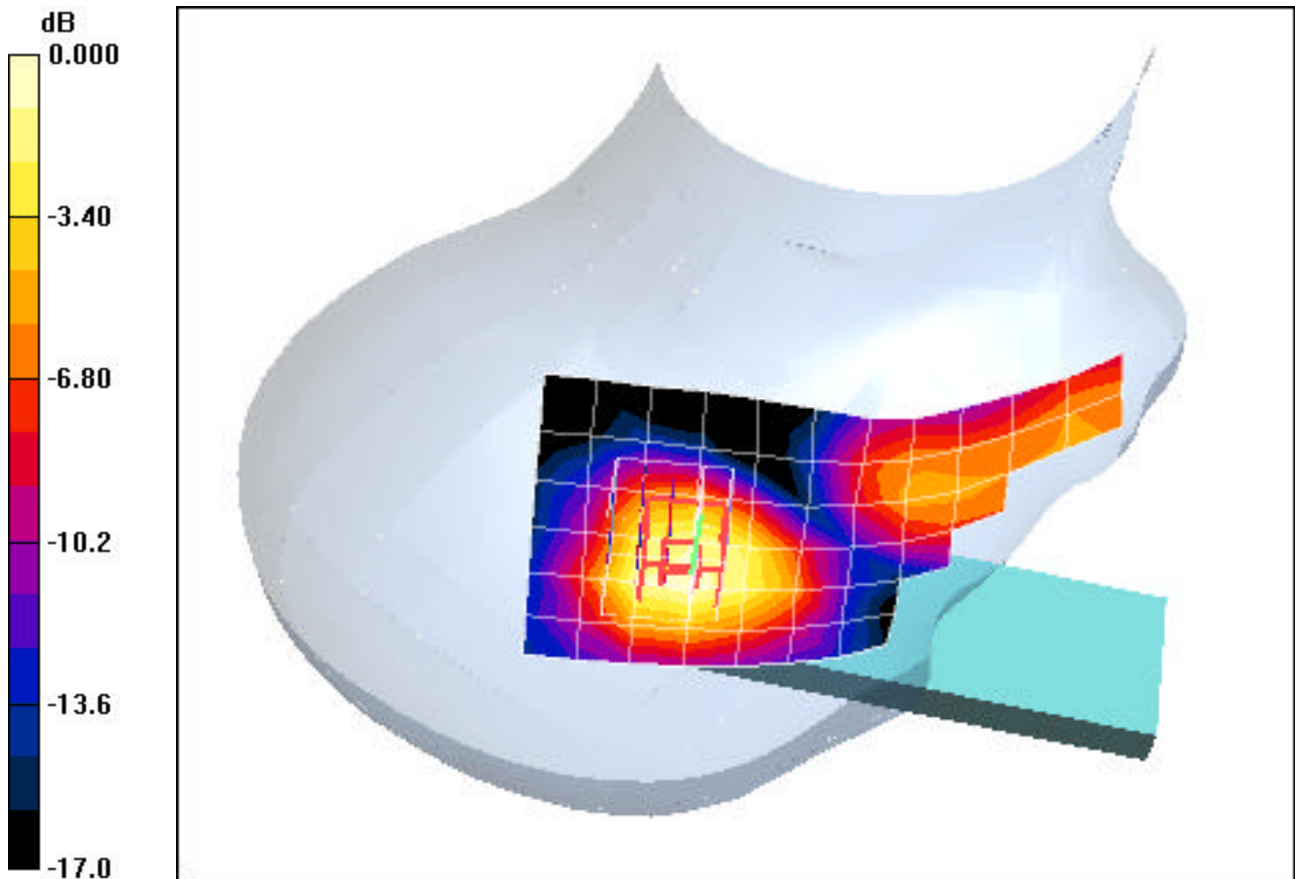

0 dB = 0.269mW/g

PCTEST ENGINEERING LABORATORY, INC.

DUT: SCP -3200; Type: SANYO Tri Mode Phone; Serial: A0000000030FF; Conducted Power: 24.0 dBm

Communication System: PCS CDMA; Frequency: 1908.75 MHz; Duty Cycle: 1:1

Medium: 1900 Brain ($\sigma = 1.44$ mho/m, $\epsilon_r = 39.39$, $\rho = 1000$ kg/m³)

Phantom section: Left Section

Test Date: 12-05-2006; Ambient Temp: 23.1°C; Tissue Temp: 21.1°C

Probe: EX3DV4 - SN3561; ConvF(6.99, 6.99, 6.99); Calibrated: 11/23/2006

Sensor-Surface: 3mm (Mechanical Surface Detection)

Electronics: DAE3 Sn455; Calibrated: 10/16/2006

Phantom: SAM Sub; Type: SAM 4.0; Serial: TP:1357

Measurement SW: DASY4, V4.7 Build 44; Postprocessing SW: SEMCAD, V1.8 Build 171

Mode: PCS, Left Head, Touch, High.ch, Standard Battery

Area Scan (7x14x1): Measurement grid: dx=15mm, dy=15mm

Zoom Scan (5x5x7)/Cube 0: Measurement grid: dx=8mm, dy=8mm, dz=5mm

Reference Value = 4.82 V/m

Peak SAR (extrapolated) = 2.02 W/kg

SAR(1 g) = 1.07 mW/g; SAR(10 g) = 0.525 mW/g

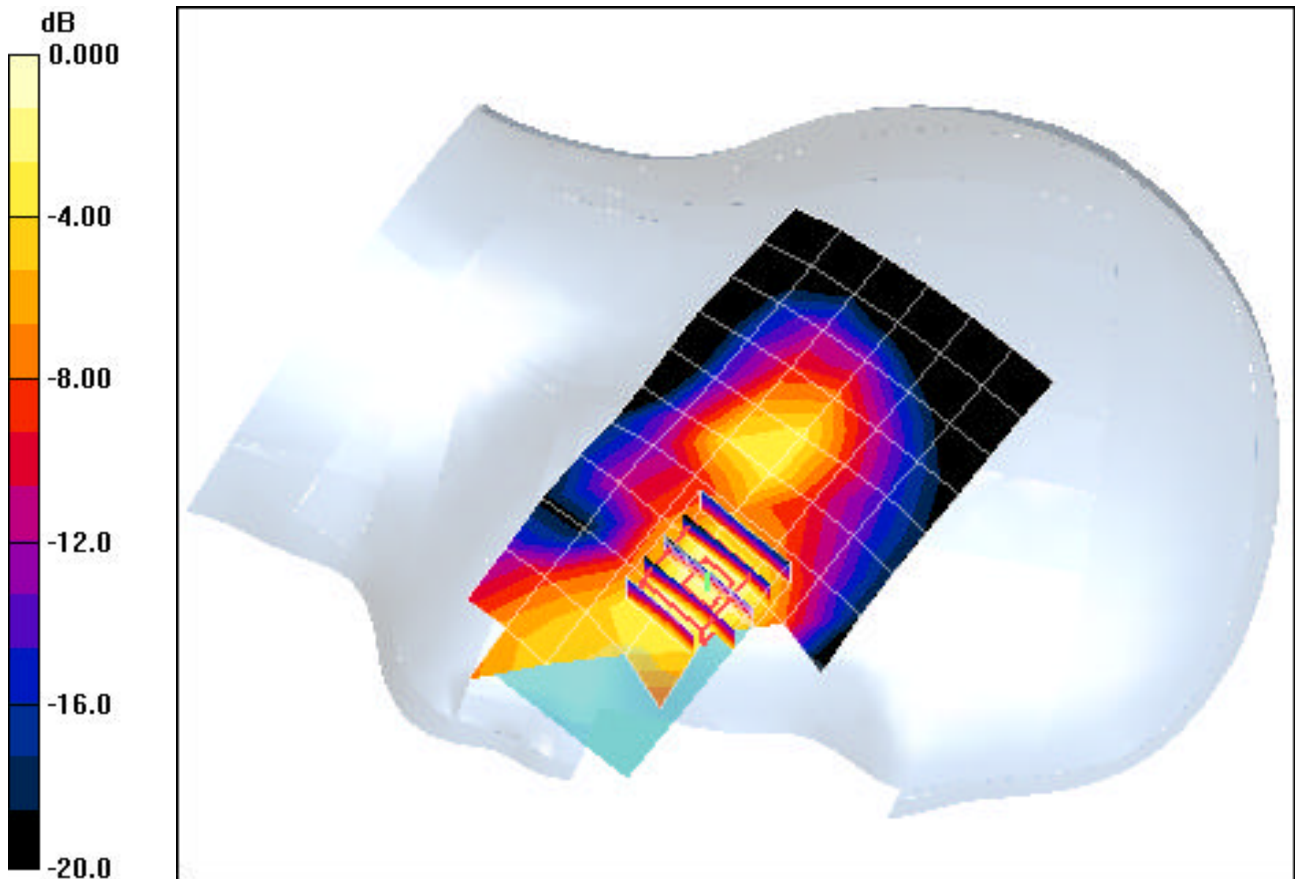

0 dB = 1.36mW/g

PCTEST ENGINEERING LABORATORY, INC.

DUT: SCP -3200; Type: SANYO Tri Mode Phone; Serial: A0000000030FF; Conducted Power: 24.0 dBm

Communication System: PCS CDMA; Frequency: 1880 MHz; Duty Cycle: 1:1

Medium: 1900 Brain ($\sigma = 1.44$ mho/m, $\epsilon_r = 39.39$, $\rho = 1000$ kg/m³)

Phantom section: Left Section

Test Date: 12-05-2006; Ambient Temp: 23.1°C; Tissue Temp: 21.1°C

Probe: EX3DV4 - SN3561; ConvF(6.99, 6.99, 6.99); Calibrated: 11/23/2006

Sensor-Surface: 3mm (Mechanical Surface Detection)

Electronics: DAE3 Sn455; Calibrated: 10/16/2006

Phantom: SAM Sub; Type: SAM 4.0; Serial: TP:1357

Measurement SW: DASY4, V4.7 Build 44; Postprocessing SW: SEMCAD, V1.8 Build 171

Mode: PCS, Left Head, Tilt, Mid.ch, Standard Battery

Area Scan (7x14x1): Measurement grid: dx=15mm, dy=15mm

Zoom Scan (5x5x7)/Cube 0: Measurement grid: dx=8mm, dy=8mm, dz=5mm

Reference Value = 7.53 V/m

Peak SAR (extrapolated) = 0.268 W/kg

SAR(1 g) = 0.174 mW/g; SAR(10 g) = 0.107 mW/g

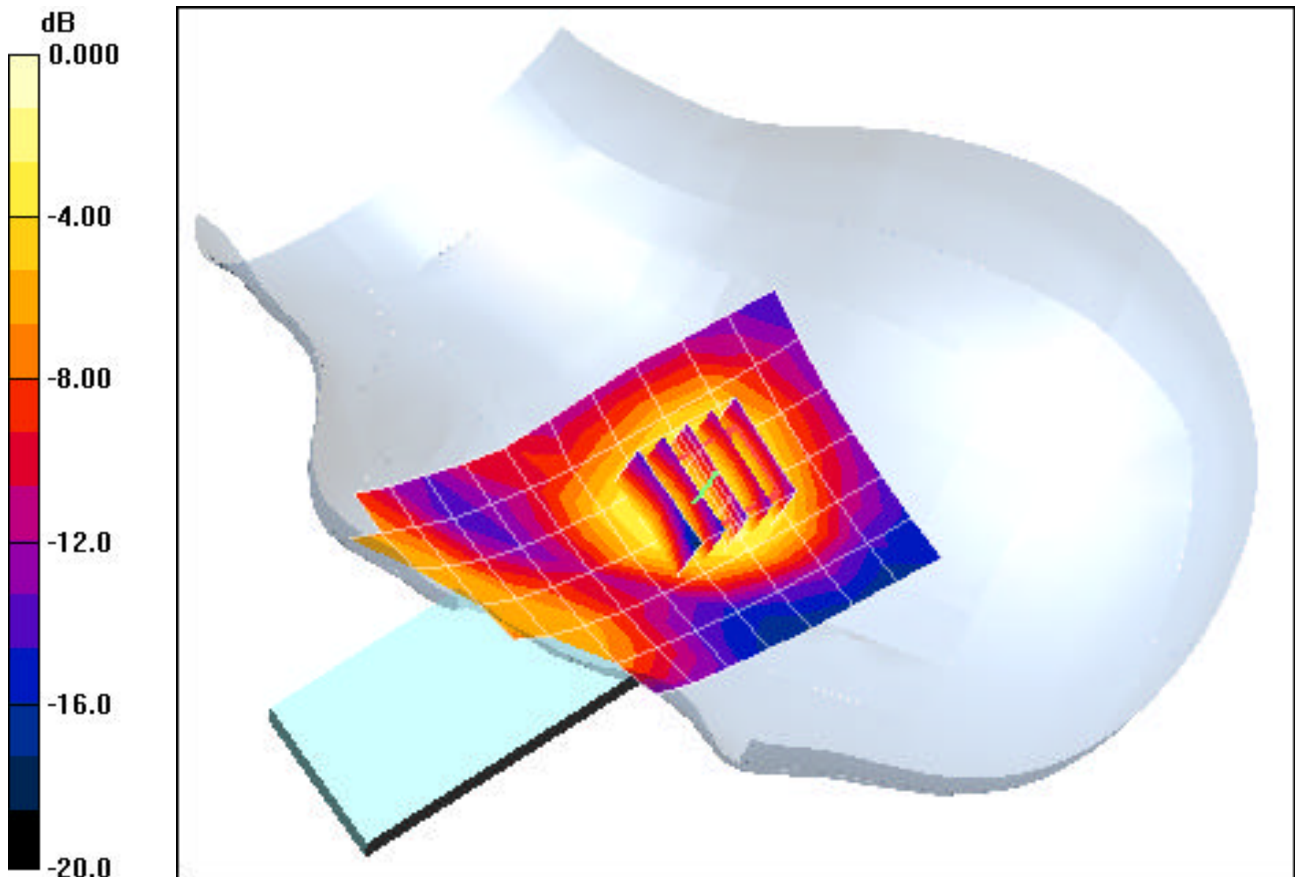

0 dB = 0.199mW/g

PCTEST ENGINEERING LABORATORY, INC.

DUT: SCP -3200; Type: SANYO Tri Mode Phone; Serial: A0000000030FF; Conducted Power: 24.5 dBm

Communication System: AMPS; Frequency: 836.49 MHz; Duty Cycle: 1:1
Medium: 835 Muscle ($\sigma = 0.97$ mho/m, $\epsilon_r = 54.71$, $\rho = 1000$ kg/m³)
Phantom section: Flat Section; Space: 2.2 cm

Test Date: 12-06-2006; Ambient Temp: 23.6°C; Tissue Temp: 21.0°C

Probe: EX3DV4 - SN3561; ConvF(7.92, 7.92, 7.92); Calibrated: 11/23/2006
Sensor-Surface: 3mm (Mechanical Surface Detection)
Electronics: DAE3 Sn455; Calibrated: 10/16/2006
Phantom: SAM Main; Type: SAM 4.0; Serial: TP:1197
Measurement SW: DASY4, V4.7 Build 44; Postprocessing SW: SEMCAD, V1.8 Build 171

Mode: AMPS, Body SAR, Front side, Mid.ch, Standard Battery

Area Scan (7x9x1): Measurement grid: dx=15mm, dy=15mm
Zoom Scan (5x5x7)/Cube 0: Measurement grid: dx=8mm, dy=8mm, dz=5mm
Reference Value = 10.9 V/m
Peak SAR (extrapolated) = 0.203 W/kg
SAR(1 g) = 0.160 mW/g; SAR(10 g) = 0.118 mW/g

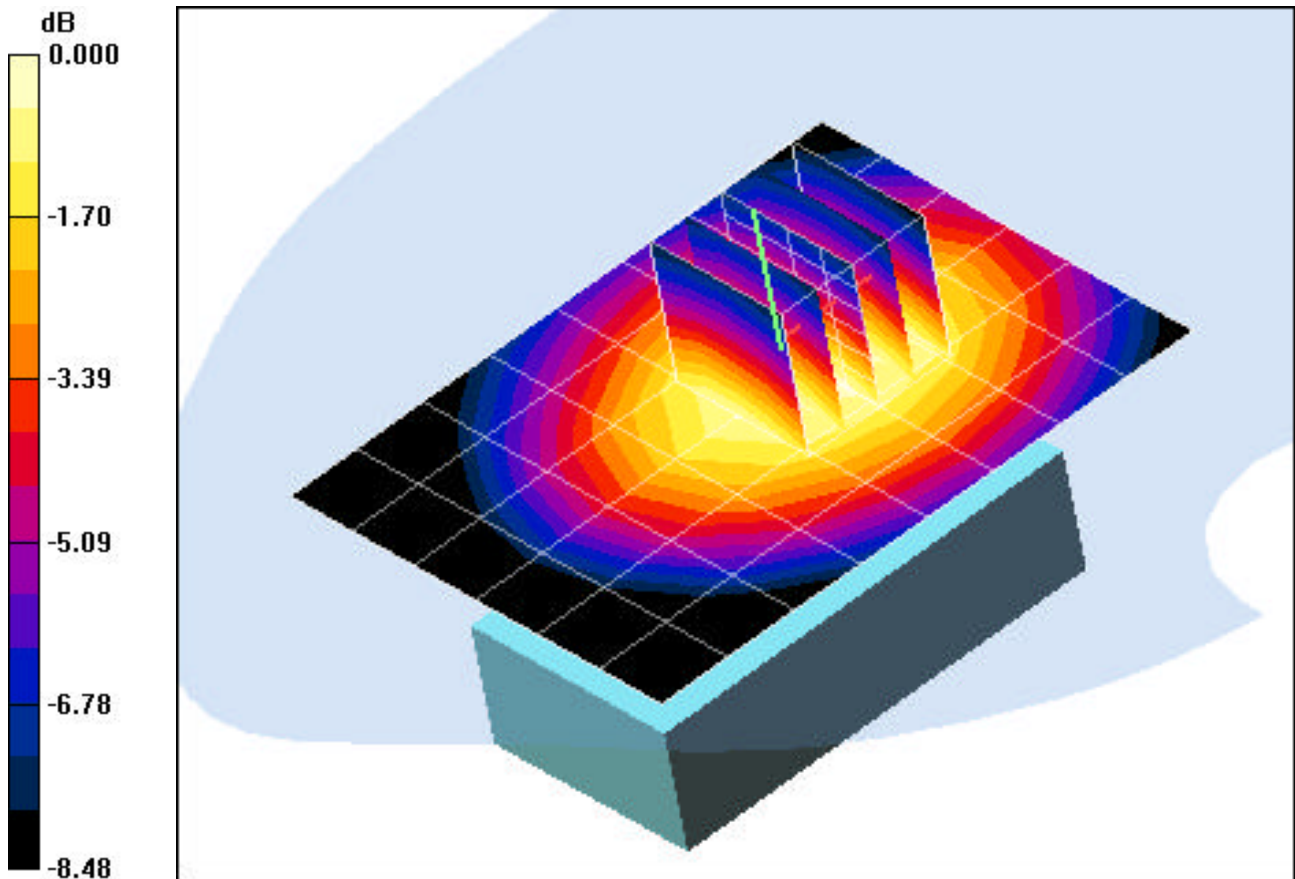

0 dB = 0.176mW/g

PCTEST ENGINEERING LABORATORY, INC.

DUT: SCP -3200; Type: SANYO Tri Mode Phone; Serial: A0000000030FF; Conducted Power: 24.5 dBm

Communication System: AMPS; Frequency: 836.49 MHz; Duty Cycle: 1:1
Medium: 835 Muscle ($\sigma = 0.97$ mho/m, $\epsilon_r = 54.71$, $\rho = 1000$ kg/m³)
Phantom section: Flat Section; Space: 2.2 cm

Test Date: 12-06-2006; Ambient Temp: 23.6°C; Tissue Temp: 21.0°C

Probe: EX3DV4 - SN3561; ConvF(7.92, 7.92, 7.92); Calibrated: 11/23/2006
Sensor-Surface: 3mm (Mechanical Surface Detection)
Electronics: DAE3 Sn455; Calibrated: 10/16/2006
Phantom: SAM Main; Type: SAM 4.0; Serial: TP:1197
Measurement SW: DASY4, V4.7 Build 44; Postprocessing SW: SEMCAD, V1.8 Build 171

Mode: AMPS, Body SAR, Back side, Mid.ch, Standard Battery

Area Scan (7x9x1): Measurement grid: dx=15mm, dy=15mm
Zoom Scan (5x5x7)/Cube 0: Measurement grid: dx=8mm, dy=8mm, dz=5mm
Reference Value = 13.8 V/m
Peak SAR (extrapolated) = 0.579 W/kg
SAR(1 g) = 0.442 mW/g; SAR(10 g) = 0.312 mW/g

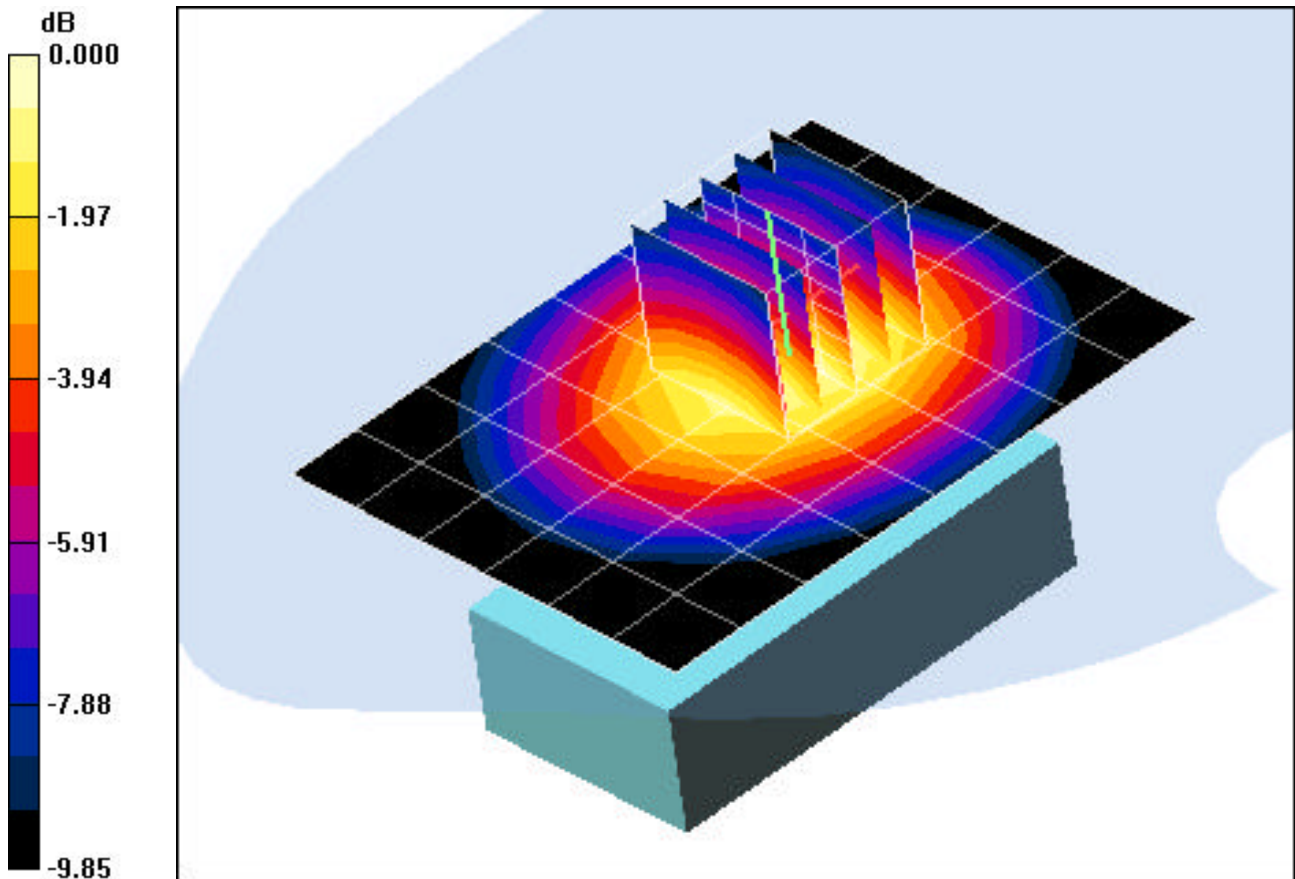

0 dB = 0.497mW/g

PCTEST ENGINEERING LABORATORY, INC.

DUT: SCP -3200; Type: SANYO Tri Mode Phone; Serial: A0000000030FF; Conducted Power: 24.0 dBm

Communication System: Cellular CDMA; Frequency: 836.49 MHz; Duty Cycle: 1:1
Medium: 835 Muscle ($\sigma = 0.97$ mho/m, $\epsilon_r = 54.71$, $\rho = 1000$ kg/m³)
Phantom section: Flat Section; Space: 2.2 cm

Test Date: 12-06-2006; Ambient Temp: 23.6°C; Tissue Temp: 21.0°C

Probe: EX3DV4 - SN3561; ConvF(7.92, 7.92, 7.92); Calibrated: 11/23/2006
Sensor-Surface: 3mm (Mechanical Surface Detection)
Electronics: DAE3 Sn455; Calibrated: 10/16/2006
Phantom: SAM Main; Type: SAM 4.0; Serial: TP:1197
Measurement SW: DASY4, V4.7 Build 44; Postprocessing SW: SEMCAD, V1.8 Build 171

Mode: CDMA, Body SAR, Front side, Mid.ch, Standard Battery

Area Scan (7x9x1): Measurement grid: dx=15mm, dy=15mm
Zoom Scan (5x5x7)/Cube 0: Measurement grid: dx=8mm, dy=8mm, dz=5mm
Reference Value = 9.79 V/m
Peak SAR (extrapolated) = 0.178 W/kg
SAR(1 g) = 0.139 mW/g; SAR(10 g) = 0.102 mW/g

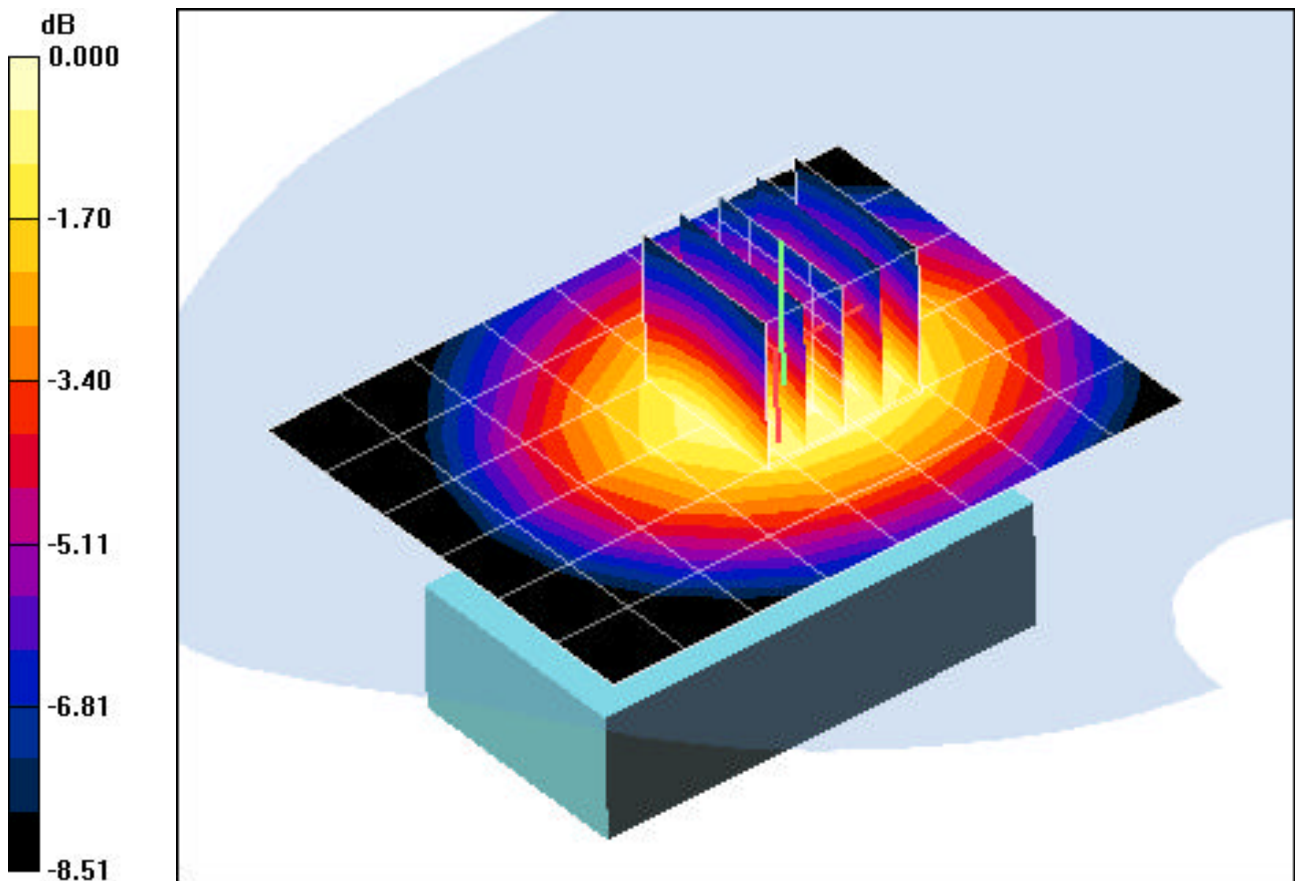

0 dB = 0.155mW/g

PCTEST ENGINEERING LABORATORY, INC.

DUT: SCP -3200; Type: SANYO Tri Mode Phone; Serial: A0000000030FF; Conducted Power: 24.0 dBm

Communication System: Cellular CDMA; Frequency: 836.49 MHz; Duty Cycle: 1:1
Medium: 835 Muscle ($\sigma = 0.97$ mho/m, $\epsilon_r = 54.71$, $\rho = 1000$ kg/m³)
Phantom section: Flat Section; Space: 2.2 cm

Test Date: 12-06-2006; Ambient Temp: 23.6°C; Tissue Temp: 21.0°C

Probe: EX3DV4 - SN3561; ConvF(7.92, 7.92, 7.92); Calibrated: 11/23/2006
Sensor-Surface: 3mm (Mechanical Surface Detection)
Electronics: DAE3 Sn455; Calibrated: 10/16/2006
Phantom: SAM Main; Type: SAM 4.0; Serial: TP:1197
Measurement SW: DASY4, V4.7 Build 44; Postprocessing SW: SEMCAD, V1.8 Build 171

Mode: CDMA, Body SAR, Back side, Mid.ch, Standard Battery

Area Scan (7x9x1): Measurement grid: dx=15mm, dy=15mm
Zoom Scan (5x5x7)/Cube 0: Measurement grid: dx=8mm, dy=8mm, dz=5mm
Reference Value = 12.4 V/m
Peak SAR (extrapolated) = 0.480 W/kg
SAR(1 g) = 0.362 mW/g; SAR(10 g) = 0.257 mW/g

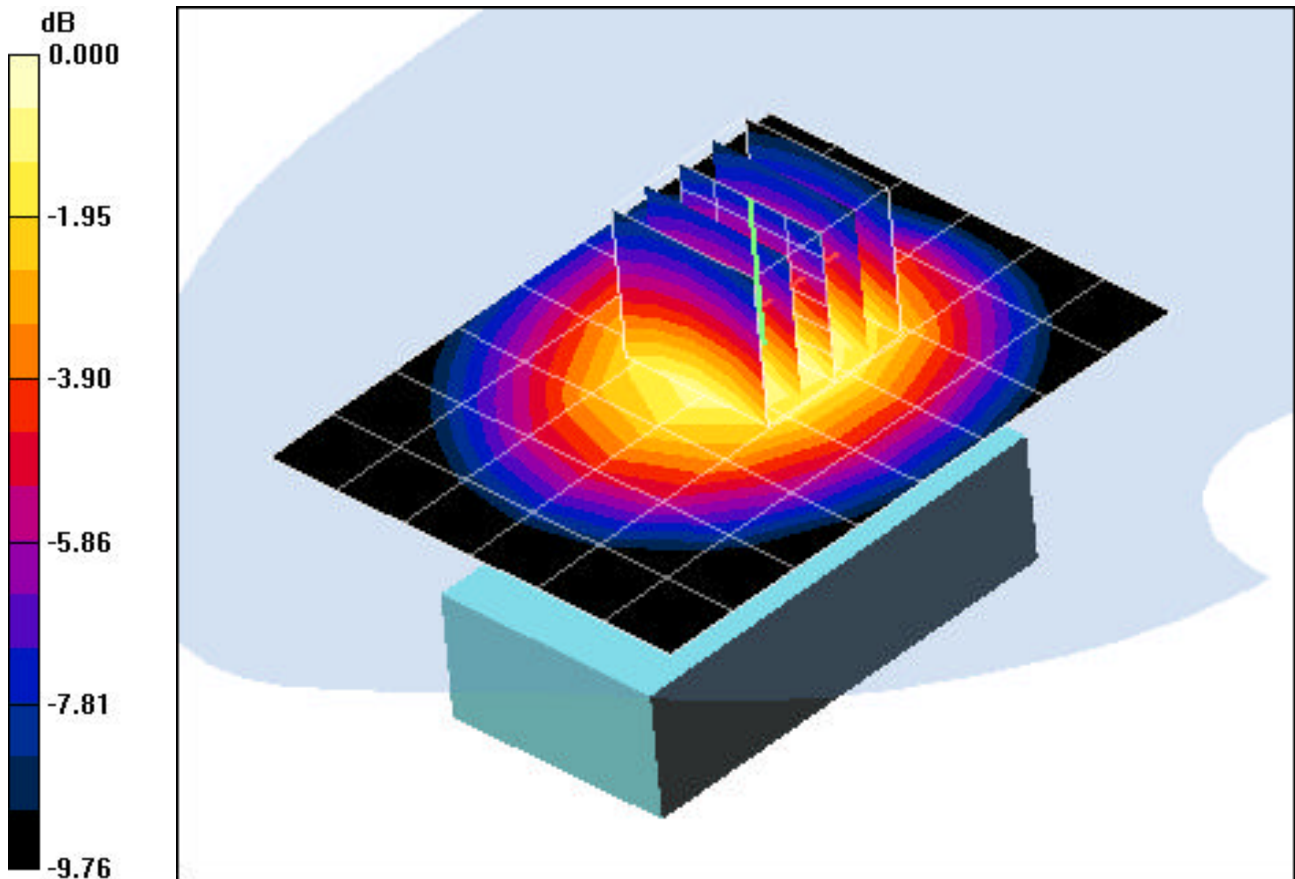

0 dB = 0.411mW/g

PCTEST ENGINEERING LABORATORY, INC.

DUT: SCP -3200; Type: SANYO Tri Mode Phone; Serial: A0000000030FF; Conducted Power: 24.0 dBm

Communication System: PCS CDMA; Frequency: 1880 MHz; Duty Cycle: 1:1
Medium: 1900 Muscle ($\sigma = 1.56$ mho/m, $\epsilon_r = 54.42$, $\rho = 1000$ kg/m³)
Phantom section: Flat Section; Space: 2.2 cm

Test Date: 12-06-2006; Ambient Temp: 23.3°C; Tissue Temp: 21.2°C

Probe: EX3DV4 - SN3561; ConvF(6.47, 6.47, 6.47); Calibrated: 11/23/2006
Sensor-Surface: 3mm (Mechanical Surface Detection)
Electronics: DAE3 Sn455; Calibrated: 10/16/2006
Phantom: SAM Sub; Type: SAM 4.0; Serial: TP:1357
Measurement SW: DASY4, V4.7 Build 44; Postprocessing SW: SEMCAD, V1.8 Build 171

Mode: PCS, Body SAR, Front side, Mid.ch, Standard Battery

Area Scan (7x9x1): Measurement grid: dx=15mm, dy=15mm
Zoom Scan (5x5x7)/Cube 0: Measurement grid: dx=8mm, dy=8mm, dz=5mm
Reference Value = 7.96 V/m
Peak SAR (extrapolated) = 0.236 W/kg
SAR(1 g) = 0.150 mW/g; SAR(10 g) = 0.094 mW/g

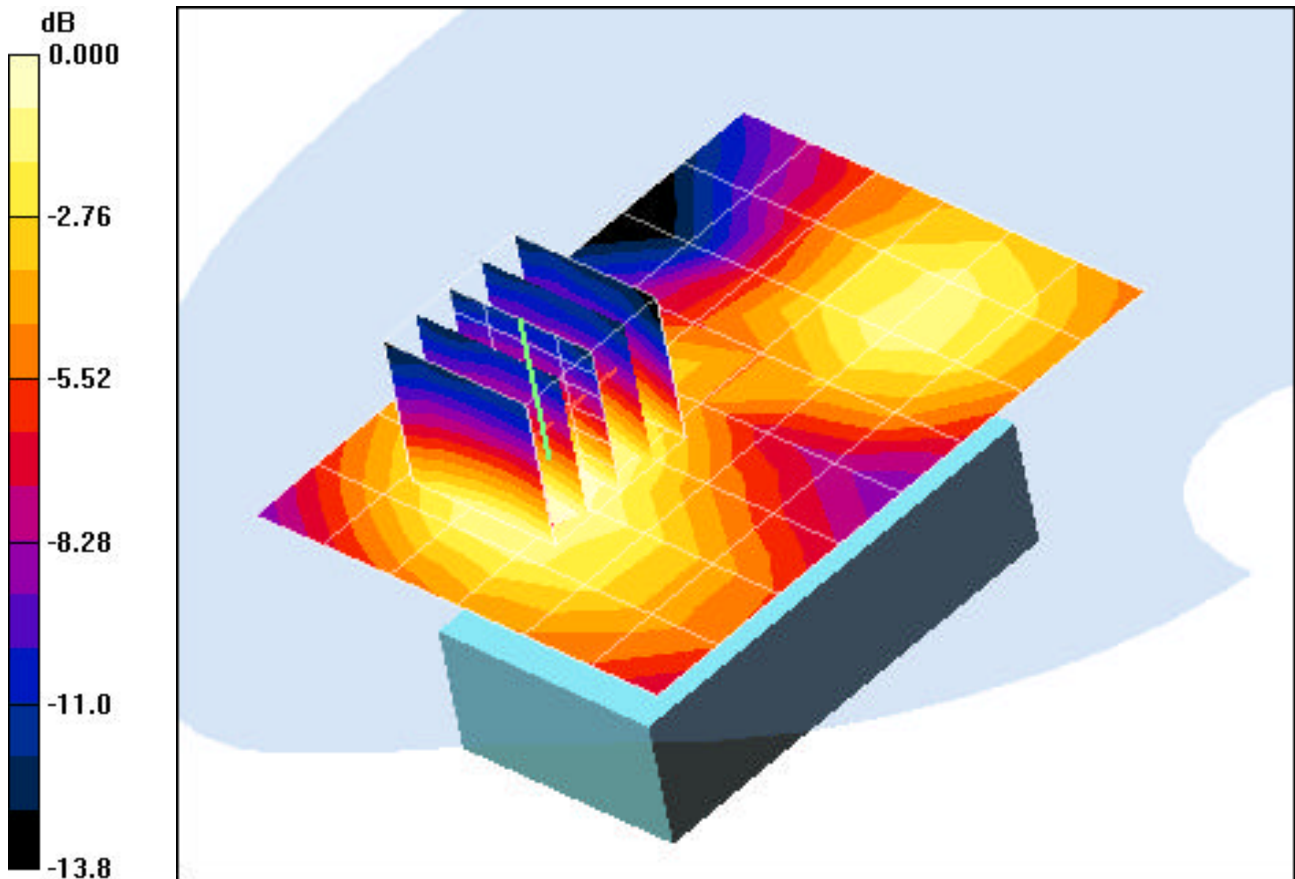

0 dB = 0.176mW/g

PCTEST ENGINEERING LABORATORY, INC.

DUT: SCP -3200; Type: SANYO Tri Mode Phone; Serial: A0000000030FF; Conducted Power: 24.0 dBm

Communication System: PCS CDMA; Frequency: 1880 MHz; Duty Cycle: 1:1

Medium: 1900 Muscle ($\sigma = 1.56$ mho/m, $\epsilon_r = 54.42$, $\rho = 1000$ kg/m³)

Phantom section: Flat Section; Space: 2.2 cm

Test Date: 12-06-2006; Ambient Temp: 23.3°C; Tissue Temp: 21.2°C

Probe: EX3DV4 - SN3561; ConvF(6.47, 6.47, 6.47); Calibrated: 11/23/2006

Sensor-Surface: 3mm (Mechanical Surface Detection)

Electronics: DAE3 Sn455; Calibrated: 10/16/2006

Phantom: SAM Sub; Type: SAM 4.0; Serial: TP:1357

Measurement SW: DASY4, V4.7 Build 44; Postprocessing SW: SEMCAD, V1.8 Build 171

Mode: PCS, Body SAR, Back side, Mid.ch, Standard Battery

Area Scan (7x9x1): Measurement grid: dx=15mm, dy=15mm

Zoom Scan (5x5x7)/Cube 0: Measurement grid: dx=8mm, dy=8mm, dz=5mm

Reference Value = 10.9 V/m

Peak SAR (extrapolated) = 0.485 W/kg

SAR(1 g) = 0.295 mW/g; SAR(10 g) = 0.175 mW/g

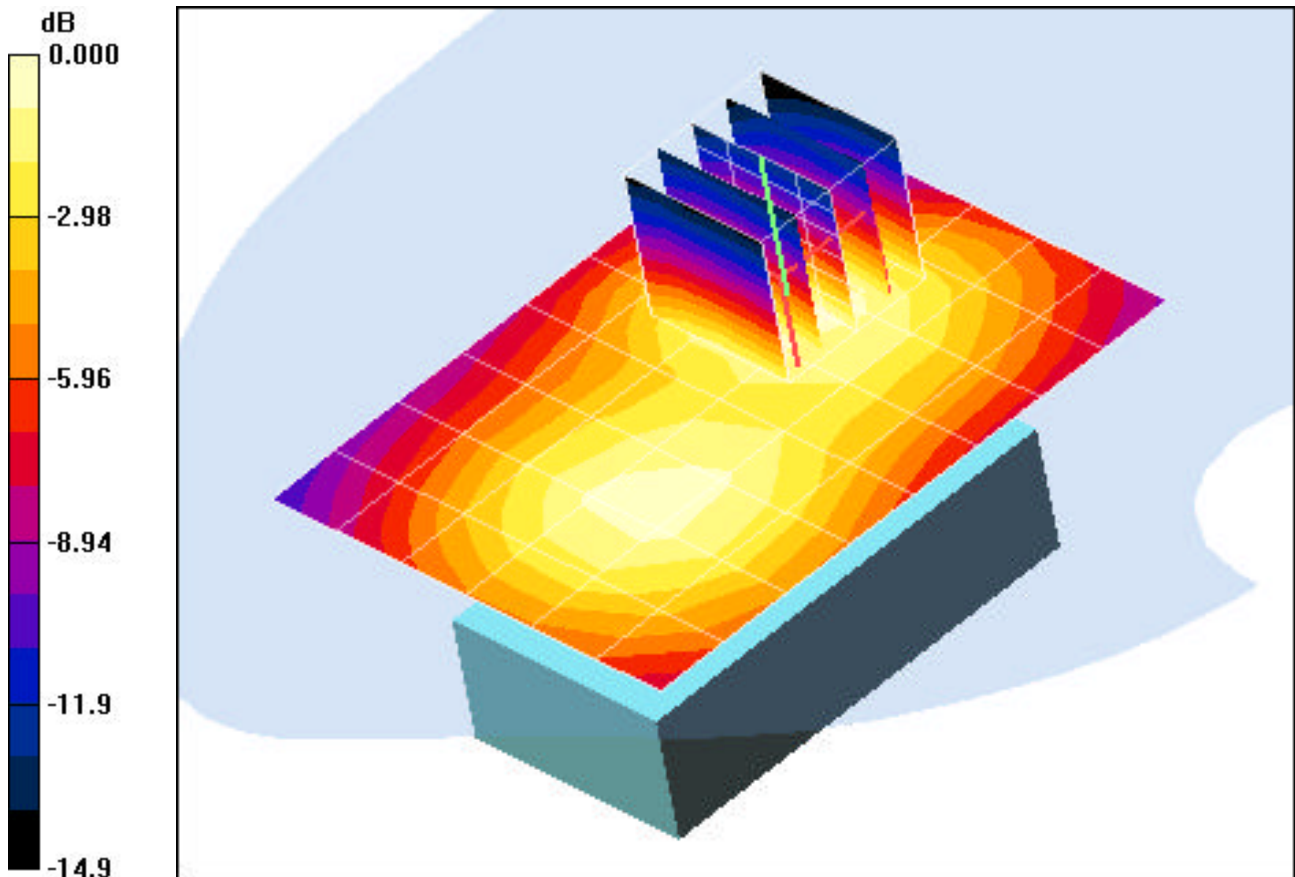

0 dB = 0.354mW/g

PCTEST ENGINEERING LABORATORY, INC.

DUT: SCP -3200; Type: SANYO Tri Mode Phone; Serial: A0000000030FF; Conducted Power: 24.0 dBm

Communication System: PCS CDMA; Frequency: 1880 MHz; Duty Cycle: 1:1
Medium: 1900 Brain ($\sigma = 1.44$ mho/m, $\epsilon_r = 39.39$, $\rho = 1000$ kg/m³)
Phantom section: Flat Section; Space: 2.5 cm

Test Date: 12-05-2006; Ambient Temp: 23.1°C; Tissue Temp: 21.1°C

Probe: EX3DV4 - SN3561; ConvF(6.99, 6.99, 6.99); Calibrated: 11/23/2006
Sensor-Surface: 3mm (Mechanical Surface Detection)
Electronics: DAE3 Sn455; Calibrated: 10/16/2006
Phantom: SAM Sub; Type: SAM 4.0; Serial: TP:1357
Measurement SW: DASY4, V4.7 Build 44; Postprocessing SW: SEMCAD, V1.8 Build 171

Mode: PTT, Face SAR, Flip Open, Mid.ch, Standard Battery

Area Scan (7x14x1): Measurement grid: dx=15mm, dy=15mm
Zoom Scan (5x5x7)/Cube 0: Measurement grid: dx=8mm, dy=8mm, dz=5mm
Reference Value = 2.41 V/m
Peak SAR (extrapolated) = 0.360 W/kg
SAR(1 g) = 0.233 mW/g; SAR(10 g) = 0.146 mW/g

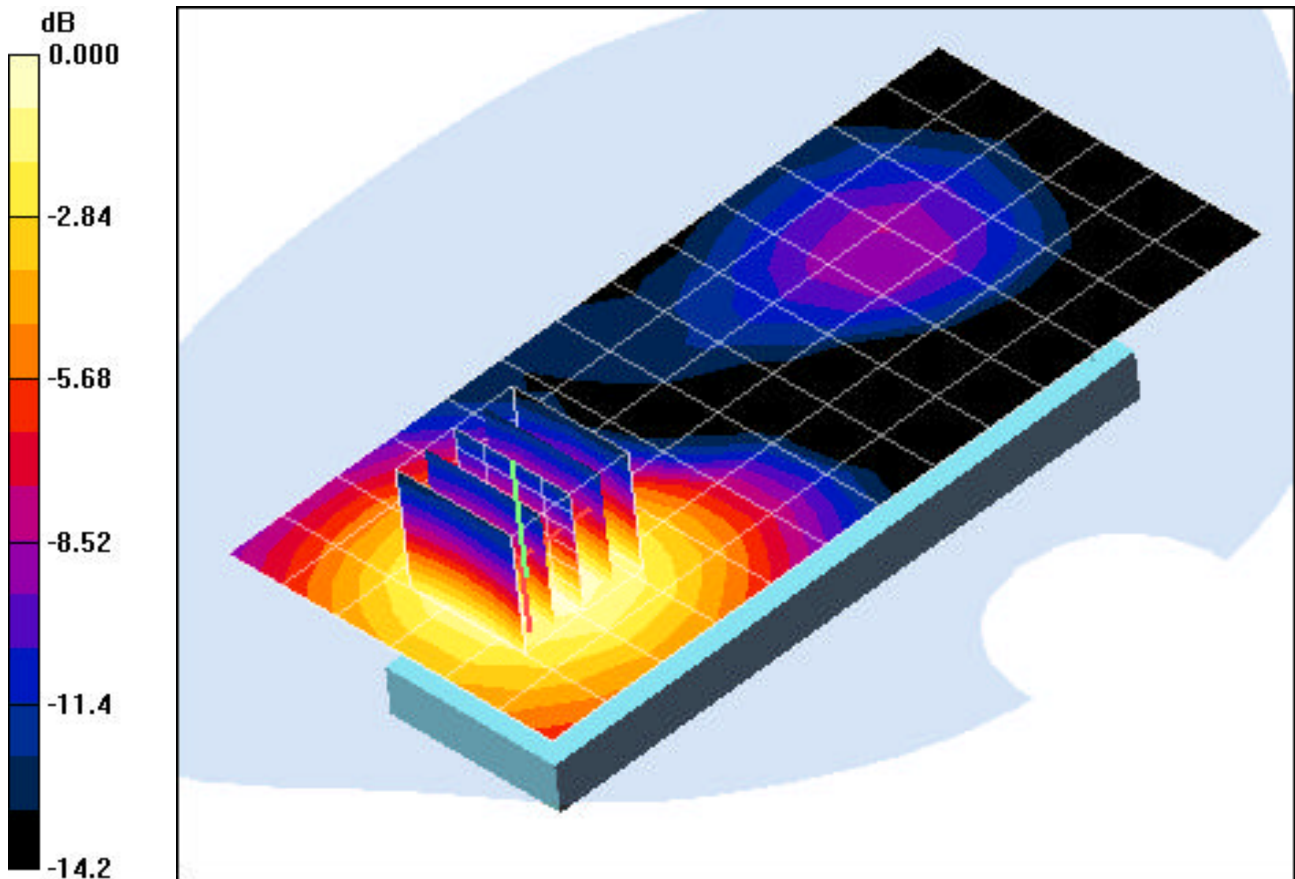

0 dB = 0.272mW/g

PCTEST ENGINEERING LABORATORY, INC.

DUT: SCP -3200; Type: SANYO Tri Mode Phone; Serial: A0000000030FF; Conducted Power: 24.0 dBm

Communication System: PCS CDMA; Frequency: 1880 MHz; Duty Cycle: 1:1
Medium: 1900 Brain ($\sigma = 1.44$ mho/m, $\epsilon_r = 39.39$, $\rho = 1000$ kg/m³)
Phantom section: Flat Section; Space: 2.5 cm

Test Date: 12-05-2006; Ambient Temp: 23.1°C; Tissue Temp: 21.1°C

Probe: EX3DV4 - SN3561; ConvF(6.99, 6.99, 6.99); Calibrated: 11/23/2006
Sensor-Surface: 3mm (Mechanical Surface Detection)
Electronics: DAE3 Sn455; Calibrated: 10/16/2006
Phantom: SAM Sub; Type: SAM 4.0; Serial: TP:1357
Measurement SW: DASY4, V4.7 Build 44; Postprocessing SW: SEMCAD, V1.8 Build 171

Mode: PTT, Face SAR, Flip Close, Mid.ch, Standard Battery

Area Scan (7x9x1): Measurement grid: dx=15mm, dy=15mm
Zoom Scan (5x5x7)/Cube 0: Measurement grid: dx=8mm, dy=8mm, dz=5mm
Reference Value = 9.08 V/m
Peak SAR (extrapolated) = 0.211 W/kg
SAR(1 g) = 0.135 mW/g; SAR(10 g) = 0.085 mW/g

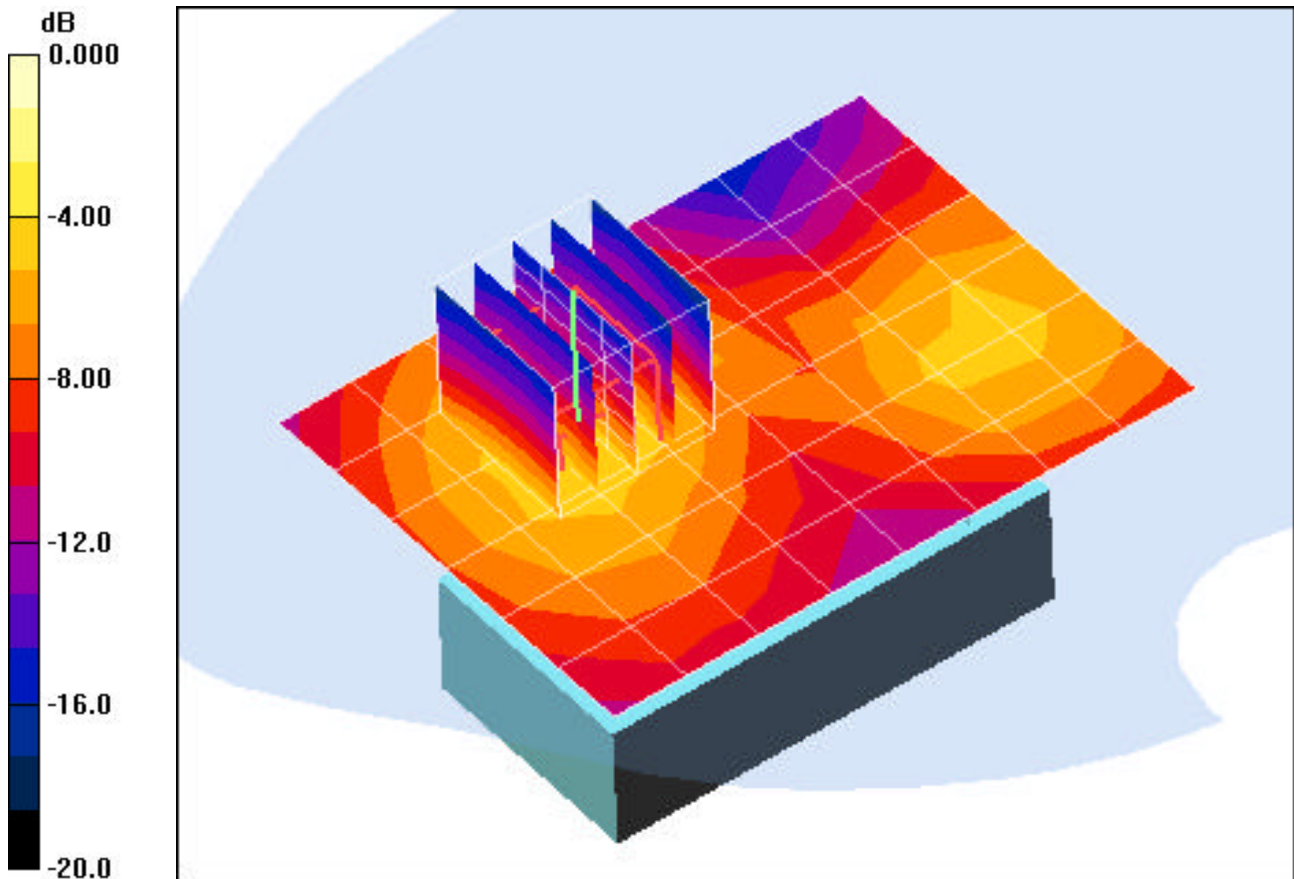

0 dB = 0.400mW/g

PCTEST ENGINEERING LABORATORY, INC.

DUT: SCP -3200; Type: SANYO Tri Mode Phone; Serial: A0000000030FF; Conducted Power: 24.5 dBm

Communication System: AMPS; Frequency: 848.97 MHz; Duty Cycle: 1:1
Medium: 835 Brain ($\sigma = 0.90$ mho/m, $\epsilon_r = 40.43$, $\rho = 1000$ kg/m³)
Phantom section: Right Section

Test Date: 12-04-2006; Ambient Temp: 23.3°C; Tissue Temp: 21.4°C

Probe: EX3DV4 - SN3561; ConvF(7.91, 7.91, 7.91); Calibrated: 8/24/2005
Sensor-Surface: 3mm (Mechanical Surface Detection)
Electronics: DAE3 Sn455; Calibrated: 10/16/2006
Phantom: SAM Main; Type: SAM 4.0; Serial: TP:1197
Measurement SW: DASY4, V4.7 Build 44; Postprocessing SW: SEMCAD, V1.8 Build 171

Mode: AMPS, Right Head, Touch, High.ch, Standard Battery

Area Scan (7x14x1): Measurement grid: dx=15mm, dy=15mm
Zoom Scan (5x5x7)/Cube 0: Measurement grid: dx=8mm, dy=8mm, dz=5mm
Reference Value = 12.9 V/m
Peak SAR (extrapolated) = 2.21 W/kg
SAR(1 g) = 1.4 mW/g; SAR(10 g) = 0.898 mW/g

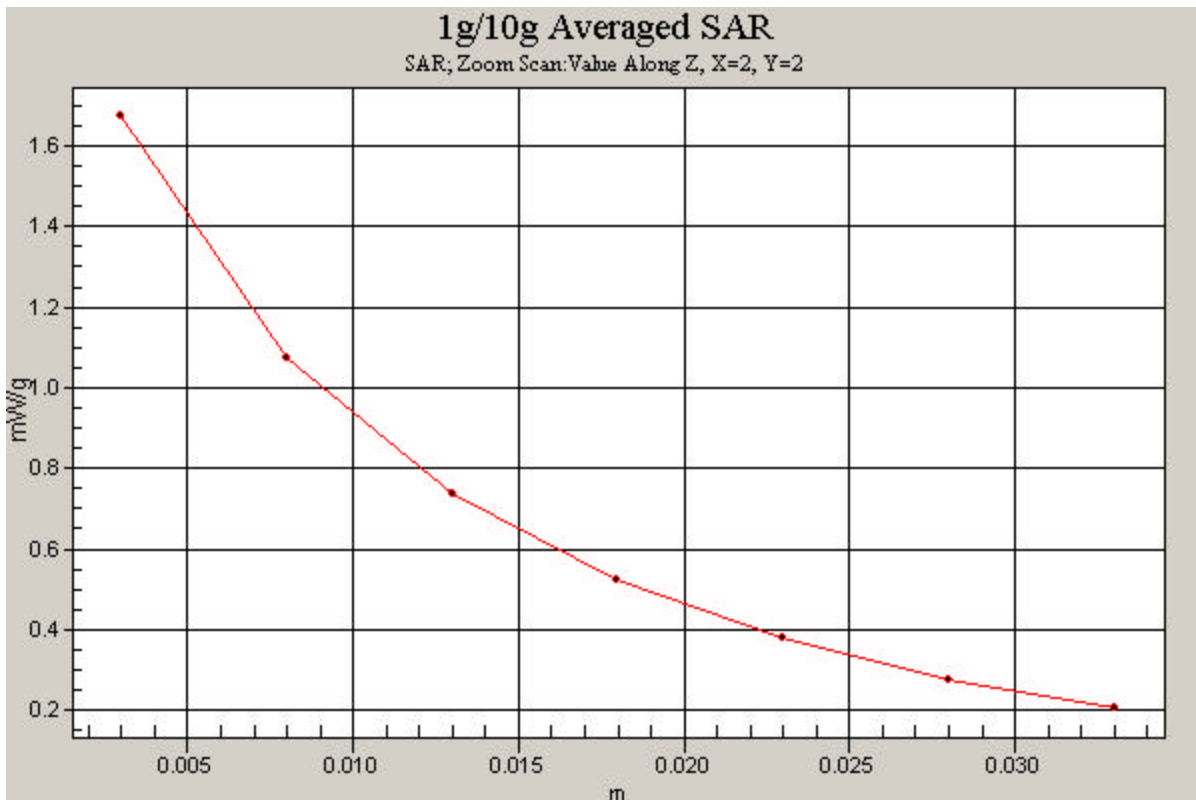

PCTEST ENGINEERING LABORATORY, INC.

DUT: SCP -3200; Type: SANYO Tri Mode Phone; Serial: A0000000030FF; Conducted Power: 24.0 dBm

Communication System: PCS CDMA; Frequency: 1880 MHz; Duty Cycle: 1:1
Medium: 1900 Brain ($\sigma = 1.44$ mho/m, $\epsilon_r = 39.39$, $\rho = 1000$ kg/m³)
Phantom section: Right Section

Test Date: 12-05-2006; Ambient Temp: 23.1°C; Tissue Temp: 21.1°C

Probe: EX3DV4 - SN3561; ConvF(6.99, 6.99, 6.99); Calibrated: 11/23/2006
Sensor-Surface: 3mm (Mechanical Surface Detection)
Electronics: DAE3 Sn455; Calibrated: 10/16/2006
Phantom: SAM Sub; Type: SAM 4.0; Serial: TP:1357
Measurement SW: DASY4, V4.7 Build 44; Postprocessing SW: SEMCAD, V1.8 Build 171

Mode: PCS, Right Head, Touch, Mid.ch, Standard Battery

Area Scan (7x14x1): Measurement grid: dx=15mm, dy=15mm
Zoom Scan (5x5x7)/Cube 0: Measurement grid: dx=8mm, dy=8mm, dz=5mm
Reference Value = 10.1 V/m
Peak SAR (extrapolated) = 2.56 W/kg
SAR(1 g) = 1.41 mW/g; SAR(10 g) = 0.706 mW/g

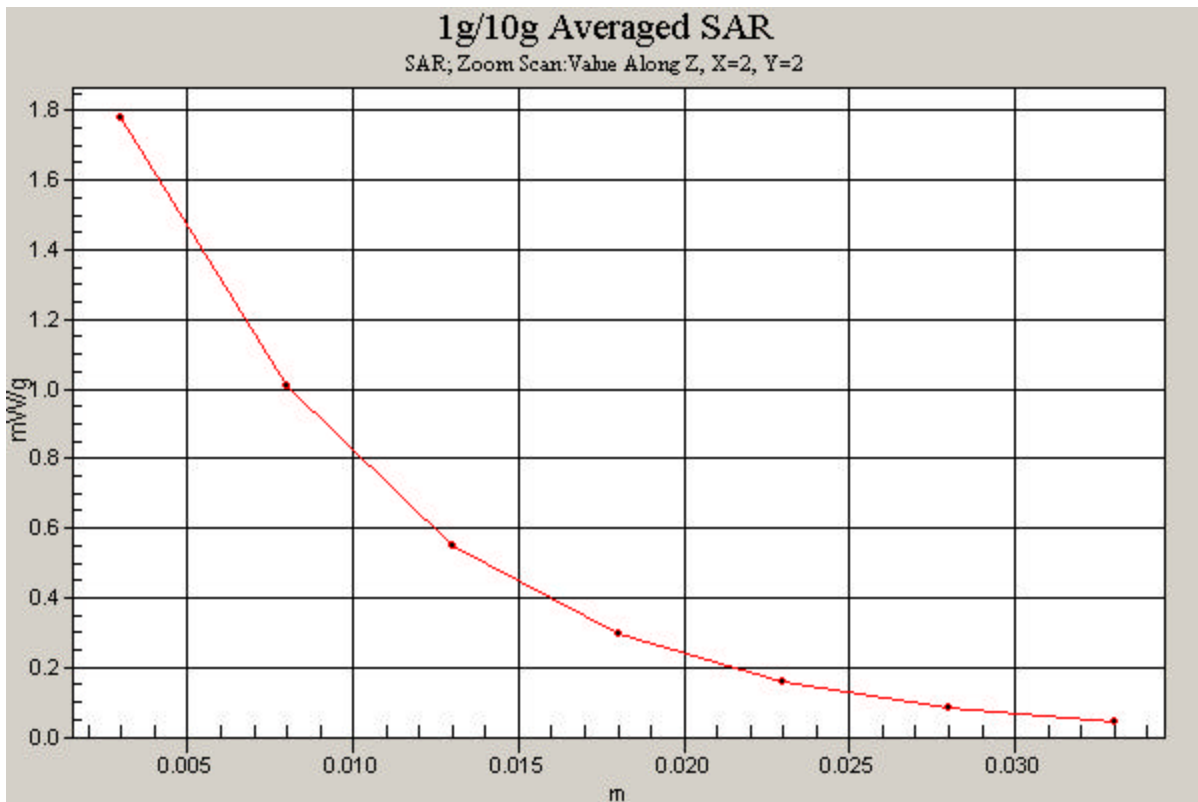

PCTEST ENGINEERING LABORATORY, INC.

DUT: SCP -3200; Type: SANYO Tri Mode Phone; Serial: A0000000030FF; Conducted Power: 24.5 dBm

Communication System: AMPS; Frequency: 836.49 MHz; Duty Cycle: 1:1

Medium: 835 Muscle ($\sigma = 0.97$ mho/m, $\epsilon_r = 54.71$, $\rho = 1000$ kg/m³)

Phantom section: Flat Section; Space: 2.2 cm

Test Date: 12-06-2006; Ambient Temp: 23.6°C; Tissue Temp: 21.0°C

Probe: EX3DV4 - SN3561; ConvF(7.92, 7.92, 7.92); Calibrated: 11/23/2006

Sensor-Surface: 3mm (Mechanical Surface Detection)

Electronics: DAE3 Sn455; Calibrated: 10/16/2006

Phantom: SAM Main; Type: SAM 4.0; Serial: TP:1197

Measurement SW: DASY4, V4.7 Build 44; Postprocessing SW: SEMCAD, V1.8 Build 171

Mode: AMPS, Body SAR, Back side, Mid.ch, Standard Battery

Area Scan (7x9x1): Measurement grid: dx=15mm, dy=15mm

Zoom Scan (5x5x7)/Cube 0: Measurement grid: dx=8mm, dy=8mm, dz=5mm

Reference Value = 13.8 V/m

Peak SAR (extrapolated) = 0.579 W/kg

SAR(1 g) = 0.442 mW/g; SAR(10 g) = 0.312 mW/g

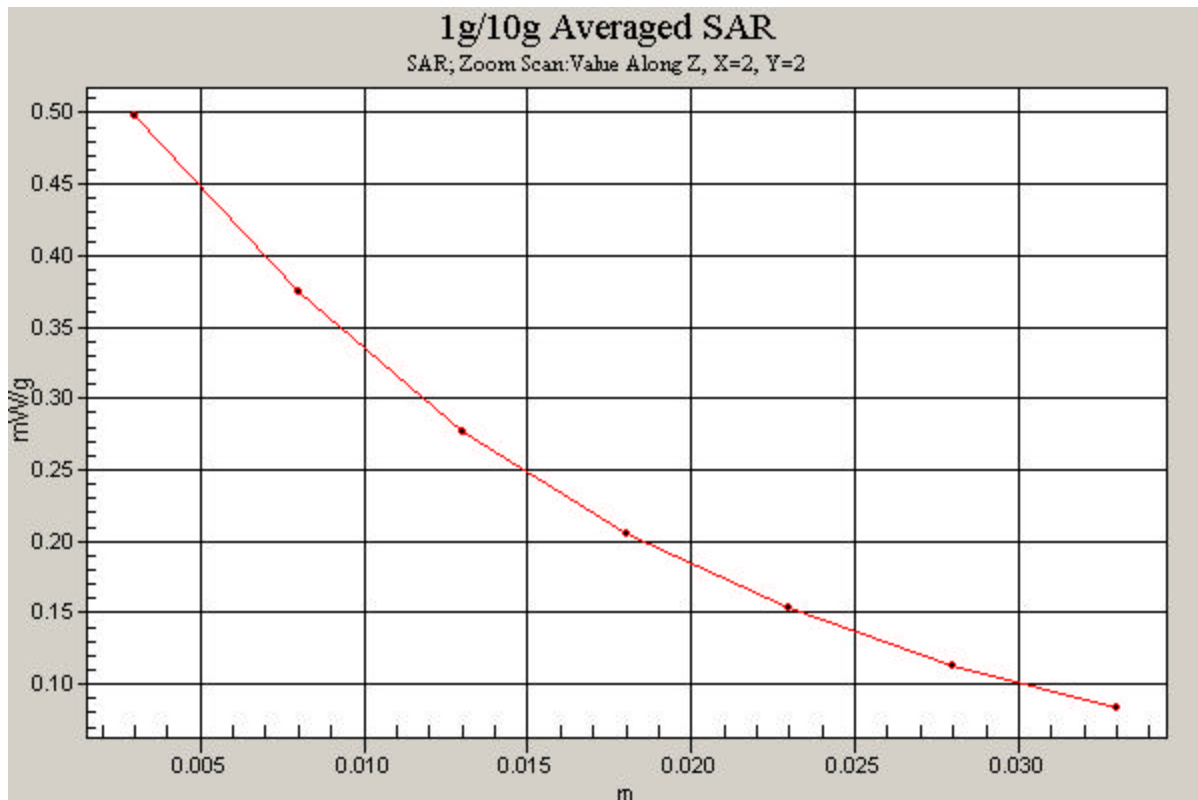

PCTEST ENGINEERING LABORATORY, INC.

DUT: SCP -3200; Type: SANYO Tri Mode Phone; Serial: A0000000030FF; Conducted Power: 24.0 dBm

Communication System: PCS CDMA; Frequency: 1880 MHz; Duty Cycle: 1:1

Medium: 1900 Muscle ($\sigma = 1.56$ mho/m, $\epsilon_r = 54.42$, $\rho = 1000$ kg/m³)

Phantom section: Flat Section; Space: 2.2 cm

Test Date: 12-06-2006; Ambient Temp: 23.3°C; Tissue Temp: 21.2°C

Probe: EX3DV4 - SN3561; ConvF(6.47, 6.47, 6.47); Calibrated: 11/23/2006

Sensor-Surface: 3mm (Mechanical Surface Detection)

Electronics: DAE3 Sn455; Calibrated: 10/16/2006

Phantom: SAM Sub; Type: SAM 4.0; Serial: TP:1357

Measurement SW: DASY4, V4.7 Build 44; Postprocessing SW: SEMCAD, V1.8 Build 171

Mode: PCS, Body SAR, Back side, Mid.ch, Standard Battery

Area Scan (7x9x1): Measurement grid: dx=15mm, dy=15mm

Zoom Scan (5x5x7)/Cube 0: Measurement grid: dx=8mm, dy=8mm, dz=5mm

Reference Value = 10.9 V/m

Peak SAR (extrapolated) = 0.485 W/kg

SAR(1 g) = 0.295 mW/g; SAR(10 g) = 0.175 mW/g

