

# SANYO

## INSTRUCTION MANUAL

EM-F1010M

### Microwave Oven

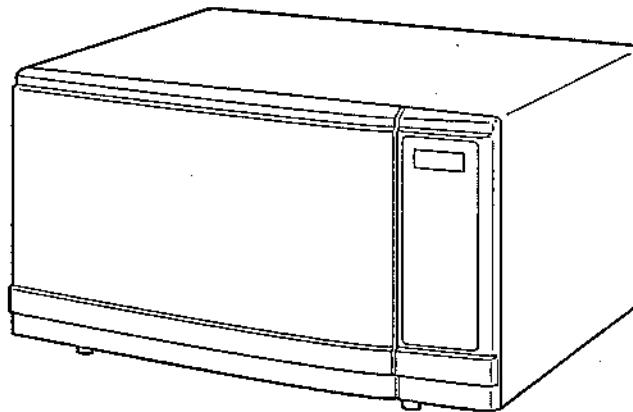

Read these instructions carefully before using your microwave oven.  
If you follow the instructions, your oven will provide you with many years of good service.

**SAVE THESE INSTRUCTIONS**

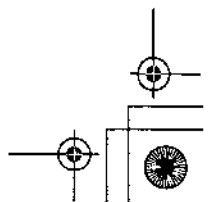
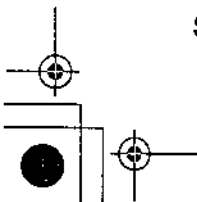

## PRECAUTIONS TO AVOID POSSIBLE EXPOSURE TO EXCESSIVE MICROWAVE ENERGY

- (a) **Do not** attempt to operate this oven with the door open since open-door operation can result in harmful exposure to microwave energy. It is important not to defeat or tamper with the safety interlocks.
- (b) **Do not** place any object between the oven front face and the door or allow soil or cleaner residue to accumulate on sealing surfaces.
- (c) **Do not** operate the oven if it is damaged. It is particularly important that the oven door closes properly and that there is no damage to the:
  - (1) DOOR (bent)
  - (2) HINGES AND LATCHES (broken or loosened)
  - (3) DOOR SEALS AND SEALING SURFACES
- (d) **The oven** should not be adjusted or repaired by anyone except properly qualified service personnel.

### SPECIFICATIONS

<b>Model:</b>	EM-F1010M
<b>Power Source:</b>	AC 120 V, 60 Hz
<b>Power Consumption:</b>	920W
<b>Maximum Output:</b>	600W*
<b>Oven Capacity:</b>	0.7 cu. ft.
<b>Turntable Diameter:</b>	10- <sup>13</sup> / <sub>16</sub> "
<b>Dimensions: (w x h x d)</b>	18- <sup>3</sup> / <sub>16</sub> " x 9- <sup>13</sup> / <sub>16</sub> " x 13- <sup>13</sup> / <sub>16</sub> "
<b>Weight: Approx.</b>	25.5 lbs

Specifications subject to change without notice.

\*According to IEC-705 test procedures. The IEC-705 test procedure is an internationally recognized method of rating microwave wattage output.

### Please record your product's information

When you call to request service, you need to know your complete model number and serial number. Please fill in the information below. Please also record purchase date, price and where purchased.

**Model Number:** \_\_\_\_\_ (Located on the inner left side of the control panel)

**Serial Number:** \_\_\_\_\_ (Located on the inner left side of the control panel)

**Date of Purchase:** \_\_\_\_\_

**Purchase Price:** \_\_\_\_\_

**Where Purchased:** \_\_\_\_\_

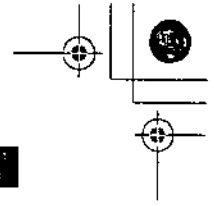
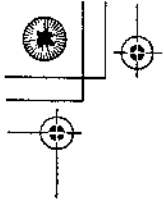

## SAFETY

### PROPER AND SAFE USE OF YOUR OVEN

- The oven must be level.
- The turntable and turntable roller rest must be in the oven during cooking.
- Place the cookware gently on the turntable and handle it carefully to avoid possible breakage.
- Incorrect use of browning dish may cause the turntable to break. See page 7.
- Use only the specified bag size when using Direct Access Popcorn.
- The oven has several built-in safety switches to ensure that the power remains off when the door is open. Do not tamper with these switches.
- Do not operate the microwave oven empty. Operating the oven with no food or food that is extremely low in moisture can cause fire, charring or sparking.
- Do not cook bacon directly on the turntable. Excessive local heating of the turntable may cause it to break.
- Do not heat baby bottles or baby food in the microwave oven. Uneven heating may occur and could cause physical injury.
- Do not heat narrow-necked containers, such as syrup bottles.
- Do not attempt to deep-fry in your microwave oven.
- Do not do home canning in this microwave oven as it is impossible to be sure all contents of the jar have reached boiling temperature.
- Do not use this microwave oven for commercial purposes. This microwave oven is made for household use only.
- Liquids, such as beverages, that are heated in a microwave oven, can overheat beyond their boiling point without any evidence of bubbling. This could result in hot liquids suddenly boiling over. To prevent this occurrence, the following steps should be taken:
  - (a) Avoid using straight-sided containers with narrow necks.
  - (b) Do not overheat.
  - (c) Stir the liquid before placing the container in the oven and again halfway through the heating time.
  - (d) After heating, allow to stand in the oven for a short time, stirring again before carefully removing the container.

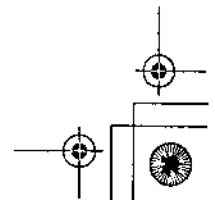
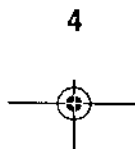
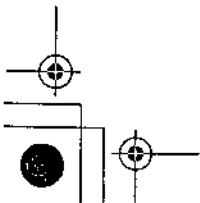

# IMPORTANT SAFETY INSTRUCTIONS

When using electrical appliances, basic safety precautions should be followed, including the following:

**WARNING** - To reduce the risk of burns, electric shock, fire, injury to persons or exposure to excessive microwave energy:

1. Read all instructions before using the appliance.
2. Read and follow the specific "PRECAUTIONS TO AVOID POSSIBLE EXPOSURE TO EXCESSIVE MICROWAVE ENERGY" on page 2.
3. As with most cooking appliances, close supervision is necessary to reduce the risk of a fire in the oven cavity.
4. Some products such as whole eggs, water with oil or fat, sealed containers and closed glass jars may explode and therefore should not be heated in this oven.
5. Use this appliance only for its intended use as described in the manual. Do not use corrosive chemicals or vapors in this appliance. This oven is specifically designed to heat or cook food. It is not designed for industrial or laboratory use.
6. As with any appliance, close supervision is necessary when used by children.
7. Do not operate this oven if it has a damaged cord or plug, if it is not working properly or if it has been damaged or dropped.
8. This appliance should be serviced only by qualified service technicians. Contact the nearest authorized service facility for examination, repair or adjustment.
9. Do not cover or block any vents on the oven.
10. Do not store or use this appliance outdoors.
11. Do not use this oven near water, near a kitchen sink, in a wet basement or near a swimming pool, and the like.
12. Do not immerse cord or plug in water.
13. Keep cord away from heated surfaces.
14. Do not let cord hang over edge of table or counter.
15. When cleaning door and oven surfaces that meet when door is closed, use only mild, nonabrasive soaps or detergents applied with a sponge or soft cloth. (See "Cleaning" instructions on page 29.)

**If a fire should start:**

- Keep the oven door closed
- Turn the oven off, and
- Disconnect the power cord or shut off power at the fuse or circuit breaker panel.

**Keep in mind the following rules at all times:**

- a. Do not overcook food. Carefully attend the appliance if paper, plastic, or other combustible materials are placed inside the oven to facilitate cooking.
  - b. Do not use the oven cavity for storage purposes. Do not store combustible items such as bread, cookies, paper products, etc. inside the oven. If lightning strikes the power line, the oven may turn on by itself.
  - c. Remove wire twist-ties and metal handles from paper or plastic containers/bags before placing them in the oven.
4. This oven must be grounded. Connect only to properly grounded outlet. See "GROUNDING INSTRUCTIONS" on page 6.
  5. Install or locate this oven only in accordance with the provided installation instructions.



## SAVE THESE INSTRUCTIONS

## GROUNDING INSTRUCTIONS

### **⚠ DANGER**

#### **Electric Shock Hazard**

- Touching some of the internal components can cause serious personal injury or death. Do not disassemble this appliance.

### **⚠ WARNING**

#### **Electric Shock Hazard**

- Improper use of the grounding can result in electric shock. Do not plug into an outlet until appliance is properly installed and grounded.

#### **Three-pronged (grounding) plug**

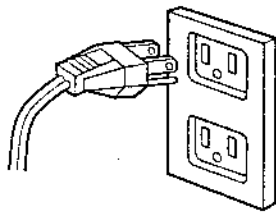

Properly polarized and grounded outlet

This appliance must be grounded. In the event of an electrical short circuit, grounding reduces the risk of electric shock by providing an escape wire for the electric current. This appliance is equipped with a cord having a grounding wire with a grounding plug. The plug must be plugged into an outlet that is properly installed and grounded.

Consult a qualified electrician or serviceman if the grounding instructions are not completely understood or if doubt exists as to whether the appliance is properly grounded. If it is necessary to use an extension cord, use only a 3-wire extension cord that has a 3-pronged grounding plug, and a 3-slot receptacle that will accept the plug on the appliance.

- A short power-supply cord is provided to reduce the risks resulting from becoming entangled in or tripping over a longer cord.
- Longer cord sets or extension cords may be used if care is exercised in their use.
- If a long cord or extension cord is used: 1) The marked electrical rating of the cord set or extension cord should be at least as great as the electrical rating of the appliance. 2) The extension cord must be a grounding-type 3-wire cord, and 3) The longer cord should be arranged so that it will not drape over the counter top or tabletop where it can be pulled on by children or tripped over unintentionally.

## UTENSILS

### **⚠ CAUTION**

#### **Personal Injury Hazard**

- Tightly-closed utensils could explode. Closed containers should be opened and plastic pouches pierced before cooking.

See following page for further instructions "Materials you can use in microwave oven or to be avoided in microwave oven."

#### **Utensil Test:**

1. Fill a microwave-safe container with 1 cup of cold water (250 mL) along with the utensil in question.
2. Cook on **maximum** power (P100) for 1 minute.
3. Carefully feel the utensil. If the empty utensil is warm, do not use it for microwave cooking. **Do not exceed 1 minute testing time.**

#### **CAUTION:**

1. Do not use plastic containers for testing.
2. Some containers and dishware may be warm (or hot) in only one area. Do not use a container that becomes warm anywhere.

## SET UP

### NAMES OF OVEN PARTS AND ACCESSORIES

Remove the oven and all materials from the carton.  
Your oven comes with the following accessories:

- 1 Turntable
- 1 Turntable roller rest
- 1 Instruction Manual

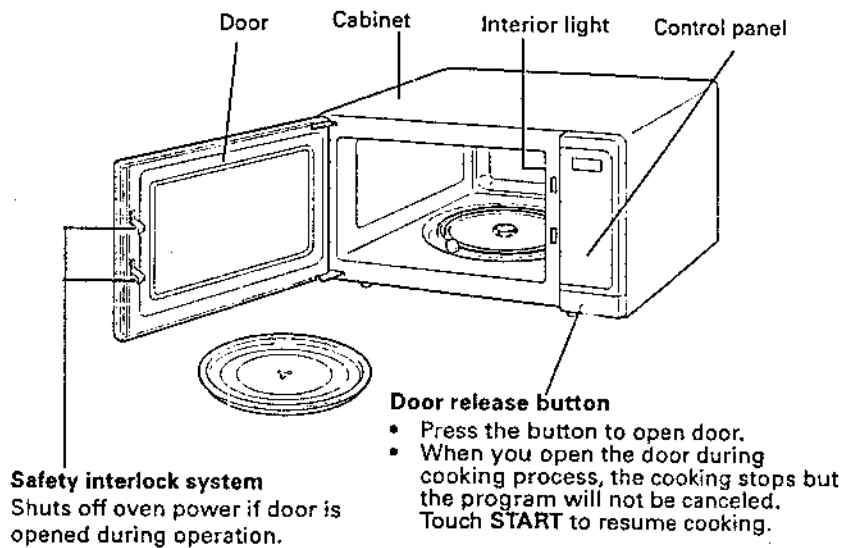

### TURNTABLE INSTALLATION

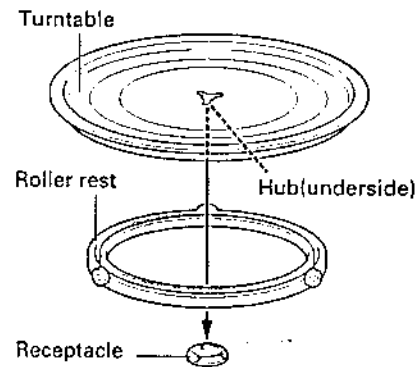

1. Place the roller rest on the cavity bottom.
2. Place the turntable on top of the roller rest as shown in the diagram. Make sure the turntable hub is securely locked in the receptacle.

- **Never place the turntable upside down.** The turntable should never be restricted.
- Both turntable and roller rest must always be used during cooking.
- All food and containers of food are always placed on the turntable for cooking.
- **The turntable returns to its original starting position** when cooking is finished. The light and fan will remain on but microwave power is turned off.
- The turntable rotates clockwise and counterclockwise; this is normal.
- If Turntable or roller rest cracks or breaks, contact your nearest authorized service center for more information regarding replacement.

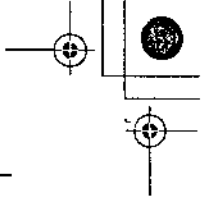
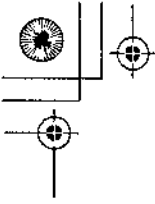

## INSTALLATION

Remove all packing material and accessories. Examine the oven for any damage such as dents or broken door. Do not install if oven is damaged.

**NOTE:** This unit is not designed for 50 Hz or any circuit other than a 120-volt/60-Hz AC circuit. This oven is designed for countertop installation.

### Countertop Installation

1. Select a level surface that provides enough open space for the intake and/or outlet vents.

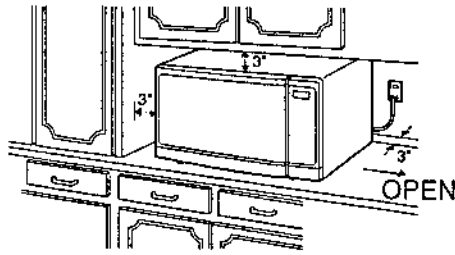

A minimum clearance of 3 inches is required between the oven and any adjacent wall. One side must be open.

- Leave a minimum clearance of 3 inches above the oven.
  - Do not remove the legs from the bottom of the oven.
  - Blocking the intake and/or outlet openings can damage the oven.
  - Place the oven as far away from radios and TV's as possible. Operation of microwave oven may cause interference to your radio or TV.
  - If the cabinet is covered with a protective film, remove the film.
2. Plug your oven into a standard 120-volt / 60-Hz household outlet. Be sure the electrical circuit is at least 15 amperes and that your microwave oven is the only appliance on the circuit.

**WARNING:** Do not install oven over a range cooktop or other heat-producing appliance. If installed near or over a heat source, the oven could be damaged and the warranty would be void.

