











# Operating Instructions

## Name & function of parts

- 1 **Antenna**
- 2 **Incoming call light**  
blinks green when the phone rings, and lights red during battery charging.
- 3 **Sub-display**  
shows wait time, receive time, etc. while the set is closed.
- 4 **Speaker**  
used to incoming calls.
- 5 **Strap hole**
- 6 **Ear-microphone jack**  
used to connect an optional switchable ear microphone.
- 7  **key**  
used to set a message or to enter a selected item (similar functions as the  key on top of the set).
- 8 ,  **Up/Down keys**  
used to adjust the volume, scroll through the Memory Dial contents, convert characters, and to make function settings (similar functions as the  key on top of the set).
- 9 **Earpiece**  
used to hear, other party's voice, various messages, etc.
- 10 **Display**  
shows various settings, phone numbers, etc.
- 11 **Flexible keys**  
used to select items shown at the bottom of the display (refer to "Using the flexible keys" on page 391.)
- 12  **key**  
used for the EZweb service.
- 13 **Volume/Retrieve/Convert/Phonebook(☎)/Redial(☎)/Cursor key**  
used to set the volume, call a memory dial, redial, convert Kanji characters, and select functions.
- 14  **(Start) key**  
used to make or receive a call.
- 15 **Dial keys**  
used to enter phone numbers and characters.
- 16 **Microphone**  
used to convey your voice during a call.
- 17 **External connection terminal**  
used to connect an optional device such as a quick-rechargeable cigarette lighter adapter.
- 18  **(End) key**  
used to turn on and off the power, to end a call, or to hold a response.
- 19  **key**  
used to call the menu or to enter selected items.
- 20  **key**  
used to send and receive E-mail and C-mail service, to delete characters, or to return to the previous display.

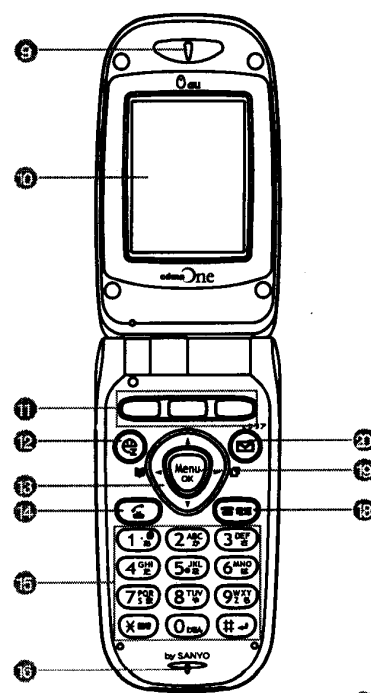
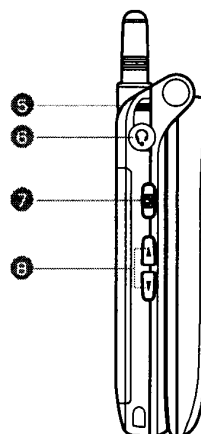
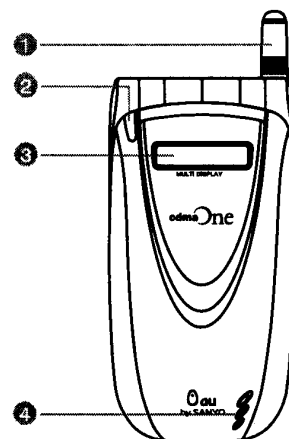

## Display indications

●The following illustration is for explanation purpose only. Not all indications will actually be displayed at the same time.

●When any key is pressed, illumination will turn on for about 10 seconds.

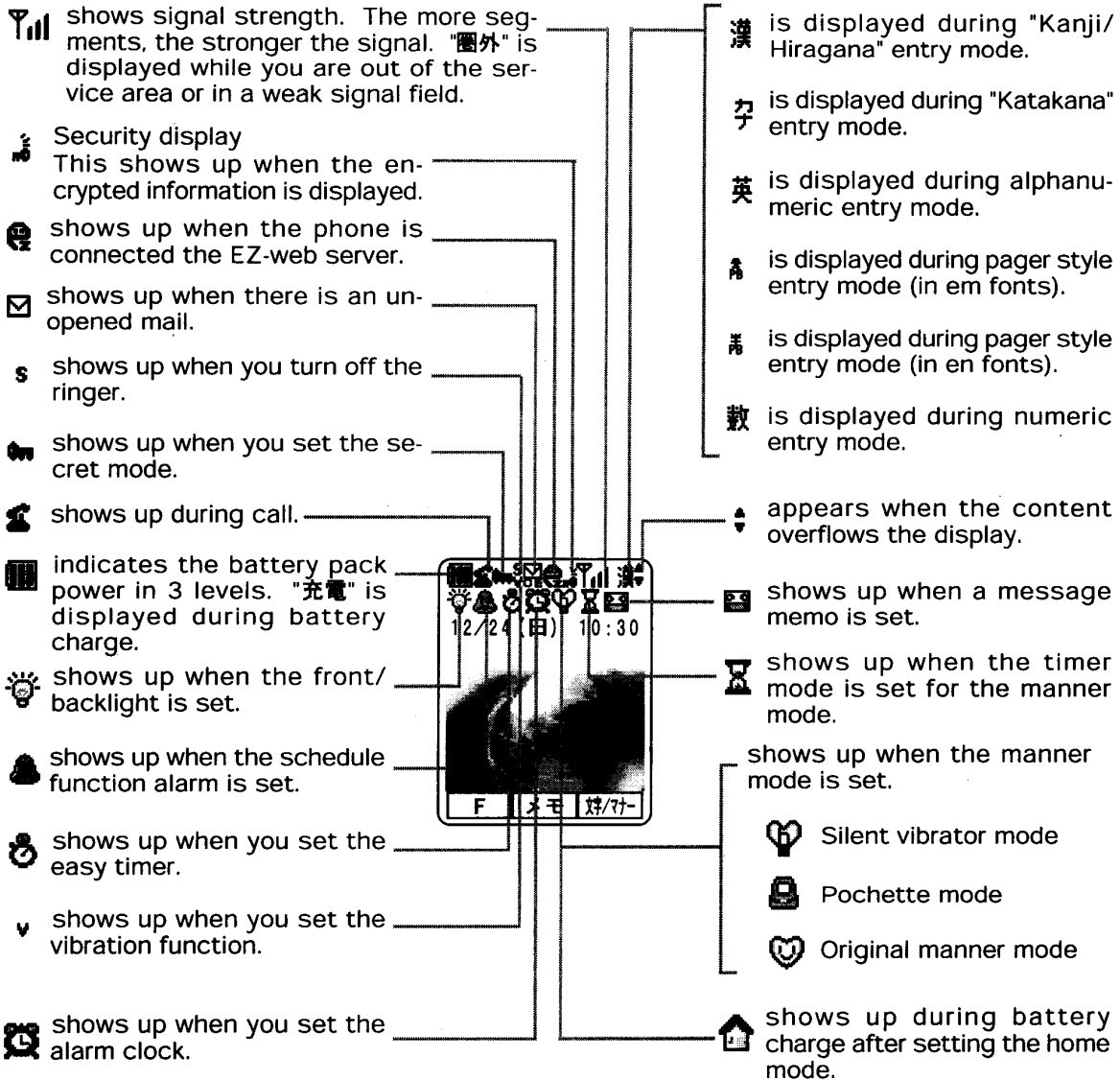

その他

Operating Instructions

### Power saving during standby for next information

In order to minimize the power consumption, the cdmaOne C412SA display turns automatically to power saving mode when key operation is stopped for a while.

Indication "🔒" turns to "🔇" in power saving mode.

The indication restores with key operation.

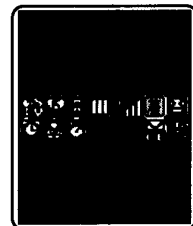

## ■ Using the flexible keys

The flexible keys correspond to the items shown at the bottom of the display. Press the key below each indication to select it.

There are several different patterns of indications shown on the display, and the functions of the flexible keys vary accordingly.

In this instruction manual, the indications for the flexible keys are expressed as shown below.

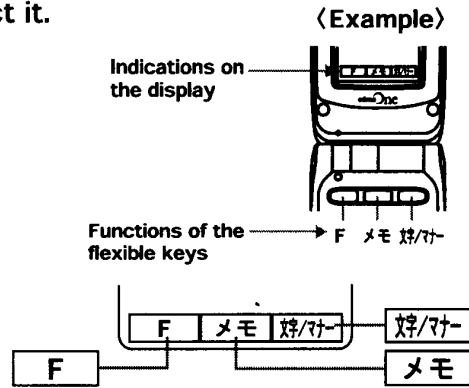

※The illustrations in this manual differs slightly from the actual displays.



## ■ key

In this instruction manual, the point at which to press the  key is indicated as shown below.

Example) Press top or bottom → 

- Continuous scrolling can be made by holding down.

## Sub-display indications

- The following illustration is for explanation purpose only. Some indications will not be displayed depending on circumstances.
- When , ,  is pressed, illumination will turn on for about 10 seconds.
- The sub-display does not work while the cover is opened.

Manner mode, ringer and vibrator settings are displayed.

- \$ shows up when you turn off the ringer.
- ▼ shows up when you set the vibration function.
- 🔇 Silent vibrator mode
- 📞 Pochette mode
- 📞 Original manner mode
- 📞 Home mode
- 🔋 indicates the battery pack power in 3 levels. "充" is displayed during battery charge.

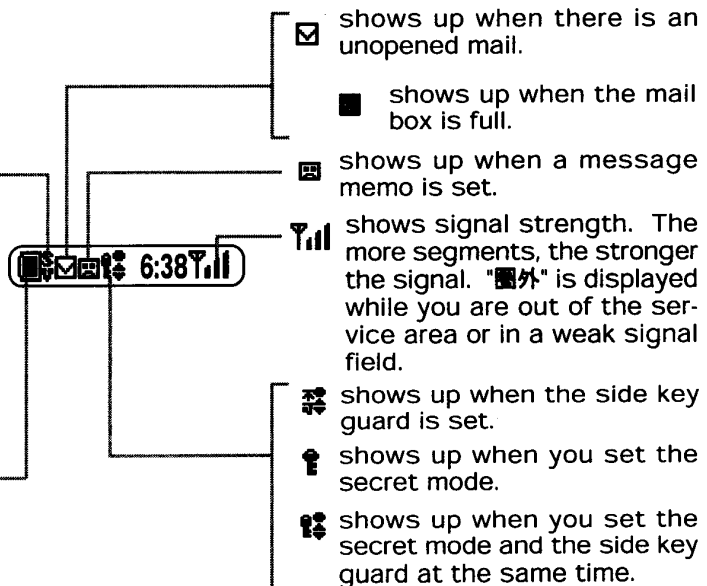

## Charging with the AC Adapter

1. Insert the connector of the AC adapter firmly into the desktop charger (see figure 1).
2. Connect the plug of the AC adapter to an AC 100V wall outlet (see figure 2).
3. Place the au telephone unit (with battery pack attached) into the desktop charger with care of the direction. (see figure 3, 4)  
The light (of incoming call / charging) lights up in red, "充電" appears on the display and then begins to charge the battery.

	While charging	Fully charged
Light	lights up in red	lights up in green
Display	「充電」 appears	Phone unit's power is ON → The 「  」 appears Phone unit's power is OFF → disappears

4. When fully charged, remove the phone from the desktop charger, and then disconnect the plug from the AC wall outlet.

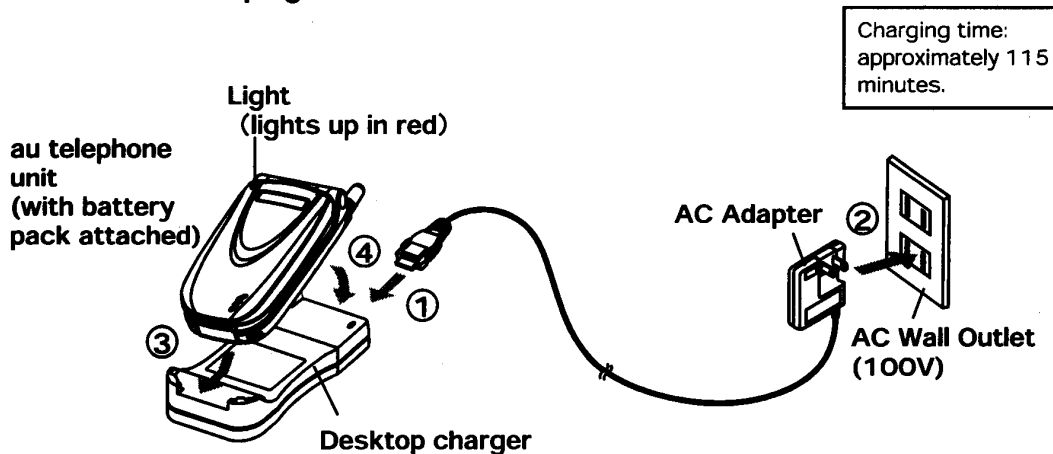

- You can charge the battery with turning the power ON, but it will take longer.
- If the battery has not been used for a long period or not charged for some time after sounding the alert tone, it may not start charging. Other than the cases that the battery is broken or its life is over, it starts charging in the normal way some minutes later.
- When you charge the battery in weak signal areas, it might take time for the light (of incoming/charging) to light up after you set the phone unit into the desktop charger.
- After charging, pull out the connector with pushing both side release buttons.

## 2 Extending the antenna

The radio waves cannot be transmitted or received well if the antenna is not extended. To facilitate transmission and reception of radio waves, use the phone by positioning the antenna vertically with respect to the ground.

• Extending the antenna.

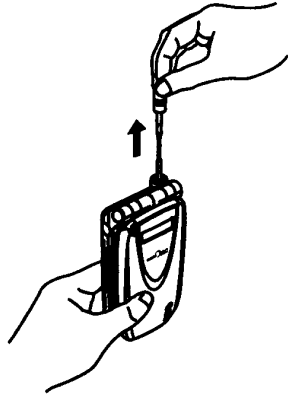

Extend the antenna until it stops with a click.

• Retracting the antenna.

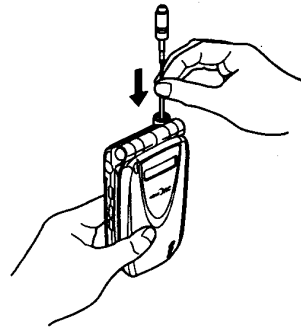



Move it straight down by pulling on a lower part of the antenna.

To avoid damaging the antenna, never apply direct pressure to the top part of the antenna.

### 3 Turning the power on.

Press and hold  or more than one second.

When you turn the power on, you'll hear the wake-up tone.  
After a few seconds, the sign will change to standby.  
(The display remains lit for about 10 seconds.)

"Charamigo" data is not registered at the time of purchase. The message "キャラミーゴ用データ未登録です 登録しますか" appears when you turn the power on. When you press  (YES) and register "Charamigo" data, the character is displayed thereafter. (see Charamigo Function Guidebook.) If you press  (NO), standby indication will be displayed.

Until you register the user data or cancel the character display function (see Charamigo Function Guidebook.), the message "キャラミーゴ用データ未登録です 登録しますか" is displayed whenever you turn the power on.

#### ◆ Turning the power off

Press and hold  for more than one second.

Power is turned off.

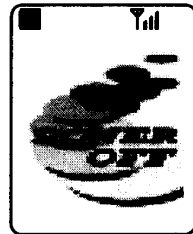
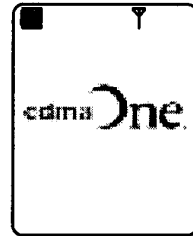

In this manual, the display shows the indications for the case when the character display function is off.

## 4 Checking the display screen

Check the display screen and make sure it is shown in the figure below after you turn the power on. This will indicate if the phone is in good working order.

The availability of power is indicated in three levels.



- when no power is left  
「充電(電池交換)してください」  
appears on the display.



This display shows telephone signal strength.  
A display of 3 bars shows the most ideal condition for telephoning.

- Even in main service areas there are places that only receive weak signals.  
In this case, you might not hear well or your call may be cut off.

The above battery level figures show remaining battery strength.  
Certain charges in conditions may cause the battery level figures  
to fluctuate.(See example of figure right.)



## Displaying your own phone number.

1. While in standby mode or while making a call, press .
2. Pressing  displays your au telephone number.

## Calling a landline, a mobile, PHS phone.



1. Enter the phone number you want to call.

Area code - local code - subscriber's number.  
example: 03-0001-XXXX

Always include the area code, even when calling to a number in the same area you are in.

2. Press  to place a call.

If you enter a wrong number:

- Press  briefly - the last dialed digit will be deleted.
- Press and hold  the entire phone number will be deleted.

## Making an International Call

1. Enter the phone number you want to call using the following pattern.  
International dial code - Country code - Area code - subscriber's number
2. Press  to place the call.

**example:** to call New York City, number 123-XXXX,

	operation	explanation
1	Pressing "001"	KDDI access code : 001
2	Pressing "1"	country code of United States : 1
3	Pressing "212"	area code of New York City : 212
4	Pressing "123-XXXX"	subscriber's number : 123-XXXX
5	Press 	









To make international calls, you need to fill out an application from KDDI international call services. Call numbers are given below for your reference:

From landline phone or au phone: **0120-786-001** (toll free)  
(9:00 to 21:00)



## Answering a call

1. The ring tone sounds/vibrator buzzes, and the incoming call lamp flashes.
2. Press  to answer the call.

An incoming call can also be answered by pressing any of the , ,  or , , , ,  or  keys.

If you do not answer the call or the caller disconnects before the call is answered, "着信あり" will be displayed.

## Entering characters:

This is the method of entering names for registering memory dials and writing mail for "C mail" and "E mail."

Each time you press , the entry mode will change:

Press  and find the entry mode you want.

"Kanji", "Hiragana" entry mode.



"Katakana" entry mode.



"Alphabetic" entry mode.



"Phone number" entry mode.

Letters are assigned to each key as shown below. Press a key repeatedly to cycle through letters assigned to that key.

entry mode key	"Kanji", "Hiragana"	"Katakana"	"Alphanumeric"	"Phone number"
1	▶ あいうえお ◀ ▶ おえういあ ◀	▶ アイウエオ ◀ ▶ オエウイア ◀	▶ . @ - _ / : - 1 ▶	1
2	▶ かきくけこ ▶	▶ カキクケコ ▶	▶ ABCabc2 ▶	2
3	▶ さしすせそ ▶	▶ サシスセソ ▶	▶ DEFdef3 ▶	3
4	▶ たちつてと ▶	▶ タチツテト ▶	▶ GHIghi4 ▶	4
5	▶ なにぬねの ▶	▶ ナニヌネノ ▶	▶ JKLjkl5 ▶	5
6	▶ はひふへほ ▶	▶ ハヒフヘホ ▶	▶ MNOmno6 ▶	6
7	▶ まみむめも ▶	▶ マミムメモ ▶	▶ PQRSpqrs7 ▶	7
8	▶ やゆよやゆよ ▶	▶ ヤユヨヤユヨ ▶	▶ TUVtuv8 ▶	8
9	▶ らりるれろ ▶	▶ ラリルレロ ▶	▶ WXYZwxyz9 ▶	9
0	▶ わをんわ ▶	▶ ワヲン ▶	0	0
	▶ Symbols (full size), pictographs ▶ <sup>Note 1</sup>	▶ Symbols (half size) ▶ <sup>Note 1</sup>	▶ Symbols (half size) ▶ <sup>Note 1</sup>	*
	Line change <sup>Note 2</sup>			#
	/			P/-
	.			x (Impossible)
	.			x (Impossible)
	Switches lowercase.			x (Impossible)
	Move the cursor (  ) to the left and to the right.			
	Converts to Kanji characters.	Switches between full-size and half-size characters.	Switches between full-size and half-size characters.	

Note 1: It is possible enter symbols (full size), pictographs and symbols (half size).

Note 2: It is possible to put in the line change mark \* in entering characters in the EZweb service.

## Registering Memory Dials.

You can register frequently used phone numbers and E-mail addresses.  
You can store up to 500 phone numbers and E-mail addresses in the memory dials.

### ■ Registering memory dials (Start with the menu.)

To register memory dials, carry out the following basic operation.

**1. Press** .

The main menu is displayed.

**2. Select "電話帳" by**  **and press** .



The list of phone directory functions is displayed.

**3. Press** .

The registration selection of extension item is displayed.

: Extension item is registered.

: Extension item is not registered.

**4. Press**  **or** .

When  is pressed, the smallest vacant number of the memory numbers No.000 - No.099 is indicated.

When  is pressed, the smallest vacant number of the memory numbers No.100 - No.499 is indicated.

**5. Enter the item you want.**

Select the icon of the item you want by  and press  to enter it.













As for the items you can enter, see "Registration Items of Memory Dials".

**6. Press** .

This completes registration.

## ■ Registration Items of Memory Dials

You can register the following items in the memory dials, in addition to the phone numbers.

Icon	Item	Maximum entry characters	Remarks	
	Memory No.	—	000 - 499	
	Name	Up to 12 em-size characters (24 en-size characters)	—	
	Pronunciation	Up to 24 en-size characters	Names entered in Kanji/Hiragana are registered automatically.	
	Phone No.1	Up to 36 digits	—	
—	Class of No.1	—	Phone numbers can be classified and controlled in 6 classes.	
	Phone No.2	Up to 36 digits	You can register phone number only when "Phone No.1" is entered.	
—	Class of No.2	—	You can register phone number only when "Phone No.1" is entered.	
	E-mail address 1	Up to 64 en-size alphanumeric characters	—	
	E-mail address 2	Up to 64 en-size alphanumeric characters	You can register E-mail address only when "E-mail address" is entered.	
	Group No. (Group name)	—	You can classify and control names into 11 groups.	
	Special receptions	Special message memo	—	Message memo can be changed according to the name you preset.
		Special melody & animation	—	Melody & Animation can be changed according to the name you preset.
		Special ringer	—	Ringer can be changed according to the name you preset.
		Special image/color	—	Image/color can be changed according to the name you preset.
	Secret	—	You can prevent disclosing the content of registration to other persons.	
	Extension items	Address	Up to 40 em-size characters	—
		URL	Up to 128 en-size characters	—
		Memo	Up to 40 em-size characters	—
	(※1) Location information	—	Content of registration cannot be changed.	

(※1) These items can be registered in the memory dials of memory No. 000 - 099 only.

## **Making a call with Memory Dial.**

You can call by using phone numbers saved in Memory Dial.  
There are 8 ways to recall numbers saved in Memory Dial.

- ① Dial Memory Dial numbers by using the number pad.
- ② Dial by Japanese phonetic symbols, i.e. hiragana or katakana.
- ③ Dial by telephone book order.
- ④ Dial by letters.
- ⑤ Dial by phone number fragment.
- ⑥ Dial by memory number order.
- ⑦ Dial by group number.
- ⑧ Dial by type of phone.

## ■ Finding a name using the dial keys:

You can dial from a list of the names whose first letters are entered using a same dial key.

1. Press a desired dial key from - , and hold it for more than one second.

example: to find a name that begins with カ, キ, ク, ケ, コ, A, B, C, a, b, c, 2, press

2. Press and hold or press several times to scroll through and display the name you want.
3. Press
4. Press or access the telephone number.









## ■ Finding a name in the Japanese alphabetical order:

1. Press
2. Use to scroll through and display the name you want.
3. Press
4. Press or access the telephone number.









## ■ Finding a name in the stored telephone book:

1. Press
2. Press
3. Press or to access the telephone book.
4. Use to scroll through and display the name you want.
5. Press
6. Press or access the telephone number.







■ Finding a name using its first letter(s):

1. Press .
2. Press .
3. Enter the first letter(s) of the desired name.
4. Press  or .
5. Use  to scroll through and display the name you want.
6. Press .
7. Press  or  access the telephone number.









■ Finding a name by the phone number:

1. Press .
2. Press .
3. Enter the first several digits of the desired phone number.
4. Press  or .
5. Use  to scroll through and display the name you want.
6. Press .
7. Press  or  access the telephone number.







■ Finding a name in the order of the Memory Dial number:

1. Press .
2. Press .
3. Use  to scroll through and display the name you want.
4. Press .
5. Press  or  access the telephone number.

### ■ Finding a name by the Group number:

1. Press .
2. Press .
3. Press  - ,  to select the desired Group number.
4. Use  to scroll through and display the name you want to call.
5. Press .
6. Press  or  access the telephone number.

### ■ Finding a name by the phone type:

1. Press .
2. Press .
3. Press  to select the desired phone type.
4. Use  to scroll through and display the name you want.
5. Press .
6. Press  or  access the telephone number.

## Speed Dial:

### ■ Calling Memory Dial numbers 000-009

<EX.> To dial the phone number stored at number 005.

1. Press .
2. Press .

### ■ Calling Memory Dial numbers 010-099

<EX.> To dial the phone number stored at number 015.

1. Press , .
2. Press .



## List of functions

### Group F0

Mode No.	Function Description
F0	Instructions of functions besides F functions

### Group F10

Mode No.	Function Description
F11	Auto-lock ON/OFF
F12	Checking the estimated time and charge for the previous call
F13	Checking the estimated total time and charge for calls
F14	Displaying the duration for the current call
F15	Displaying the charge for the current call after ringing off
F16	Setting the remote talk function using an ear microphone
F17	Setting the auto answering function using an ear microphone
F18	Setting the quick call

### Group F20

Mode No.	Function Description
F21※	Ringer volume
F22※	Selecting ringer pattern
F23	Setting the vibrator with the ringer turned off
F24	Adjusting key response tone volume
F25※	Turning off sound effects
F26	Setting the disconnection alert
F27※	Composing a melody
F28	Adjusting speaker tone
F29※	Setting an original manner

### Group F30

Mode No.	Function Description
F31	Turning on the display illumination while a car cigarette lighter adapter is used
F32	Turning off the key illuminations
F33	Changing display color
F34	Adjusting contrast of display
F35	Setting display animation
F36※	Selecting the waiting mode display
F37	Setting display image effects
F38※	Displaying the characters
F39	Power save mode

### Group F40

Mode No.	Function Description
F40	Displaying the Memory Dial number registration status
F41	Resetting the estimated time for calls
F42	Resetting the estimated charge for calls
F43	Resetting the contents of memory
F44※	Resetting the function settings
F45※	Resetting the entire memory
F46	Changing the password
F47	Registering the area code
F48	Setting the rate for calls
F49※	Registering group names

### Group F50

Mode No.	Function Description
F51	Setting limits for transmission
F52	Locking Memory Dial function
F53	Setting limits for EZweb service
F54	Rejecting non-shared incoming calls and unwanted calls
F55	Prohibiting E-mail and C-mail service
F56	Setting secret mode

### Group F60

Mode No.	Function Description
F60	Registering profile
F61※	Setting melody & animation
F62	Setting pager style entry mode & registering user dictionary
F63	Setting the message memo, recording/playing/erasing the "absent" message
F64	Setting the answering time for the message memo
F65	Setting the ringer and the vibration
F66	Calculator
F67	Setting "home" mode
F68	Ranking the phone numbers by frequently of reception and transmission
F69※	Playing games

### Group F70

Mode No.	Function Description
F71	Entering the date, time or birthdays
F72※	Alarm
F73※	Registering schedule
F74	Auto Power ON
F75	Auto Power OFF
F76※	Setting easy timer
F77	Registering task list

### Group F80

Mode No.	Function Description
F80	Playing message(s) from the answering service
F81	Enabling answering service
F82	Canceling the answering service
F83	Changing the message(s) from the answering service
F84	Forwarding incoming calls without the answering message
F85	Forwarding incoming calls while the phone is used
F86	Forwarding incoming calls unconditionally
F87	Forwarding incoming calls selectively.
F88	Resetting call forwarding service
F89	Registering the destination for forwarding

### Group F90

Mode No.	Function Description
F91	Notifying receiving parties of your phone number
F92※	Setting the rates for communication
F93※	Setting data communications mode

※ : Unable to operate during the call.

## Specifications

<b>Weight:</b>	<b>approximately 100 g (including battery pack)</b>
<b>Continuous talk time:</b>	<b>approximately 150 minutes</b>
<b>Continuous standby time:</b>	<b>approximately 200 hours</b>
<b>Dimensions (H/W/D):</b>	<b>approximately 94mm x 49mm x 24mm</b> (not including the antenna and protuberances)

- The continuous talk time and continuous standby time are the average values of when the signals can be received normally while the telephone is in the standstill status.

The operation time may be reduced to almost half due to charging conditions, temperature, and other operation environment conditions, signal condition at the location of use, function setting, etc.