



TEST REPORT

Report Number : A-007-17-C

Date of Issue: 5 March 2018

FCC Rules and Regulations Part 15 Subpart E Unlicensed NII devices.

This test report is to certify that the device was tested according to the requirements of the above. The results of this report should not be construed to imply compliance of devices other than the sample tested. Without the laboratory approval by the documents, this report should not be copied in part.

1. Applicant

Company Name : Funai Electric Co., Ltd.
Mailing Address : 7-1, 7-chome, Nakagaito, Daito, Osaka 574-0013, Japan

2. Identification of Tested Device

Type of Device : Transmitter
FCC ID : ADTU9W33
Device Name : WiFi Module
Model Number : U9W33
Serial Number : T377100003
Trade Name : FUNAI
Type of Test : Production Pre-production Prototype

3. Test Items

AC Power Line Conducted Emission	<input checked="" type="checkbox"/> Pass	<input type="checkbox"/> Fail	<input type="checkbox"/> N/A
Emission Bandwidth	<input checked="" type="checkbox"/> Pass	<input type="checkbox"/> Fail	<input type="checkbox"/> N/A
Maximum Conducted Output Power	<input checked="" type="checkbox"/> Pass	<input type="checkbox"/> Fail	<input type="checkbox"/> N/A
Peak Power Spectral Density	<input checked="" type="checkbox"/> Pass	<input type="checkbox"/> Fail	<input type="checkbox"/> N/A
Spurious Emission	<input checked="" type="checkbox"/> Pass	<input type="checkbox"/> Fail	<input type="checkbox"/> N/A
Frequency Stability	<input checked="" type="checkbox"/> Pass	<input type="checkbox"/> Fail	<input type="checkbox"/> N/A
U-NII Detection Bandwidth	<input type="checkbox"/> Pass	<input type="checkbox"/> Fail	<input checked="" type="checkbox"/> N/A (*1)
Channel Availability Check Time	<input type="checkbox"/> Pass	<input type="checkbox"/> Fail	<input checked="" type="checkbox"/> N/A (*1)
Channel Closing Transmission Time	<input type="checkbox"/> Pass	<input type="checkbox"/> Fail	<input checked="" type="checkbox"/> N/A (*1)
Channel Move Time	<input type="checkbox"/> Pass	<input type="checkbox"/> Fail	<input checked="" type="checkbox"/> N/A (*1)
Non-Occupancy Period	<input type="checkbox"/> Pass	<input type="checkbox"/> Fail	<input checked="" type="checkbox"/> N/A (*1)
Statistical Performance Check	<input type="checkbox"/> Pass	<input type="checkbox"/> Fail	<input checked="" type="checkbox"/> N/A (*1)

Refer the below reason(s) with respect to the decision and justification not to test.
(*1) EUT Specifications (*2) Request of Applicant (*3) According to Test Plan

KEC Electronic Industry Development Center Testing Division
3-2-2, Hikari-dai, Seika-cho, Soraku-gun, Kyoto 619-0237 Japan

Test Engineer(s)

Naoki Norimoto



Approved by Ikuya Minematsu / Group Manager



Table of Contents

1. REVISION HISTORY 3

2. LABORATORY INFORMATION 4

 2.1. Laboratory Accreditation 4

 2.2. Test Facility 4

 2.3. Measurement Uncertainty 4

3. GENERAL INFORMATION 5

 3.1. Product Description 5

4. TESTED SYSTEM 8

 4.1. Reference Rule and Specification 8

 4.2. Date of Test 8

 4.3. Deviation of Standard 8

 4.4. Test Mode 9

 4.5. Block Diagram of TEST System 10

 4.6. List of Test System 10

 4.7. List of Cables 10

5. AC POWER LINE CONDUCTED EMISSION MEASUREMENT 11

 5.1. Test Procedure 11

 5.2. Test Software List 11

 5.3. Test Results 12

6. EMISSION BANDWIDTH 14

 6.1. Test Procedure 14

 6.2. Test Results of 26dB Emission Bandwidth 15

 6.3. Test Results of 6dB Emission Bandwidth 22

7. MAXIMUM PEAK OUTPUT POWER 27

 7.1. Test Procedure 27

 7.2. Test Results 27

8. POWER SPECTRAL DENSITY 34

 8.1. Test Procedure 34

 8.2. Test Results 35

9. SPURIOUS EMISSION 51

 9.1. Test Procedure 51

 9.2. Test Software List 51

 9.3. Test Results 52

10.FREQUENCY STABILITY 88

 10.1. Test Procedure 88

 10.2. Test Results 89

11.TEST EQUIPMENT 92

APPENDIX A (DECLARATION OF COMPLIANCE TO MAXIMUM PERMISSIBLE EXPOSURE LIMITS FOR HUMANS) 94

APPENDIX B Photographs of EUT System Configuration 95



1. REVISION HISTORY

Report Version	Page	Description	Date of Issue	Status
A	-	Initial issue of report	14 December 2017	VOID
B	63	Clerical error	14 December 2017	VOID
C	76	Clerical error	5 March 2018	

Note: The previous version listed above as “VOID” is invalid.



2. LABORATORY INFORMATION

2.1. Laboratory Accreditation

The KEC has been accredited by the following organizations based on their criteria for testing laboratory (ISO/IEC 17025).

(1) Voluntary EMC Laboratory Accreditation Center Inc. (VLAC) : Accreditation Number: VLAC-005

2.2. Test Facility

All tests described in this report were performed by:

Name: KEC Electronic Industry Development Center
Testing Division

Address: 3-2-2, Hikari-dai, Seika-cho, Soraku-gun, Kyoto 619-0237 Japan

Anechoic Chamber : No.1 No.2 No.3 No.6 No.7 No.8
 No.9 No.10 No.11 No.12 No.13 No.14
 Shielded Room : No.1 No.7 No.8 No.9 No.10
 Harmonic Current Meas. Room:

2.3. Measurement Uncertainty

The result of a measurement is only an approximation or estimate of the value of a specific quantity. And thus the measurand is complete only when a statement of uncertainty is given.

KEC quotes Measurement Uncertainty (U) as follows.

Frequency Range Measurement (Frequency Band measurement)	+/- 3.0 %
Time Base Measurement (Hopping dwell time)	+/- 2. 4%
Carrier Frequency Measurement (Frequency measurement) EN300 328, EM301 893, FCC Part 15 C	+/- 2.0×10 ⁻⁷
Carrier Frequency Measurement (Frequency measurement) EN300 330	+/- 1.5×10 ⁻⁷
Power Density Measurement (Spectrum Analyzer Method)	+/- 0.6 dB
RF Output Power (e.i.r.p) Measurement (Power Meter Method)	+/- 1.1 dB
Conducted Spurious Measurement (9kHz–26.5GHz)	+/- 0.9 dB
Conducted Spurious Measurement (26.5GHz–40GHz)	+/- 1.2 dB
Effective Radiated Power Measurement (30–200MHz)	+/- 3.9 dB
Effective Radiated Power Measurement (200–1000MHz)	+/- 3.9 dB
Effective Radiated Power Measurement (1–12.75GHz)	+/- 4.2 dB
Effective Radiated Power Measurement (12.75–18.0GHz)	+/- 4.7 dB
Effective Radiated Power Measurement (18.0–40.0GHz)	+/- 4.6 dB
Temperature control on thermostatic chamber test	+/- 1.4 °C

Expiration Date : 2018/9/30

The above values are calculated as Expanded Uncertainty (k=2 [Approximately 95%]).

[Note]

If the measured result is below the specification limit and a margin is less than the above measurement uncertainty, it is impossible to determine compliance at a level of confidence of approximately 95%. However, the measured result indicates high probability that the tested device complies with the specification limit.



3. GENERAL INFORMATION

3.1. Product Description

(1) Technical Specifications

(a) Wireless-LAN 2.4GHz

Type of Radio	IEEE802.11b IEEE802.11g IEEE802.11n HT20, HT40
Frequency of Operation	IEEE802.11b: 2412MHz - 2462MHz IEEE802.11g: 2412MHz - 2462MHz IEEE802.11n HT20: 2412MHz - 2462MHz IEEE802.11n HT40: 2422MHz - 2452MHz
Output Power	IEEE802.11b: 15dBm IEEE802.11g: 12dBm IEEE802.11n HT20: 13dBm IEEE802.11n HT40: 11dBm
Antenna Gain	Ant A: 1.08 dBi max Ant B: 2.08 dBi max
Antenna Type	1/4 lambda monopole antenna
Antenna Impedance	50ohm
Modulation / Spreading	DSSS, OFDM
Type of Modulation	IEEE802.11b(DSSS): BPSK, QPSK, CCK IEEE802.11g/n(OFDM): BPSK, QPSK, 16QAM, 64QAM
Nominal Bandwidth	20MHz, 40MHz
Transmit Chains	IEEE802.11b/g: 1 IEEE802.11n: 2

[Note]

11b/g : used only Ant A

11n : used only MIMO



(b) Wireless-LAN 5GHz

Type of Radio	IEEE802.11a IEEE802.11n HT20, HT40 IEEE802.11ac HT20, HT40, HT 80	
Frequency of Operation	IEEE802. 11a / IEEE802.11n HT20 / IEEE802.11ac HT20	5180MHz - 5240MHz, 5745MHz - 5825MHz
	IEEE802. 11n HT40 / IEEE802.11ac HT40	5190MHz - 5230MHz, 5755MHz - 5795MHz
	IEEE802. 11ac HT80	5210MHz, 5775MHz
Output Power	IEEE802.11a: 14dBm IEEE 802.11n/ac HT20: 13dBm IEEE 802.11n/ac HT40: 13dBm IEEE 802.11ac HT80: 11dBm	
Antenna Gain	Ant A: -1.73 dBi max Ant B: -0.68 dBi max	
Antenna Type	1/4 lambda monopole antenna	
Antenna Impedance	50ohm	
Modulation	OFDM	
Type of Modulation	IEEE 802.11a/n/ac(OFDM): BPSK, QPSK, 16QAM, 64QAM, 256QAM	
Nominal Bandwidth	20MHz, 40MHz, 80MHz	
Transmit Chains	IEEE 802.11a:1 IEEE 802.11n/ac:2	
DFS Related Operating Mode	Client without radar detection	

[Note]

11a : used only Ant A

11n/ac : used only MIMO



- (2) Maximum Oscillators Frequency
- Maximum local frequency : 3883.33MHz
 - Maximum generation frequency : 5825MHz
- (3) Software Version
- MT7662UQA.exe : Ver. 1.0.3.24
 - MT62UQ.sys (USB Driver) : v1.0.7.8
- (4) Firmware Version : None
- (5) Interface and Provide Terminal
- USB : USB 2.0 (voltage: 3.3V)
 - WiFi RF Antenna connector for TEST : MHF type (50 ohm)
- (6) Rated Power Supply : DC 3.3V \pm 5%
(Test for AC 120V,60Hz (AC Adapter supply))
- (7) Power Setting
- IEEE802.11b (2.4GHz) : 15 dBm
 - IEEE802.11g (2.4GHz) : 12 dBm
 - IEEE802.11n HT20 (2.4GHz) : 13 dBm
 - IEEE802.11n HT40 (2.4GHz) : 11 dBm
 - IEEE802.11a (5GHz) : 14 dBm
 - IEEE802.11n/ac HT20 (5GHz) : 13 dBm
 - IEEE802.11n/ac HT40 (5GHz) : 13 dBm
 - IEEE802.11ac HT80 (5GHz) : 11 dBm
- (8) Antenna Type : Integral Antenna (undetachable)
- (9) Operating Temperature : 0 deg C to 60 deg C



4. TESTED SYSTEM

4.1. Reference Rule and Specification

(1) Reference Rule and Regulation	: FCC Rule Part 15 Subpart E, Unlicensed National Information Infrastructure Devices
	<input checked="" type="checkbox"/> Section 15.205
	<input checked="" type="checkbox"/> Section 15.207
	<input checked="" type="checkbox"/> Section 15.209
	<input checked="" type="checkbox"/> Section 15.407 (a)(1)
	<input type="checkbox"/> Section 15.407 (a)(2)
	<input checked="" type="checkbox"/> Section 15.407 (a)(3)
	<input checked="" type="checkbox"/> Section 15.407 (b)(1)
	<input type="checkbox"/> Section 15.407 (b)(2)
	<input type="checkbox"/> Section 15.407 (b)(3)
	<input checked="" type="checkbox"/> Section 15.407 (b)(4)
	<input checked="" type="checkbox"/> Section 15.407 (e)
	<input checked="" type="checkbox"/> Section 15.407 (g)
	<input type="checkbox"/> Section 15.407 (h)(1)
	<input type="checkbox"/> Section 15.407 (h)(2)
(2) Test Procedure	: ANSI C63.10-2013 KDB Publication No.789033 D02 General UNII Test Procedures New Rules v02

4.2. Date of Test

Receipt of Test Sample : 12 October 2017

Condition of Test Sample : Damage is not found on the set.
 Damage is found on the set. (Details are described in this report)

Test Completed on : 29 November 2017

Condition of Test Sample : Damage is not found on the set.
 Damage is found on the set. (Details are described in this report)

4.3. Deviation of Standard

without deviation, with deviation (details are found inside of this report)



4.4. Test Mode

Test Item	Operating Mode	Test Frequency
AC Power Line Conducted Emission (*1)	11n-HT40	5755MHz
6dB, 26dB Emission Bandwidth	11a/11n-HT20/11ac-HT20	5180MHz / 5220MHz / 5240MHz 5745MHz / 5785MHz / 5825MHz
	11n-HT40/11ac-HT40	5190MHz / 5230MHz 5755MHz / 5795MHz
	11ac-HT80	5210MHz / 5775MHz
Maximum Conducted Output Power	11a/11n-HT20/11ac-HT20	5180MHz / 5220MHz / 5240MHz 5745MHz / 5785MHz / 5825MHz
	11n-HT40/11ac-HT40	5190MHz / 5230MHz 5755MHz / 5795MHz
	11ac-HT80	5210MHz / 5775MHz
Peak Power Spectral Density	11a/11n-HT20/11ac-HT20	5180MHz / 5220MHz / 5240MHz 5745MHz / 5785MHz / 5825MHz
	11n-HT40/11ac-HT40	5190MHz / 5230MHz 5755MHz / 5795MHz
	11ac-HT80	5210MHz / 5775MHz
Spurious Emissions / Restricted Band Edges (Radiated / Conducted) (*1)	11a/11n-HT20/11ac-HT20	5180MHz / 5220MHz / 5240MHz 5745MHz / 5785MHz / 5825MHz
	11n-HT40/11ac-HT40	5190MHz / 5230MHz 5755MHz / 5795MHz
	11ac-HT80	5210MHz / 5775MHz
Frequency Stability	11a/11n-HT20/11ac-HT20	5180MHz / 5220MHz / 5240MHz 5745MHz / 5785MHz / 5825MHz
	11n-HT40/11ac-HT40	5190MHz / 5230MHz 5755MHz / 5795MHz
	11ac-HT80	5210MHz / 5775MHz

Worst Data Rate/MCS		
Operating Mode	Data Rate/MCS	Worst Data Rate/MCS
11a ANT A	6-54 Mbps	18 Mbps
11n-HT20 MIMO	MCS 8-15	MCS 11
11n-HT40 MIMO	MCS 8-15	MCS 8
11ac-HT20 MIMO	MCS 0-8	MCS 1
11ac-HT40 MIMO	MCS 0-9	MCS 5
11ac-HT80 MIMO	MCS 0-9	MCS 2

[Note]

- (1) The test program was prepared by the applicant.
 - (2) The power setting was determined by the applicant. (See page 7)
 - (3) The spurious emissions data of the each modes were checked in three orthogonal axes, and the data of the producing the maximum emissions were reported at each frequency.
 - (4) AC Power Line Conducted Emission and Spurious Emissions of 30MHz to 1000MHz performed in worst mode of Maximum Conducted Output Power.
- (*1) Radiated measurement : above 30MHz, Conducted measurement : below 30MHz

4.5. Block Diagram of TEST System

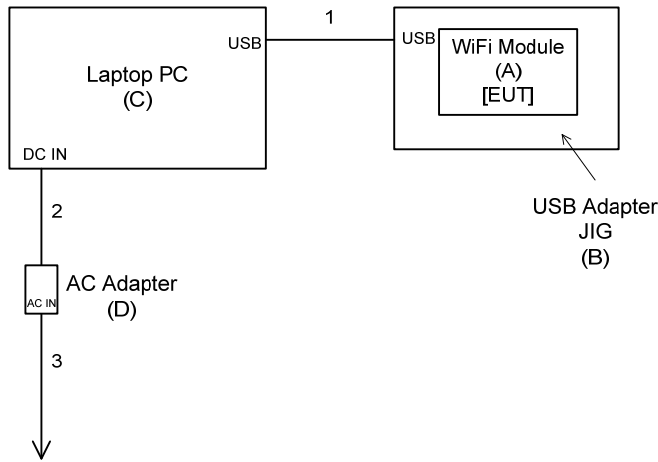

to AC 120V, 60Hz

4.6. List of Test System

No.	Device Name	Model Number	Serial Number	Trade Name	Note
A	WiFi Module	U9W33	T377100003	FUNAI	EUT
B	USB Adapter JIG	U9W30XT/U9W40XT-2L	-	-	
C	Laptop PC	CF-19DC1AXS	7GKSA56169	Panasonic	
D	AC Adapter	CF-AA1632A M1	1632AM107508920C	Panasonic	

[Note]

(1) Option of EUT

4.7. List of Cables

No.	Cable Name	Shielded (Y/N)	Length (m)	Note
1	USB Cable	Y	1.0	
2	DC Power Cord	N	1.3	with one ferrite core(1-turn) (1)
3	AC Power Cord	N	0.8	(4)

[Note]

- (1) Undetachable cable type
- (2) Accessories cable of EUT
- (3) 3-wires type, earth plug is grounded.
- (4) 2-wires type

5. AC POWER LINE CONDUCTED EMISSION MEASUREMENT

5.1. Test Procedure

- (1) The EUT is placed in accordance with ANSI C63.10.
- (2) The EUT is activated as to simulate a worst data rate.
- (3) Connect the EUT's AC power cord to one Line Impedance Stabilization Network (LISN).
- (4) Any other power cord of other equipment is connected to a LISN different from the LISN used for the EUT.
- (5) Connect the spectrum analyzer (*1) to the measuring port of the LISN for the EUT, using a calibrated coaxial cable.
- (6) To find out the maximum emission of the configuration of the EUT System, the operation mode and the position of the cables are changed, then preliminary conducted measurement are performed.
- (7) The spectrums are scanned from 150kHz to 30MHz and collect the six highest emissions minimum on the spectrum analyzer relative to the limits in the whole range.
- (8) The test receiver (*2) is connected to the LISN for the EUT, and the six highest emissions minimum recorded above are measured.

[Note]

(*1) Spectrum Analyzer Set Up Conditions

Frequency range	: 150kHz – 30MHz
Resolution bandwidth	: 10kHz (6dB Bandwidth)
Video bandwidth	: 1MHz
Detector	: Peak

(*2) Test Receiver Set Up Conditions

Detector function	: Quasi – Peak / Average (if necessary)
IF bandwidth	: 10kHz (6dB Bandwidth)

5.2. Test Software List

KEC No.	Software Name	Version	Manufacture
TF-088	TEPTO Conducted emission automatic measurement	2.6.0164	TSJ
TF-110	Junction sheet	1.6J	KEC



5.3. Test Results

11n-HT40 5755MHz

Measured Frequency (MHz)	Correction Factor (dB)	Meter Reading				Maximum RF Voltage		Limit		Margin for Limit	
		Q-Peak		Average		Q-Peak (dBµV)	Average (dBµV)	Q-Peak (dBµV)	Average (dBµV)	Q-Peak (dB)	Average (dB)
		Va (dBµV)	Vb (dBµV)	Va (dBµV)	Vb (dBµV)						
0.150	10.4	39.1	39.3	9.7	9.9	49.7	20.3	66.0	56.0	16.3	35.7
0.185	10.4	37.6	38.4	22.7	24.0	48.8	34.4	64.3	54.3	15.5	19.9
0.249	10.3	29.5	30.6	16.3	17.9	40.9	28.2	61.8	51.8	20.9	23.6
0.311	10.3	24.7	25.5	12.8	13.5	35.8	23.8	59.9	49.9	24.1	26.1
0.559	10.3	17.8	20.2	13.0	16.0	30.5	26.3	56.0	46.0	25.5	19.7
3.239	10.4	18.0	19.0	13.2	13.6	29.4	24.0	56.0	46.0	26.6	22.0
6.484	10.6	19.4	19.5	8.5	10.5	30.1	21.1	60.0	50.0	29.9	28.9

[Note]
 (1) Correction Factor includes the LISN Factor, cable loss and attenuator loss.
 (2) The EUT is powered by the PC via the USB. Therefore AC Power Line Conducted Emission measured on the PC Power Line.

[Calculation method]
 Maximum RF Voltage (dBµV)
 = Meter Reading (at maximum level of Va or Vb) (dBµV) + Correction Factor (dB)

At the next page, the result of exploratory conducted emission measurement by using the spectrum analyzer is shown by the spectrum chart.

Tested Date	Environment	
	Temperature	Humidity
20 November 2017	24 °C	30 %



Test Results in Graph

11n-HT40 5755MHz

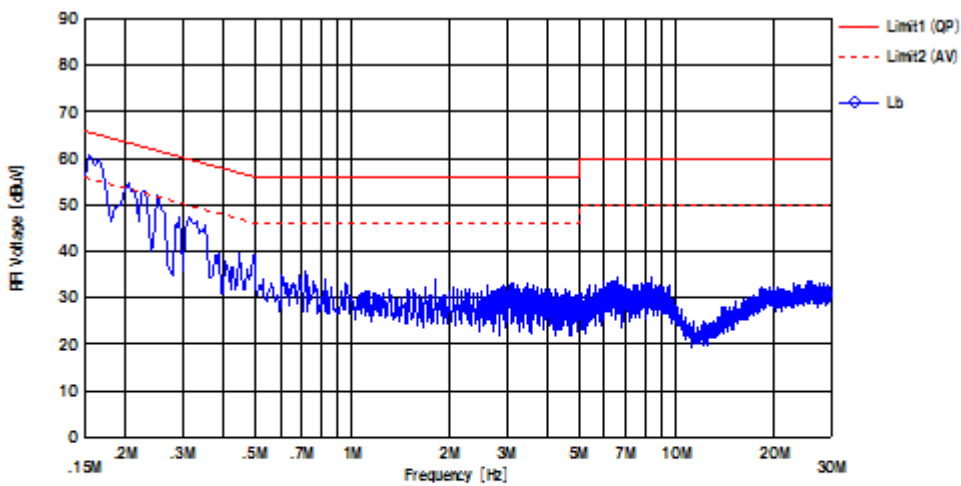
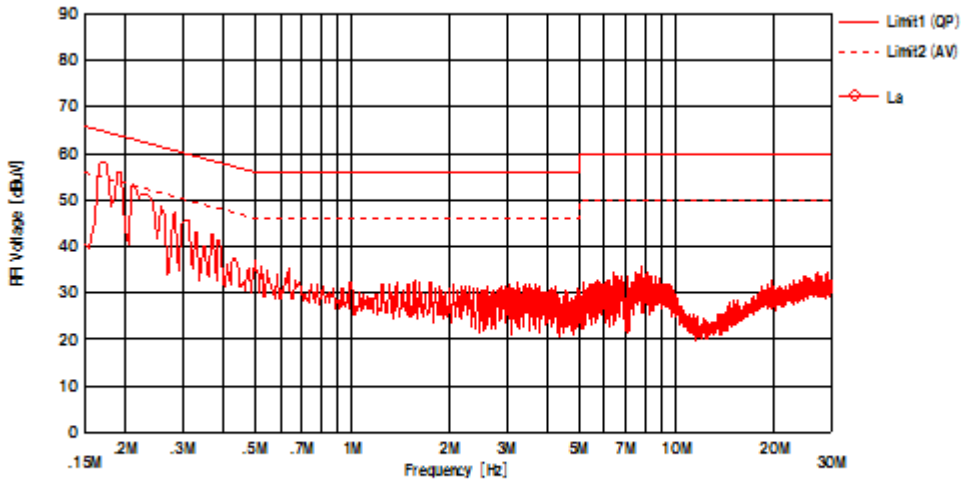



6. EMISSION BANDWIDTH

6.1. Test Procedure

- (1) Connect the EUT RF output port to spectrum analyzer (*1) via calibrated coaxial cable and suitable attenuator (if necessary).
- (2) Activates the EUT System and execute the software prepared for test, if necessary.
- (3) To find out the worst condition, the transmitting data rate of EUT is changed.
- (4) 26dB and 6dB Bandwidth is measured using the function of spectrum analyzer.

[Note]

(*1) Spectrum Analyzer Set Up Conditions (26dB Bandwidth)

Resolution bandwidth : approximately 1% of the emission bandwidth
Video bandwidth : >RBW
Detector function : Peak
x dB : -26dB

Spectrum Analyzer Set Up Conditions (6dB Bandwidth)

Resolution bandwidth : 100kHz
Video bandwidth : $\geq 3 \times \text{RBW}$
Detector function : Peak
x dB : -6dB



6.2. Test Results of 26dB Emission Bandwidth

11a

Measured Frequency (MHz)	26dB Bandwidth (MHz)	99% OBW Bandwidth (MHz)
5180	19.10	16.45
5220	19.46	16.50
5240	19.53	16.50
5745	19.44	16.53
5785	19.14	16.48
5825	18.95	16.47

11n-HT20

Measured Frequency (MHz)	26dB Bandwidth (MHz)	99% OBW Bandwidth (MHz)
5180	19.67	17.58
5220	19.61	17.61
5240	19.78	17.58
5745	19.53	17.60
5785	19.87	17.61
5825	19.67	17.63

11n-HT40

Measured Frequency (MHz)	26dB Bandwidth (MHz)	99% OBW Bandwidth (MHz)
5190	40.11	36.03
5230	40.19	36.07
5755	40.32	36.03
5795	40.33	36.07



11ac-HT20

Measured Frequency (MHz)	26dB Bandwidth (MHz)	99% OBW Bandwidth (MHz)
5180	19.61	17.53
5220	19.77	17.58
5240	19.66	17.55
5745	19.66	17.57
5785	19.84	17.61
5825	19.85	17.61

11ac-HT40

Measured Frequency (MHz)	26dB Bandwidth (MHz)	99% OBW Bandwidth (MHz)
5190	39.60	36.07
5230	39.62	36.14
5755	39.81	36.12
5795	40.11	36.10

11ac-HT80

Measured Frequency (MHz)	26dB Bandwidth (MHz)	99% OBW Bandwidth (MHz)
5210	79.98	74.90
5775	80.30	75.16

[Note]

See next page figure.

Tested Date	Environment	
	Temperature	Humidity
29 November 2017	20 °C	45 %

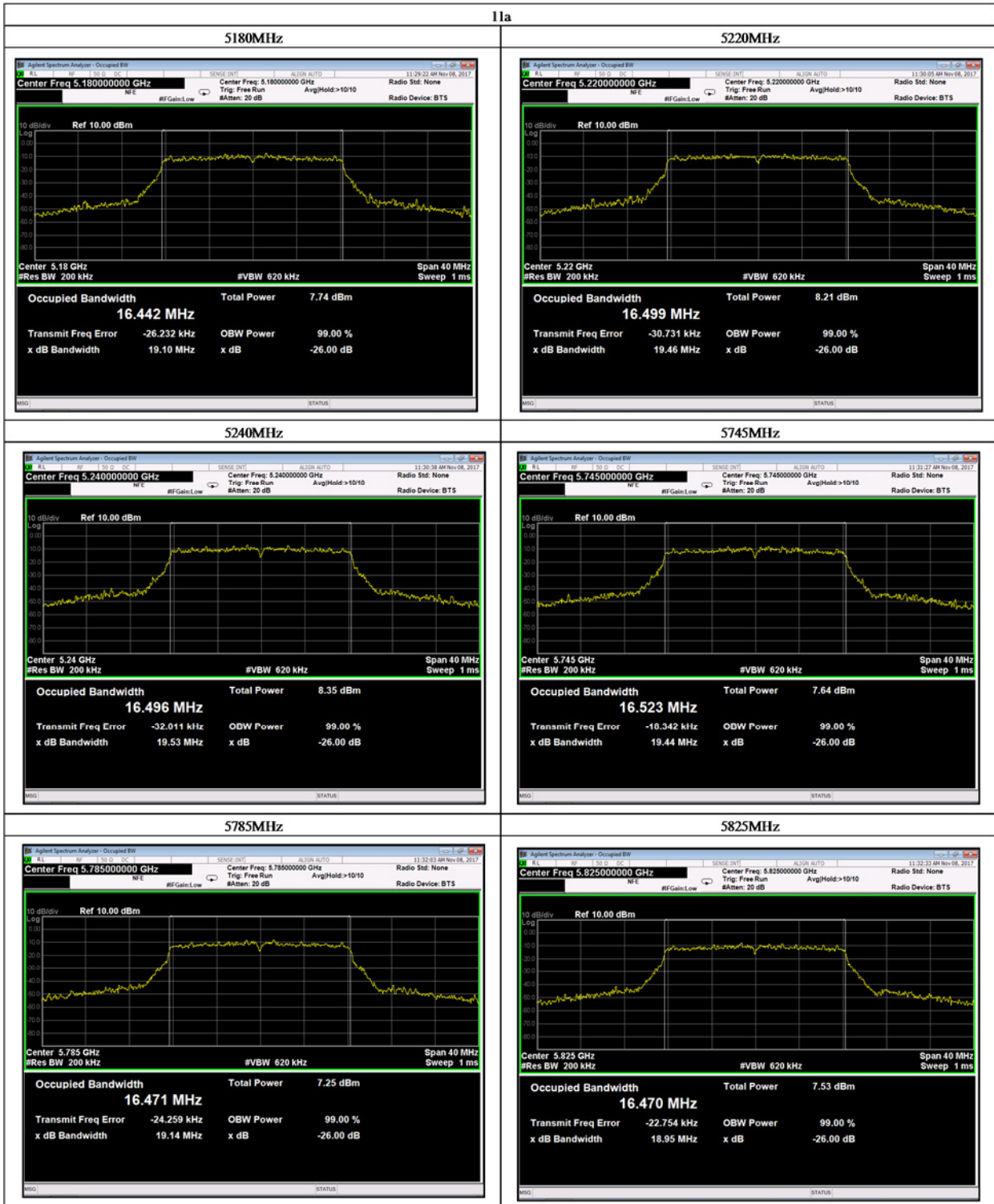



11n-HT20

5180MHz

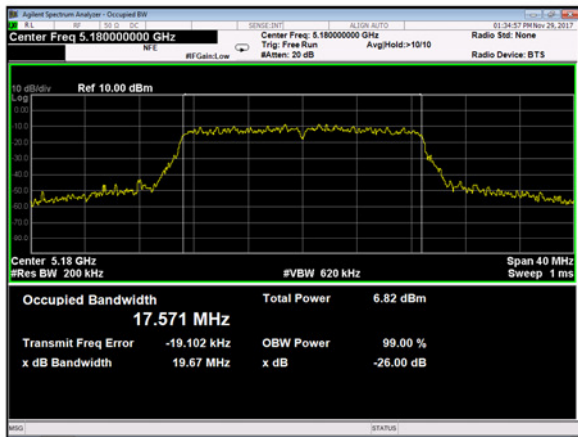

5220MHz

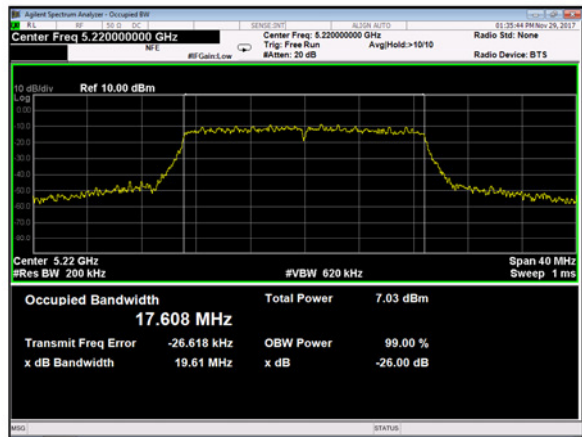

5240MHz

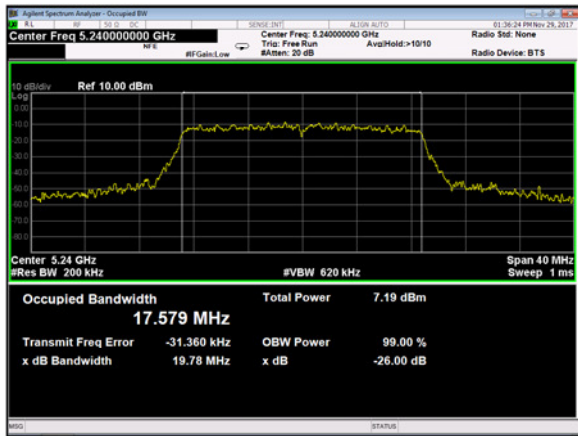

5745MHz

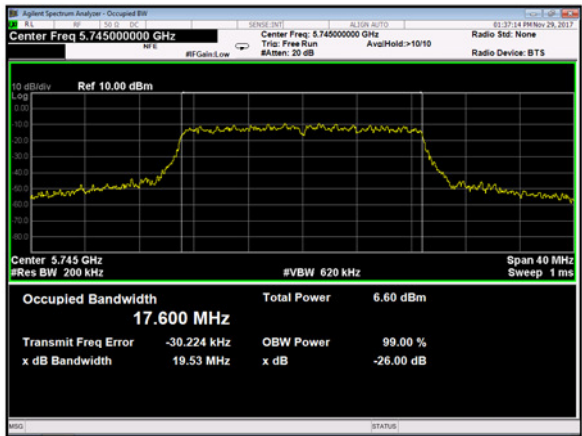

5785MHz

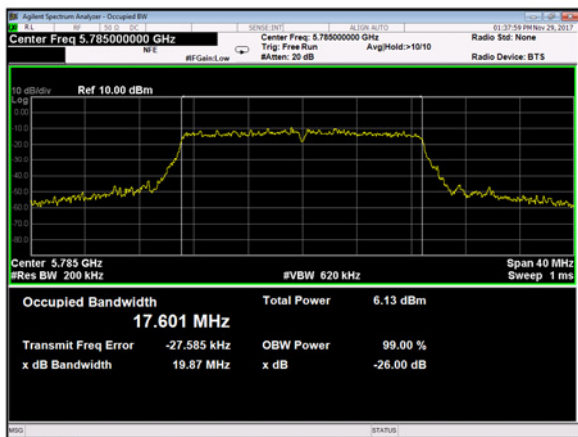

5825MHz

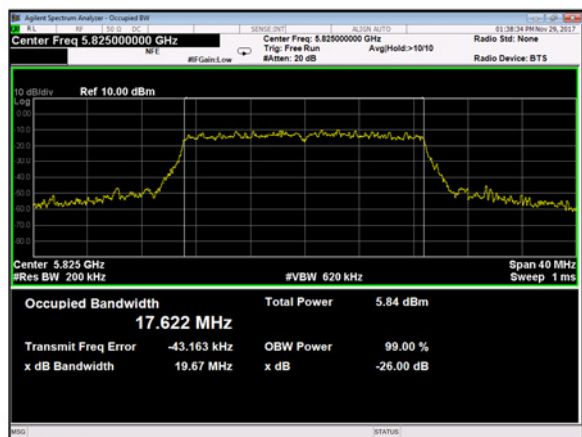

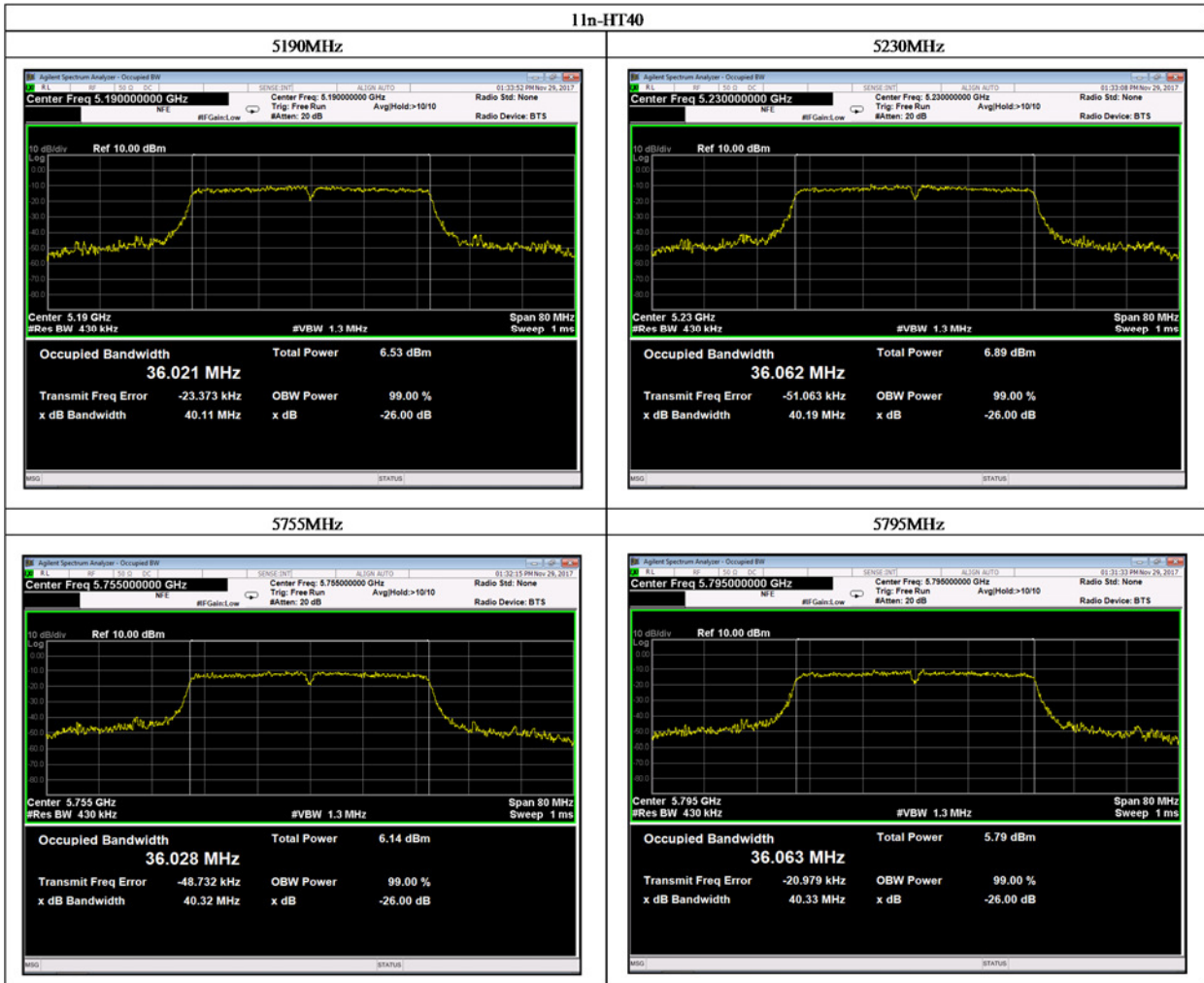

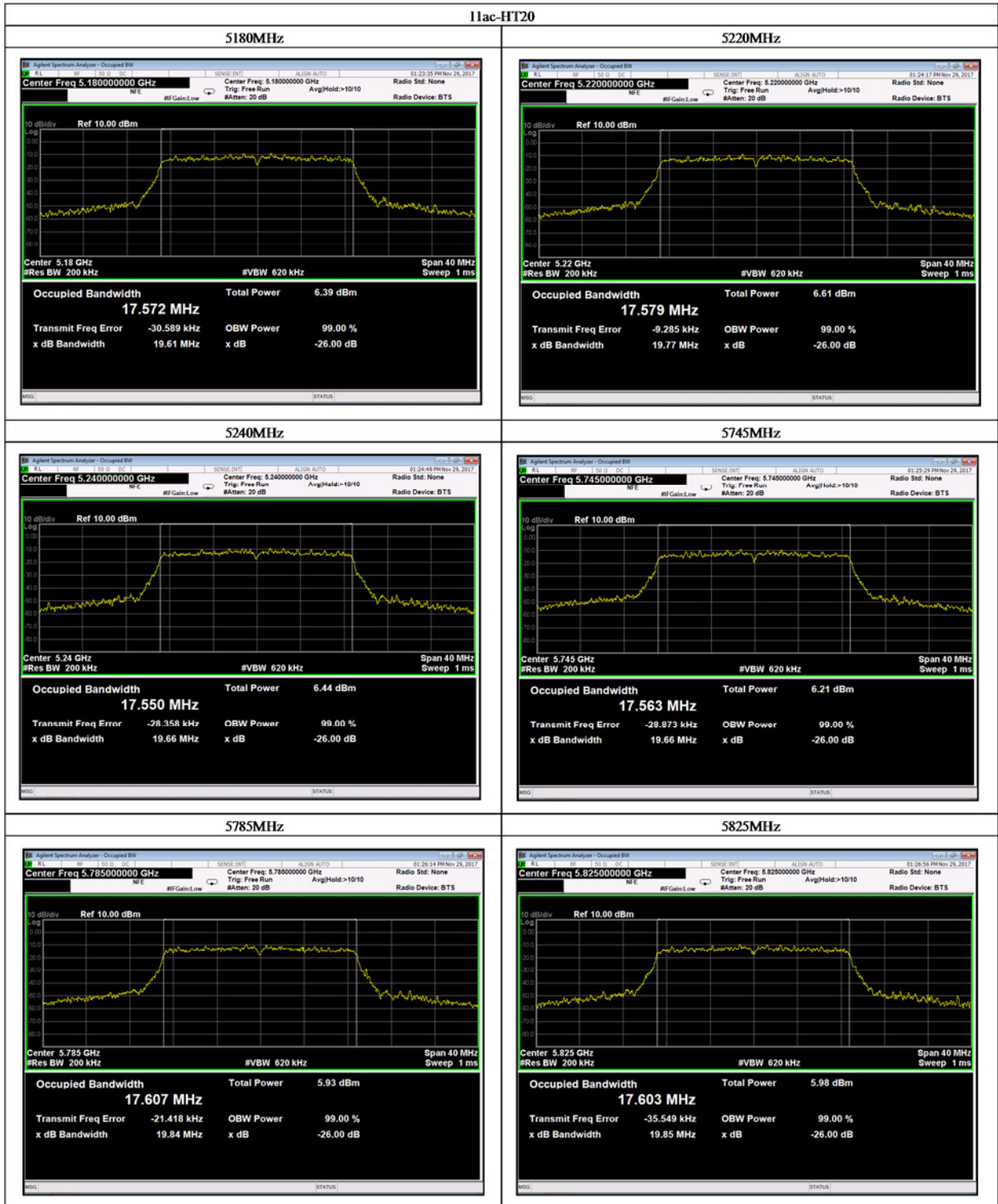



11ac-HT40

5190MHz

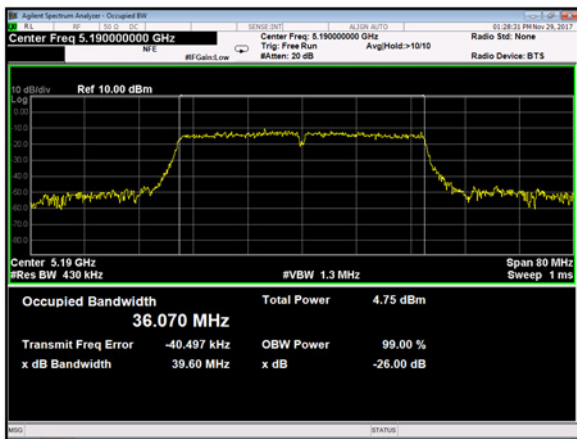

5230MHz

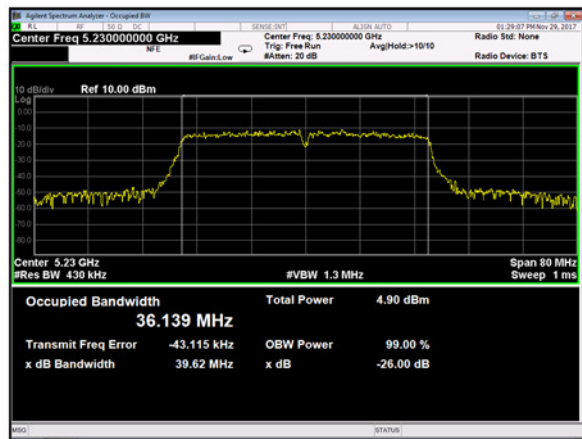

5755MHz

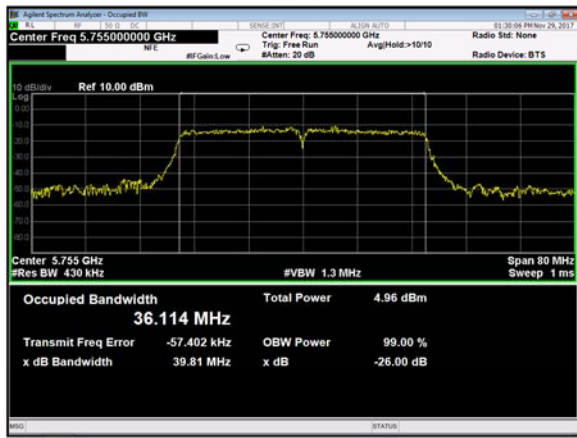

5795MHz

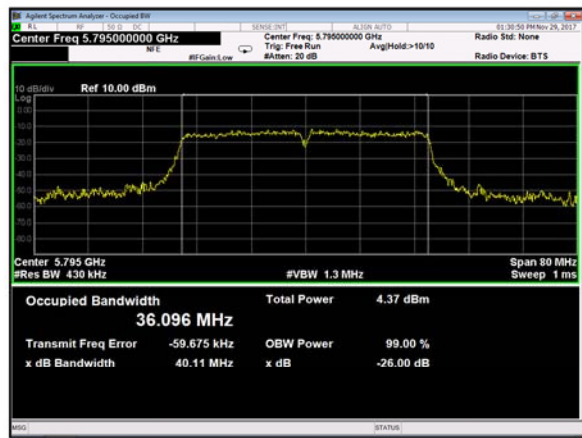

11ac-HT80

5210MHz

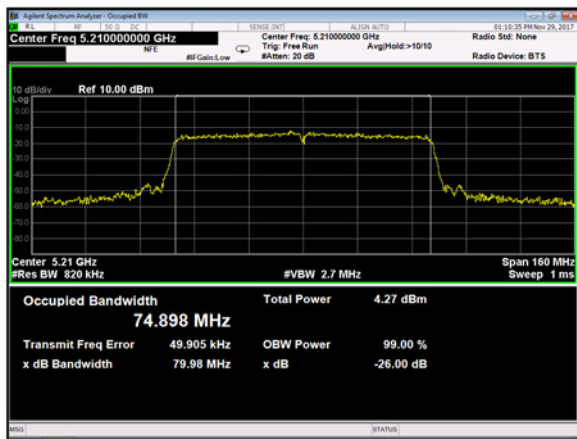

5775MHz

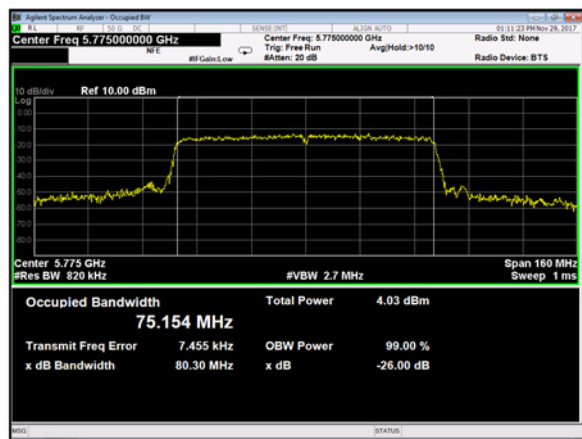

6.3. Test Results of 6dB Emission Bandwidth

11a

Measured Frequency (MHz)	6dB Bandwidth (MHz)	Limit (MHz)
5745	16.40	≥0.50
5785	15.36	≥0.50
5825	16.08	≥0.50

11n-HT20

Measured Frequency (MHz)	6dB Bandwidth (MHz)	Limit (MHz)
5745	17.24	≥0.50
5785	17.47	≥0.50
5825	17.31	≥0.50

11n-HT40

Measured Frequency (MHz)	6dB Bandwidth (MHz)	Limit (MHz)
5755	35.22	≥0.50
5795	35.22	≥0.50

11ac-HT20

Measured Frequency (MHz)	6dB Bandwidth (MHz)	Limit (MHz)
5745	16.63	≥0.50
5785	16.64	≥0.50
5825	16.90	≥0.50

11ac-HT40

Measured Frequency (MHz)	6dB Bandwidth (MHz)	Limit (MHz)
5755	35.22	≥0.50
5795	35.22	≥0.50

11ac-HT80

Measured Frequency (MHz)	6dB Bandwidth (MHz)	Limit (MHz)
5775	75.24	≥0.50

[Note]
See next page figure.

Tested Date	Environment	
	Temperature	Humidity
29 November 2017	22 °C	35 %



11a

5745MHz

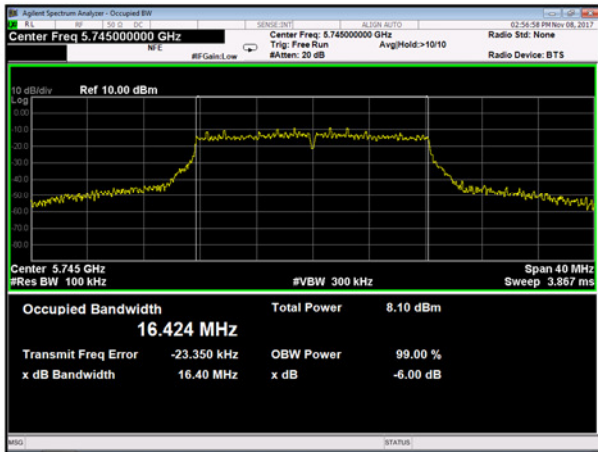

5785MHz

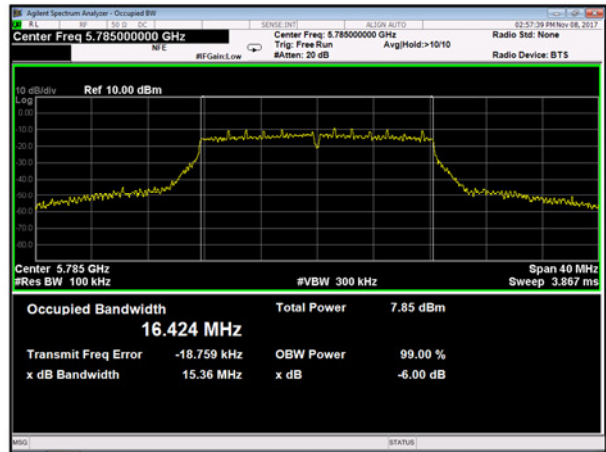

5825MHz

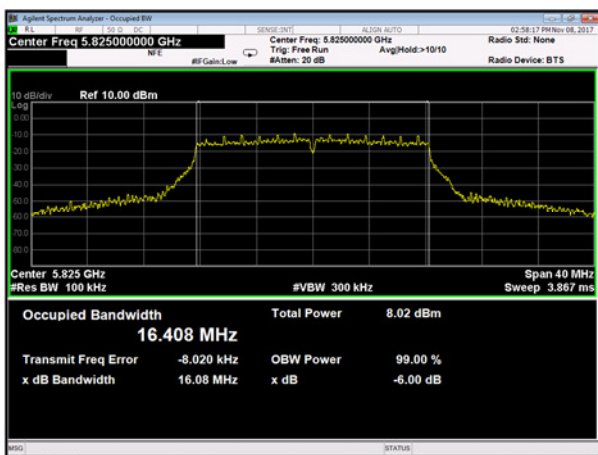



11n-HT20

5745MHz

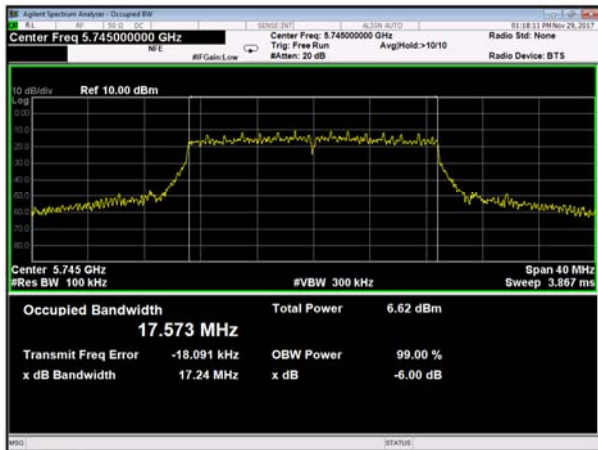

5785MHz

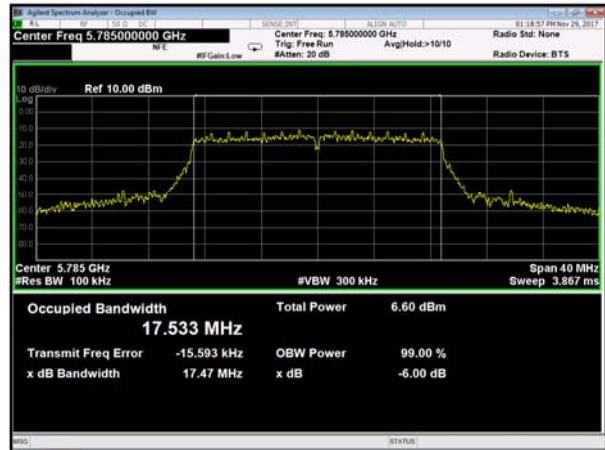

5825MHz

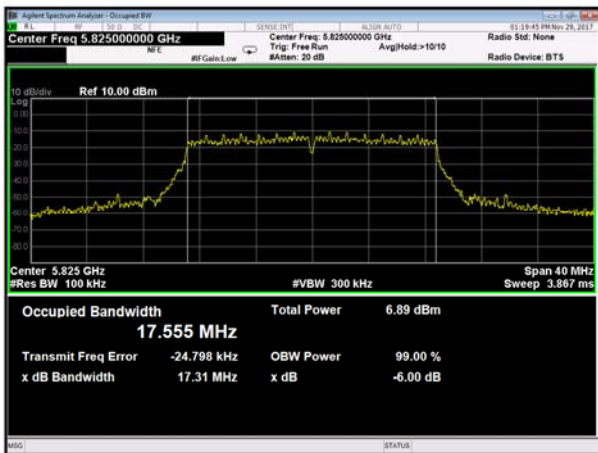



11n-HT40

5755MHz

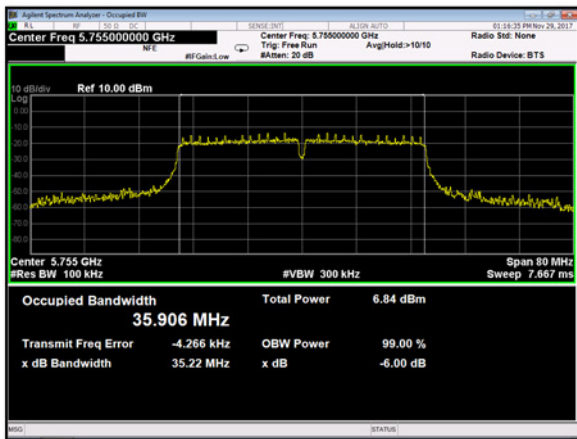

5795MHz

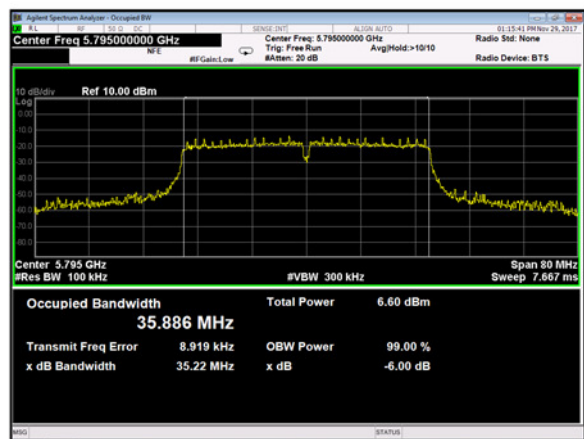

11ac-HT20

5745MHz

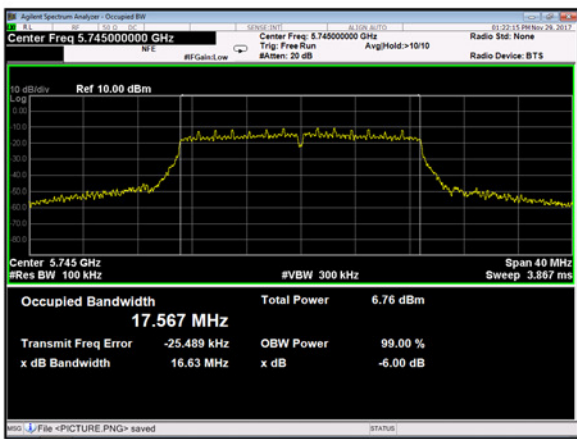

5785MHz

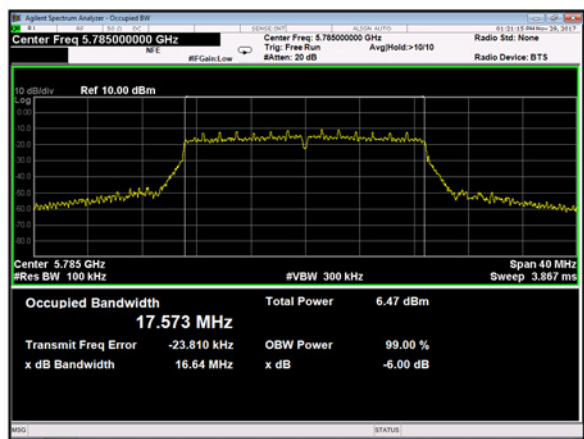

5825MHz

