



# TEST REPORT

Report Number : A-004-17-C

Date of Issue: 24 May 2018

FCC Rules and Regulations Part 15 Subpart C Intentional Radiators.

This test report is to certify that the device was tested according to the requirements of the above.  
The results of this report should not be construed to imply compliance of devices other than the sample tested.  
Without the laboratory approval by the documents, this report should not be copied in part.

## 1. Applicant

Company Name : Funai Electric Co., Ltd.  
Mailing Address : 7-1, 7-chome, Nakagaito, Daito, Osaka 574-0013, Japan

## 2. Identification of Tested Device

Type of Device : Transmitter  
FCC ID : ADTU9W31  
Device Name : WiFi Module  
Model Number : U9W31  
Serial Number : T377100001  
Trade Name : FUNAI  
Type of Test :  Production  Pre-production  Prototype

## 3. Test Items

AC Power Line Conducted Emission	<input checked="" type="checkbox"/> Pass	<input type="checkbox"/> Fail	<input type="checkbox"/> N/A
20dB Bandwidth and Carrier Frequency Separation (FHSS only)	<input type="checkbox"/> Pass	<input type="checkbox"/> Fail	<input checked="" type="checkbox"/> N/A (*1)
Time of Occupancy (Dwell Time) (FHSS only)	<input type="checkbox"/> Pass	<input type="checkbox"/> Fail	<input checked="" type="checkbox"/> N/A (*1)
Number of Hopping Frequency (FHSS only)	<input type="checkbox"/> Pass	<input type="checkbox"/> Fail	<input checked="" type="checkbox"/> N/A (*1)
6dB Bandwidth (DTS only)	<input checked="" type="checkbox"/> Pass	<input type="checkbox"/> Fail	<input type="checkbox"/> N/A
Peak Conducted Output Power	<input checked="" type="checkbox"/> Pass	<input type="checkbox"/> Fail	<input type="checkbox"/> N/A
Power Spectral Density (DTS only)	<input checked="" type="checkbox"/> Pass	<input type="checkbox"/> Fail	<input type="checkbox"/> N/A
Spurious Emission	<input checked="" type="checkbox"/> Pass	<input type="checkbox"/> Fail	<input type="checkbox"/> N/A

Refer the below reason(s) with respect to the decision and justification not to test.

(\*1) EUT Specifications (\*2) Request of Applicant (\*3) According to Test Plan

KEC Electronic Industry Development Center Testing Division  
3-2-2, Hikari-dai, Seika-cho, Soraku-gun, Kyoto 619-0237 Japan

### Test Engineer(s)



Naoki Norimoto



**VLAC**  
Lab Accreditation

VLAC-005

Approved by



Ikuya Minematsu / Group Manager



Table of Contents

**1. REVISION HISTORY .....3**

**2. LABORATORY INFORMATION .....4**

2.1. Laboratory Accreditation .....4

2.2. Test Facility .....4

2.3. Measurement Uncertainty.....4

**3. GENERAL INFORMATION .....5**

3.1. Product Description .....5

**4. TESTED SYSTEM .....8**

4.1. Reference Rule and Specification .....8

4.2. Date of Test.....8

4.3. Deviation of Standard .....8

4.4. Test Mode .....9

4.5. Block Diagram of TEST System .....10

4.6. List of Test System .....10

4.7. List of Cables.....10

**5. AC POWER LINE CONDUCTED EMISSION MEASUREMENT .....11**

5.1. Test Procedure .....11

5.2. Test Software List .....11

5.3. Test Results .....12

**6. 6dB BANDWIDTH MEASUREMENT (DTS only) .....14**

6.1. Test Procedure .....14

6.2. Test Results .....15

**7. PEAK CONDUCTED OUTPUT POWER.....18**

7.1. Test Procedure .....18

7.2. Test Results .....18

**8. POWER SPECTRAL DENSITY (DTS only) .....21**

8.1. Test Procedure .....21

8.2. Test Results .....22

**9. SPURIOUS EMISSION .....28**

9.1. Test Procedure .....28

9.2. Test Software List .....29

9.3. Test Results .....29

**10. TEST EQUIPMENT .....50**

**APPENDIX A (DECLARATION OF COMPLIANCE TO MAXIMUM PERMISSIBLE EXPOSURE LIMITS FOR HUMANS) .....52**

**APPENDIX B Photographs of EUT System Configuration .....53**



## 1. REVISION HISTORY

Report Version	Page	Description	Date of Issue	Status
A	-	Initial issue of report	19 December 2017	VOID
B	38, 40	Clerical error	11 January 2018	VOID
C	43	Clerical error	5 March 2018	VOID
D	52	Clerical error	24 May 2018	

Note: The previous version listed above as “VOID” is invalid.



## 2. LABORATORY INFORMATION

### 2.1. Laboratory Accreditation

The KEC has been accredited by the following organizations based on their criteria for testing laboratory (ISO/IEC 17025).

Voluntary EMC Laboratory Accreditation Center Inc. (VLAC) : Accreditation Number: VLAC-005

### 2.2. Test Facility

All tests described in this report were performed by:

Name: KEC Electronic Industry Development Center  
Testing Division

Address: 3-2-2, Hikari-dai, Seika-cho, Soraku-gun, Kyoto 619-0237 Japan

Anechoic Chamber :  No.1  No.2  No.3  No.6  No.7  No.8  
 No.9  No.10  No.11  No.12  No.13  No.14  
 Shielded Room :  No.1  No.7  No.8  No.9  No.10  
 Harmonic Current Meas. Room :

### 2.3. Measurement Uncertainty

The result of a measurement is only an approximation or estimate of the value of a specific quantity. And thus the measurand is complete only when a statement of uncertainty is given. KEC quotes Measurement Uncertainty (U) as follows.

Frequency Range Measurement (Frequency Band measurement)	+/- 3.0 %
Time Base Measurement (Hopping dwell time)	+/- 2.4%
Carrier Frequency Measurement (Frequency measurement) EN300 328, EM301 893, FCC Part 15 C	+/- 2.0×10 <sup>-7</sup>
Carrier Frequency Measurement (Frequency measurement) EN300 330	+/- 1.5×10 <sup>-7</sup>
Power Density Measurement (Spectrum Analyzer Method)	+/- 0.6 dB
RF Output Power (e.i.r.p) Measurement (Power Meter Method)	+/- 1.1 dB
Conducted Spurious Measurement (9kHz–26.5GHz)	+/- 0.9 dB
Conducted Spurious Measurement (26.5GHz–40GHz)	+/- 1.2 dB
Effective Radiated Power Measurement (30–200MHz)	+/- 3.9 dB
Effective Radiated Power Measurement (200–1000MHz)	+/- 3.9 dB
Effective Radiated Power Measurement (1–12.75GHz)	+/- 4.2 dB
Effective Radiated Power Measurement (12.75–18.0GHz)	+/- 4.7 dB
Effective Radiated Power Measurement (18.0–40.0GHz)	+/- 4.6 dB
Temperature control on thermostatic chamber test	+/- 1.4 °C

Expiration Date : 2018/9/30

The above values are calculated as Expanded Uncertainty (k=2 [Approximately 95%]).

#### [Note]

If the measured result is below the specification limit and a margin is less than the above measurement uncertainty, it is impossible to determine compliance at a level of confidence of approximately 95%. However, the measured result indicates high probability that the tested device complies with the specification limit.



### 3. GENERAL INFORMATION

#### 3.1. Product Description

##### (1) Technical Specifications

##### (a) Wireless-LAN 2.4GHz

Type of Radio	IEEE802.11b IEEE802.11g IEEE802.11n HT20, HT40
Frequency of Operation	IEEE802.11b: 2412MHz - 2462MHz IEEE802.11g: 2412MHz - 2462MHz IEEE802.11n HT20: 2412MHz - 2462MHz IEEE802.11n HT40: 2422MHz - 2452MHz
Output Power	IEEE802.11b: 15dBm IEEE802.11g: 15dBm IEEE802.11n HT20: 15dBm IEEE802.11n HT40: 15dBm
Antenna Gain	Ant A: 0.67 dBi max Ant B: 0.88 dBi max
Antenna Type	1/4 lambda monopole antenna
Antenna Impedance	50ohm
Modulation / Spreading	DSSS, OFDM
Type of Modulation	IEEE802.11b(DSSS): BPSK, QPSK, CCK IEEE802.11g/n(OFDM): BPSK, QPSK, 16QAM, 64QAM
Nominal Bandwidth	20MHz, 40MHz
Transmit Chains	IEEE802.11b/g: 1 IEEE802.11n: 2

[Note]

11b/g : used only Ant A

11n : used only MIMO



## (b) Wireless-LAN 5GHz

Type of Radio	IEEE802.11a IEEE802.11n HT20, HT40 IEEE802.11ac HT20, HT40, HT80	
Frequency of Operation	IEEE802.11a / IEEE802.11n HT20 / IEEE802.11ac HT20	5180MHz - 5240MHz, 5745MHz - 5825MHz
	IEEE802.11n HT40 / IEEE802.11ac HT40	5190MHz - 5230MHz, 5755MHz - 5795MHz
	IEEE802.11ac HT80	5210MHz, 5775MHz
Output Power	IEEE802.11a: 12dBm IEEE 802.11n HT20: 12dBm IEEE 802.11n HT40: 12dBm IEEE 802.11a HT20: 12dBm IEEE 802.11a HT40: 12dBm IEEE 802.11a HT80: 12dBm	
Antenna Gain	Ant A: 1.62 dBi max Ant B: 3.34 dBi max	
Antenna Type	1/4 lambda monopole antenna	
Antenna Impedance	50ohm	
Modulation	OFDM	
Type of Modulation	IEEE 802.11a/n/ac(OFDM): BPSK, QPSK, 16QAM, 64QAM, 256QAM	
Nominal Bandwidth	20MHz, 40MHz, 80MHz	
Transmit Chains	IEEE 802.11a:1 IEEE 802.11n/ac:2	
DFS Related Operating Mode	Client without radar detection	

[Note]

11a : used only Ant A

11n/ac : used only MIMO



- (2) Maximum Oscillators Frequency
- Maximum local frequency : 2462MHz
  - Maximum generation frequency : 4924MHz
- (3) Software Version
- MPTool.exe : Ver. 1.0.0.9
  - rtwlanump.sys (USB Driver) : v1014.0.1128.2011
- (4) Firmware Version : None
- (5) Interface and Provide Terminal
- USB : USB 2.0 (voltage: 3.3V)
  - WiFi RF Antenna connector for TEST : MHF type (50 ohm)
- (6) Rated Power Supply : DC 3.3V  $\pm$ 5%  
(Test for AC 120V,60Hz (AC Adapter supply))
- (7) Power Setting
- IEEE802.11b / g / n HT20 (2.4GHz) : 15 dBm
  - IEEE802.11n HT40 (2.4GHz) : 15 dBm
  - IEEE802.11a / n HT20 / ac HT20 (5GHz) : 12 dBm
  - IEEE802.11n HT40 / ac HT40 (5GHz) : 12 dBm
  - IEEE802.11ac HT80(5GHz) : 12 dBm
- (8) Antenna Type : Integral Antenna (undetachable)
- (9) Operating Temperature : 0 deg C to 60 deg C



4. TESTED SYSTEM

4.1. Reference Rule and Specification

(1) Reference Rule and Regulation	: FCC Rule Part 15 Subpart C, Section 15.247 Operation within the bands 902-928MHz, 2400-2483.5MHz, 5725-5850MHz
	<input checked="" type="checkbox"/> Section 15.205
	<input checked="" type="checkbox"/> Section 15.207
	<input checked="" type="checkbox"/> Section 15.209
	<input type="checkbox"/> Section 15.247 (a)(1)
	<input checked="" type="checkbox"/> Section 15.247 (a)(2)
	<input type="checkbox"/> Section 15.247 (b)(1)
	<input checked="" type="checkbox"/> Section 15.247 (b)(3)
	<input checked="" type="checkbox"/> Section 15.247 (d)
	<input checked="" type="checkbox"/> Section 15.247 (e)
(2) Test Procedure	: ANSI C63.10-2013 KDB Publication No.558074 D01 DTS Meas Guidance v04

4.2. Date of Test

Receipt of Test Sample : 12 October 2017  
Condition of Test Sample :  Damage is not found on the set.  
 Damage is found on the set. (Details are described in this report)

Test Completed on : 21 November 2017  
Condition of Test Sample :  Damage is not found on the set.  
 Damage is found on the set. (Details are described in this report)

4.3. Deviation of Standard

without deviation,  with deviation (details are found inside of this report)





## 4.4. Test Mode

Test Item	Operating Mode	Test Frequency
AC Power Line Conducted Emission	11n-HT40	2452MHz
6dB Bandwidth	11b/11g/11n-HT20	2412MHz / 2437MHz / 2462MHz
	11n-HT40	2422MHz / 2437MHz / 2452MHz
Peak Conducted Output Power	11b/11g/11n-HT20	2412MHz / 2437MHz / 2462MHz
	11n-HT40	2422MHz / 2437MHz / 2452MHz
Power Spectral Density	11b/11g/11n-HT20	2412MHz / 2437MHz / 2462MHz
	11n-HT40	2422MHz / 2437MHz / 2452MHz
Spurious Emissions / Restricted Band Edges (Radiated / Conducted) (*1)	11b/11g/11n-HT20	2412MHz / 2437MHz / 2462MHz
	11n-HT40	2422MHz / 2437MHz / 2452MHz

Worst Data Rate		
Operating Mode	Data Rate / MCS	Worst Data Rate
11b Ant A	1-11 Mbps	1 Mbps
11g Ant A	6-54 Mbps	18 Mbps
11n-HT20 MIMO	MCS 8-15	MCS 10
11n-HT40 MIMO	MCS 8-15	MCS 8

## [Note]

- (1) The test program was prepared by the applicant.
  - (2) The power setting was determined by the applicant. (See page 7)
  - (3) The spurious emissions data of the each modes were checked in three orthogonal axes, and the data of the producing the maximum emissions were reported at each frequency.
  - (4) AC Power Line Conducted Emission and Spurious Emissions of 30MHz to 1000MHz performed in worst mode of Peak Conducted Output Power.
- (\*1) Above 30MHz : Radiated measurement, Below 30MHz : Conducted measurement

4.5. Block Diagram of TEST System

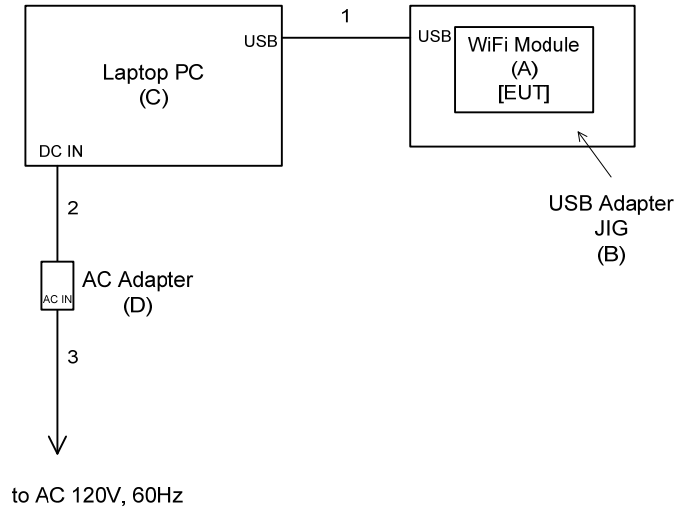

4.6. List of Test System

No.	Device Name	Model Number	Serial Number	Trade Name	Note
A	WiFi Module	U9W31	T377100001	FUNAI	EUT
B	USB Adapter JIG	U9W30XT/U9W40XT-2L	-	-	
C	Laptop PC	CF-19DC1AXS	7GKSA56169	Panasonic	
D	AC Adapter	CF-AA1632A M1	1632AM107508920C	Panasonic	

[Note]

(1) Option of EUT

4.7. List of Cables

No.	Cable Name	Shielded (Y/N)	Length (m)	Note
1	USB Cable	Y	1.0	
2	DC Power Cord	N	1.3	with one ferrite core(1-turn) (1)
3	AC Power Cord	N	0.8	(4)

[Note]

- (1) Undetachable cable type
- (2) Accessories cable of EUT
- (3) 3-wires type, earth plug is grounded.
- (4) 2-wires type



## 5. AC POWER LINE CONDUCTED EMISSION MEASUREMENT

### 5.1. Test Procedure

- (1) The EUT is placed in accordance with ANSI C63.10.
- (2) The EUT is activated as to simulate a worst data rate.
- (3) Connect the EUT's AC power cord to one Line Impedance Stabilization Network (LISN).
- (4) Any other power cord of other equipment is connected to a LISN different from the LISN used for the EUT.
- (5) Connect the spectrum analyzer (\*1) to the measuring port of the LISN for the EUT, using a calibrated coaxial cable.
- (6) To find out the maximum emission of the configuration of the EUT System, the operation mode and the position of the cables are changed, then preliminary conducted measurement are performed.
- (7) The spectrums are scanned from 150kHz to 30MHz and collect the six highest emissions minimum on the spectrum analyzer relative to the limits in the whole range.
- (8) The test receiver (\*2) is connected to the LISN for the EUT, and the six highest emissions minimum recorded above are measured.

[Note]

(\*1) Spectrum Analyzer Set Up Conditions

- Frequency range : 150kHz – 30MHz
- Resolution bandwidth : 10kHz (6dB Bandwidth)
- Video bandwidth : 1MHz
- Detector : Peak

(\*2) Test Receiver Set Up Conditions

- Detector function : Quasi – Peak / Average (if necessary)
- IF bandwidth : 10kHz (6dB Bandwidth)

### 5.2. Test Software List

KEC No.	Software Name	Version	Manufacture
TF-088	TEPTO Conducted emission automatic measurement	2.6.0164	TSJ
TF-110	Junction sheet	1.6J	KEC



## 5.3. Test Results

11n-HT40 2452MHz

Measured Frequency (MHz)	Correction Factor (dB)	Meter Reading				Maximum RF Voltage		Limit		Margin for Limit	
		Q-Peak		Average		Q-Peak (dB $\mu$ V)	Average (dB $\mu$ V)	Q-Peak (dB $\mu$ V)	Average (dB $\mu$ V)	Q-Peak (dB)	Average (dB)
		Va (dB $\mu$ V)	Vb (dB $\mu$ V)	Va (dB $\mu$ V)	Vb (dB $\mu$ V)						
0.150	10.4	39.0	38.8	9.7	9.7	49.4	20.1	66.0	56.0	16.6	35.9
0.187	10.4	41.5	42.0	26.1	26.7	52.4	37.1	64.2	54.2	11.8	17.1
0.249	10.3	33.1	33.5	19.0	20.1	43.8	30.4	61.8	51.8	18.0	21.4
0.311	10.3	26.1	27.5	14.7	15.7	37.8	26.0	59.9	49.9	22.1	23.9
0.559	10.3	18.8	20.6	13.0	16.2	30.9	26.5	56.0	46.0	25.1	19.5
3.112	10.4	19.0	21.0	15.5	16.5	31.4	26.9	56.0	46.0	24.6	19.1
6.856	10.6	17.3	19.5	11.3	12.6	30.1	23.2	60.0	50.0	29.9	26.8

[Note]

- (1) Correction Factor includes the LISN Factor, cable loss and attenuator loss.
- (2) The EUT is powered by the PC via the USB. Therefore AC Power Line Conducted Emission measured on the PC Power Line.

[Calculation method]

$$\begin{aligned} &\text{Maximum RF Voltage (dB}\mu\text{V)} \\ &= \text{Meter Reading (at maximum level of Va or Vb) (dB}\mu\text{V)} + \text{Correction Factor (dB)} \end{aligned}$$

At the next page, the result of exploratory conducted emission measurement by using the spectrum analyzer is shown by the spectrum chart.

Tested Date	Environment	
	Temperature	Humidity
20 November 2017	24 °C	30 %



Test Results in Graph

11n-HT40 2452MHz

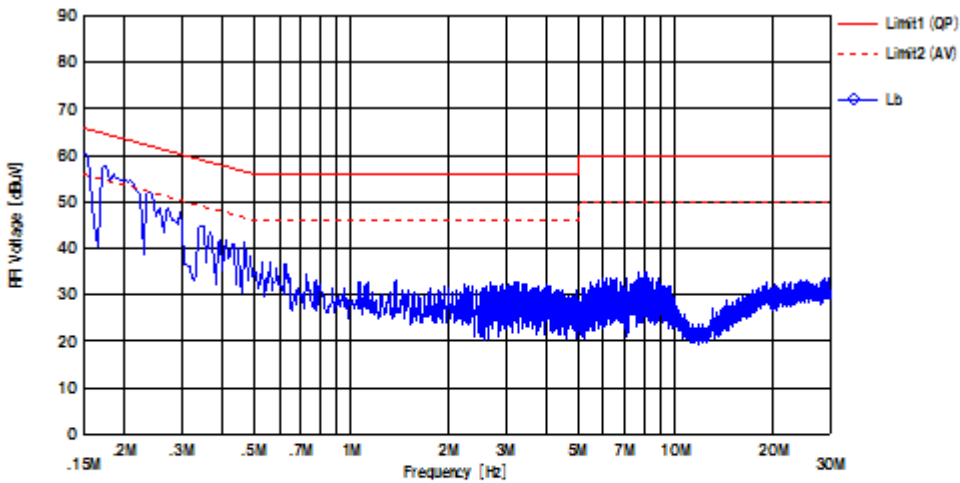
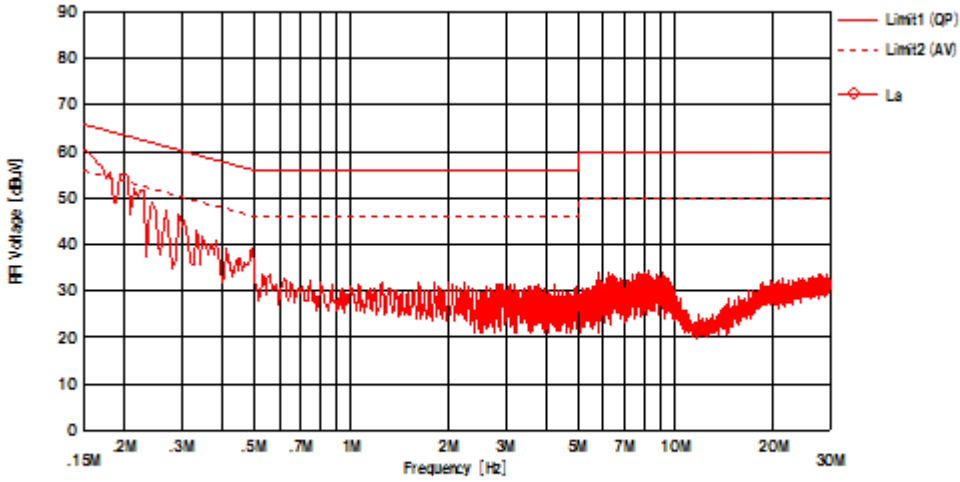



## 6. 6dB BANDWIDTH MEASUREMENT (DTS only)

### 6.1. Test Procedure

- (1) Connect the EUT RF output port to spectrum analyzer (\*1) via calibrated coaxial cable and suitable attenuator (if necessary).
- (2) Activates the EUT System and execute the software prepared for test, if necessary.
- (3) To find out the worst condition, the transmitting data rate of EUT is changed.
- (4) 6dB Bandwidth is measured using the function of spectrum analyzer.

[Note]

- (\*1) Spectrum Analyzer Set Up Conditions
- |                      |                              |
|----------------------|------------------------------|
| Resolution bandwidth | : 100kHz                     |
| Video bandwidth      | : $\geq 3 \times \text{RBW}$ |
| Detector function    | : Peak                       |
| x dB                 | : -6dB                       |



## 6.2. Test Results

11b

Measured Frequency ( MHz )	6dB Bandwidth ( MHz )	Limit (MHz )
2412	8.66	≥0.50
2437	8.66	≥0.50
2462	8.68	≥0.50

11g

Measured Frequency ( MHz )	6dB Bandwidth ( MHz )	Limit (MHz )
2412	16.49	≥0.50
2437	16.50	≥0.50
2462	16.50	≥0.50

11n-HT20

Measured Frequency ( MHz )	6dB Bandwidth ( MHz )	Limit (MHz )
2412	17.70	≥0.50
2437	17.72	≥0.50
2462	17.72	≥0.50

11n-HT40

Measured Frequency ( MHz )	6dB Bandwidth ( MHz )	Limit (MHz )
2422	36.37	≥0.50
2437	36.48	≥0.50
2452	36.47	≥0.50

[Note]

See next page figure.

Tested Date	Environment	
	Temperature	Humidity
20 October 2017	23 °C	30 %

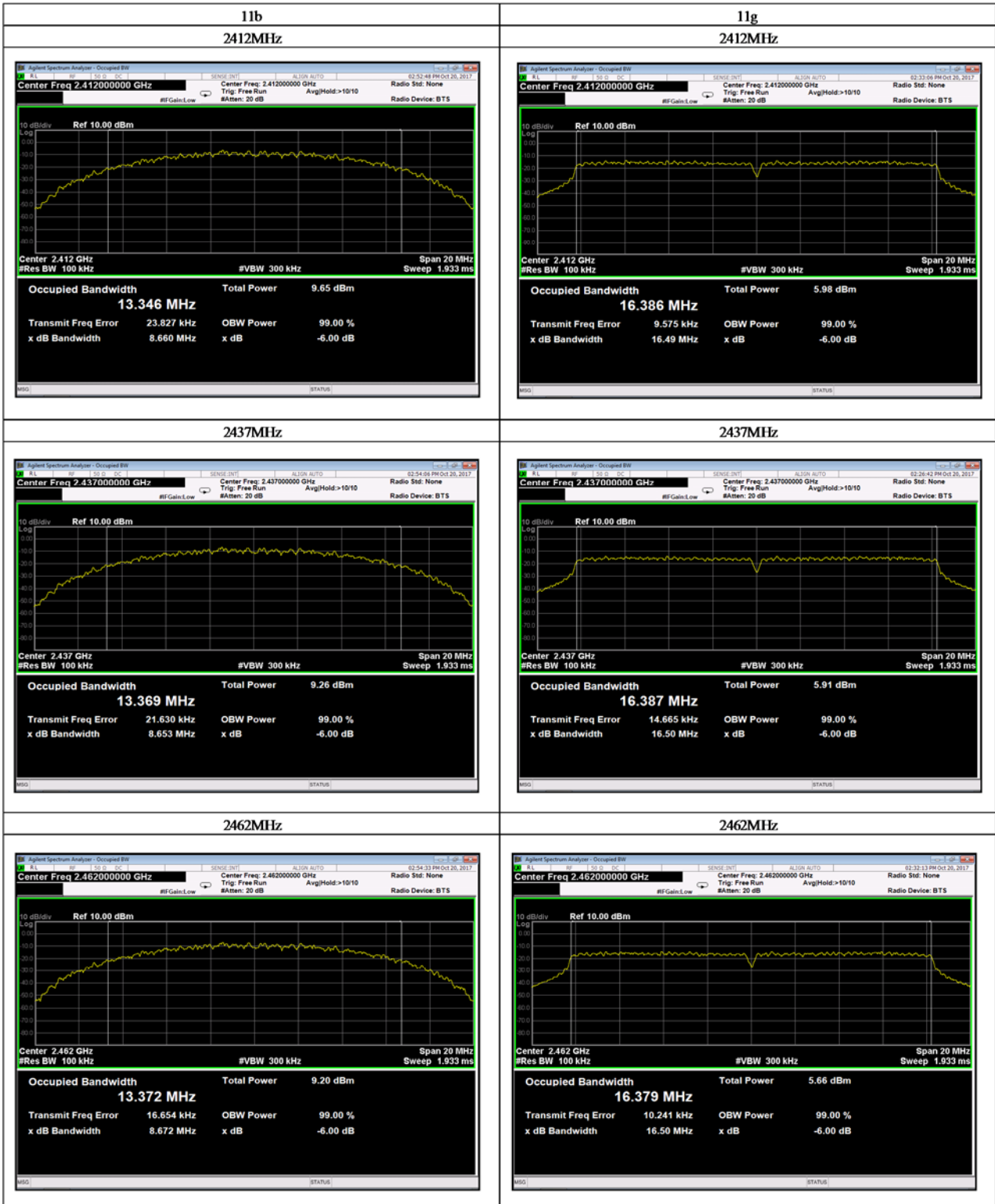



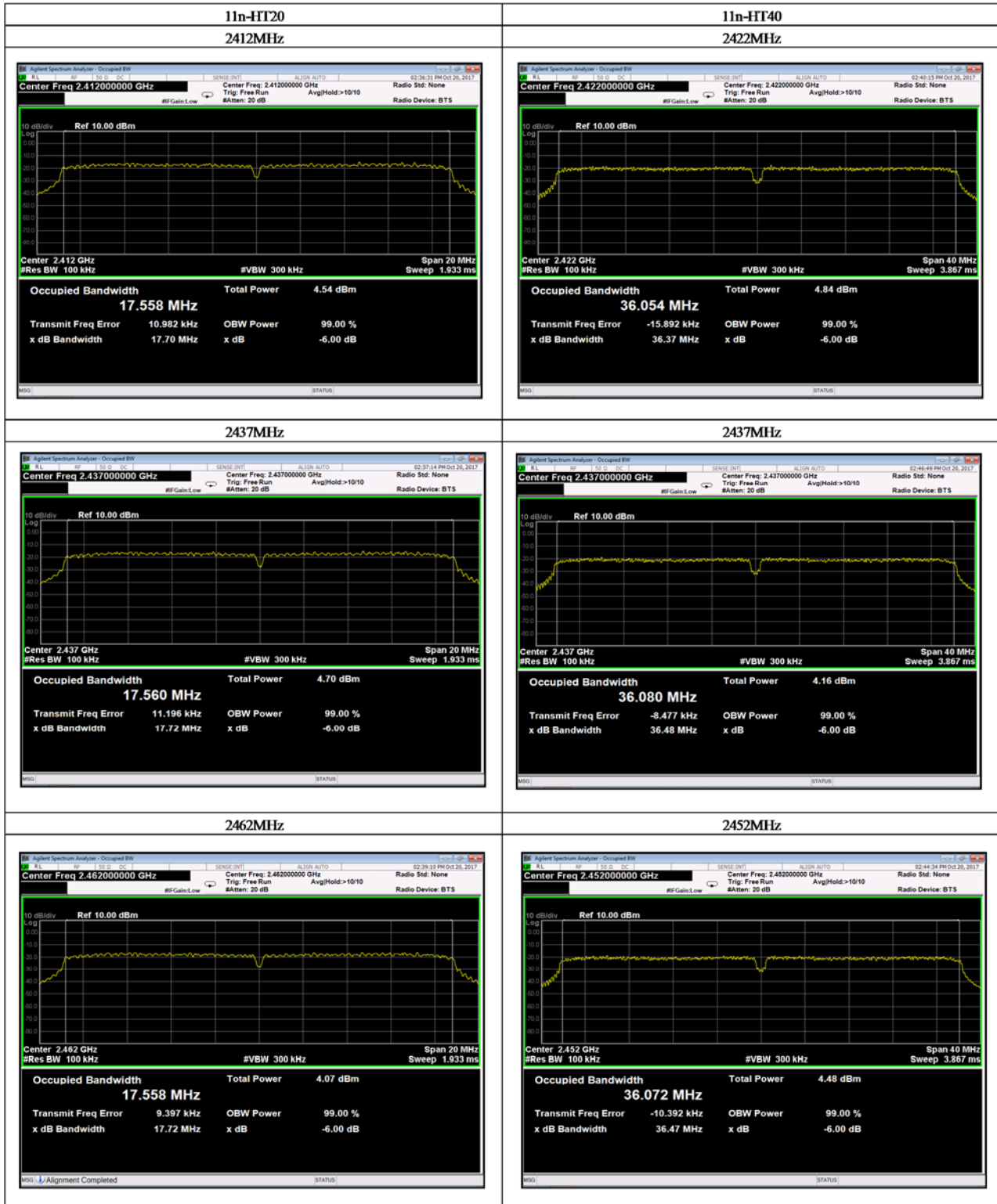



## 7. PEAK CONDUCTED OUTPUT POWER

### 7.1. Test Procedure

- (1) Connect the EUT RF output port to peak power meter via calibrated coaxial cable and suitable attenuator (if necessary).
- (2) Activates the EUT System and execute the software prepared for test, if necessary.
- (3) To find out the worst condition, the transmitting data rate of EUT is changed.
- (4) Measurement is started using the peak power meter.

### 7.2. Test Results

#### 11b Ant A

Measured Frequency (MHz)	Correction Factor (dB)	Meter Reading (dBm)	Peak Output Power (dBm)	Limit (dBm)	Margin for Limit (dB)
2412	10.98	6.98	17.96	30.00	12.04
2437	10.98	6.89	17.87	30.00	12.13
2462	10.98	6.68	17.66	30.00	12.34

#### 11g Ant A

Measured Frequency (MHz)	Correction Factor (dB)	Meter Reading (dBm)	Peak Output Power (dBm)	Limit (dBm)	Margin for Limit (dB)
2412	10.98	10.08	21.06	30.00	8.94
2437	10.98	10.25	21.23	30.00	8.77
2462	10.98	10.31	21.29	30.00	8.71



## 11n-HT20 Ant A

Measured Frequency (MHz)	Correction Factor (dB)	Meter Reading (dBm)	Peak Output Power	
			(dBm)	(mW)
2412	10.98	9.82	20.80	120.23
2437	10.98	9.49	20.47	111.43
2462	10.98	9.31	20.29	106.91

## 11n-HT20 Ant B

Measured Frequency (MHz)	Correction Factor (dB)	Meter Reading (dBm)	Peak Output Power	
			(dBm)	(mW)
2412	10.98	9.38	20.36	108.64
2437	10.98	9.49	20.47	111.43
2462	10.98	8.93	19.91	97.95

## 11n-HT20 Ant A+B

Measured Frequency (MHz)	Ant A (mW)	Ant B (mW)	Sum (mW)	Result (dBm)	Limit (dBm)	Margin for Limit (dB)
2412	120.23	108.64	228.87	23.60	30.00	6.40
2437	111.43	111.43	222.86	23.48	30.00	6.52
2462	106.91	97.95	204.85	23.11	30.00	6.89



## 11n-HT40 Ant A

Measured Frequency (MHz)	Correction Factor (dB)	Meter Reading (dBm)	Peak Output Power	
			(dBm)	(mW)
2422	10.98	9.89	20.87	122.18
2437	10.98	9.87	20.85	121.62
2452	10.98	10.26	21.24	133.05

## 11n-HT40 Ant B

Measured Frequency (MHz)	Correction Factor (dB)	Meter Reading (dBm)	Peak Output Power	
			(dBm)	(mW)
2422	10.98	9.41	20.39	109.40
2437	10.98	9.45	20.43	110.41
2452	10.98	9.63	20.61	115.08

## 11n-HT40 Ant A+B

Measured Frequency (MHz)	Ant A (mW)	Ant B (mW)	Sum (mW)	Result (dBm)	Limit (dBm)	Margin for Limit (dB)
2422	122.18	109.40	231.58	23.65	30.00	6.35
2437	121.62	110.41	232.03	23.66	30.00	6.34
2452	133.05	115.08	248.13	23.95	30.00	6.05

[Note]

Correction Factor includes the cable loss and attenuator loss.

[Calculation method]

Peak Output Power (dBm) = Meter Reading (dBm) + Correction Factor (dB)

Tested Date	Environment	
	Temperature	Humidity
20 October 2017	22 °C	29 %



## 8. POWER SPECTRAL DENSITY (DTS only)

### 8.1. Test Procedure

- (1) Connect the EUT RF output port to spectrum analyzer (\*1) via calibrated coaxial cable and suitable attenuator (if necessary).
- (2) Activates the EUT System and execute the software prepared for test, if necessary.
- (3) To find out the worst condition, the transmitting data rate of EUT is changed.
- (4) Record the spectral density perform peak search using the spectrum analyzer.

[Note]

(\*1) Spectrum Analyzer Set Up Conditions

Center Frequency	: Carrier frequency
Frequency Span	: 1.5 times the emission bandwidth
Resolution bandwidth	: 3kHz
Video bandwidth	: $\geq 3 \times$ RBW
Detector function	: Peak



## 8.2. Test Results

## 11b Ant A

Measured Frequency (MHz)	Correction Factor (dB)	Meter Reading (dBm)	Power Spectral Density (dBm)	Limit (dBm)	Margin for Limit (dB)
2412	11.42	-19.94	-8.52	8.00	16.52
2437	11.42	-20.19	-8.77	8.00	16.77
2462	11.42	-20.44	-9.02	8.00	17.02

## 11g Ant A

Measured Frequency (MHz)	Correction Factor (dB)	Meter Reading (dBm)	Power Spectral Density (dBm)	Limit (dBm)	Margin for Limit (dB)
2412	11.42	-27.34	-15.92	8.00	23.92
2437	11.42	-27.49	-16.07	8.00	24.07
2462	11.42	-27.25	-15.83	8.00	23.83



## 11n-HT20 Ant A

Measured Frequency (MHz)	Correction Factor (dB)	Meter Reading (dBm)	Power Spectral Density	
			(dBm)	(mW)
2412	11.42	-28.13	-16.71	0.02
2437	11.42	-28.69	-17.27	0.02
2462	11.42	-28.14	-16.72	0.02

## 11n-HT20 Ant B

Measured Frequency (MHz)	Correction Factor (dB)	Meter Reading (dBm)	Power Spectral Density	
			(dBm)	(mW)
2412	11.42	-28.95	-17.53	0.02
2437	11.42	-29.01	-17.59	0.02
2462	11.42	-28.88	-17.46	0.02

## 11n-HT20 Ant A+B

Measured Frequency (MHz)	Ant A (mW)	Ant B (mW)	Sum (mW)	Result (dBm)	Limit (dBm)	Margin for Limit (dB)
2412	0.02	0.02	0.04	-14.09	8.00	22.09
2437	0.02	0.02	0.04	-14.42	8.00	22.42
2462	0.02	0.02	0.04	-14.06	8.00	22.06



## 11n-HT40 Ant A

Measured Frequency (MHz)	Correction Factor (dB)	Meter Reading (dBm)	Power Spectral Density	
			(dBm)	(mW)
2422	11.42	-30.47	-19.05	0.01
2437	11.42	-30.98	-19.56	0.01
2452	11.42	-31.50	-20.08	0.01

## 11n-HT40 Ant B

Measured Frequency (MHz)	Correction Factor (dB)	Meter Reading (dBm)	Power Spectral Density	
			(dBm)	(mW)
2422	11.42	-31.62	-20.20	0.01
2437	11.42	-32.21	-20.79	0.01
2452	11.42	-32.49	-21.07	0.01

## 11n-HT40 Ant A+B

Measured Frequency (MHz)	Ant A (mW)	Ant B (mW)	Sum (mW)	Result (dBm)	Limit (dBm)	Margin for Limit (dB)
2422	0.01	0.01	0.02	-16.58	8.00	24.58
2437	0.01	0.01	0.02	-17.12	8.00	25.12
2452	0.01	0.01	0.02	-17.54	8.00	25.54

[Note]

- (1) Correction Factor includes the cable loss and attenuator loss.
- (2) See next page figure.

[Calculation method of Limit line]

$$\text{Spectral Density (dBm)} = \text{Meter Reading (dBm)} + \text{Correction Factor (dB)}$$

Tested Date	Environment	
	Temperature	Humidity
20 October 2017	23 °C	30 %





Spectrum Chart

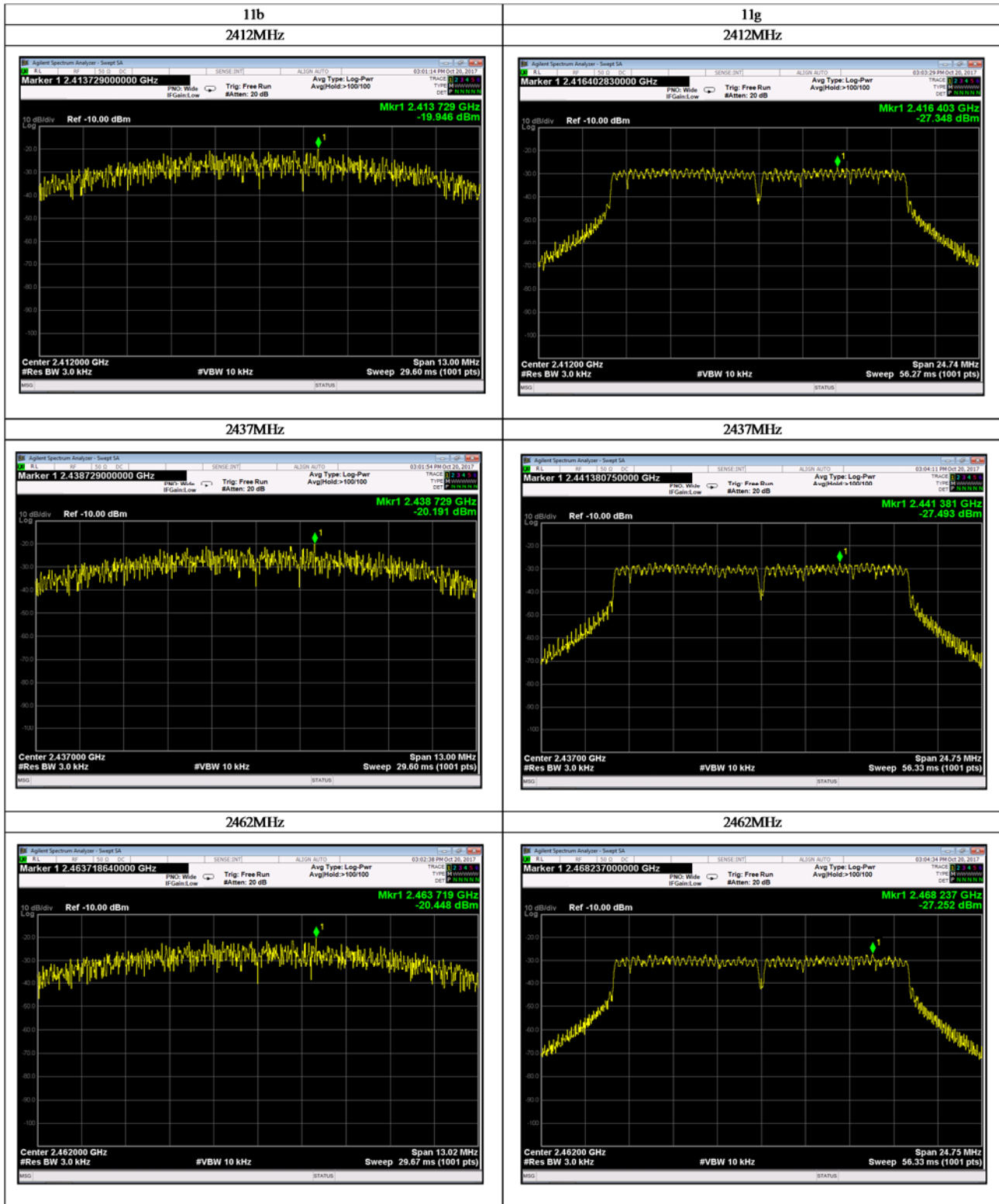

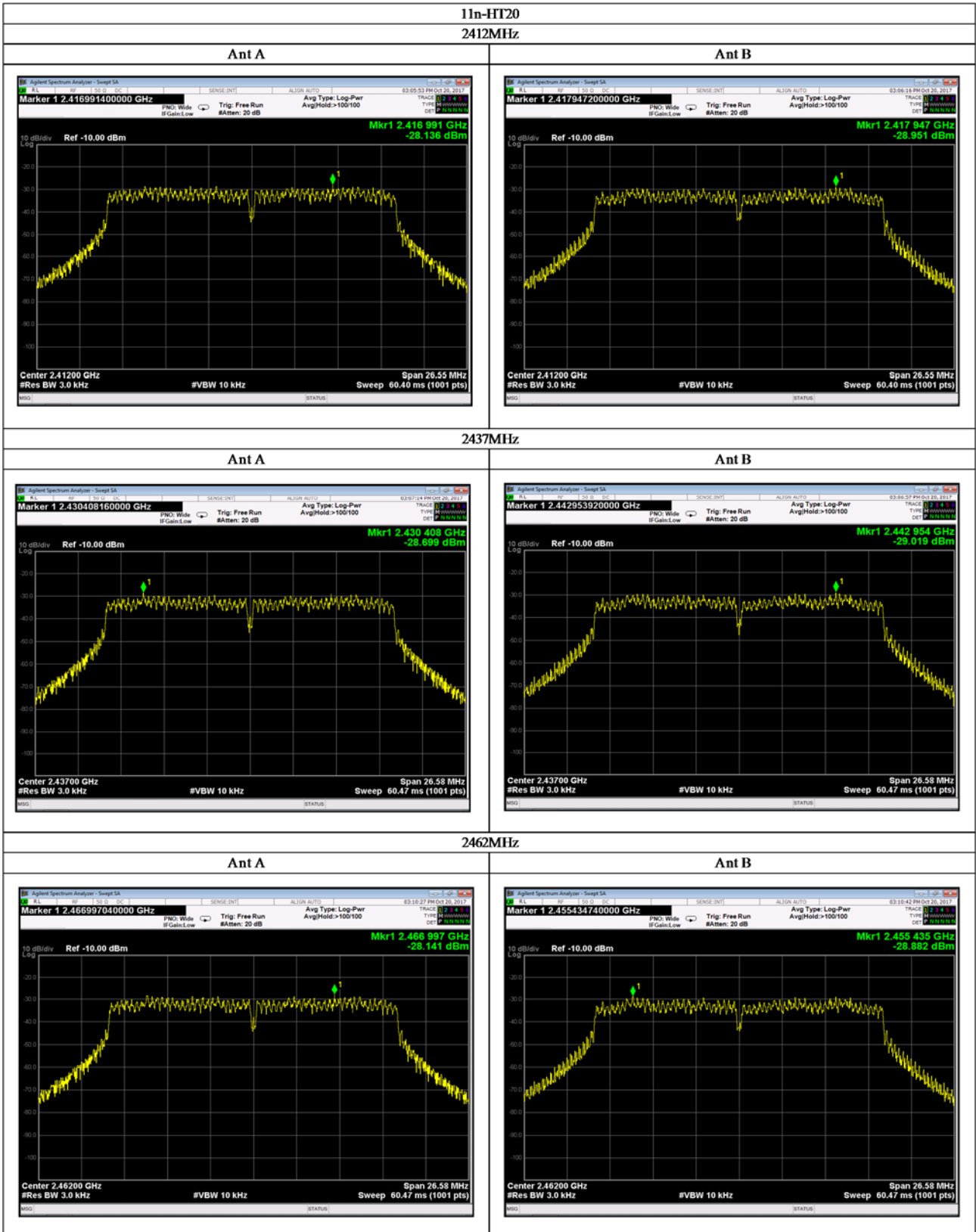

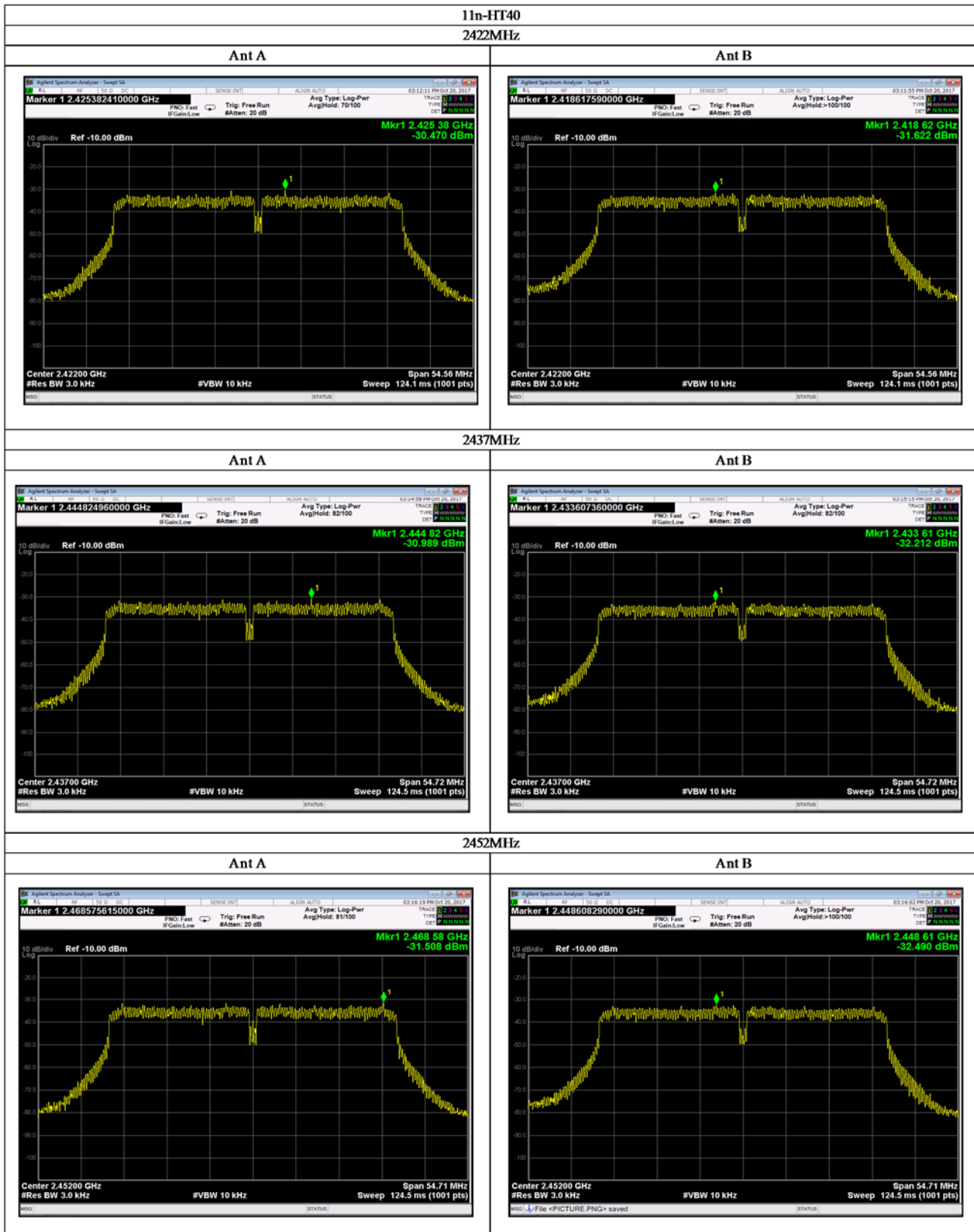

9. SPURIOUS EMISSION

9.1. Test Procedure

<p>Radiated measurement</p> <p>(1) The EUT is placed in accordance with ANSI C63.10.</p> <p>(2) The EUT is activated as to simulate an wort datarate.</p> <p>(3) To find out the maximum emission of the configuration of the EUT System, the position of the cables are changed, then preliminary radiated measurement are performed using the spectrum analyzer ,the broad band antenna and the horn antenna.</p> <p>(4) The spectrums are scanned from 30MHz to 1GHz, and collect the highest emissions on the spectrum analyzer (*1) relative to the limits in the whole range. In the frequency above 1GHz, it is performed using the spectrum analyzer (*1) and the horn antenna.</p> <p>(5) The highest emissions are measured at the specified distance using the test receiver (*2) and the broad band antenna or the tuned dipole. In the frequency above 1GHz, the measurements are performed by Bore-sight method using the spectrum analyzer (*3) and the horn antenna (*4).</p> <p>Conducted measurement</p> <p>(1) Connect the EUT RF output port to the spectrum analyzer (*5) via calibrated coaxial cable and suitable attenuator (if necessary).</p> <p>(2) The EUT is activated as to simulate an wort data rate.</p>														
<p>[Note]</p> <p>(*1) Spectrum Analyzer Set Up Conditions (Pre-measurement)</p> <p>Frequency range : 30MHz – 1GHz / 1GHz – Upper frequency of measurement range</p> <p>Resolution bandwidth : 100kHz / 1MHz</p> <p>Detector function : Peak</p> <p>(*2) Test Receiver Set Up Conditions</p> <p>Detector function : Quasi – Peak</p> <p>IF bandwidth : 120kHz (6dB Bandwidth)</p> <hr/> <p>(*3) Peak measurement Set Up Conditions</p> <p>Resolution bandwidth : 1MHz (Impulse Bandwidth)</p> <p>Video bandwidth : 3 x RBW</p> <p>Detector function : Peak</p> <p>Average measurement Set Up Conditions</p> <p>Resolution bandwidth : 1MHz (Impulse Bandwidth)</p> <p>Video bandwidth : 3 x RBW (DTS) / 10Hz (FHSS)</p> <p>Detector function : RMS (DTS) / Peak (FHSS)</p> <p>Trace : Trace Average 100 times (DTS)</p> <p>Y axis : Linear (FHSS)</p> <p>Non-Restricted Band measurement Set Up Conditions</p> <p>Resolution bandwidth : 100kHz</p> <p>Video bandwidth : 3 x RBW</p> <p>Detector function : Peak</p> <hr/> <p>(*4) Cover Area of Horn Antenna (3dB Beamwidth)</p> <table border="1" data-bbox="354 1621 1189 1794"> <thead> <tr> <th>Frequency [GHz]</th> <th>Cover Area [m] at distance 3m</th> <th>Cover Area [m] at distance 1m</th> </tr> </thead> <tbody> <tr> <td>1.0-6.0</td> <td>1.89</td> <td>-</td> </tr> <tr> <td>5.8-12.4</td> <td>0.63</td> <td>0.21</td> </tr> <tr> <td>12.4-40.0</td> <td>0.47</td> <td>0.16</td> </tr> </tbody> </table> <hr/> <p>(*5) Spectrum Analyzer Set Up Conditions</p> <p>Frequency range : 9kHz – 150kHz / 150kHz – 30MHz</p> <p>Resolution bandwidth : 300Hz / 10kHz (6dB Bandwidth)</p> <p>Video bandwidth : 3 x RBW</p> <p>Detector function : Peak</p>			Frequency [GHz]	Cover Area [m] at distance 3m	Cover Area [m] at distance 1m	1.0-6.0	1.89	-	5.8-12.4	0.63	0.21	12.4-40.0	0.47	0.16
Frequency [GHz]	Cover Area [m] at distance 3m	Cover Area [m] at distance 1m												
1.0-6.0	1.89	-												
5.8-12.4	0.63	0.21												
12.4-40.0	0.47	0.16												



## 9.2. Test Software List

KEC No.	Software Name	Version	Manufacture
TF-059	TEPTO Radiated emission automatic measurement	2.6.0164	TSJ
TF-110	Junction sheet	1.6J	KEC

## 9.3. Test Results

30-1000MHz

11n-HT40 2452MHz

Measured Frequency ( MHz )	Correction Factor ( dB/m )	Meter Reading		Maximum Field Strength ( dB $\mu$ V/m )	Limit ( dB $\mu$ V/m )	Margin for Limit ( dB )
		Horizontal Polarization ( dB $\mu$ V )	Vertical Polarization ( dB $\mu$ V )			
30.00	25.1	<0.0	5.8	30.9	40.0	9.1
66.30	13.7	6.6	6.8	20.5	40.0	19.5
99.20	17.5	<0.0	9.7	27.2	43.5	16.3
154.37	22.8	<0.0	3.1	25.9	43.5	17.6
456.11	21.0	2.5	4.8	25.8	46.0	20.2
798.75	25.7	<0.0	<0.0	<25.7	46.0	>20.3



Test Results in Graph

X Axis

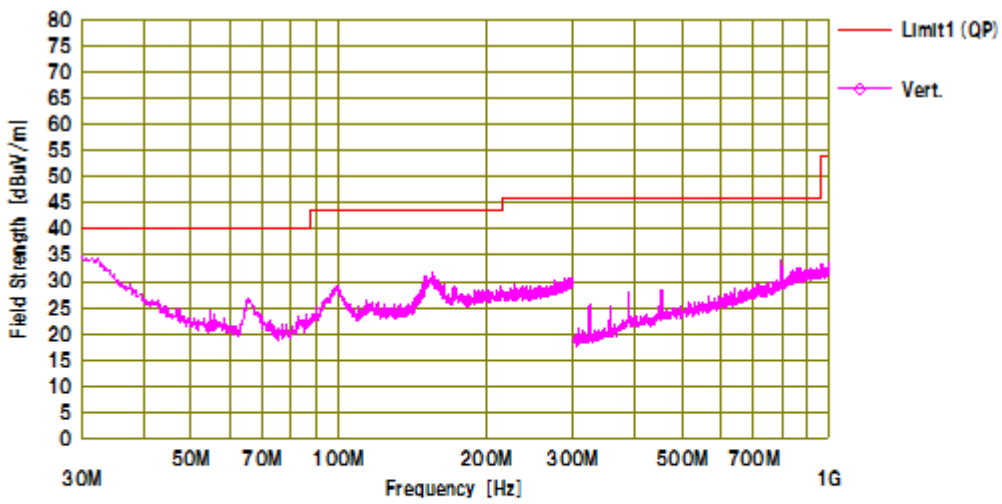
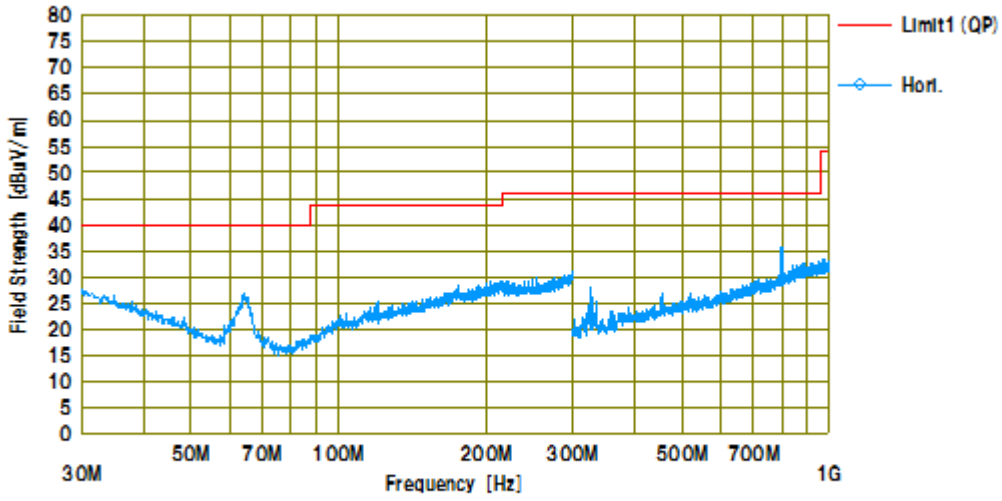



Y Axis

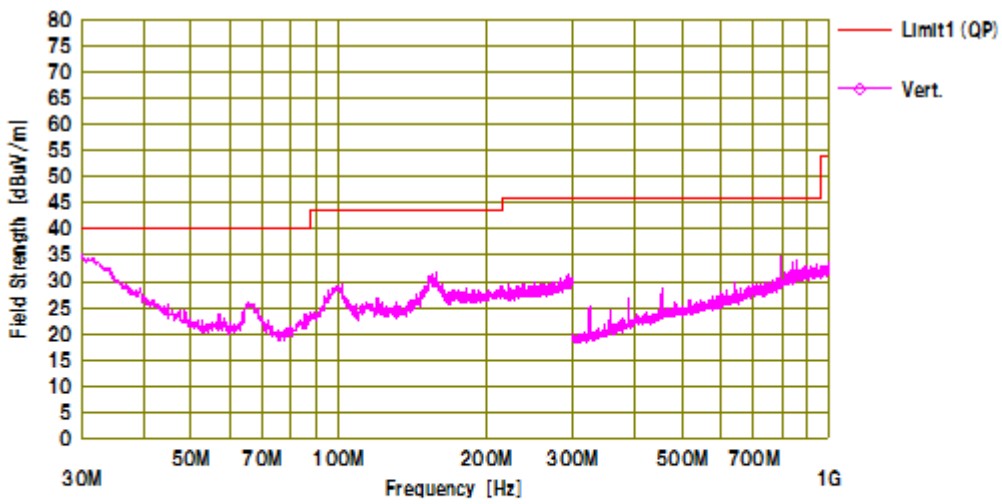
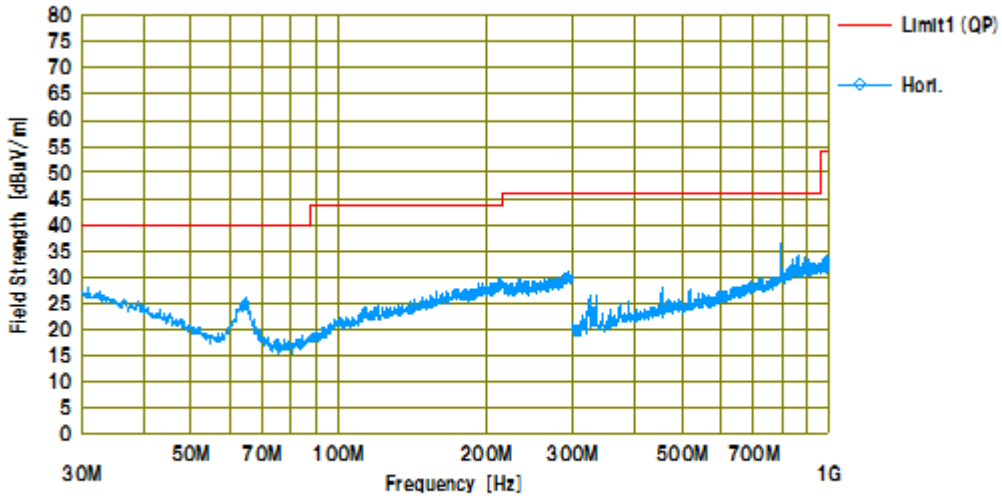



Z Axis

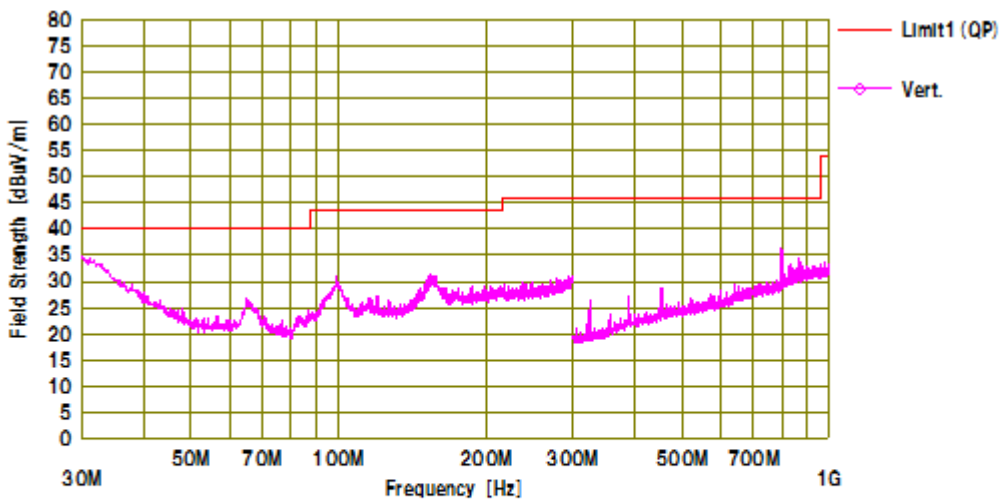
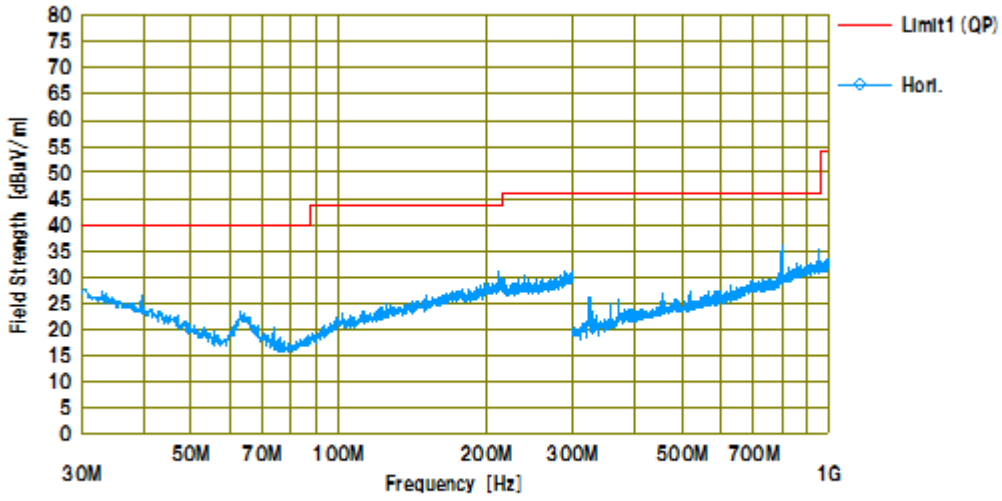





Above 1GHz

11b 2412MHz

Measured Frequency (MHz)	Correction Factor (dB/m)	Meter Reading		Maximum Field Strength (dBµV/m)	Limit (dBµV/m)	Margin for Limit (dB)
		Horizontal Polarization (dBµV)	Vertical Polarization (dBµV)			
Measurement with the Peak Detector						
2390.00	6.7	47.5	46.9	54.2	74.0	19.8
3215.90	-1.5	46.4	46.7	45.2	74.0	28.8
4824.00	0.3	50.8	50.8	51.1	74.0	22.9
6432.00	-7.6	59.5	56.3	51.9	74.0	22.1
7236.00	-5.9	60.0	53.1	54.1	74.0	19.9
9648.00	-1.8	50.2	50.3	48.5	74.0	25.5
Measurement with the Average Detector						
2390.00	6.7	34.9	35.1	41.8	54.0	12.2
3215.90	-1.5	35.5	36.8	35.3	54.0	18.7
4824.00	0.3	37.6	37.9	38.2	54.0	15.8
6432.00	-7.6	57.3	53.7	49.7	54.0	4.3
7236.00	-5.9	48.2	42.5	42.3	54.0	11.7
9648.00	-1.8	41.7	41.2	39.9	54.0	14.1

[20dBc Data Sheet]

Measured Frequency (MHz)	Correction Factor (dB/m)	Meter Reading		Maximum Field Strength (dBµV/m)	Limit (dBµV/m)	Margin for Limit (dB)
		Horizontal Polarization (dBµV)	Vertical Polarization (dBµV)			
Peak measurement						
* 1) 2412.00	6.8	91.8	-	98.6	-	-
2400.00	6.7	43.1	-	49.8	78.6	28.8
* 1) 2412.00	6.8	-	91.9	98.7	-	-
2400.00	6.7	-	42.4	49.1	78.7	29.6

[ Note ]

\* 1) : Carrier

[Restricted-band band-edge plot]

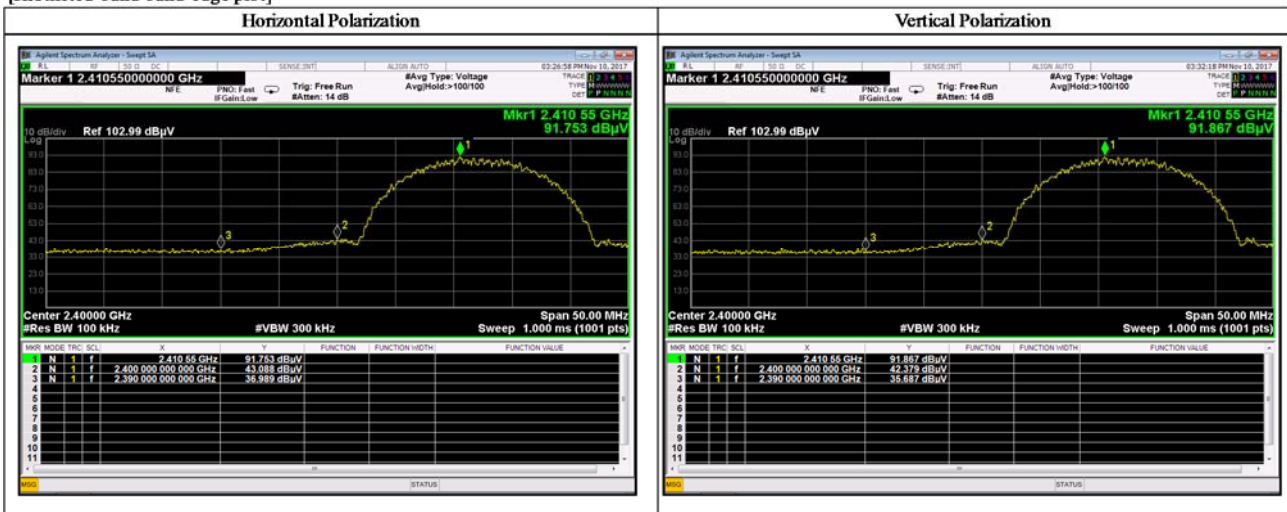



11b 2437MHz

Measured Frequency (MHz)	Correction Factor (dB/m)	Meter Reading		Maximum Field Strength (dBµV/m)	Limit (dBµV/m)	Margin for Limit (dB)
		Horizontal Polarization (dBµV)	Vertical Polarization (dBµV)			
Measurement with the Peak Detector						
3249.27	-1.5	54.5	47.2	53.0	74.0	21.0
4874.00	0.3	50.1	49.7	50.4	74.0	23.6
6498.63	-7.7	59.5	55.5	51.8	74.0	22.2
7311.00	-5.7	57.6	51.4	51.9	74.0	22.1
9748.00	-1.9	48.7	48.5	46.8	74.0	27.2
Measurement with the Average Detector						
3249.27	-1.5	37.2	37.0	35.7	54.0	18.3
4874.00	0.3	38.0	38.2	38.5	54.0	15.5
6498.63	-7.7	57.6	52.8	49.9	54.0	4.1
7311.00	-5.7	45.9	40.0	40.2	54.0	13.8
9748.00	-1.9	38.9	37.5	37.0	54.0	17.0

11b 2462MHz

Measured Frequency (MHz)	Correction Factor (dB/m)	Meter Reading		Maximum Field Strength (dBµV/m)	Limit (dBµV/m)	Margin for Limit (dB)
		Horizontal Polarization (dBµV)	Vertical Polarization (dBµV)			
Measurement with the Peak Detector						
2483.50	7.0	45.8	46.2	53.2	74.0	20.8
3282.69	-1.6	47.7	46.0	46.1	74.0	27.9
4924.00	0.4	51.0	49.9	51.4	74.0	22.6
6565.28	-7.4	59.7	58.6	52.3	74.0	21.7
7386.00	-5.5	59.4	52.2	53.9	74.0	20.1
9848.00	-1.8	48.2	47.8	46.4	74.0	27.6
Measurement with the Average Detector						
2483.50	7.0	34.1	35.0	42.0	54.0	12.0
3282.69	-1.6	37.4	35.1	35.8	54.0	18.2
4924.00	0.4	38.9	38.3	39.3	54.0	14.7
6565.28	-7.4	58.3	56.5	50.9	54.0	3.1
7386.00	-5.5	47.9	40.1	42.4	54.0	11.6
9848.00	-1.8	37.9	36.1	36.1	54.0	17.9

[Restricted-band band-edge plot]

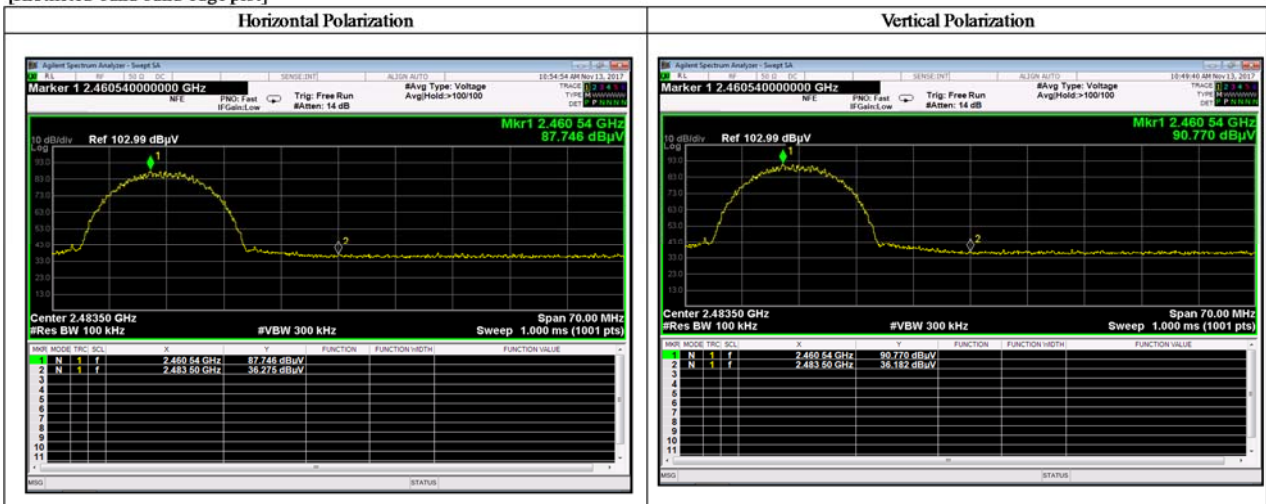



11g 2412MHz

Measured Frequency (MHz)	Correction Factor (dB/m)	Meter Reading		Maximum Field Strength (dBµV/m)	Limit (dBµV/m)	Margin for Limit (dB)
		Horizontal Polarization (dBµV)	Vertical Polarization (dBµV)			
Measurement with the Peak Detector						
2390.00	6.7	49.7	50.2	56.9	74.0	17.1
3215.98	-1.5	47.7	48.1	46.6	74.0	27.4
4824.00	0.3	53.8	52.1	54.1	74.0	19.9
6431.97	-7.6	58.8	51.3	51.2	74.0	22.8
7236.00	-5.9	56.6	52.0	50.7	74.0	23.3
9648.00	-1.8	47.4	47.9	46.1	74.0	27.9
Measurement with the Average Detector						
2390.00	6.7	37.0	38.0	44.7	54.0	9.3
3215.97	-1.5	39.8	40.9	39.4	54.0	14.6
4824.00	0.3	43.8	43.0	44.1	54.0	9.9
6431.97	-7.6	58.3	50.7	50.7	54.0	3.3
7236.00	-5.9	43.6	40.9	37.7	54.0	16.3
9648.00	-1.8	37.4	36.4	35.6	54.0	18.4

[20dBc Data Sheet]

Measured Frequency (MHz)	Antenna Factor (dB/m)	Meter Reading		Maximum Field Strength (dBµV/m)	Limit (dBµV/m)	Margin for Limit (dB)
		Horizontal Polarization (dBµV)	Vertical Polarization (dBµV)			
Peak measurement						
* 1) 2412.00	6.8	86.1	-	92.9	-	-
2400.00	6.7	46.8	-	53.5	72.9	19.4
* 1) 2412.00	6.8	-	86.7	93.5	-	-
2400.00	6.7	-	48.7	55.4	73.5	18.1

[ Note ]

\* 1) : Carrier

[Restricted-band band-edge plot]

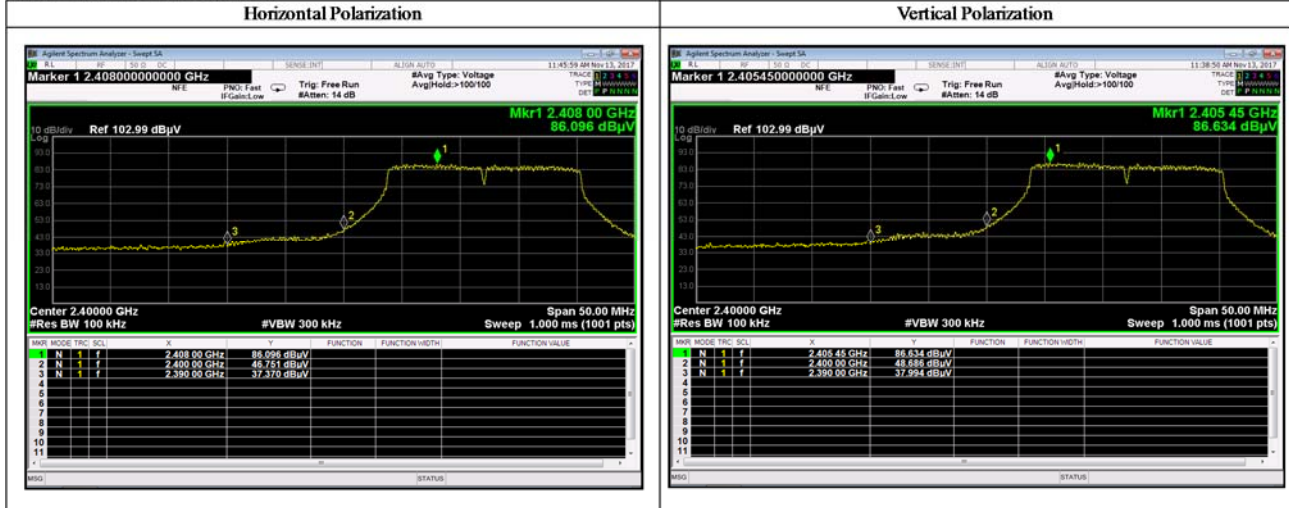



11g 2437MHz

Measured Frequency (MHz)	Correction Factor (dB/m)	Meter Reading		Maximum Field Strength (dBµV/m)	Limit (dBµV/m)	Margin for Limit (dB)
		Horizontal Polarization (dBµV)	Vertical Polarization (dBµV)			
Measurement with the Peak Detector						
3249.31	-1.5	49.1	48.9	47.6	74.0	26.4
4874.00	0.3	53.2	54.4	54.7	74.0	19.3
6498.71	-7.5	59.0	53.3	51.5	74.0	22.5
7313.38	-5.7	57.2	52.8	51.5	74.0	22.5
9748.00	-1.9	47.8	47.0	45.9	74.0	28.1
Measurement with the Average Detector						
3249.31	-1.5	39.8	40.5	39.0	54.0	15.0
4874.00	0.3	44.3	44.7	45.0	54.0	9.0
6498.71	-7.5	56.7	49.5	49.2	54.0	4.8
7313.38	-5.7	44.2	41.3	38.5	54.0	15.5
9748.00	-1.9	37.0	35.9	35.1	54.0	18.9

11g 2462MHz

Measured Frequency (MHz)	Correction Factor (dB/m)	Meter Reading		Maximum Field Strength (dBµV/m)	Limit (dBµV/m)	Margin for Limit (dB)
		Horizontal Polarization (dBµV)	Vertical Polarization (dBµV)			
Measurement with the Peak Detector						
2483.50	7.0	50.2	48.9	57.2	74.0	16.8
3282.69	-1.6	47.7	48.0	46.4	74.0	27.6
4924.00	0.4	54.6	52.8	55.0	74.0	19.0
6565.28	-7.4	59.2	52.5	51.8	74.0	22.2
7386.00	-5.5	56.8	53.4	51.3	74.0	22.7
9848.00	-1.8	48.1	52.8	51.0	74.0	23.0
Measurement with the Average Detector						
2483.50	7.0	36.6	36.2	43.6	54.0	10.4
3282.69	-1.6	39.8	40.3	38.7	54.0	15.3
4924.00	0.4	44.4	45.3	45.7	54.0	8.3
6565.28	-7.4	57.1	50.3	49.7	54.0	4.3
7386.00	-5.5	43.2	39.4	37.7	54.0	16.3
9848.00	-1.8	36.6	35.3	34.8	54.0	19.2

[Restricted-band band-edge plot]

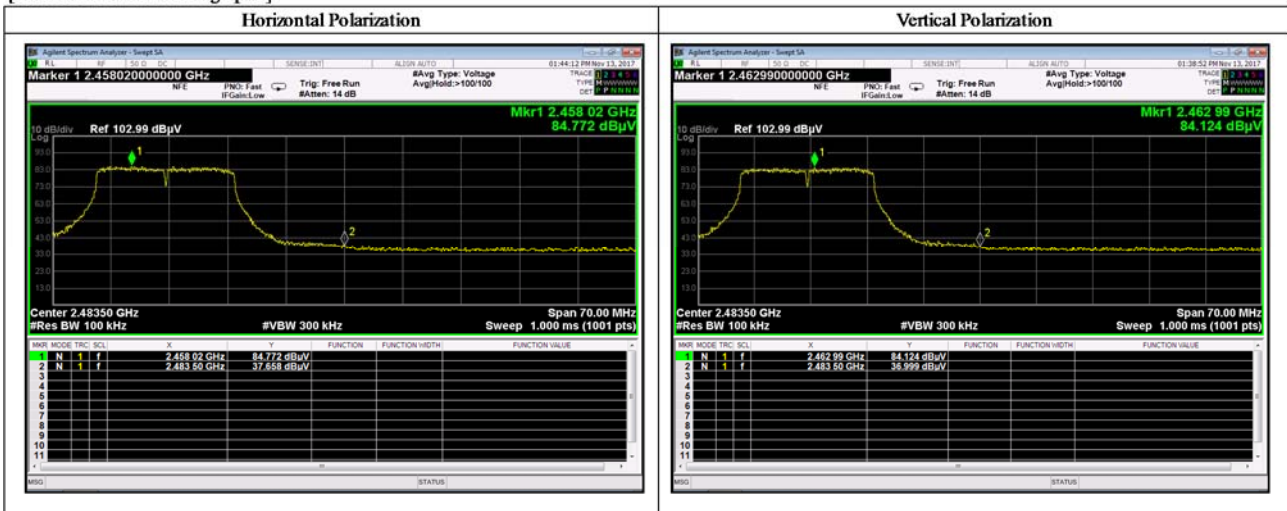



11n-HT20 2412MHz

Measured Frequency ( MHz )	Correction Factor ( dB/m )	Meter Reading		Maximum Field Strength ( dBμV/m )	Limit ( dBμV/m )	Margin for Limit ( dB )
		Horizontal Polarization ( dBμV )	Vertical Polarization ( dBμV )			
Measurement with the Peak Detector						
2390.00	6.7	49.2	52.1	58.8	74.0	15.2
3249.29	-1.5	47.9	48.5	47.0	74.0	27.0
4824.00	0.3	53.3	54.5	54.8	74.0	19.2
6431.95	-7.8	56.6	51.5	48.8	74.0	25.2
7236.00	-5.9	52.9	51.8	47.0	74.0	27.0
9648.00	-1.8	48.7	47.9	46.9	74.0	27.1
Measurement with the Average Detector						
2390.00	6.7	38.6	40.8	47.5	54.0	6.5
3249.29	-1.5	40.8	42.2	40.7	54.0	13.3
4824.00	0.3	44.5	43.6	44.8	54.0	9.2
6431.95	-7.8	54.8	46.9	47.0	54.0	7.0
7236.00	-5.9	40.2	39.9	34.3	54.0	19.7
9648.00	-1.8	39.3	36.3	37.5	54.0	16.5

[20dBc Data Sheet]

Measured Frequency ( MHz )	Antenna Factor ( dB/m )	Meter Reading		Maximum Field Strength ( dBμV/m )	Limit ( dBμV/m )	Margin for Limit ( dB )
		Horizontal Polarization ( dBμV )	Vertical Polarization ( dBμV )			
Peak measurement						
* 1) 2412.00	6.8	85.4	-	92.2	-	-
2400.00	6.7	46.6	-	53.3	72.2	18.9
* 1) 2412.00	6.8	-	88.5	95.3	-	-
2400.00	6.7	-	50.0	56.7	75.3	18.6

[ Note ]

\* 1) : Carrier

[Restricted-band band-edge plot]

