

OWNER'S MANUAL

Symphonic

VIDEO CASSETTE RECORDER SL2920

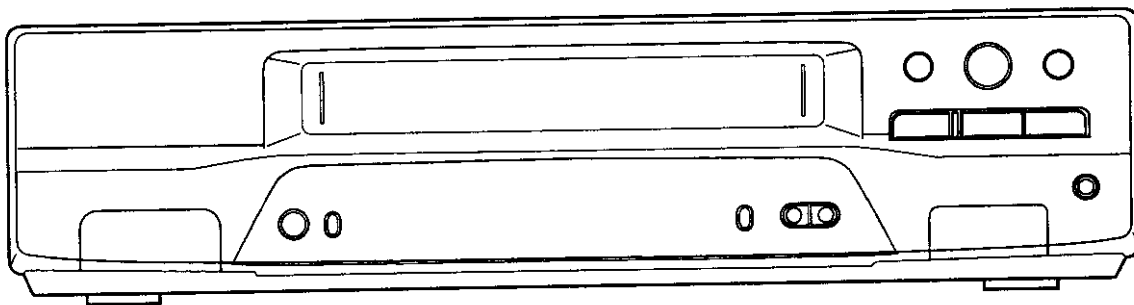

INSTRUCCIONES EN ESPAÑOL INCLUIDAS.

If you need additional assistance for set-up or operating
after reading owner's manual, please call
TOLL FREE : 1-800-242-7158.

VHS

Please read before using this equipment.

WARNING:

TO REDUCE THE RISK OF FIRE OR ELECTRIC SHOCK, DO NOT EXPOSE THIS APPLIANCE TO RAIN OR MOISTURE.



CAUTION

RISK OF ELECTRIC SHOCK
DO NOT OPEN



CAUTION: TO REDUCE THE RISK OF ELECTRIC SHOCK, DO NOT REMOVE COVER (OR BACK). NO USER SERVICEABLE PARTS INSIDE. REFER SERVICING TO QUALIFIED SERVICE PERSONNEL.



THIS SYMBOL INDICATES THAT DANGEROUS VOLTAGE CONSTITUTING A RISK OF ELECTRIC SHOCK IS PRESENT WITHIN THIS UNIT.



THIS SYMBOL INDICATES THAT THERE ARE IMPORTANT OPERATING AND MAINTENANCE INSTRUCTIONS IN THE LITERATURE ACCOMPANYING THE APPLIANCE.

The caution marking is located on the rear of the cabinet.

IMPORTANT SAFEGUARDS

- 1. Read instructions**-All the safety and operating instructions should be read before the appliance is operated.
- 2. Retain Instructions**-The safety and operating instructions should be retained for future reference.
- 3. Heed Warnings**-All warnings on the appliance and in the operating instructions should be adhered to.
- 4. Follow Instructions**-All operating and use instructions should be followed.
- 5. Cleaning**-Unplug this video product from the wall outlet before cleaning. Do not use liquid cleaners or aerosol cleaners. Use a damp cloth for cleaning.
EXCEPTION: A product that is meant for uninterrupted service and, that for some specific reason, such as the possibility of the loss of an authorization code for a CATV converter, is not intended to be unplugged by the user for cleaning or any other purpose, may exclude the reference to unplugging the appliance in the cleaning description otherwise required in item 5.
- 6. Attachments**-Do not use attachments not recommended by the video product manufacturer as they may cause hazards.
- 7. Water and Moisture**-Do not use this video product near water, for example, near a bath tub, wash bowl, kitchen sink, or laundry tub, in a wet basement, or near a swimming pool, and the like.
- 8. Accessories**-Do not place this video product on an unstable cart, stand, tripod, bracket, or table. The video product may fall, causing serious injury to a child or adult, and serious damage to the appliance. Use only with a cart, stand, tripod, bracket, or table recommended by the manufacturer, or sold with the video product. Any mounting of the appliance should follow the manufacturer's instructions and should use a mounting accessory recommended by the manufacturer. An appliance and cart combination should be moved with care. Quick stops, excessive force, and uneven surfaces may cause the ap-

PORTABLE CART WARNING
(Symbol provided by RETAC)



S3125A

pliance and cart combination to overturn.

- 9. Ventilation**-Slots and openings in the cabinet are provided for ventilation and to ensure reliable operation of the video product and to protect it from overheating, and these openings must not be blocked or covered. The openings should never be blocked by placing the video product on a bed, sofa, rug, or other similar surface. This video product should not be placed in a built-in installation such as a bookcase or rack unless proper ventilation is provided or the manufacturer's instructions have been adhered to.
- 10. Power Sources**-This video product should be operated only from the type of power source indicated on the marking label. If you are not sure of the type of power supply to your home, consult your appliance dealer or local power company. For products intended to operate from battery power, or other sources, refer to the operating instructions.
- 11. Grounding or Polarization**- This video product is equipped with a polarized alternating-current line plug (a plug having one blade wider than the other). This plug will fit into the power outlet only one way. This is a safety feature. If you are unable to insert the plug fully into the outlet, try reversing the plug. If the plug should still fail to fit, contact your electrician to replace your obsolete outlet. Do not defeat the safety purpose of the polarized plug.
- 12. Power Cord Protection**-Power supply cords should be routed so that they are not likely to be walked on or pinched by items placed upon or against them, paying particular attention to cords at plugs, convenience receptacles, and the point where they exit from the appliance.
- 13. Outdoor Antenna Grounding**-If an outside antenna or cable system is connected to the video product, be sure the antenna or cable system is grounded so as to provide some protection against voltage surges and built-up static charges. Article 810 of the National Electrical Code, ANSI/NFPA No. 70, provides information with regard to proper grounding of the mast and supporting structure, grounding of the lead-in wire to an antenna discharge unit, size of grounding conductors, location of antenna-discharge unit, connection to grounding electrodes, and requirements for the grounding electrode. (Fig. A)

FIGURE A
EXAMPLE OF ANTENNA GROUNDING AS PER
NATIONAL ELECTRICAL CODE

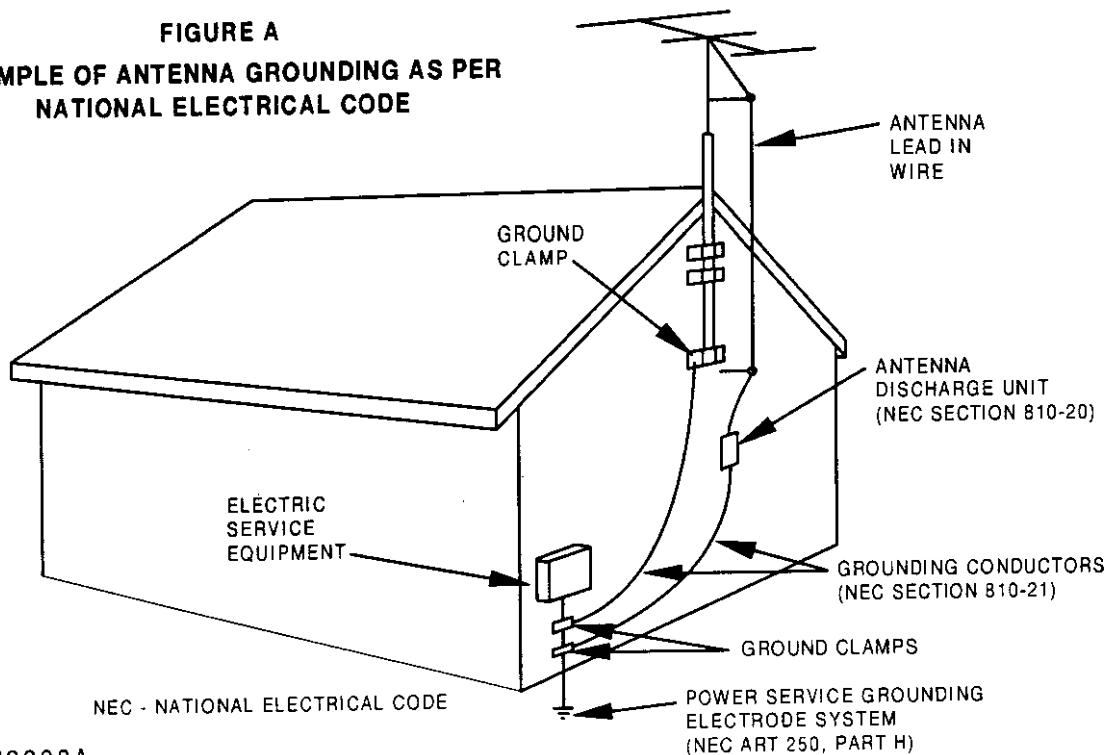

S2898A

14. Lightning-For added protection for this video product during a lightning storm, or when it is left unattended and unused for long periods of time, unplug it from the wall outlet and disconnect the antenna or cable system. This will prevent damage to the video product due to lightning and power-line surges.

15. Power Lines-An outside antenna system should not be located in the vicinity of overhead power lines or other electric light or power circuits, or where it can fall into such power lines or circuits. When installing an outside antenna system, extreme care should be taken to keep from touching such power lines or circuits as contact with them might be fatal.

16. Overloading-Do not overload wall outlets and extension cords as this can result in a risk of fire or electric shock.

17. Object and Liquid Entry-Never push objects of any kind into this video product through any openings as they may touch dangerous voltage points or short-out parts that could result in a fire or electric shock. Never spill liquid of any kind on the video product.

18. Servicing-Do not attempt to service this video product yourself as opening or removing covers may expose you to dangerous voltage or other hazards. Refer all servicing to qualified service personnel.

19. Damage Requiring Service-Unplug this video product from the wall outlet and refer servicing to qualified service personnel under the following conditions:

- a. When the power-supply cord or plug is damaged.
- b. If liquid has been spilled, or objects have fallen into the video product.
- c. If the video product has been exposed to rain or water.

- d. If the video product does not operate normally by following the operating instructions. Adjust only those controls that are covered by the operating instructions as an improper adjustment of other controls may result in damage and will often require extensive work by a qualified technician to restore the video product to its normal operation.
- e. If the video product has been dropped or damaged in any way.
- f. When the video product exhibits a distinct change in performance-this indicates a need for service.

20. Replacement Parts-When replacement parts are required, be sure the service technician has used replacement parts specified by the manufacturer or have the same characteristics as the original part. Unauthorized substitutions may result in fire, electric shock or other hazards.

21. Safety Check-Upon completion of any service or repairs to this video product, ask the service technician to perform safety checks to determine that the video product is in proper operating condition.

22. Heat-This video product should be situated away from heat sources such as radiators, heat registers, stoves, or other products (including amplifiers) that produce heat.

PRECAUTIONS

LOCATION

For safe operation and optimum performance of your VCR, keep the following in mind when selecting a place for its installation:

- Shield it from direct sunlight and keep it away from sources of intense heat.
- Avoid dusty or humid places.
- Avoid places with insufficient ventilation for proper heat dissipation. Do not block the ventilation holes on the sides of the VCR.
- Install unit in a horizontal position.
- Avoid locations subject to strong vibration.
- Do not place the VCR near strong magnetic fields.
- Avoid moving VCR to locations where temperature differences are extreme.
- Do not place the VCR directly on top of the TV.

AVOID THE HAZARDS OF ELECTRICAL SHOCK AND FIRE

- Do not handle the power cord with wet hands.
- Do not pull on the power cord when disconnecting it from AC wall outlet. Grasp it by the plug.
- If, by accident, water is spilled on your VCR, unplug the power cord immediately and take the unit to our Authorized Service Center for servicing.
- Do not put your fingers or objects into the VCR cassette holder.
- Do not place anything directly on top of the VCR.

WARNING

Moisture condensation may occur inside the unit when it is moved from a cold place to a warm place, or after heating a cold room or under conditions of high humidity. Do not use the VCR at least for 2 hours until its inside is dry.

FCC WARNING- This equipment may generate or use radio frequency energy. Changes or modifications to this equipment may cause harmful interference unless the modifications are expressly approved in the instruction manual. The user could lose the authority to operate this equipment if an unauthorized change or modification is made.

IMPORTANT COPYRIGHT INFORMATION

Unauthorized recording or use of broadcast television programming, video tape, film or other copyrighted material may violate applicable copyright laws. We assume no responsibility for the unauthorized duplication, use, or other acts which infringe upon the rights of copyright owners.

The serial number of this product may be found on the back of the VCR. No other VCR has the same serial number as yours. You should record the number and other vital information here and retain this book as a permanent record of your purchase to aid identification in case of theft. Serial numbers are not kept on file.

Date of Purchase	
Dealer Purchase from	
Dealer Address	
Dealer Phone No.	
Model No.	
Serial No.	

TABLE OF CONTENTS

■ IMPORTANT SAFEGUARDS	2
■ PRECAUTIONS	4
LOCATION	4
AVOID THE HAZARDS OF ELECTRICAL SHOCK AND FIRE	4
WARNING	4
■ FEATURES	6
■ SUPPLIED ACCESSORIES	6
■ VIDEO CASSETTE TAPE INFORMATION	7
■ OPERATING CONTROLS AND FUNCTIONS	8
■ PREPARATION FOR USE	10
ANTENNA/CABLE CONNECTIONS	10
SETTING THE CH3/CH4 SWITCH	13
CONNECTING TO INPUT JACKS	13
A/V TERMINALS	13
INSTALLING THE BATTERIES	13
■ SET UP FOR USE	14
CHANNEL SET UP (Automatic)	14
CLOCK SET UP	15
TO DELETE CHANNELS	16
CHANNEL SET UP AGAIN	16
SELECTING THE LANGUAGE	16
■ PLAYBACK	17
NORMAL PLAYBACK	17
PICTURE SEARCH	17
STILL PICTURE	17
NOISE CANCEL (in the Still mode)	17
VERTICAL HOLD CONTROL	18
TRACKING ADJUSTMENT	18
COUNTER MEMORY	18
■ SPECIAL PLAYBACK	19
AUTO REPEAT PLAYBACK	19
RENTAL PLAYBACK	19
■ RECORDING	20
VIEWING AND RECORDING THE SAME PROGRAM	20
SKIPPING SOME MATERIALS DURING RECORDING	20
RECORDING ONE PROGRAM WHILE VIEWING ANOTHER	20
TO MONITOR THE PROGRESS OF YOUR RECORDING	20
OTR (One Touch Recording)	21
■ TIMER RECORDING	22
AUTOMATIC TIMER RECORDING	22
HINTS FOR TIMER RECORDING	23
TIMER PROGRAM EXTENSION	24
AUTO RETURN	24
■ COPYING A VIDEO TAPE	25
■ ON SCREEN DISPLAY	25
■ SPECIAL FEATURES	25
REAL TIME TAPE COUNTER	25
AUTO REWIND	25
■ TROUBLESHOOTING GUIDE	26
■ MAINTENANCE	26
■ SPECIFICATIONS	27
■ CABLE CHANNEL DESIGNATIONS	27
■ WARRANTY	BACK COVER

INDICE

■ IMPORTANTE PARA SU SEGURIDAD	29
■ PRECAUCIONES	30
UBICACIÓN	30
EVITE LOS PELIGROS DE DESCARGAS ELÉCTRICAS E INCENDIOS	30
ADVERTENCIA	30
■ ACCESORIOS SUMINISTRADOS	31
■ INFORMACIÓN ACERCA DE LAS CINTAS DE VIDEOCASETE	31
■ CONTROLES DE OPERACIÓN Y SUS FUNCIONES	31
■ PREPARACIÓN PARA LA UTILIZACIÓN	32
CONEXIONES DE ANTENA/CABLE	32
AJUSTE DEL CONMUTADOR CH3/CH4	33
TERMINALES A/V	33
INSTALACIÓN DE LAS PILAS	33
■ PREPARACIÓN PARA LA UTILIZACIÓN	33
PREPARACIÓN DE CANALES (Automática)	33
PUESTA EN HORA DEL RELOJ	34
PARA BORRAR CANALES	34
REPETICIÓN DE PREPARACIÓN DE CANALES	34
SELECCIÓN DEL IDIOMA	35
■ REPRODUCCIÓN	35
REPRODUCCIÓN NORMAL	35
BÚSQUEDA DE IMAGEN	35
IMAGEN FIJA	35
CANCELACIÓN DE RUIDOS (En el modo de imagen fija)	35
CONTROL DE RETENCIÓN VERTICAL	35
AJUSTE DE SEGUIMIENTO	35
MEMORIA DEL CONTADOR	35
■ REPRODUCCIÓN ESPECIAL	36
REPETICIÓN AUTOMÁTICA DE LA REPRODUCCIÓN	36
REPRODUCCIÓN DE VIDEOCASSETES DE ALQUILER	36
■ GRABACIÓN	36
VISIÓN Y GRABACIÓN DEL MISMO PROGRAMA	36
SALTO DURANTE LA GRABACIÓN	36
GRABACIÓN DE UN PROGRAMA MIENTRAS SE VE OTRO	36
PARA COMPROBAR EL PROGRESO DE SU GRABACIÓN	37
OTR (Grabación de un toque)	37
■ GRABACIÓN CON TEMPORIZADOR	37
GRABACIÓN AUTOMÁTICA CON TEMPORIZADOR	37
CONSEJOS PARA LA GRABACIÓN CON TEMPORIZADOR	38
RETORNO AUTOMÁTICO	38
■ COPIADO DE UNA VIDEOCINTA	38
■ VISUALIZACIÓN EN PANTALLA	38
■ FUNCIONES ESPECIALES	39
CONTADOR DE CINTA DE TIEMPO REAL	39
REBOBINADO AUTOMÁTICO	39
■ MANTENIMIENTO	39
■ GUÍA PARA LOCALIZACIÓN Y SOLUCIÓN DE PROBLEMAS	39

FEATURES

- **Bilingual on-screen menu display selectable in English or Spanish**
- **Infrared remote control**
- **Real time tape counter**– This shows the elapsed recording or playback time in hours, minutes, and seconds. (Does not work in blank areas of the tape)
- **181 channel capability PLL frequency synthesizer tuner with direct station call**– (A converter may be necessary to view scrambled cable channels.)
- **Auto power on and off system**– Automatically turns the VCR when you insert the cassette, turns off after auto-rewind, and ejects when the beginning of the tape is reached.
- **Auto counter reset**– (Automatically resets tape counter "0:00:00" when a tape is inserted.)
- **Auto rewind when the end of a tape is reached**– (Does not occur when using the timer recording).
- **Direct Button Operation**– When a tape is in the VCR and the power is off, just press the PLAY, REW or F.FWD button on the main unit and it will automatically turn on the VCR and perform the desired function. (Does not occur when using the timer recording).
- **2 Step Picture Search Operation**– You can view a video program at a high speed or super high speed in either a forward or reverse direction in LP and SLP mode.
- **Three different playback tape speeds : SP/LP/SLP**
- **Two different recording tape speeds : SP/SLP**
- **Still**– "Freeze" the picture at any time, for close viewing of a particular scene. Only tapes recorded in SLP mode will show a fairly clear picture.
- **Digital Auto Tracking (DTR)**– Automatically adjusts the tracking for each tape you play.
- **Auto Repeat**– Allows you to repeat a tape indefinitely without pressing the PLAY button.
- **Rental Play Mode**– Improves playback picture quality of worn tapes, such as rental tapes.
- **OTR (One Touch Recording)**– Instant timed recording for 30 to 480 minutes is possible at the push of the REC/OTR button.
- **1 Year, 7 events (including Daily and Weekly Timer Recording)**– The built-in timer allows you to record up to 7 programs at different times on different channels up to 1 year in advance. The daily timer allows recordings to be made of daily broadcasts from Monday through Friday, and the weekly timer allows recording to be made once a week up to the end of the tape.
- **Auto Return**– After timer recording is finished, the VCR can return to the beginning of the recording automatically.
- **Auto Head Cleaner**– Automatically cleans video heads as you insert or remove a cassette.
- **Timer Program Extension**– Allows you to shift the time schedule of an one time program for timer recording.

SUPPLIED ACCESSORIES

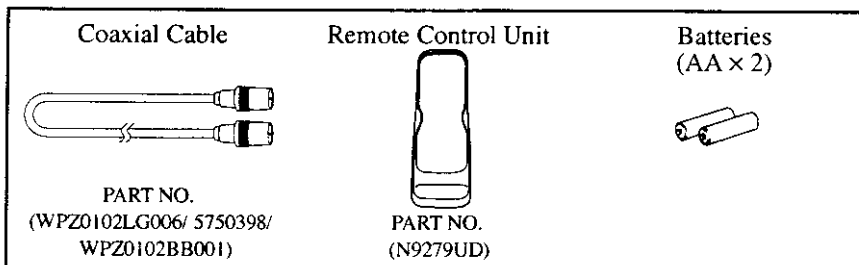

- If you need to replace these accessories, please refer to the PART NO. under the illustrations and call 1-800-242-7158.
- Depending on your antenna system, you may need different types of Combiners (Mixer) or Separators (Splitter). Contact your local electronics store for these items.
- We do not recommend the use of universal remote controls. Not all of the functions may be controlled with a universal remote control.
If you decide to use a universal remote control with this unit, please be aware that the code number given may not operate this unit. In this case, please call the manufacturer of the universal remote control.

VIDEO CASSETTE TAPE INFORMATION

This VCR will operate with any cassette that has the **VHS** mark. For best results, we recommend the use of high-quality tapes. Do not use poor quality or damaged tapes.

PRECAUTIONS

- Avoid moisture. Moisture condensation may occur on the tape if it is moved from a cold place to a warm place or visa versa. Before using a tape with these conditions, to avoid damage of the tape and your VCR, wait until the tape has warmed to room temperature and the moisture has evaporated.
- Avoid extreme heat, high humidity and magnetic fields.
- Do not tamper with the cassette mechanism.
- Do not touch the tape with your fingers.

TWO DIFFERENT TAPE SPEEDS

Before recording, select the tape speed from : **SP mode** (Standard Play) or **SLP mode** (Super Long Play).

The table below shows the maximum recording/playback time using T60, T120 or T160 tapes in each mode.

Tape Speed	Recording/Playback Time			
	Type of tape	T60	T120	T160
SP mode		1 hour	2 hours	2-2/3 hours
SLP mode		3 hours	6 hours	8 hours

Note: You can play back a tape recorded in LP mode (Long Play).

INSERTING A CASSETTE

Insert the cassette in the direction as shown. Push in gently, but continuously, on the center-back of the cassette until it is drawn into the VCR.

The VCR will automatically turn on.

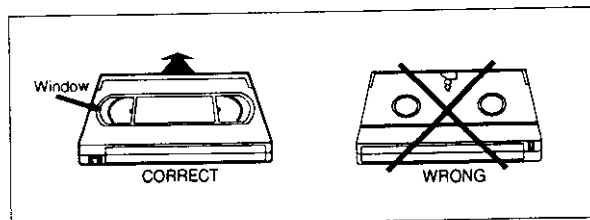

REMOVING A CASSETTE

- 1) In the Stop mode, press the EJECT button on the remote control or press the STOP/EJECT button on the VCR. The cassette will be ejected.
- 2) Pull the cassette out of the cassette compartment.
- 3) Store the cassette in its case as shown.

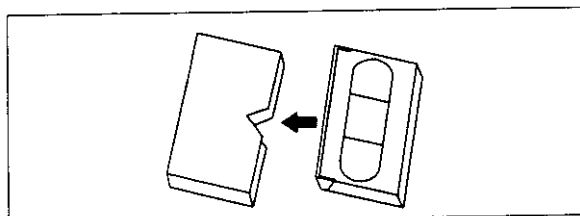

ERASE PREVENTION

You can prevent accidental erasing of a recording by breaking off the tab on the back edge of the cassette.

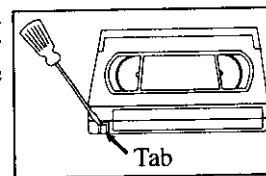

If you decide to record on the tape again, cover the hole with plastic tape.

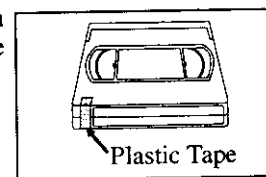

OPERATING CONTROLS AND FUNCTIONS

NOTES:

- Some controls are located on both the VCR and on the remote control, some are only located on one, some controls operate certain functions only in one location. See each description for details.
- We do not recommend the use of universal remote controls. Not all of the functions may be controlled with a universal remote control.
If you decide to use a universal remote control with this unit, please be aware that the code number given may not operate this unit. In this case, please call the manufacturer of the universal remote control.

—VCR FRONT PANEL—

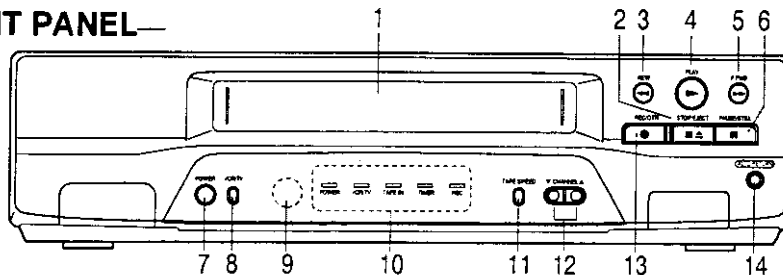

—REMOTE CONTROL—

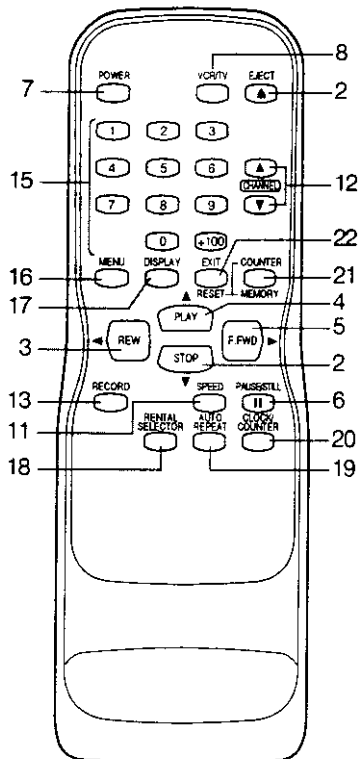

1. Cassette Compartment

2. EJECT button— Press to remove the tape from the VCR.

STOP button— Press to stop the tape motion.

▼ button— Press to enter digits when setting program (For example: setting clock or timer program). Press to select setting modes from on screen menu. (only on the remote control)

3. REW button— Press to rewind the tape, or to view the picture rapidly in reverse during the playback mode. (Rewind Search)

◀ button— Press to cancel a setting of timer program. Press to correct digits when setting program (For example: setting clock or timer program). Press to add or delete channel numbers during channel preset. (only on the remote control)

4. PLAY button— Press to begin playback.

▲ button— Press to enter digits when setting program (For example: setting clock or timer program). Press to select setting modes from on screen menu. (only on the remote control)

5. F.FWD button— Press to rapidly advance the tape, or view the picture rapidly in forward during playback. (Forward Search)

▶ button— When setting program (For example: setting clock or timer program), press to determine your selection and proceed to the next step you want to input. Press to determine setting modes from on screen menu. Press to add or delete channel numbers during channel preset. (only on the remote control)

6. PAUSE/STILL button— Press to temporarily stop the tape during recording or to view a still picture during playback.

7. POWER button— Press to turn VCR on and off. Press to activate timer recording.

8. VCR/TV button— Press to select TV or VCR mode.

VCR position: to view playback, to monitor video recordings or watch TV using the VCR tuner.

TV position: to watch TV or to view one program while recording another.

—REAR VIEW—

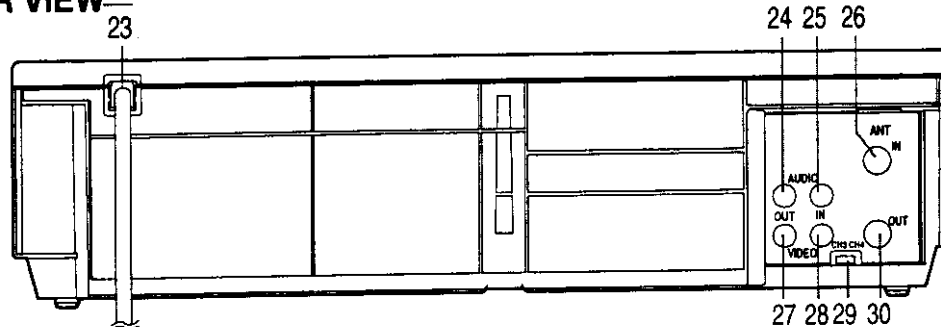

9. **Remote sensor window**— Receives the infrared signals from the remote control.
10. **Indicators**
 - POWER indicator**— Indicates that the power is turned on.
 - VCR/TV indicator**— Indicates that the VCR is in the VCR position.
 - TAPE IN indicator**— Indicates that there is a tape in the VCR.
 - TIMER indicator**— Indicates that the timer recording or OTR has been set.
 - REC indicator**— Indicates that it is recording. Flashes when a recording has been paused.
11. **TAPE SPEED button**— Press to choose the desired recording speed : SP/SLP.
12. **CHANNEL buttons**— Press to select the desired channels for viewing or recording.
 - Tracking function**— Press to minimize video 'noise' (lines or dots on screen) during playback. (only on the VCR)
 - Press to stabilize the picture in the Still mode when the picture begins to vibrate vertically.
13. **RECORD button**— Press for manual recording.
 - OTR button**— Activates One Touch Recording. (only on the VCR)
14. **AUTO RETURN button**— Rewinds to the beginning of the timer recording. (only on the VCR)
15. **NUMBER buttons**— Press to select desired channels for viewing or recording. To select channels from 1 to 9, first press "0" button then 1 to 9.
 - +100 button**— When selecting cable channels which are higher than 99, press this button first, then press the last two digits. (To select channel 125, first press "+100" button then press "2" and "5").
16. **MENU button**— Press to display the menus on the TV screen. Press to exit the menus on the TV screen. (only on the remote control)
17. **DISPLAY button**— Displays the counter or the current channel number and the current time on the TV screen. (only on the remote control)
18. **RENTAL SELECTOR button**— Press to set the Rental Play mode on and off during playback. (only on the remote control)
19. **AUTO REPEAT button**— Press to repeat playback automatically. (only on the remote control)
20. **CLOCK/COUNTER button**— Press to display or alternate between clock and counter on the TV screen. (only on the remote control)
21. **COUNTER MEMORY button**— Press to set counter memory on and off. (only on the remote control)
22. **COUNTER RESET button**— Press to reset counter to 0:00:00. (only on the remote control)
 - EXIT button**— Press to exit the menus on the TV screen. (only on the remote control)
23. **Power cord**— Connect to a standard AC outlet (120V/60Hz).
24. **AUDIO OUT jack**— Connect to the audio input jack of your audio equipment or another VCR.
25. **AUDIO IN jack**— Connect to the audio output jack of your audio equipment or another VCR.
26. **ANT. IN terminal**— Connect to an antenna, CATV or Satellite system.
27. **VIDEO OUT jack**— Connect to the video input jack of your video camera or another VCR.
28. **VIDEO IN jack**— Connect to the video output jack of your video camera or another VCR.
29. **CH3/CH4 selector switch**— Use to select a video output channel (3 or 4) for VCR playback.
30. **ANT. OUT terminal**— Connects to the antenna input terminal on your TV.

PREPARATION FOR USE

ANTENNA/CABLE CONNECTIONS

For some of the most common types of connections, please follow the drawings below. Use only one connection. For any further complex connections, please contact your local dealer or other qualified persons. (You may need additional accessories which are not supplied).

- 1 Disconnect the antenna or cable from your TV.
- 2 Connect the antenna or cable to the ANT.IN (Top jack) of your VCR.
- 3 Connect one end of the coaxial cable (supplied) to the ANT.OUT (Bottom jack) of your VCR.
- 4 Connect the other end of the coaxial cable (supplied) to the UHF/VHF antenna jack of your TV.

Fig.1: Indoor Antenna

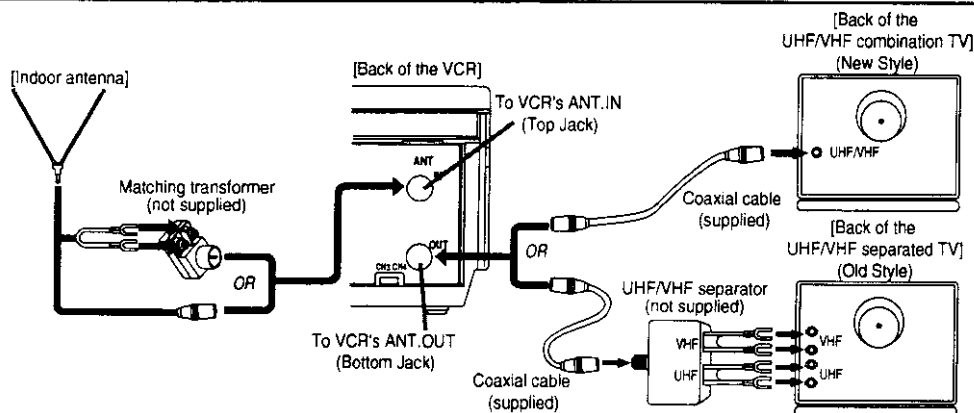

You can record one channel while viewing another. The same goes for Automatic Timer Recording and One Touch Recording. For details, please refer to "Recording" on page 20.

Note: The connection of an indoor antenna with a VCR may not always give acceptable TV reception.

Fig.2: VHF/UHF Combination Antenna or Cable from the Cable Company

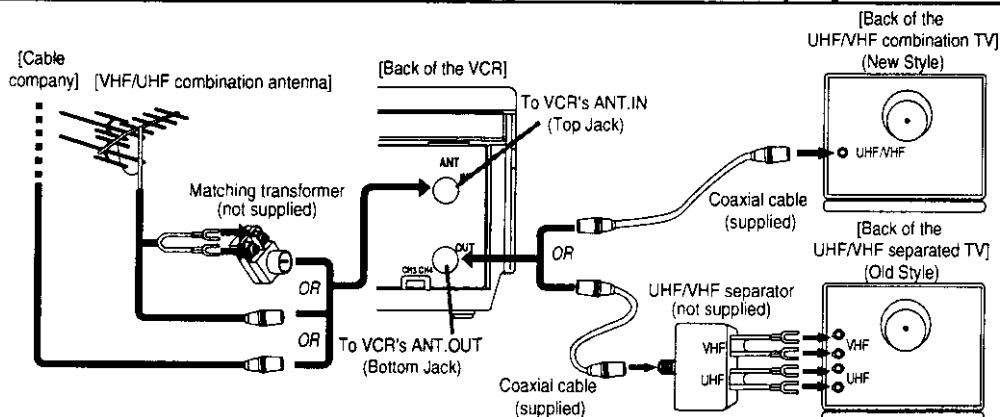

You can record one channel while viewing another. The same goes for Automatic Timer Recording and One Touch Recording. For details, please refer to "Recording" on page 20.

Continued on the next page.

Fig.3: VHF/UHF Separate Antenna

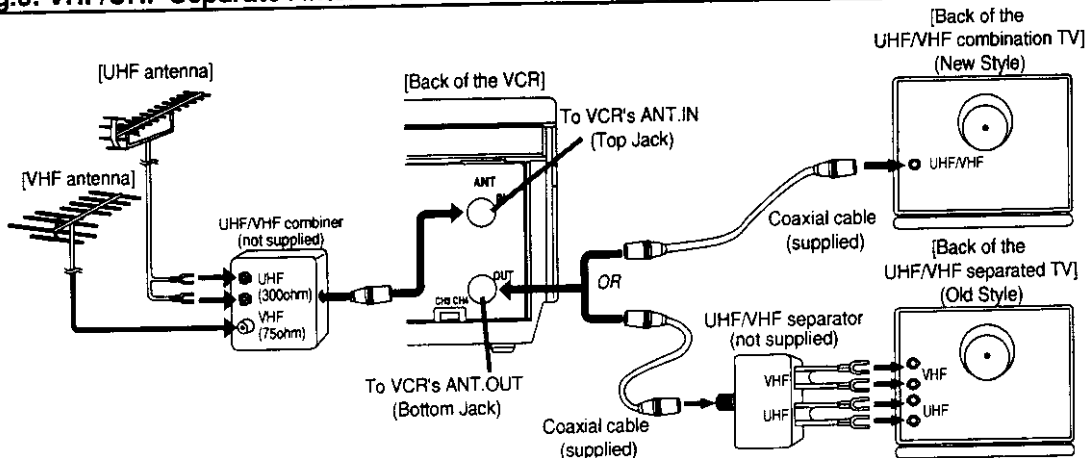

You can record one channel while viewing another. The same goes for Automatic Timer Recording and One Touch Recording. For details, please refer to "Recording" on page 20.

Fig.4: Cable Box and Satellite Box

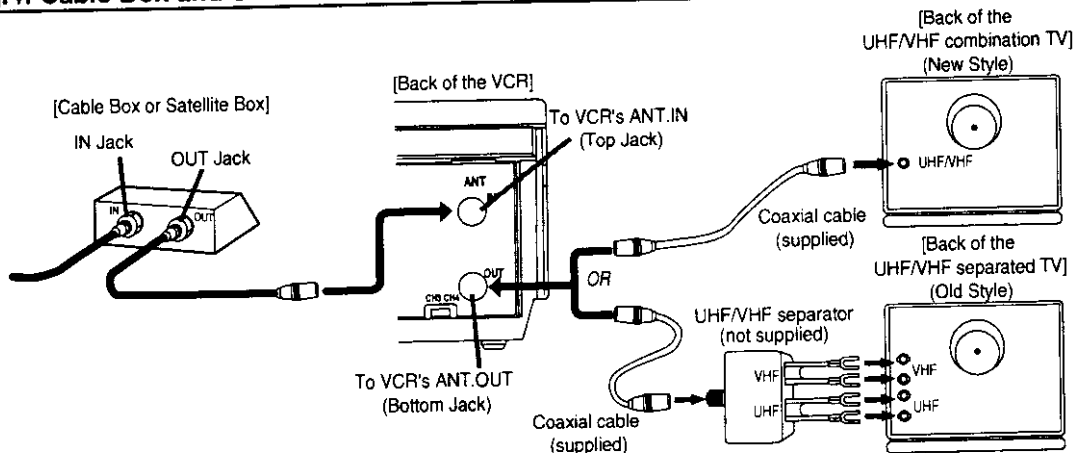

You can ONLY record and view the SAME channel when using this connection. There are no exceptions. The same goes for Automatic Timer Recording and One Touch Recording.

Note: Channel memory programming is NOT needed when using this connection.

RECORDING HINT

- 1) Be sure to check the POWER and the VCR/TV indicators are on.
- 2) Turn on the TV and Cable Box.
- 3) Set the channel to be recorded on the Cable Box.
- 4) Set the TV and VCR to channel 3 or 4.
- 5) Set the CH3/CH4 switch on the back of the VCR to match the channel set on the TV and VCR.
- 6) Press the RECORD button. For AUTOMATIC TIMER RECORDING, the VCR must stay on channel 3 or 4 at step [9] on page 23.

Continued on the next page.

Some customers with cable boxes may record one channel and view another, with either one of the connections below.

Satellite systems: Neither one of these connection will work. For satellite owner wishing to record one channel and view another, please contact the manufacture of the satellite system.

Fig.5:

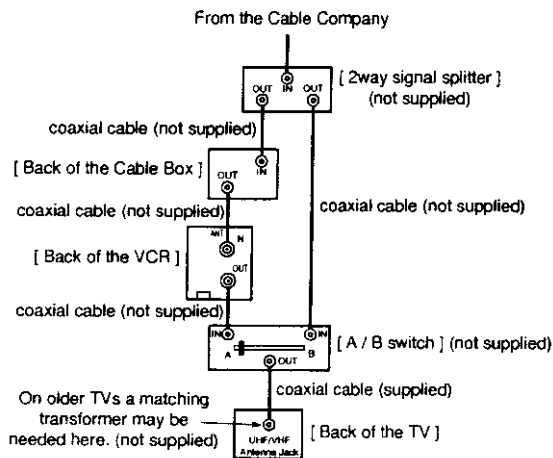

You can record a scrambled channel while viewing another.

RECORDING HINT

- 1) Be sure to check the POWER and the VCR/TV indicators are on.
- 2) Turn on the TV and Cable Box.
- 3) Set the channel to be recorded on the Cable Box.
- 4) Set the TV and VCR to channel 3 or 4.
- 5) Set the CH3/CH4 switch on the back of the VCR to match the channel set on the TV and VCR.
- 6) Press the RECORD button. For AUTOMATIC TIMER RECORDING, the VCR must stay on channel 3 or 4 at step [9] on page 23.
- 7) Set the A-B switch to the other side. For AUTOMATIC TIMER RECORDING, set the A-B switch to the other side after step [12] on page 23.
- 8) Select the channel to be viewed on the TV.

Note: If you wish to view what you are recording or play a tape with this connection, make sure the A-B switch is on the correct side.

Fig.6:

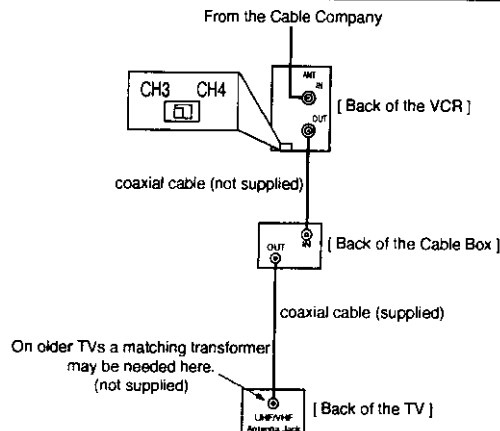

This connection is good only if none of your channels are scrambled. You can record one channel while viewing another.

RECORDING HINT

- 1) Be sure to check the POWER and the VCR/TV indicators are on.
- 2) Turn on the TV and Cable Box.
- 3) Set the channel to be recorded on the VCR.
- 4) Set the TV and Cable Box to channel 3 or 4.
- 5) Set the CH3/CH4 switch on the back of the VCR to match the channel set on the TV.
- 6) To view ONE channel while recording ANOTHER, the VCR/TV indicator must be off.
Or for AUTOMATIC TIMER RECORDING, the VCR/TV indicator must be off after step [11] on page 23.
- 7) Set the channel to be viewed on the Cable Box.

Note: If you wish to view what you are recording or play a tape with this connection, the VCR/TV indicator must be turned on and the Cable Box channel must match the channel selected on the back of the VCR. (CH 3 or 4)

Note to CATV system installer

This reminder is provided to call the CATV system installer's attention to Article 820-40 of the NEC that provides guidelines for proper grounding and, in particular, specifies that the cable ground shall be connected to the grounding system of the building, as close to the point of cable entry as practical.

SETTING THE CH3/CH4 SWITCH

If your TV does not have A/V terminals:

When the VCR is in the Playback mode or when the VCR is in the VCR position, your TV will receive signals from the VCR on either channel 3 or 4.

To use the VCR with your TV, set the selector switch to CH3 or CH4 (which is located in the back of your VCR), whichever is not used for normal broadcasts in your area. Then set your TV to the same channel.

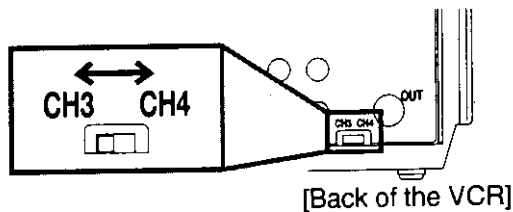

CONNECTING TO INPUT JACKS

When you copy a video tape, or watch a program recorded on another source, use the audio/video input jacks.

Fig.7:

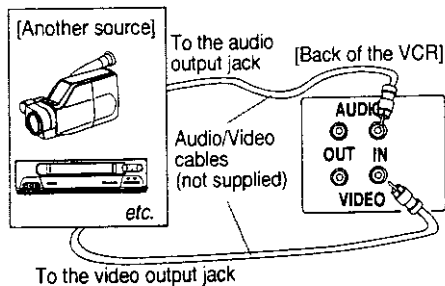

INPUT SELECT

- 1) Be sure to check the POWER and the VCR/TV indicators are on.
- 2) Turn on the TV and set the TV to channel 3 or 4. Now set the switch on the back of the VCR to match the channel selected on the TV.
- 3) Connect the audio/video cables to the audio/video input jacks on the back of the VCR. Now connect the other end of the cables to the audio/video output jacks on the source.
- 4) Press the CHANNEL ▲ or ▼ button to select "AUX", which will appear on the TV screen.

You may also select the "AUX" setting by pressing "00" with the number buttons on the remote control.

Note: "AUX" is found before the lowest memorized channel. (Example: CH2)

A/V TERMINALS

If your TV has A/V input jacks, you may connect your VCR's AUDIO/VIDEO OUTPUT jacks to the audio/video input jacks on back of your TV.

Direct audio/video connections usually result in a better picture and sound quality for tape playback. Please see your TV's owner's manual for A/V input connections.

Fig.8:

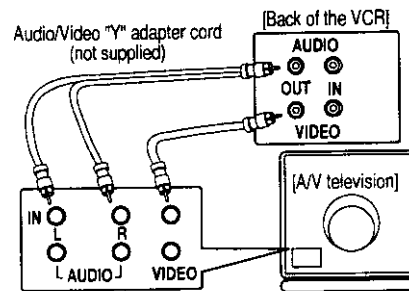

INSTALLING THE BATTERIES

- 1) Open the battery compartment cover by pressing the cover on the remote unit in the direction of the arrow.
- 2) Insert 2 "AA" penlight batteries into the battery compartment in the direction indicated by the polarity (+/-) markings.
- 3) Replace the cover.

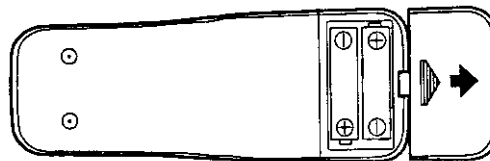

SET UP FOR USE

You can program the tuner to scan only the channels you receive in your area. You must use the remote control for this procedure.

NOTES:

- Channel memory programming is **NOT** needed when connected to a cable box or satellite box as in Fig 4 on page 11 or Fig 5 on page 12. In this case with your remote, select the VCR to channel 3 or 4 the same channel as located on the back of VCR (CH3 or CH4). Then the channel you wish to record or view may be selected on the cable box or satellite box.
- Follow the steps below once. Repeat it only if there is a power failure or if the VCR is unplugged for more than 30 seconds. (In these cases, the programmed channels are erased.)
- You must follow the steps below before attempting to play or record a video tape. If you want to play or record a video tape **BEFORE** programming the tuner, you must first turn off the VCR. Then, press the POWER button again to turn it back on. To program the tuner again, see "CHANNEL SET UP AGAIN" on page 16.

CHANNEL SET UP (Automatic)

1 Plug in the VCR power cord

Plug the VCR power cord into a standard AC outlet.

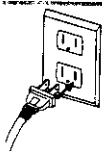

Remember: If your cable box or satellite box is connected as in Fig 4 on page 11 or Fig 5 on page 12, you **DO NOT** have to set up the channels. Just select the TV and VCR to channel 3 or 4 and also have the CH3/CH4 switch on the back of the VCR to match the channel you selected (CH 3 or CH 4). Now select the Box to the channel you wish to view or record.

2 Select channel 3 or 4 on the TV

Turn on the TV and set the TV to channel 3 or 4. Now set the CH3/CH4 switch on the back of the VCR to match the channel selected on the TV.

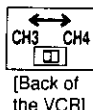

3 Turn on the VCR

Press the POWER button to turn on the VCR. Both the POWER indicator and the VCR/TV indicator on the VCR come on.

- Use the remote control for this procedure.



4 Select "ENGLISH" or "ESPAÑOL"

Select "ENGLISH" or "ESPAÑOL"=Spanish using the PLAY/▲ or STOP/▼ button.

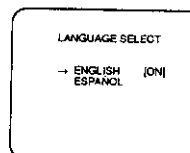

Then, press the F.FWD/▶ button.

Note: This function effects only the language on the screen menu and not the audio source.

5 Begin channel preset

Press the F.FWD/▶ button once. The tuner scans and memorizes all active channels in your area.

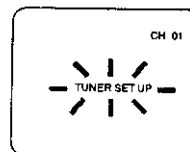

- The VCR distinguishes between standard TV channels and cable channels.

6 After scanning

The tuner stops on the lowest memorized channel. The TV screen returns to TV mode.

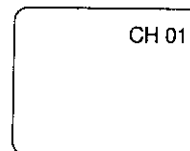

- If "TUNER SET UP" appears on the TV screen again, check the cable connections. Press the F.FWD/▶ button once again and the VCR will begin preset again.

TO SELECT A DESIRED CHANNEL

You can select the desired channel by using the CHANNEL ▲ or ▼ button or directly pressing number buttons on the remote control.

Note for using number buttons:

- When selecting cable channels which are higher than 99, press the +100 button first, then press the last two digits. (Example: to select channel 125, first press the +100 button then press "2" and "5").
- You must precede single-digit channel numbers with a zero (For example: 02, 03, 04 and so on).

CLOCK SET UP

Set the clock accurately for proper automatic timer recording. We suggest that you use a TV or radio station as your time source.

In the example below, the clock is to be set to:

DATE March 1st, 1999
SETTING TIME 5:40PM

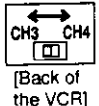
- Use the remote control for this procedure. 
- When the VCR is in the Menu mode, the following buttons only work (PLAY/▲, F.FWD/▶, REW/◀, STOP/▼, RESET/EXIT, POWER and MENU).
- Be sure to check the POWER and the VCR/TV indicators are on.
- Turn on the TV and set the TV to channel 3 or 4. Now set the CH3/CH4 switch on the back of the VCR to match the Channel selected on the TV.  [Back of the VCR]

1 Select "SETTING CLOCK"

Press the MENU button. The SETTING CLOCK menu appears.

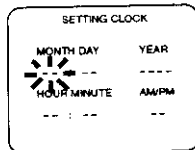

- The number buttons on the remote control do not work in this Menu mode.
- When you press the F.FWD/▶ button during steps [2] to [6], you may forward to next step.
- Press the REW/◀ button to go back one step from current step during steps [3] to [7].

2 Select the month

Press the PLAY/▲ or STOP/▼ button repeatedly until the desired month appears. (Example: March → 03)

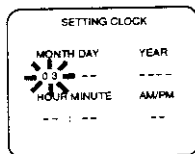

Then, press F.FWD/▶ button.

3 Select the day

Press the PLAY/▲ or STOP/▼ button repeatedly until the desired day appears. (Example: 1st → 01)

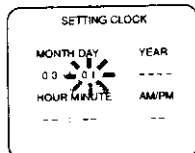

Then, press the F.FWD/▶ button.

4 Select the year

Press the PLAY/▲ or STOP/▼ button until the desired year appears. (Example: 1999)

Then, press the F.FWD/▶ button.

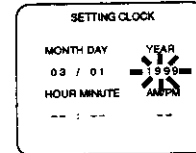

5 Select the hour

Press the PLAY/▲ or STOP/▼ button until the desired hour appears. (Example: 05)

Then, press the F.FWD/▶ button.

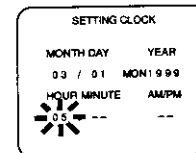

6 Select the minute

Press the PLAY/▲ or STOP/▼ button until the desired minute appears. (Example: 40)

Then, press the F.FWD/▶ button.

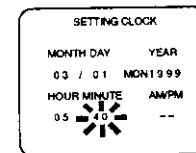

7 Select "AM" or "PM"

Press the PLAY/▲ or STOP/▼ button to point to "AM" or "PM". (Example: PM)

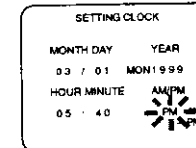

8 Start the clock

Press the RESET/EXIT or F.FWD/▶ button.

Although seconds are not displayed, they begin counting from 00 when you press the RESET/EXIT or F.FWD/▶ button. Use this feature to synchronize the clock with the correct time.

- When unplugging the AC-cord or if there is a power failure for more than 30 seconds, you may have to reset the clock.
- If the display shows an abnormal reading or no reading, unplug the power cord for more than 30 seconds. Then plug it back in. And reset clock.

TO CHANGE CLOCK SETTING

1) Press the MENU button until the INITIALIZE menu appears.

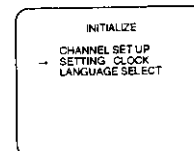

2) Press the PLAY/▲ or STOP/▼ button to point to "SETTING CLOCK". Then, press the F.FWD/▶ button.

3) Follow steps [2] to [8].



TO DELETE CHANNELS

The channels you no longer receive or seldom watch can be deleted from the memory. (Of course, you can later add the deleted channel into the memory again.)

- Use the remote control for this procedure. 
- Be sure to check the POWER and the VCR/TV indicators are on.
- Turn on the TV and set the TV to channel 3 or 4. Now set the CH3/CH4 switch on the back of the VCR to match the channel selected on the TV.  [Back of the VCR]

1 Select "INITIALIZE"

Press the MENU button until the INITIALIZE menu appears.

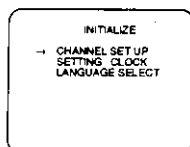

2 Select "CHANNEL SET UP"

Confirm "CHANNEL SET UP" is pointed to, then press the F.FWD/▶ button.

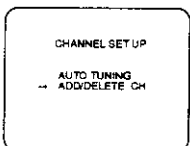

3 Select "ADD/DELETE CH"

Press the PLAY/▲ or STOP/▼ button to point to "ADD/DELETE CH". Then, press the F.FWD/▶ button.



4 Enter the desired channel number

Press the number buttons or the PLAY/▲ or STOP/▼ button until your desired channel number appears. (Example: CH02)

5 Delete it from memory

Press the F.FWD/▶ or REW/◀ button so that "DELETE" flashes on the TV screen.

- To delete another channel, repeat steps [4] and [5].
- If you press the F.FWD/▶ or REW/◀ button again, the channel is memorized again.

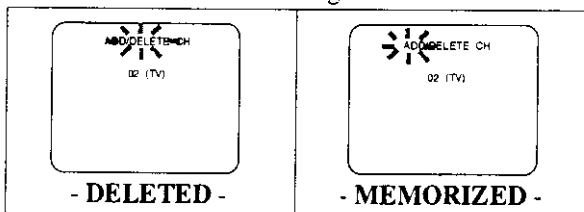

6 Exit the preset mode

Press the RESET/EXIT button to return to TV mode.

NOTE: To confirm that channel(s) has been deleted or added, press the CHANNEL ▲ or ▼ button.

CHANNEL SET UP AGAIN

Remember: If your cable box or satellite box is connected as in Fig 4 on page 11 or Fig 5 on page 12, you **DO NOT** have to set up the channels. Just select the TV and VCR to channel 3 or 4 and also have the CH3/CH4 switch on the back of the VCR to match the channel you selected (CH 3 or CH 4). Now select the Box to the channel you wish to view or record.

- Use the remote control for this procedure. 

1) Press the MENU button until the INITIALIZE menu appears.

2) Confirm "CHANNEL SET UP" is pointed to, then press the F.FWD/▶ button.

3) Confirm "AUTO TUNING" is pointed to, then press the F.FWD/▶ button. After scanning, the tuner stops at the lowest memorized channel.

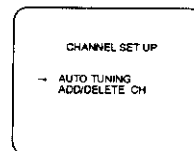

- The VCR distinguishes between standard TV channels and cable channels.

SELECTING THE LANGUAGE

If you want to change the language on the TV screen, follow the steps below:

Note: This function effects only the language on the screen menu and not the audio source.

- Use the remote control for this procedure. 

1) Press the MENU button until the INITIALIZE menu appears.

2) Press the PLAY/▲ or STOP/▼ button to point to "LANGUAGE SELECT". Then, press the F.FWD/▶ button.

3) Select "ENGLISH" or "ESPAÑOL"= Spanish using the PLAY/▲ or STOP/▼ button.

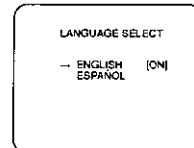

4) Press the RESET/EXIT button to return to TV mode.

NOTE: If for some reason the menu is in Spanish, press the MENU button until "PARAINICIAR" menu appears, press the PLAY/▲ button to point to "SELEC. IDIOMA", press the F.FWD/▶ button, press the PLAY/▲ button to point to "ENGLISH", then press the RESET/EXIT button.

PLAYBACK

NORMAL PLAYBACK

- Be sure to check the POWER and the VCR/TV indicators are on.
- Turn on the TV and set the TV to channel 3 or 4. Now set the CH3/CH4 switch on the back of the VCR to match the channel selected on the TV.

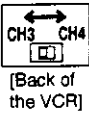

1 Insert a prerecorded tape

Counter mode appears at counter 0:00:00 on the TV screen. If the erase-protection tab has been removed, the VCR will start playback automatically.

2 To begin playback

Press the PLAY button.



NOTE: If any menu is activated on the TV screen, the PLAY button on the remote control does not function. Press the RESET/EXIT button to clear the menu. Then, press the PLAY button.

If a tape is already in the VCR with power off

2A) Using button on the VCR

Just press the PLAY button on the VCR. Power will automatically turn on and playback will start. (Direct Button Operation)

2B) Using button on the remote control

Press the POWER button to turn on the VCR, and then press the PLAY button on the remote control.

3 To stop playback

Press the STOP button.

PICTURE SEARCH

This feature is very useful in finding or skipping over a particular scene on a tape. In this mode, the sound will be muted.

- 1) You may view a video tape at a high speed in either a forward or reverse direction by pressing the F.FWD or REW button. (in the SP / LP / SLP modes)
- 2) Press it again and the VCR will now search in super high speed. (in the LP / SLP modes only)
- 3) Press the PLAY button to return to normal speed.

STILL PICTURE

You can view a still picture on the TV screen during playback (the Still mode). Press the PAUSE/STILL button during playback. Press the PLAY button to return to playback.

- Usually there will be video "noise" lines (black and white streaks or dots) on the screen. This is normal.

If the tape was originally recorded in SP or LP mode, the still picture will, in addition to the "noise" lines, be black and white.

This is not a fault of the machine but merely a by-product of the technology involved in producing a 2 Head VCR with SP and LP mode.

- If it is left in the Still mode for more than five minutes, the VCR will automatically switch to the Stop mode.

NOISE CANCEL (in the Still mode)

This feature allows you to reposition or reduce the noise lines of a still picture.

Press the PAUSE/STILL button repeatedly so that the noise lines change position on the screen and you can see the picture in its entirety without distracting noise lines.

NOTE: This feature can be activated ONLY when you use a tape recorded in the SLP mode.

VERTICAL HOLD CONTROL

In the Pause/Still mode only, when the picture begins to vibrate vertically, stabilize the picture by pressing the CHANNEL ▲ or ▼ button.

NOTES:

- If there are video noise lines on the screen, reposition or reduce them. Refer to "NOISE CANCEL" on page 17.
- If the picture is distorted or rolling vertically, adjust vertical hold control on your TV.
- Most newer TV's do not have a user adjustable vertical hold control.

TRACKING ADJUSTMENT

- Tracking adjustment will be set automatically (Digital Tracking function) when you start playback. However when playing pre-recorded tapes or tapes recorded on units other than your own, noise lines (black and white streaks) may appear on the playback picture. If this occurs, you can adjust the tracking control manually by pressing the CHANNEL ▲ or ▼ button on the VCR until the streaks disappear. To return to the DTR function, stop the tape once and start playback again.

COUNTER MEMORY

Use this feature to memorize the beginning point that you want to return to. And you can search it easily by rewinding or fast forwarding.

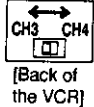
- Use the remote control for this procedure. 
- Be sure to check the POWER and the VCR/TV indicators are on.
- Turn on the TV and set the TV to channel 3 or 4. Now set the CH3/CH4 switch on the back of the VCR to match the channel selected on the TV. 
- This feature only works with a prerecorded tape.

1 Stop tape at your desired point

Insert a prerecorded tape. Rewind or fast forward the tape to the beginning point at which you want to mark.

2 Reset the counter to 0:00:00

Press the COUNTER RESET button on the remote control. If necessary press the COUNTER RESET button again to reset the counter to 0:00:00.

3 Select the Counter Memory mode

Press the COUNTER MEMORY button on the remote control so that "M" appears on the TV screen.



- The COUNTER MEMORY button does not function if the Auto Repeat mode is set to [ON]. In this case, set the Auto Repeat mode to [OFF].

4 Begin recording or playback

Press the RECORD or PLAY button.

Press the STOP button when recording or playback is completed.

5 To activate the Counter Memory

Press the REW (or F.FWD) button, the VCR will stop automatically when the counter has returned to approximately 0:00:00.

NOTE: The displayed time will not change during blank portions on the tape.

TO EXIT THE COUNTER MEMORY

Press the COUNTER MEMORY button on the remote control so that "M" disappears from the TV screen.

On more information concerning the display, please refer to page 25.

SPECIAL PLAYBACK

- Use the remote control for the following procedure. 
- Be sure to check the POWER and the VCR/TV indicators are on.

- Turn on the TV and set the TV to channel 3 or 4. Now set the CH3/CH4 switch on the back of the VCR to match the channel selected on the TV.

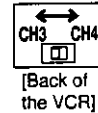

AUTO REPEAT PLAYBACK

The VCR has the auto repeat function that allows you to repeat a tape indefinitely without touching the PLAY button.

Make sure to insert a prerecorded tape.

1 Select "VCR SET UP"

Press the MENU button until the VCR SET UP menu appears.

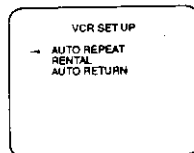

2 Select "AUTO REPEAT"

Confirm "AUTO REPEAT" is pointed to.

3 Begin Auto repeat playback

Press the F.FWD/▶ button so that [ON] will appear next to "AUTO REPEAT" on the TV screen.

When in Stop mode, Repeat playback mode will start automatically.

If the on-screen menu still remains, press the RESET/EXIT button to exit the menu.

- You may also select Auto Repeat play mode by pressing the AUTO REPEAT button on the remote control.
- Once you select the Auto Repeat mode, it stays in effect even after you turn off the VCR.
- The COUNTER MEMORY button does not function if the Auto Repeat mode is set to [ON]. In this case, set the Auto Repeat mode to [OFF].
- To stop playback, press the STOP button.

TO EXIT THE AUTO REPEAT MODE

- Repeat steps [1] to [2], and press the F.FWD/▶ button. [ON] will then disappear from the menu. Then, press the RESET/EXIT button to return to TV mode.
- Or, press the AUTO REPEAT button again.

Power failure: If there is a power failure for more than 30 second, Auto Repeat Playback will go to off.

RENTAL PLAYBACK

This function enables you to improve the picture quality when playing back worn cassettes such as rented tapes.

- Selecting ON or OFF must be done during playback.

1 Insert rental tape into VCR

Begin playback.

2 Select "VCR SET UP"

Press the MENU button until the VCR SET UP menu appears.

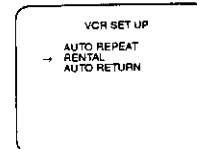

3 Select "RENTAL"

Press the PLAY/▲ or STOP/▼ button to point to "RENTAL".

4 Select "RENTAL" to [ON]

Press the F.FWD/▶ button so that "RENTAL ON" appears.

- You may also set the Rental mode to ON or OFF by pressing the RENTAL SELECTOR button on the remote control **during playback**.
- Once you select the Rental mode, it stays in effect even after you turn off the VCR.
- To stop playback, press the STOP button.

TO EXIT THE RENTAL PLAY MODE

- Repeat steps [1] to [3], and press the F.FWD/▶ button so that "RENTAL OFF" appears.
- Or, press the RENTAL SELECTOR button **during playback** so that "RENTAL OFF" appears on the TV screen.

Power failure: If there is a power failure for more than 30 second, Rental Playback will go to off.

RECORDING

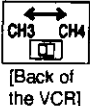
- Please refer to the connection you are using, through pages 10, 11, or 12 on "ANTENNA/CABLE CONNECTIONS" before continuing.
- Be sure to check the POWER and the VCR/TV indicators are on.
- Turn on the TV and set the TV to channel 3 or 4. Now set the CH3/CH4 switch on the back of the VCR to match the channel selected on the TV. 
- Insert a cassette tape with its erase prevention tab in place. (If necessary, rewind or fast forward the tape to the point at which you want to begin recording.)

VIEWING AND RECORDING THE SAME PROGRAM

- 1 Select the channel to be recorded

Press number buttons on the remote control or the CHANNEL ▼ or ▲ button.

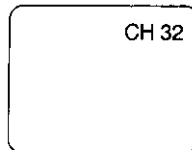

NOTE: If you have a cable box or satellite box connected to this VCR, please refer to "ANTENNA/CABLE CONNECTIONS" on pages 11 and 12 before proceeding to the next step.

- 2 Select the tape speed

Press the TAPE SPEED button to select the desired tape speed (SP/SLP).

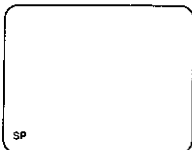

- 3 Begin recording

Press the RECORD button. The REC indicator on the VCR comes on.

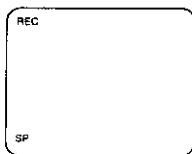

NOTE: If any menu is activated on the TV screen, the RECORD button on the remote control does not function. Press the RESET/EXIT button to clear the menu. Then, press the RECORD button.

- 4 Stop recording

Press the STOP button when recording is completed.

SKIPPING SOME MATERIALS DURING RECORDING

Press the PAUSE/STILL button to temporarily stop recording.

Press the PAUSE/STILL or RECORD button to resume recording.

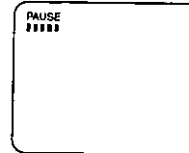

NOTE: When the VCR is in the Pause mode, you may review the time remaining with ■ marks on the TV screen. Each ■ mark represents one minute. After five minutes, the VCR will automatically switch to the Stop mode to prevent tape damage. When there is 1 minute remaining, one ■ will flash.

RECORDING ONE PROGRAM WHILE VIEWING ANOTHER

You can record one program while viewing another. To start recording, follow steps [1] to [3] under "VIEWING AND RECORDING THE SAME PROGRAM".

NOTE: If you have a cable box or satellite box connected to this VCR, please refer to "ANTENNA/CABLE CONNECTIONS" on pages 11 and 12 before proceeding to the next step.

- 4 Select the TV mode

Press the VCR/TV button to select TV so that the VCR/TV indicator on the VCR *disappears*.

- 5 Select the channel on the TV

Set the TV to the channel you want to watch.

TO MONITOR THE PROGRESS OF YOUR RECORDING

- 1) Press the VCR/TV button so that the VCR/TV indicator on the VCR comes on.
- 2) Turn on the TV and set the TV to channel 3 or 4. Now set the CH3/CH4 switch on the back of the VCR to match the channel selected on the TV.

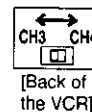

OTR (One Touch Recording)

This function enables you to set the recording length simply by pressing the REC/OTR button on the VCR.

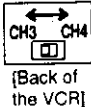
- Please refer to the connection you are using, through pages 10, 11, or 12 on "ANTENNA/CABLE CONNECTIONS" before continuing.
- You can not use the remote control for this function.
- Be sure to check the POWER and the VCR/TV indicators are on.
- Turn on the TV and set the TV to channel 3 or 4. Now set the CH3/CH4 switch on the back of the VCR to match the channel selected on the TV. 
- Insert a cassette tape with its erase prevention tab in place. (If necessary, rewind or fast forward the tape to the point at which you want to begin recording.)

PUSH(ES)	DISPLAY	RECORDED LENGTH
1 push	<i>(normal recording)</i>	
2 pushes	0:30	30 minutes
3 pushes	1:00	60 minutes
↓	↓	↓
17 pushes	8:00	480 minutes
18 pushes	<i>(normal recording)</i>	

NOTE: If you have a cable box or satellite box connected to this VCR, please refer to "ANTENNA/CABLE CONNECTIONS" on pages 11 and 12 before proceeding to the next step.

1 Select the channel to be recorded

Press number buttons on the remote control or the CHANNEL ▼ or ▲ button.

2 Select the tape speed

Press the TAPE SPEED button to select the desired tape speed (SP/SLP).

3 Begin OTR

Press the REC/OTR button on the VCR as many times as needed. The recording length will be determined by the number of times you press the REC/OTR button.

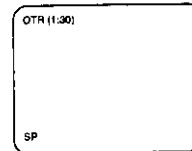

Each additional push will increase the recording time by 30 minutes. It can be set for up to 8 hours.

- Recording starts immediately when the REC/OTR button is pressed, whether you are watching the same or a different channel.
- When the REC/OTR button is pressed 18 times, the VCR returns to the normal recording mode.
- To stop the OTR operation, press the STOP button on the VCR or on the remote control.
- To show the remaining time, press the DISPLAY button on the remote control so that "OTR" appears on the TV screen. (It will show up momentarily then disappear.)
- Recording stops when 0:00 is reached.
- Please note that in the SLP mode maximum recording time, assuming the tape is started at the beginning, is 8 hours using T-160 (or 6 hours using T-120).
- The TV that is connected to your VCR may be turned on or off during OTR.
- If the tape runs out before the end time, the VCR will switch to the Stop mode immediately, eject the tape and turn power off.

TIMER RECORDING

AUTOMATIC TIMER RECORDING

You may set the VCR to start and end a recording while you are away. You can set seven programs to record on specific days, daily or weekly within a 1 year period.

In the example below, the timer is being set to record:

DATE: May 6th, 1999
 SETTING TIME: from 7:30PM to 8:30PM
 CHANNEL: CH16
 TAPE SPEED: SP
 PROGRAM NO: No. 1

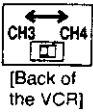
- Please refer to the connection you are using, through pages 10, 11, or 12 on "ANTENNA/CABLE CONNECTIONS" before continuing.
- Use the remote control for this procedure.
- Be sure to check the POWER and the VCR/TV indicators are on to program it.
- Turn on the TV and set the TV to channel 3 or 4. Now set the CH3/CH4 switch on the back of the VCR to match the channel selected on the TV. 
- Clock must be set to the correct time and date before setting the timer.
- Insert a cassette tape with its erase prevention tab in place. (If necessary, rewind or fast forward the tape to the point at which you want to begin recording.)

Avoid overlap of programs ...

There is a case that a program will not be performed. When programs overlap:

- The program with an earlier start time has priority.
- Once the earlier program finishes, the overlapping programs will begin recording in sequence.
- The illustration below demonstrates the sequence of recordings.

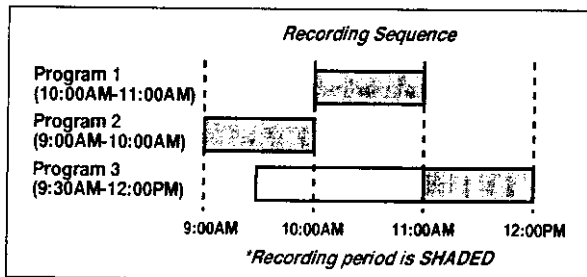

1 Select "TIMER PROGRAMMING"

Press the MENU button so that **TIMER PROGRAMMING** menu appears.

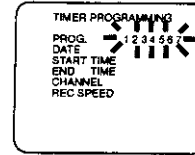

NOTE: If you have not yet set the clock, "SETTING CLOCK" appears. If so, follow the steps [2] to [8] on page 15. Then, set the timer recording.

2 Select your desired program number (1~7)

Program number which is not set up flashes.

Press the PLAY/▲ or STOP/▼ button until your desired program number appears. (Example: 1)

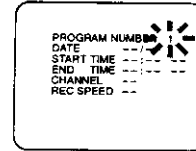

Then, press the F.FWD/▶ button.

3 Select once, daily or weekly recording

For once recording :

Press the PLAY/▲ or STOP/▼ button to point to "ONCE", and then press the F.FWD/▶ button.

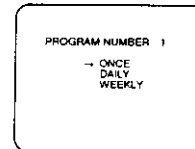

For daily recording : To record a TV program at the same time on the same channel from Monday through Friday.

Press the PLAY/▲ or STOP/▼ button to point to "DAILY", and then press the F.FWD/▶ button.

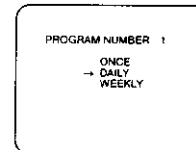

For weekly recording : To record a TV program at the same time on the same channel every week. (Example: every Monday on ch 7 at 5:00PM)

Press the PLAY/▲ or STOP/▼ button to point to "WEEKLY", and then press the F.FWD/▶ button.

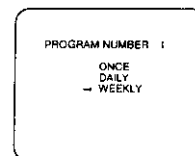

- When you press the F.FWD/▶ button during steps [4] to [10], you may move to the next step.
- Press the REW/◀ button to go back one step from the current step during steps [2] to [10].

4 Set the date when you want to start

First, press the PLAY/▲ or STOP/▼ button until the desired month appears.

(Example: "05" for May)

Then, press the F.FWD/▶ button.

Next, press the PLAY/▲ or STOP/▼ button until the desired day appears, and then press the F.FWD/▶ button. (Example: "06" for 6th)

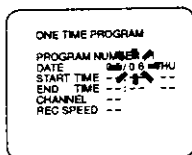

5 Set the start hour

Press the PLAY/▲ or STOP/▼ button until the desired hour appears. (Example: 07)

Then, press the F.FWD/▶ button.

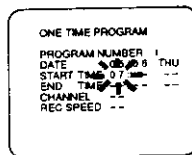

6 Set the start minute

Press the PLAY/▲ or STOP/▼ button until the desired minute appears. (Example: 30)

Then, press the F.FWD/▶ button.

Next, press the PLAY/▲ or STOP/▼ button to point to "AM" or "PM". (Example: PM) Then, press the F.FWD/▶ button.

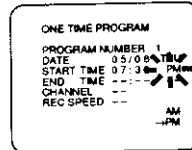

7 Set the end hour

Press the PLAY/▲ or STOP/▼ button until the desired hour appears. (Example: 08)

Then, press the F.FWD/▶ button.

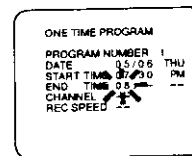

8 Set the end minute

Press the PLAY/▲ or STOP/▼ button until the desired minute appears. (Example: 30) Then, press the F.FWD/▶ button.

Next, press the PLAY/▲ or STOP/▼ button to point to "AM" or "PM". (Example: PM) Then, press the F.FWD/▶ button.

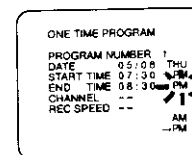

9 Set the channel number

Press the PLAY/▲ or STOP/▼ button until the desired channel number appears. (Example: 16)

Then, press the F.FWD/▶ button.

- Remember refer to "ANTENNA/CABLE CONNECTIONS" on pages 11 and 12 if you have a cable box or satellite box before setting the channel number.

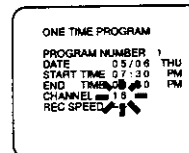

10 Set the tape speed

Press the PLAY/▲ or STOP/▼ button until the desired tape speed appears. (Example: SP)

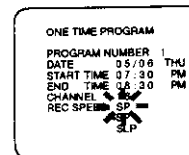

11 Finish setting the program

Press the F.FWD/▶ button. Program 1 is now completed.

- To set another program, repeat steps [2] to [11].
- Press the RESET/EXIT button to return to original mode.

12 Set the timer

Press the POWER button. The TIMER indicator on the VCR comes on.

- Please see "HINTS FOR TIMER RECORDING" on page 23 for more information.

HINTS FOR TIMER RECORDING

- If there is a power failure or the VCR is unplugged for more than 30 seconds, the clock setting and all timer settings will be lost.
- If the tape runs out before the end time, the VCR will switch to the Stop mode immediately, eject the tape and the VCR power will be turned off. The TIMER indicator will flash.
- If a tape is not in the VCR or does not have the erase-protection tab, the TIMER indicator flashes and timer recording can not be performed. Please insert a recordable tape.
- The TV that is connected to your VCR may be turned ON or OFF when the VCR is in the timer-record mode.

TIMER PROGRAM EXTENSION

To shift the time schedule of an one time program.

- 1) Turn the power on. Then, press the MENU button.
- 2) Select the program number which you want to shift forward using the PLAY/▲ or STOP/▼ button. The details of the selected program appears on the TV screen.
- 3) Press the RECORD button on the remote control when a program number is blinking.

Each additional push will shift forward the start/end time for recording by 10 minutes. It can be shift forward for up to 24 hours.

When the recording is already in progress, each additional push will shift forward the end time for recording by 10 minutes. It can shift forward up to 23:50 from the start time. In this case, the recording speed is forcedly set to SLP mode.

If you want to cancel while the setting, press the PAUSE/STILL button on the remote control. The recording time returns to the original time.

- 4) Press the RESET/EXIT button to exit the setting menu.

NOTES:

- You can shift the time schedule of an one time program only.
- When you press the PAUSE/STILL button to cancel the setting while the recording is already in progress, the recording mode keeps in SLP mode.

TO CORRECT AN AUTOMATIC TIMER PROGRAM

- 1) Turn the power on.
- 2) Repeat steps [1] to [3] on page 22.
- 3) Go to the digit you want to change by using the the F.FWD/▶ button or REW/◀ button.
- 4) Enter correct numbers using the PLAY/▲ or STOP/▼ button.
- 5) Press the RESET/EXIT button to return to original mode.
- 6) Press the POWER button to return to timer stand-by mode.

TO STOP A STARTED AUTOMATIC TIMER PROGRAM

Press the STOP/EJECT button on the VCR.

NOTE: The STOP button on the remote control will not function in Automatic Timer Recording mode.

TO CANCEL OR CHECK THE START/END TIME

- 1) Turn the power on. Then, press the MENU button.
- 2) Select the program number which you want to check using the PLAY/▲ or STOP/▼ button. The details of the selected program appears on the TV screen.
You may cancel the entire program by pressing the REW/◀ button.
- 3) Press the RESET/EXIT button to return to original mode.

AUTO RETURN

When all the timer recordings are completed (the TIMER indicator on the VCR flashes), the VCR will rewind to the beginning of the first recorded program(s) automatically.

MANUAL OPERATION

Press the AUTO RETURN button on the VCR first when all the timer recordings are completed. The VCR will automatically come on and rewind the tape.

- If you press the any tape function button before pressing the AUTO RETURN button, auto return does not function.

AUTOMATICALLY OPERATION (from the menu)

- 1) Press the POWER button to turn on the VCR.
- 2) Press the MENU button repeatedly so that the VCR SET UP menu appears.
- 3) Press the PLAY/▲ or STOP/▼ button to point to "AUTO RETURN".
- 4) Press the F.FWD/▶ button so that [AUTO] appears next to "AUTO RETURN".

To cancel the auto return programming, press the F.FWD/▶ button so that [AUTO] disappears from the menu.

- 5) Press the RESET/EXIT button to return to original mode.

NOTE: If there are any remaining programs for Once, Daily and Weekly, this function does not activate.

If you program multiple timer recordings and you want to activate the auto return when only some of those are finished, press the POWER button to turn on the VCR then press the AUTO RETURN button. The VCR will rewind to the beginning of those programs.

WATCH THE RECORDED PROGRAM

Press the POWER button to turn on the VCR. Then, press the PLAY button.

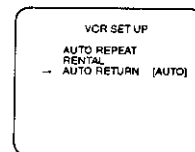

COPYING A VIDEO TAPE

You can make copies of video tapes made by friends or relatives for your enjoyment.

Warning: Unauthorized recordings of copyrighted video tapes may be an infringement of copyright laws.

Connect the editing (recording) VCR, source (playing) VCR and your TV using the following diagram.

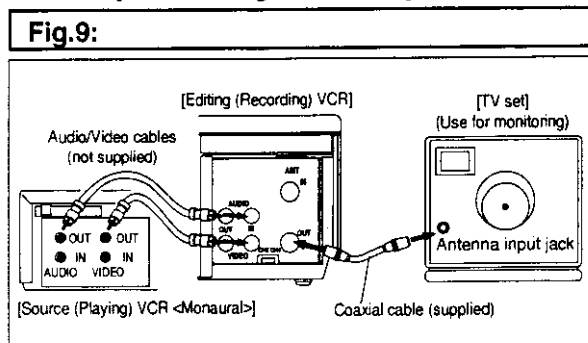

- 1) Insert a pre-recorded video cassette into the source (playing) VCR.
- 2) Insert a blank video cassette, or one you want to record over, into the editing (recording) VCR cassette compartment.
- 3) Press the TAPE SPEED button on the editing (recording) VCR to select the desired recording speed (SP/SLP).

4) Select the AUX position on the editing (recording) VCR. See page 13, under "Connecting to input jacks".

5) Press the REC button on the editing (recording) VCR.

6) Begin playback of the tape in the source (playing) VCR.

- For best results during dubbing, use the VCR's front panel controls whenever possible. The remote control might affect the playback VCR's operation.
- Always use video-quality shielded cables with RCA-type connectors. Standard audio cables are not recommended.
- You can use a video disc player, satellite receiver, or other audio/video component with A/V outputs in place of the playback VCR.

TO MONITOR THE RECORDING

1) Turn on the TV and set the TV to channel 3 or 4. Now set the CH3/CH4 switch on the back of the VCR to match the channel selected on the TV.

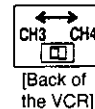

2) Press the VCR/TV button on the editing (recording) VCR so that the VCR/TV indicator on the VCR comes on.

ON SCREEN DISPLAY

NOTE: VCR power and the VCR/TV indicator must be turned on.

- To check the Count, Clock and Channel number, press the DISPLAY button. Each time you press the DISPLAY button, TV screen will change as shown.
- It is normal for the status display (STOP, PLAY etc.) and the tape speed display (SP, LP (playback only), or SLP) to disappear after 5 seconds.

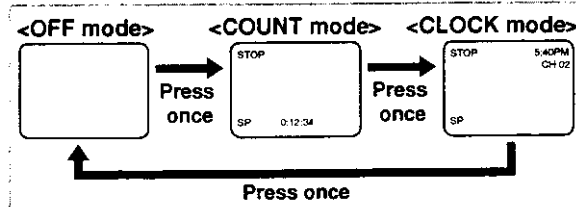

- To check either the Count or Clock, press the CLOCK/COUNTER button.

SPECIAL FEATURES

REAL TIME TAPE COUNTER

- This shows the elapsed recording or playback time in hours, minutes, and seconds. (The displayed time will not change during blank portions on the tape.)
- The "-" indication will appear when the tape is rewound further than "0:00:00" on the tape counter.

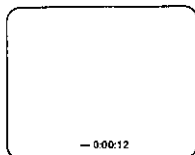

AUTO REWIND

When the end of a tape is reached during recording, playback, or fast-forward, the tape will automatically rewind to the beginning. After rewinding finishes, the VCR will eject the tape and turn itself off.

- The tape will not auto-rewind during timer recording or One Touch Recording.
- When the Counter Memory is activated, the tape will rewind to the M0:00:00 and the VCR will go into the Stop mode.

TROUBLESHOOTING GUIDE

If you have followed the instructions contained in this manual and have difficulty in operating your VCR, locate the **PROBLEM** in the left column below. Check the corresponding **CORRECTIVE ACTION** column to remedy the problem.

PROBLEM	CORRECTIVE ACTION
No power.	<ul style="list-style-type: none"> • Make sure the AC cord is connected to an AC outlet. • Make sure the power is turned on.
Timer recording can not be performed.	<ul style="list-style-type: none"> • Make sure the timer recording is set correctly. • Make sure the power is off. • Make sure the VCR clock is set correctly.
Cannot go into Record mode.	<ul style="list-style-type: none"> • Make sure the tape has an erase-prevention tab. If need, cover the hole with plastic tape.
Playback picture is partially noisy.	<ul style="list-style-type: none"> • Adjust tracking control for a better picture using the CHANNEL ▲ or ▼ button on the VCR.
No picture but the audio is OK in playback.	<ul style="list-style-type: none"> • Head cleaning is necessary. Refer to "AUTO HEAD CLEANING" below.
No picture or poor picture on playback.	<ul style="list-style-type: none"> • Set your TV to the VCR mode and/or press the VCR/TV button so that the VCR/TV indicator on the VCR comes on. • Fine tune your TV.
On-the-air TV programs cannot be seen.	<ul style="list-style-type: none"> • Re-check the ANT. IN and ANT. OUT connections. See page 10. • Set your TV to the TV mode and/or press the VCR/TV button so that the VCR/TV indicator on the VCR disappears.
No operation by infrared Remote Control.	<ul style="list-style-type: none"> • Make sure the AC cord is connected to an AC outlet. • Check batteries in remote control.
Video or color fades in and out when making a copy of a video tape.	<ul style="list-style-type: none"> • You can not copy a copyrighted video tape. You are experiencing copy guard protection.

MAINTENANCE

SERVICING

Should your VCR become inoperative, do not try to correct the problem by yourself. There are no user-serviceable parts inside. Turn off, unplug the power cord, and take the unit to Authorized Service Center for servicing. To locate an Authorized Service Center, please call 1-800-242-7158.

CABINET CLEANING

- Wipe the front panel and other exterior surfaces of the VCR with a soft cloth immersed in lukewarm water and wrung dry.
- Never use a solvent or alcohol. Do not spray insecticide liquid near the VCR. Such chemicals may cause damage and discoloration to the exposed surfaces.

AUTO HEAD CLEANING

- Automatically cleans heads as you insert or remove a cassette, so you can see a clear picture.
- Playback picture may become blurred or interrupted while the TV program reception is clear. Dirt accumulated on the video heads after long periods of use, or the usage of rental or worn tapes can cause this problem.

If a streaky or snowy picture appears during playback, the heads of your VCR may need to be cleaned.

1. Please visit your local Audio/Video store and purchase a good quality VHS Video Head Cleaner.
2. If a Video Head Cleaner does not solve the problem, consult the nearest Authorized Service Center. Professional video head cleaning requires highly technical attention.

NOTES:

- Remember to read the instructions included with the head cleaner before use.
- Clean heads only when problems occur.

SPECIFICATIONS

GENERAL SPECIFICATIONS

Television system :	NTSC, TV standard
Video heads :	Rotary two-head
Tape width :	1/2inch (12.65mm)
Tape speed	
SP :	33.35mm/sec.
LP :	16.67mm/sec.
SLP :	11.12mm/sec.
Tuner channel	
VHF :	#2~#13
UHF :	#14~#69
Cable channel :	5A, A-5 ~ A-1, A ~ W+84
RF converter :	Built-in VHF converter
Converter output :	VHF Channel 3 or 4.
Timer indication :	AM/PM 12-hour system
Operating temperature :	5°C~40°C (41°F~104°F)
Terminals	
Antenna input :	F type connector x 1
Antenna output :	F type connector x 1
Video input/output :	RCA connector x 2
Audio input/output :	RCA connector x 2

ELECTRICAL SPECIFICATIONS

Video output level :	1Vp-p
Video output impedance :	75Ω
Audio output level :	-6dBv (1KHz)
Video input level :	0.5~2.0Vp-p
Audio input level :	-10dBv
Video S/N ratio	
SP:	More than 45dB
Audio S/N ratio	
SP:	More than 38dB

OTHER SPECIFICATIONS

Power requirement :	120V, 60Hz
Power consumption :	14 Watts
Dimensions :	W 14-1/4" (360mm)
	H 3-5/8" (92mm)
	D 9-1/16" (230mm)
Weight :	5.51 lbs. (2.5 Kg.) (approx.)

- Designs and specifications are subject to change without notice and without our legal obligation.
- If there is any discrepancy between languages, the English is final.

CABLE CHANNEL DESIGNATIONS

If you subscribe to cable TV, the channels are displayed as 1-125.

Cable companies often designate channels with letters or letter-number combinations. Please check with your local cable company. The following is a chart of common cable channel designations.

CATV channel	5A	2	3	4	5	6	7	8	9	10	11	12	13	A	B
VCR Display	1	2	3	4	5	6	7	8	9	10	11	12	13	14	15
CATV channel	C	D	E	F	G	H	I	J	K	L	M	N	O	P	Q
VCR Display	16	17	18	19	20	21	22	23	24	25	26	27	28	29	30
CATV channel	R	S	T	U	V	W	W+1	W+2	W+3	W+4	W+5	W+6	W+7	W+8	W+9
VCR Display	31	32	33	34	35	36	37	38	39	40	41	42	43	44	45
CATV channel	W+10	W+11	W+12	W+13	W+14	W+15	W+16	W+17	W+18	W+19	W+20	W+21	W+22	W+23	W+24
VCR Display	46	47	48	49	50	51	52	53	54	55	56	57	58	59	60
CATV channel	W+25	W+26	W+27	W+28	W+29	W+30	W+31	W+32	W+33	W+34	W+35	W+36	W+37	W+38	W+39
VCR Display	61	62	63	64	65	66	67	68	69	70	71	72	73	74	75
CATV channel	W+40	W+41	W+42	W+43	W+44	W+45	W+46	W+47	W+48	W+49	W+50	W+51	W+52	W+53	W+54
VCR Display	76	77	78	79	80	81	82	83	84	85	86	87	88	89	90
CATV channel	W+55	W+56	W+57	W+58	A-5	A-4	A-3	A-2	A-1	W+59	W+60	W+61	W+62	W+63	W+64
VCR Display	91	92	93	94	95	96	97	98	99	100	101	102	103	104	105
CATV channel	W+65	W+66	W+67	W+68	W+69	W+70	W+71	W+72	W+73	W+74	W+75	W+76	W+77	W+78	W+79
VCR Display	106	107	108	109	110	111	112	113	114	115	116	117	118	119	120
CATV channel	W+80	W+81	W+82	W+83	W+84										
VCR Display	121	122	123	124	125										

FUNAI CORPORATION LIMITED WARRANTY

FUNAI CORP. will repair this product, free of charge in the USA in the event of defect in materials or workmanship as follows:

DURATION:

PARTS: FUNAI CORP. will provide parts to replace defective parts without charge for one (1) year from the date of original retail purchase. Two (2) years for Picture Tube. Certain parts are excluded from this warranty.

LABOR: FUNAI CORP. will provide the labor without charge for a period of ninety (90) days from the date of original retail purchase.

LIMITS AND EXCLUSIONS:

This warranty is extended only to the original retail purchaser. A purchase receipt or other proof of original retail purchase will be required together with the product to obtain service under this warranty.

This warranty shall not be extended to any other person or transferee.

This warranty is void and of no effect if any serial numbers on the product are altered, replaced, defaced, missing or if service was attempted by an unauthorized service center. This FUNAI CORPORATION Limited warranty does not apply to any product not purchased and used in the United States.

This warranty only covers failures due to defects in material or workmanship which occur during normal use. It does not cover damage which occurs in shipment, or failures which are caused by repairs, alterations or product not supplied by FUNAI CORP., or damage which results from accident, misuse, abuse, mishandling, misapplication, alteration, faulty installation, improper maintenance, commercial use such as hotel, rental or office use of this product or damage which results from fire, flood, lightning or other acts of God.

THIS WARRANTY DOES NOT COVER PACKING MATERIALS, ANY ACCESSORIES (EXCEPT REMOTE CONTROL), ANY COSMETIC PARTS, COMPLETE ASSEMBLY PARTS, DEMO OR FLOOR MODELS.

FUNAI CORP. AND ITS REPRESENTATIVES OR AGENTS SHALL IN NO EVENT BE LIABLE FOR ANY GENERAL, INDIRECT OR CONSEQUENTIAL DAMAGES ARISING OUT OF OR OCCASIONED BY THE USE OF OR THE INABILITY TO USE THIS PRODUCT. THIS WARRANTY IS MADE IN LIEU OF ALL OTHER WARRANTIES, EXPRESS OR IMPLIED, AND OF ALL OTHER LIABILITIES ON THE PART OF FUNAI. ALL OTHER WARRANTIES INCLUDING THE WARRANTY OF MERCHANTABILITY, AND FITNESS FOR A PARTICULAR PURPOSE, ARE HEREBY DISCLAIMED BY FUNAI AND ITS REPRESENTATIVES IN THE UNITED STATES. ALL WARRANTY INSPECTIONS AND REPAIRS MUST BE PERFORMED BY A FUNAI AUTHORIZED SERVICE CENTER. THIS WARRANTY IS VALID WHEN THE UNIT IS CARRIED-IN TO FUNAI AUTHORIZED SERVICE FACILITY.

WHEN YOU ARE RETURNING THE PRODUCT FOR SERVICE TO THE FACTORY SERVICE CENTER, PLEASE CONTACT THE FUNAI SERVICE DEPARTMENT TO RECEIVE A R.A. (REPAIR AUTHORIZATION) NUMBER PRIOR TO SHIPPING. ANY POSTAGE, INSURANCE AND SHIPPING COST, INCURRED IN PRESENTING OR SENDING YOUR FUNAI/SYMPHONIC PRODUCT FOR SERVICE ARE SHIPPER'S RESPONSIBILITY.

CAREFULLY PACK WITH PROPER PACKING MATERIALS, PREFERABLY IN THE ORIGINAL CARTON AND IF NEEDED DOUBLE BOX IT.

ATTACH WRITTEN DOCUMENTATION DETAILING THE COMPLAINT, TO THE OUTSIDE OR INSIDE OF THE CARTON.

THE PRODUCT MUST BE ACCOMPANIED BY A COPY OF THE ORIGINAL RETAIL PURCHASE RECEIPT. IF NO PROOF OF PURCHASE IS ATTACHED, THE WARRANTY WILL NOT BE HONORED AND REPAIRS COSTS WILL BE CHARGED.

IMPORTANT:

THIS LIMITED WARRANTY GIVES YOU SPECIFIC LEGAL RIGHTS. YOU MAY HAVE OTHER RIGHTS THAT VARY FROM STATE TO STATE. IF, AT ANY TIME DURING THE WARRANTY PERIOD, YOU ARE UNABLE TO OBTAIN SATISFACTION WITH THE REPAIR OF THIS PRODUCT, PLEASE CONTACT FUNAI CORP.

ATTENTION:

FUNAI CORP. RESERVES THE RIGHT TO MODIFY ANY DESIGN OF THIS PRODUCT WITHOUT PRIOR NOTICE.

To locate your nearest FUNAI Authorized Service Center or for general service procedure, please call 1-800-242-7158 or write to the following:

FUNAI CORPORATION
Factory Service Center
100 North Street; Teterboro, NJ 07608

Tel :1-800-242-7158