

# Test Report

FCC Rules 47 CFR,  
Part 90 (90.205, 90.207, 90.209, 90.210, 90.213, 90.215),  
Part 80(80.209, 80.211, 80.273),  
Part 2 (2.201, 2.202, 2.1046, 2.1047, 2.1049, 2.1051, 2.1053, 2.1055)

for

**Trade name: Furuno**  
**Model: WEATHER RADAR**  
**Type: WR2120**

Report no.: LIC 12-18-065

Date of issue: 29 June 2018

**Labotech International Co., Ltd.**

1-16, Fukazu-cho, Nishinomiya-shi, Hyogo, 663-8203 Japan

Tel: +81-798-63-1094 Fax: +81-798-63-1098

URL: <http://www.labotech-intl.co.jp/>

## Report Summary

LIC project number:	LIC 04-17-0743		
Test report number of initial issue:	LIC 12-18-065	Date of initial issue	29 June 2018
Test report number of revised/replaced issue:	--	Date of revised/replaced issue	--
Test report revision/replacement history:	--		
Test standard(s)/ Test specifications:	FCC Rules 47 CFR, Sections: 2.201 - Emission, modulation, and transmission characteristics 2.202 - Bandwidths 2.1046 - RF Power output 2.1047 - Measurements required: Modulation characteristics 2.1049 - Occupied bandwidth 2.1051 - Spurious emissions at antenna terminals 2.1053 - Field strength of spurious radiation 2.1055 - Measurements required: Frequency stability 80.209 - Transmitter frequency tolerances 80.211 - Emission limitations 80.273 - Radar standards 90.205 - Power and antenna height limits 90.207 - Types of emissions 90.209 - Bandwidth limitations 90.210 - Emission masks 90.213 - Frequency stability 90.215 - Transmitter measurements (The latest version on the first day of the testing period)		
Customer:	Furuno Electric Co., Ltd. 9-52, Ashihara-cho, Nishinomiya City, Hyogo, 662-8580 Japan		
Manufacturer:	Furuno Electric Co., Ltd. 9-52, Ashihara-cho, Nishinomiya City, Hyogo, 662-8580 Japan		
Trade name:	Furuno		
Model:	WEATHER RADAR		
Type:	WR2120		
Product function and intended use:	Weather radar		
Number of samples tested:	One		
Serial number:	ANTENNA UNIT: 1000-9100-0001 SIGNAL PROCESSING UNIT: 000001		
Power rating:	SIGNAL PROCESSING UNIT: 100–240 VAC, 50/60 Hz 3.5–1.5 A ANTENNA UNIT: 100–240 VAC, 50/60 Hz 6.5–2.7 A		
Product status:	Pre-production model		
Modifications made to samples during testing:	None		
Date of receipt of samples:	1 February 2018		
Test period:	From 19 February 2018 to 28 February 2018		
Place of test:	Labotech International Co., Ltd. FCC Test firm Designation Number: JP2007, FCC Test firm Registration Number: 838049 - LABOTECH EMC Center 1-16, Fukazu-cho, Nishinomiya-shi, Hyogo, 663-8203 Japan - Nishinomiya Lab. 9-52, Ashihara-cho, Nishinomiya-shi, Hyogo, 662-8580 Japan		
Test results/Compliance:	Passed. The test results of this report relate only to the samples tested.		

Tested by:	Atsushi Takagi and Yuya Katoh
Written by:	Arisa Ogino
Verified by:	Tadayuki Ekawa
Approved by:	29 June 2018 Name: Tadayuki Ekawa Title: Chief engineer, Technical Department, Labotech International Co., Ltd. Signature: 

## Testing Laboratory Status

Labotech International Co., Ltd. (hereafter called "LIC") has been holding the following status after having been assessed according to the provisions of ISO/IEC 17025 and/or the relevant rules:

(1) JAB Accredited Testing Laboratory:

- accredited by Japan Accreditation Board (JAB)
- Laboratory accreditation number: RTL03220
- Date of initial accreditation: 14 January 2011 (\*)
- Scope of accreditation: Electrical testing - EMC, Climatic, Vibration and Radio tests

(2) Telefication Listed Testing Laboratory:

- listed by Telefication B. V. (The Netherlands)
- Laboratory assignment number: L116
- Date of initial listing: 26 July 1999 (\*)
- for testing the following product categories/ test standards: EN 60945, IEC 61162-1/-2, IEC/EN 61162-450 and IEC 62288

(3) TÜV Appointed EMC Test Laboratory:

- appointed by TÜV Rheinland Japan Ltd.
- Laboratory assignment number: UA 50046428
- Date of initial appointment: 21 December 1998 (\*)
- for carrying out the tests of:
  - EN 55011, CISPR 11, EN 55012, CISPR 12, EN 55022, CISPR 22, EN 55024, CISPR 24, EN 55025, CISPR 25, EN/IEC 61000-3-2/-3, EN/IEC 61000-4-2/-3/-4/-5/-6/-8/-11, EN/IEC 61000-6-1/-2/-3/-4, EN/IEC 60945, EN/IEC 61326-1, EN/IEC 61326-2-6, EN/IEC 60601-1-2, JIS T 0601-1-2, JIS C 1806-1, ISO 11452-1/-2/-4, EN ISO 14982, IEC 62236-3-2 and EN 50121-3-2.

(4) RMRS Recognized Testing Laboratory:

- recognized by Russian Maritime Register of Shipping (RMRS) (Russia)
- Laboratory recognition number: 11.02594.011
- Date of initial recognition: 27 January 2009 (\*)
- for carrying out testing in the field of:
  - Electrical measurements and tests, EMC tests, Mechanical measurements and tests, Equipment protection degree tests, and Climatic tests for Ship's radio and navigational equipment and IEC 60945: 2002

(5) RRR Recognized Test Laboratory:

- recognized by Russian River Register (RRR) (Russia)
- Recognition certificate number: 131927 (\*)
- Date of initial recognition: 31 May 2013
- for carrying out of tests of ships radio and navigation equipment

(6) DNV GL Recognized Environmental Test Laboratory:

- recognized by Det Norske Veritas AS, Germanischer Lloyd (DNV GL) (Norway)
- Recognition certificate number: 262.1-015854-J-12
- Date of initial recognition: 12 July 2013 (\*)
- Scope of recognition: Testing according to the standards IEC 60945, IEC 61162-1/-2/-450, IEC 62288, IEC 62388 and IEC 62252 Annex E
- Application: Provisions of Environmental, interface and safety testing

(7) CCS Recognized Test Agency

- recognized by China Classification Society
- Recognition certificate number: DB13A00001
- Date of initial recognition: 29 January 2014 (\*)
- Scope of recognition: Performance/Environmental/EMC/Special purpose/Safety precautions tests for Electrical & Electronic Product including Maritime Navigation and Radio-communication Equipment & Systems

Note: (\*) – The current certificates may be found in the LIC web site (<http://www.labotech-intl.co.jp/>).

## TABLE OF CONTENTS

Report Summary.....	2
Testing Laboratory Status .....	4
1 Principal Information.....	6
1.1 Equipment under test (EUT).....	6
1.2 Observation and comments .....	7
2 Test Results Summary .....	8
3 Test Results.....	8
3.1 RF Power output (FCC Rule 47 CFR, 2.1046(a) and 90.205(s)) .....	8
3.2 Modulation characteristics (FCC Rule 47 CFR, 2.201, 2.1047(d) and 90.207).....	10
3.3 Frequency stability – temperature & voltage (FCC Rule 47 CFR, 2.1055(a)(1)/(d)(1)/(d)(3), 80.209(b) and 90.213).....	12
3.4 Occupied bandwidth (FCC Rule 47 CFR, 2.202(a) 2.1049(c)(1), 80.209(b), 80.211(f), 90.209 and 90.210(b)) .....	16
3.5 Spurious emissions at antenna terminal (FCC Rule 47 CFR, 2.1051, 80.211(f), 80.273, 90.210 and 90.215).....	17
3.6 Field strength of spurious radiation (FCC Rule 47 CFR, 2.1053, 80.211(f), 90.210 and 90.215).....	18
4 Test Setup for Measurements .....	19
5 Measuring Equipment List .....	21
6 RF Envelope and Spectrum of the Output Pulse .....	23
7 Spurious Emission Plots measured at Antenna Terminal .....	35

# 1 Principal Information

## 1.1 Equipment under test (EUT)

### 1.1.1 General

(a) Trade name: Furuno

(b) Manufacturer: Furuno Electric Co., Ltd.

9-52, Ashihara-cho, Nishinomiya-city, Hyogo, 662-8580 Japan

(c) Model:

	Type	Serial Number
ANTENNA UNIT	WR2120-ATU	1000-9100-0001
SIGNAL PROCESSING UNIT	WR2120-SPU	000001

(d) FCC ID: ADB9ZWWR2120

(e) Primary function: Weather Radar

(f) Frequency range: CH1 (9422.5 MHz), CH2 (9427.5 MHz), CH3 (9432.5 MHz), CH4 (9437.5 MHz)

Type of emission: P0N/Q0N/P0N+Q0N (Emission designator)

(g) Occupied bandwidth:

Pulse type		Horizontal		Vertical	
		Short	Long	Short	Long
Occupied bandwidth (MHz)	CH1 (P0N)	4.58	4.58	4.58	4.58
	CH1 (Q0N)	5.50	4.58	5.50	4.58
	CH2 (P0N)	4.58	4.58	4.58	4.58
	CH2 (Q0N)	5.50	4.58	5.50	4.58
	CH3 (P0N)	4.58	4.58	4.58	4.58
	CH3 (Q0N)	5.50	4.58	5.50	4.58
	CH4 (P0N)	4.58	4.58	4.58	4.58
	CH4 (Q0N)	5.50	4.58	5.50	4.58

Note: Represents actual measured data.

(h) Size and mass: ANTENNA UNIT: f 980 mm ´ 1068 mm (H), 65 kg (Including radome)

SIGNAL PROCESSING UNIT: 756 mm (W) ´ 750 mm (H) ´ 300 mm (D), 45 kg

(i) Power supply: 1j , 100–240 VAC, 50/60 Hz, 350 W

(Power supply for ANTENNA UNIT is supplied via SIGNAL PROCESSING UNIT)

### 1.1.2 Transceiver

Type: WR2120-ATU (Contained in the radome)

#### 1.1.2.1 Transmitter

(a) Assignable frequency band: Between 9300 and 9500 MHz (FCC Rule, 90.103 (b))

(b) Type of RF generator:

Type: Solid-state device (no magnetron)

Peak output power: 200 W nominal

(c) Tx frequency: CH1: 9422.5 MHz

CH2: 9427.5 MHz

CH3: 9432.5 MHz

CH4: 9437.5 MHz

(d) Pulse characteristics:

Pulse type	Short	Long
Pulse length (ms) P0N/Q0N	0.5/20	1/50
P.R.F. (Hz)	1600/2000	1600/2000

**1.1.2.2 Receiver**

## (a) Passband

RF Stage: 300 MHz

IF Stage: 60 MHz

## (b) Intermediate Frequency: 93.75 MHz

## (c) Gain (overall): Approximately 50 dB

## (d) Overall noise figure: 4 dB (typical)

## (e) Video output voltage: Not provided (via Ethernet communication)

## (f) Features provided: Main bang suppression

## (g) If receiver is tunable, describe method for adjusting frequency: By adjusting tuning voltage of receiver local oscillator (automatic and manual)

**1.1.3 Operational features**

## (a) Is positive means provided to indicate whether or not the overall operation of the equipment is such that it may be relied upon to provide effective operation in accordance with its primary function: Yes (Alarm function)

## (b) Is the equipment for continuous operation: Yes

## (c) Is provision made for operation with shore based radar beacons (RACONS): No

**1.1.4 Construction features**

## (a) Does equipment embody replacement units with chassis type assembly: Yes

## (b) Are fuse alarms provided: No

## (c) State units that are weatherproof: Transceiver Unit (IEC 60529 – IP55)

## (d) If all units are not housed in a single container, indicate number and give description of individual units:

See Clause 1.1.1 (c) of this report.

## (e) Approximate space required for installation excluding antenna unit: approx. size = 330 ´ 130 ´ 299

See the outline drawing of junction unit in the installation manual

(Doc. No. S2E-17-0056).

**1.2 Observation and comments**

None.

## 2 Test Results Summary

Clause No. of this report	47 CFR Section	Item	Result	Test engineer
3.1	2.1046 (a) 90.205(s)	RF power output	Passed.	A. Takagi
3.2	2.201 2.1047(d) 90.207	Modulation characteristics	Passed.	A. Takagi
3.3	2.1055 (a)(1),(d)(1),(d)(3) 80.209 (b) 90.213	Frequency stability	Passed.	A. Takagi
3.4	2.202 (a) 2.1049 (c)(1) 80.209 (b) 80.211 (f) 90.209 90.210 (b)	Occupied bandwidth	Passed.	A. Takagi
3.5	2.1051 80.211 (f) 80.273, 90.210 90.215	Spurious emissions at antenna terminals	Passed.	A. Takagi
3.6	2.1053 80.211 (f) 90.210 90.215	Field strength of spurious radiation	Passed.	Y. Katoh

## 3 Test Results

### 3.1 RF Power output (FCC Rule 47 CFR, 2.1046(a) and 90.205(s))

#### (1) Test conditions

For CH1, CH3, CH4 (P0N Short/P0N Long/Q0N Short/Q0N Long) pulses, the transmitter output power was measured at the antenna port of the non-reflective load, which replaced an antenna radiator.

#### (2) Test setup

See Clause 4.

#### (3) Limits

Output power: 200 W max. (+20% of nominal power) (FCC Rule 47 CFR, 90.205(s))

#### (4) Test Results

##### CH1, P0N

Pulse type	Horizontal		Vertical	
	Short	Long	Short	Long
Transmission mean power Pm (W)	0.089	0.179	0.093	0.188
Pulse length T (ms)	0.520	1.052	0.532	1.056
PRF (Hz) (*1)	1778	1778	1778	1778
Transmission pulse power Pp (W) (*2)	96.3	95.7	98.3	100.1

##### CH1, Q0N

Pulse type	Horizontal		Vertical	
	Short	Long	Short	Long
Transmission mean power Pm (W)	3.168	7.828	3.273	8.090
Pulse length T (ms)	20.30	50.20	20.20	50.40
PRF (Hz) (*1)	1778	1778	1778	1778
Transmission pulse power Pp (W) (*2)	87.8	87.7	91.1	90.3



**CH3, P0N**

Pulse type	Horizontal		Vertical	
	Short	Long	Short	Long
Transmission mean power Pm (W)	0.092	0.186	0.097	0.194
Pulse length T (ms)	0.544	1.068	0.540	1.060
PRF (Hz) (*1)	1778	1778	1778	1778
Transmission pulse power Pp (W) (*2)	95.1	98.0	101.0	102.9

**CH3, Q0N**

Pulse type	Horizontal		Vertical	
	Short	Long	Short	Long
Transmission mean power Pm (W)	3.247	8.012	3.377	8.090
Pulse length T (ms)	20.20	50.20	20.20	50.40
PRF (Hz) (*1)	1778	1778	1778	1778
Transmission pulse power Pp (W) (*2)	90.4	89.8	94.0	90.3

**CH4, P0N**

Pulse type	Horizontal		Vertical	
	Short	Long	Short	Long
Transmission mean power Pm (W)	0.094	0.190	0.097	0.195
Pulse length T (ms)	0.536	1.068	0.540	1.064
PRF (Hz) (*1)	1778	1778	1778	1778
Transmission pulse power Pp (W) (*2)	98.6	100.1	101.0	103.1

**CH4, Q0N**

Pulse type	Horizontal		Vertical	
	Short	Long	Short	Long
Transmission mean power Pm (W)	3.299	8.116	3.43	8.038
Pulse length T (ms)	20.20	50.40	20.30	50.20
PRF (Hz) (*1)	1778	1778	1778	1778
Transmission pulse power Pp (W) (*2)	91.9	90.6	95.0	90.1

(\*1) Pulse repetition frequency

 (\*2)  $P_p (W) = (P_m (W) / (T (ms) \cdot PRF (Hz))) \cdot 1000000$ 

Environmental conditions: 23 February 2018, 24°C to 24°C, 43%RH to 43%RH

Power supply voltage measured: 120 VAC, 60 Hz to 120 VAC, 60 Hz

### 3.2 Modulation characteristics (FCC Rule 47 CFR, 2.201, 2.1047(d), and 90.207)

#### (1) Test Conditions

The RF envelope of the solid-state device output pulse was measured using an envelope detector and an oscilloscope. Each pulse spectrum was measured using a spectrum analyzer.

#### (2) Test setup

See Clause 4.

#### (3) Test Results

##### CH1, P0N

Pulse type	Horizontal		Vertical	
	Short	Long	Short	Long
Pulse length T (ms)	0.520	1.052	0.532	1.056
Rise time tr (ms) (10 to 90% amplitude)	0.277	0.336	0.274	0.337
Fall time tf (ms) (90 to 10% amplitude)	0.270	0.333	0.267	0.336
PRF (Hz) (*1)	1778	1778	1778	1778

##### CH1, Q0N

Pulse type	Horizontal		Vertical	
	Short	Long	Short	Long
Pulse length T (ms)	20.30	50.20	20.20	50.40
Rise time tr (ms) (10 to 90% amplitude)	0.721	0.670	0.729	0.678
Fall time tf (ms) (90 to 10% amplitude)	0.834	0.819	0.849	0.835
PRF (Hz) (*1)	1778	1778	1778	1778

##### CH3, P0N

Pulse type	Horizontal		Vertical	
	Short	Long	Short	Long
Pulse length T (ms)	0.544	1.068	0.540	1.060
Rise time tr (ms) (10 to 90% amplitude)	0.274	0.334	0.273	0.337
Fall time tf (ms) (90 to 10% amplitude)	0.268	0.335	0.266	0.334
PRF (Hz) (*1)	1778	1778	1778	1778

##### CH3, Q0N

Pulse type	Horizontal		Vertical	
	Short	Long	Short	Long
Pulse length T (ms)	20.20	50.20	20.20	50.40
Rise time tr (ms) (10 to 90% amplitude)	0.728	0.675	0.730	0.680
Fall time tf (ms) (90 to 10% amplitude)	0.851	0.825	0.849	0.831
PRF (Hz) (*1)	1778	1778	1778	1778

**CH4, P0N**

Pulse type	Horizontal		Vertical	
	Short	Long	Short	Long
Pulse length T (ms)	0.536	1.068	0.540	1.064
Rise time tr (ms) (10 to 90% amplitude)	0.274	0.335	0.273	0.337
Fall time tf (ms) (90 to 10% amplitude)	0.267	0.334	0.266	0.336
PRF (Hz) (*1)	1778	1778	1778	1778

**CH4, Q0N**

Pulse type	Horizontal		Vertical	
	Short	Long	Short	Long
Pulse length T (ms)	20.20	50.40	20.30	50.20
Rise time tr (ms) (10 to 90% amplitude)	0.727	0.677	0.728	0.678
Fall time tf (ms) (90 to 10% amplitude)	0.851	0.828	0.854	0.833
PRF (Hz) (*1)	1778	1778	1778	1778

(\*1) Pulse repetition frequency

Measured plots: See Clause 7.

Environmental conditions: 23 February 2018, 24°C to 24°C, 43%RH to 43%RH

Power supply voltage measured: 120 VAC, 60 Hz to 120 VAC, 60 Hz

### 3.3 Frequency stability – temperature & voltage (FCC Rule 47 CFR, 2.1055(a)(1)/(d)(1)/(d)(3), 80.209(b) and 90.213)

#### (1) Test conditions

- (1) Radar transmitter: CH1, CH3, CH4 (P0N Short/P0N Long/Q0N Short/Q0N Long) pulses
- (2) Ambient temperature: -30°C to +50°C (10°C interval)
- (3) Power supply voltage: 85/100/115% of nominal voltage (85 VAC/50 Hz/120 VAC/60 Hz /276 VAC/60 Hz)

#### (2) Test setup

See Clause 4.

#### (3) Frequency tolerance limit

##### (3.1) Frequency tolerance limits (FCC Rule 47, 2.1055(a)(1) and CFR 90.213(a))

##### CH1, P0N

Pulse type	Horizontal		Vertical	
	Short	Long	Short	Long
Guard Band f(1.5/T) (MHz) (*1)	2.9	1.4	2.8	1.4
Upper limit (MHz) (*2)	9497.1	9498.6	9497.2	9498.6
Lower limit (MHz) (*2)	9302.9	9301.4	9302.8	9301.4

##### CH1, Q0N

Pulse type	Horizontal		Vertical	
	Short	Long	Short	Long
Guard Band f(1.5/T) (MHz) (*1)	0.1	0.0	0.1	0.0
Upper limit (MHz) (*2)	9499.9	9500.0	9499.9	9500.0
Lower limit (MHz) (*2)	9300.1	9300.0	9300.1	9300.0

##### CH3, P0N

Pulse type	Horizontal		Vertical	
	Short	Long	Short	Long
Guard Band f(1.5/T) (MHz) (*1)	2.8	1.4	2.8	1.4
Upper limit (MHz) (*2)	9497.2	9498.6	9497.2	9498.6
Lower limit (MHz) (*2)	9302.8	9301.4	9302.8	9301.4

##### CH3, Q0N

Pulse type	Horizontal		Vertical	
	Short	Long	Short	Long
Guard Band f(1.5/T) (MHz) (*1)	0.1	0.0	0.1	0.0
Upper limit (MHz) (*2)	9499.9	9500.0	9499.9	9500.0
Lower limit (MHz) (*2)	9300.1	9300.0	9300.1	9300.0

##### CH4, P0N

Pulse type	Horizontal		Vertical	
	Short	Long	Short	Long
Guard Band f(1.5/T) (MHz) (*1)	2.8	1.4	2.8	1.4
Upper limit (MHz) (*2)	9497.2	9498.6	9497.2	9498.6
Lower limit (MHz) (*2)	9302.8	9301.4	9302.8	9301.4

**CH4, Q0N**

Pulse type	Horizontal		Vertical	
	Short	Long	Short	Long
Guard Band $f(1.5/T)$ (MHz) (*1)	0.1	0.0	0.1	0.0
Upper limit (MHz) (*2)	9499.9	9500.0	9499.9	9500.0
Lower limit (MHz) (*2)	9300.1	9300.0	9300.1	9300.0

(\*1) Guard Band is specified to be equal to  $1.5/T$  MHz, where "T" is the pulse length in microseconds.  
(FCC Rule 47 CFR, 80.209(b))

(\*2) Upper limit frequency,  $f(U) = 9500 - 1.5/T$   
Lower limit frequency,  $f(L) = 9300 + 1.5/T$

**(4) Test results**

Complied.

**(4.1) Temperature test at the nominal voltage of 120 VAC/60 Hz:**

**CH1, P0N**

Pulse type		Short	Long	Result
Frequency at maximum emission (MHz)  9422.5	- 30°C	9422.4	9422.5	Complied.
	- 20°C	9422.5	9422.5	Complied.
	- 10°C	9422.5	9422.5	Complied.
	0°C	9422.5	9422.5	Complied.
	+10°C	9422.5	9422.5	Complied.
	+20°C	9422.5	9422.5	Complied.
	+30°C	9422.5	9422.5	Complied.
	+40°C	9422.5	9422.5	Complied.
	+50°C	9422.5	9422.5	Complied.

**CH1, Q0N**

Pulse type		Short	Long	Result
Center frequency (MHz)  9422.5	- 30°C	9422.5	9422.5	Complied.
	- 20°C	9422.4	9422.5	Complied.
	- 10°C	9422.5	9422.5	Complied.
	0°C	9422.5	9422.5	Complied.
	+10°C	9422.5	9422.5	Complied.
	+20°C	9422.5	9422.5	Complied.
	+30°C	9422.5	9422.5	Complied.
	+40°C	9422.4	9422.5	Complied.
	+50°C	9422.5	9422.5	Complied.

**CH3, P0N**

Pulse type		Short	Long	Result
Frequency at maximum emission (MHz)  9432.5	- 30°C	9432.6	9432.4	Complied.
	- 20°C	9432.5	9432.5	Complied.
	- 10°C	9432.4	9432.5	Complied.
	0°C	9432.5	9432.5	Complied.
	+10°C	9432.5	9432.5	Complied.
	+20°C	9432.5	9432.5	Complied.
	+30°C	9432.5	9432.5	Complied.
	+40°C	9432.5	9432.5	Complied.
	+50°C	9432.5	9432.5	Complied.

**CH3 Q0N**

Pulse type		Short	Long	Result
Center frequency (MHz)  9432.5	- 30°C	9432.4	9432.5	Complied.
	- 20°C	9432.5	9432.5	Complied.
	- 10°C	9432.5	9432.5	Complied.
	0°C	9432.5	9432.5	Complied.
	+10°C	9432.4	9432.5	Complied.
	+20°C	9432.5	9432.5	Complied.
	+30°C	9432.5	9432.5	Complied.
	+40°C	9432.5	9432.5	Complied.
	+50°C	9432.5	9432.5	Complied.

**CH4, P0N**

Pulse type		Short	Long	Result
Frequency at maximum emission (MHz)  9437.5	-30°C	9437.4	9437.4	Complied.
	-20°C	9437.5	9437.5	Complied.
	-10°C	9437.5	9437.5	Complied.
	0°C	9437.5	9437.5	Complied.
	+10°C	9437.5	9437.5	Complied.
	+20°C	9437.5	9437.5	Complied.
	+30°C	9437.5	9437.5	Complied.
	+40°C	9437.5	9437.5	Complied.
	+50°C	9437.5	9437.5	Complied.

**CH4, Q0N**

Pulse type		Short	Long	Result
Center frequency (MHz)  9437.5	- 30°C	9437.4	9437.5	Complied.
	- 20°C	9437.5	9437.5	Complied.
	- 10°C	9437.5	9437.5	Complied.
	0°C	9437.5	9437.5	Complied.
	+10°C	9437.5	9437.5	Complied.
	+20°C	9437.5	9437.5	Complied.
	+30°C	9437.5	9437.5	Complied.
	+40°C	9437.5	9437.5	Complied.
	+50°C	9437.5	9437.5	Complied.

**(4.2) Voltage variation test at the normal temperature of +20°C:**

**CH1, P0N**

Pulse type		Short	Long	Result
Frequency at maximum emission (MHz) 9422.5	85 VAC	9422.5	9422.5	Complied.
	120 VAC	9422.5	9422.5	Complied.
	276 VAC	9422.5	9422.5	Complied.

**CH1, Q0N**

Pulse type		Short	Long	Result
Center frequency (MHz) 9422.5	85 VAC	9422.5	9422.5	Complied.
	120 VAC	9422.5	9422.5	Complied.
	276 VAC	9422.5	9422.5	Complied.

**CH3, P0N**

Pulse type		Short	Long	Result
Frequency at maximum emission (MHz) 9432.5	85 VAC	9432.5	9432.5	Complied.
	120 VAC	9432.5	9432.5	Complied.
	276 VAC	9432.5	9432.5	Complied.

**CH3, Q0N**

Pulse type		Short	Long	Result
Center frequency (MHz) 9432.5	85 VAC	9432.5	9432.5	Complied.
	120 VAC	9432.5	9432.5	Complied.
	276 VAC	9432.5	9432.5	Complied.

**CH4, P0N**

Pulse type		Short	Long	Result
Frequency at maximum emission (MHz) 9437.5	85 VAC	9437.5	9437.5	Complied.
	120 VAC	9437.5	9437.5	Complied.
	276 VAC	9437.5	9437.5	Complied.

**CH4, Q0N**

Pulse type		Short	Long	Result
Center frequency (MHz) 9437.5	85 VAC	9437.5	9437.5	Complied.
	120 VAC	9437.5	9437.5	Complied.
	276 VAC	9437.5	9437.5	Complied.

Environmental conditions: On 24 February 2018, 24°C to 24°C, 39%RH to 39%RH  
 On 25 February 2018, 23°C to 23°C, 45%RH to 45%RH  
 On 26 February 2018, 23°C to 23°C, 45%RH to 45%RH

Power supply voltage measured: 85 VAC, 50 Hz to 85 VAC, 50 Hz  
 120 VAC, 60 Hz to 120 VAC, 60 Hz  
 276 VAC, 60 Hz to 276 VAC, 60 Hz

### 3.4 Occupied bandwidth

(FCC Rule 47 CFR, 2.202(a) 2.1049(c)(1), 80.209(b), 80.211(f), 90.209 and 90.210(b))

#### (1) Test conditions

For CH1, CH3, CH4 (P0N Short/P0N Long/Q0N Short/Q0N Long) pulses, the transmitter occupied bandwidth was measured at the antenna port of the non-reflective load, which replaced an antenna radiator.

#### (2) Test setup

See Clause 4.

#### (3) Emission limits (FCC Rule 47 CFR, 80.211 (f) and 90.210 (b))

Frequency removed from the assigned frequency (*1)	Emission attenuation (mean power, dB)
50 to 100% (of the authorized bandwidth) (*2)	At least 25
100 to 250% (of the authorized bandwidth) (*2)	At least 35
More than 250% (of the authorized bandwidth) (*2)	At least $43 + 10 \log_{10}$ (mean power in watts) = -13 dBm

(\*1) Assigned frequency (center frequency) = 9422.5, 9432.5 and 9437.5 MHz (for X-band radars)

(\*2) Authorized bandwidth = 110 MHz (for X-band radars)

#### (4) Test results

Complied.

Spectrum plots: See Clause 7.

Environmental conditions: On 23 February 2018, 24°C to 24°C, 43%RH to 43%RH

Power supply voltage measured: 120 VAC, 60 Hz to 120 VAC, 60 Hz



### 3.5 Spurious emissions at antenna terminals (FCC Rule 47 CFR, 2.1051, 80.211(f), 80.273, 90.210 and 90.215)

#### (1) Test conditions

For CH1, CH3, CH4 (P0N Short/P0N Long/Q0N Short/Q0N Long) pulse, the transmitter output power was measured at the antenna port of the non-reflective load, which replaced an antenna radiator. (\*1)

(\*1): Emission measurements only need to be carried out for the pulse length setting producing the widest calculated  $B_{-40}$  bandwidth. (IEC 62388 Ed.2/Annex B.4.2 part)

#### (2) Test setup

See Clause 4.

#### (3) Emission limits (FCC Rule 47 CFR 90.210(b))

Frequency removed from the assigned frequency (*1)	Emission attenuation (mean power, dB)
More than 250% (*3) (of the authorized bandwidth) (*2)	At least $43 + 10 \log_{10}$ (mean power in watts) = -13 dBm

(\*1) Assigned frequency (center frequency) = 9422.5, 9432.5 and 9437.5 MHz (for X-band radars)

(\*2) Authorized bandwidth = 110 MHz (for X-band radars)

(\*3) Spurious measurement range for X-Band RADAR: 3.68 GHz to 40 GHz

Lower measurement band	Upper measurement band
From 3.68 GHz (*4) to the lower OoB boundary	From the upper OoB boundary to 40 GHz

(\*4) 0.7 times of the waveguide cut-off frequency for WRJ-9 (ITU-R SM.329-12, Section 2.5)

#### (4) Harmonics frequencies

$f_0$ (MHz)	$1/2f_0$	$2f_0$	$3f_0$	$4f_0$
9422.5	4711.25	18845	28267.5	37690
9432.5	4716.25	18865	28297.5	37730
9437.5	4718.75	18875	28312.5	37750

#### (5) Test results

Complied.

Spurious emission levels measured were found to be attenuated more than 20 dB below the limits.

Environmental conditions: On 27 February 2018, 23°C to 23°C, 52%RH to 52%RH

On 28 February 2018, 23°C to 23°C, 52%RH to 52%RH

Power supply voltage measured: 120 VAC, 60 Hz to 120 VAC, 60 Hz

**3.6 Field strength of spurious radiation  
(FCC Rule 47 CFR, 2.1053, 80.211(f), 90.210, and 90.215)**

**(1) Test conditions:**

For S pulse, the transmitter output power was measured at the antenna output terminal with a non-reflective load, which replaced the antenna. (\*1)

(\*1): Emission measurements only need to be carried out for the pulse length setting producing the widest calculated B<sub>-40</sub> bandwidth. (IEC 62388 Ed.2/Annex B.4.2 part)

(a) Spurious measurement range for X-Band radar: 3.68 GHz to 40 GHz

Lower measurement band	Upper measurement band
From 3.68 GHz (*2) to the lower OoB boundary	From the upper OoB boundary to 40 GHz

(\*2) 0.7 times of the waveguide cut-off frequency for WRJ-9 (ITU-R SM.329-12, Section 2.5)

(b) Antenna port was terminated with a dummy load.

**(2) Test site:** LIC EMC center, Semi-anechoic chamber

**(3) Distance between the radar set and measuring antenna:** 3 m

**(4) Test setup**

See Clause 4.

The GRP (Ground reference plane, metal floor) between the EUT and the measuring (receiving) antenna was lined with the Radio Absorbers (2.4 m ´ 3.0 m ´ 0.5 m) to reduce the influences of the reflections of the RF waves from the floor.

**Measuring (receiving) antenna height and polarization:**

(a) Antenna height: EUT center (2.03 m)

(b) Antenna polarization: vertical and horizontal.

**EUT height:** 1.5 m

**(5) Field strength limits (FCC Rule 47 CFR, and 90.210(b))**

Frequency removed from the assigned frequency (*1)	Emission attenuation (mean power, dB)
More than 250% (of the authorized bandwidth) (*2)	At least 43 + 10 log <sub>10</sub> (mean power in watts) = -13 dBm

(\*1) Assigned frequency (center frequency) = 9422.5, 9432.5, and 9437.5 MHz (for X-band radars)

(\*2) Authorized bandwidth = 110 MHz (for X-band radars)

**(6) Harmonics frequencies**

f <sub>0</sub> (MHz)	1/2f <sub>0</sub>	2f <sub>0</sub>	3f <sub>0</sub>	4f <sub>0</sub>
9422.5	4711.25	18845	28267.5	37690
9432.5	4716.25	18865	28297.5	37730
9437.5	4718.75	18875	28312.5	37750

**(7) Test results**

Complied.

Spurious emission levels measured were found to be attenuated more than 20 dB below the limits.

Environmental conditions: On 19 February 2018, 23°C to 23°C, 40%RH to 40%RH  
On 20 February 2018, 20°C to 20°C, 40%RH to 40%RH

Power supply voltage measured: 120 VAC, 60 Hz to 120 VAC, 60 Hz

## 4 Test Setup for Measurements

### (1) Test setup for Clause 3.3 and 3.5

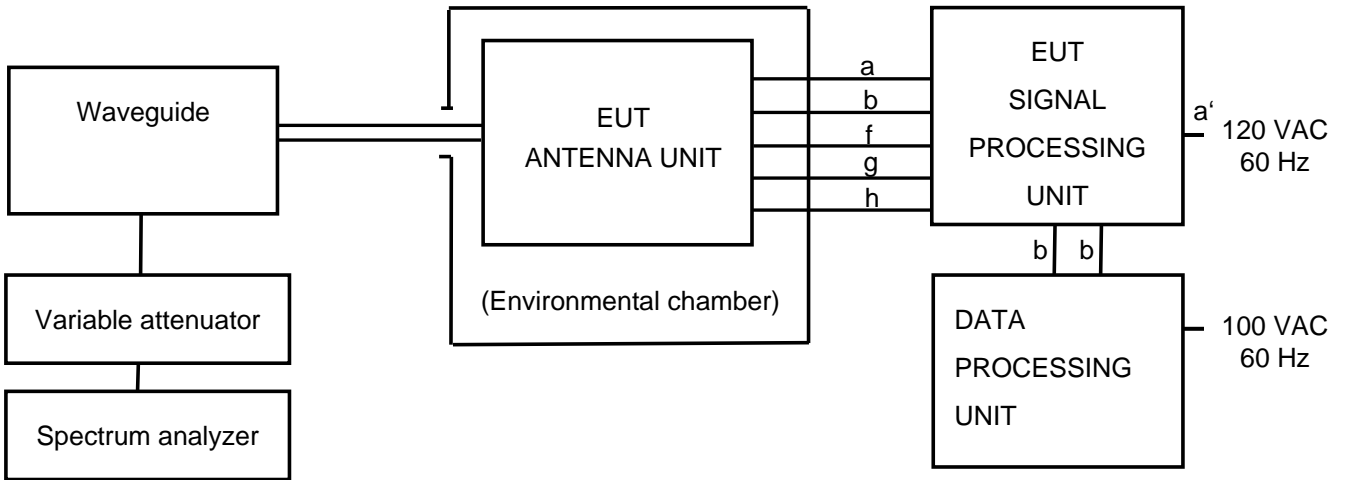

### (2) Test setup for Clause 3.1, 3.2 and 3.4

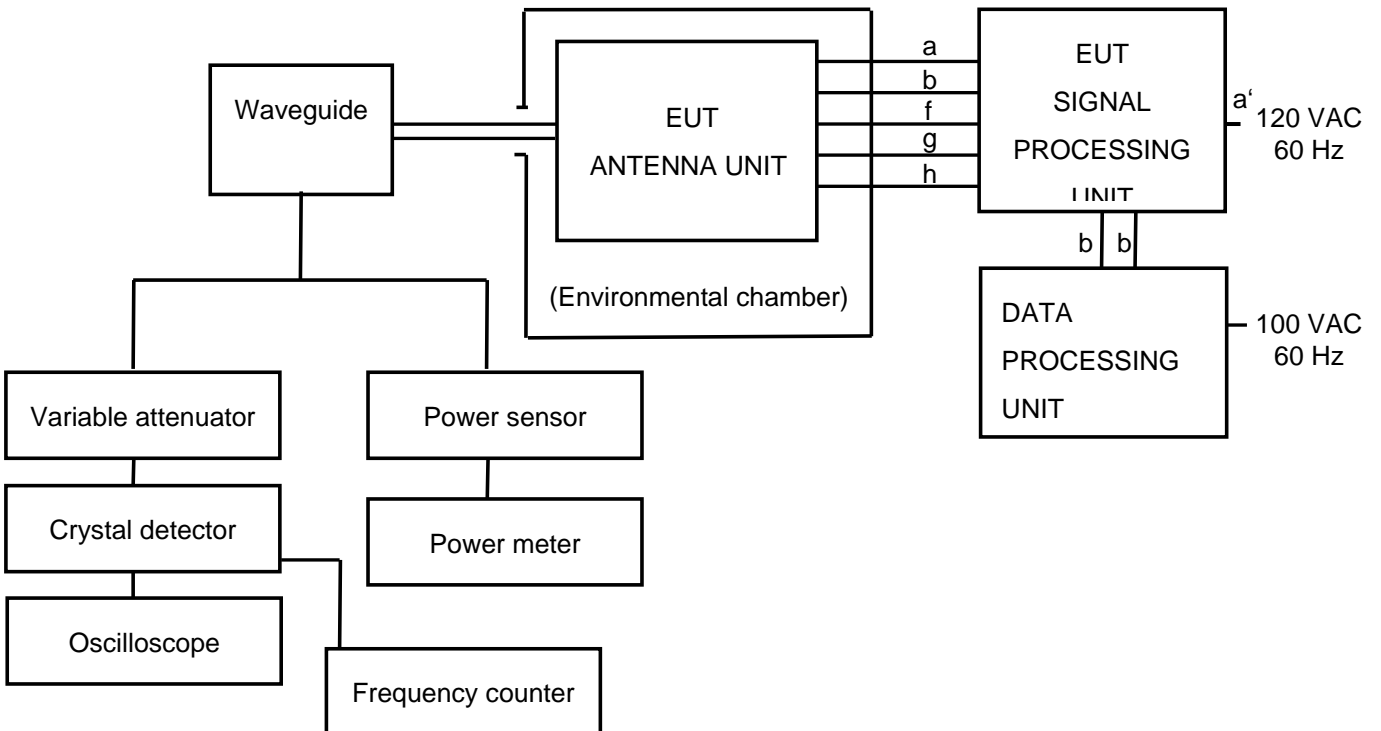

**(3) Test setup for Clause 3.6**

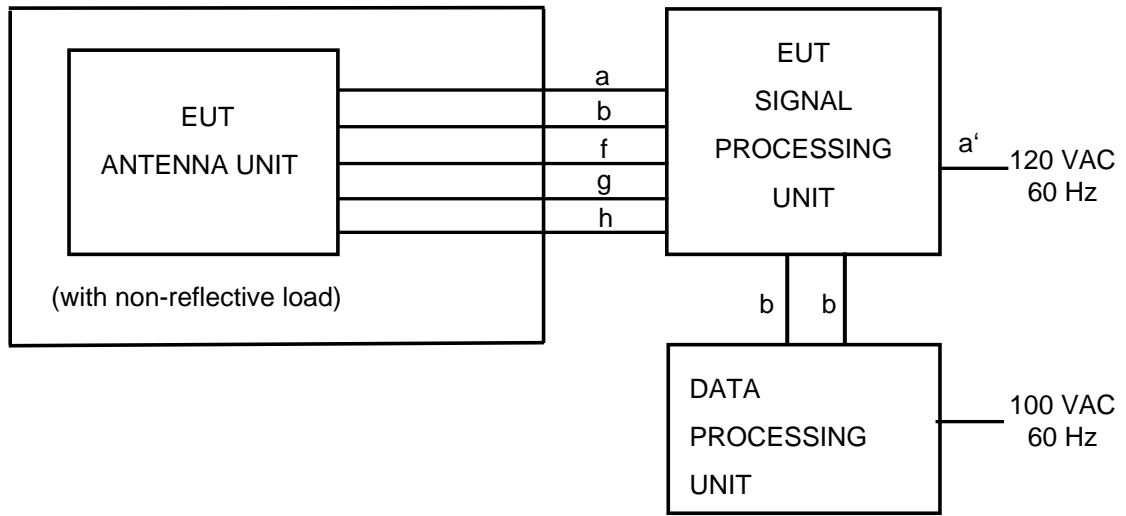

List of cables used for the tests

No.	Name	Length (m)
a	VCTF-SB 2.0SQx3C	20
a'	VCTF-SB 2.0SQx3C	1.5
b	Ethernet STP CAT.5e	20
f	HDR-AS-0215-L20000	20
g	HDR-AS-0214-L20000	20
h	3D-2Vx3C	20

## 5 Measuring Equipment List

Measuring/Test instruments have been appropriately calibrated/maintained according to the LIC programs/procedures and ISO/IEC 17025. Measuring/Test instruments used for the tests are listed below.

### (1) RF Power output

C/N	Instrument	Type	S/N	Manufacturer	Date of last calibration	Calibration interval
505026	Power meter	E4418B	GB43317662	Agilent	19 June 2017	1 year
120110402	Avg. Power sensor	N8481A	MY48100658	Agilent	19 June 2017	1 year
RT213	Waveguide	WRJ-10	Not assigned.	Furuno	4 July 2017	1 year
HT1204	Programmable AC power source	DP045M	9158465	NF	Not applicable.	--
HT370	Climatic chamber (Large)	TBE-3HW5GE2F	3013000995	Espec	17 August 2017	1 year
HT723	Paperless recorder/ Dual communication logger	FX106-4-1	S5JA01445	Yokogawa	--	1 year
HT831	Digital multi-meter	115	15540244	Fluke	26 May 2017	1 year

### (2) Modulation characteristics

C/N	Instrument	Type	S/N	Manufacturer	Date of last calibration	Calibration interval
RT213	Waveguide	WRJ-10	Not assigned	Furuno	4 July 2017	1 year
HT654	Attenuator	8494B	MY42148134	Agilent	21 February 2018	1 year
HT728	Attenuator	8495B	MY42145734	Agilent	14 December 2017	1 year
--	Attenuator	47-30-21	--	Aeroflex/ Weinschel	Not Applicable.	--
740040701	Crystal detector	423B	MY42241658	Agilent	11 October 2017	1 year
808052	Frequency counter	MF2414C	6200769857	Anritsu	18 July 2017	1 year
HT972	Oscilloscope	MSO4054B	C030483	Tektronix	13 February 2017	1 year
HT1204	Programmable AC power source	DP045M	9158465	NF	Not applicable.	--
HT370	Climatic chamber (Large)	TBE-3HW5GE2F	3013000995	Espec	17 August 2017	1 year
HT723	Paperless recorder/ Dual communication logger	FX106-4-1	S5JA01445	Yokogawa	Not applicable.	--
HT831	Digital multi-meter	115	15540244	Fluke	26 May 2017	1 year

### (3) Frequency stability – temperature & voltage

C/N	Instrument	Type	S/N	Manufacturer	Date of last calibration	Calibration interval
HT370	Climatic chamber (Large)	TBE-3HW5GE2F	3013000995	Espec	17 August 2017	1 year
HT723	Paperless recorder/ Dual communication logger	FX106-4-1	S5JA01445	Yokogawa	Not Applicable.	--
RT213	Waveguide	WRJ-10	Not assigned	Furuno	4 July 2017	1 year
HT654	Attenuator	8494B	MY42148134	Agilent	21 February 2018	1 year
HT728	Attenuator	8495B	MY42145734	Agilent	14 December 2017	1 year
--	Attenuator	47-30-21	--	Aeroflex/ Weinschel	Not Applicable.	--
HT676	Spectrum Analyzer	8564EC	4103A00440	Agilent	12 April 2017	1 year
HT1204	Programmable AC power source	DP045M	9158465	NF	Not applicable.	--
HT831	Digital multi-meter	115	15540244	Fluke	26 May 2017	1 year

**(4) Occupied bandwidth**

C/N	Instrument	Type	S/N	Manufacturer	Date of last calibration	Calibration interval
HT370	Climatic chamber (Large)	TBE-3HW5GE2F	3013000995	Espec	17 August 2017	1 year
HT723	Paperless recorder/ Dual communication logger	FX106-4-1	S5JA01445	Yokogawa	Not Applicable.	--
RT213	Waveguide	WRJ-10	Not assigned	Furuno	4 July 2017	1 year
HT654	Attenuator	8494B	MY42148134	Agilent	21 February 2018	1 year
HT728	Attenuator	8495B	MY42145734	Agilent	14 December 2017	1 year
--	Attenuator	47-30-21	--	Aeroflex/ Weinschel	Not Applicable.	--
HT676	Spectrum analyzer	8564EC	4103A00440	Agilent	12 April 2017	1 year
HT1204	Programmable AC power source	DP045M	9158465	NF	Not applicable.	--
HT831	Digital multi-meter	115	15540244	Fluke	26 May 2017	1 year

**(5) Spurious emissions at antenna port**

C/N	Instrument	Type	S/N	Manufacturer	Date of last calibration	Calibration interval
HT370	Climatic chamber (Large)	TBE-3HW5GE2F	3013000995	Espec	17 August 2017	1 year
HT723	Paperless recorder/ Dual communication logger	FX106-4-1	S5JA01445	Yokogawa	Not Applicable.	--
RT213	Waveguide	WRJ-10	Not assigned	Furuno	4 July 2017	1 year
HT654	Attenuator	8494B	MY42148134	Agilent	21 February 2018	1 year
HT728	Attenuator	8495B	MY42145734	Agilent	14 December 2017	1 year
--	Attenuator	47-30-21	--	Aeroflex/ Weinschel	Not Applicable.	--
--	Adapter	BL00-6254-00	--	Orient Microwave	Not Applicable.	--
--	Adapter	PE9803 WR-62	--	Pasternack	Not Applicable.	--
--	Adapter	PE9803 WR-42	--	Pasternack	Not Applicable.	--
--	Adapter	PE9803 WR-28	--	Pasternack	Not Applicable.	--
HT676	Spectrum analyzer	8564EC	4103A00440	Agilent	12 April 2017	1 year
HT1204	Programmable AC power source	DP045M	9158465	NF	Not applicable.	--
HT831	Digital multi-meter	115	15540244	Fluke	26 May 2017	1 year

**(6) Field strength of spurious radiation**

C/N	Instrument	Type	S/N	Manufacturer	Date of last calibration	Calibration interval
HT744	Radiated emission measurement software	EP5/RE	Ver. 5.6.0	Toyo	Not applicable.	--
HT745	EMI test receiver (20 Hz to 40 GHz)	ESU40	110243	Rohde & Schwarz	29 December 2017	1 year
HT758	Broadband horn antenna (1 GHz to 6 GHz)	BBHA9120B	522	Schwarzbeck	3 January 2018	1 year
NK004	Double ridged horn antenna	TR17206	93370015	Advantest	15 December 2017	1 year
NK012	Pre-amplifier	8449B	3008A01286	Agilent	30 January 2018	1 year
HT762	Double ridged horn antenna & amp.	HAP26-40N	00000010	Toyo	7 December 2017	1 year
HT755	Pre-amplifier	TPA0108-40	1017	Toyo	21 July 2017	1 year
HT779	Semi-anechoic chamber	10mSAC	90984	Tokin	--	--
HT780	Programmable AC/DC power supply	ES18000W	9128767-1+ 9128767-2	NF	Not applicable.	--

## 6 RF Envelope and Spectrum of the Output Pulse

CH1, Horizontal

P0N

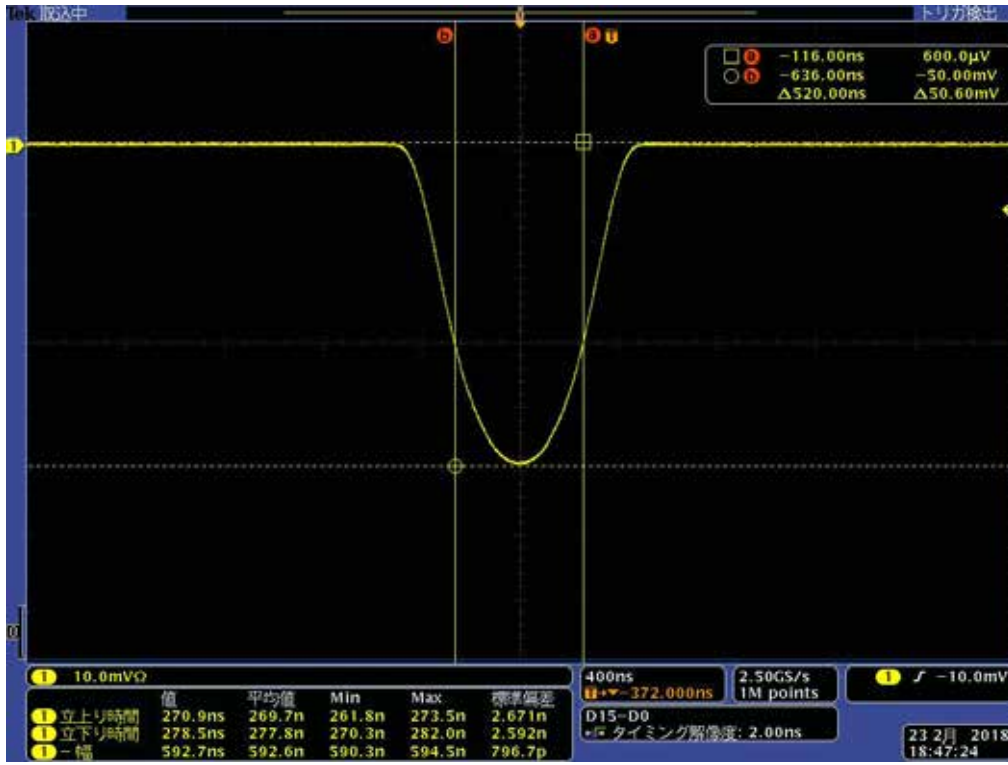

Fig. 6.1 Short pulse envelope

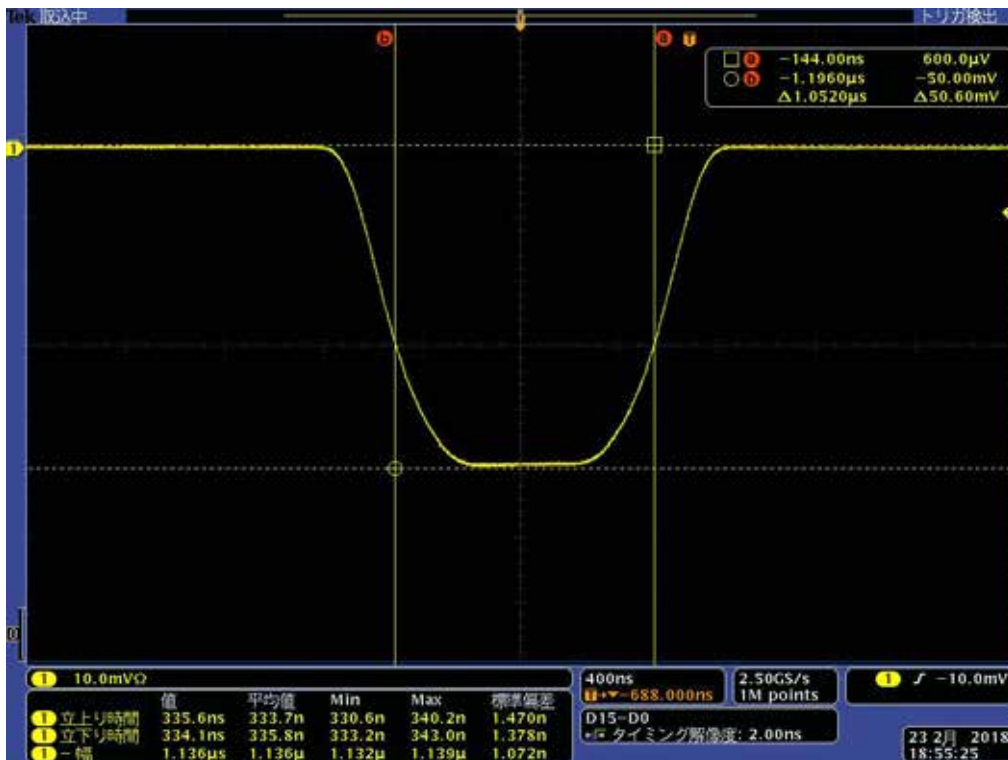

Fig. 6.2 Long pulse envelope

Q0N



Fig. 6.3 Short pulse envelope



Fig. 6.4 Long pulse envelope



CH1, Vertical

P0N

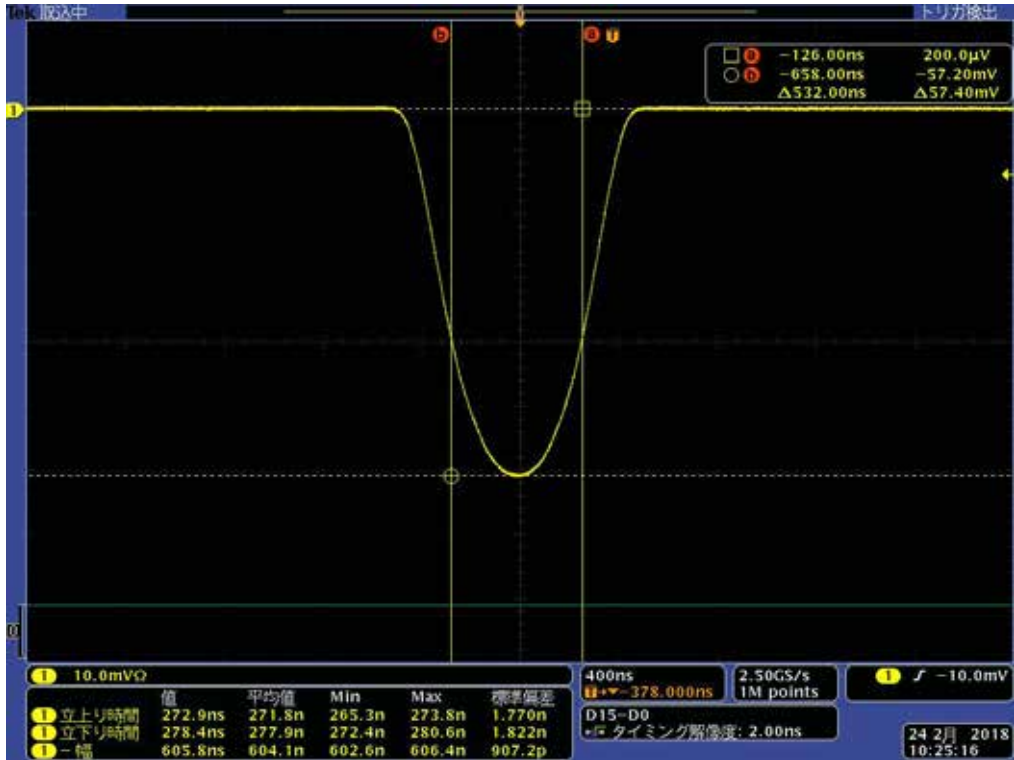

Fig. 6.5 Short pulse envelope

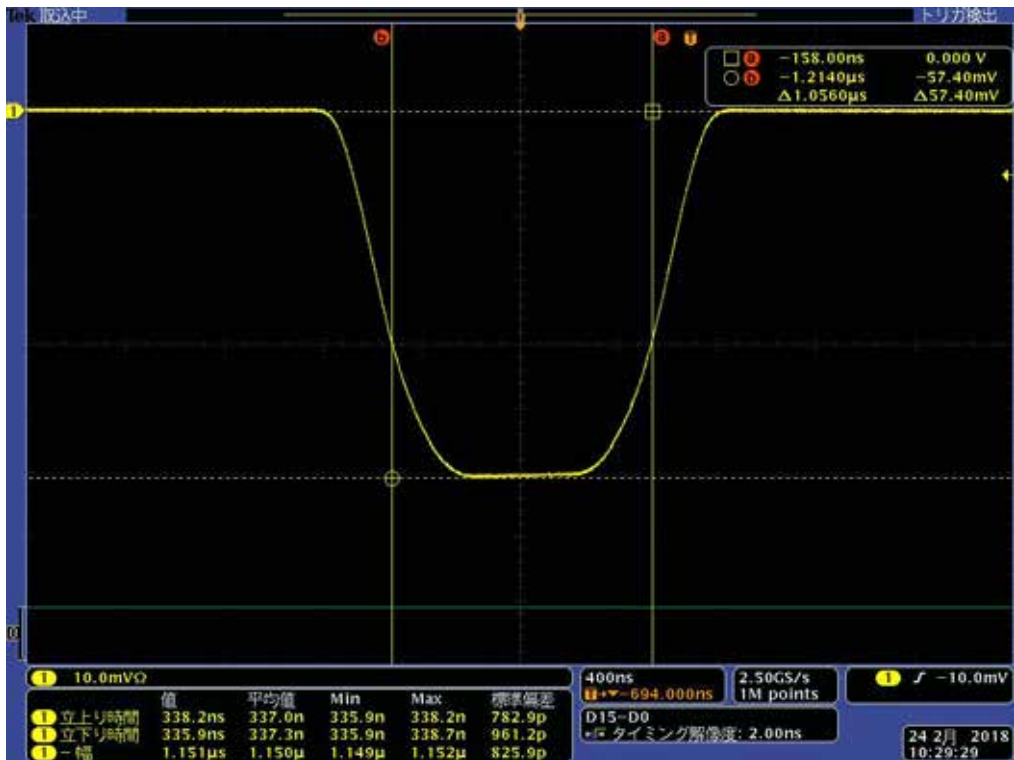

Fig. 6.6 Long pulse envelope

Q0N



Fig. 6.7 Short pulse envelope



Fig. 6.8 Long pulse envelope

CH3, Horizontal

P0N

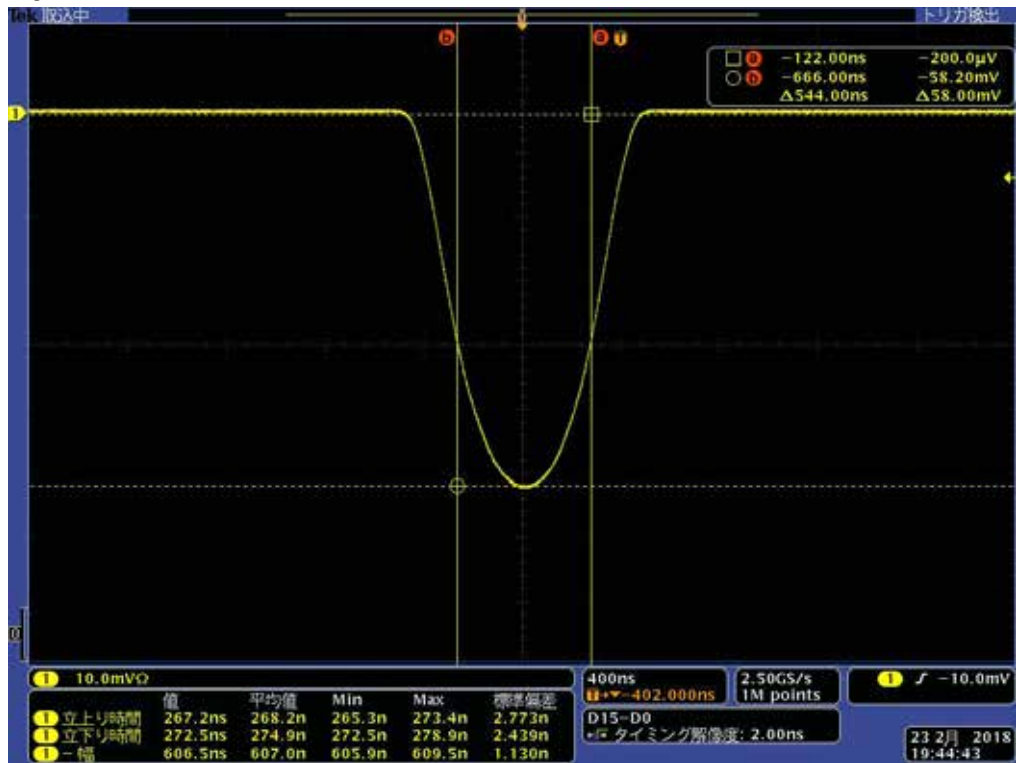

Fig. 6.9 Short pulse envelope

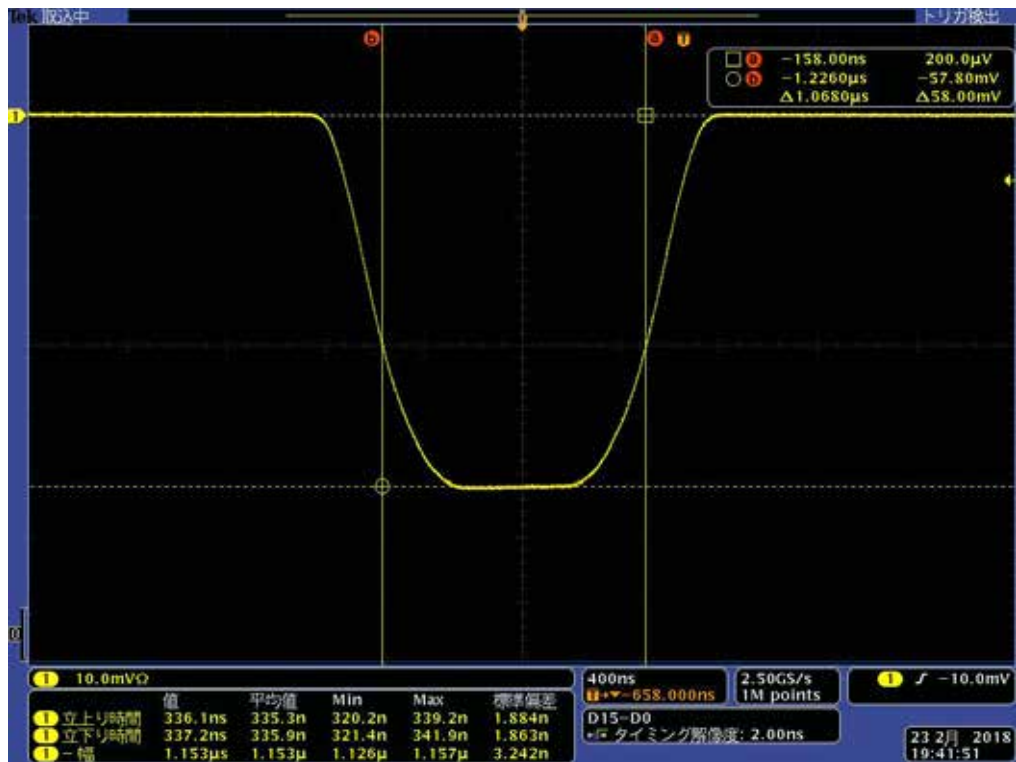

Fig. 6.10 Long pulse envelope

Q0N



Fig. 6.11 Short pulse envelope

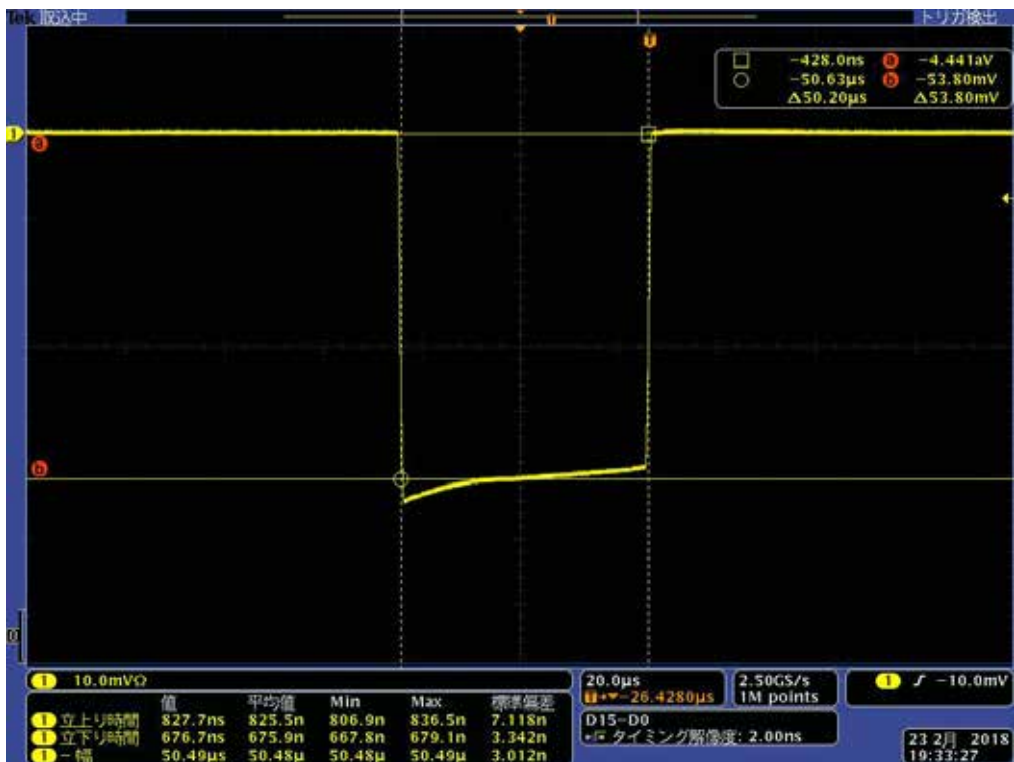

Fig. 6.12 Long pulse envelope

CH3, Vertical

P0N

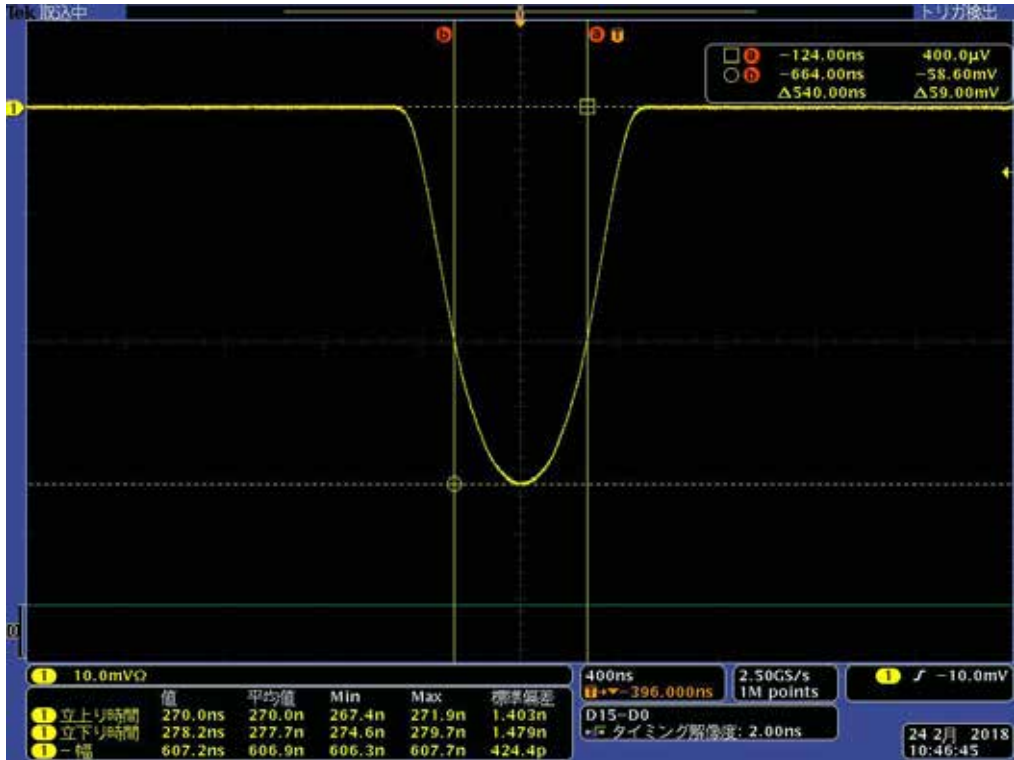

Fig. 6.13 Short pulse envelope

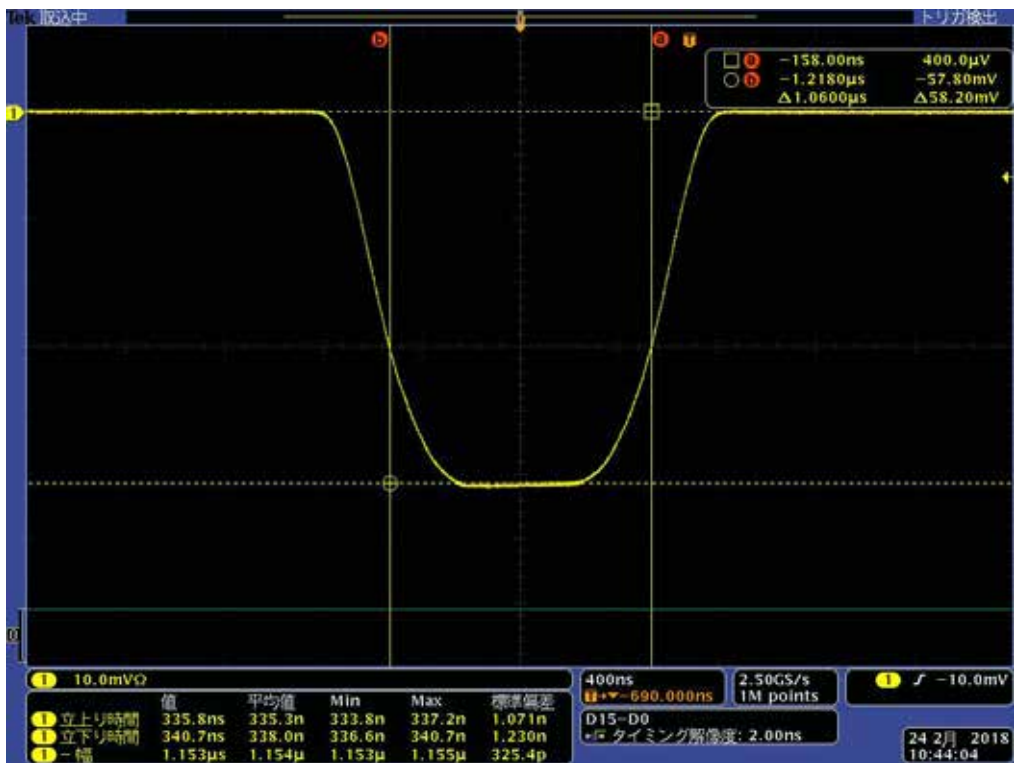

Fig. 6.14 Long pulse envelope

Q0N



Fig. 6.15 Short pulse envelope



Fig. 6.16 Long pulse envelope

CH4, Horizontal

P0N

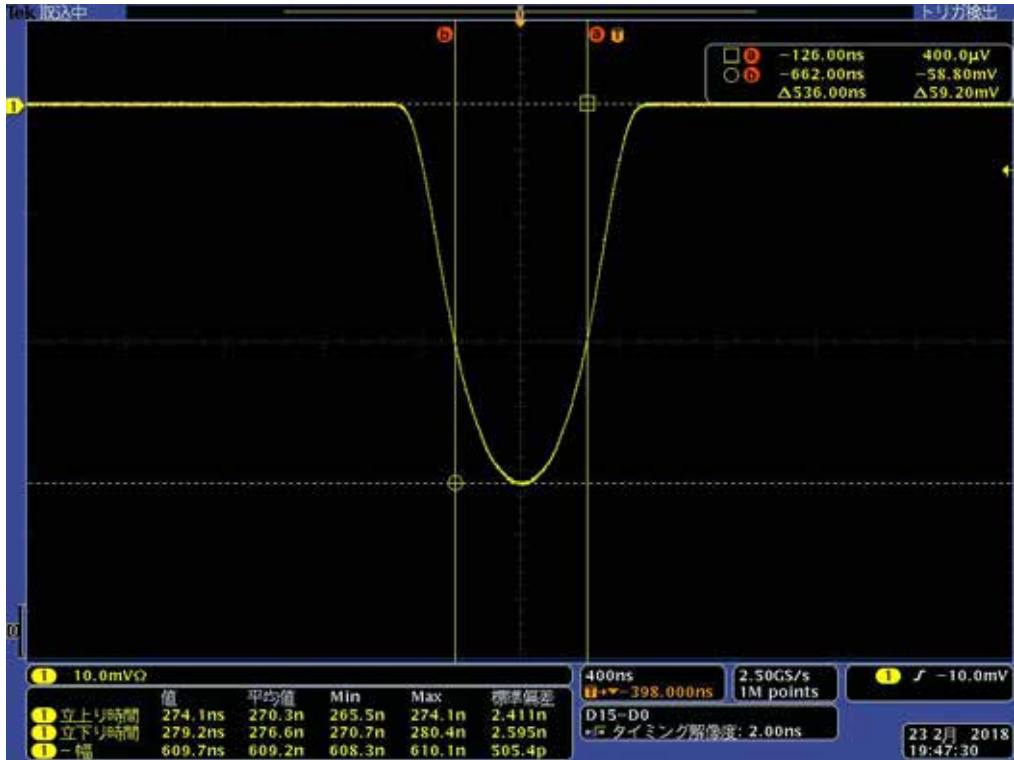

Fig. 6.17 Short pulse envelope

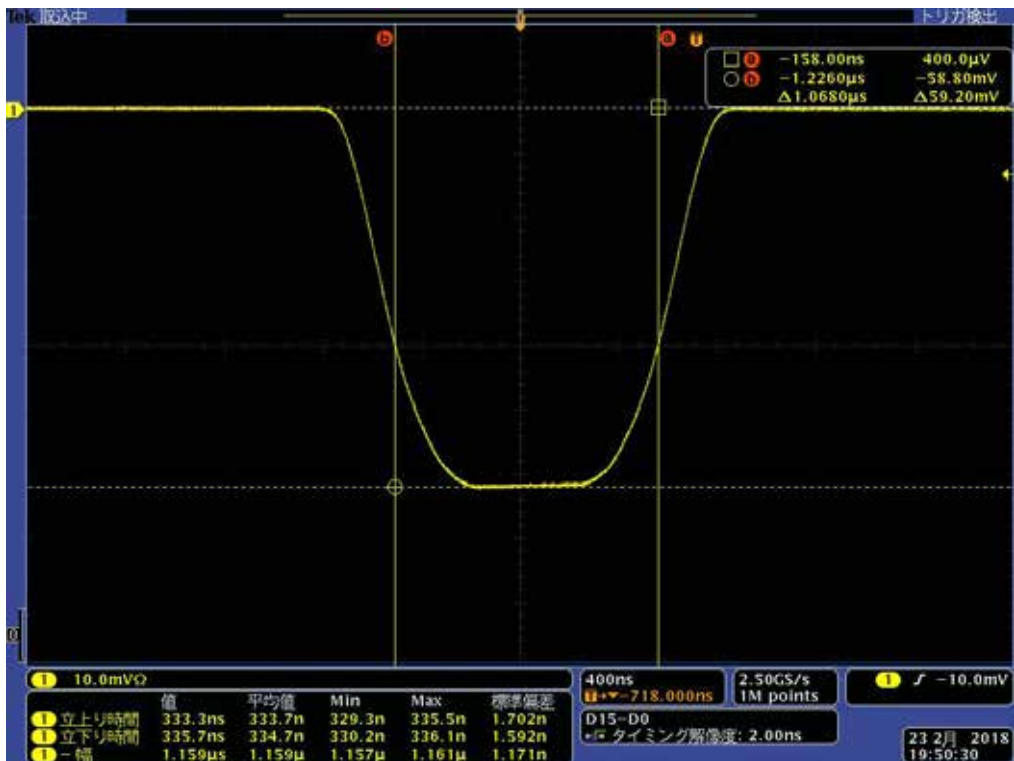

Fig. 6.18 Long pulse envelope

Q0N



Fig. 6.19 Short pulse envelope



Fig. 6.20 Long pulse envelope



CH4, Vertical

P0N

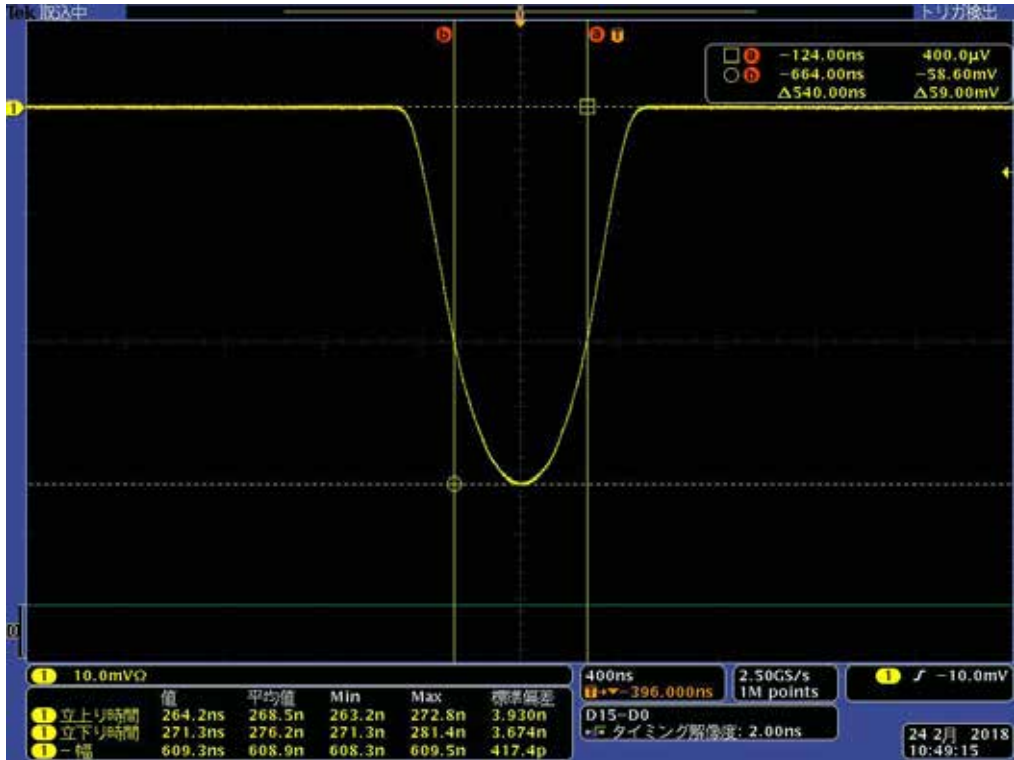

Fig. 6.21 Short pulse envelope

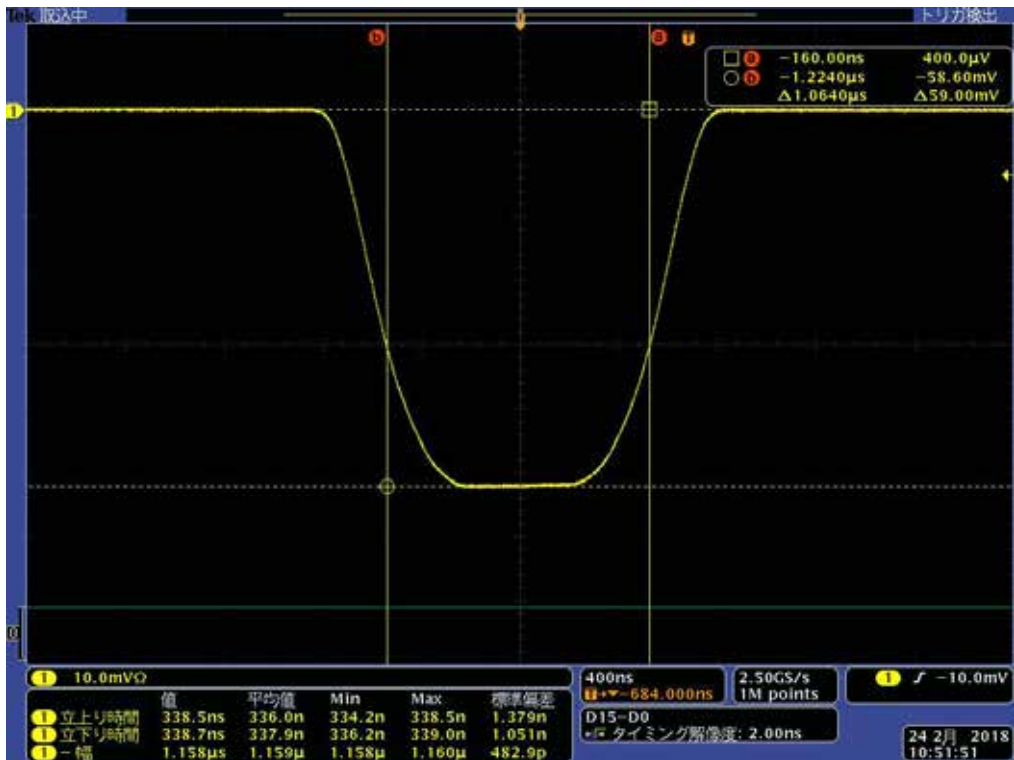

Fig. 6.22 Long pulse envelope

Q0N



Fig. 6.23 Short pulse envelope



Fig. 6.24 Long pulse envelope

## 7 Spurious Emission Plots measured at Antenna Terminal

CH1, Horizontal

P0N

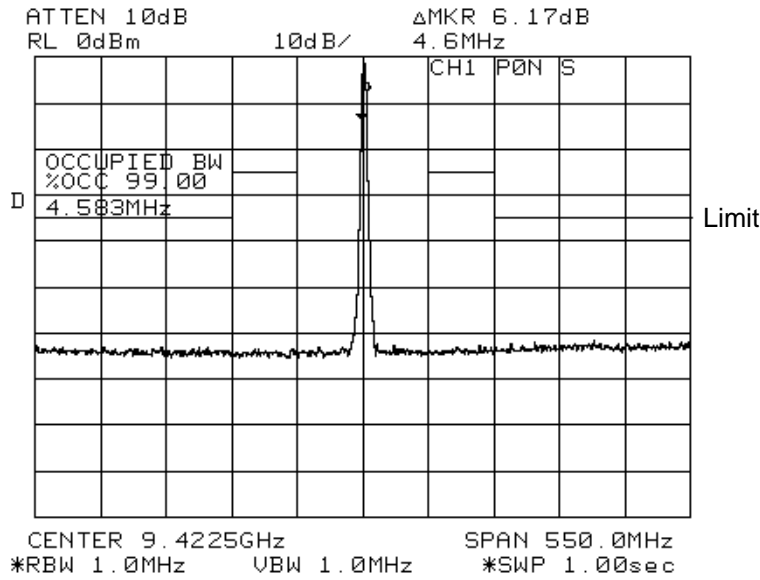

Fig. 7.1 CH1, Horizontal, P0N, Short pulse

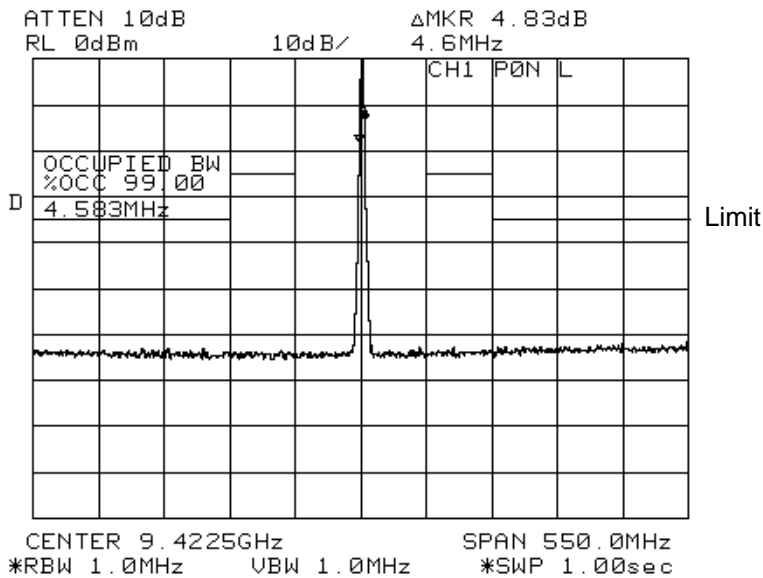

Fig. 7.2 CH1, Horizontal, P0N, Long pulse

**Q0N**

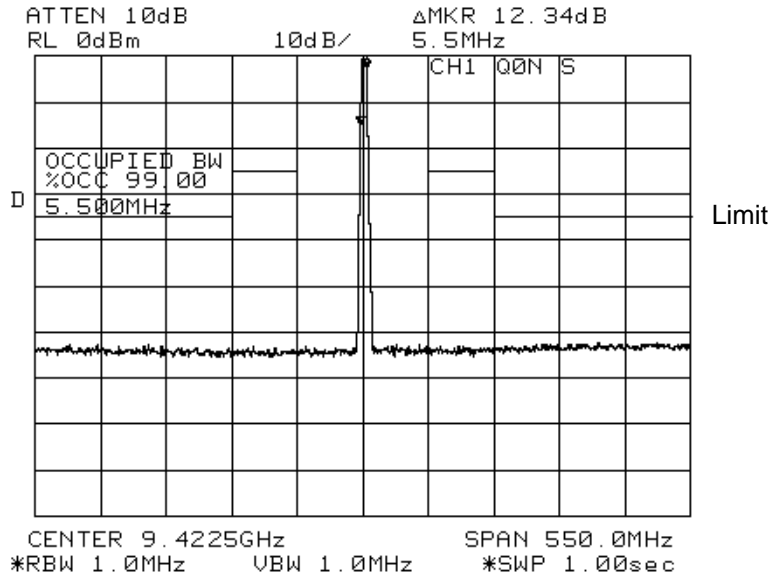

Fig. 7.3      CH1, Horizontal, Q0N, Short pulse

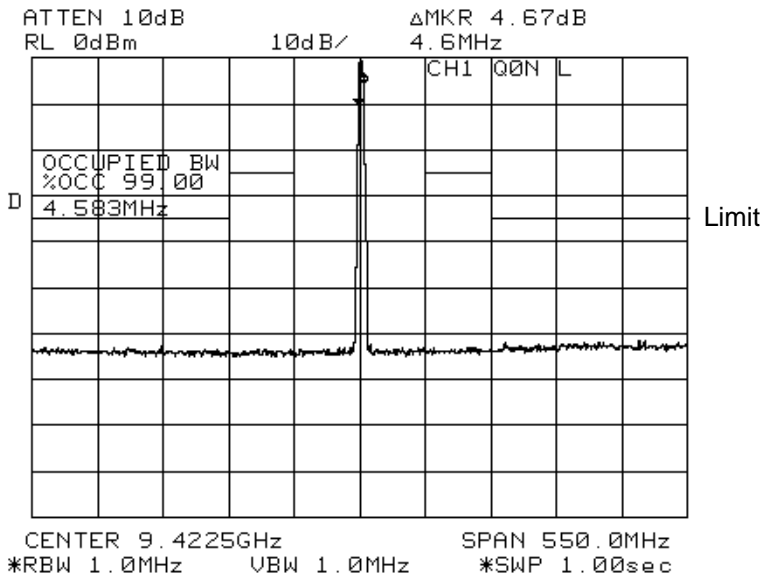

Fig. 7.4      CH1, Horizontal, Q0N, Long pulse





**CH3, Horizontal  
P0N**

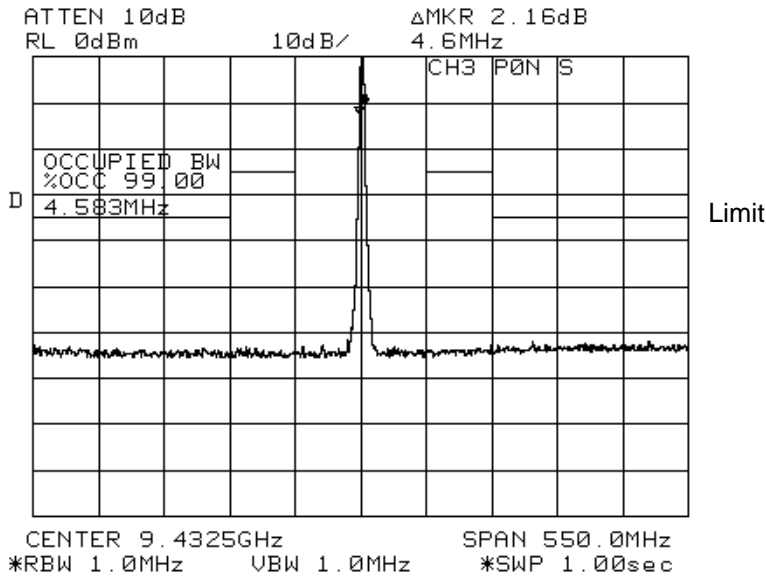

Fig. 7.9 CH3, Horizontal, P0N, Short pulse

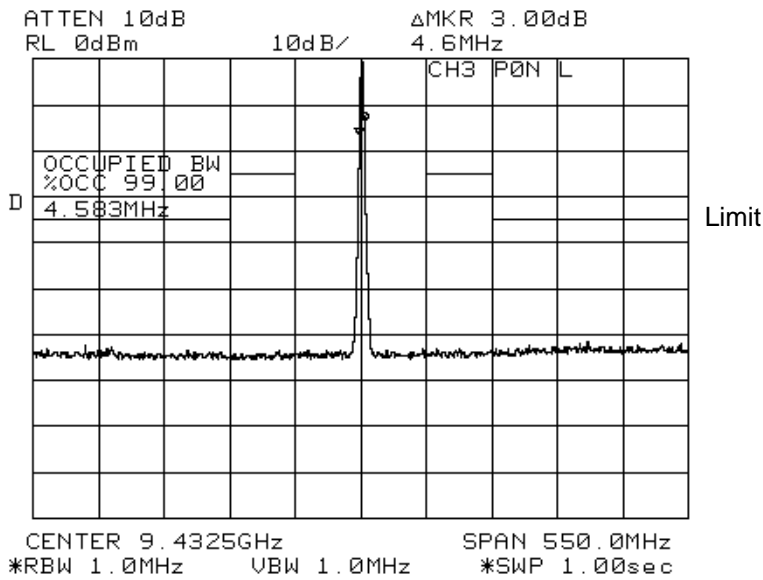

Fig. 7.10 CH3, Horizontal, P0N, Long pulse

**Q0N**

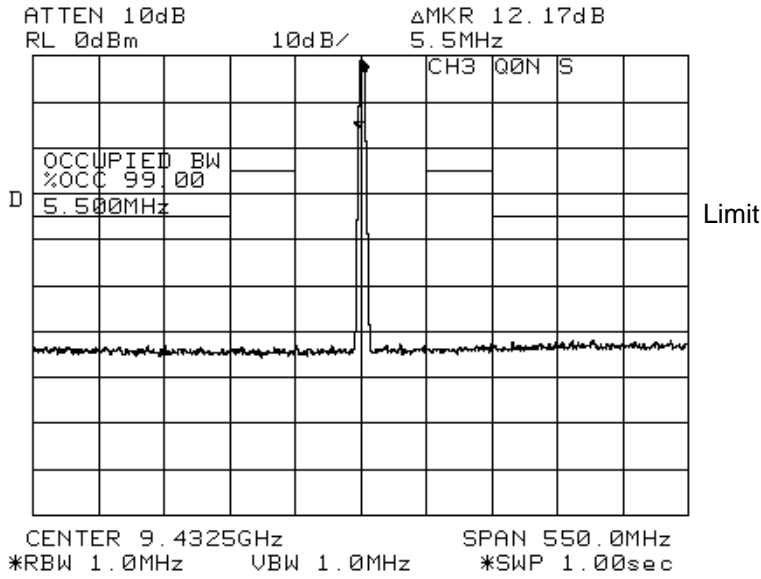

Fig. 7.11 CH3, Horizontal, Q0N, Short pulse

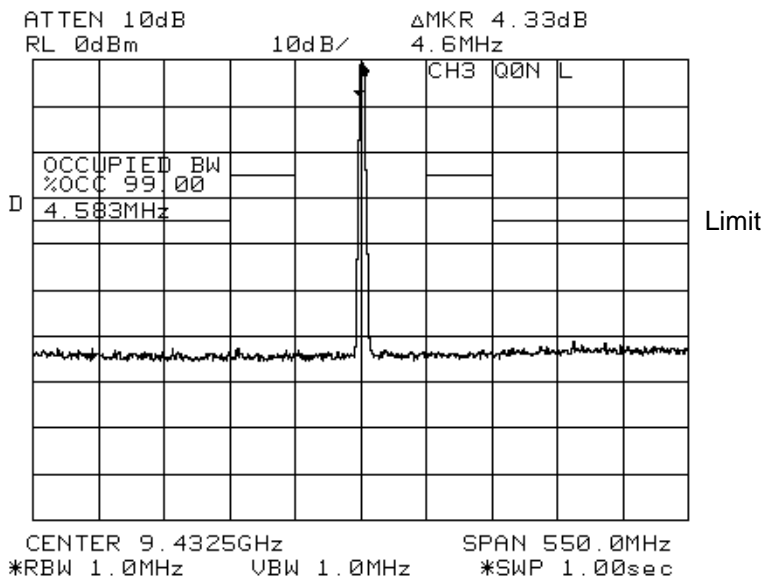

Fig. 7.12 CH3, Horizontal, Q0N, Long pulse



**CH3, Vertical  
P0N**

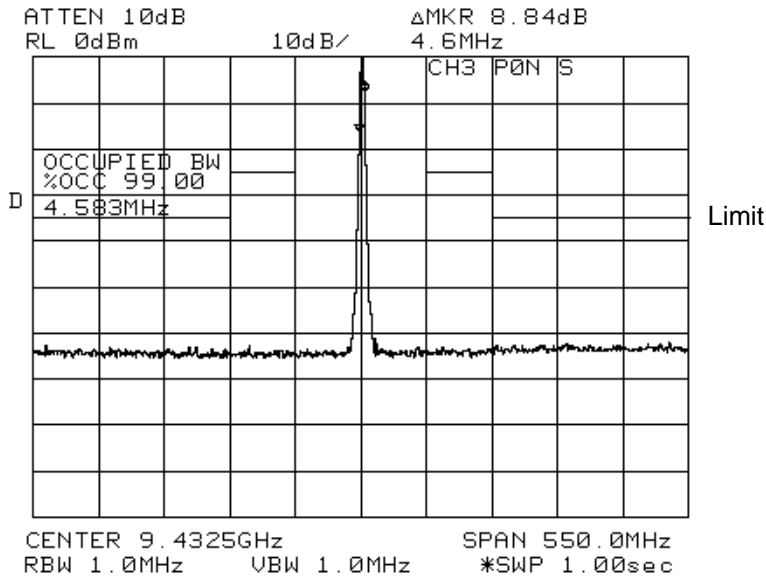

Fig. 7.13 CH3, Vertical, P0N, Short pulse

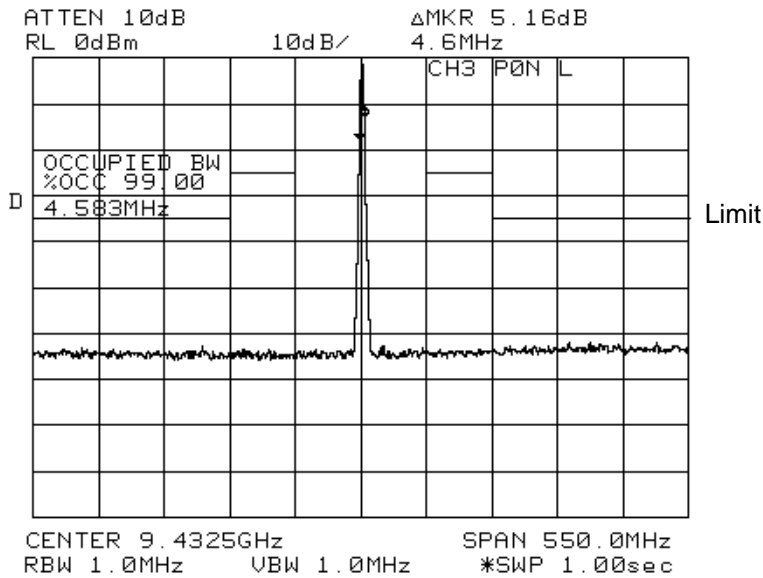

Fig. 7.14 CH3, Vertical, P0N, Long pulse

**Q0N**

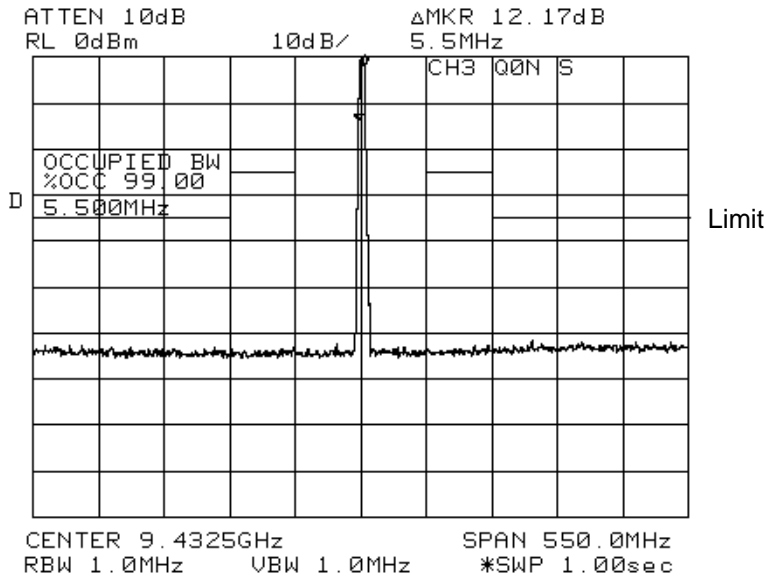

Fig. 7.15 CH3, Vertical, Q0N, Short pulse

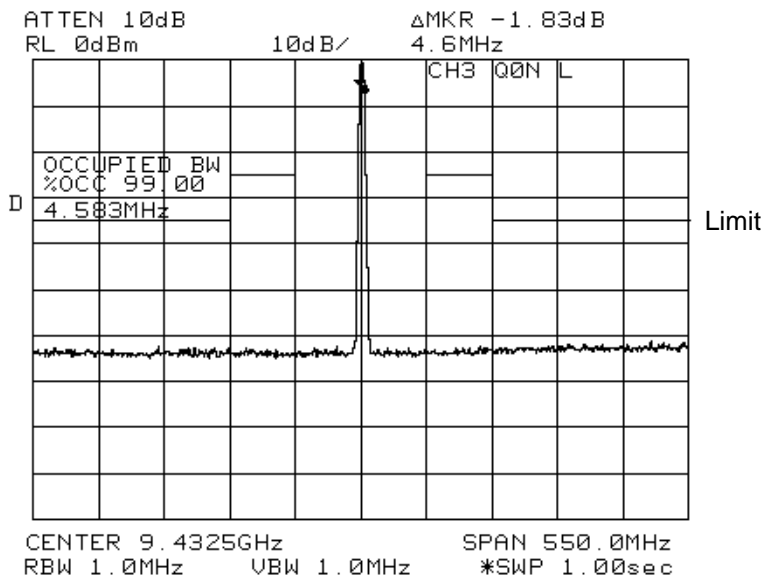

Fig. 7.16 CH3, Vertical, Q0N, Long pulse

**CH4, Horizontal  
P0N**

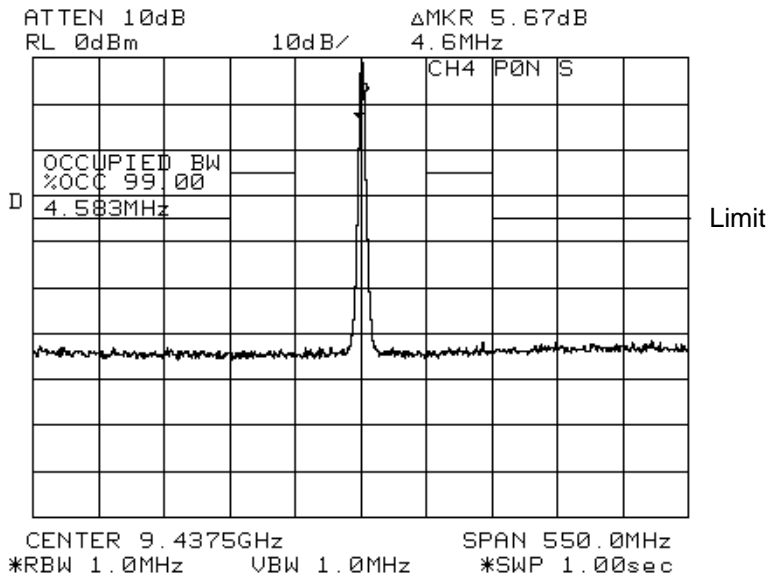

Fig. 7.17 CH4, Horizontal, P0N, Short pulse

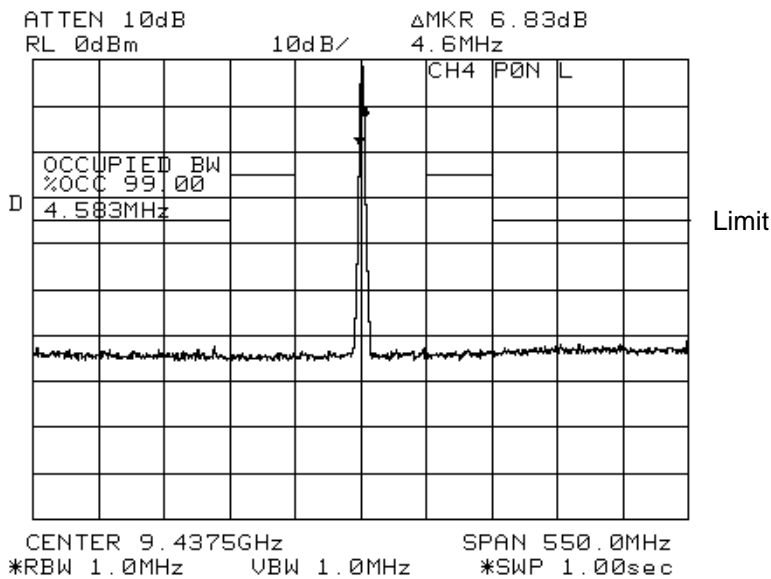

Fig. 7.18 CH4, Horizontal, P0N, Long pulse

**Q0N**

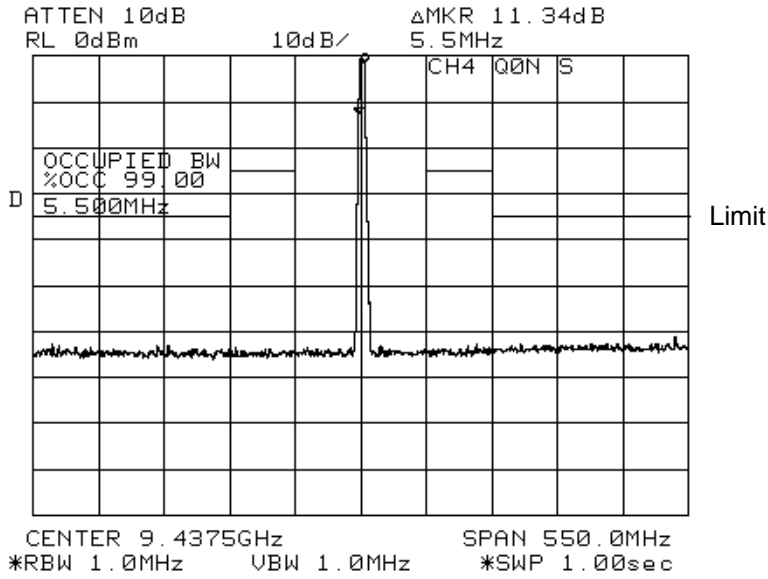

Fig. 7.19 CH4, Horizontal, Q0N, Short pulse

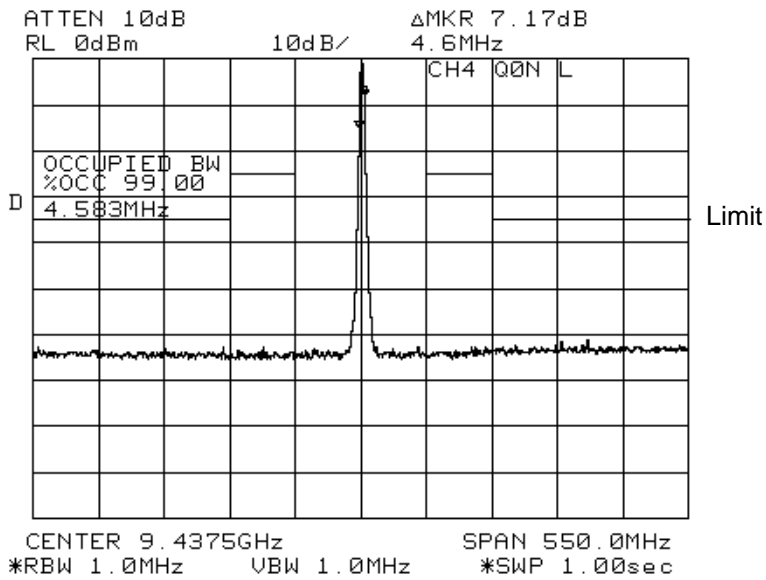

Fig. 7.20 CH4, Horizontal, Q0N, Long pulse

**CH4, Vertical  
P0N**

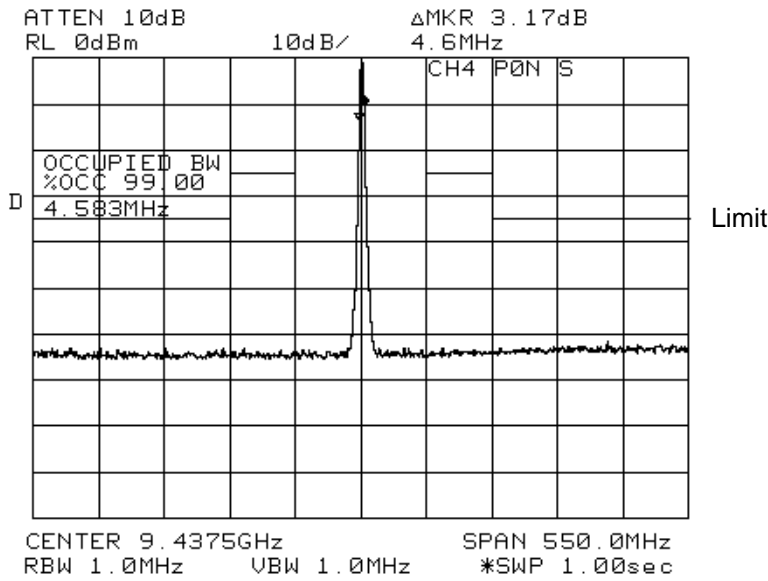

Fig. 7.21 CH4, Vertical, P0N, Short pulse

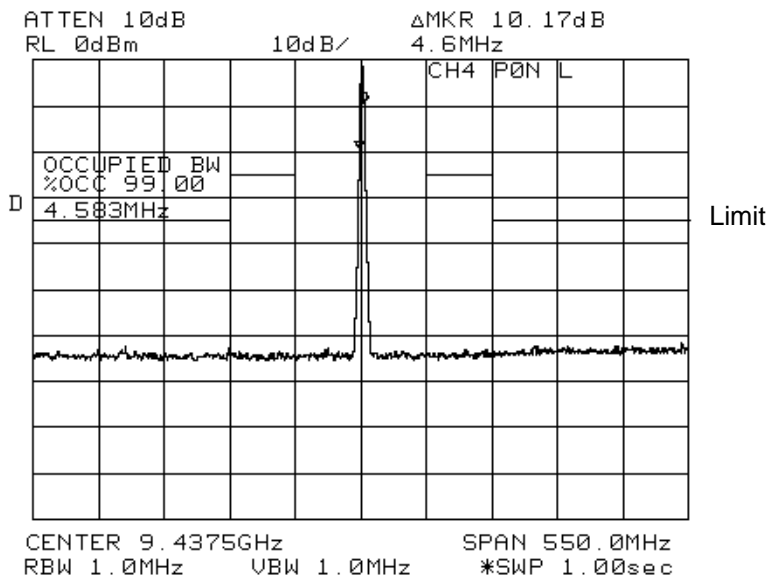

Fig. 7.22 CH4, Vertical, P0N, Long pulse

**Q0N**

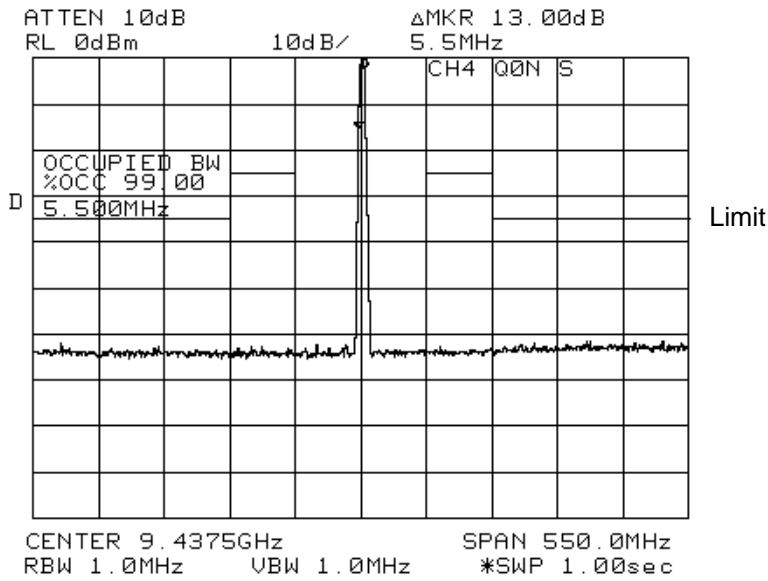

Fig. 7.23 CH4, Vertical, Q0N, Short pulse

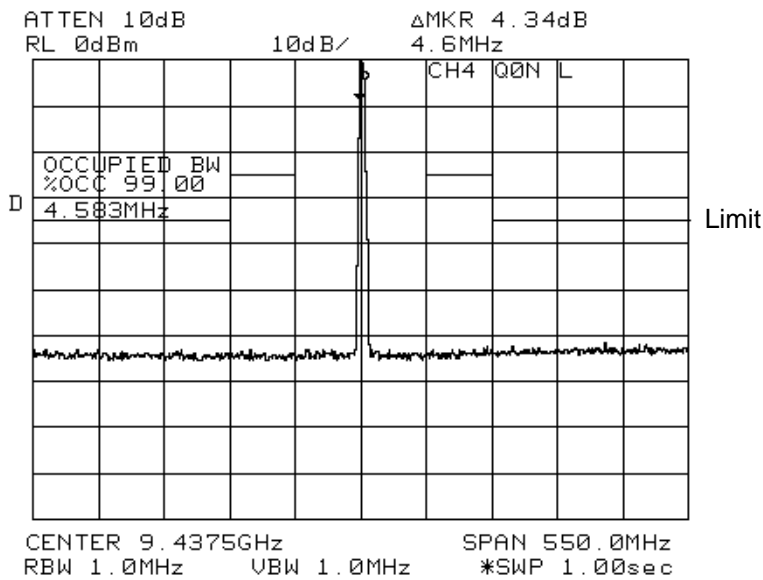

Fig. 7.24 CH4, Vertical, Q0N, Long pulse

End of Text