

FURUNO

OPERATOR'S MANUAL

MARINE RADAR

FAR-2218

FAR-2218-BB

FAR-2228

FAR-2228-BB

FAR-2228-NXT

FAR-2228-NXT-BB

FAR-2238S

FAR-2238S-BB

FAR-2238S-NXT

FAR-2238S-NXT-BB

FAR-2318

FAR-2328

FAR-2328-NXT

FAR-2328W

FAR-2338SW

FAR-2338S

FAR-2338S-NXT

FAR-2018-MARK-2

FAR-2028-MARK-2

FURUNO ELECTRIC CO., LTD.

9-52 Ashihara-cho,
Nishinomiya, 662-8580, JAPAN

• FURUNO Authorized Distributor/Dealer

All rights reserved. Printed in Japan

Pub. No. OME-36520-L30

(REFU) FAR-2xx8 series

A : NOV. 2017

L30 : DEC . 19, 2022



0 0 0 1 9 9 5 2 7 1 0

IMPORTANT NOTICES

General

- This manual has been authored with simplified grammar, to meet the needs of international users.
- The operator of this equipment must read and follow the instructions in this manual. Wrong operation or maintenance can void the warranty or cause injury.
- Do not copy any part of this manual without written permission from FURUNO.
- If this manual is lost or worn, contact your dealer about replacement.
- The contents of this manual and the equipment specifications can change without notice.
- The example screens (or illustrations) shown in this manual can be different from the screens you see on your display. The screens you see depend on your system configuration and equipment settings.
- Save this manual for future reference.
- Any modification of the equipment (including software) by persons not authorized by FURUNO will void the warranty.
- The following concern acts as our importer in Europe, as defined in DECISION No 768/2008/EC.
 - Name: FURUNO EUROPE B.V.
 - Address: Siriusstraat 86, 5015 BT, Tilburg, The Netherlands
- The following concern acts as our importer in UK, as defined in SI 2016/1025 as amended SI 2019/470.
 - Name: FURUNO (UK) LTD.
 - Address: West Building Penner Road Havant Hampshire PO9 1QY, U.K.
- InstantAccess bar™ is a registered trademark of FURUNO Electric co., Ltd.
- SDHC is a registered trademark of SD-3C, LLC.
- All brand, product names, trademarks, registered trademarks, and service marks belong to their respective holders.

How to discard this product

Discard this product according to local regulations for the disposal of industrial waste. For disposal in the USA, see the homepage of the Electronics Industries Alliance (<http://www.eiae.org/>) for the correct method of disposal.

How to discard a used battery

Some FURUNO products have a battery(ies). To see if your product has a battery, see the chapter on Maintenance. If a battery is used, tape the + and - terminals of the battery before disposal to prevent fire, heat generation caused by short circuit.

In the European Union

The crossed-out trash can symbol indicates that all types of batteries must not be discarded in standard trash, or at a trash site. Take the used batteries to a battery collection site according to your national legislation and the Batteries Directive 2006/66/EU.

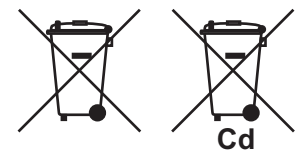

In the USA

The Mobius loop symbol (three chasing arrows) indicates that Ni-Cd and lead-acid rechargeable batteries must be recycled. Take the used batteries to a battery collection site according to local laws.





In the other countries

There are no international standards for the battery recycle symbol. The number of symbols can increase when the other countries make their own recycle symbols in the future.















SAFETY INSTRUCTIONS

The operator must read the applicable safety instructions before attempting to operate the equipment.

 DANGER	Indicates a potentially hazardous situation which, if not avoided, could result in death or serious injury.
 WARNING	Indicates a potentially hazardous situation which, if not avoided, could result in death or serious injury.
 CAUTION	Indicates a potentially hazardous situation which, if not avoided, could result in minor or moderate injury.

 Warning, Caution	 Prohibitive Action	 Mandatory Action
--	--	--

 WARNING	
	ELECTRICAL SHOCK HAZARD. Do not open the equipment. Only qualified personnel should work inside the equipment.
	Turn off the radar power switch before servicing the antenna unit. Post a warning sign near the switch indicating it should not be turned on while the antenna unit is being serviced. If the antenna rotates while there is personnel nearby or servicing the antenna, injury or death may result.
	Do not disassemble or modify the equipment. Fire, electrical shock or serious injury can result.
	Immediately turn off the power at the ship's mains switchboard if water leaks into the equipment or the equipment is emitting smoke or fire. Continued use can cause fatal damage to the equipment.

 WARNING	
	Use the proper fuse. Use of a wrong fuse can result in damage to the equipment or cause fire.
	Keep heater away from equipment. Heat can alter equipment shape and melt the power cord, which can cause fire or electrical shock.
	Do not place liquid-filled containers near the equipment. Fire or electrical shock can result if a liquid spills into the equipment.
	Do not operate the equipment with wet hands. Electrical shock can result.
	Before servicing the radar, turn off the appropriate external breaker. Power is not removed from the radar simply by turning off its power switch.
	This equipment has a valid latitude range of 85°N to 85°S. Operation outside of this range can result in a larger margin of error when calculating position, heading, bearing, etc.

WARNING

Keep the area around the antenna free of ropes and other items that may get tangled.

If the antenna becomes tangled, damage to the equipment or injury to personnel may occur.

WARNING

Make sure no rain or water splash leaks into the equipment.

Fire or electrical shock can result if water leaks into the equipment.

WARNING

Radio Frequency Radiation Hazard

The radar antenna emits electromagnetic radio frequency (RF) energy that can be harmful, particularly to your eyes. Never look directly into the antenna aperture from a close distance while the radar is in operation or expose yourself to the transmitting antenna at a close distance. Distances at which RF radiation level of 100, 50 and 10 W/m² are given in the table below.

Note: If the antenna unit is installed at a close distance in front of the wheel house, your administration may require halt of transmission within a certain sector of antenna revolution. This is possible. Ask your FURUNO representative or dealer to provide this feature.

	Model	Transceiver	Magnetron	Antenna*	100 W/m ²	50 W/m ²	10 W/m ²
Magnetron radar	FAR-2218(-BB) FAR-2318	RTR-105 (12 kW)	FNE1201	XN12CF	0.6 m	1.4 m	4.4 m
				XN20CF	0.4 m	0.9 m	3.0 m
	XN24CF	0.3 m		0.6 m	2.5 m		
	XN12AF	0.25 m		0.73 m	4.2 m		
	XN20AF	0.17 m		0.42 m	2.6 m		
	XN24AF	N/A		0.28 m	1.73 m		
	FAR-2018-MARK-2	RTR-131 (12 kW)	MG5436	XN12CF	1.3 m	2.7 m	9.5 m
				XN20CF	1.0 m	1.7 m	6.8 m
				XN24CF	0.7 m	1.3 m	5.5 m
				XN20CF	0.5 m	1.2 m	5.5 m
				XN24CF	0.3 m	0.9 m	4.0 m
				XN12AF	0.82 m	1.8 m	8.84 m
	FAR-2228(-BB) FAR-2328	RTR-106 (25 kW)	MG5223F	XN20AF	0.51 m	0.93 m	5.76 m
				XN24AF	0.3 m	0.7 m	4.01 m
FAR-2328W	RTR-108 (25 kW)	MG5223F	SN24CF**	1.7 m	2.4 m	3.8 m	
			SN30CF**	1.4 m	2.1 m	3.4 m	
FAR-2028-MARK-2	RTR-132 (25 kW)	MG5223F	SN36CF	N/A	0.5 m	4.6 m	
			SN36CF	N/A	0.26 m	2.3 m	
FAR-2238S(-BB) FAR-2338S	RTR-107 (30 kW)	MG5223F	SN36CF	N/A	0.26 m	2.3 m	
			SN36CF	N/A	0.26 m	2.3 m	
Solid state radar	FAR-2228-NXT(-BB) FAR-2328-NXT	RTR-123 (600 W***)	—	XN12CF	0.3 m	0.7 m	3.3 m
				XN20CF	0.24 m	0.32 m	1.9 m
				XN24CF	0.19 m	0.29 m	1.6 m
	SN24CF**	N/A		N/A	N/A		
	SN30CF**	N/A		N/A	N/A		
	SN36CF	N/A		N/A	N/A		
FAR-2238S-NXT(-BB) FAR-2338S-NXT	RTR-111 (250 W)	—	—	SN24CF**	N/A	N/A	N/A
				SN30CF**	N/A	N/A	N/A
				SN36CF	N/A	N/A	N/A

*: The following numerical values, shown in the antenna types, indicate antenna length.

[12]: 4 ft, [20]: 6.5 ft, [24]: 8 ft, [30]: 10 ft, [36]: 12 ft

** : Unavailable on IMO-type radars

*** : 500 W for a Japanese flag vessel.

⚠ WARNING

No one navigational aid should be relied upon for the safety of vessel and crew. The navigator has the responsibility to check all aids available to confirm position. Electronic aids are not a substitute for basic navigational principles and common sense.

- ◆ This TT automatically tracks automatically or manually acquired radar targets and calculates their courses and speeds, indicating them by vectors. Since the data generated by the auto plotter are based on what radar targets are selected, the radar must always be optimally tuned for use with the auto plotter, to ensure required targets will not be lost or unwanted targets such as sea returns and noise will not be acquired and tracked.
- ◆ A target does not always mean a land-mass, reef, ships or other surface vessels but can imply returns from sea surface and clutter. As the level of clutter changes with environment, the operator should properly adjust the A/C SEA, A/C RAIN and GAIN controls to be sure target echoes are not eliminated from the radar screen.

⚠ CAUTION

The plotting accuracy and response of this TT meets IMO standards. Tracking accuracy is affected by the following:

- ◆ Tracking accuracy is affected by course change. One to two minutes is required to restore vectors to full accuracy after an abrupt course change. (The actual amount depends on gyrocompass specifications.)
- ◆ The amount of tracking delay is inversely proportional to the relative speed of the target. Delay is on the order of 15 - 30 seconds for high relative speed; 30 - 60 seconds for low relative speed.
- ◆ The target tracking and pertinent vector calculation accuracy is influenced by the following:
 - Echo intensity
 - The range measurement accuracy; characterized by both random and biased measurement errors.
 - The angular measurement accuracy; characterized by beam shape, target glint and bias errors.
 - Radar transmission pulsewidth
 - Gyrocompass heading error
 - Speed log error
 - Current and wind (set & drift)
 - Course change (own ship and target)

The data generated by TT, AIS and video plotter are intended for reference only.

Refer to official nautical charts for detailed and up-to-date information.

WARNING LABEL

Warning labels are attached to the equipment. Do not remove any label. If a label is missing or damaged, contact a FURUNO agent or dealer about replacement.



Name: Warning Label 1
 Type: 86-003-1011-3
 Code No.: 100-236-233-10

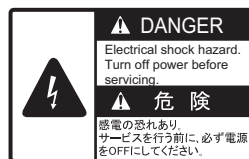

Name: Warning Label
 Type: 03-160-1042-0
 Code No.: 100-302-750-10

TABLE OF CONTENTS

FOREWORD	xii
SYSTEM CONFIGURATION	xvii
1. OPERATIONAL OVERVIEW	1-1
1.1 Controls Overview	1-1
1.1.1 Control Unit RCU-014	1-1
1.1.2 Control Unit RCU-015/RCU-016	1-3
1.2 How to Turn the Radar On/Off.....	1-4
1.3 How to Adjust the Brilliance.....	1-4
1.4 Display Indications.....	1-5
1.4.1 InstantAccess bar™ buttons	1-6
1.4.2 Radar display and shortcuts	1-7
1.4.3 Information and settings	1-9
1.5 Menu Operations	1-10
1.5.1 How to open and close the main menu	1-10
1.5.2 How to operate the menus	1-10
1.6 How to Use the On-screen Box Menus	1-12
1.7 How to Use the CURSOR Menu	1-13
1.8 Cursor Data	1-14
1.8.1 How to change the cursor data attributes (B/W-type only).....	1-15
1.9 How to Set Up Function Keys.....	1-15
1.10 How to Customize Operation.....	1-17
1.11 How to Select the Interface for Heading Input.....	1-19
1.12 How to Set Own Ship's Speed	1-19
1.12.1 Automatic speed input (log or EPFS navigator)	1-19
1.12.2 Manual speed input	1-21
1.13 How to Set the Own Ship Position.....	1-21
1.14 How to Adjust the Date and Time.....	1-22
1.15 User Settings	1-23
1.15.1 How to reset the user settings	1-25
1.15.2 How to save/load user settings	1-25
1.16 How to Start/Stop Transmission	1-26
1.17 How to Tune the Receiver (Magnetron Radars Only)	1-27
1.17.1 How to select the tuning method	1-27
1.17.2 How to initialize tuning.....	1-27
1.17.3 How to tune the receiver manually	1-27
1.18 How to Select a Pulselength.....	1-28
1.18.1 How to select a pulselength	1-28
1.18.2 How to change the preset pulselength	1-28
1.19 How to Adjust Sensitivity	1-29
1.20 How to Reduce Sea Clutter	1-29
1.20.1 How to select the method of clutter adjustment	1-29
1.20.2 How to fine-tune sea clutter reduction	1-30
1.20.3 How to manually reduce sea clutter	1-30
1.20.4 How to use the BERTHING STC function	1-31
1.21 How to Reduce Rain Clutter	1-31
1.21.1 How to select the method of rain clutter reduction	1-32
1.21.2 How to manually reduce the rain clutter	1-32
1.22 Interference Rejector	1-34
1.23 Echo Stretch	1-35
1.24 Echo Averaging	1-36
1.25 Automatic Clutter Elimination (ACE) Function.....	1-38

TABLE OF CONTENTS

1.25.1	How to turn the Automatic Clutter Elimination (ACE) function on/off	1-38
1.25.2	How to adjust the gain in Automatic Clutter Elimination (ACE) mode	1-38
1.25.3	How to get high sensitivity	1-39
1.25.4	How to suppress false echoes	1-39
1.26	Noise Rejector	1-40
1.27	Wiper	1-40
1.28	How to Preset Controls for a Specific Navigation Purpose	1-41
1.28.1	How to select a customized echo	1-44
1.28.2	How to edit a customized echo	1-44
1.28.3	How to restore a user customized echo to the saved settings	1-45
1.28.4	How to restore a user customized echo to the factory default settings	1-46
1.28.5	How to edit the available customized echoes	1-46
1.29	How to Reject Second-trace Echoes	1-47
1.30	Orientation Modes	1-48
1.30.1	How to select an presentation mode	1-48
1.30.2	Description of presentation modes	1-48
1.31	How to Select a Range Scale	1-50
1.32	How to Measure Range	1-51
1.32.1	How to show/hide the range rings	1-51
1.32.2	How to measure range with the variable range marker (VRM)	1-51
1.32.3	How to set the VRM unit of measurement (B-type only)	1-52
1.32.4	How to show TTG to VRM	1-53
1.33	How to Measure Bearing	1-53
1.33.1	Methods to measure bearing	1-54
1.33.2	True or relative bearing	1-54
1.34	Collision Assessment by Offset EBL	1-55
1.34.1	How to assess risk of collision using the offset EBL	1-55
1.34.2	How to set the origin point reference for EBL OFFSET	1-56
1.35	How to Measure Range and Bearing Between Two Targets	1-57
1.36	How to Off-Center the Display	1-59
1.37	Target Trails	1-60
1.37.1	True or relative trails	1-60
1.37.2	Trail time	1-61
1.37.3	Trail gradation	1-62
1.37.4	Trail level	1-62
1.37.5	Narrow trails (B/W-type only)	1-63
1.37.6	How to hide the trails temporarily	1-63
1.37.7	Trail stabilization in true motion	1-63
1.37.8	How to erase/restart trails	1-63
1.37.9	How to prevent sea clutter in true trails	1-64
1.37.10	How to show/hide OS trails	1-65
1.37.11	How to show/hide land trails (B/W-type only)	1-65
1.37.12	How to set the trail length (B/W-type only)	1-66
1.37.13	How to set the trail color (B/W-type only)	1-66
1.37.14	How to remove the colors from a section of a multicolor trail (B/W-type only) ...	1-67
1.37.15	How to offset the colors for multicolored trail (B/W-type only)	1-68
1.38	Target Analyzer (B/W-type only)	1-69
1.38.1	How to activate/deactivate the target analyzer	1-70
1.39	Target Alarm	1-71
1.39.1	How to set a target alarm	1-71
1.39.2	How to mute the target alarm	1-72
1.39.3	How to deactivate a target alarm	1-72
1.39.4	How to change target alarm attributes	1-72
1.40	PI (Parallel Index) Lines	1-73
1.40.1	How to show/hide the PI lines	1-73
1.40.2	How to set the maximum number of lines to display	1-73

1.40.3	How to change PI line bearing and interval	1-74
1.40.4	How to change the PI line bearing reference (B/W-type only)	1-74
1.40.5	How to change the PI line orientation	1-75
1.40.6	How to reset the PI lines to default (ship's heading)	1-75
1.40.7	How to change PI line length (IMO/A/B/R-types only)	1-75
1.41	How to Use the Net (Diamond) Cursor (B/W-type only)	1-76
1.41.1	How to activate the net cursor	1-76
1.41.2	How to set the net cursor dimensions and orientation	1-77
1.42	Zoom	1-78
1.43	How to Use Marks	1-79
1.43.1	Heading line mark	1-79
1.43.2	How to hide/show the stern mark	1-79
1.43.3	North mark	1-80
1.43.4	How to set up the own ship symbol	1-80
1.43.5	How to set the barge marker	1-80
1.43.6	Antenna mark	1-81
1.43.7	Latitude/longitude grid	1-81
1.44	Drop Mark	1-82
1.44.1	How to activate the drop mark	1-82
1.44.2	How to inscribe a drop mark	1-82
1.44.3	How to erase drop marks	1-82
1.45	Brilliance and Color Schemes	1-83
1.45.1	How to select a brilliance and color scheme	1-83
1.45.2	How to change the color and brilliance assigned to a palette	1-83
1.45.3	How to change the color palette	1-85
1.46	How to Display and Set Up Navigational Data	1-86
1.46.1	How to set up the navigational data	1-86
1.46.2	How to display navigational data	1-87
1.47	How to Use the Information Box	1-88
1.48	Interswitch	1-90
1.48.1	How to display antenna information	1-90
1.48.2	How to preset antenna and display combinations	1-91
1.48.3	How to clear the interswitch	1-93
1.49	Performance Monitor	1-93
1.49.1	How to activate/deactivate the performance monitor	1-93
1.49.2	How to check the radar's performance	1-95
1.50	How to Change the Reference Position	1-96
1.51	Anchor Watch	1-97
1.52	Alerts	1-98
1.52.1	What is an alert?	1-98
1.52.2	How to interpret the [ALERT] box	1-99
1.52.3	How to acknowledge an alert	1-99
1.52.4	How to silence the alert buzzer	1-99
1.52.5	Alert list	1-100
1.52.6	Alert icons and their meanings	1-102
1.52.7	Responsibility transfer alert	1-103
1.53	Icing Prevention	1-104
1.54	How to Select a Display Mode (B/W-type Only)	1-105
1.55	How to Manage SD Card Data	1-106
1.55.1	Formatting the SD card	1-106
1.55.2	Cautionary notes on handling SD cards	1-106
1.55.3	Compatible SD cards	1-106
1.55.4	How to insert SD cards	1-107
1.55.5	How to remove SD cards	1-107
1.55.6	How to save data to an SD card	1-108
1.55.7	How to read (load) data from an SD card	1-108

TABLE OF CONTENTS

1.55.8	How to delete data from an SD card	1-108
1.56	How to Take a Screenshot.....	1-109
1.57	How to Use the Watch Alert (A/B/W-types only)	1-109
1.58	Dual Radar (A/B-types only)	1-110
1.58.1	How to toggle control of each dual radar display	1-111
1.58.2	Operating considerations for the dual radar display.....	1-112
1.59	Wave Mode	1-114
1.60	Doppler Feature (X-band Solid State Radars only).....	1-115
2.	RADAR OBSERVATION	2-1
2.1	General	2-1
2.1.1	Minimum range	2-1
2.1.2	Maximum range	2-1
2.1.3	X-band and S-band	2-2
2.1.4	Radar resolution.....	2-2
2.1.5	Bearing accuracy	2-3
2.1.6	Range measurement.....	2-3
2.2	False Echoes	2-3
2.3	SART (Search and Rescue Transponder)	2-5
2.3.1	SART description	2-5
2.3.2	How to show SART marks on the radar display.....	2-6
2.3.3	General remarks on receiving SARTs.....	2-6
2.4	RACON	2-7
2.5	Radar Target Enhancer (RTE).....	2-7
2.6	Solid state radar	2-8
3.	TARGET TRACKING (TT)	3-1
3.1	Precautions when Using Target Tracking	3-1
3.2	TT Controls	3-2
3.3	TT Box Overview.....	3-2
3.4	How to Select the TT mode.....	3-3
3.5	How to Acquire and Track Targets.....	3-4
3.5.1	How to manually acquire a target.....	3-4
3.5.2	How to automatically acquire targets	3-5
3.6	How to Enter Own Ship Speed	3-5
3.6.1	Echo-referenced speed input.....	3-5
3.7	How to Cancel Target Tracking.....	3-7
3.7.1	How to cancel tracking for individual TT targets	3-7
3.7.2	How to cancel tracking for all TT targets.....	3-7
3.8	Lost Target.....	3-8
3.8.1	How to set the lost target filter.....	3-8
3.8.2	How to enable/disable the lost target alert.....	3-8
3.9	TT Symbols and Attributes.....	3-9
3.9.1	How to adjust symbol brilliance.....	3-9
3.9.2	How to set the symbol color.....	3-9
3.9.3	How to select a TT symbol (B/W-types only)	3-10
3.10	How to Display/Remove Target Data	3-10
3.10.1	TT pop up information.....	3-10
3.10.2	How to show/remove target data in the data display area	3-11
3.10.3	How to display, hide and sort the target list	3-12
3.11	How to Assign a Preset Name to TT Targets (B/W-type only).....	3-14
3.11.1	How to activate the preset name function	3-14
3.11.2	How to setup preset names	3-14
3.11.3	How to assign a name to a TT	3-15
3.12	Vector Modes	3-16
3.12.1	Description of vectors.....	3-16

3.12.2	Vector mode and length	3-18
3.13	Past Position Display	3-19
3.13.1	How to display past position points and select the plotting interval.....	3-19
3.13.2	How to select the number of past position points to be displayed.....	3-19
3.14	Set and Drift.....	3-20
3.15	Collision Alarm (CPA, TCPA)	3-21
3.15.1	How to set the CPA and TCPA ranges	3-21
3.15.2	How to acknowledge the TT collision alarm	3-22
3.16	Acquisition Zone	3-22
3.16.1	How to enable the acquisition zones	3-22
3.16.2	How to activate the first acquisition zone (AZ1)	3-23
3.16.3	How to set a polygon acquisition zone (AZ2)	3-23
3.16.4	How to sleep/deactivate an acquisition zone	3-24
3.16.5	How to acknowledge the acquisition zone alert	3-24
3.16.6	How to select the target type to acquire (B/W-types only)	3-24
3.16.7	How to change the acquisition zone reference	3-25
3.16.8	How to set acquisition zone shape and stabilization (B/W-types only)	3-25
3.17	Trial Maneuvers.....	3-27
3.17.1	Types of trial maneuvers	3-27
3.17.2	How to perform a trial maneuver	3-28
3.17.3	How to stop the trial maneuver.....	3-30
3.18	TT System Messages.....	3-31
3.19	TT Simulation Mode	3-32
3.20	Criteria for Tracking Target Selection.....	3-33
3.21	Factors Affecting Target Tracking	3-34
4.	AIS OPERATION	4-1
4.1	Controls for AIS	4-2
4.2	AIS Box Overview.....	4-3
4.3	How to Select the AIS Display Mode.....	4-3
4.4	AIS Symbols and Their Meanings	4-4
4.5	How to Use the AIS Display Filter	4-4
4.6	How to Activate AIS Targets.....	4-6
4.6.1	How to activate specific targets manually	4-6
4.6.2	How to set the AIS auto activate function.....	4-7
4.7	How to Sleep AIS Targets	4-8
4.7.1	How to sleep individual AIS targets	4-8
4.7.2	How to sleep all AIS targets	4-8
4.8	How to Set Up For a Voyage.....	4-9
4.8.1	How to access the [VOYAGE DATA] menu	4-9
4.9	How to Display AIS Target Data.....	4-10
4.9.1	AIS pop-up information.....	4-10
4.9.2	How to display basic AIS target data.....	4-11
4.9.3	How to display expanded AIS target data	4-12
4.9.4	How to remove target data from the display area	4-12
4.10	How to Change AIS Symbol Attributes.....	4-13
4.10.1	How to adjust the AIS symbol brilliance	4-13
4.10.2	How to change the color of the AIS symbol	4-13
4.10.3	How to change the color of the ATON symbol	4-13
4.10.4	How to change the size of the AIS symbol.....	4-14
4.11	Past Position Display.....	4-15
4.11.1	How to display past position points and select the plotting interval.....	4-15
4.11.2	How to select the number of past position points to be displayed.....	4-15
4.11.3	Past position display orientation	4-15
4.11.4	Stabilization in true motion	4-16
4.12	Lost Target	4-16

TABLE OF CONTENTS

4.12.1	How to set the lost target filter.....	4-16
4.12.2	How to enable/disable the lost target alert.....	4-17
4.13	ROT Setting	4-17
4.14	AIS Collision Alarm (CPA, TCPA).....	4-18
4.14.1	How to set the CPA and TCPA ranges	4-18
4.15	How to Associate TT and AIS Targets	4-19
4.16	How to View Own Ship Data	4-21
4.17	How to Use AIS Messages	4-22
4.17.1	How to create and save messages	4-22
4.17.2	How to transmit messages.....	4-23
4.17.3	How to view messages	4-24
4.17.4	How to set up the AIS message notification.....	4-24
4.17.5	How to display AIS alert messages.....	4-25
4.18	AIS System Messages	4-26
5.	VIDEO PLOTTER OPERATION	5-1
5.1	Orientation Modes.....	5-1
5.2	How to select a mark type.....	5-1
5.3	How to select the mark inscription position	5-2
5.4	Radar Map	5-3
5.4.1	How to show/hide radar map marks.....	5-3
5.4.2	How to select the mark color (B/W-type only).....	5-4
5.4.3	How to inscribe marks.....	5-4
5.4.4	How to delete marks	5-6
5.4.5	How to align the radar map.....	5-7
5.5	Origin Mark.....	5-8
5.5.1	How to inscribe origin marks	5-8
5.5.2	How to set origin mark stabilization.....	5-9
5.5.3	How to delete origin marks.....	5-9
5.6	How to Change the Shape of the Own Ship Mark	5-10
5.7	How to Use ECDIS Chart Marks	5-11
5.8	Own Ship and Other Ship's Track.....	5-12
5.8.1	How to show/hide tracks	5-12
5.8.2	How to set the plotting interval.....	5-13
5.8.3	How to set the track color (A/B/W-types only).....	5-14
5.8.4	How to automatically plot target tracks (A/B/W-types only)	5-14
5.8.5	How to delete tracks.....	5-15
5.9	How to Use Waypoints.....	5-16
5.9.1	How to set the data source for waypoints	5-16
5.9.2	How to enter waypoints.....	5-17
5.9.3	How to erase waypoints	5-18
5.9.4	How to display the waypoint list	5-19
5.9.5	How to show/hide the waypoint name/number	5-19
5.10	Routes.....	5-20
5.10.1	How to set/edit an internal route	5-20
5.10.2	How to display routes.....	5-21
5.10.3	How to delete internal routes	5-23
5.10.4	How to view the routes list	5-23
5.10.5	How to use the waypoint arrival distance function	5-24
5.11	Chart Functions.....	5-25
5.11.1	How to show/hide the chart.....	5-25
5.11.2	How to align the chart position	5-26
5.11.3	How to select the chart type.....	5-27
5.11.4	Chart settings menu	5-27
5.11.5	How to show/hide land mass emphasis	5-29
5.11.6	How to check your charts/symbol versions.....	5-30

6. MAINTENANCE, TROUBLESHOOTING 6-1

6.1 Periodic Maintenance Schedule 6-2

6.2 How to Replace the Fuse 6-3

6.3 Life Expectancy of Major Parts 6-4

6.4 Trackball Maintenance 6-5

6.5 Easy Troubleshooting 6-5

6.6 Advanced-level Troubleshooting 6-6

6.7 Diagnostics 6-8

6.8 Sentence Monitor 6-13

6.9 Fallback Arrangements 6-14

APPX. 1 MENU TREE AP-1

APPX. 2 LONGITUDE ERROR TABLE (96 NM SCALE) AP-9

APPX. 3 ALERT LIST AP-11

APPX. 4 DATA COLOR AND MEANING AP-33

APPX. 5 ABBREVIATIONS AP-34

APPX. 6 SYMBOLS AP-40

APPX. 7 PARTS LOCATION AP-46

APPX. 8 RADIO REGULATORY INFORMATION AP-56

SPECIFICATIONS SP-1

INDEX IN-1

FOREWORD

A Word to the Owner of FAR-22x8/23x8 Series Marine Radar

Congratulations on your choice of the FURUNO FAR-22x8/FAR-23x8 series of radars. We are confident you will see why FURUNO has become synonymous with quality and reliability.

Since 1948, FURUNO Electric Company has enjoyed an enviable reputation for innovative and dependable marine electronics equipment. This dedication to excellence is furthered by our extensive global network of agents and dealers.

Your radar is designed and constructed to meet the rigorous demands of the marine environment. However, no machine can perform its intended function unless installed, operated and maintained properly. Please carefully read and follow the recommended procedures for operation and maintenance. We would appreciate hearing from you, the end-user, about whether we are achieving our goal.

Thank you for considering and purchasing FURUNO equipment.

Features

- The FAR-2xx8 series consists of the following models and configurations:

Model	Frequency band	Size of monitor unit* ¹	Output power	Transceiver location
Magnetron radar				
FAR-2218	X-band	19.0"	12 kW	Antenna unit
FAR-2218-BB		Local supply	12 kW	Antenna unit
FAR-2318		23.1"/27"	12 kW	Antenna unit
FAR-2018-MARK-2		19.0"/27"	12 kW	Antenna unit
FAR-2228		19.0"	25 kW	Antenna unit
FAR-2228-BB		Local supply	25 kW	Antenna unit
FAR-2328		23.1"/27"	25 kW	Antenna unit
FAR-2028-MARK-2		19.0"/27"	25 kW	Antenna unit
FAR-2328W		23.1"/27"	25 kW	Transceiver unit
FAR-2238S		S-band	19.0"	30 kW
FAR-2238S-BB	Local supply		30 kW	Antenna unit
FAR-2338S	23.1"/27"		30 kW	Antenna unit
FAR-2338SW	23.1"/27"		30 kW	Transceiver unit
Solid state radar				
FAR-2228-NXT	X-band	19.0"	600 W* ²	Antenna unit
FAR-2328-NXT		23.1"/27"	600 W* ²	Antenna unit
FAR-2228-NXT-BB		Local supply	600 W* ²	Antenna unit
FAR-2238S-NXT	S-band	19.0"	250 W	Antenna unit
FAR-2338S-NXT		23.1"/27"	250 W	Antenna unit
FAR-2238S-NXT-BB		Local supply	250 W	Antenna unit

*¹: Viewing distances are as follows:

• MU-190/MU-190HD/MU-192HD/MU-270W: 1020 mm

• MU-231: 1200 mm

*²: 500W for a Japanese flag vessel.

- Two methods of operation are available: the standard supply control unit (RCU-014) and the optional trackball unit (RCU-015/RCU-016). The ergonomically designed palm rest on the trackball unit makes it easy to use.
- Simple operation with “point-and-click” menu functionality.
- All functions can be accessed using only the trackball unit, however, RCU-016 trackball units do not have a power button.
- TT, AIS, Radar Map, Interswitch and FURUNO’s unique Target Analyzer are supplied as standard.
- CPA/TCPA alarms.
- Targets activate the user-set alarm zone when entering or exiting the zone.
- The Target Analyzer function helps to find targets in high noise areas (rain/snow), or where there is interference from surface reflections. (Available for B/W-types only.)
- The FAR-2xx8 series complies with MED 2014/90/EU and also the following directives: IEC62388, IEC 62288, IMO MSC. 192(79).

Terminology standards used in this manual

This manual uses the following terminology standards:

Terminology	Meaning or usage example
Select	<ul style="list-style-type: none"> • Use the trackball or scrollwheel on the control unit to move the cursor over the item to be “selected”, then left-click. • With a menu open: Press the appropriate menu number.
Left-click	Press the left mouse button.
Right-click	Press the right mouse button.
Control Unit	Refers to the RCU-014 Control Unit, unless otherwise specified.
Open the menu.	Press the MENU key to show the [MENU].
Close the menu.	Press the MENU key to close the [MENU].

For the sake of brevity, all procedures in this manual use the terms “Open the menu.” and “Close the menu”.

Program numbers

Please access the following URL if you need software information:

http://www.furuno.com/en/merchant/radar/FAR-22x8_23x8/#SoftwareVersion

System	Program no.	Version no.	Remarks
Antenna unit (common to all antennas)			
SPU	0359281	01.xx	For magnetron radar
SPU	0359286	01.xx	For S-band solid state radar
SPU	0359477	01.xx	For X-band solid state radar
IF-SPU	0359560	01.xx	For MARK-2 magnetron radar
MTR-DRV	0359293	01.xx	
MTR-PWR	0359556	01.xx	For MARK-2 magnetron radar
PM	0359296	01.xx	
RF-Converter	0359302	01.xx	For S-band solid state radar
RF-Converter	0359414	01.xx	For X-band solid state radar
Processor Unit: RPU-025			
MAIN	0359377	02.xx	
SUB	0359380	02.xx	
Control Unit: RCU-014/015/016			
KEY	0359385	01.xx	

xx: Denotes minor changes to the software.

About the programs used in A/B/W-types with Radar Plotter functionality

- Ubiquitous QuickBoot Copyright© 2015. Ubiquitous Corp. All right reserved.
- Portions of this software are copyright© 2016. The FreeType Project (www.freetype.org). All right reserved.
- This equipment includes GPL2.0, LGPL2.0, Apache, BSD, MIT or other licensed softwares. For further software information, please access the following URL:
https://www.furuno.co.jp/en/contact/cnt_oss_e01.html

Radar Type and Function Availability

This radar is available in several specification types to meet the requirements of Authorities, and function availability depends on specification type. The table below shows the function that have limited availability. This manual provides descriptions for all functions of this radar series, and we have endeavored to denote in the text those functions that have limited availability. For detailed information on the function availability, see the menu tree at the back of this manual.

Type abbreviations and their meanings

- IMO: Meets the IMO requirements and is compliant with IMO regulations
- A: Near-IMO specifications
- B: Standard fishing specifications
- R: Russian River
- W: Washington Ferry

Function availability and specification type

Function	Type				
	IMO	A	B	R	W
TT symbol selection	No	No	Yes	No	Yes
Acquisition zone range limitation	Yes	No	No	Yes	No
Auto Track Target	No	Yes	Yes	No	Yes
Chart Display	No	Yes	Yes	No	Yes
Color Echo	No	No	Yes	No	Yes
Cursor range unit selection	No	No	Yes	No	No
Cursor Size	No	No	Yes	No	Yes
Echo area configuration	No	No	Yes	No	Yes
Mark color	No	No	Yes	No	Yes
Mark w/line	No	No	Yes	No	Yes
Range	[0.125], [0.25], [0.5], [0.75], [1.5], [3], [6], [12], [24], [48], [96]	Same as IMO	[0.125]***, [0.25], [0.5], [0.75], [1], [1.5], [2], [3], [4], [6], [8], [12], [16], [24], [32], [48], [96], [120]*	Same as IMO	Same as B
Range unit	[NM] only	Same as IMO	[NM], [SM], [km], [kyd]	Same as IMO	Same as B
VRM unit - selectable unit	No	No	Yes	No	No
Track - Other ship	No	Yes	Yes	No	Yes
Trail Eraser	No	No	Yes	No	Yes
Trails - Color	No	No	Yes	No	Yes
Trails - Hide	No	No	Yes	No	Yes
Trails - Long	No	No	Yes	No	Yes
Trails - Narrow	No	No	Yes	No	Yes
WPT marker	No	Yes	Yes	No	Yes
Target Analyzer	No	No	Yes	No	Yes
Net Cursor	No	No	Yes	No	Yes
Target Type to Acquire	No	No	Yes	No	Yes
Check Area Setting	No	No	Yes	No	Yes
Display Scroll**	No	No	Yes	No	Yes
Dual Radar display	No	Yes	Yes	No	No

*: The range setting [120] is only available when the range unit is set to km,kyd.

** : Available only for B/W-types.

***: The range setting [0.125] is only available when the range unit is set to [NM] or [SM].

Advanced fishing specifications

The following radar plotter features will be available by updating to the software for advanced fishing specifications and installing the RP board to the processor unit. Consult your local dealer regarding the software update and RP board installation.

- A variety of plotter-related functions.
(Memory capacity increase for own and other ship's track, ship's track color customize function, mark/line function, memory capacity increase for origin mark, origin mark list, etc.)
- TT/AIS symbol customize function.
- Enhanced dynamic range for a more complete EAV (Echo Average) function.
- Compatible with the RCU-031 control unit that is specially designed for fisheries.

For details about advanced fishing specifications, see the operator's manual (OME-36521).

Signal processing functions

This radar has the signal processing functions listed in the table below.

Function	Description	Reference
Interference rejector	Suppresses interference by other radars. Interference received simultaneously from multiple radars may be difficult to reduce.	See section 1.22
Echo stretch	Enlarges target echoes, especially small echoes. Suppress interference, sea clutter and rain clutter before using echo stretch, to prevent enlargement of unwanted echoes.	See section 1.23
Echo averaging	The radar samples echoes with each scan. Targets that show a large change with each scan are judged as clutter and are reduced to display only echoes from legitimate targets.	See section 1.24
Automatic clutter elimination	Discriminates clutter from the radar echo, then reduces the clutter automatically.	See section 1.25
Noise rejector	Reduces white noise then improves the on-screen S/N ratio by processing the weighted moving average filter for the received echoes in the range direction. Use this function with caution. Weak target echoes may disappear from the screen or the range resolution may worsen.	See section 1.26

CE/UKCA Declaration

With regards to CE/UKCA declarations, please refer to our website (www.furuno.com) for further information about RoHS conformity declarations.

Disclosure of Information about China RoHS

With regards to China RoHS information for our products, please refer to our website (www.furuno.com).

SYSTEM CONFIGURATION

NOTICE

IMO-type radar(s) must be interconnected to the following type approved sensors.
For other radar types, it is recommended to connect the following type approved sensors.

- EPFS meeting the requirements of the IMO resolution MSC.112(73).
- Gyrocompass (or equivalent devices) meeting the requirements of the IMO resolution A.424(XI).
- SDME meeting the requirements of IMO resolution MSC.96(72).

The radar may be interconnected via HUB-3000 to other FURUNO processing units having approved LAN ports.

Note: Basic configuration is shown with a solid line. For footnotes, see "Notes" on page xxii.

X-band (TR-UP, CF Antenna)

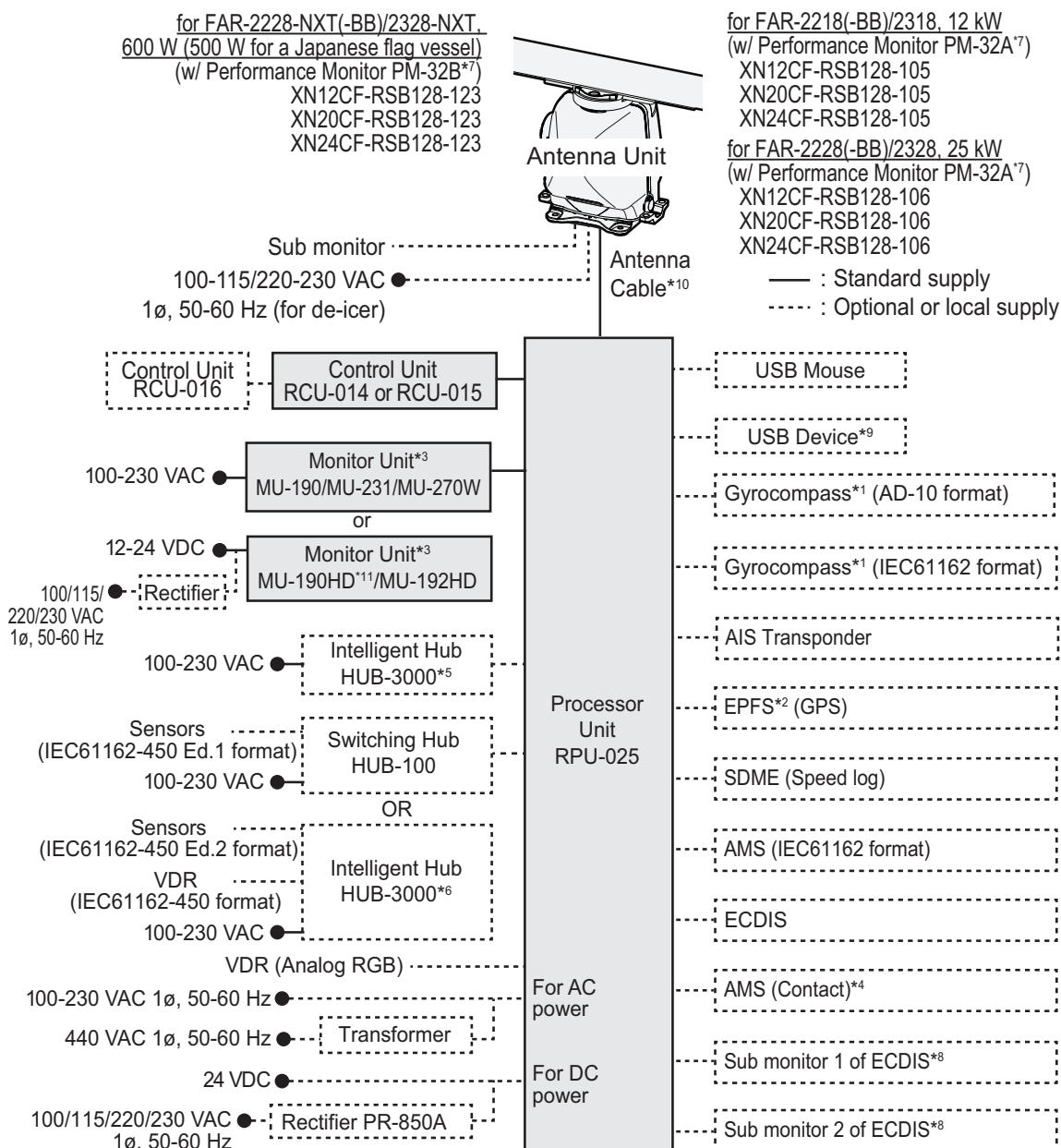

X-band (TR-UP, AF Antenna)

— : Standard supply
 : Optional or local supply

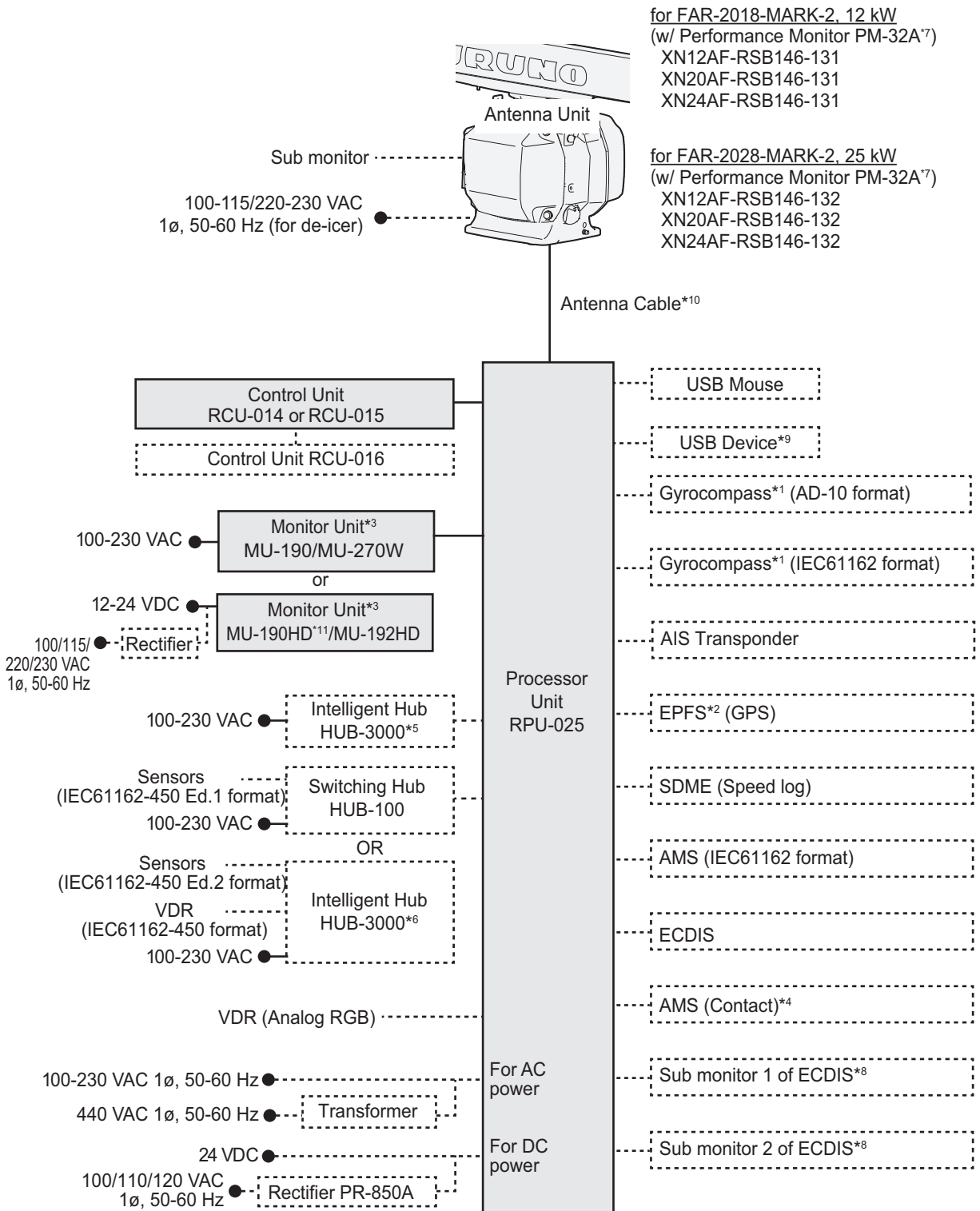

S-band (TR-UP)

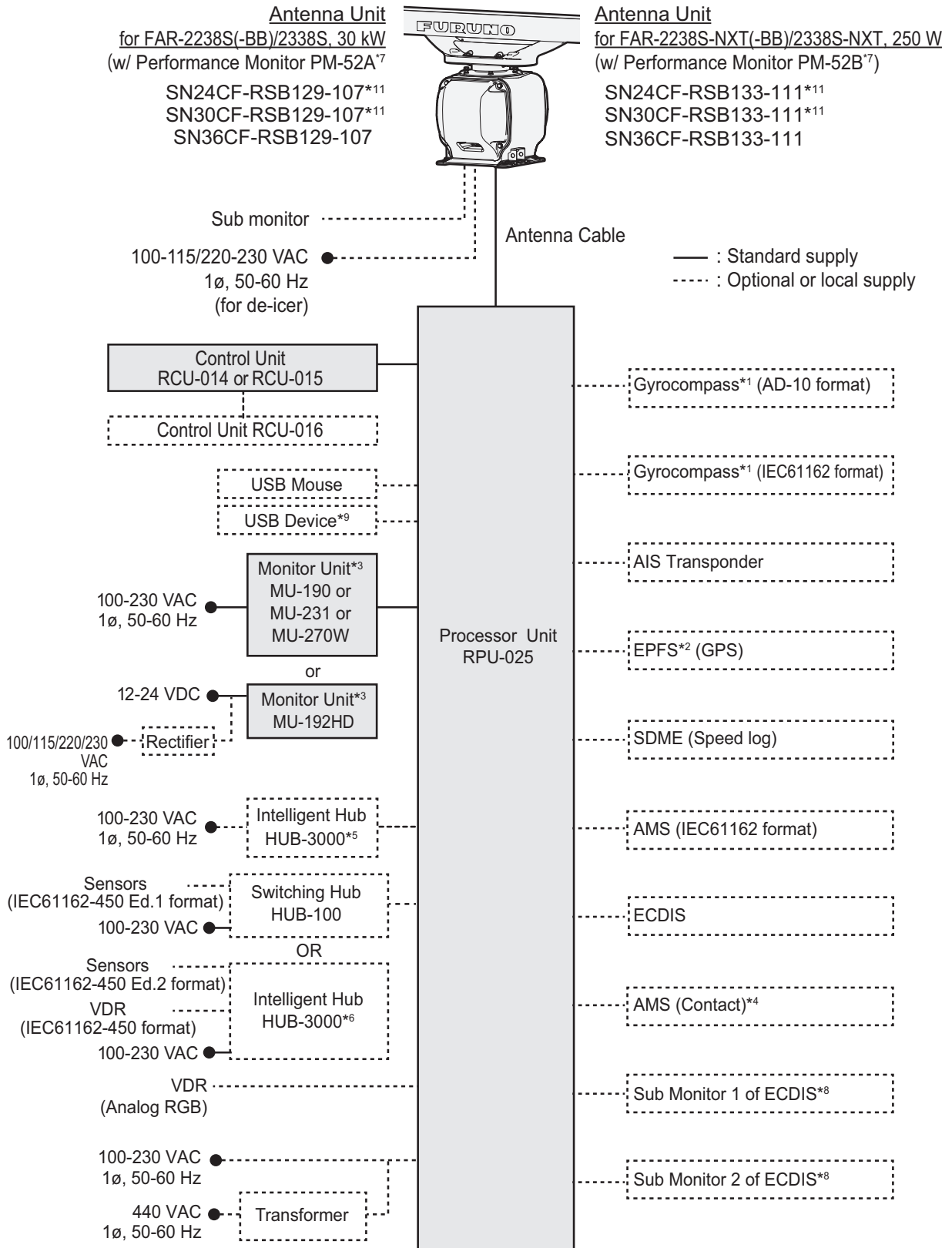

SYSTEM CONFIGURATION

X-band (TR-DOWN)

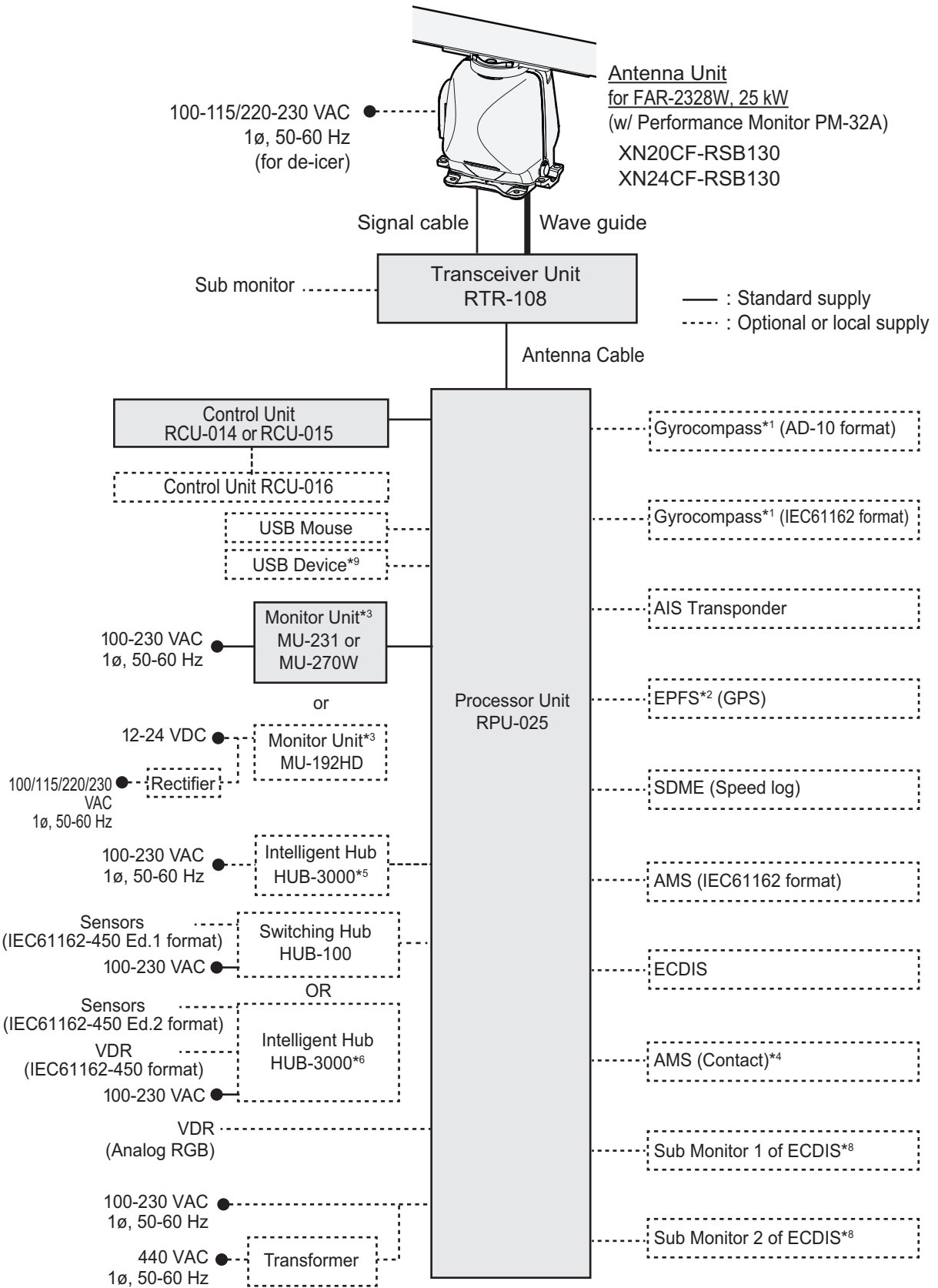

S-band (TR-DOWN)

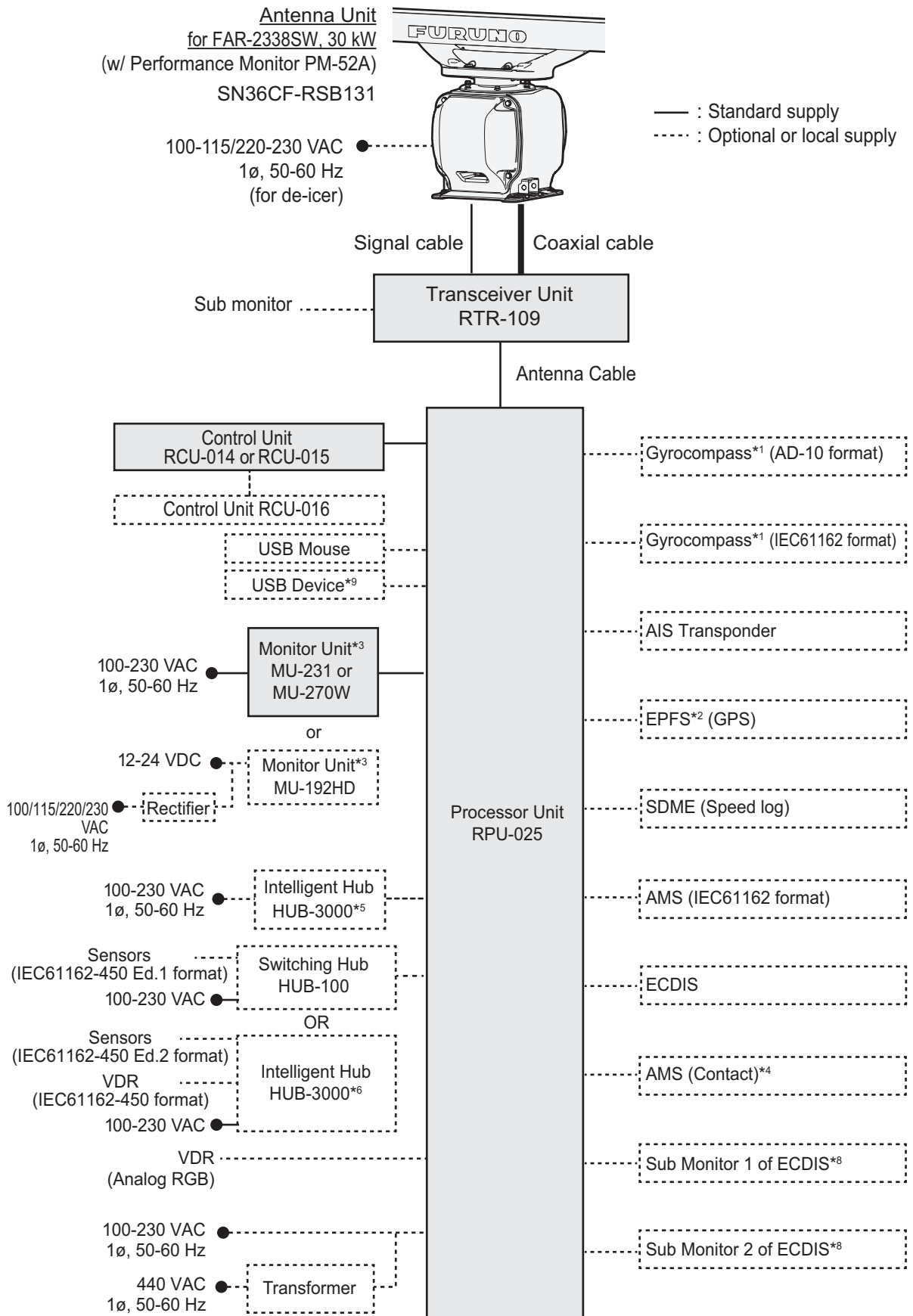

Category of units

- Antenna units: Exposed to the weather.
- Other units: Protected from the weather.

Notes

- 1) The gyrocompass must be type approved for compliance with IMO resolution A.424(XI) (and/ or resolution A.821(19) for installation on HSC). The gyrocompass must also have an update rate that is adequate for the ship's rate of turn. The update rate must be better than 40 Hz (HSC) or 20 Hz (conventional vessel).
- 2) The EPFS must be type approved for compliance with IMO resolution MSC.112(73).
- 3) The monitors listed in the following table have been approved by the IMO.
If a different monitor is to be used on IMO vessels, its effective diameter must meet the applicable Category requirements.
 - CAT 1 and CAT 1H: effective diameter of 320 mm or higher
 - CAT 2 and CAT 2H: effective diameter of 250 mm or higher
 - CAT 3: effective diameter of 180 mm or higher

Category	Manufacturer	Model	Viewing distance
CAT 1 and CAT 1H	FURUNO	MU-231	1.20 m
		MU-270W	1.02 m
	Hatteland Display	JH 23T14 FUD	1.20 m
		HD26T21 MMD	0.99 m
		HD26T22 FUD	0.99 m
		HD27T22 FUD	1.07 m
		HD32T22 FUD	0.64 m
		HD55T22 FUD	1.09 m
	North Invent	WA270-01-MON-01	1.07 m
		WE270FU*	1.07 m
WA460-01-MON-01		0.60 m	
CAT 2 and CAT 2H	FURUNO	MU-190/MU-190HD/MU-192HD	1.02 m
	Hatteland Display	JH 19T14 FUD	1.02 m
		JH 20T17 FUD	0.88 m
		HD19T22 FUD	1.02 m
		HD24T21 FUD	1.12 m
		HD24T22 FUD	1.12 m
CAT 3	FURUNO	MU-152	1.02 m
	Hatteland Display	JH 15T17 FUD	1.02 m
		HD15T22 FUD	1.02 m

*: CCS approved only (not approved by MED). When WE270FU is used with FAR-20x8-MARK-2, the equipment is non-compliant with both CCS and MED.

For installation and operation of other monitors, see the respective manuals.

For BB type, a monitor unit is prepared by user.

- 4) Characteristics of contact output for Alarm:
 - (Load current) 250 mA;
 - (Polarity) Normally Open: 2 ports, Normally Close: 2 ports;
 - Serial I/O for alarm is also possible, which complies with IEC 61162-1.

- 5) For configurations with 3 or more radars/ECDIS (FMD-3100/FMD-3200/FMD-3300) connected, connect via the HUB-3000. For 2 radars, HUB-100 can be used.
- 6) For connection to a VDR or IEC61162-450 Ed.2 sensor, connection should be made via the HUB-3000.
- 7) Some antenna configurations do not have an in-built Performance Monitor. This type of antenna is not usable for IMO-type radars.
- 8) For connecting non-FURUNO ECDIS only. For connection of radars or plotters, the connection must be done at the radar antenna (or the transceiver unit) via the sub monitor connector.
- 9) Available only for A/B/W-types with Radar Plotter functionality.
- 10) Junction boxes are required for antenna cable length greater than 100 m (only for TX-band R-UP radar). Max. cable length is 400 m.
- 11) Unavailable on IMO-type radars.

This page is intentionally left blank.

1. OPERATIONAL OVERVIEW

1.1 Controls Overview

Two types of control units are available for your FAR-2xx8: a full keyboard (RCU-014) or palm control (RCU-015/RCU-016).

Most operations can be done with either type of Control Unit. Throughout the manual, procedures are outlined using the RCU-014, unless otherwise specified.

1.1.1 Control Unit RCU-014

You can control almost all aspects of your radar from the RCU-014. The figure and table below show an overview of the control unit with a brief description of the controls.

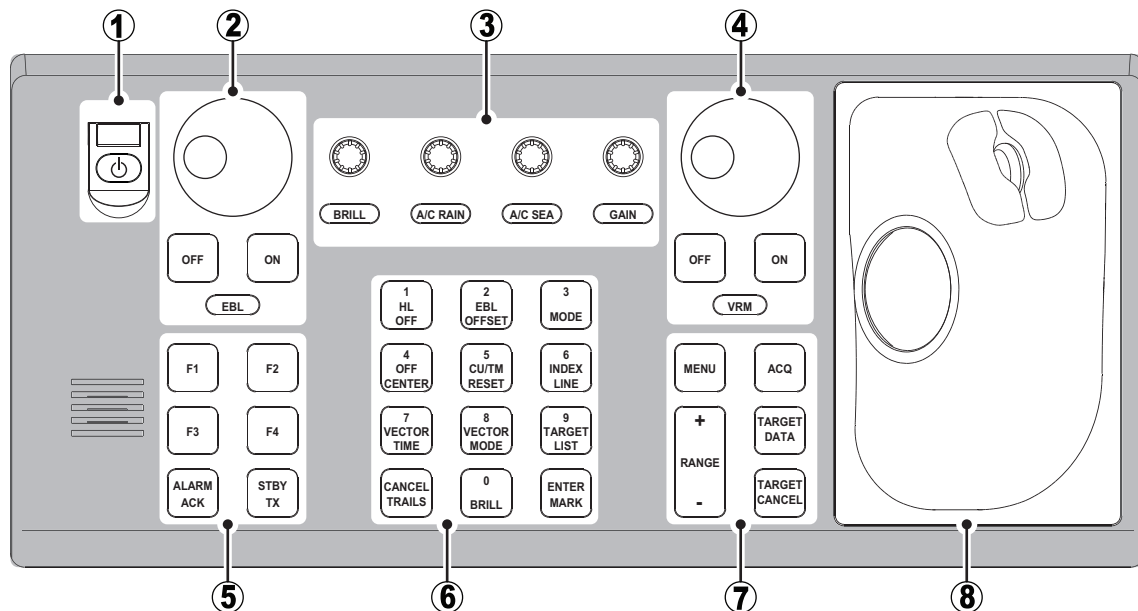

No.	Control Name	Description
1	Power button	Turn the power on or off. See section 1.2.
2	EBL controls	<ul style="list-style-type: none"> • EBL keys: Turn the EBLs on or off. • EBL knob: Move the selected EBL. See section 1.33.
3	BRILL knob	Adjust echo brilliance and screen brilliance. See section 1.3.
	A/C RAIN knob	Adjust auto/manual clutter reduction for rain. See section 1.21.
	A/C SEA knob	Adjust auto/manual clutter reduction for rough seas. See section 1.20.
	GAIN knob	Adjust the gain (sensitivity). See section 1.19.
4	VRM controls	<ul style="list-style-type: none"> • VRM keys: Turn the VRMs on or off. • VRM knob: Move the selected VRM. See section 1.32.
5	Functions keys (F1 to F4)	Perform a pre-registered function. See section 1.9.
	ALARM ACK key	Acknowledge active alerts. See section 1.52.
	STBY TX key	Toggle the radar operation between transmit (TX) and standby (STBY). See section 1.16.

1. OPERATIONAL OVERVIEW

No.	Control Name	Description
6	1, HL OFF key	<ul style="list-style-type: none"> With the menu open: Select menu item "1". Press and hold to hide the heading line, range rings and OS symbol. Release to re-show the hidden items. See section 1.43.1.
	2, EBL OFFSET key	<ul style="list-style-type: none"> With the menu open: Select menu item "2". Sets the positive/negative value to "+". See section 1.14 and section 1.10. Offset or reset the EBL. See section 1.34.
	3, MODE key	<ul style="list-style-type: none"> With the menu open: Select menu item "3". Change the orientation mode. See section 1.30.
	4, OFF CENTER key	<ul style="list-style-type: none"> With the menu open: Select menu item "4". Enable or disable off-center. See section 1.36.
	5, CU/TM RESET key	<ul style="list-style-type: none"> With the menu open: Select menu item "5". Course Up mode: Reset the heading line to 000°. See section 1.30. True Motion mode: Move Own Ship position 75% of the radius in opposite direction of the current heading. See section 1.30.
	6, INDEX LINE key	<ul style="list-style-type: none"> With the menu open: Select menu item "6". Short press: Select a PI line. See section 1.40. Long press: Show or hide the selected PI line. See section 1.40.
	7, VECTOR TIME key	<ul style="list-style-type: none"> With the menu open: Select menu item "7". Change the vector time. See section 3.12.2.
	8, VECTOR MODE key	<ul style="list-style-type: none"> With the menu open: Select menu item "8". Sets the positive/negative value to "-". See section 1.14 and section 1.10. Toggle between true and relative vectors. See section 3.12.
	9, TARGET LIST key	<ul style="list-style-type: none"> With the menu open: Select menu item "9". Show or hide the TT/AIS target list. See section 3.10.3.
	CANCEL TRAILS key	<p>Without the menu open (see section 1.37.2):</p> <ul style="list-style-type: none"> Short press: Change the trail display time. Long press: Erase displayed trails. <p>With the menu open (see section 1.5):</p> <ul style="list-style-type: none"> Go back one level in the menu. Closes the menu if the top level is displayed. Cancel changes made to a menu setting.
	0, BRILL key	<ul style="list-style-type: none"> With the menu open: Select menu item "0". Change the color scheme. See section 1.45.
	ENTER MARK key	<p>Inside the Operational Display Area (ODA):</p> <p>Inscribe a mark. See section 1.43.</p> <p>With the menu open:</p> <p>Confirm changes, open the selected menu. See section 1.5</p>
7	MENU key	<p>Open or close the menu the menu. See section 1.5.</p> <p>Note: The MENU key will not open/close the menu in the following situations:</p> <ul style="list-style-type: none"> VRM or EBL is being set. DROP MARK or MARK is being inscribed. Alarm Zone (AZ) or TARGET ALARM is being set.
	RANGE controls	Increase or decrease the range. See section 1.31.
	ACQ key	<ul style="list-style-type: none"> Manually acquire the cursor-highlighted target for Target Tracking (TT).
	TARGET DATA key	<ul style="list-style-type: none"> Show the information for the cursor-highlighted target. Change the selected TT target's symbol (B/W-types only). Activate a sleeping AIS target. See section 3.2.

No.	Control Name	Description
7	TARGET CANCEL key	<ul style="list-style-type: none"> • Cancel tracking for the selected target. • Sleep the selected AIS target. • Long press: Cancel tracking for all TT targets. See section 3.2.
8	Trackball controls	See section 1.1.2.

1.1.2 Control Unit RCU-015/RCU-016

The RCU-015 and RCU-016 offer an easy to use mouse-like control interface, without the bulkiness of the RCU-014. You can access all your radar functions from the RCU-015/RCU-016, however, only the function keys are available as short-cut keys.

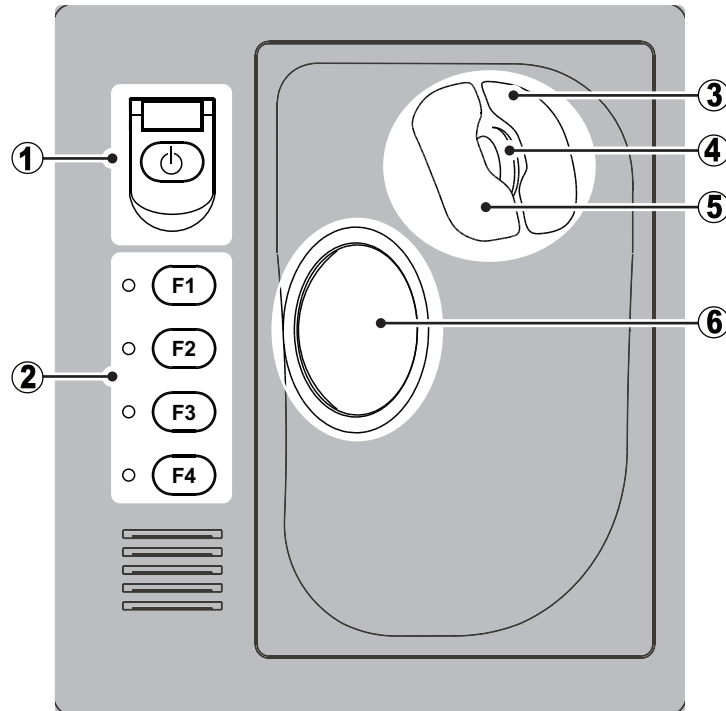

No.	Control Name	Description
1	Power button*	Turn the power on or off. See section 1.2.
2	Functions keys (F1 to F4)	Perform a pre-registered function. See section 1.9.
3	Right mouse button	<u>Short press:</u> <ul style="list-style-type: none"> • Show the pop up menu for the highlighted item. • Cancel changes to the currently selected setting. • With pop up menus shown: Hide pop up menus. <u>Long press:</u> <ul style="list-style-type: none"> • Change the screen brilliance to [50].
4	Scrollwheel	<ul style="list-style-type: none"> • Change settings. • Highlight a menu item.
5	Left mouse button	Select a highlighted object or menu item.
6	Trackball	<ul style="list-style-type: none"> • Moves the cursor. • Highlight an object or menu item.

*: The RCU-016 Control Unit has no power button. To turn the power on or off when using a RCU-016 Control Unit, use the power button on the RCU-014/RCU-015.

1.2 How to Turn the Radar On/Off

The power button (⏻) is located at the top-left corner of the RCU-014 and RCU-015 Control Units.

Note: The RCU-016 Control Unit has no power button. To turn the power on or off when using a RCU-016 Control Unit, use the power button on the RCU-014/RCU-015.

To turn the power on, open the power switch cover, then press the power button.

The LED to the left of the power button lights up (green color) and the system begins the startup process. The indication "Initializing....." appears at the center of the screen. When the startup process is complete, the system begins warm-up procedures to prepare the magnetron for transmission. The warm-up can take up to three minutes. During the warm-up, indications for total on-time (magnetron on-time since installation) and total transmission time (since installation) appear below the warm-up countdown timer. These indications are also displayed when the radar is in standby mode. When the warm-up process is complete, the radar goes into standby (STBY) mode and the indication "RADAR STBY" (IMO-types) or "STBY" (A/B/R/W-types) appears. This indication also appears whenever the equipment is in STBY mode.

Note 1: For B/W-types with Radar Plotter functionality, the "STBY" indication appears only once, when the equipment is turned on.

Note 2: For B/W-types with Radar Plotter functionality, the numerals on the heading dial (outer-most range ring) are not shown and the TT function is inactive while in standby (STBY) mode.

Note 3: Do not turn on the power directly after it has been turned off. Wait several seconds before you reapply the power, to be sure the radar starts up properly.

To turn the power off, open the power switch cover, then press the power button.

Note: Solid state radars do not have a magnetron, therefore they have no warming period.

1.3 How to Adjust the Brilliance

The screen brilliance (brightness) for monitors can be adjusted as shown below.

Note: The following procedure applies only to monitors supplied by FURUNO for this system. For other monitors, see the monitor operator's manual to adjust the brilliance.

Brilliance adjustment from the Control Unit (RCU-014)

Rotate the **BRILL** knob clockwise to increase the brilliance (brighter), or rotate the **BRILL** knob counter-clockwise to reduce the brilliance (darker).

Brilliance adjustment from the on-screen box

Select the [BRILL] box, then spin the scrollwheel on the Control Unit upwards to reduce the brilliance (darker) or downwards to increase the brilliance (brighter).

Note: The above scrollwheel operation is based on default settings for [2 MOUSE WHEEL DIR]. See section 1.10.



1.4 Display Indications

Note: The example screen below may differ slightly from your display, depending on the monitor purchased in your configuration. The overall information, however, is the same.

The on-screen display for your radar system is divided into three main areas, as shown in the figure below.

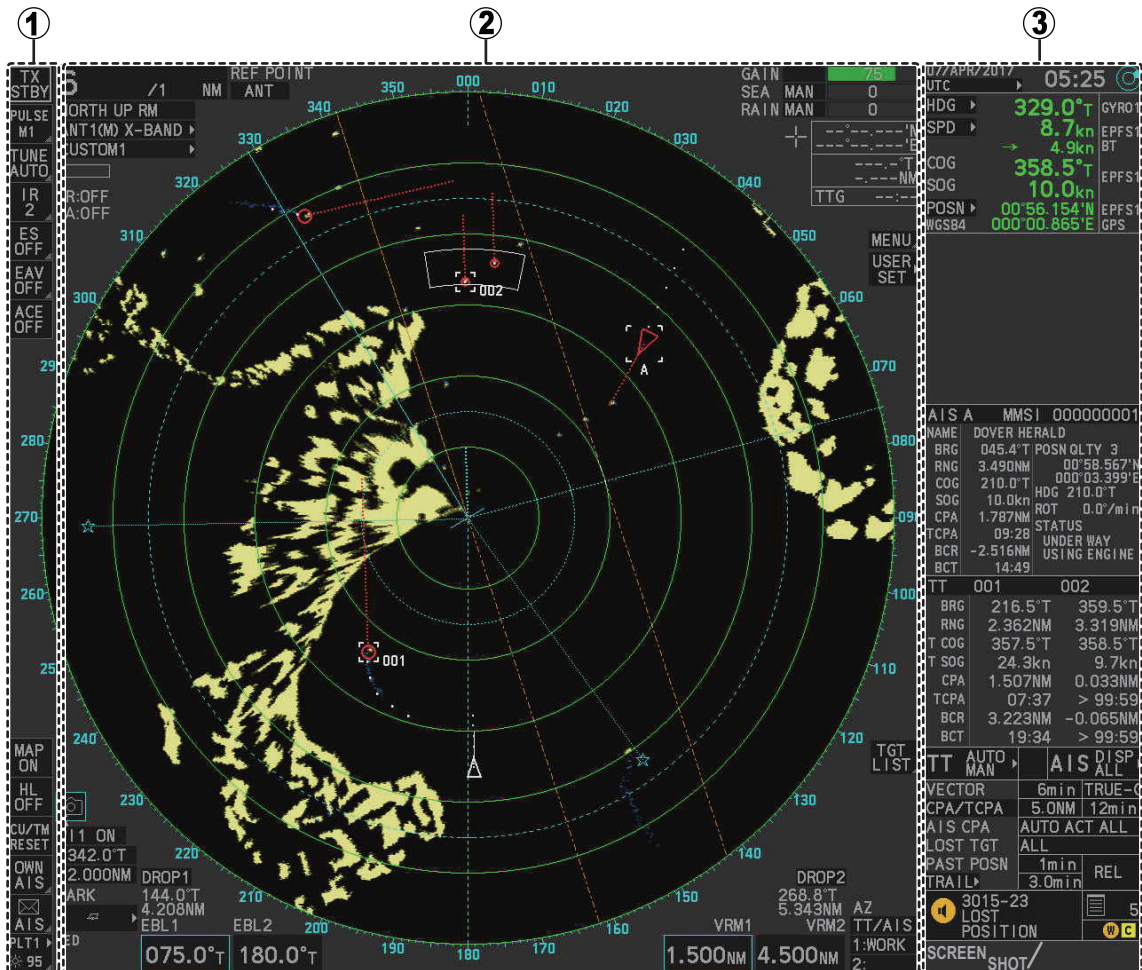















- 1: InstantAccess bar™. See section 1.4.1.
- 2: Radar display and function boxes. See section 1.4.2.
- 3: Information and settings. See section 1.4.3.

Display specifications

	MU-190/190HD/192HD	MU-231	MU-270W
Nominal viewing distance	1.02 m	1.20 m	1.02 m
Text height (min. font)	3.53 mm	4.23 mm	3.64 mm
Text width (min. font)	2.36 mm	2.97 mm	2.43 mm

1.4.1 InstantAccess bar™ buttons

Button	Description
Upper Half	
	Standby/Transmit button. Toggle between standby (STBY) and transmit (TX).
	Pulselength button. Selects the pulselength.
	Tune button. Toggles between automatic and manual tuning. (See section 1.17.1.) Note: For SSD antennas, this button appears as "TX CH x" ("x" denotes the channel used for transmission). If your radar is receiving interference from another radar operating at the same frequency, use the [TX CH] button to change the TX frequency.
	Interference Rejector button. Activates/deactivates the interference rejector feature.
	Echo Stretch button. Activates/deactivates the echo stretch function.
	Echo Average button. Activates/deactivates the echo average function. Note: This item is grayed out under the following conditions: <ul style="list-style-type: none"> • ACE function is active. • No position data is input (excludes Dead Reckoning).
	ACE button. Activates/deactivates the ACE (Auto Clutter Elimination) function.
Lower Half	
	Chart button. <ul style="list-style-type: none"> • Shows/hides the chart. • Opens the [CHART] menu. Note: Appears on A/B/W-types with Radar Plotter functionality only.
	Radar Map button. Shows/hides the radar map marks.
	HEADING LINE button. Left-click and hold to hide the heading line, range rings and OS symbol.
	CU/TM RESET button <ul style="list-style-type: none"> • Puts the ship's heading at the top of the screen in course-up mode the moment this button is pressed. • Resets the ship's position to a point of 75% radius opposite to the extension of the heading line passing through the display center in true motion modes.
	Own Ship AIS button. Shows the AIS VOYAGE DATA for AIS data setup.
	AIS Message button. Opens the AIS Message menu, allowing you to view received AIS messages.
	Brilliance button. <ul style="list-style-type: none"> • Adjusts the screen brilliance • Opens the [BRILLIANCE] menu. • Selects the color palette. See section 1.45.1.

1.4.2 Radar display and shortcuts

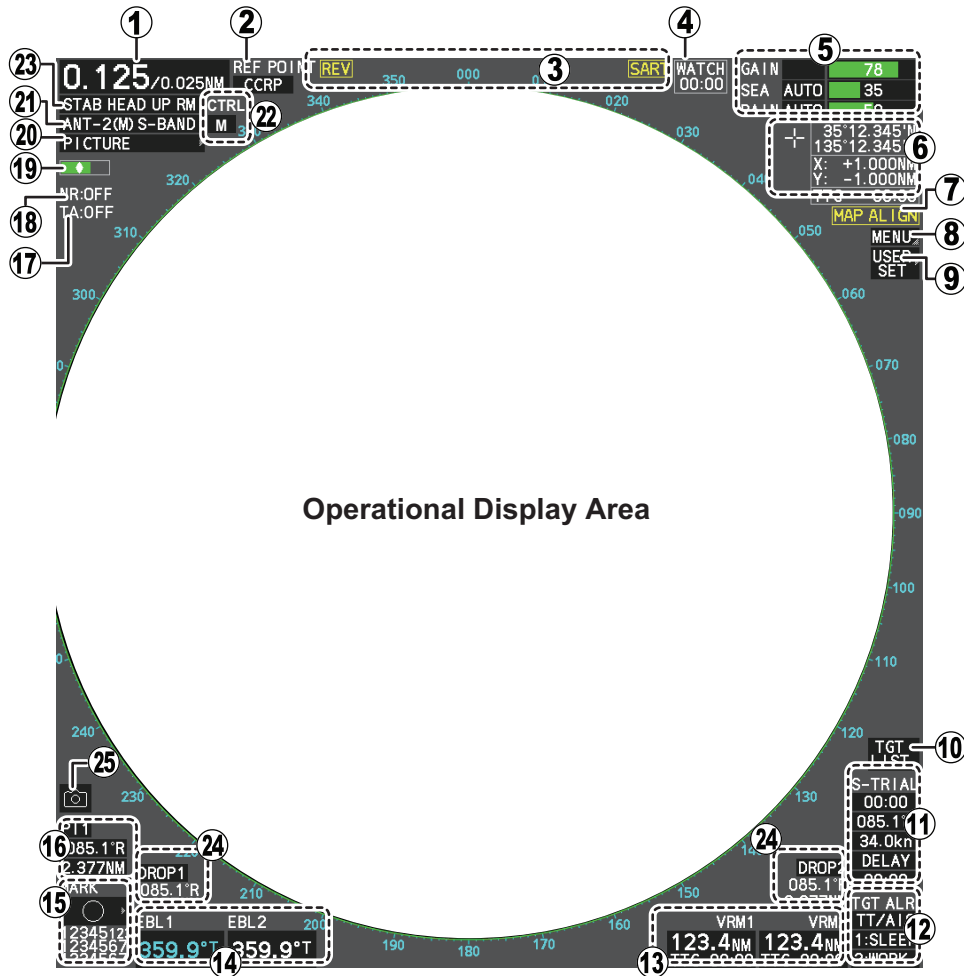







No.	Name	Description
-	Operational Display Area	Radar echoes are displayed here.
1	[RANGE] box	Shows/changes the current range in use.
2	[REF POINT] box	Shows/changes the point of reference.
3	Indications	Shows indications for SART, shuttle ferry mode, etc.
4	[WATCH] box	<ul style="list-style-type: none"> Shows the watch alert countdown timer. Resets the watch alert countdown. Note: The watch alert is available only for A/B/W-types.
5	[ECHO ADJUST] box	Place the cursor on a box to adjust the setting. <ul style="list-style-type: none"> [GAIN] bar: Shows the level of gain in use. [SEA] bar: Shows the level and mode of sea clutter reduction. [RAIN] bar: Shows the level and mode of rain clutter reduction.
6	Cursor position details	<ul style="list-style-type: none"> Shows the location (coordinates) of the cursor position. Shows the TTG to the cursor position. Shows the bearing and range to the cursor position.
7	[MAP ALIGN] indication	Shows/hides the map alignment status.
8	[MENU] box	Opens/closes the menu.
9	User settings box	<ul style="list-style-type: none"> Loads pilot settings. Opens the [USER SET] menu.
10	[TGT LIST] box	Shows the target details list for tracked TTs and active AIS targets.

1. OPERATIONAL OVERVIEW

No.	Name	Description
11	[TRIAL MANEUVERS] box	<ul style="list-style-type: none"> • Activates/deactivates trial maneuvers. • Sets up trial maneuver parameters.
12	[ACQUISITION ZONE] box	<ul style="list-style-type: none"> • Adjust acquisition zone settings for target alarms. • Toggle between sentry zone and acquisition zone alert modes.
13	[VRM] box	<ul style="list-style-type: none"> • Activate/deactivate the VRM (Variable Range Marker). • Adjust the active (selected) VRM. • Shows VRM range and TTG.
14	[EBL] box	<ul style="list-style-type: none"> • Activate/deactivate the EBL (Electronic Bearing Line). • Adjust the active (selected) EBL. • Shows EBL bearing.
15	[MAP MARK] box	<ul style="list-style-type: none"> • Selects a map mark to use. • Inscribes the selected map mark.
16	[PI Lines] box	<ul style="list-style-type: none"> • Selects PI line set to use. • Shows/hides the selected PI lines. • Shows the angle, reference and range interval for the PI lines.
17	[TARGET ANALYZER] indication	Shows the target analyzer function's ON/OFF status. Note: Appears only for B/W-types.
18	[NOISE REJECTOR] indication	Shows the noise rejector function's ON/OFF status.
19	[TUNING LEVEL] bar	<ul style="list-style-type: none"> • Shows the level of tuning in use. See section 1.17. • Adjusts the tuning (manual only). See section 1.17.3. Note: The [TUNING LEVEL] bar is not shown for solid state radars.
20	[PICTURE] box	<ul style="list-style-type: none"> • Selects a preset custom display. • Right-click to open the [CUSTOMIZED ECHO] menu.
21	[ANTENNA SELECTION] box	<ul style="list-style-type: none"> • Selects the antenna to use for radar images. • Right-click to open the [SELECT ANTENNA] menu.
22	[CONTROL] box	Indicates which Dual Radar image is currently selected. <ul style="list-style-type: none"> • "M": Master. Operations and settings are applied to the Main (Master) radar image. • "S": Slave. Operations and settings are applied to the Sub (Slave) radar image. Note: Appears only for A/B-types when the dual radar function is enabled at installation and the connected radar is turned on.
23	[PRESENTATION MODE] box	Change the presentation (orientation) mode for the radar images.
24	[DROP MARK] box	Shows the bearing and range to the drop mark(s).
25	Screenshot button	Saves a screenshot of the entire displayed area. Note: Requires SD card to be inserted in the Processor Unit. Shown in gray and not selectable if no SD card is inserted.

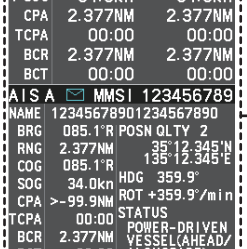
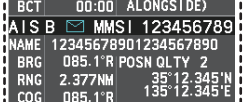
1.4.3 Information and settings

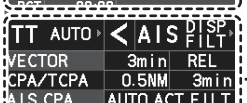
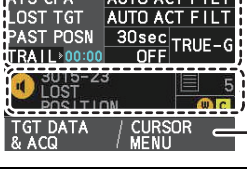
	No.	Description
	1	<u>Date/Time</u> Shows date and time (with offset indication).
		<u>Working indicator</u> Stops rotating if the system is not functioning normally (screen freeze, etc.).
	2	<u>Own Ship information</u> Shows heading, speed, water tracking speed* ¹ , COG, SOG* ² , coordinates and sensor used for data input.
	3	<u>Information box</u> <ul style="list-style-type: none"> Shows information for selected TT or AIS targets. Shows the currently selected menu. Shows navigational data. Shows the performance monitor graph. Shows the zoomed area. Note: TT/AIS data are hidden when the menu is open.
	4	<u>TT/AIS settings</u> Contains settings for vectors, CPA, TCPA, lost targets, trails, etc.
	5	<u>Alert box</u> Shows active alerts and contains a shortcut to the alert list.
	6	<u>Guidance box</u> Shows operational guidance for the Control Unit's left button and right button .
		* ¹ : Direction is indicated with an arrow facing PORT or STBD. * ² : Where the data source for COG/SOG is a satellite log, the indication shows "SLOG".

1.5 Menu Operations

1.5.1 How to open and close the main menu

The main menu can be accessed from the control unit or from the on-screen box. The [MAIN MENU] appears in the information box at the right side of the screen.

From the control unit (RCU-014)

Press the **MENU** key on the control panel.

From the on-screen box

Place the cursor the [MENU] box, then press the **left button**.

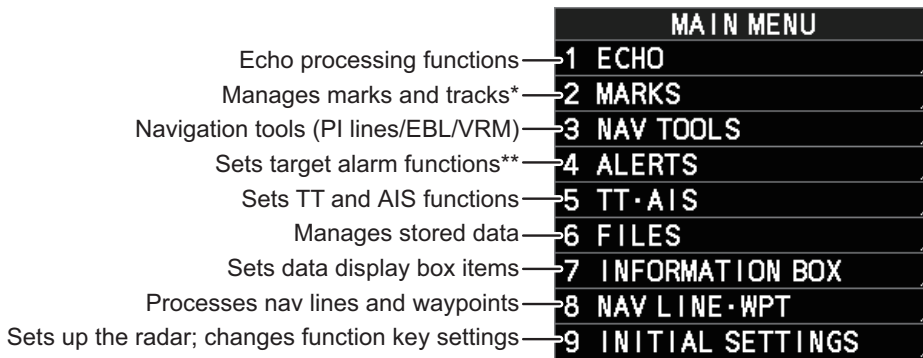

*: Own ship and other ships tracks.

** : Alert contact output is set at installation.

Note: For the sake of abbreviation in procedures, the above methods are written collectively as “Open the menu.” and “Close the menu.”

1.5.2 How to operate the menus

1. Open the menu.
2. Roll the scrollwheel to select a menu item, then left-click. The menu item currently selected is highlighted and shown in reverse video. You can also select a menu item by pressing the corresponding numeric key on the control unit.

Menu selection is highlighted and in reverse video.

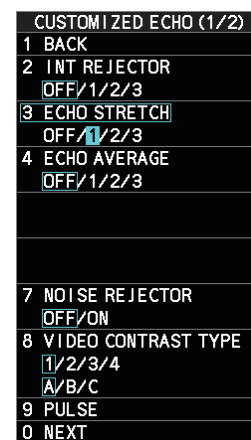
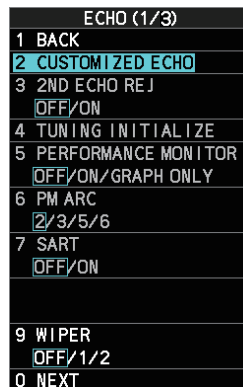
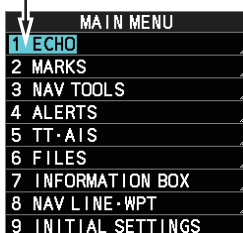

Select menu items with arrows (←) to access the next menu layer. In this example, the [ECHO] menu is accessed, then the [CUSTOMIZED ECHO] menu is accessed.

The next menu layer appears. Menu items with arrows, as shown in the above example figure, have their own menu layer. You can select these items to show the respective menu.

3. Roll the scrollwheel to select a menu item, then left-click. You can also select a menu item by pressing the corresponding numeric key. When required, repeat this step to access the next menu. In the example, [1 ECHO] is selected, which opens the [ECHO (1/2)] menu. Next, [2 CUSTOMIZED ECHO] is selected, which opens the [CUSTOMIZED ECHO (1/2)] menu. Finally, [3 ECHO STRETCH] is selected, in order to change settings. Menus such as the [ECHO] menu and [CUSTOMIZED ECHO] menu have more than one page. In this case, the currently displayed page is indicated in brackets to the right of the menu title.
To view the next page of a menu, select [0 NEXT].
To go back one layer (or page) in the menu, left-click [1 BACK], or right-click.
4. Roll the scrollwheel to select the desired setting, then left-click. The selected settings is highlighted and displayed in reverse video. In the above example, the selected setting at [3 ECHO STRETCH] is [1].
Note 1: For some menu items, the software keyboard, shown in the figure below, is displayed at the bottom of the menu. Select the number/character desired with the cursor, then left-click. When you finish entering the desired numbers/characters, left-click the [END] button on the software keyboard.





Note 2: Unless otherwise stated, operations in this manual use the scrollwheel for procedures which require menu selection, or settings changed.

5. Close the menu.

1.6 How to Use the On-screen Box Menus

Some radar functions can be accessed using the on-screen box as a shortcut to the respective menus. A "▶" at the right side of an on-screen box indicates that there is a menu shortcut available.

Note: The cursor changes shape according to its location. When placed outside the operational display area the cursor is an arrow () shape. When placed inside the operational display area, it is a cross ().

For the purpose of this example, place the cursor on the palette indication (displayed as "PLTx", where x is the currently selected palette number), inside the brilliance settings box at the bottom-left of the screen.

The selected item appears highlighted with a light-blue colored box.

Right-click to show the [BRILL1] box menu.

Similar shortcuts are available from the following on-screen boxes/indications:

- [PICTURE] box.
- [AIS] box.
- [TT] box.
- [HDG] indication.
- [SPD] indication.
- [POSN] indication.
- [PLT] indication.
- [ANTENNA SELECTION] box.
- User settings box.
- [MARK] box.
- Time indication ("UTC" or "Local").
- [TRAIL] indication.
- [CHART ON/OFF] button (A/B/W-types with Radar Plotter functionality only).

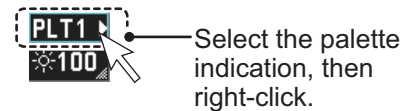

BRILL1 (1/2)	
1	BACK
2	ECHO COLOR YEL/GRN/WHT
3	PALETTE DAY-GRY/DAY-BLU/ DAY-GRN/DUSK-GRY/ DUSK-BLU/DUSK-GRN/ NIGHT-GRY/NIGHT-BLU
4	CONTROL PANEL
5	CHARACTERS
6	CURSOR
7	ECHOS
8	TRAILS
9	HL
0	NEXT

1.7 How to Use the CURSOR Menu

Functions that require the use of the cursor, such as EBL offset and zoom, can be activated directly from the guidance box or from the [CURSOR] menu, either method with the cursor inside the operational display area. Below is the procedure for choosing cursor-related functions from the [CURSOR] menu.

1. Select the operational display area, then press the **right button**.
The [CURSOR] menu appears.
2. Select the desired function, then left-click.
Note: Cursor function are also selectable from the operational display area. With the menu closed, place the cursor inside the operational display area, spin the scrollwheel to show the desired function, then press the **left button** to activate the function.
3. The guidance box shows "XX / EXIT" (XX = function selected). Use the trackball to place the cursor where desired.
4. Left-click to execute the function selected at step 3.
5. To quit the selected function, right-click when the guidance box shows "XX / EXIT" (XX = function selected).
The table below lists the contents of the cursor context menu with a brief description for each menu item.

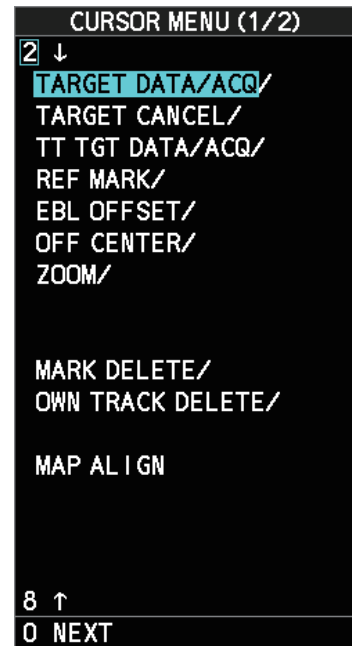

Menu Item	Description
Page 1	
TARGET DATA / ACQ	TT: Acquires target; displays data for selected tracked target. AIS: Activates sleeping AIS target; displays data for selected AIS target.
TARGET CANCEL	TT: Cancels tracking on selected tracked target. AIS: Sleeps selected AIS target.
TT TGT DATA / ACQ	Acquires selected echo as tracked target.
REF MARK	Inscribes reference mark, for target-based speed input.
EBL OFFSET	Offsets EBL to measure range and bearing between two targets.
OFFCENTER	Shifts screen center to selected location.
ZOOM	Zooms selected location.
TARGET TRACK ON*1*3	Shows the target tracks.
TARGET TRACK OFF*1*3	Hides the target tracks.
MARK DELETE	Deletes selected mark (plotter mark, origin mark or waypoint mark).
OWN TRACK DELETE	Deletes own ship's tracks.
TGT TRACK DELETE*1	Deletes the selected target's tracks.
MAP ALIGN	Aligns charts (maps) with the radar picture.
TRAIL ERASER*2	Erases trails.

Menu Item	Description
Page 2	
TARGET DATA / ACQ SETTING	Change target tracking settings.
TARGET CANCEL SETTING	Change target cancel settings.

*1: Shown on A/B/W-types only

*2: Shown on B/W-types only

*3: Shown on A/B/W-types only when [5 AUTO TARGET TRACK], located in [2 MARKS] ([2 MARKS•CHARTS] for systems with Radar Plotter functionality) → [7 TRACKS] → [3 TARGET TRACK] menu, is set to [OFF].

1.8 Cursor Data

The cursor data display shows the cursor's latitude and longitude position or the cursor's X-Y co-ordinates.

Place the cursor on the [CURSOR DATA] box at the top-right side of the display then press the **left button** to switch between display formats.

The data box shows the cursor location, bearing/range to the cursor location and the time to go (TTG) to the cursor location.

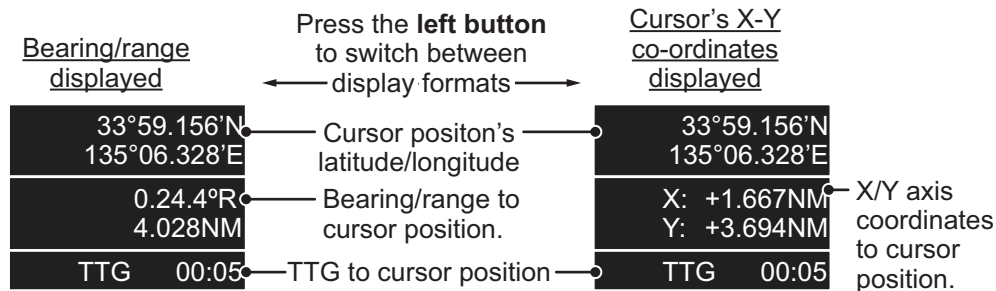

Note 1: For the X-Y co-ordinates display, the Y-axis is the upper/lower half of the screen, the upper half of the screen is “plus” and the lower part of the screen is “minus”. The X-axis is the left/right-side of the screen, right is “plus”, left is “minus”.

Note 2: Cursor data reads "- - -" when the cursor is placed outside the operational display area.

1.8.1 How to change the cursor data attributes (B/W-type only)

You can change the cursor bearing reference, cursor range unit, cursor size and also align the cursor by latitude/longitude. Changing some of these settings affects the indications in the cursor data display.

1. Open the menu.
2. Select [3 NAV TOOLS].
3. Select [3 EBL•VRM•CURSOR SET].
4. Select [9 CURSOR]. The [CURSOR] menu appears.
5. Select the item you want to change, referring to the list below.

CURSOR	
1	BACK
2	CURSOR BEARING REL/TRUE
3	CURSOR RANGE NM/km/SM/kyd
4	CURSOR SIZE SMALL/LARGE
5	CURSOR L/L ALIGN OFF/ON

- [2 CURSOR BEARING]: Sets the bearing reference.
 - [3 CURSOR RANGE]: Sets the unit for cursor range.*
 - [4 CURSOR SIZE]: Sets the cursor size.
 - [5 CURSOR L/L ALIGN]: Set whether to align the cursor with latitude/longitude.
- *: Appears for B-types only.

6. Close the menu.

1.9 How to Set Up Function Keys

Some menu functions and menus can be assigned to a function key. This allows one-touch access to the assigned function or menu.

To activate an assigned function, press the corresponding function key (**F1**, **F2**, **F3** or **F4**).

The current presets are listed at the bottom of the menu page and the **function keys** are preset with the following functions:

F1: Interference Rejector, **F2**: Echo Stretch, **F3**: AUTO-SEA, **F4**: AUTO-RAIN.

You can change the function assigned to each key using the following procedure.

1. Open the [MAIN MENU].
2. Select [9 INITIAL SETTINGS].
3. Select [6 FUNCTION KEY SETUP]. The function key setup menu appears.
4. Select the function key to set up.
5. Referring to the following table of available functions, select a function category, then left-click.

FUNCTION KEY SETUP	
1	BACK
2	F1
3	F2
4	F3
5	F4
F1:	IR
F2:	ES
F3:	AUTO-SEA
F4:	AUTO-RAIN

1. OPERATIONAL OVERVIEW

Function category	Available functions
ECHO	CUSTOM SELECT, IR, ES, EAV, NOISE REJ, ANT SELECT, PULSE LENGTH, AUTO-SEA, AUTO-RAIN, TUNE SELECT, 2ND ECHO REJ, STC CURVE, STC RANGE, PM, SART, ECHO TRAIL, TRAIL T/R, WIPER* ¹ , ACE, ACE HIGH SENSITIVITY
STD KEY	ALERT ACK, STBY TX, HL OFF, EBL OFFSET, ORIENTATION-MODE, OFF CENTER, CU-TM RESET, PI LINE, VECTOR TIME, VECTOR MODE, TARGET LIST, BRILL, MARK, MENU, RANGE UP, RANGE DOWN, ACQ, TARGET DATA, TARGET CANCEL
TT•AIS	TT-DISP, AIS-DISP, TARGET DATA & ACQ, PAST POSN INTERVAL, REF MARK, CPA LIMIT, CPA, TCPA, AZ1, AZ2, TARGET LIST SORT, TRIAL MANEUVER, TRIAL MODE CHANGE, AIS MESSAGE, AIS SCALED SYMBOL
DELETE DATA	MARK DELETE, MARK ALL DELETE, OWN TRK DELETE, OWN TRK ALL DELETE, TGT TRK DELETE* ³ , TGT TRK ALL DELETE* ³
OPERATION	BUZZER STOP, ECHO AREA* ¹ , ECHO COLOR, PALETTE, RING(ON/OFF), ZOOM, MOB, ALARM1, ALARM2, WATCH ALERT RESET* ³ , TLL* ¹ , MAP ALIGN, ANCHOR WATCH, DROP MARK, SCREEN SHOT, CHART DISPLAY* ² , NAV AIDS* ²

*1: Appears for B/W-types only.

*2: Appears for A/B/W-types with radar plotter functionality only.

*3: Appears for A/B/W-types only.

6. Select the appropriate function to assign, then left-click.
You can check the currently assigned functions in the bottom half of the menu.
7. Repeat the procedure as necessary to set up other function keys.
8. Close the menu.

1.10 How to Customize Operation

Several operation items can be customized to suit your needs.

1. Open the menu.
2. Select [9 INITIAL SETTING].
3. Select [5 OPERATION]. The [OPERATION] menu appears.

OPERATION(1/2)	OPERATION(2/2)
1 BACK	1 BACK
2 MOUSE WHEEL DIR NORMAL/REVERSE	2 AUTO COURSE UP RESET OFF/ON
3 KEY BEEP OFF/LOW/MID/HIGH	
4 OWN SHIP VECTOR OFF/HDG/COURSE	
5 STERN UP RM OFF/ON	
6 SHUTTLE FERRY OFF/MODE1/MODE2	
7 ICING PREVENTION OFF/ON	
8 BRG FINE ADJUST +0.0°	
9 USB MOUSE SPEED 1/2/3/4/5	
0 NEXT	

These menu items appear for all radar types, however B/W-types may have additional menu items. See the following table for details.

4. Referring to the table below, press the menu item number to select the appropriate menu item to customize.

Menu items	Description
Page 1	
[2 MOUSE WHEEL DIR]	Sets the direction of the wheel drive (scrollwheel). <ul style="list-style-type: none"> • [NORMAL]: Scroll downwards to increase, or upwards to decrease the value. • [REVERSE]: Scroll directions are reverse of [NORMAL].
[3 KEY BEEP]	Changes the key beep volume. Select [OFF] to silence the key beeps. Select [LOW], [MID], [HIGH] to adjust the volume for key beeps.
[4 OWN SHIP VECTOR]	Select how the own ship vector is displayed. <ul style="list-style-type: none"> • [OFF]: Own ship vector is not displayed. • [HDG]: Vector is displayed in heading direction. • [COURSE]: Vector is displayed in course direction.
[5 STERN UP RM]	Select [ON] to show [STERN UP RM] orientation in the selection cycle. (See section 1.30.) Note: This item is shown for A/B/W-types only.
[6 SHUTTLE FERRY]	Sets the shuttle ferry mode to use. <ul style="list-style-type: none"> • [OFF]: Shuttle ferry mode is deactivated. • [MODE1]: Shuttle ferry mode is activated. See "Shuttle ferry mode" on next page. • [MODE2]: Shuttle ferry mode is activated. See "Shuttle ferry mode" on next page. Note: Shuttle ferry mode requires an external switch.
[7 ICING PREVENTION]	Select [ON] to rotate the antenna without transmission, to prevent ice buildup. See section 1.53.
[8 BRG FINE ADJUST]	Adjusts the heading line location. 0.0°, the default setting, shows the heading line pointing towards the top of the screen.

1. OPERATIONAL OVERVIEW

Menu items	Description
[9 USB MOUSE SPEED]	Adjust the USB mouse sensitivity. A higher value increase the mouse cursor's movement speed.
Page 2	
[2 AUTO COURSE UP RESET]	Select [ON] to enable, or [OFF] to disable the automatic reset of the screen when using COURSE UP orientation and your course is more than 22.5° to either side the center of the screen.
[3 DISPLAY SCROLL]	Select [ON] to enable, [OFF] to disable display scrolling. When set to [ON], move the cursor to the edge of the screen in the direction you want to scroll. Note: This item is shown for B/W-types only.

- Select the required setting by pressing the menu item number. For this example, set [3 KEY BEEP] to [HIGH]. Press the **3 MODE** key to highlight [HIGH]. For [8 BRG FINE ADJUST] and other menu items with a setting range, spin the scrollwheel, or use the number keys to adjust the required setting.
Note: Regarding input for [8 BRG FINE ADJUST], when using the number keys, the indication is first selected as a whole. At this time, you can toggle between plus "+" or minus "-". Press the **8** key for "-", press the **2** key for "+". If single digits are highlighted, toggle is not possible. In this case, press the **CANCEL TRAILS** key to re-highlight the whole indication.
- Close the menu.

Shuttle ferry mode

The shuttle ferry mode changes the orientation of the display when the external switch is turned on. (The external switch should be connected to the RS-232C port on the processor unit at installation.)

There are two variations: Standard display ([SHUTTLE FERRY] is set to [OFF]) and reversed display ([SHUTTLE FERRY] is set to [MODE1] or [MODE2]).

When the display is reversed for shuttle ferry mode, the following changes also occur:

- Echoes are displayed 180° opposite to normal display.
- Bearing for speed data is re-calibrated to 180° opposite to normal.
- Wind direction based on speed input is re-calibrated to 180° opposite to normal.
- Where [Mode2] is selected, data input from the gyrocompass is re-calibrated to 180° opposite to normal.

Note: Gyrocompass data input is not re-calibrated for [Mode1].

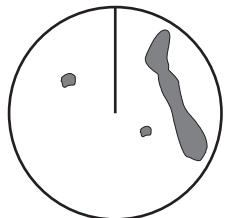

Standard display: Gyro input is displayed normally.

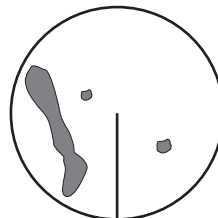

Reversed display: Gyro input is displayed in reverse.

1.11 How to Select the Interface for Heading Input

When a gyrocompass is connected, the ship's heading appears on the right side of the screen, in the data display area.

Heading input format can be selected as follows:

1. Open the menu.
2. Select [7 INFORMATION BOX].
3. Select [2 OWN SHIP INFO].
4. Select [2 HDG]. The [HDG] menu appears.
Note: You can also access the [HDG] menu from the on-screen box. Place the cursor on the [HDG ►] indication in the heading box at the top-right of the screen, then right-click.
5. Select [2 HDG SOURCE].
6. Select [GYRO1] or [GYRO2] as appropriate.
7. Close the menu.

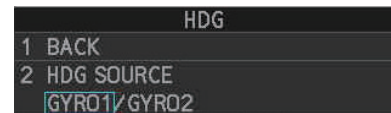

Note 1: The heading sensor must be able to follow a minimum ROT of 20° per second. Heading sensors with a lesser capability may degrade the performance of echo averaging, trails and TT. The data refresh rate should also be as short as possible. If the refresh rate is too long, the ability to follow courses lessens, thereby affecting the performance of echo averaging, trails and TT.

Note 2: For IMO-types, Where the heading source is other than the heading sensor (for example, and EPFS device), the sensor indication is displayed in yellow color.

1.12 How to Set Own Ship's Speed

The TT and azimuth stabilized presentation modes require own ship speed input and compass signal. The speed can be entered from a log (STW, SOG) or EPFS (SOG) or manually on the menu.

1.12.1 Automatic speed input (log or EPFS navigator)

1. Open the menu.
2. Select [7 INFORMATION BOX].
3. Select [2 OWN SHIP INFO].
4. Select [3 SPEED].
5. Select [2 SHIP SPEED].
Note: You can also access the [SPEED] menu from the on-screen box. Place the cursor on the [SPD ►] indication in the speed box at the top-right of the screen, then right-click.
6. Select the appropriate source for automatic speed input, referring to following table.

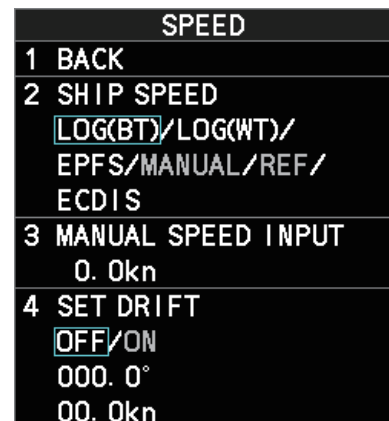

Note: Changes to the settings here are also applied to the speed calculations for TT targets, true trails, SOG and STW.

1. OPERATIONAL OVERVIEW

Selection	Explanation	Stabilization Mode
[LOG (BT)]* ¹	Log, speed over ground (SOG)	Ground stabilization
[LOG (WT)]	Log, Speed Thru Water (STW)	Sea stabilization
[EPFS]	Speed input by GPS navigator	Ground stabilization
[MANUAL]	Manually input speed	Sea stabilization
[REF]	Echo-referenced speed input	Ground stabilization
[ECDIS]* ²	Speed input by ECDIS	Ground stabilization or Sea Stabilization (Dependent on ECDIS settings).

*¹: Set and drift may be required to display [LOG (BT)] correctly in deep waters. To change set and drift, see section 3.14.

*²: Where [ECDIS] is selected as the speed source, [4 OWN SHIP POSN] in the [OWN SHIP INFO] menu is automatically set to [ECDIS] also. See section 1.13.

7. If you selected [MANUAL] as the speed data source, see section 1.12.2 to set the speed.
8. Close the menu.

Notes on speed input

It should be noted that in determining a target's aspect by radar, the calculation of its true track is dependent on the choice and accuracy of the own ship's course and speed input. A ground-stabilized target plot may accurately calculate the ground track of the target, but the target's heading may be significantly different from its track when experiencing set, drift or leeway. Similarly, a sea stabilized target plot may be inaccurate when own ship and the target, are experiencing different rates of set, drift or leeway.

- IMO Resolution A.823(19) for TT recommends that a speed log to be interfaced with a TT should be capable of providing through-the-water speed (forward speed).
- Be sure not to select a [LOG] option when a speed log is not connected. If the log signal is not provided, the ship speed readout at the top of the screen will be blank. In the event of a log error, enter speed manually.
- If a speed log is selected as the data source and there is no signal present for 30 seconds, the [SPD] is shown as ".* kn" and the label "LOST LOG(BT) SIG" or "LOST LOG(WT) SIG" in yellow-orange appears and the alert buzzer sounds.
- When the speed input in use is interrupted or lost, the system automatically changes to another speed input (stabilization reference) and shows the "SPD SOURCE CHG" indication.
- On IMO-type radars with AIS in use, [MANUAL] and [REF] are shown in gray to indicate they are not available for selection.
- A single-axis water log cannot measure speed when the wind is coming from the leeway direction.
- When [ECDIS] is selected as the speed data source and communication with the ECDIS is interrupted or lost for 30 seconds, the Alert "LOST ECDIS COM" is released.
- When speed stabilization is changed at the ECDIS and [ECDIS] is selected as the speed data source, the "SPD SOURCE CHG" indication appears.

1.12.2 Manual speed input

If the speed log is not working, enter speed manually as below. In this case the speed data type is shown as "MANUAL" and is speed thru water (STW). Manual speed input is not available on IMO-type radars when the AIS feature is active.

1. Open the menu.
2. Select [7 INFORMATION BOX].
3. Select [2 OWN SHIP INFO].
4. Select [3 SPEED].
5. Select [2 SHIP SPEED].

Note: You can also access the [SPEED] menu from the on-screen box. Place the cursor on the [SPD ►] indication in the speed box at the top-right of the screen, then right-click.
6. Select [MANUAL].
7. Select [3 MANUAL SPEED INPUT].
8. Spin the scrollwheel to set the speed.
9. Press the **ENTER MARK** key to confirm the new setting.
10. Close the menu.

1.13 How to Set the Own Ship Position

You can select the data source for own ship's position as follows:

1. Open the menu.
2. Select [7 INFORMATION BOX].
3. Select [2 OWN SHIP INFO].
4. Select [4 OWN SHIP POSN].

Note: You can also access the [OWN SHIP POSN] menu from the on-screen box. Place the cursor on the [POSN ►] indication in the position box at the top-right of the screen, then right-click.
5. Select [2 POSITION SOURCE] or [3 MANUAL L/L INPUT] as appropriate.
6. If [2 POSITION SOURCE] is selected at step 2, select the appropriate position source, referring to the list below.

[2 POSITION SOURCE] uses navigational aids. Select the navigational aid to use. Available options are listed with a brief description in the table below:

OWN SHIP POSN	
1	BACK
2	POSITION SOURCE EPFS1/EPFS2/LAN/ ECDIS/DEAD RECKONING
3	MANUAL L/L INPUT 00°00.000'N 000°00.000'E
4	SIO DATA LAN OUTPUT OFF/ON
POSITIONING SYSTEM EPFS1	

Available options	Description
[EPFS1]	Use the device assigned as EPFS1 for position data.
[EPFS2]	Use the device assigned as EPFS2 for position data.
[LAN]	Use the device connected to the LAN1 port for position data.
[ECDIS]	Use the connected ECDIS for position data.
[DEAD RECKONING]	Position data is derived from dead reckoning (manual input)