

Test Report

For

Model: Transceiver for Marine Radar

Type: RTR-090

Report no.: FLI 12-07-026

Date of issue: 10 July 2007

Furuno Labotech International Co., Ltd.

9-52 Ashihara-cho, Nishinomiya City, Hyogo 662-8580, Japan

Tel: +81-798-63-1094 Fax: +81-798-63-1098

TABLE OF CONTENTS

Testing Laboratory Status	2
1 Principal Information.....	3
1.1 Introduction	3
1.2 Equipment under test (EUT).....	3
1.3 Test schedule	7
1.4 Test specifications applied	7
1.5 Modification made to the EUT	7
1.6 Conclusions	8
2 Test Report Overview	9
3 Test Results	10
3.1 RF Power Output (FCC Rule, 2.1046).....	10
3.2 Modulation Characteristics (FCC Rule, 2.1047)	11
3.3 Occupied Bandwidth (FCC Rule, 2.1049).....	12
3.4 Frequency Stability (FCC Rule, 2.1055)	13
3.5 Spurious Emissions	15
3.5.1 Spurious Emissions at Antenna Terminal (FCC Rule, 2.1051)	15
3.5.2 Field Strength of Spurious Radiation (FCC Rule, 2.1053)	16
3.6 Suppression of Interference Aboard Ships (FCC Rule, 80.217).....	19
4 Test Setup for Measurement	20
5 Measuring Equipment List.....	21
6 Photograph of Test Setup/Arrangement	24
7 RF Envelope and Spectrum of the output pulse	26
8 Spurious Emissions at Antenna Terminal	32
9 Field Strength of Spurious Radiation	33

Testing Laboratory Status

Furuno Labotech International Co., Ltd. (hereafter called FLI) has been holding the following status after having been assessed according to the provisions of ISO/IEC 17025:

(1) Telefication Listed Testing Laboratory:

- listed by Telefication B. V., Edisonstraat 21 A, 6902 PK Zevenaar, The Netherlands
- Laboratory assignment number: L116
- Date of initial certification: 26 July 1999 (*)
- for testing the following product categories/ test standards:
 - EN 60945, Maritime navigation and radiocommunication equipment and systems - General requirements.
 - IEC 61162-1/-2, Maritime navigation and radiocommunication equipment and systems - Digital interfaces - Part 1: Single talker and multiple listeners / Part 2: Single talker and multiple listeners, high speed transmission.

(2) BSH Recognized Testing Laboratory:

- recognized by Bundesamt für Seeschifffahrt und Hydrographie, Bernhad-Nocht-Str. 78, 20359 Hamburg, Federal Republic of Germany
- Laboratory assignment number: BSH-062-03
- Date of initial certification: 4 April 2003 (*)
- for testing in the fields of:
 - “Marine navigational and radiocommunication equipment and systems”
 - EMC and environmental tests according to:
 - IEC 60945: 1996, DIN EN 60945: 1997
 - IEC 60945: 2002, DIN EN 60945: 2001
 - Radar
 - IEC 60936-1: 1999, DIN EN 60936-1: 2000
 - IEC 60936-2: 1998, DIN EN 60936-2: 1999

(3) TÜV Appointed EMC Test Laboratory:

- appointed by TÜV Rheinland Japan Ltd., 19-5 Shin Yokohama 3-chome, Kohoku-ku, Yokohama 222-0033 Japan
- Laboratory assignment number: UA 50046428
- Date of initial certification: 21 December 1998 (*)
- for carrying out the tests of:
 - EN 55022, EN 61000-6-1/-2, EN 61000-6-3/-4, EN 61000-3-2/-3, EN 61000-4-2, EN 61000-4-3, EN 61000-4-4, EN 61000-4-5, EN 61000-4-6, EN 61000-4-8, EN 61000-4-11.

(*): The current certificates may be found in the FLI web site (<http://www.furuno-labotech.co.jp>).

1 Principal Information

1.1 Introduction

This report contains the results of measurements and tests carried out by FLI for the purpose of the technical assessment on the shipborne radar operation in the maritime radionavigation service on the Equipment under Test (EUT).

The order for these tests and inspections has been placed by:

Company name: Furuno Electric Co., Ltd.
Address: 9-52 Ashihara-Cho, Nishinomiya-City, 662-8580 Japan

FLI project no.: FLI 04-07-180

1.2 Equipment under test (EUT)

1.2.1 General

(a) Manufacturer: Furuno Electric Co., Ltd.
Ashihara-cho 9-52, Nishinomiya-city, 662-8580 Japan

(b) Model: DRS2D

	Type	Serial number	Note
Radar Sensor	DRS2D	4356-0002	Radome type, Antenna rotation rate: 24/36/48 rpm.
Transceiver	RTR-090	---	Contained in Radome.
Antenna	DRS2D	---	Microstrip antenna, Contained in Radome.

(c) Primary Function: Search, Navigation and anticollision

(d) Frequency Range: Fixed frequency, X-band

Type of Emission: P0N

(e) Power Supply: 48 VDC (fed through the specified external equipment, not directly from DC mains)

1.2.2 Radar Sensor

1.2.2.1 Transceiver

Type: **RTR-090**
(Contained in the Radome)

(1) Transmitter

- (a) Assignable Frequency for Shipborne Radar:
Between 9300 and 9500 MHz (FCC Rule, 80.375 (d)-(1))
- (b) Type of RF Generator
Magnetron Type: E3590
Peak Output Power: 2 kW nominal
- (c) Magnetron Ratings
Center frequency of Magnetron: 9410 MHz
Tolerances
E3590
Manufacturing: ±30 MHz
Pulling: 27 MHz
Tolerance for 20°C temperature variation: -5 MHz

(d) Pulse Characteristics:

Pulse type	S1	S2	M1	M2	M3	L
Pulselength (µs)	0.08	0.15	0.30	0.50	0.70	0.80
P.R.R.(Hz)	3000	3000	1500	1000	600	600

(2) Modulator

- (a) FET Type: SPP21N50C3
Trigger Voltage: Approx. +20 VDC positive

(3) Receiver

- (a) Passband (MHz)
RF Stage: 60 MHz
IF Stage:

Pulse type	S1	S2	M1	M2	M3	L
(MHz)	20	20	20	1.7	1.7	1.7

- (b) Gain (overall) (dB): Sufficient to cause limiting, approximately 100
- (c) Overall Noise Figure (dB): 4.5 (typical)
- (d) Video Output Voltage (V): ±1 V differential
- (e) Features Provided: Sensitivity Time Controls (Anti-clutter Sea),
Fast Time Constant (Anti-clutter Rain)

- (f) If receiver is tunable, describe method for adjusting frequency:
by adjustment of tuning voltage of receiver local oscillator
(Automatic and manual)

1.2.2.2 Antenna and Scanner

- (a) Antenna Rotation ON-OFF Switch: Not Provided.

- (b) Antenna structure: Microstrip antenna

- (c) Antenna size 42.5 cm (1.4 ft)

- (d) Type of Beam: Vertical fan

- (e) Beam Width (3 dB)

Horizontal	5.2°
Vertical	25°

- (f) Polarization: Horizontal

- (g) Antenna Gain: 23 dB or more

- (h) Attenuation of Major Side Lobes with respect to main beam:

Within ±20°	-24 dB
Outside ±20°	-26 dB

- (i) Scanning (rotating or oscillating): Rotating over 360° continuously clockwise

- (j) Antenna Rotation Rate: 24/36/48 rpm

- (k) Number of Degrees Scanned: 360°

- (l) Sector Scan: Not provided.

- (m) Rated Loss of Transmission line per hundred feet:

Negligible. (Transmission path is only in the Transceiver)

1.2.3 Operational Features

- (a) Is positive means provided to indicate whether or not the overall operation of the equipment is such that it may be relied upon to provide effective operation in accordance with its primary function:

Yes (Magnetron)

- (b) Is the equipment for continuous operation: Yes

- (c) Is provision made for operation with shore based radar beacons (RACONS):

Yes (RACONS and SART)

1.2.4 Line Power Supply Requirements

- (a) Input Voltage: 48 VDC (fed through the specified external equipment, not directly from DC mains)

- (b) Power consumption: 35 W

1.2.5 Construction Features

- (a) Does equipment embody replacement units with chassis type assembly: Yes
- (b) Are fuse alarms provided: No
- (c) State units that are weatherproof: Radar Sensor (IEC 60529 – IP26)
- (d) If all units are not housed in a single container, indicate number and give description of individual units: All units are housed in a single container (Radome).
- (e) Approximate Weight of Complete Installation:
Radar Sensor: 6.0 kg
- (f) Approximate space required for installation excluding scanner: not applicable.

1.3 Test schedule

(1) Date of receipt of EUT: 8 June 2007

(2) Date(s) of tests performed: (Testing period: 16 June 2007 to 22 June 2007)

Tests were carried out in accordance with the specifications described in subclause 1.4 at the following locations and on the following dates:

CFR 47 Section	Item	Test site	Date
2.1046	RF Power Output	FLI Nishinomiya Lab.	16 June 2007
2.1047	Modulation Characteristics	(*1)	16 June 2007
2.1049	Occupied Bandwidth		16 June 2007
2.1055	Frequency Stability		21 and 22 June 2007
	Spurious Emissions	---	---
2.1051	- Spurious Emissions at Antenna Terminal	FLI Nishinomiya Lab. (*1)	16 June 2007
2.1053	- Field Strength of Spurious Radiation	FLI Nishinomiya-Hama Lab. (*3)	20 June 2007
80.217	Suppression of Interference Aboard Ships	---	Not performed

(*1): 9-52 Ashihara-Cho, Nishinomiya City, Hyogo Prefecture, 662-8580 Japan

(*2): 2-20 Nishinomiya Hama, Nishinomiya City, Hyogo Prefecture, 662-0934 Japan

(*3): Anechoic Chamber used for the test has been registered by FCC.

(File number: 90607)

1.4 Test specifications applied

The equipment is intended for use in the following application areas:

For Maritime Safety Navigation,

The sample was tested to the requirements of the following standard:

- FCC Rules 2.1046 - RF Power Output,
- 2.1047 - Modulation Characteristics,
- 2.1049 - Occupied Bandwidth,
- 2.1051 - Spurious Emissions at Antenna Terminal,
- 2.1055 - Frequency Stability,
- 2.1053 - Field Strength of Spurious Radiation,
- 80.217 - Suppression of Interference Aboard Ships.

1.5 Modification made to the EUT

No modifications were made to the EUT during testing.

1.6 Conclusions

The tests on the samples of FURUNO Transceiver RTR-090 for Marine Radar have been completed satisfactorily and showed NO NON-COMPLIANCES with the specifications stated in subclause 1.4 in this report:

The test results of this report relate only to the items tested.

Total page number of this report is 39 including the front page.

Tested by: Katsumi Imamura / Assistant Chief, Technical Section

Reviewed by: Yoshihiro Ishii / Chief Engineer, Technical Section

Approved by:

All data herein contained is true and correct to our best knowledge.

Date: 10 July 2007

Name: Mitsuyoshi Komori
Manager, Technical Section

Signature:



2 Test Report Overview

CFR 47 Section	Item	Satisfactory	Relevant clause
2.1046	RF Power Output	Yes	3.1
2.1047	Modulation Characteristics	Yes	3.2
2.1049	Occupied Bandwidth	Yes	3.3
2.1055	Frequency Stability	Yes	3.4
	Spurious Emissions	---	3.5
2.1051	- Spurious Emissions at Antenna Terminal	Yes	3.5.1
2.1053	- Field Strength of Spurious Radiation	Yes	3.5.2
80.217	Suppression of Interference Aboard Ships	n. p.	3.6

Note: n. a. - Not applicable, n. p. - Not performed.

3 Test Results

3.1 RF Power Output (FCC Rule, 2.1046)

(1) Test conditions:

For all TX (S1/S2/M1/M2/M3/L) Pulses, the transmitter output power was measured at the antenna port with Antenna replaced with the Non-reflective load.

(2) Test setup:

See Clause 4.

(3) Test Results:

Pulse type	S1	S2	M1	M2	M3	L
Magnetron Output, mean (W):	0.32	0.73	0.76	0.82	0.68	0.77
Magnetron Output, peak (kW):	1.5	1.6	1.6	1.6	1.6	1.6

Environmental conditions observed: On 16 June 2007, 23°C to 23°C, 50% to 50%RH

Power supply voltage measured (*): 24.0 VDC to 24.0 VDC.

(*): Power input voltages to the external equipment (Processor unit) measured. DRS2D was powered through the voltage regulator built in the Processor unit, not directly from the external power supply.

3.2 Modulation Characteristics (FCC Rule, 2.1047)

(1) Test Conditions:

The RF envelope of the magnetron output pulse was measured using an envelope detector and an oscilloscope.

Each pulse spectrum was measured using a spectrum analyzer.

(2) Test setup:

See Clause 4.

(3) Limits (FCC Rule, 80.213 (g)):

Upper limit frequency, $f(U) = f_0 + f(AUBW)/2 - 1.5/T$

Lower limit frequency, $f(L) = f_0 - f(AUBW)/2 + 1.5/T$

Note: Assigned frequency (f_0): 9410 MHz

Authorized bandwidth ($f(AUBW)$): 100 MHz

(4) Test Results:

Complied.

Pulse type	S1	S2	M1	M2	M3	L	Result
Pulselength T (μ s) (-3 dB points)	0.070	0.152	0.316	0.510	0.712	0.814	Not applicable
Rise time t_r (μ s) (10 - 90 % amplitude)	0.020	0.064	0.070	0.070	0.070	0.070	Not applicable
Decay time t_f (μ s) (90 - 10 % amplitude)	0.043	0.048	0.048	0.048	0.048	0.048	Not applicable
PRR (Hz)	2999	2999	1499	999	600	600	Not applicable
Guard Band $f(1.5/T)$ (MHz) (*)	21.4	9.9	4.7	2.9	2.1	1.8	Not applicable
$f(U)$ (MHz)	9438.6	9450.1	9455.3	9457.1	9457.9	9458.2	Not applicable
$f(L)$ (MHz)	9381.4	9369.9	9364.7	9362.9	9362.1	9361.8	Not applicable
Frequency at maximum emission (MHz)	9421.2	9420.2	9419.7	9419.4	9419.7	9419.5	Complied

(*): Guard Band is specified to be equal to $1.5/T$ MHz, where "T" is the pulselength in microseconds.
(FCC Rule, 80.209(b))

Measured Plots: See Clause 7.

Environmental conditions observed: On 16 June 2007, 23°C to 23°C, 50% to 50%RH

Power supply voltage measured (*): 24.0 VDC to 24.0 VDC.

(*): Power input voltages to the external equipment (Processor unit) measured. DRS2D was powered through the voltage regulator built in the Processor unit, not directly from the external power supply.

3.3 Occupied Bandwidth (FCC Rule, 2.1049)**(1) Test conditions:**

For all TX (S1/S2/M1/M2/M3/L) Pulses, the transmitter occupied bandwidth was measured at the antenna port with Antenna replaced with the Non-reflective load.

(2) Test setup:

See Clause 4.

(3) Test Results:

Pulse type	S1	S2	M1	M2	M3	L
Occupied bandwidth (MHz)	42.5	23.2	15.2	11.2	8.8	8.0

Environmental conditions observed: On 16 June 2007, 23°C to 23°C, 52% to 52%RH

Power supply voltage measured (*): 24.0 VDC to 24.0 VDC.

(*): Power input voltages to the external equipment (Processor unit) measured. DRS2D was powered through the voltage regulator built in the Processor unit, not directly from the external power supply.

3.4 Frequency Stability (FCC Rule, 2.1055)

(1) Test Conditions:

- 1) Radar Transmitter settings: All TX (S1/S2/M1/M2/M3/L) Pulses
- 2) Ambient Temperature settings: - 20°C to + 50°C (10°C interval)
- 3) Power Supply Voltage settings: 85 /115 % of nominal voltage (10.2 VDC/27.6 VDC)

(2) Test setup:

See Clause 4.

(3) Frequency Tolerance Limits (FCC Rule, 80.213 (g)):

Pulse type	S1	S2	M1	M2	M3	L
f(U) (MHz)	9438.6	9450.1	9455.3	9457.1	9457.9	9458.2
f(L) (MHz)	9381.4	9369.9	9364.7	9362.9	9362.1	9361.8

See Clause 3.2 for details.

(4) Test Results:

Complied.

Power Supply Voltage setting (*): 10.2 VDC

Pulse type		S1	S2	M1	M2	M3	L	Result
Frequency at maximum emission (MHz)	- 30°C	9432.4	9431.3	9430.8	9430.6	9430.8	9430.6	Complied
	- 20°C	9430.2	9429.1	9428.6	9428.4	9428.6	9428.4	Complied
	- 10°C	9427.9	9426.9	9426.4	9426.1	9426.4	9426.2	Complied
	0°C	9425.7	9424.6	9424.1	9423.9	9424.1	9423.9	Complied
	+10°C	9423.4	9422.4	9421.9	9421.6	9421.9	9421.7	Complied
	+20°C	9421.2	9420.2	9419.7	9419.4	9419.7	9419.5	Complied
	+30°C	9420.0	9419.0	9418.3	9418.2	9418.4	9418.3	Complied
	+40°C	9418.7	9417.7	9417.0	9417.0	9417.1	9417.0	Complied
	+50°C	9417.5	9416.5	9415.6	9415.8	9415.8	9415.8	Complied

Power Supply Voltage setting (*): 27.6 VDC

Pulse type		S1	S2	M1	M2	M3	L	Result
Frequency at maximum emission	- 30°C	9432.4	9431.3	9430.8	9430.6	9430.8	9430.6	Complied
	- 20°C	9430.2	9429.1	9428.6	9428.4	9428.6	9428.4	Complied
	- 10°C	9427.9	9426.9	9426.4	9426.1	9426.4	9426.2	Complied

Pulse type		S1	S2	M1	M2	M3	L	Result
(MHz)	0°C	9425.7	9424.6	9424.1	9423.9	9424.1	9423.9	Complied
	+10°C	9423.4	9422.4	9421.9	9421.6	9421.9	9421.7	Complied
	+20°C	9421.2	9420.2	9419.7	9419.4	9419.7	9419.5	Complied
	+30°C	9420.0	9419.0	9418.3	9418.2	9418.4	9418.3	Complied
	+40°C	9418.7	9417.7	9417.0	9417.0	9417.1	9417.0	Complied
	+50°C	9417.5	9416.5	9415.6	9415.8	9415.8	9415.8	Complied

(*): Power input voltages to the external equipment (Processor unit) measured. DRS2D was powered through the voltage regulator built in the Processor unit, not directly from the external power supply.

3.5 Spurious Emissions

3.5.1 Spurious Emissions at Antenna Terminal (FCC Rule, 2.1051)

(1) Test Conditions:

For all TX (S1/S2/M1/M2/M3/L) Pulses, the transmitter output power was measured at the antenna port with Antenna replaced with the Non-reflective load.

(2) Test setup:

See Clause 4.

(3) Emission Limits (FCC Rule, 80.211 (f)):

Frequency removed from the assigned frequency	Emission attenuation (mean power, dB)
50 - 100 % (of the authorized bandwidth)	At least 25
100 - 250 % (of the authorized bandwidth)	At least 35
more than 250 % (*) (of the authorized bandwidth)	At least $43 + 10 \log_{10}$ (mean power in watts)

Note: (1) Authorized bandwidth = 100 MHz

(*) - for the relevant frequency bands, tests were performed according to FCC Rule, 2.1053. See Clause 3.5.2.

(4) Test Results:

Complied.

From the results of the pre-tests, the EUT emission level was found to be the maximum with S1 pulse. Consequently, the test was performed only with S1 pulse.

Spectrum Plots: See Clause 8.

Environmental conditions observed: On 16 June, 23°C to 23°C, 50% to 50%RH

Power supply voltage measured (*): 24.0 VDC to 24.0 VDC.

(*): Power input voltages to the external equipment (Processor unit) measured. DRS2D was powered through the voltage regulator built in the Processor unit, not directly from the external power supply.

3.5.2 Field Strength of Spurious Radiation (FCC Rule, 2.1053)**(1) Test Conditions:**

For all TX (S1/S2/M1/M2/M3/L) Pulses, the Radiated Emission test was performed.

(a) For the test frequency range of 9 kHz to 2000 MHz, the Antenna for Transceiver was replaced with the rotating non-reflective load. Spurious emissions for 9 kHz to 2000 MHz are not found at the antenna terminal due to its structure. (Waveguide tube). The EUT cabinet radiation was measured with the EUT rotated 360°.

(b) For 2 GHz to 40 GHz, the Antenna was set to the Transceiver with the rotating mode.

(2) Test Site: FLI Nishinomiya-Hama Laboratory, Semi-Anechoic Chamber
(FCC file number: 90607)

(3) Distance between the radar set and measuring antenna: 3 m

(4) Test setup:

For the test frequency range of 2 GHz to 40 GHz, the GRP (Ground reference plane, metal floor) between the EUT and the measuring (receiving) antenna was lined with the Radio Absorbers (2.4 m × 3.0 m × 0.5 m) to reduce the influences of the reflections of the RF waves from the floor.

Measuring (Receiving) Antenna height:

For the test frequency range of 9 kHz to 30 MHz, The antenna height was 1.5 m.

For the test frequency range of 30 MHz to 2000 MHz, The antenna height was varied between 1 m and 4 m.

For the test frequency range of 2 GHz to 40 GHz, The antenna height was set to 1.8 m that was same as those for the EUT.

EUT height:

For the test frequency range of 9 kHz to 2000 MHz; 0.8 m,

For the test frequency range of 2 GHz to 40 GHz, 1.8 m (To reduce the influences of the reflections from GRP)

See Clause 4 and 6.

(5) Field Strength Limits (FCC Rule, 80.211 (f)):

Frequency removed from the assigned frequency	Frequency (MHz)	Emission attenuation (mean power, dB)
50 - 100 % (*) (of the authorized bandwidth)	9,310 – 9,360 9,460 – 9,510	At least 25
100 - 250 % (*)	9,160 – 9,310 9,510 – 9,660	At least 35
more than 250 %	0.009 – 9,160 9,660 - 40,000	At least $43 + 10 \log_{10}$ (mean power in watts)

Note: (1) Assigned frequency (center frequency) = 9410 MHz

(2) Authorized bandwidth = 100 MHz

(*) - for the relevant frequency bands, tests were performed according to FCC Rule, 2.1051. See Clause 3.5.1.

(6) Test Results:

Complied.

From the results of the pre-tests, the spurious emission level was found to be the maximum with L pulse. Consequently, the test was performed only with L pulse.

$$\begin{aligned}
 [\text{Limit}] &= 43 + 10 \log_{10} (\text{mean power in watts}) \\
 &= 43 + 10 \log_{10} (1.6) \\
 &= 42 \text{ dB}
 \end{aligned}$$

where, [mean power in watts] = 1.6 W for L pulse. See 3.1.

For this time, Limit of 60 dB was applied for the test.

The electric field strength of the maximum power radiation was 174.9 dB μ V/m with L pulse. Consequently, the allowable emission limit was set to 114.9 dB μ V/m (= 174.9 dB μ V/m - 60 dB).

As a result, the minimum emission attenuation was found to be more than 60 dB.

Spectrum plots: See Clause 9.

Spurious Emission Frequency and Electric Field Strength that were prominent were listed in the following table.

Frequency (GHz)	Antenna Polarization	Pulse type	Electric Field Strength measured (dB μ V/m)	Limit (dB μ V/m)	Margin (dB)
18.86	Horizontal	L	100.8	114.9	14.1
18.86	Vertical	L	98.1	114.9	16.8

Note: For Transmitting mode, Receiver was operated at the same time. Consequently test results included Receiver spurious emissions.

Environmental conditions observed: On 20 June, 22°C to 22°C, 54% to 54 %RH

Power supply voltage measured (*): 24.0 VDC to 24.0 VDC.

(*): Power input voltages to the external equipment (Processor unit) measured. DRS2D was powered through the voltage regulator built in the Processor unit, not directly from the external power supply.

3.6 Suppression of Interference Aboard Ships (FCC Rule, 80.217)

Not performed.

According to the results of Clause 3.2.4.2 performed with Transmitting and Receiving modes at the same time, those emission limit was 114.9 dB μ V/m (556 mV/m) at the measuring distance of 3 m. This value was much greater than those for the Receiver spurious emission limits. Consequently, Receiver spurious emission test was not performed.

4 Test Setup for Measurement

(1) Test Setup for Clauses 3.1, 3.2, 3.3, 3.4, and 3.5.1.

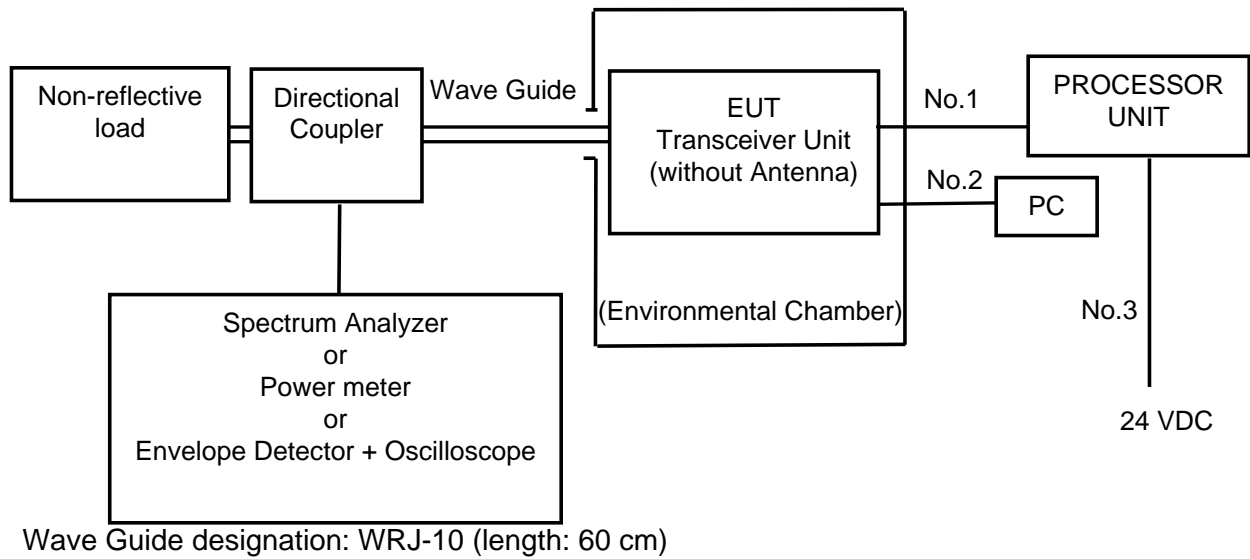

(2) Test Setup for Clause 3.5.2.

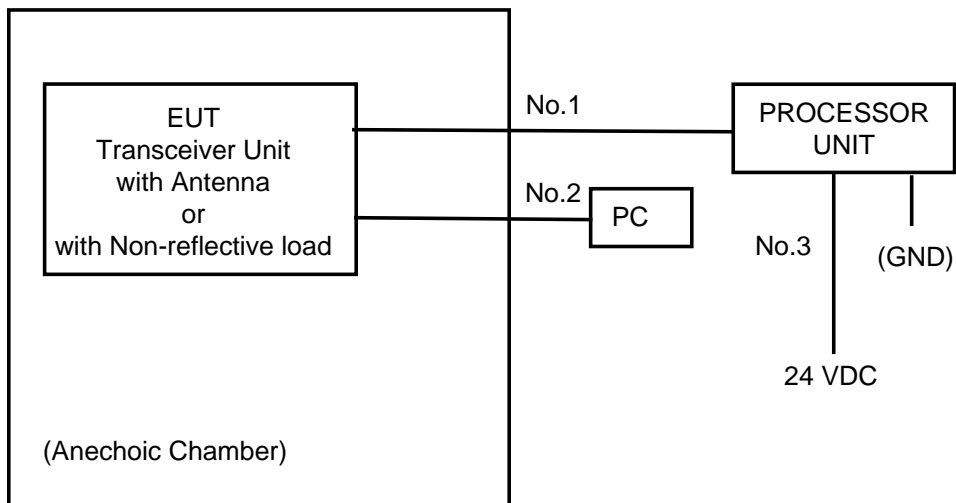

Cable designations;

No.	Name	Length (m)
1	MOD-ASW0001-300	30
2	CAT 5	30
3	DPYC-6	3

5 Measuring Equipment List

(1) For 3.1 Transmitter Output Power:

C/N	Instrument	Type	S/N	Manufacturer
8408089	Power meter	436A	2410A19137	HP
8408089	Power Sensor	8481A	2349A39603	HP
-----	Crystal Detector	432B	1822A24228	HP
8411057	Directional Coupler	5D364S	R05762	Shimada
8411057	Dummy Load	4D376	R05763	Shimada
8408087	Frequency Counter	TR5824A	41940036	Advantest
0404008	Attenuator	8494B	MY42141964	Agilent
0404008	Attenuator	8495B	MY42140929	Agilent
HT168	Oscilloscope	TDS680B	B030202	Tektronix
HT432	DC power supply	PAN55-20	AK003307	Kikusui
-----	Coaxial cable	SUCOFLEX 104 - 2m	-----	SUHNER

(2) For 3.2 Modulation Characteristics:

C/N	Instrument	Type	S/N	Manufacturer
8411057	Directional Coupler	5D364S	R05762	Shimada
8411057	Dummy Load	4D376	R05763	Shimada
0404008	Attenuator	8494B	MY42141964	Agilent
0404008	Attenuator	8495B	MY42140929	Agilent
-----	Crystal Detector	432B	1822A24228	HP
512043	Spectrum Analyzer	FSU46	200015	Rohde & Schwarz
8408087	Frequency Counter	TR5824A	41940036	Advantest
HT168	Oscilloscope	TDS680B	B030202	Tektronix
HT432	DC power supply	PAN55-20	AK003307	Kikusui

(3) For 3.3 Occupied Bandwidth and for 3.5.1 Spurious Emissions at Antenna Terminal:

C/N	Instrument	Type	S/N	Manufacturer
8411057	Directional Coupler	5D364S	R05762	Shimada
8411057	Dummy Load	4D376	R05763	Shimada
512043	Spectrum Analyzer	FSU46	200015	Rohde & Schwarz
0404008	Attenuator	8494B	MY42141964	Agilent
0404008	Attenuator	8495B	MY42140929	Agilent
HT432	DC power supply	PAN55-20	AK003307	Kikusui
-----	Coaxial cable	SUCOFLEX 104 - 2m	-----	SUHNER
-----	Coaxial cable	SUCOFLEX 104 - 5m	250497	SUHNER

(4) For 3.4 Frequency Stability:

C/N	Instrument	Type	S/N	Manufacturer
HT370	Climatic chamber (L)	TBE-3HW5GE2F	3013000995	Tabai Espec
HT128	Temperature recorder (L)	437006/R1182	4370TB580	Yokogawa
HT430	DC power supply	PAD55-20L	10091786	Kikusui
8411057	Directional Coupler	5D364S	R05762	Shimada
8411057	Dummy Load	4D376	R05763	Shimada
512043	Spectrum Analyzer	FSU46	200015	Rohde & Schwarz
0404008	Attenuator	8494B	MY42141964	Agilent
0404008	Attenuator	8495B	MY42140929	Agilent
-----	Coaxial cable	SUCOFLEX 104 - 2m	-----	SUHNER
-----	Coaxial cable	SUCOFLEX 104 - 5m	250497	SUHNER

(5) For 3.5.2 Field Strength of Spurious Radiation:

C/N	Instrument	Type	S/N	Manufacturer
HT463	Spectrum analyzer (9 kHz to 3 GHz)	R3132	110401654	Advantest
HT565	Loop antenna (0.15 - 30 MHz)	HFH2-Z2	100093	Rohde & Schwarz
HT459	Biconical antenna (30 MHz to 300 MHz)	VBA6106A	1296	Schaffner
HT331	Log periodic antenna (300 MHz to 1000 MHz)	UHALP9107	8411059	Schwarzbeck
HT467	Double-ridged waveguide horn antenna (1 GHz to 18 GHz)	3115	6520	EMCO
HT518	Pre-amplifier (30 MHz to 2 GHz)	87405A	3207A01643	Agilent
HT365	Semi-anechoic Chamber	3mSAC	D-002	Riken
512043	Spectrum Analyzer	FSU46	200015	Rohde & Schwarz
740060501	Horn antenna (18 GHz to 26.5 GHz)	42-442-6	E414109-01	A.H. Systems
0511041	Low-noise amplifier	JSWV4-18002600-30-8P	1058348	MITEQ
----	DC power supply for Low-noise amplifier	EX-375L2	405650060347	Takasago
740060502	Horn antenna (26.5 GHz to 40 GHz)	28-442-6	E414209-01	A.H. Systems
----	Notch Filter	CBR-X7-3A	R9865001	Shimada
-----	Coaxial cable	SUCOFLEX 106 - 2m	-----	SUHNER
-----	Coaxial cable	SUCOFLEX 104 - 2m	-----	SUHNER

C/N	Instrument	Type	S/N	Manufacturer
-----	Coaxial cable	SUCOFLEX 104 - 5m	250497	SUHNER
-----	Coaxial cable	SUCOFLEX 102 - 5m	265055	SUHNER

6 Photograph of Test Setup/Arrangement

(1) For Temperature (TX frequency stability) tests,



Note: During testing, Transceiver was covered not to be exposed to direct air blowing in the chamber.

(2) For Spurious Emission measurements,



for 9 kHz to 2000 MHz



for 2 GHz to 40 GHz

7 RF Envelope and Spectrum of the output pulse

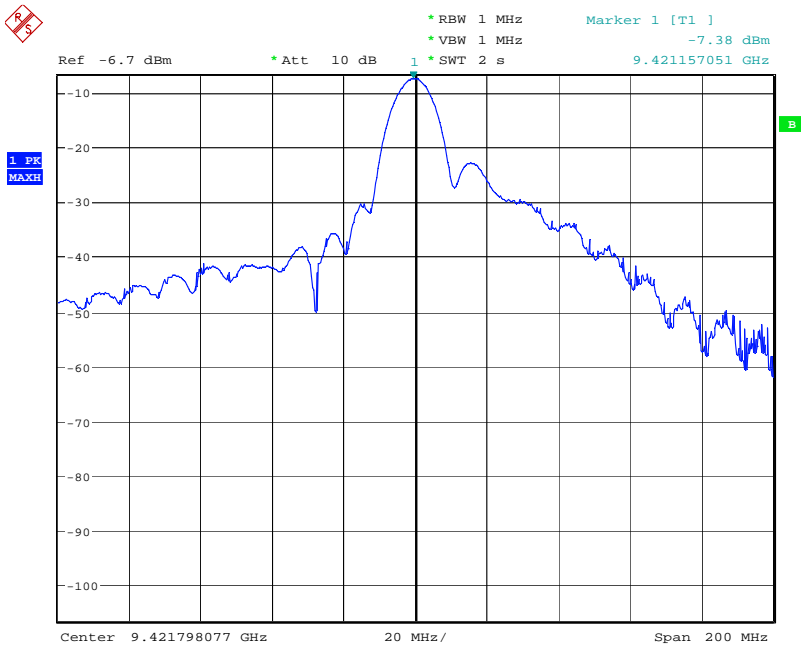
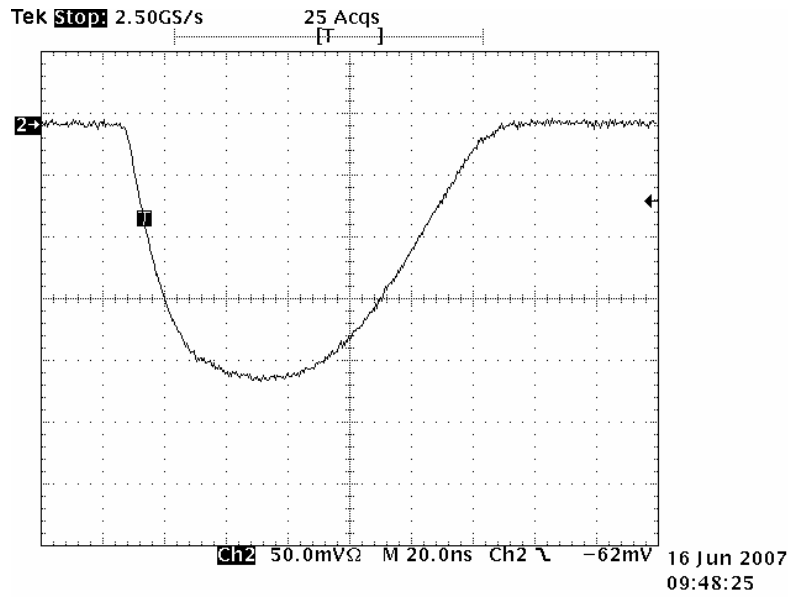
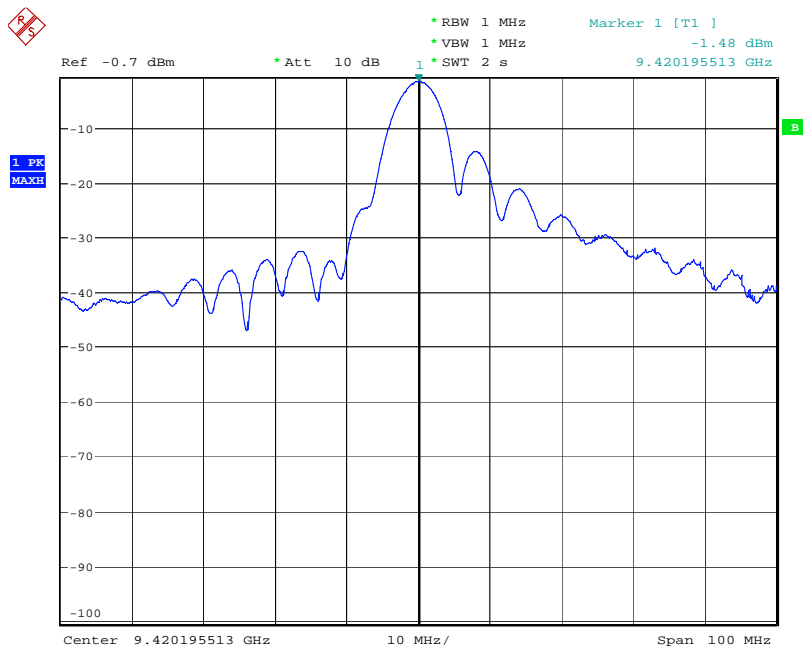
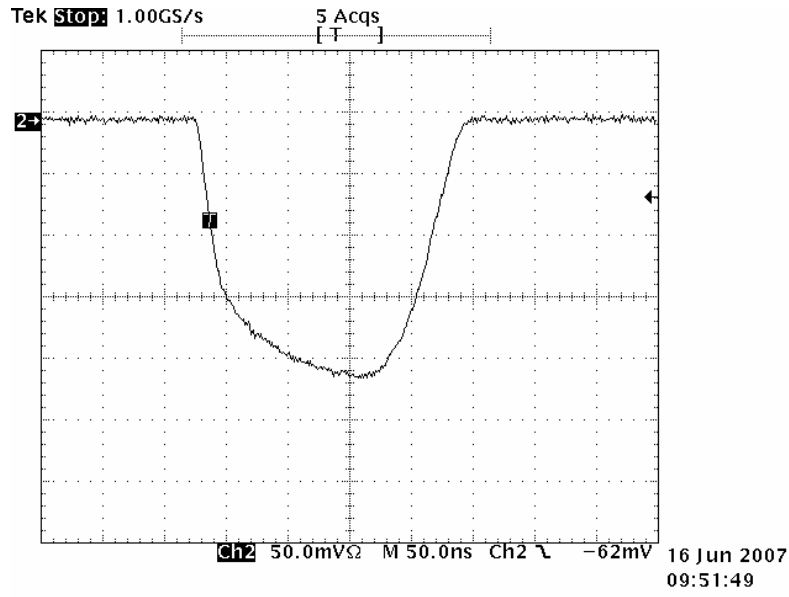
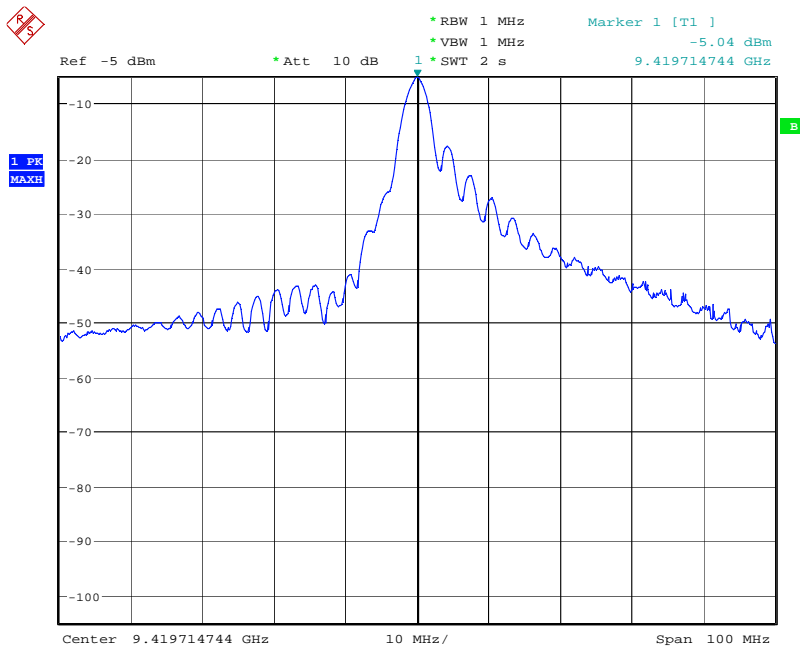
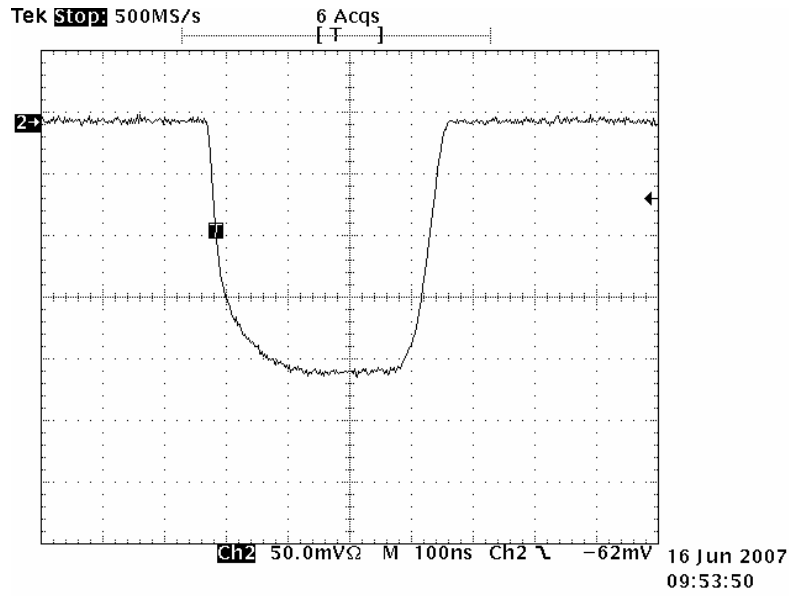

Fig. 7.1 S1 Pulse Envelope and Spectrum



Date: 16.JUN.2007 15:15:52

Fig. 7.2 S2 Pulse Envelope and Spectrum



Date: 16.JUN.2007 15:18:01

Fig. 7.3 M1 Pulse Envelope and Spectrum

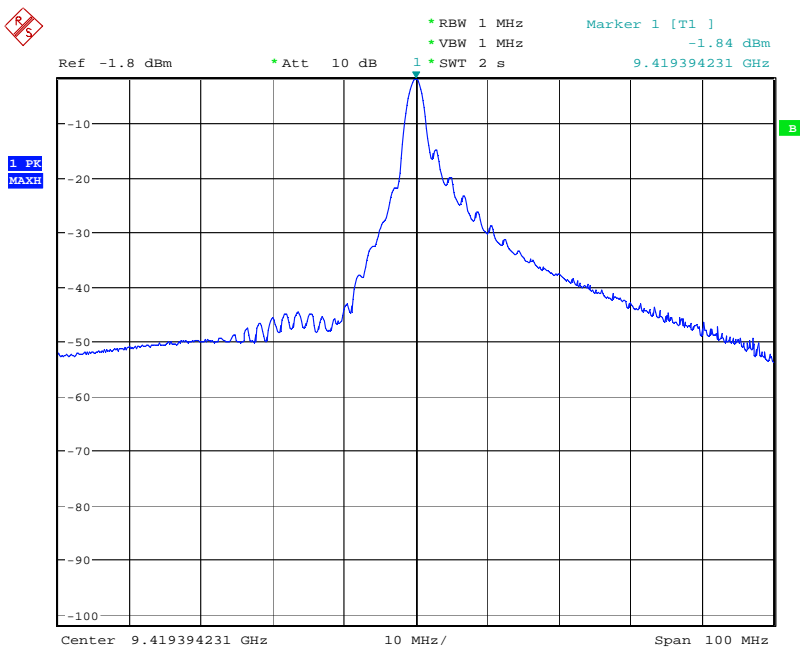
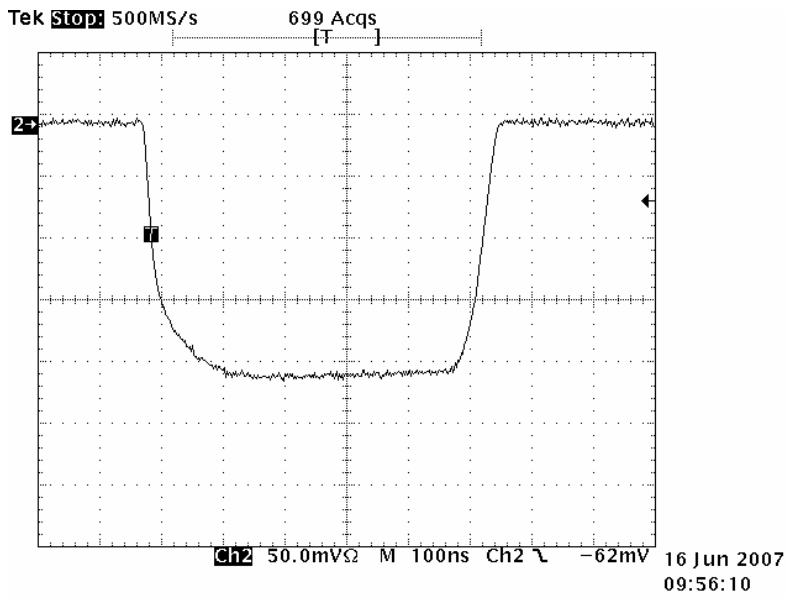

Date: 16.JUN.2007 15:19:18

Fig. 7.4 M2 Pulse Envelope and Spectrum

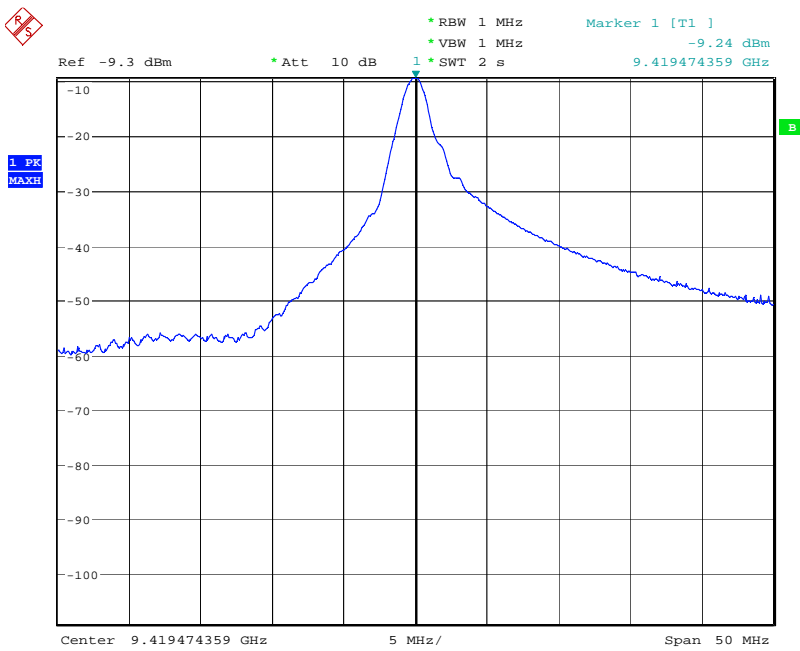
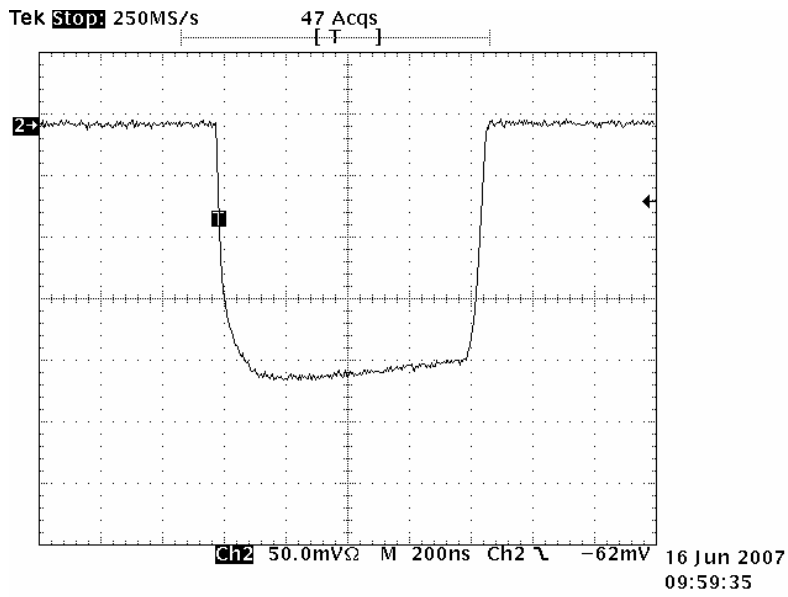

Date: 16.JUN.2007 15:23:24

Fig. 7.6 L Pulse Envelope and Spectrum

8 Spurious Emissions at Antenna Terminal

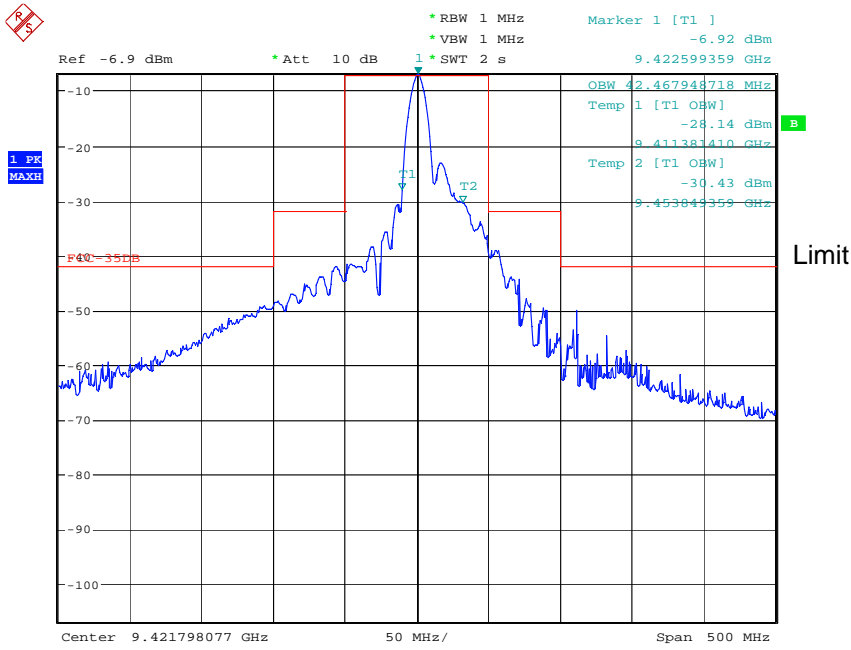

Date: 16.JUN.2007 14:41:00

for S1 pulse

9 Field Strength of Spurious Radiation

9.1 Maximum power radiation level (for L Pulse)

- for Horizontal

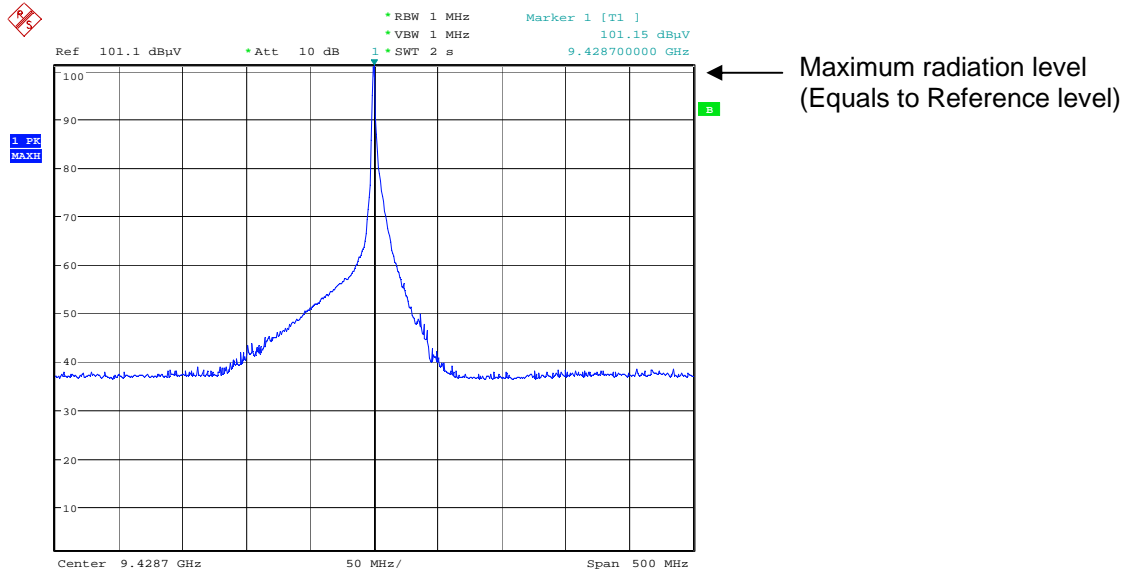

Date: 20.JUN.2007 10:42:26

- for Vertical

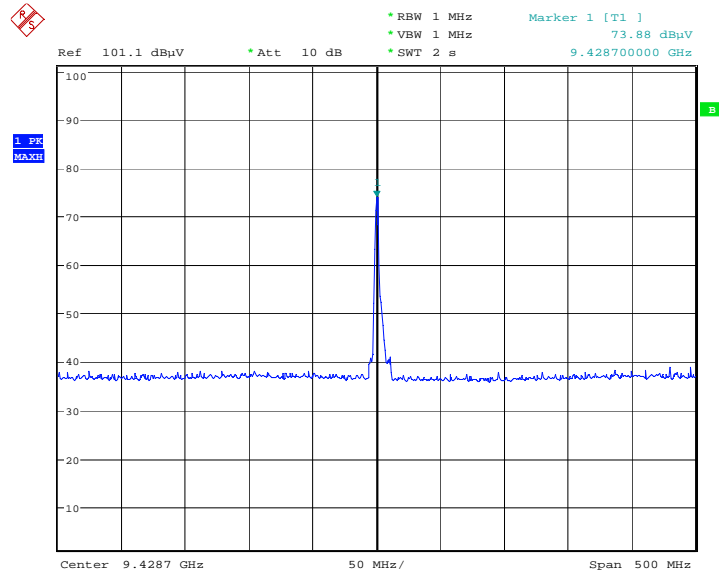

Date: 20.JUN.2007 10:44:40

For the maximum power radiation level, the voltage value measured by the spectrum analyzer was converted into the electric field strength with the measuring antenna factor, Cable loss and Amp. gain.

Maximum power radiation level = 174.9 dB μ V/m

Therefore, Emission Limit = 174.9 dB μ V/m - 60 dB = 114.9 dB μ V/m

9.2 Spurious emissions (L pulse)

(1) for 9 kHz to 30 MHz

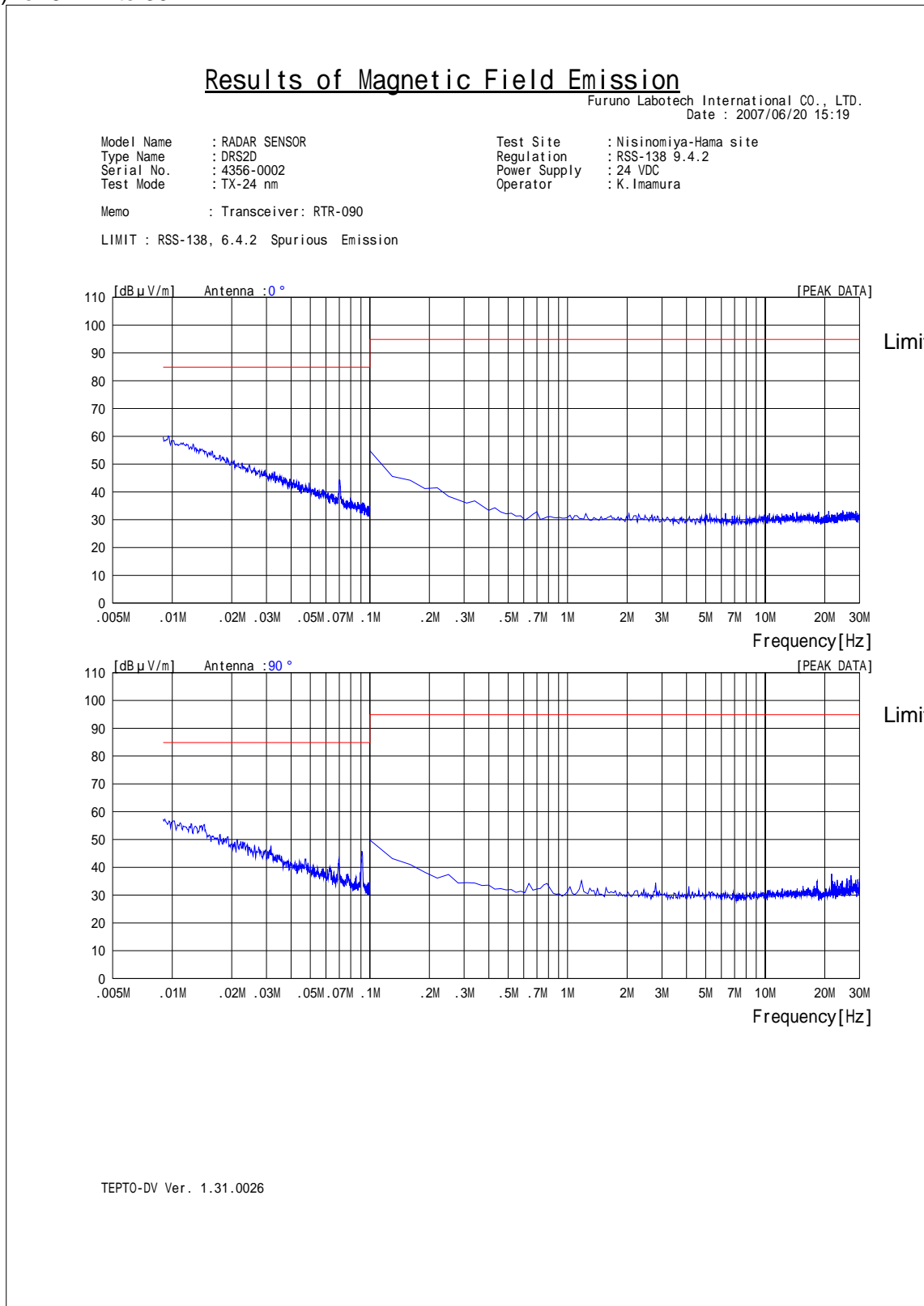

(*) The resolution bandwidth of the spectrum analyzer in the frequency range of 9 kHz to 100 kHz was set to 1 kHz, and 100 kHz to 30 MHz, to 10 kHz, instead of 1 MHz at the frequency range from 2 GHz to 40 GHz. The applicable limit was set at 30 dB lower than that computed in 9.1 for the former frequency range, and 20 dB lower for the latter frequency range.

(2) for 30 MHz to 2000 MHz

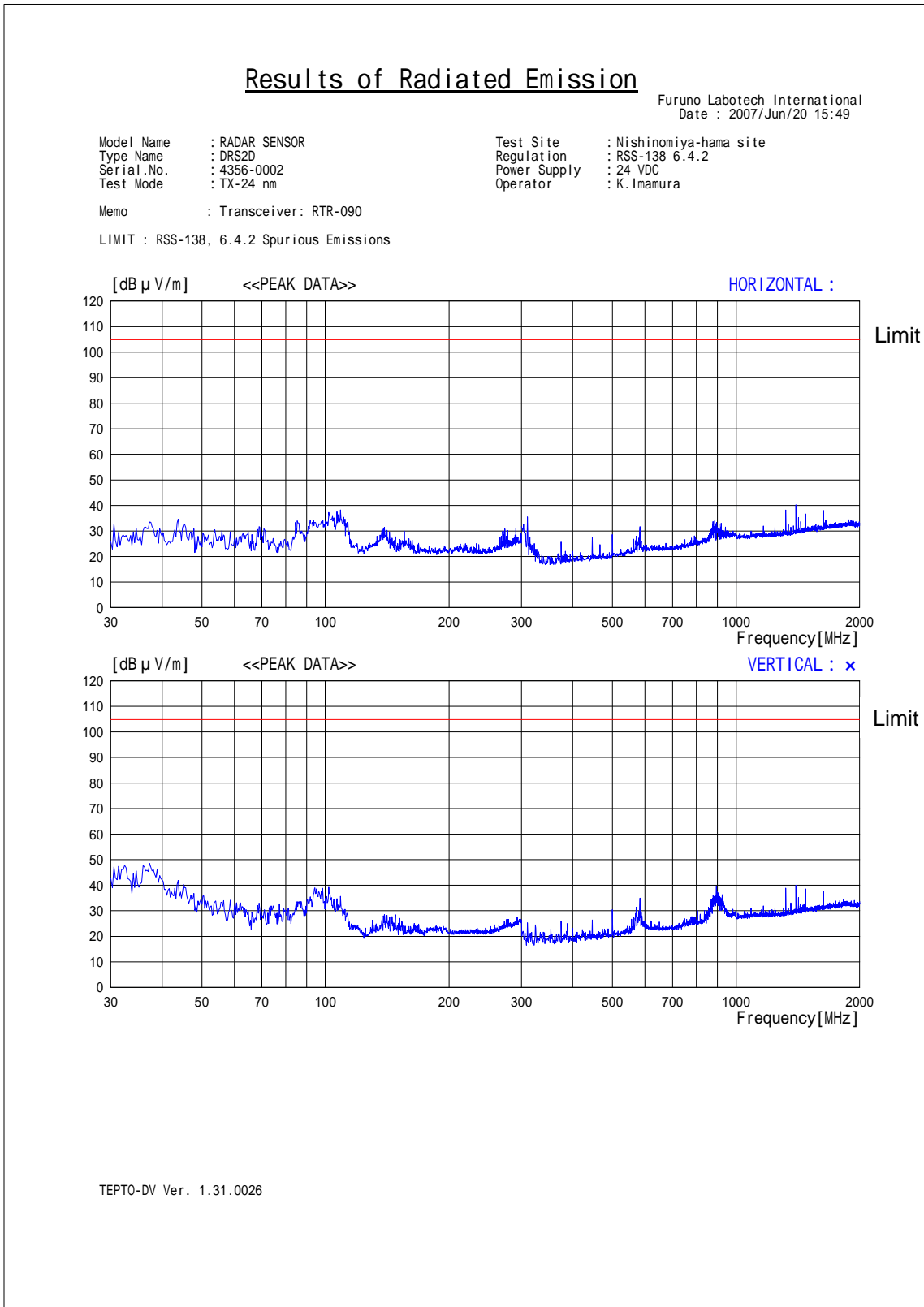

(*) The resolution bandwidth of the spectrum analyzer in the frequency range of 30 MHz to 2000 MHz was set to 100 kHz instead of 1 MHz at the frequency range from 2 GHz to 40 GHz. The applicable limit was set at 10 dB lower than that computed in 9.1.

(3) for 2 GHz to 18 GHz

- for Horizontal

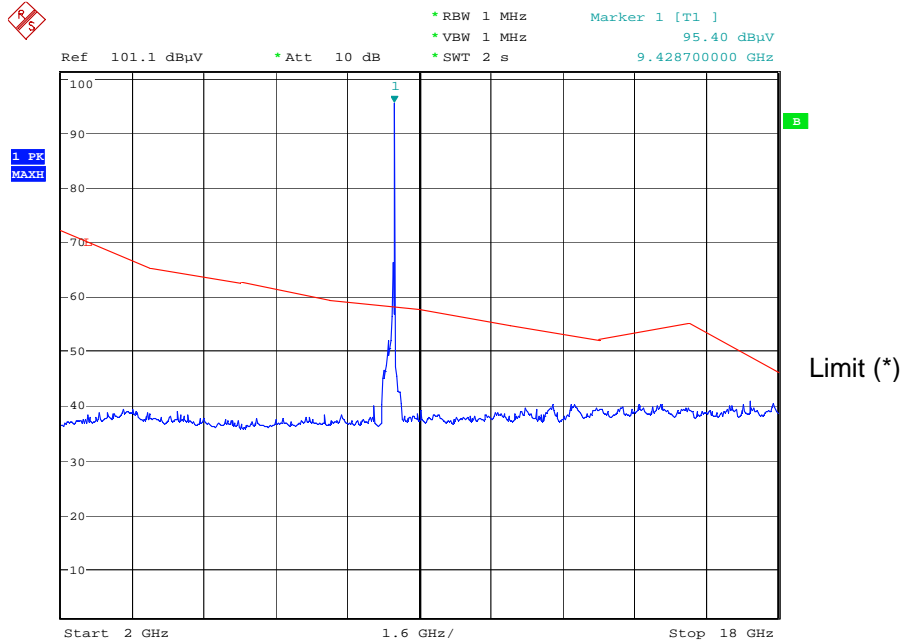

Date: 20.JUN.2007 10:54:18

- for Vertical

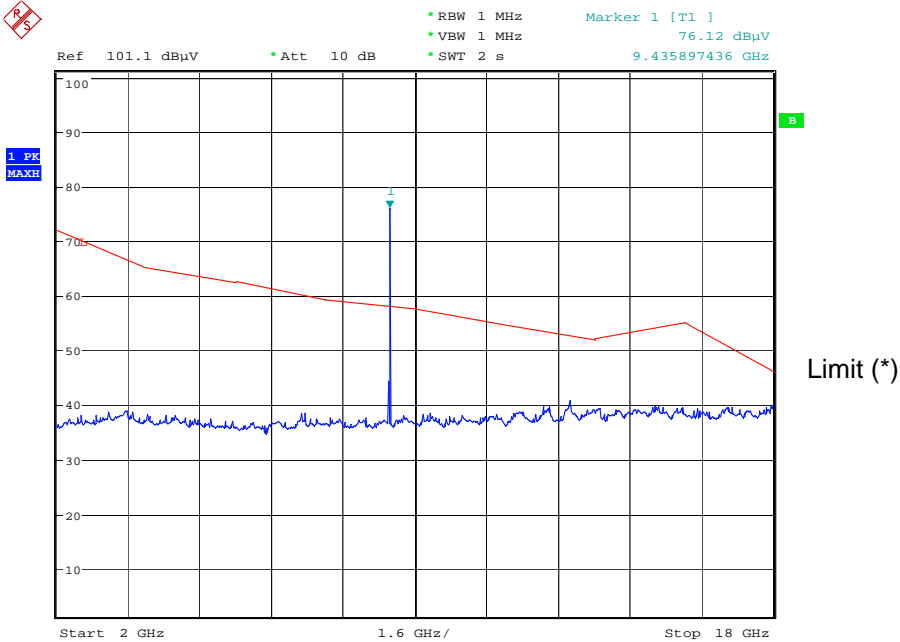

Date: 20.JUN.2007 10:56:32

The notch filter (Pass band: 9410 ± 150 MHz) was inserted between the measuring antenna and Spectrum Analyzer to prevent the excessive input to Spectrum Analyzer only for the test frequency range of 2 GHz to 18 GHz.

(*) The Limit is represented by the voltage value, which was derived from the electric field strength value with Antenna factor, Cable loss and Amp. gain.

(4) for 18 GHz to 26.5 GHz
- for Horizontal

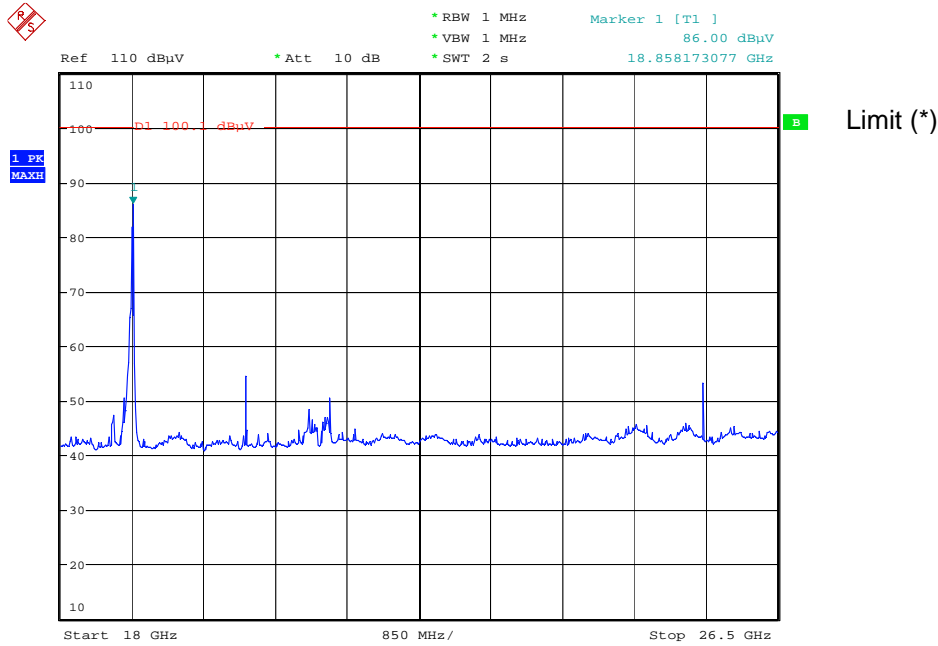

Date: 20.JUN.2007 11:08:07

- for Vertical

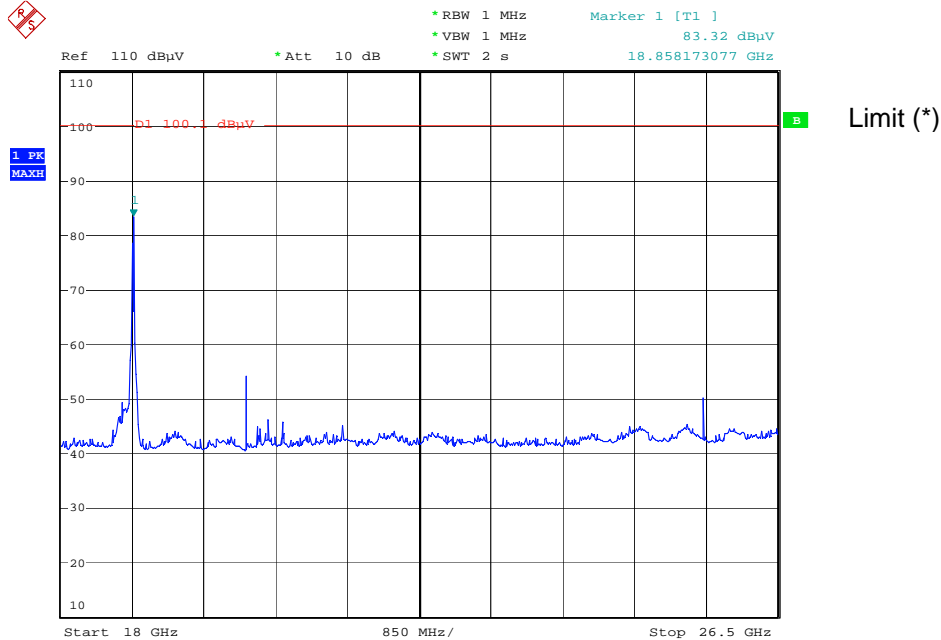

Date: 20.JUN.2007 11:09:29

(*) The Limit is represented by the voltage value, which was derived from the electric field strength value with Antenna factor, Cable loss and Amp. gain.

Minimum limit line for the frequency range of 18 GHz to 26.5 GHz is indicated in the above plots.

(5) for 26.5 GHz to 40 GHz
- for Horizontal

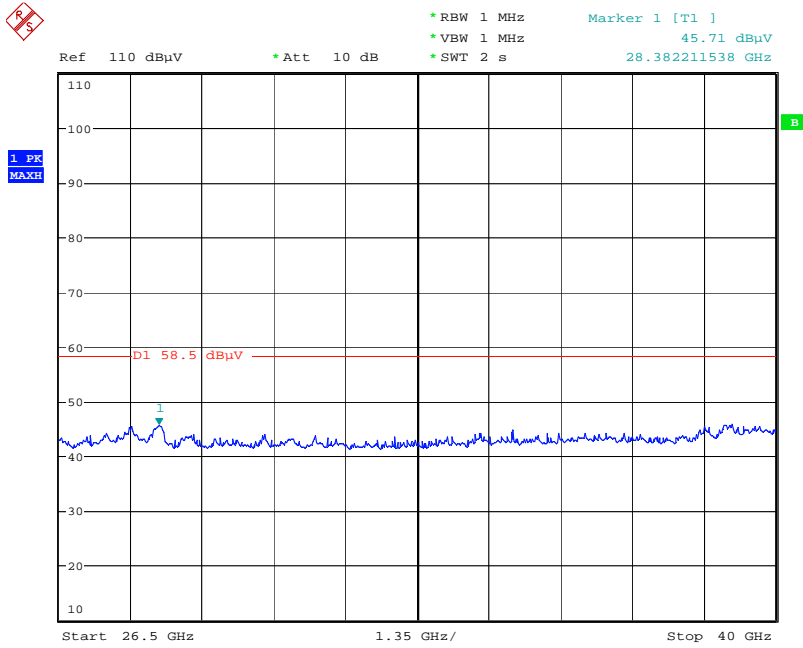

Limit (*)

Date: 20.JUN.2007 11:15:17

- for Vertical

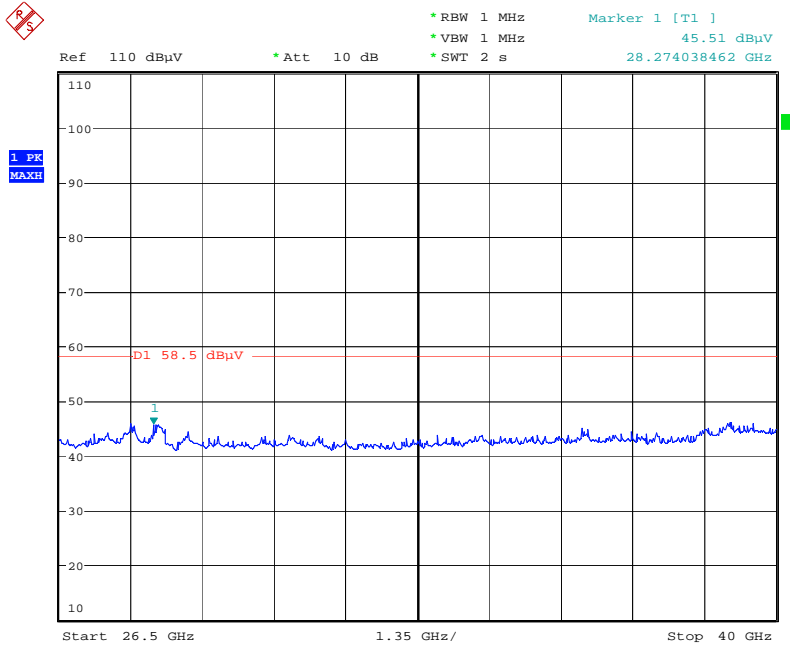

Limit (*)

Date: 20.JUN.2007 11:16:32

(*) Emission limit was converted from the electric field strength into the voltage values with Antenna factor, Cable loss and Amp. gain added to the calculation.

Minimum limit line for the frequency range of 26.5 GHz to 40 GHz is indicated in the above plots.