

# **TECHNICAL INFORMATION**

## **TEST REPORT ON THE PERFORMANCE OF MARINE RADAR**

---

**Brand Name : FURUNO**

---

**Transceiver Type : RTR-087**

Report no.: FLI 12-05-027

Date of issue: June 30, 2005

Furuno Labotech International Co., Ltd.

9-52 Ashihara-cho, Nishinomiya City, Hyogo 662-8580, Japan

Tel: +81-798-63-1094 Fax: +81-798-63-1098

All tests were performed in Furuno Labotech International Co., Ltd.  
All data herein contained is true and correct to our best knowledge.

Tested by: Katusmi Imamura/Assistant Chief Engineer, Technical Section

Reviewed by: Sadatomo Kuwahara/Chief Engineer, Technical Section

Approved by: Mitsuyoshi Komori/Manager, Technical Section

Date: June 30, 2005

Name: Mitsuyoshi Komori  
Manager, Technical Section

Signature:

A handwritten signature in blue ink, appearing to read 'M. Komori', with a large, sweeping flourish extending to the right.

\* \* \* \* \* **C O N T E N T S** \* \* \* \* \*

<b>1</b>	<b>General Information</b> .....	<b>3</b>
<b>2</b>	<b>Identification of Equipment (FCC Rule, 2.925)</b> .....	<b>10</b>
<b>3</b>	<b>Test data</b> .....	<b>11</b>
3.1	RF Power Output (FCC Rule, 2.1046).....	11
3.2	Modulation Characteristics (FCC Rule, 2.1047).....	14
3.3	Occupied Bandwidth (FCC Rule, 2.1049) .....	22
3.4	Spurious Emissions at Antenna Terminal (FCC Rule, 2.1051) .....	24
3.5	Field Strength of Spurious Radiation (FCC Rule, 2.1053) .....	28
3.6	Frequency Stability (FCC Rule, 2.1055).....	30
3.7	Suppression of Interference Aboard Ships (FCC Rule, 80.217) .....	33
<b>4</b>	<b>Photographs to Reveal Equipment Construction and Layout (FCC Rule, 2.1033)</b> .....	<b>37</b>
<b>5</b>	<b>Description of Circuitry and Devices (FCC Rules, 2.1033)</b> .....	<b>38</b>
<b>6</b>	<b>Operator's Manual Incl. Circuit Diagrams (FCC Rule, 2.1033)</b> .....	<b>39</b>
Attachment A	[ Test data for 3.4 Spurious Emissions at Antenna Terminal ]	
Attachment B	[ Test data for 3.5 Field Strength of Spurious Radiation ]	
Attachment C	[ Test data for 3.7 Suppression of Interference Aboard Ships ]	
Attachment D	[ List of Test/ Measuring Equipment ]	

## 1 General Information

### 1.1 General

- (a) Manufacturer: Furuno Electric Co., Ltd.  
Ashihara-cho 9-52, Nishinomiya-city, 662-8580 Japan
- (b) Model: FR-8252

	Type	Serial Number
Display unit	RDP-150	4332-0002
Antenna unit	RSB-0073	Antenna rotation rate: 24/36/48 rpm
Transceiver:	RTR-087	Contained in Antenna unit
Radiator (*):	XN12A	
	XN13A	
Power supply unit	PSU-008	R151-0002

Note: (\*) - 1 (one) selectable

- (c) Primary Function: Search, Navigation and anticollision
- (d) Discrimination

Range Discrimination: 20 meters on a range scale of 1.5 nm

Bearing Discrimination:

Radiator type:	XN12A	XN13A
Discrimination (°):	1.90	1.35

- (e) Minimum Range: 20 meters on a range scale of 0.25 nm
- (f) Frequency Range: Fixed frequency, X-band  
Type of Emission: P0N
- (g) Power Supply: 12 - 24 VDC

### 1.2 Antenna Unit

#### 1.2.1 Transceiver

Type: **RTR-087**

#### (1) Transmitter

- (a) Assignable Frequency for Shipborne Radar:  
Between 9300 and 9500 MHz (FCC Rule, 80.375 (d)-(1))
- (b) Type of RF Generator  
Magnetron Type: M1458 (F)  
Peak Output Power: 25 kW nominal

- (c) Magnetron Ratings  
Center frequency of Magnetron: 9410 MHz  
Tolerances

M1458 (F)

Manufacturing: ± 30 MHz

Pulling: 26 MHz

Tolerance for 20°C temperature variation: -5 MHz

- (d) Guard Band:  
Guard Band is specified to be equal to 1.5/T MHz, where "T" is the pulselength in microseconds. See para (e). (FCC Rule, 80.209(b))

- (e) Pulse Characteristics:

Range Scale (nm)	(Short )	(Middle)	(Long 1)	(Long 2)	(Long 3)
	<u>0.125</u>				
	0.25				
	0.5				
	0.75				
	1.0	<u>1.5</u>			
	1.5	2			
		3			
			<u>3</u>		
			4		
			6		
			8		
			12		
			16		
			24		
			36		
				<u>48</u>	
				64	
					72
					<u>96</u>
Pulselength ( μ s)	0.08	0.30	0.80	0.80	0.80
P.R.R.(Hz)	2100	1200	600	550	500
Duty cycle	1.68X10 <sup>-4</sup>	3.60X10 <sup>-4</sup>	4.80X10 <sup>-4</sup>	4.40X10 <sup>-4</sup>	4.00X10 <sup>-4</sup>
Guard Band (MHz)	18.75	5.00	1.88	1.88	1.88

Note 1: Tests were carried out for the underlined Range Scales.

**(2) Modulator**

- (a) FET Type: 2SK1464  
Trigger Voltage: Approx. +20 VDC positive

**(3) Receiver**

- (a) Passband (MHz)  
RF Stage: 60 MHz

IF Stage:

Pulselength	Short	Middle	Long 1	Long 2	Long 3
(MHz)	40	2.5	2.5	2.5	2.5

- (b) Gain (overall) (dB): Sufficient to cause limiting, approximately 100  
 (c) Overall Noise Figure (dB): 5.0 (typical)  
 (d) Video Output Voltage (V): 4 V negative  
 (e) Features Provided:  
     Sensitivity Time Controls (Anti-clutter Sea),  
     Fast Time Constant (Anti-clutter Rain)  
 (f) If receiver is tunable, describe method of adjusting frequency:  
     Adjustment of tuning voltage of receiver local oscillator  
     (Automatic and manual)

**1.2.2 Antenna**

- (a) Antenna Rotation ON-OFF Switch:  
Not Provided.  
 (b) Reflector: Slotted array antenna

Radiator type:	XN12A	XN13A
Length (cm):	120	180
Length (ft):	3.9	5.9

- (c) Type of Beam: Vertical fan  
 (d) Beam Width (between half-Radiator power points)

Radiator type:	XN12A	XN13A
Horizontal	1.90°	1.35°
Vertical	22°	22°

- (e) Polarization: Horizontal  
 (f) Antenna Gain:

Radiator type:	XN12A	XN13A
	28 dB	29.5 dB

(g) Attenuation of Major Side Lobes with respect to main beam:

Radiator type:	XN12A	XN13A
Within $\pm 10^\circ$	-24 dB	-28 dB
Outside $\pm 10^\circ$	-30 dB	-35 dB

(h) Scanning (rotating or oscillating):

Rotating over 360° continuously clockwise

(i) Antenna Rotation Rate:

Radiator type:	XN12A	XN13A
RSB-0073	24/36/48 rpm	24/36/48 rpm

(j) Number of Degrees Scanned: 360°

(k) Sector Scan: Not provided.

(l) Type of Transmission System: Contained in scanner unit

(m) Rated Loss of Transmission System per hundred feet:

None. Transmission path is only in the antenna scanner unit.

**1.3 Display Unit**

- (a) Type: 12.1 (in.) Color LCD,  
600 X 800 pixels
- (b) Size of Indicator: 12.1 in. diagonal  
effective dia. 182 mm
- (c) Sweep Linearity: 1 % on all ranges
- (d) Range Scales:

Range (nm)	Number of Range Rings	Range Ring Interval (nm)
0.125	5	0.025
0.25	5	0.05
0.5	5	0.1
0.75	3	0.25
1.0	4	0.25
1.5	6	0.25
2	4	0.5
3	6	0.5
4	4	1
6	6	1
8	4	2
12	6	2
16	4	4
24	6	4
36	6	6
48	6	8
64	4	16
72	6	12
96	6	16

- (e) Range Ring Accuracy: Better than 1 % of maximum scale in use  
or 8 m, whichever is the greater
- (f) Overall Bearing Accuracy from Scanner to Display:  
Better than 1°
- (g) Target Plot Facility: Simulated afterglow in low shade
- (h) Heading Indicator: Provided, automatic alignment. Heading Line and Heading  
Marker
- (i) True Bearing Indicator: Provided



## 1.4 Functional Controls

Range selector	Power Switch	A/C Rain control
A/C SEA (STC)	Gain control	Panel dimmer <sup>2)</sup>
Heading line off	Echo stretch <sup>2)</sup>	MENU
Guard zone set/Audio alarm off	Range ring on/off <sup>2)</sup>	Interference rejector <sup>2)</sup>
ST-BY/TX	Trackball (VRM/EBL/GUARD)	VRM on/off
SHIFT (Offcenter)	Range set <sup>2)</sup>	Zoom
EBL on/off	Echo Trail	Contrast <sup>2)</sup>
Display brilliance <sup>2)</sup>	Mode <sup>3)</sup>	TLL <sup>1), 3)</sup>
Date box <sup>1), 2)</sup>		

Note: <sup>1)</sup> Valid when interfaced with navaid

<sup>2)</sup> Selected on menu

<sup>3)</sup> Valid when interfaced with gyrocompass

## 1.5 Operational Features

(a) Is positive means provided to indicate whether or not the overall operation of the equipment is such that it may be relied upon to provide effective operation in accordance with its primary function:

Yes (Magnetron/Xtal checker)

(b) Is the equipment for continuous operation: Yes

(c) Is provision made for operation with shore based radar beacons (RACONS):

Yes (RACONS and SART)

## 1.6 Line Power Supply Requirements

(a) Input Voltage: 24 VDC

(b) Power Drain: 120 W

## 1.7 Construction Features

(a) Does equipment embody replacement units with chassis type assembly: Yes

(b) Are fuse alarms provided: Fuses are provided.

(c) State units that are weatherproof: Antenna Unit (IEC 60529 – IP26)

(d) If all units are not housed in a single container, indicate number and give description of individual units:

1 X Display Unit	Type:	RDP-150 (with 12.1-inch Color LCD)
1 X Antenna Unit	Type:	RSB-0073 (24/36/48 rpm)
Transceiver	Type:	RTR-087 (contained in the Antenna unit)
1 X Power Supply Unit	Type:	PSU-008

## (e) Approximate Weight of Complete Installation:

Display Unit:	6.7 kg
Antenna Unit:	25 kg for RSB-0073 with Radiator XN12A 27 kg for RSB-0073 with Radiator XN13A
Power Supply Unit	2.7 kg

## (f) Approximate space required for installation excluding scanner

Display Unit:	331 mm (W) X 345 mm (H) X 172 mm (D)
Antenna Unit:	340 mm (W) X 445 mm (H) X 438 mm (D) without Radiator
Power Supply Unit	333 mm (W) X 77 mm (H) X 260 mm (D)

## 2 Identification of Equipment (FCC Rule, 2.925)

(See separate covers.)

### 3 Test data

#### 3.1 RF Power Output (FCC Rule, 2.1046)

##### 3.1.1 Microwave characteristics

The peak voltage was determined using the divider having a ratio of 1000 to 1 and the oscilloscope. Current pulse was viewed across the wideband current transformer with output voltage per ampere 1.00.

##### (1) Nominal values

Pulselength	Short	Middle	Long 1	Long 2	Long 3
Range scale (nm)	0.125	1.5	3	48	96
Pulselength (μs)	0.08	0.30	0.80	0.80	0.80
PRR (Hz)	2100	1200	600	550	500
Duty cycle	$1.68 \times 10^{-4}$	$3.60 \times 10^{-4}$	$4.80 \times 10^{-4}$	$4.40 \times 10^{-4}$	$4.00 \times 10^{-4}$
Guard band (MHz)	18.75	5.00	1.88	1.88	1.88

##### (2) Measured values

##### Magnetron input pulse voltage

Magnetron input pulse voltage was measured at its cathode using the oscilloscope and divider with ratio 1000 to 1.

Pulselength	Short	Middle	Long 1	Long 2	Long 3
Directional coupler attenuation (dB)	40.51	40.51	40.51	40.51	40.51
Magnetron input voltage (kV)	8.12	8.30	8.30	8.30	8.30
Pulselength (μs) (50 % amplitude)	0.278	0.442	0.932	0.932	0.932
Rise time (μs) (10 - 90 % amplitude)	0.074	0.076	0.076	0.076	0.076
Decay time (μs) (90 - 10 % amplitude)	0.512	0.424	0.400	0.400	0.400

### Magnetron input pulse current

Magnetron input pulse current was observed across the wideband current transformer with output voltage per ampere 1.00.

Pulselength	Short	Middle	Long 1	Long 2	Long 3
Magnetron input current (A)	5.60	6.80	7.20	7.20	7.20
Pulselength (µs) (50 % amplitude)	0.078	0.250	0.740	0.740	0.740
Rise time (µs) (10 - 90 % amplitude)	0.082	0.083	0.182	0.182	0.182
Decay time (µs) (90 - 10 % amplitude)	0.083	0.090	0.126	0.126	0.126

### RF envelope of the magnetron output pulse

The RF envelope of the magnetron output pulse was measured using a diode and the oscilloscope with the following results:

Pulselength	Short	Middle	Long 1	Long 2	Long 3
Pulselength (µs) (-3 dB points)	0.080	0.249	0.744	0.744	0.744
Rise time (µs) (10 - 90 % amplitude)	0.014	0.044	0.061	0.061	0.061
Decay time (µs) (90 - 10 % amplitude)	0.072	0.088	0.108	0.108	0.108

### Estimated efficiency

The estimated efficiency of the RF generator (magnetron) was determined by the following measurements and calculation. Power output from magnetron was measured using the directional coupler, power meter and the oscilloscope.

Pulselength	Short	Middle	Long 1	Long 2	Long 3
Range scale (nm)	0.125	1.5	3	48	96
P.R.R (Hz)	2101.0	1200.1	600.0	550.0	500.0
Duty cycle	$1.69 \times 10^{-4}$	$2.99 \times 10^{-4}$	$4.46 \times 10^{-4}$	$4.09 \times 10^{-4}$	$3.72 \times 10^{-4}$
Magnetron input, av. (W)	7.68	16.87	26.68	24.45	22.23
Magnetron input, peak (kW)	45.47	56.44	59.76	59.76	59.76
Power meter reading (mW)	0.2950	0.5390	0.8580	0.7850	0.7140
Magnetron output, av. (W)	3.318	6.062	9.649	8.828	8.030
Spurious response limits (dB)	-48.21	-50.83	-52.84	-52.46	-52.05
Magnetron Output, peak (kW):	19.64	20.28	21.62	21.57	21.59

Pulselength	Short	Middle	Long 1	Long 2	Long 3
Magnetron efficiency (%)	43.19	35.94	36.17	36.10	36.12

Peak Power Input to RF Generator : 56.2 kW  
Estimated Efficiency of RF Generator : 37.5 %

**3.2 Modulation Characteristics (FCC Rule, 2.1047)**

**3.2.1 FET Trigger Pulse**

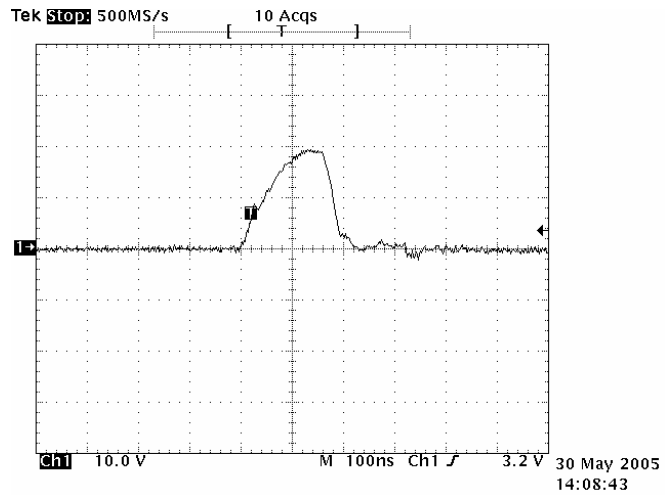


Fig. 3.2.1.1 Typical waveform of Trigger Pulse Scale: 10 V/div., 100 ns/div.

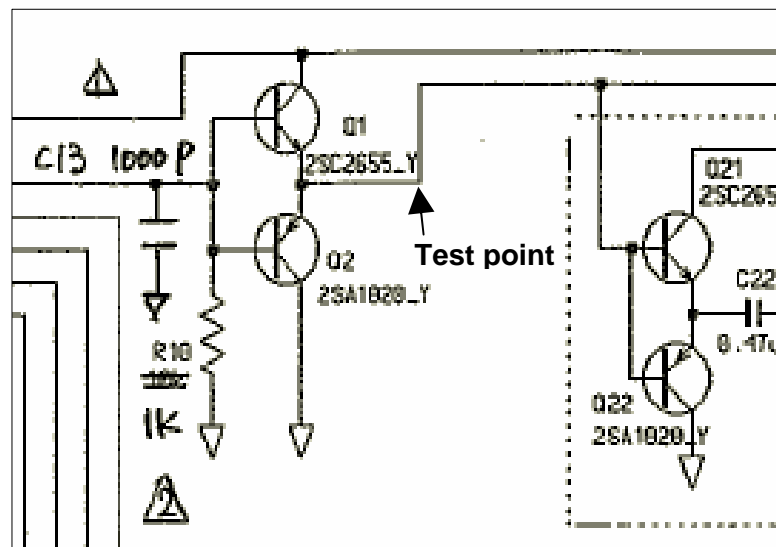


Fig. 3.2.1.2 Test Point for Trigger Pulse  
(in MD board (03P9239) of Radar Antenna Unit)

**3.2.2 Trigger Pulse at Magnetron Cathode**

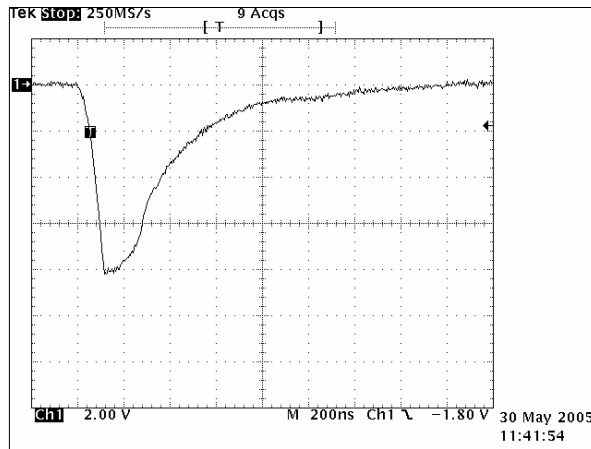


Fig. 3.2.2.1 Short Pulse (0.125 nm Range) Scale: 2 kV/div. 200 ns/div.

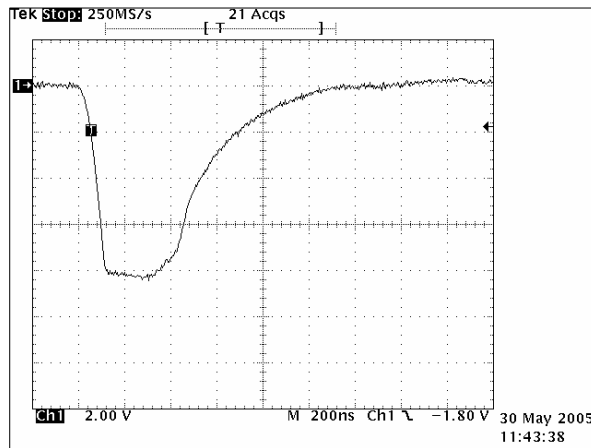


Fig. 3.2.2.2 Middle Pulse (1.5 nm Range) Scale: 2 kV/div. 200 ns/div.

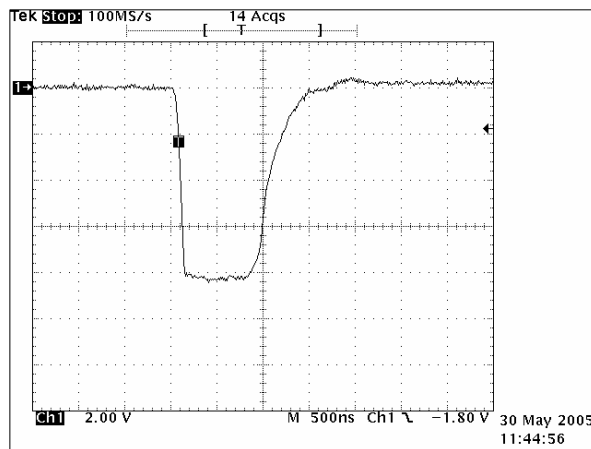


Fig. 3.2.2.3 Long 1 Pulse (3 nm Range) Scale: 2 kV/div. 500 ns/div.



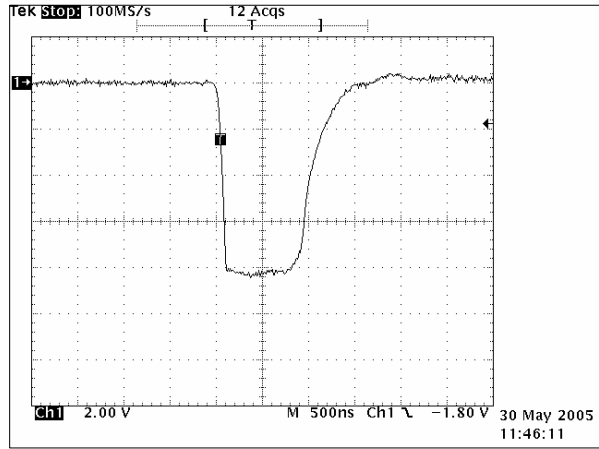


Fig. 3.2.2.4 Long 2 Pulse (48 nm Range) Scale: 2 kV/div. 500 ns/div.

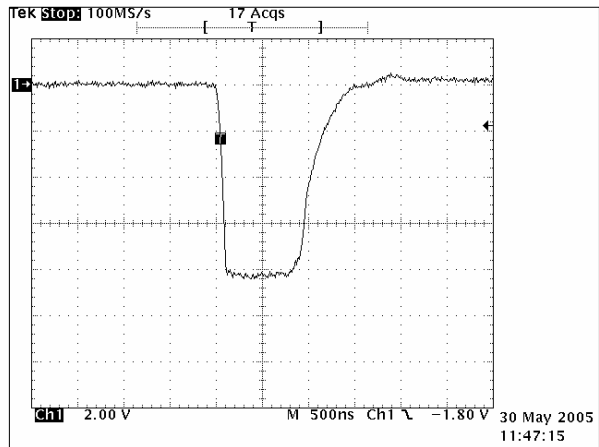


Fig. 3.2.2.5 Long 3 Pulse (96 nm Range) Scale: 2 kV/div. 500 ns/div.

**3.2.3 Magnetron Output (detected):**

## 3.2.3.1 Setup for Measurement:

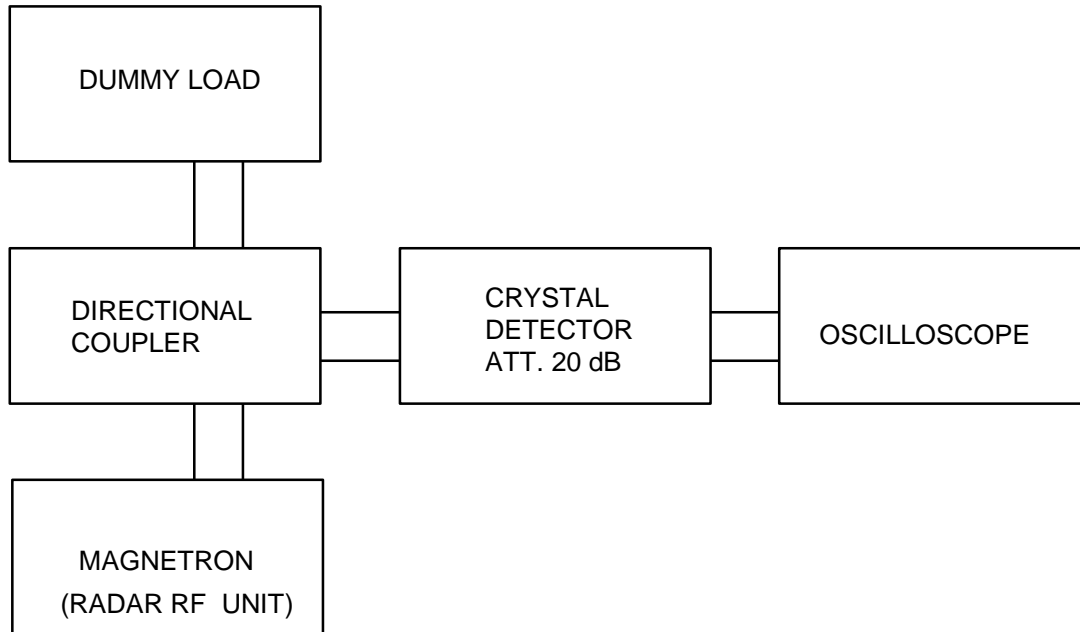


Fig. 3.2.3.1

## 3.2.3.2 Measuring Equipment List:

See Attachment D [ List of Test/Measuring Equipment ].

3.2.3.3 Measured Data:

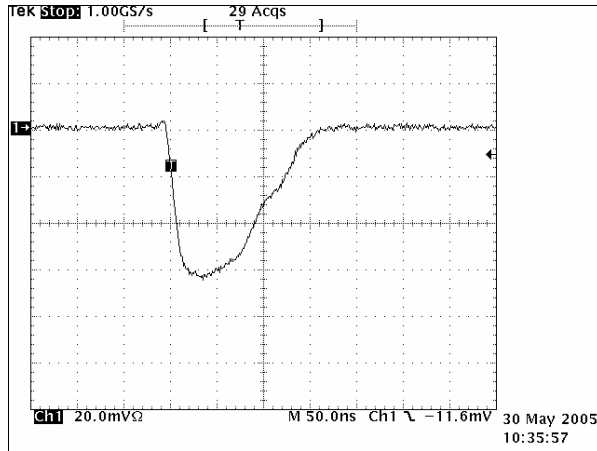


Fig. 3.2.3.2 Short Pulse (0.125 nm Range) Scale: 20 mV/div. 50 ns/div.

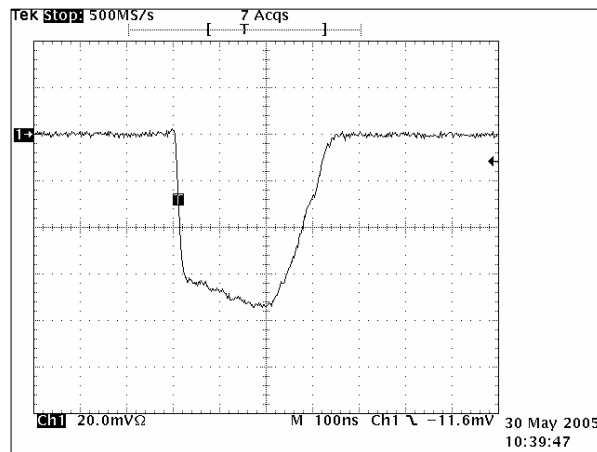


Fig. 3.2.3.3 Middle Pulse (1.5 nm Range) Scale: 20 mV/div. 100 ns/div.

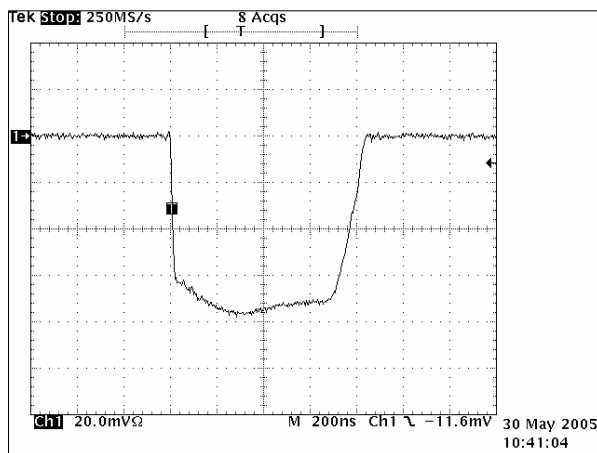


Fig. 3.2.3.4 Long 1 Pulse (3 nm Range) Scale: 20 mV/div. 200 ns/div.

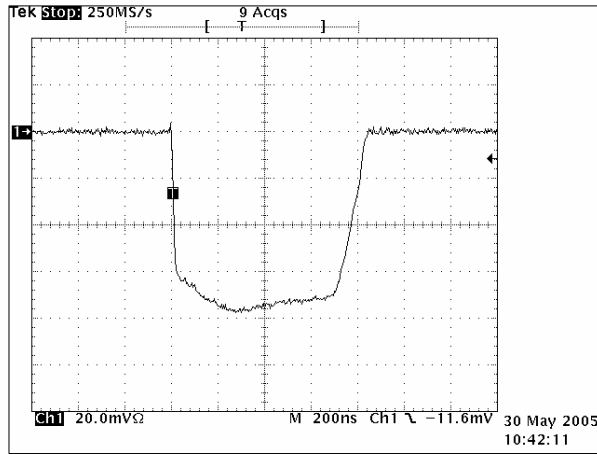


Fig. 3.2.3.5 Long 2 Pulse (48 nm Range) Scale: 20 mV/div. 200 ns/div.

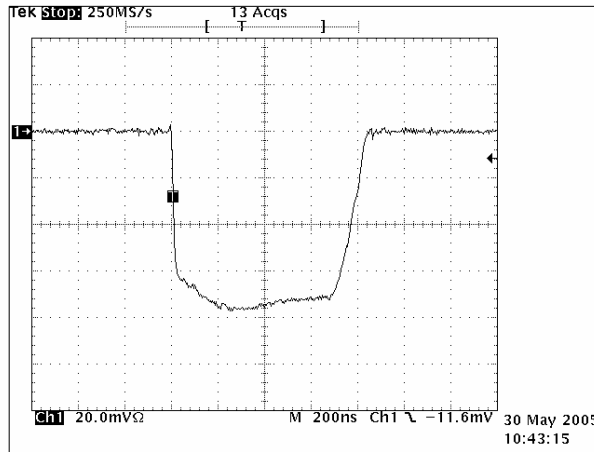


Fig. 3.2.3.6 Long 3 Pulse (96 nm Range) Scale: 20 mV/div. 200 ns/div.

**3.2.4 Radar Pulse Spectrum:**

Measured by the spectrum analyzer.

(Test Equipment Setup and Measuring Equipment List are same as Clause 3.4.1 and 3.4.2.)

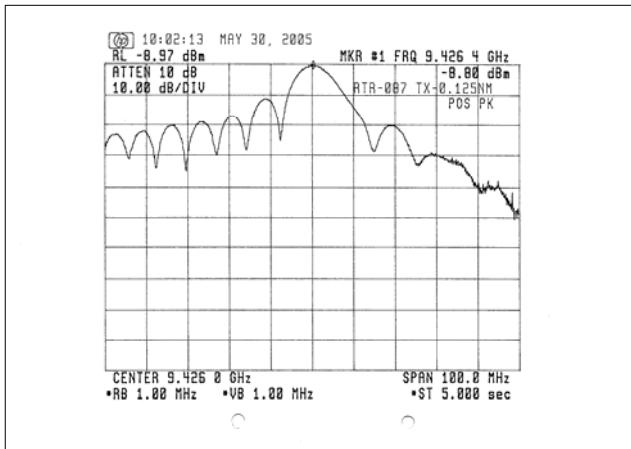


Fig. 3.2.4.1 For Short Pulse (0.125 nm Range)

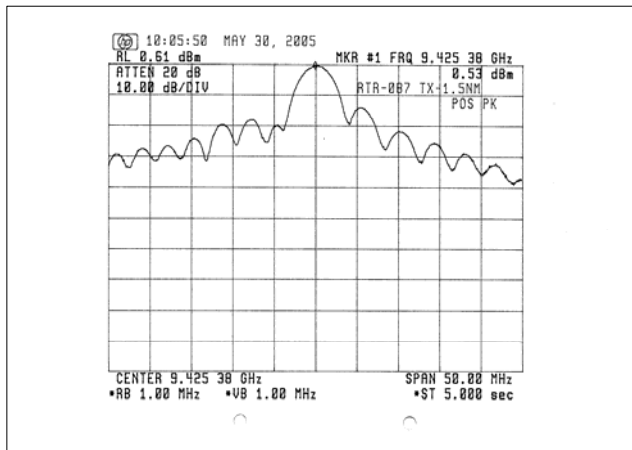


Fig. 3.2.4.2 For Middle Pulse (1.5 nm Range)

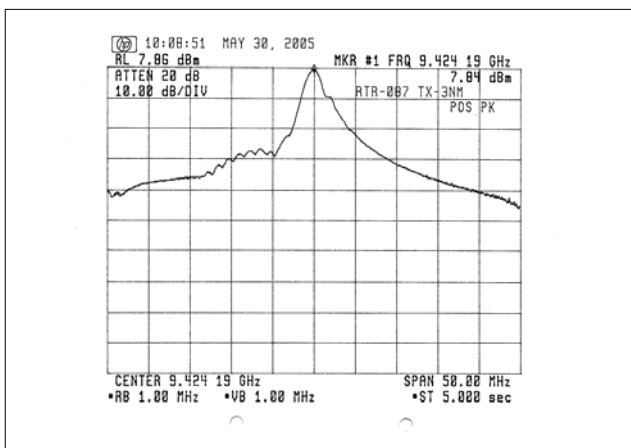


Fig. 3.2.4.3 For Long 1 Pulse (3 nm Range)

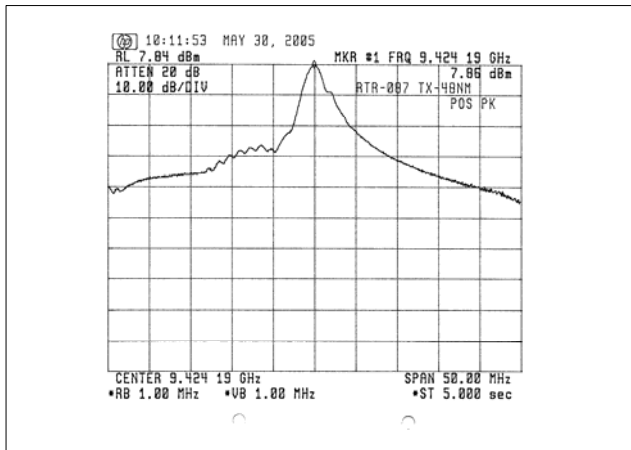


Fig. 3.2.4.4 For Long 2 Pulse (48 nm Range)

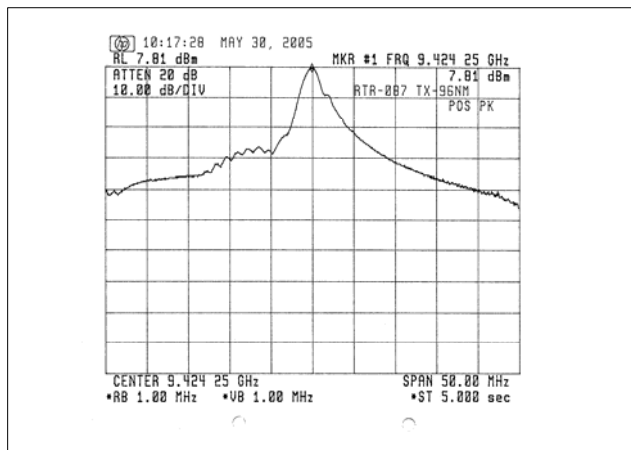


Fig. 3.2.4.5 For Long 3 Pulse (96 nm Range)

### 3.3 Occupied Bandwidth (FCC Rule, 2.1049)

#### 3.3.1 Measuring Method

FCC rule 47 CFR 2.1049 requires measurements of the occupied bandwidth which is defined in the same section as "the frequency bandwidth such that, below its lower and above its upper frequency limits, the mean powers radiated are each equal to 0.5 percent of the total mean power radiated by a given emission." To obtain the occupied bandwidth of the radar transmitter, a special program (program list shown below) was loaded to the Hewlett-Packard spectrum analyzer and run by entering the HP-provided POWER BANDWIDTH calculation command [PWRBW].

The result was automatically displayed on the screen on the spectrum analyzer as:

```

POWER_BW=----- MHz

10 ! HP_71000 DOWNLOAD PROGRAM
20 ASSIGN @Sa TO 718
30 CLEAR @Sa
40 CALL M_ain(@Sa)
50 LOCAL @Sa
60 END
70 !
80 SUB M_ain(@Sa)
90 M_ain: !
100 CALL Pwr_bw(@Sa)
110 CALL Limit_line(@Sa)
120 !
130 OUTPUT @Sa;"VARDEF K_ey,0;";
140 !
150 OUTPUT @Sa;"FUNCDEF D_LP,^";
160 OUTPUT @Sa;"MOV K_ey,0;";
170 !
180 Main_menu: !
190 OUTPUT @Sa;"REPEAT;";
200 OUTPUT @Sa;"READMENU K_ey;";
210 ! location: %Top----Bottom-%
220 OUTPUT @Sa;"I,%Limit line %,";
230 OUTPUT @Sa;" 2,%Power bw %,";
240 OUTPUT @Sa;"14,% Exit%,";
250 !
260 OUTPUT @Sa;"IF K_ey,EQ,1;THEN;LIMIT_LINE;";
270 OUTPUT @Sa;"ELSIF K_ey,EQ,2;THEN;PWR_BW;";
280 OUTPUT @Sa;"ELSIF K_ey,EQ,14;THEN;ABORT;";
290 OUTPUT @Sa;"ENDIF;";
300 OUTPUT @Sa;"UNTIL K_ey,EQ,14;";
310 OUTPUT @Sa;"IP;TS;";
320 OUTPUT @Sa;"ADORT;";
330 OUTPUT @Sa;"^"
340 !
350 Define_keydef: !
360 OUTPUT @Sa;"KEYDEF 7,D_LP, %DLP TEST%,";
370 !
380 OUTPUT @Sa;"FUNCDEF D,^";
390 OUTPUT @Sa;"KEYPST;";
400 OUTPUT @Sa;"^"
410 !
420 SUBEND

430 !
440 SUB Limit_line(@Sa)
450 Limit_line: !
460 OUTPUT @Sa;"CLRDSP;";
470 OUTPUT @Sa;"FUNCDEF LIMIT_LINE,^";
480 OUTPUT @Sa;"PU;PA 0,654;";
490 OUTPUT @Sa;"LINET 1;";
500 OUTPUT @Sa;"PD;PA 100,654;";
510 OUTPUT @Sa;"PU;PA 201,654;";
520 OUTPUT @Sa;"PD;PA 300,654;";
530 OUTPUT @Sa;"PU;PA 105,630;";
540 OUTPUT @Sa;"TEXT @-35dB@;";
550 OUTPUT @Sa;"PU;PA 205,720;";
560 OUTPUT @Sa;"TEXT @-25dB@;";
570 OUTPUT @Sa;"PU;PA 301,743;";
580 OUTPUT @Sa;"LINET 1;";
590 OUTPUT @Sa;"PD;PA 400,743;";
600 OUTPUT @Sa;"PU;PA 601,743;";
610 OUTPUT @Sa;"LINET I;";
620 OUTPUT @Sa;"PD;PA 700,743;";
630 OUTPUT @Sa;"PU;PA 701,654;";
640 OUTPUT @Sa;"LINET I;";
650 OUTPUT @Sa;"PD;PA 1000,654;HD;";
660 OUTPUT @Sa;"^"
670 SUBEND
680 SUB Pwr_bw(@Sa)
690 Pwr_bw: !
700 ! Calculating Power band width
710 OUTPUT @Sa;"VARDEF P_bw,0;";
720 OUTPUT @Sa;"FUNCDEF PWR_BW,^";
730 OUTPUT @Sa;"CLRW TRA;";
740 OUTPUT @Sa;"CLRDSP;";
750 OUTPUT @Sa;"SNGLS;";
760 OUTPUT @Sa;"MXMH TRA;TS;TS;TS;";
770 OUTPUT @Sa;"MOV P_bw,PWRBW TRA,99.0;";
780 OUTPUT @Sa;"DIV P_bw,P_bw,1000000;";
790 OUTPUT @Sa;"PU;PA 10,800;HD;";
800 OUTPUT @Sa;"TEXT @POWER_BW = @;";
810 OUTPUT @Sa;"DSPLY P_bw,8,3;";
820 OUTPUT @Sa;"TEXT @ MHz @;";
830 OUTPUT @Sa;"^"
840 SUBEND

```

Fig. 3.3.1 Program for Calculation of Occupied Bandwidth

**3.3.2 Test Equipment Setup:**

Same as Clause 3.4.1.

**3.3.3 Measuring Equipment List:**

Same as Clause 3.4.2.

**3.3.4 Test Result:**

The test result is shown below.

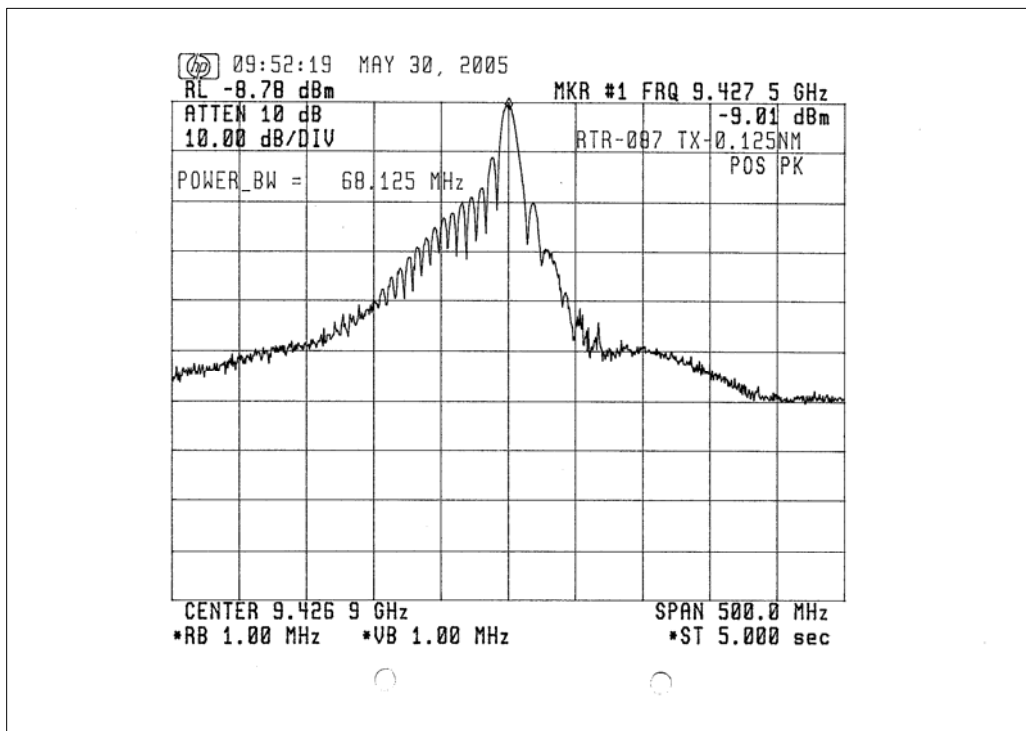


Fig. 3.3.2 Measurement of Occupied Bandwidth

**Occupied bandwidth = 68.125 MHz**



**3.4 Spurious Emissions at Antenna Terminal (FCC Rule, 2.1051)**

**3.4.1 Test Equipment Setup:**

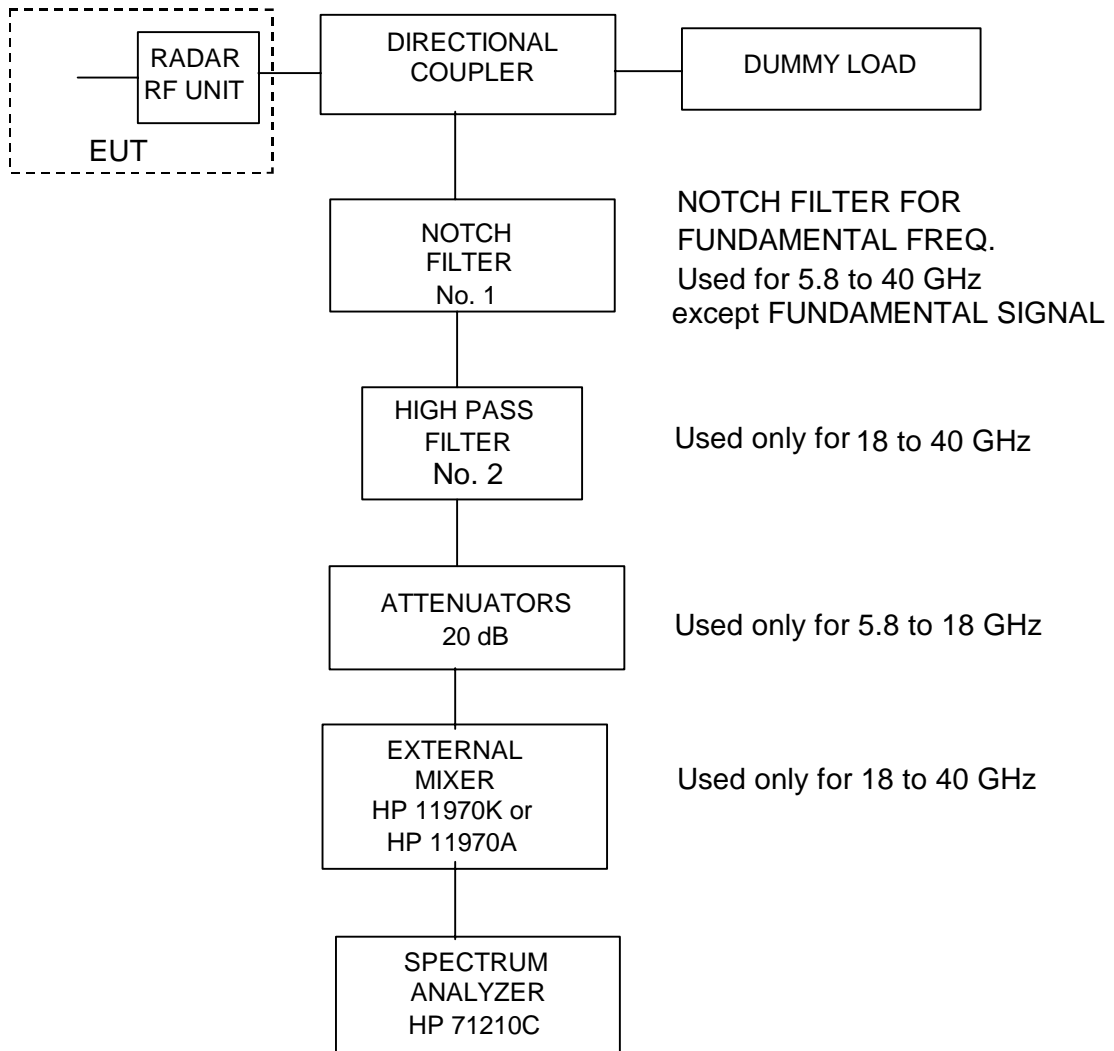


Fig. 3.4.1

**3.4.2 Measuring Equipment List:**

See Attachment D [ List of Test/Measuring Equipment ].

- Note : (1) The characteristics of Notch Filter (No. 1) are described in Fig. 3.4.2 to Fig. 3.4.5.  
(2) The characteristic of High Pass Filter (No. 2) is described in Fig. 3.4.6.

**3.4.3 Test Conditions:**

Radar Range Settings: 0.125 nm (Short)/1.5 nm (Middle)/3 nm (Long 1)/  
48 nm (Long 2)/96 nm (Long 3)

**3.4.4 Emission Limits:**

- (a) Frequency Range (FCC Rule, 2.1057(1)) : 10 kHz - 40 GHz
- (b) Emission Limits (FCC Rule, 80.211) :

Frequency removed from the assigned frequency	Frequency (Hz)	Emission attenuation (mean power ,dB)
50 - 100 % (of the authorized bandwidth)	9310 - 9360 M	At least 25
	9460 - 9510 M	
100 - 250 %	9160 - 9310 M	At least 35
	9510 - 9660 M	
more than 250 %	10 k - 9160 M	At least 43 + 10 log <sub>10</sub> (mean power in watts)
	9660- 40,000 M	

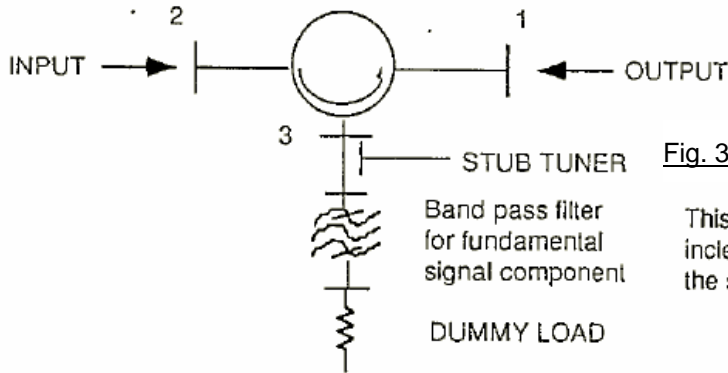
- Note : (1) Assigned frequency (center frequency) = 9410 MHz  
(2) Authorized bandwidth = 100 MHz

**3.4.5 Test Results:**

As shown in Attachment A, the spurious emissions at antenna terminal of EUT are found lower than the specified limits.

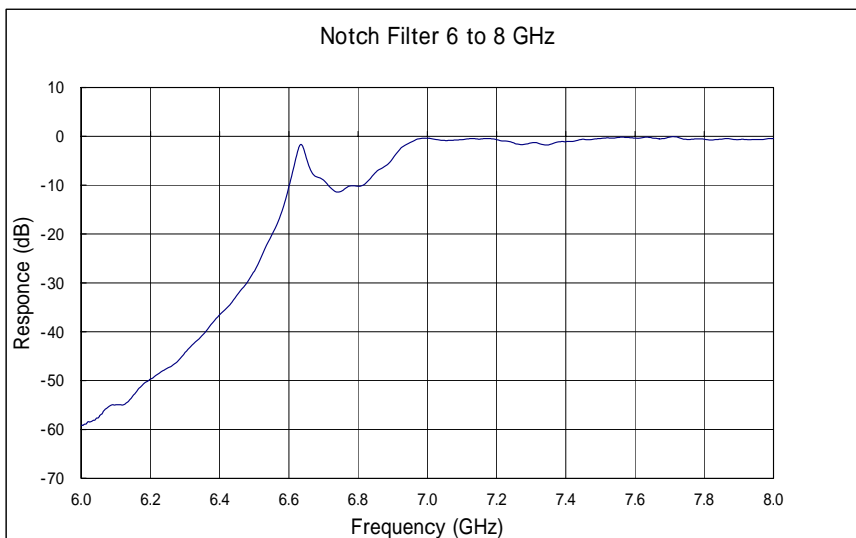
(Note: Spurious emissions for 10 kHz to 5.8 GHz are not found due to the antenna terminal structure. (Waveguide tube)).

Characteristic of Filter No.1 (for X-band)

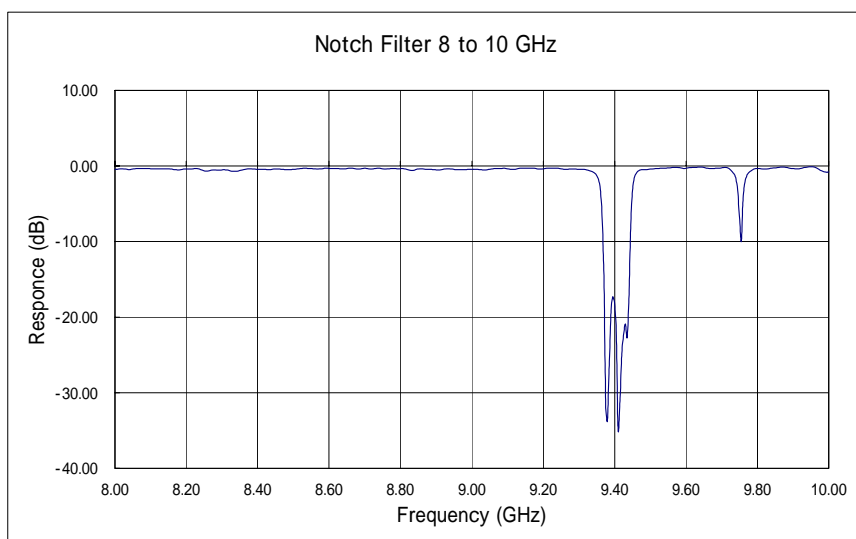


**Fig. 3.4.2** Setup of Notch Filter No.1

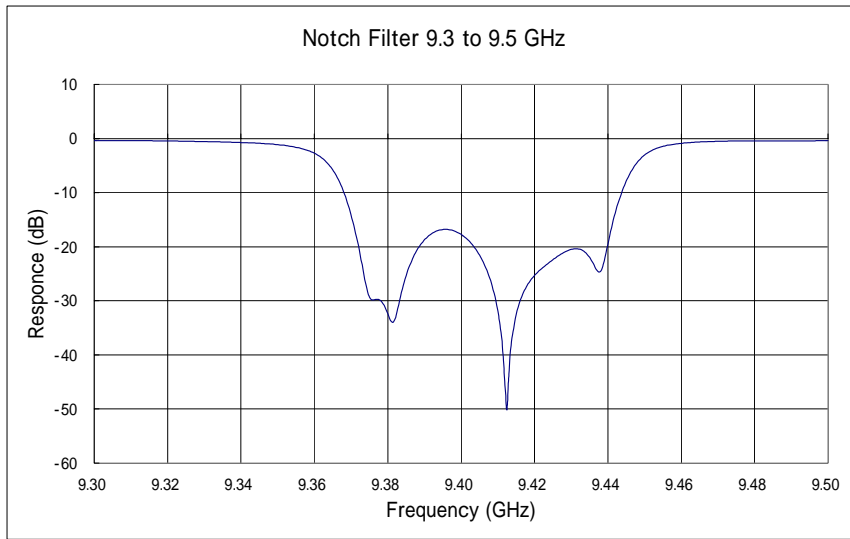
This notch filter is used to increase the dynamic range of the spectrum analyzer



**Fig. 3.4.3**

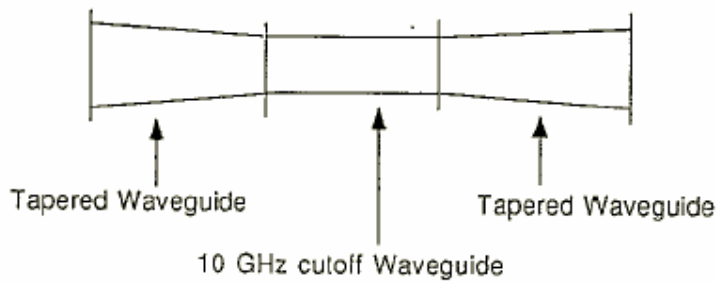


**Fig. 3.4.4**



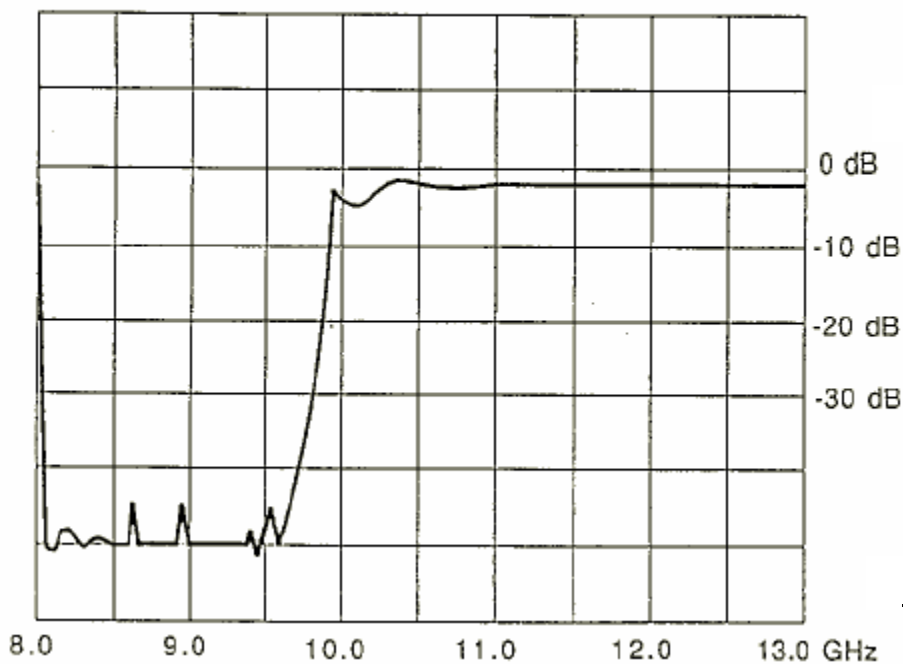
**Fig. 3.4.5**

Characteristic of Filter No. 2 (for X-band)



This filter is used to filter out the high level fundamental signal to avoid damage to the analyzer.

High Pass Filter Construction



**Fig. 3.4.6**

**3.5 Field Strength of Spurious Radiation (FCC Rule, 2.1053)**

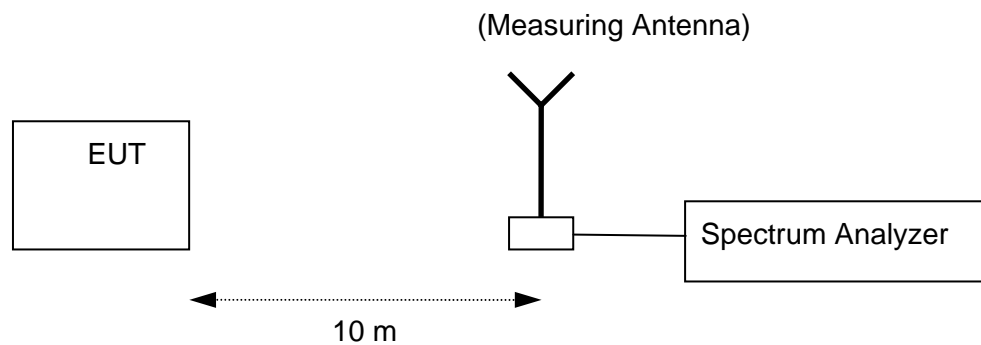
**3.5.1 Test Site:** Rooftop of 6-story building,  
FURUNO ELECTRIC CO., LTD.  
Ashihara-cho 9-52, Nishinomiya-city, 662-8580 Japan

**3.5.2 Distance between the radar set and measuring antenna:** 10 m

**3.5.3 Radar Range settings:** 0.125 nm (Short)/1.5 nm (Middle)/3 nm (Long 1)/  
48 nm (Long 2)/ 96 nm (Long 3)

**3.5.4 Measuring Equipment List:**  
See Attachment D [ List of Test/Measuring Equipment ].

**3.5.5 Test settings:**



**3.5.6 Field Strength Limits:**

(a) Frequency Range (FCC Rule, 2.1057(1)) : 10 kHz - 40 GHz

(b) Emission Limits (FCC Rule, 80.211) :

Frequency removed from the assigned frequency	Frequency (MHz)	Emission attenuation (mean power, dB)
50 - 100 % (of the authorized bandwidth)	9,310 – 9,360	At least 25
	9,460 – 9,510	
100 - 250 %	9,160 – 9,310	At least 35
	9,510 – 9,660	
more than 250 %	0.01 – 9,160	At least 43 + 10 log <sub>10</sub> (mean power in watts)
	9,660 - 40,000	

Note : (1) Assigned frequency (center frequency) = 9410 MHz  
(2) Authorized bandwidth = 100 MHz

**3.5.7 Test Results:**

As shown in Attachment B, the field strengths of spurious radiation generated by EUT are found lower than the specified limits.

**3.6 Frequency Stability (FCC Rule, 2.1055)**

**3.6.1 Setup for Measurement**

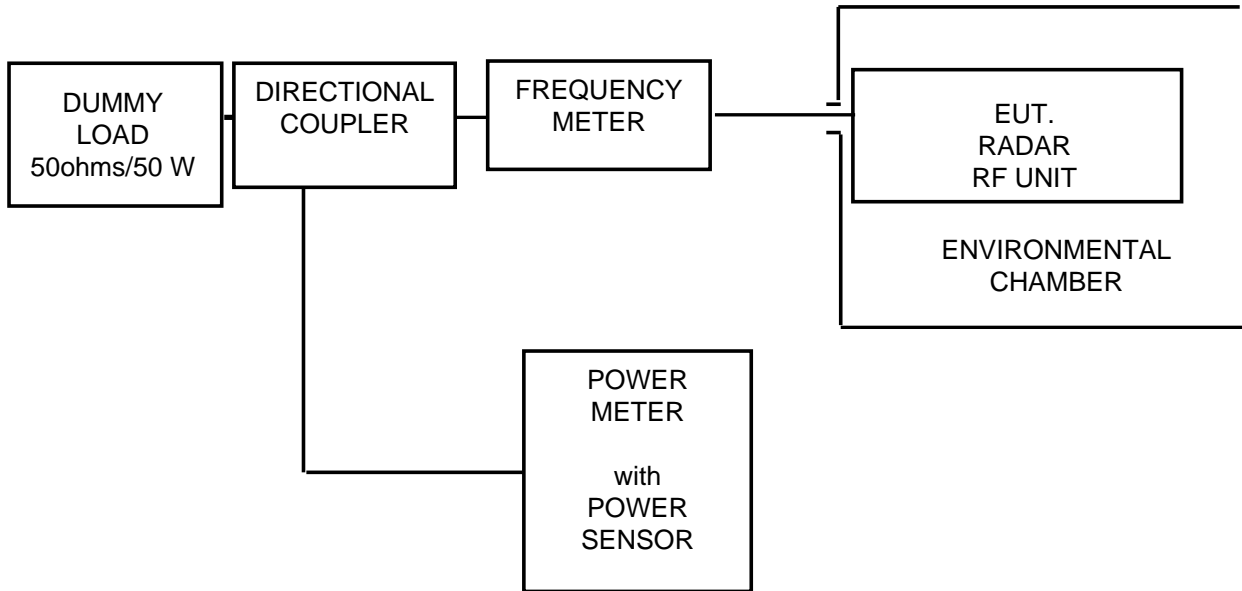


Fig. 3.6.1

**3.6.2 Test Conditions:**

- 1) Radar Range settings : 0.125 nm (Short)/1.5 nm (Middle)/3 nm (Long 1)/  
48 nm (Long 2)/96 nm (Long 3)
- 2) Ambient Temperature settings: - 20°C to + 60°C (10°C step)
- 3) Power Supply Voltage settings: 85 /115 % of nominal voltage (20.4 VDC to 27.6 VDC)

**3.6.3 Measuring Equipment List:**

See Attachment D [ List of Test/Measuring Equipment ].

**3.6.4 Frequency Tolerance Limits:**

"The frequency at which maximum emission occurs must be within the authorized bandwidth and must not be closer than 1.5/T MHz to the upper and lower limits of the authorized band width, where "T" is the pulse duration in microseconds. "

(FCC Rule, 80.209 (b))

- 1) Center frequency (f<sub>0</sub>): 9410 MHz
- 2) Authorized bandwidth (f(AUBW)): 100 MHz

"Upper limit frequency of the authorized band",  $f(\text{UAUBW}) = f_0 + f(\text{AUBW})/2 = 9460 \text{ MHz}$

"Lower limit frequency of the authorized band",  $f(\text{LAUBW}) = f_0 - f(\text{AUBW})/2 = 9360 \text{ MHz}$

- 3) Assignable frequency bandwidth : 200 MHz (between 9300 MHz and 9500 MHz)  
(FCC Rule, 80.375 (d)-(1))

"Upper limit frequency of the assignable band",  $f(\text{UASB}) = 9500 \text{ MHz}$

"Lower limit frequency of the assignable band",  $f(\text{LASB}) = 9300 \text{ MHz}$

- 4) Guard Band (f(1.5/T)) :

Pulselength	Short	Middle	Long 1	Long 2	Long 3
Range Scale (nm)	0.125	1.5	3	48	96
Pulselength (µsec)	0.08	0.30	0.80	0.80	0.80
Guard Band f(1.5/T) (MHz)	18.75	5.00	1.88	1.88	1.88

**3.6.5 Test Results:**

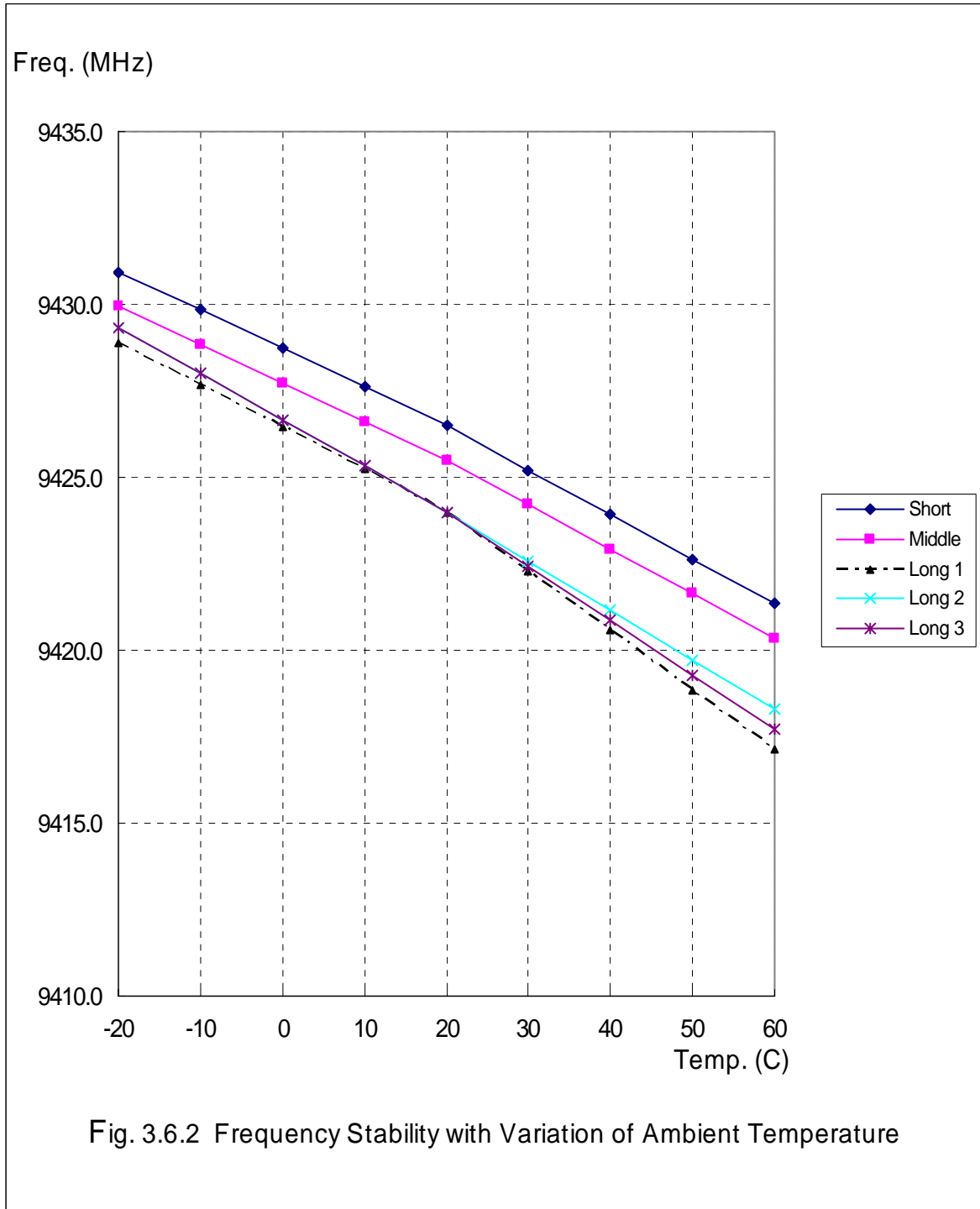
Shown on Fig. 3.6.2.

- (1) "Upper Tolerance Frequency measured (at - 20°C)",  $f(\text{U}) = 9430.9 \text{ MHz}$
  - (2) "Lower Tolerance Frequency measured (at + 50°C)",  $f(\text{L}) = 9418.9 \text{ MHz}$
  - (3)-(a)  
 $f(\text{U}) + \text{max. } f(1.5/T) = 9449.7 \text{ MHz} < f(\text{UAUBW}) = 9460 \text{ MHz} \leq f(\text{UASB}) = 9500 \text{ MHz}$
  - (3)-(b)  
 $f(\text{L}) - \text{max. } f(1.5/T) = 9400.1 \text{ MHz} > f(\text{LAUBW}) = 9360 \text{ MHz} \geq f(\text{LASB}) = 9300 \text{ MHz}$
- So, both are found within the specified limits.



**FREQUENCY STABILITY WITH VARIATION OF PRIMARY SUPPLY VOLTAGE:**

The built-in voltage regulator allows no frequency variation against variations of  $\pm 15\%$  of nominal power supply voltage (20.4 to 27.6 VDC for nominal 24 VDC).



### 3.7 Suppression of Interference Aboard Ships (FCC Rule, 80.217)

#### 3.7.1 Measuring Antenna Characteristics at Representative Frequencies:

Whip antennas are used to determine the level of interference caused by the radar to shipboard receivers. These antennas have the following characteristics (refer to impedance charts attached):

Length	Test Frequency (Hz)	Impedance ( $\Omega$ )	$\theta$	R ( $\Omega$ )	C or L
6 m	500.5 k	1 k	-90°	0	80 pF
6 m	1.992 M	1.25 k	-86°	87.2	64 pF
6 m	10.00204 M	158		109	140 pF
4 m	27.5 M	95		83.5	128 pF
$5/8 \lambda$	150 M	116.5		105.5	52.5 nH
$1/4 \lambda$	450 M	70.5		34.5	5.68 pF

**3.7.2 Test Site:** Rooftop of 6-story building,  
Furuno Electric Company, Ltd.  
Ashihara-cho 9-52, Nishinomiya-city, 662-8580 JAPAN

#### 3.7.3 Measuring Instrument List:

See Attachment D [ List of Test/Measuring Equipment ].  
(Instruments for measuring antenna characteristics are listed below.)

- (1) Network Analyzer, HP 8753C
- (2) Spectrum Analyzer, ADVANTEST TR4172
- (3) Spectrum Analyzer, HP 8566B
- (4) Antennas,
  - for 14 k - 10 MHz, 6 m whip
  - for 10 - 30 MHz, 4 m whip
  - for 30 - 300 MHz, VHF whip
  - for 300 - 1000 MHz, UHF whip

**3.7.4 Test Results:**

Interference levels to the respective antenna were measured at 2 m from the radar which was put in OFF and TRANSMIT conditions, and found within the specified limits.

**3.7.4.1 Harmful Interference to Receiver (FCC Rule, 80.217 (a))**

Limits: for 14 - 490 kHz, 5  $\mu\text{V}/\text{m}$   
for 490 kHz - 1 GHz, 1  $\mu\text{V}/\text{m}$

Results: There is no spurious component which is deemed harmful interference. (Test data are shown in Attachment C.)

**3.7.4.2 Electromagnetic Field (FCC Rule, 80.217 (b) - 1)**

Limits: for below 30 MHz, 0.1  $\mu\text{V}/\text{m}$  at 1 nm (-20 dB $\mu\text{V}/\text{m}$ )  
for 30 to 100 MHz, 0.3  $\mu\text{V}/\text{m}$  at 1 nm (-10.5 dB $\mu\text{V}/\text{m}$ )  
for 100 to 300 MHz, 1.0  $\mu\text{V}/\text{m}$  at 1 nm (0 dB $\mu\text{V}/\text{m}$ )  
for over 300 MHz, 3.0  $\mu\text{V}/\text{m}$  at 1 nm (9.5 dB $\mu\text{V}/\text{m}$ )

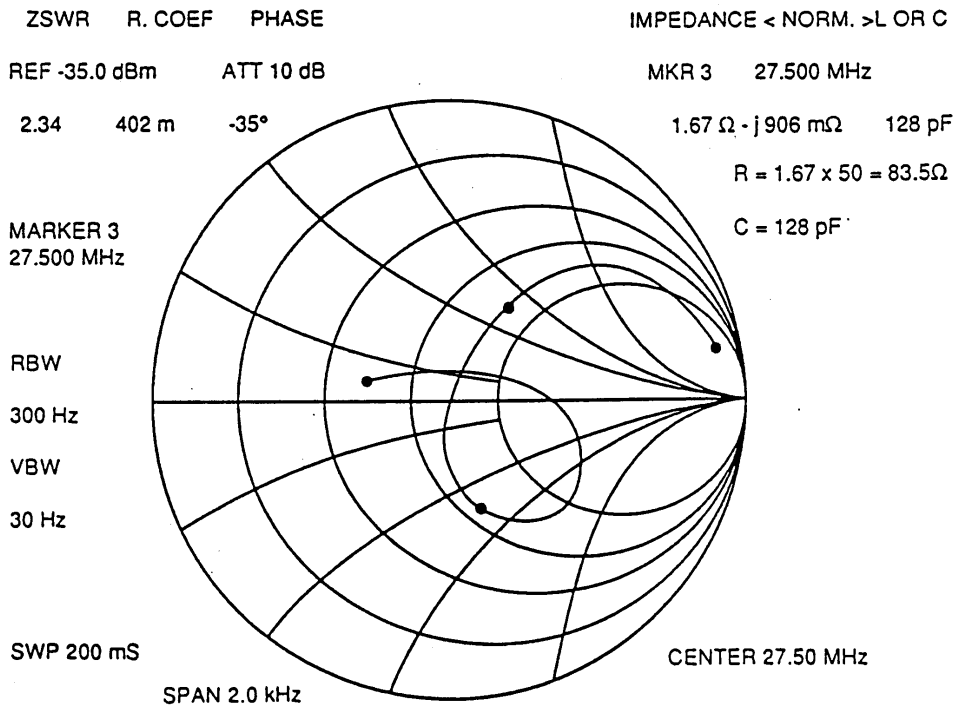
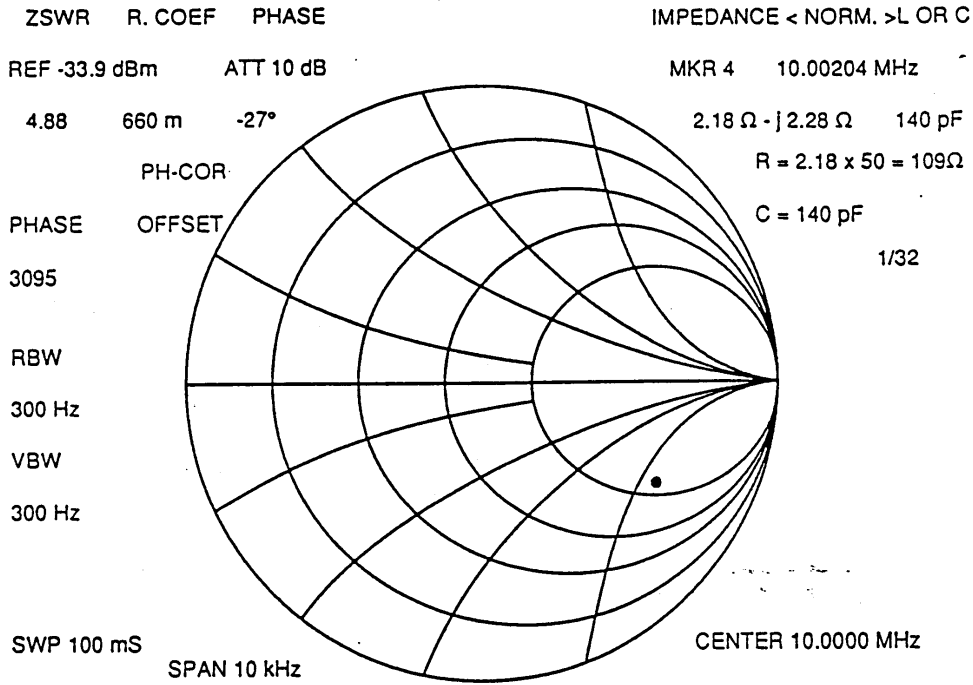
Results: Interference was measured with the antenna located 2 m from the radar and converted to levels at 1 nm. There is no spurious component exceeding the limits.  
(Test data are shown in Attachment C.)

**3.7.4.3 Power Input to an Artificial Antenna (FCC Rule, 80.217 (b) - 2)**

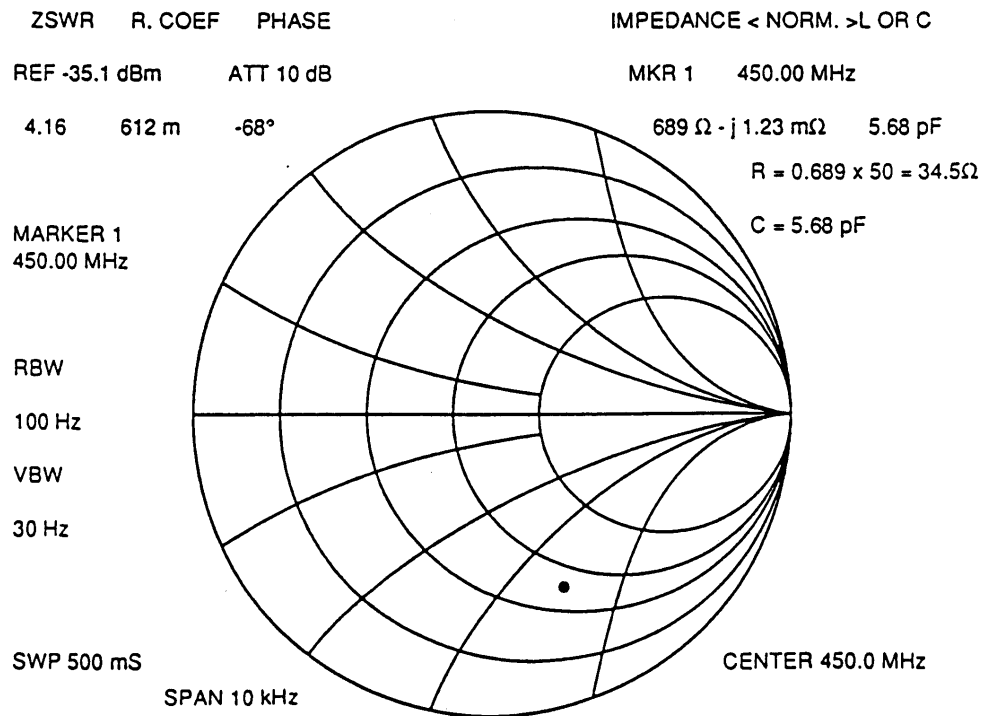
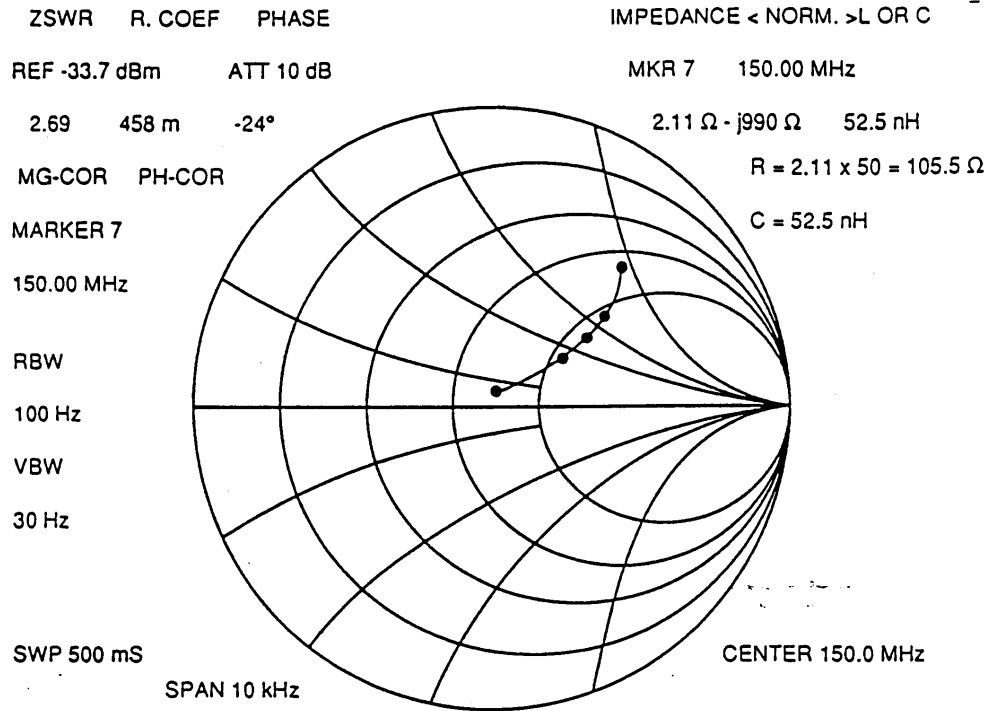
Limits: for below 30 MHz, 400  $\mu\text{W}$   
for 30 to 100 MHz, 4,000  $\mu\text{W}$   
for 100 to 300 MHz, 40,000  $\mu\text{W}$   
for over 300 MHz, 400,000  $\mu\text{W}$

Results: There is no spurious component exceeding the limits.  
(Test data are shown in Attachment C.)

## MEASUREMENT OF IMPEDANCE OF TEST ANTENNAS



## MEASUREMENT OF IMPEDANCE OF TEST ANTENNAS



**4 Photographs to Reveal Equipment Construction and Layout (FCC Rule, 2.1033)**

(See separate covers.)

## **5 Description of Circuitry and Devices (FCC Rules, 2.1033)**

(See separate covers.)

**6 Operator's Manual Incl. Circuit Diagrams (FCC Rule, 2.1033)**

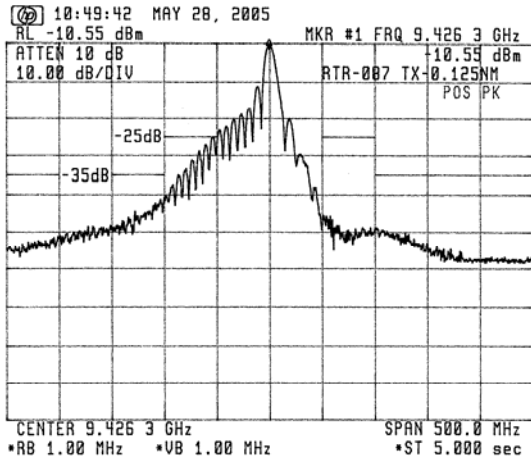
(See separate covers.)



**Attachment A**

[ TEST DATA for Clause 3.4. SPURIOUS EMISSIONS AT ANTENNA TERMINALS ]

1. Spurious emissions for 0.125 nm Range:

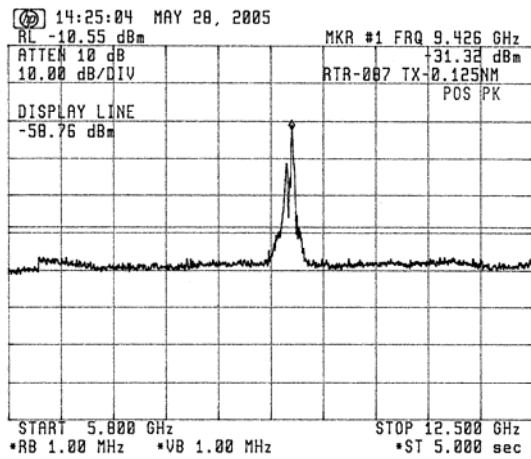


Ref. level: -10.55 dBm

Emission limitations:

- (a) 25 dB for 50 to 100 % of the authorized BW (100 MHz)
- (b) 35 dB for 100 to 250 % of the authorized BW (100 MHz)

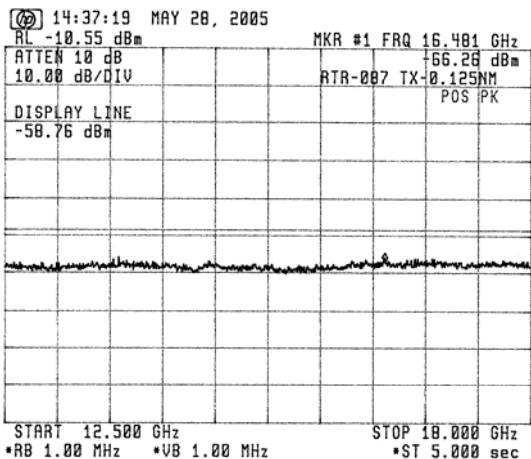
Fig. 1.1 Without Filters



Emission limitations:

- (c)  $43 + 10 \log P_m = -48.21 \text{ dB}$  for more than 250 % of the authorized BW (100 MHz)

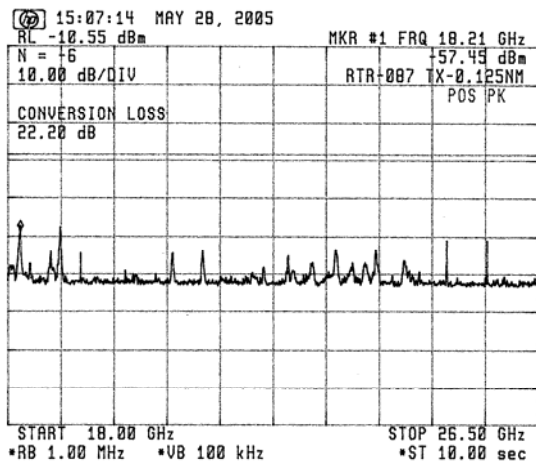
Fig. 1.2 With Filter No.1



Emission limitations:

- (c)  $43 + 10 \log P_m = -48.21 \text{ dB}$  for more than 250 % of the authorized BW (100 MHz)

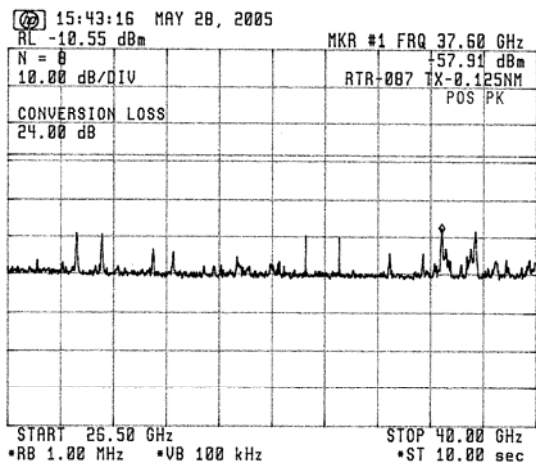
Fig. 1.3 With Filter No. 1



Emission limitations:

- (c)  $43 + 10 \log P_m = -48.21 \text{ dB}$   
for more than 250 % of  
the authorized BW (100 MHz)

Fig. 1.4 With Filters No. 1 + No. 2

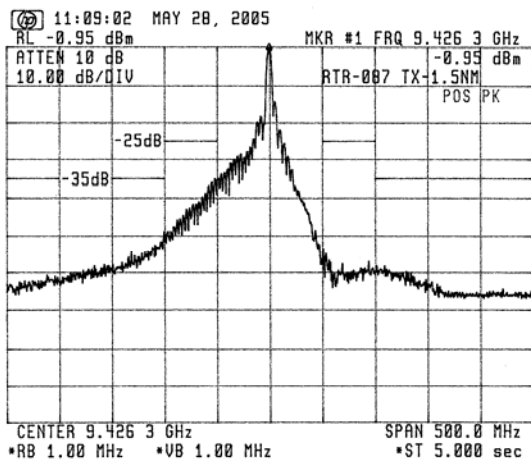


Emission limitations:

- (c)  $43 + 10 \log P_m = -48.21 \text{ dB}$   
for more than 250 % of  
the authorized BW (100 MHz)

Fig. 1.5 With Filters No. 1 + No. 2

2. Spurious emissions for 1.5 nm Range:

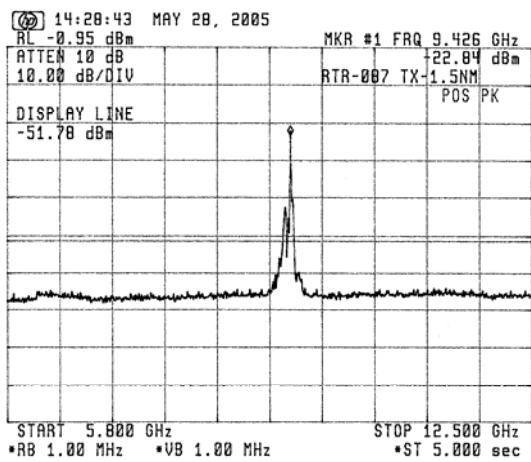


Ref. level: -0.95 dBm

Emission limitations:

- (a) 25 dB for 50 to 100 % of the authorized BW (100 MHz)
- (b) 35 dB for 100 to 250 % of the authorized BW (100 MHz)

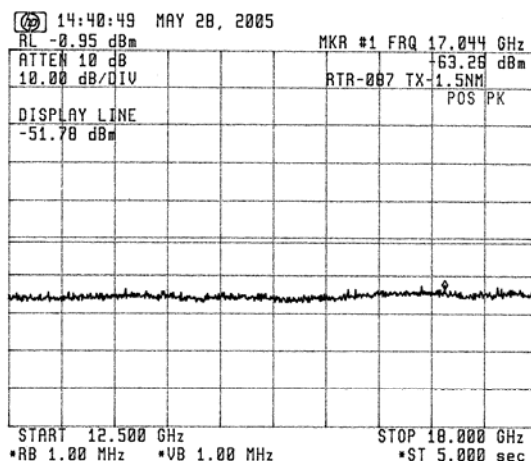
Fig. 2.1 Without Filters



Emission limitations:

- (c)  $43 + 10 \log P_m = -50.83 \text{ dB}$  for more than 250 % of the authorized BW (100 MHz)

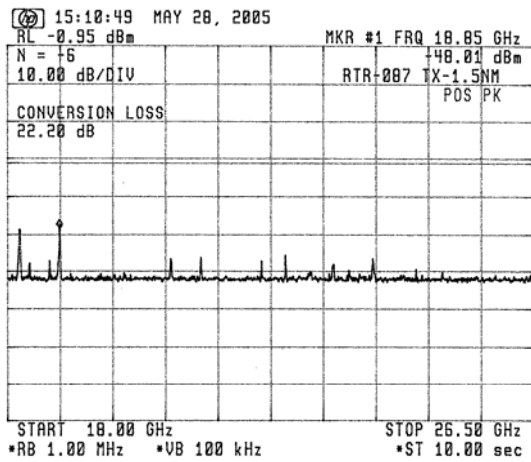
Fig. 2.2 With Filter No.1



Emission limitations:

- (c)  $43 + 10 \log P_m = -50.83 \text{ dB}$  for more than 250 % of the authorized BW (100 MHz)

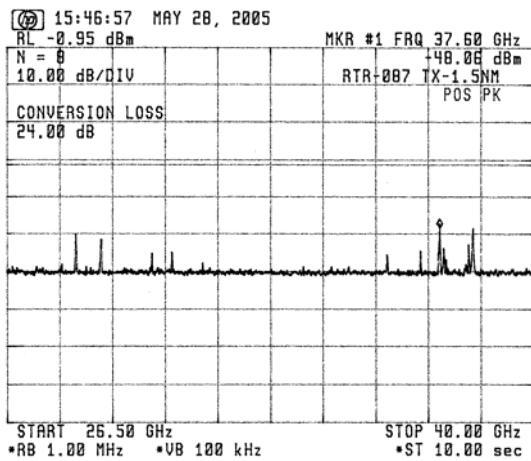
Fig. 2.3 With Filter No. 1



Emission limitations:

- (c)  $43 + 10 \log P_m = -50.83 \text{ dB}$   
for more than 250 % of  
the authorized BW (100 MHz)

Fig. 2.4 With Filters No. 1 + No. 2

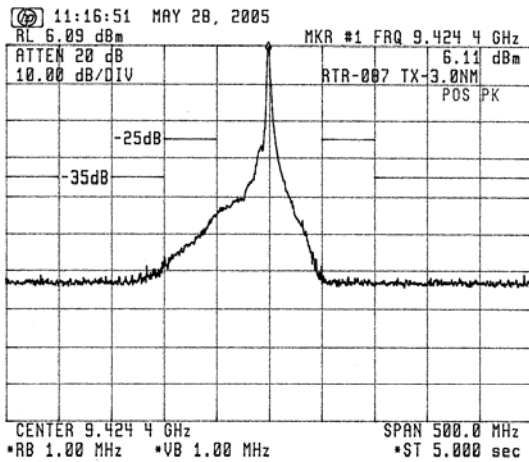


Emission limitations:

- (c)  $43 + 10 \log P_m = -50.83 \text{ dB}$   
for more than 250 % of  
the authorized BW (100 MHz)

Fig. 2.5 With Filters No. 1 + No. 2

3. Spurious emissions for 3 nm Range:

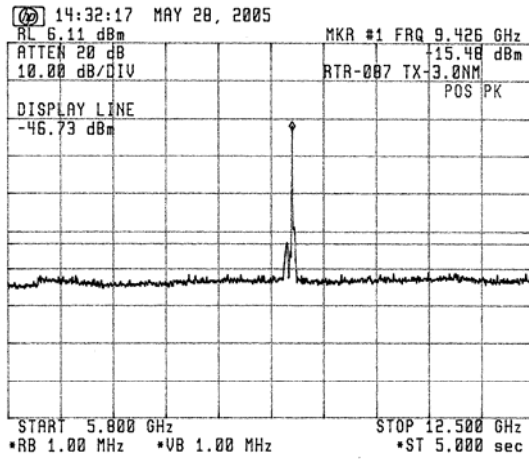


Ref. level: 6.09 dBm

Emission limitations:

- (a) 25 dB for 50 to 100 % of the authorized BW (100 MHz)
- (b) 35 dB for 100 to 250 % of the authorized BW (100 MHz)

Fig. 3.1 Without Filters

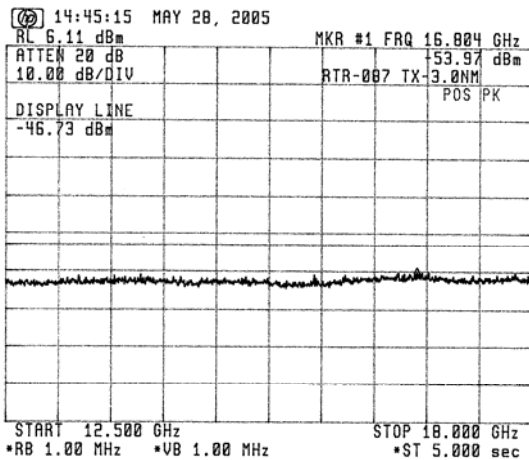


Ref. level: 6.11 dBm

Emission limitations:

- (c)  $43 + 10 \log P_m = -52.84 \text{ dB}$  for more than 250 % of the authorized BW (100 MHz)

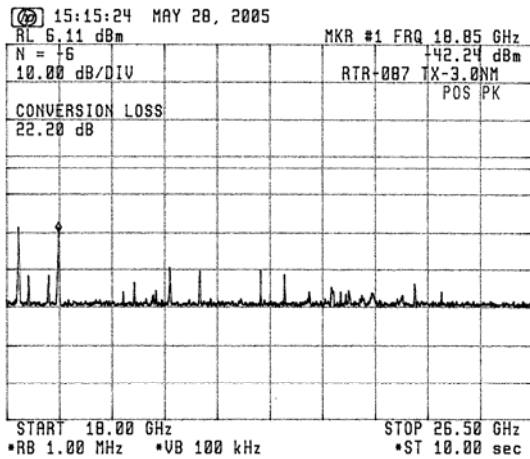
Fig. 3.2 With Filter No.1



Emission limitations:

- (c)  $43 + 10 \log P_m = -52.84 \text{ dB}$  for more than 250 % of the authorized BW (100 MHz)

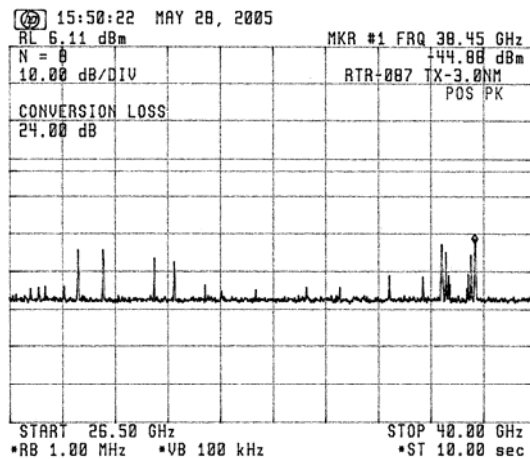
Fig. 3.3 With Filter No. 1



Emission limitations:

(c)  $43 + 10 \log P_m = -52.84 \text{ dB}$   
for more than 250 % of  
the authorized BW (100 MHz)

Fig. 3.4 With Filters No. 1 + No. 2

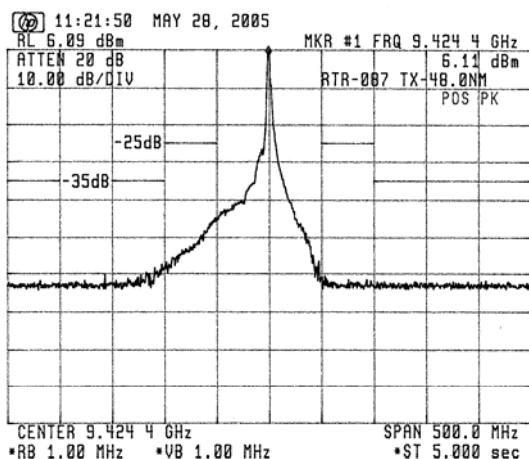


Emission limitations:

(c)  $43 + 10 \log P_m = -52.84 \text{ dB}$   
for more than 250 % of  
the authorized BW (100 MHz)

Fig. 3.5 With Filters No. 1 + No. 2

4 Spurious emissions for 48 nm Range:

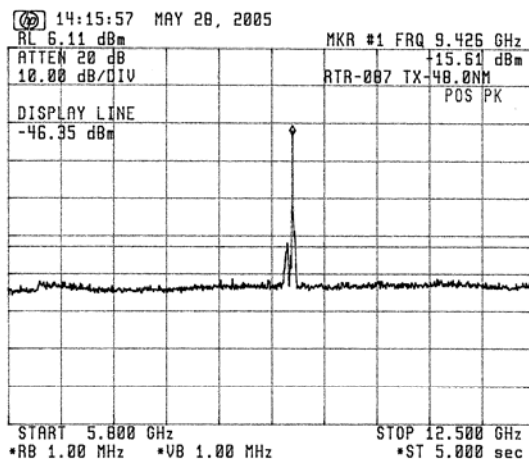


Ref. level: 6.09 dBm

Emission limitations:

- (a) 25 dB for 50 to 100 % of the authorized BW (100 MHz)
- (b) 35 dB for 100 to 250 % of the authorized BW (100 MHz)

Fig. 4.1 Without Filters

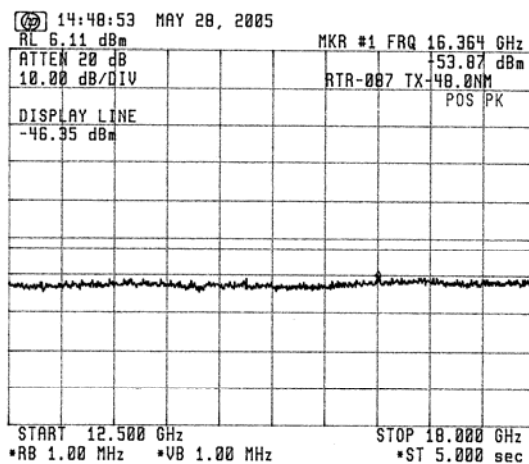


Ref. level: 6.11 dBm

Emission limitations:

- (c)  $43 + 10 \log P_m = -52.46 \text{ dB}$  for more than 250 % of the authorized BW (100 MHz)

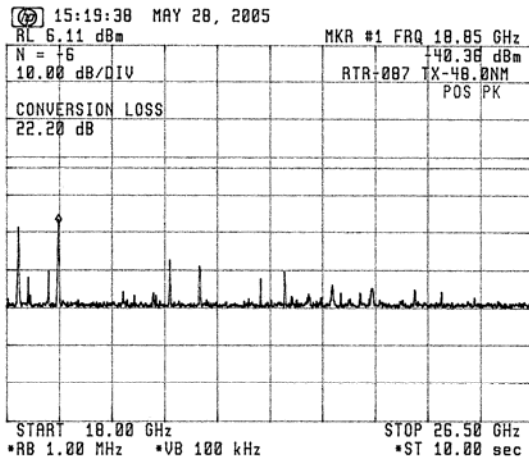
Fig. 4.2 With Filter No.1



Emission limitations:

- (c)  $43 + 10 \log P_m = -52.46 \text{ dB}$  for more than 250 % of the authorized BW (100 MHz)

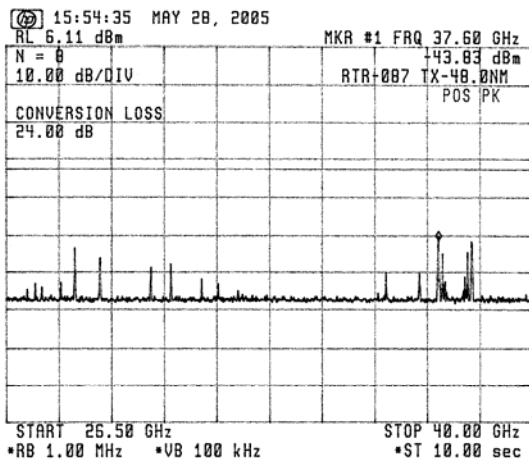
Fig. 4.3 With Filter No.1



Emission limitations:

(c)  $43 + 10 \log P_m = -52.46 \text{ dB}$   
 for more than 250 % of  
 the authorized BW (100 MHz)

Fig. 4.4 With Filters No. 1 + No. 2



Emission limitations:

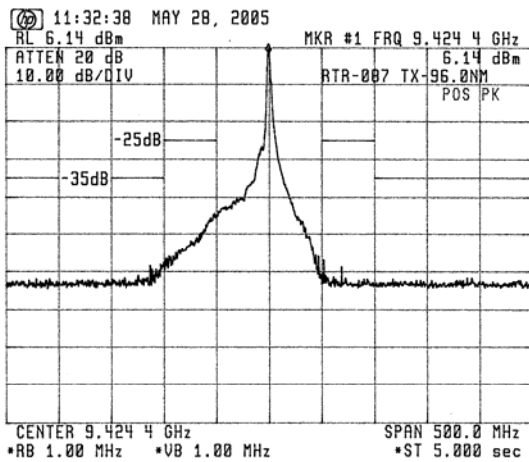
(c)  $43 + 10 \log P_m = -52.46 \text{ dB}$   
 for more than 250 % of  
 the authorized BW (100 MHz)

Fig. 4.5 With Filters No. 1 + No. 2



5 Spurious emissions for 96 nm Range:

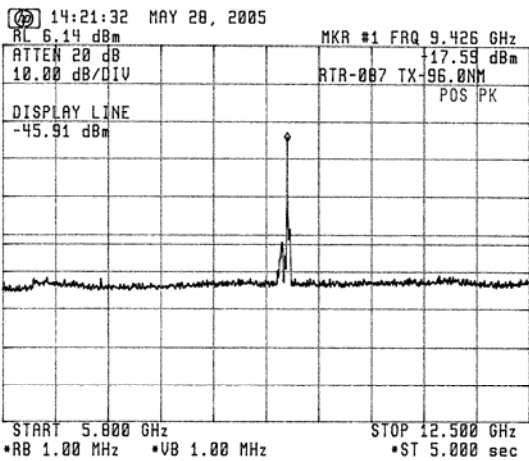
Ref. level: 6.14 dBm



Emission limitations:

- (a) 25 dB for 50 to 100 % of the authorized BW (100 MHz)
- (b) 35 dB for 100 to 250 % of the authorized BW (100 MHz)

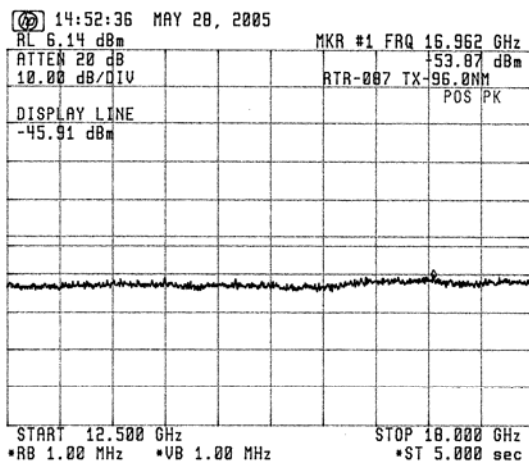
Fig. 5.1 Without Filters



Emission limitations:

- (c)  $43 + 10 \log P_m = -52.05 \text{ dB}$  for more than 250 % of the authorized BW (100 MHz)

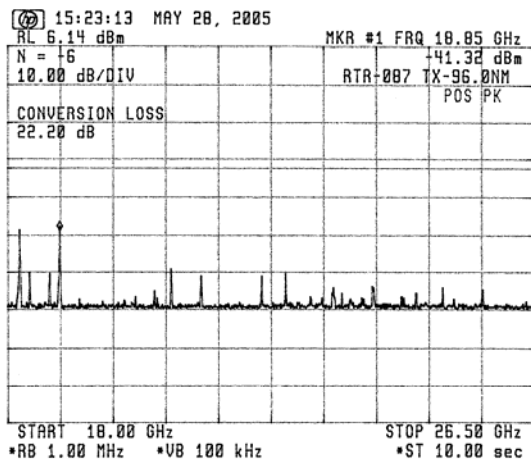
Fig. 5.2 With Filter No.1



Emission limitations:

- (c)  $43 + 10 \log P_m = -52.05 \text{ dB}$  for more than 250 % of the authorized BW (100 MHz)

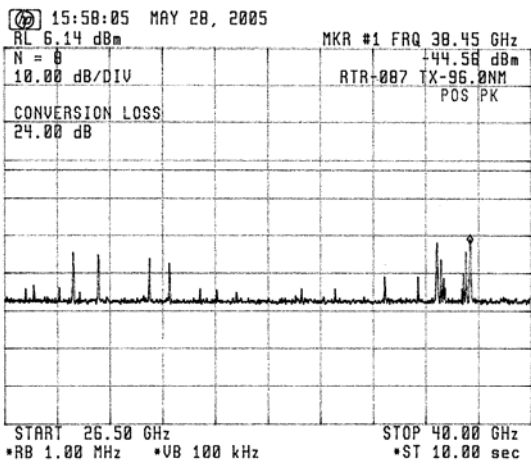
Fig. 5.3 With Filter No. 1



Emission limitations:

- (c)  $43 + 10 \log P_m = -52.05 \text{ dB}$   
for more than 250 % of  
the authorized BW (100 MHz)

Fig. 5.4 With Filters No. 1 + No. 2

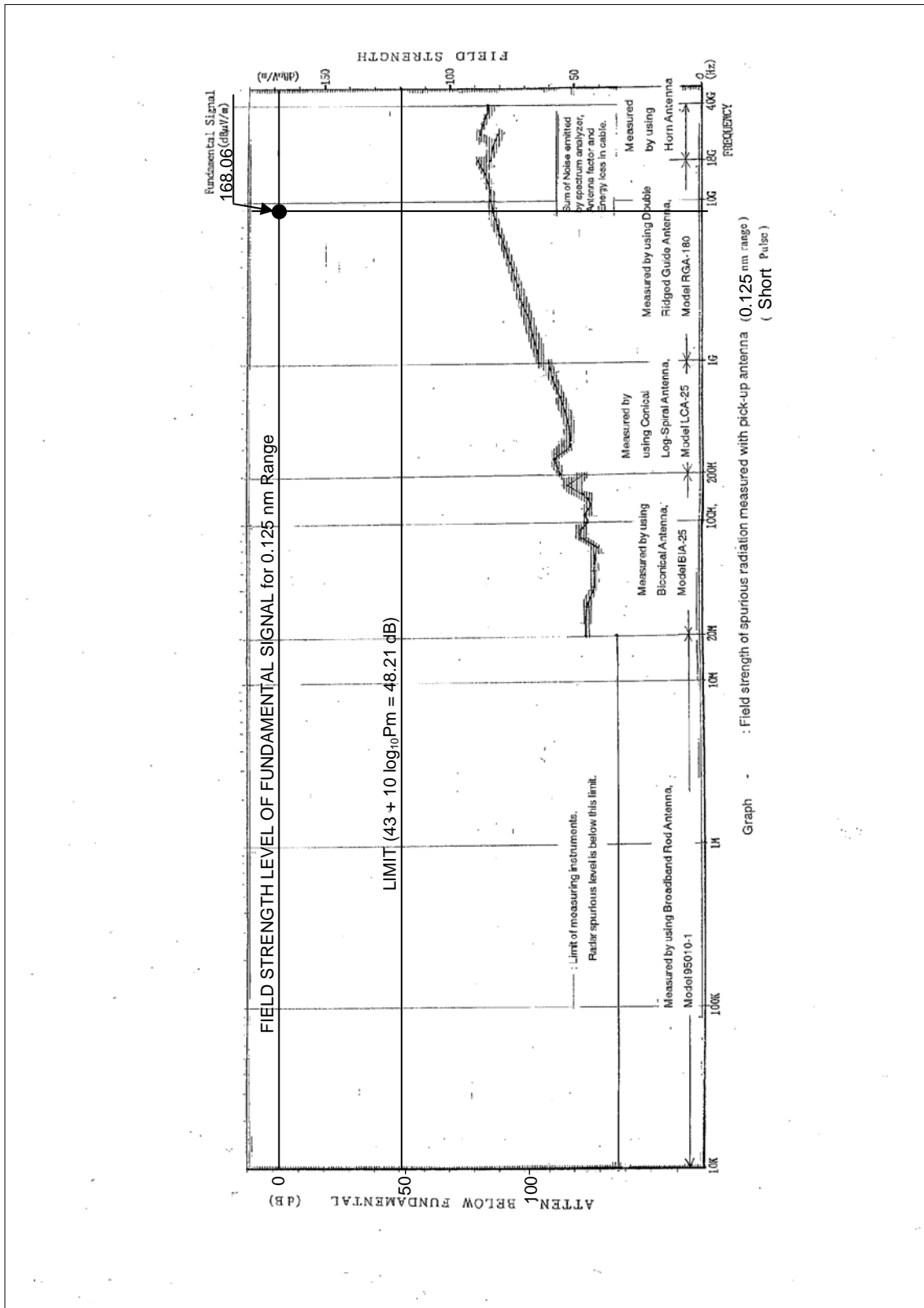


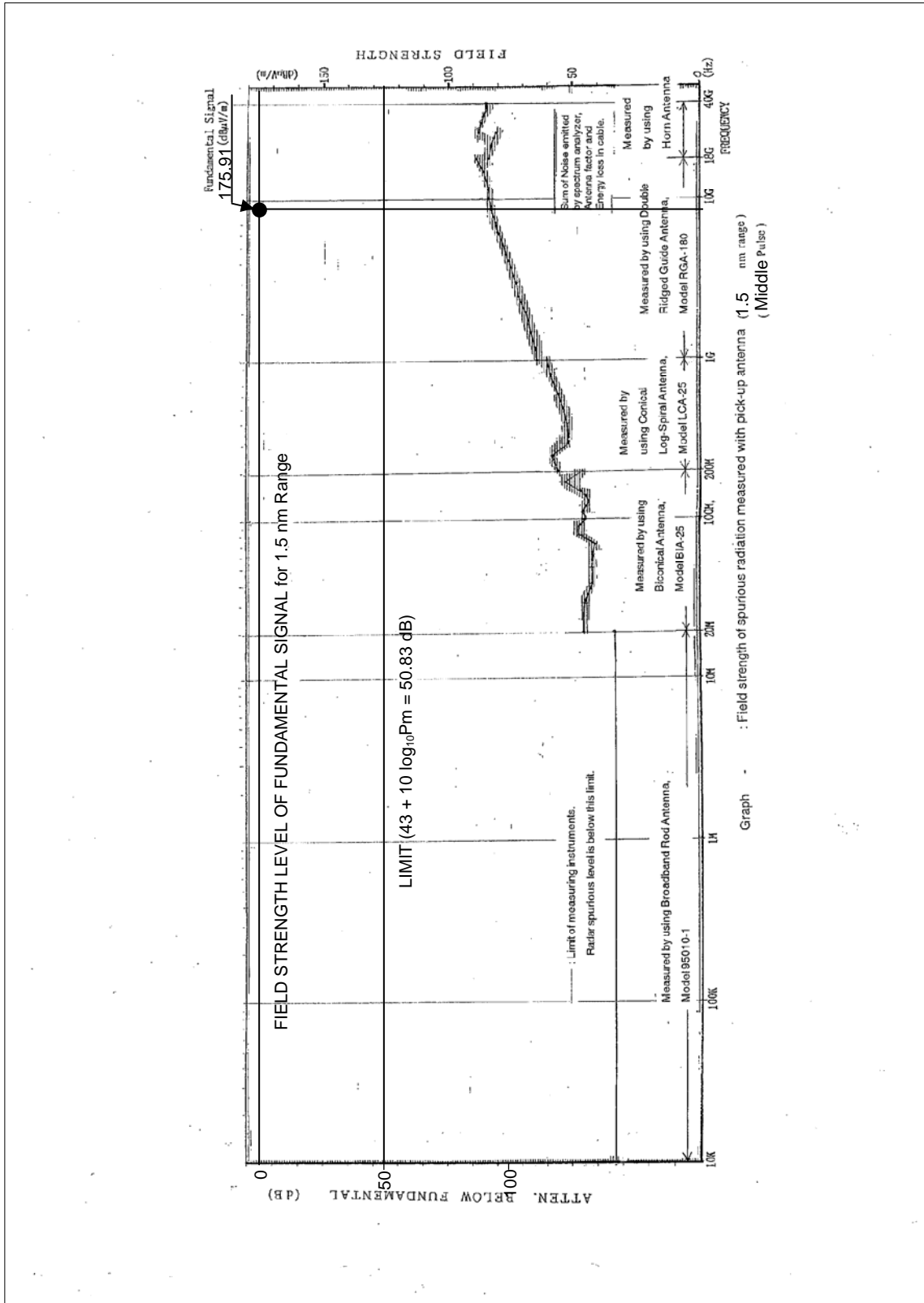
Emission limitations:

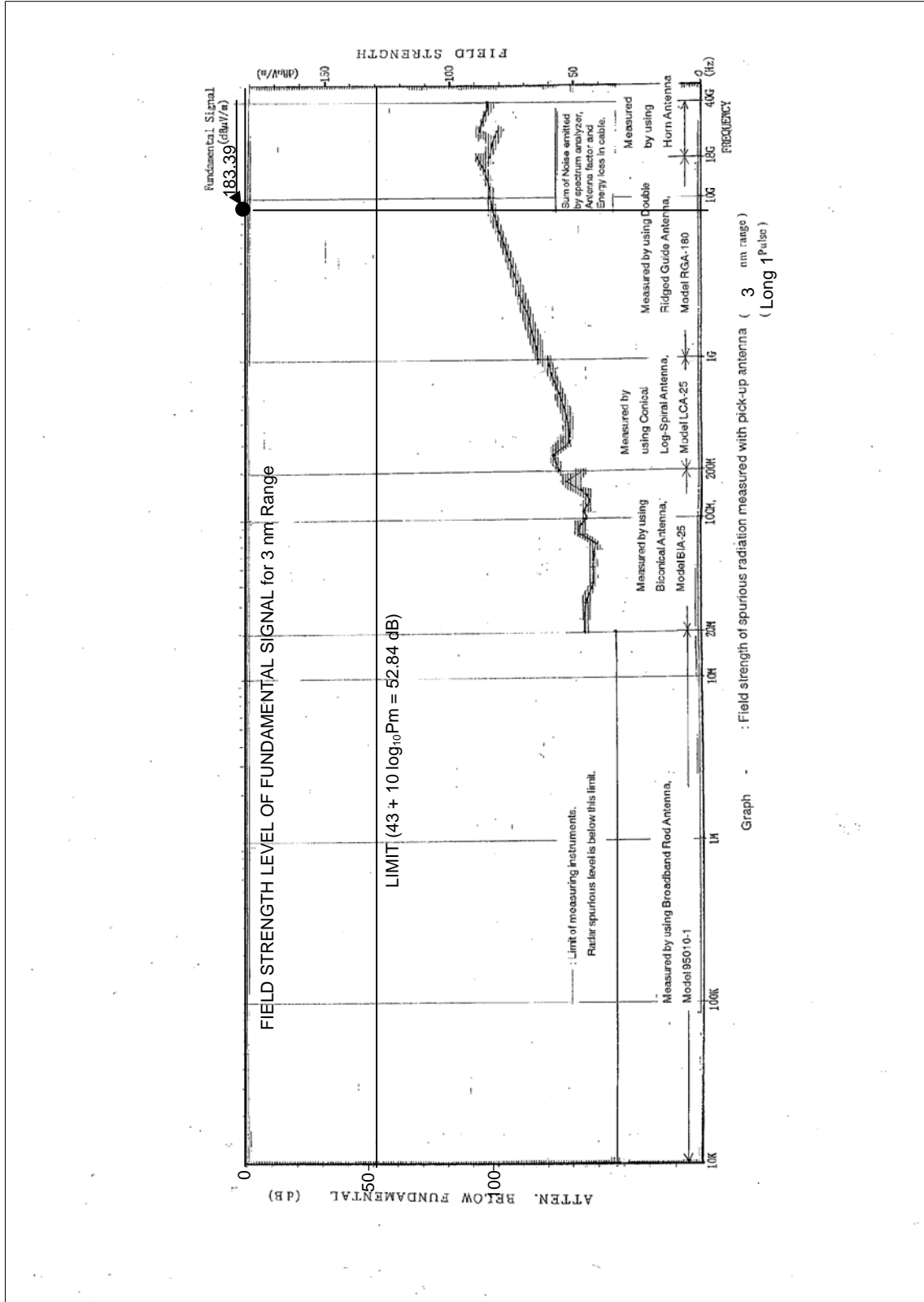
- (c)  $43 + 10 \log P_m = -52.05 \text{ dB}$   
for more than 250 % of  
the authorized BW (100 MHz)

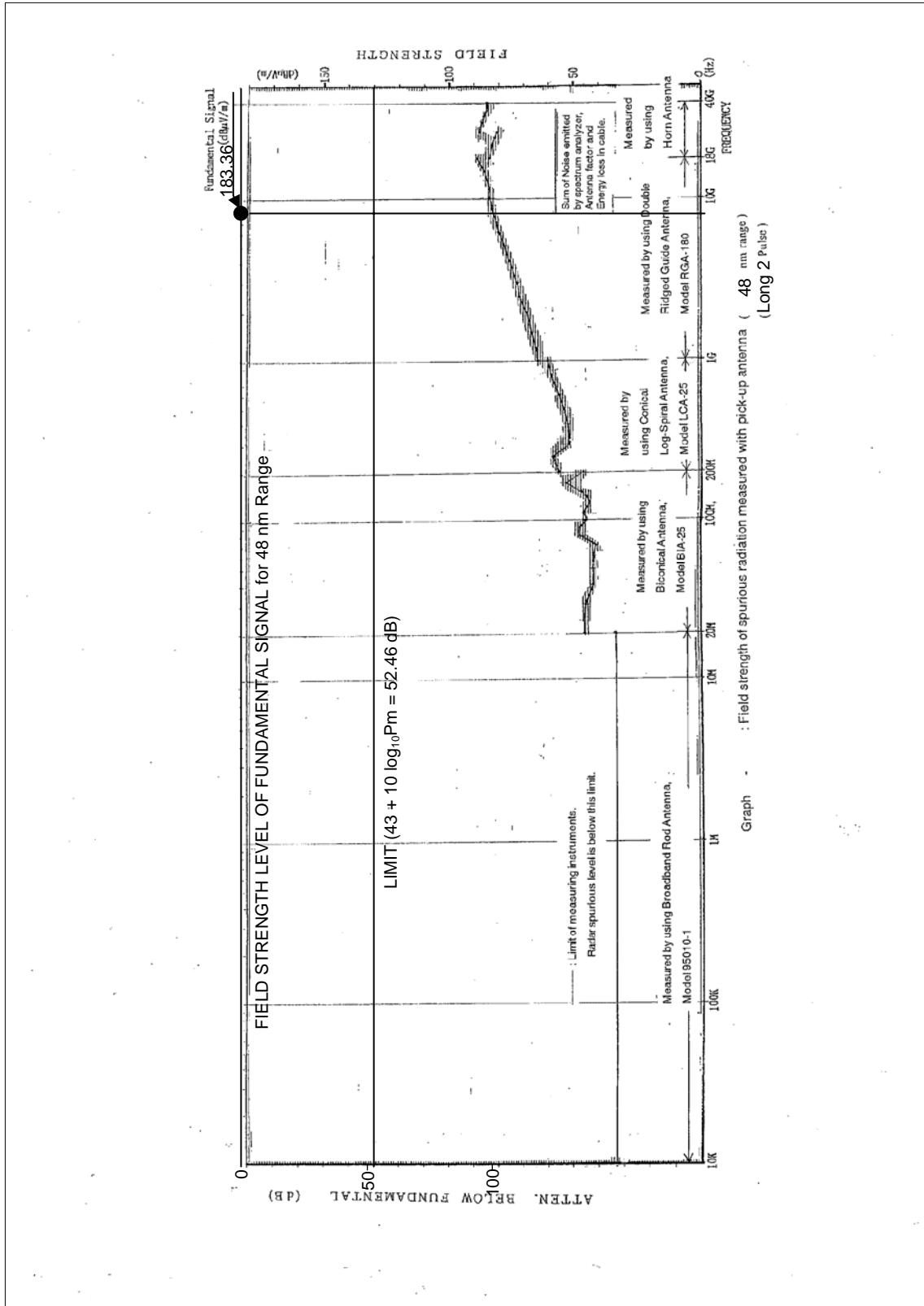
Fig. 5.5 With Filters No. 1 + No. 2

**ATTACHMENT B TEST DATA** for Clause 3.5 FIELD STRENGTH OF SPURIOUS RADIATION











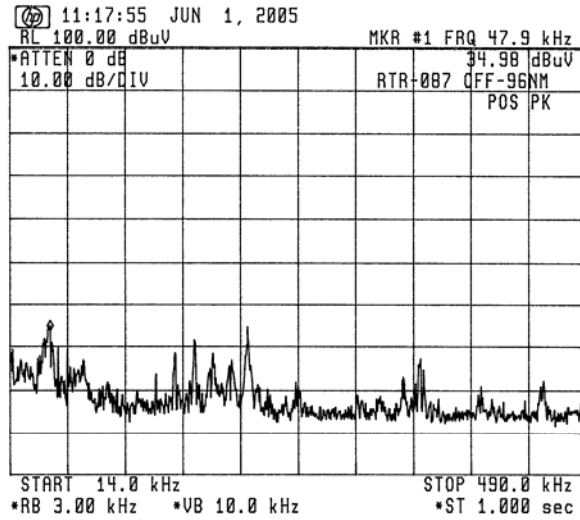
**ATTACHMENT C**

[ TEST DATA for Clause 3.7 SUPPRESSION OF INTERFERENCE ABOARD SHIPS ]

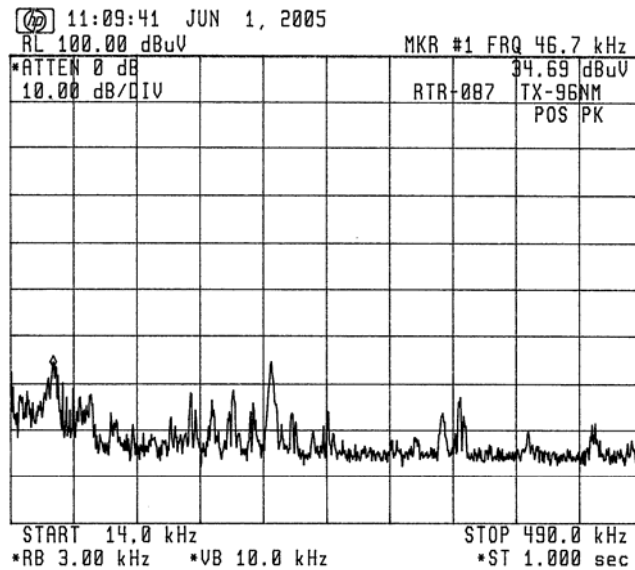
1 Harmful Interference to Receiver

(Band: 14 kHz - 490 kHz)

a) Radar Power: OFF



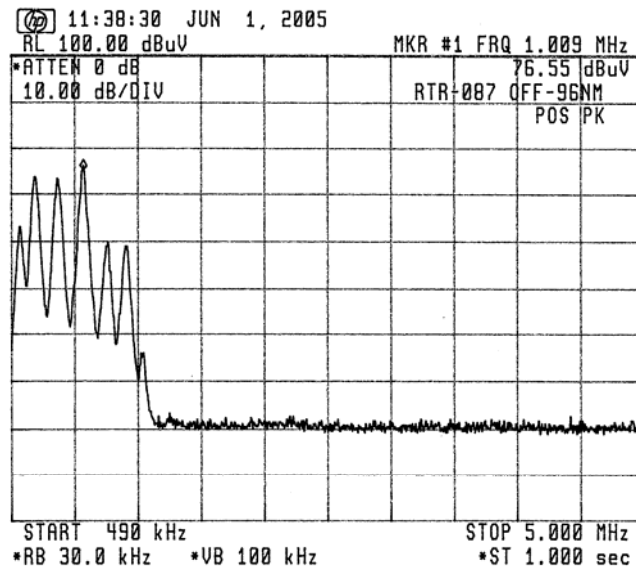
b) Radar TX: ON



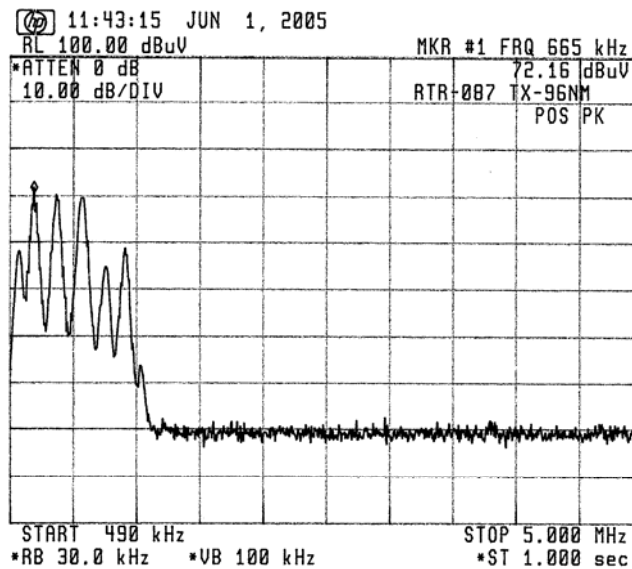


(Band: 490 kHz - 5 MHz)

a) Radar Power: OFF

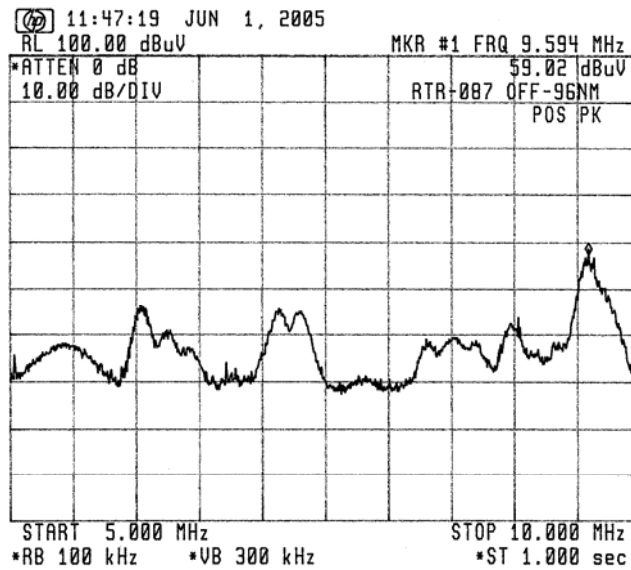


b) Radar TX: ON

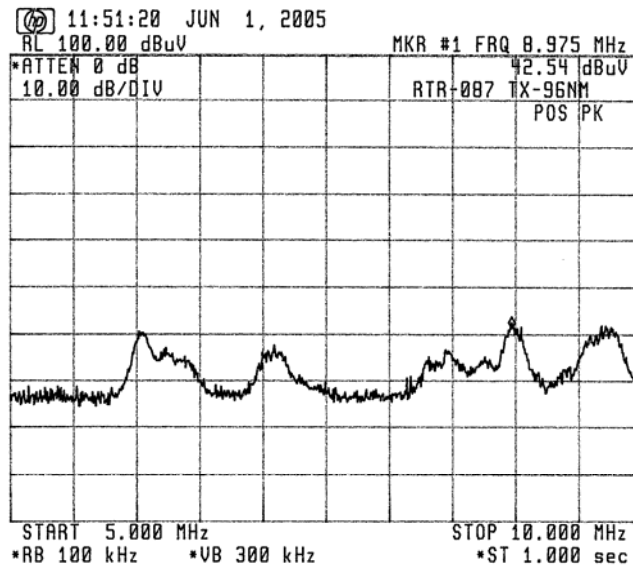


(Band: 5 MHz - 10 MHz)

a) Radar Power: OFF

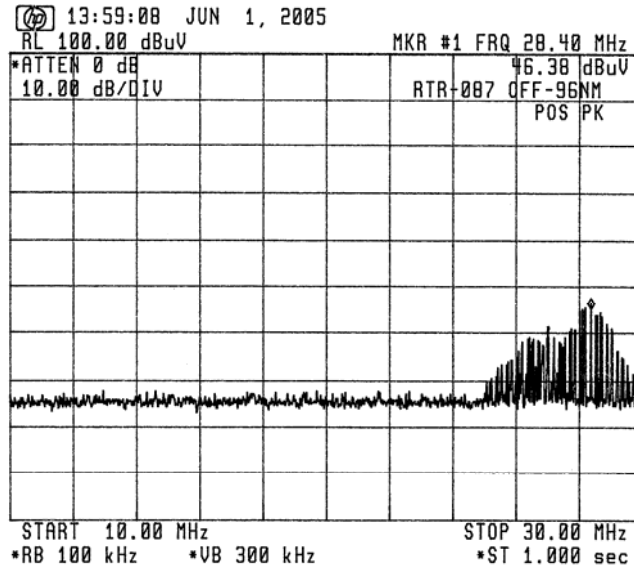


b) Radar TX: ON

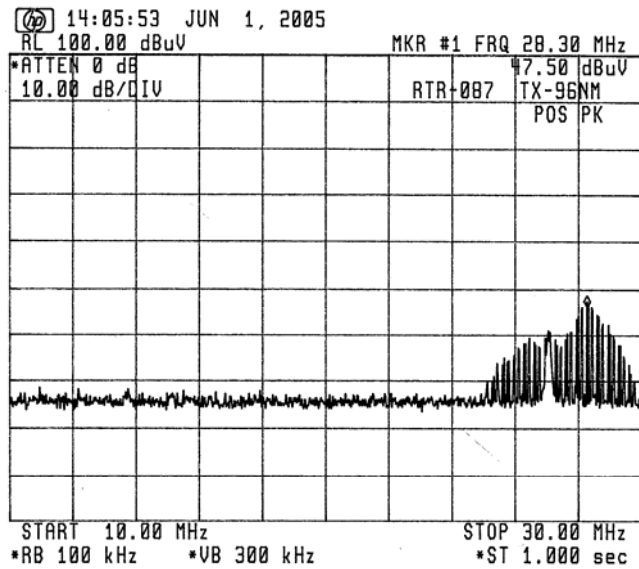


(Band: 10 MHz - 30 MHz)

a) Radar Power: OFF

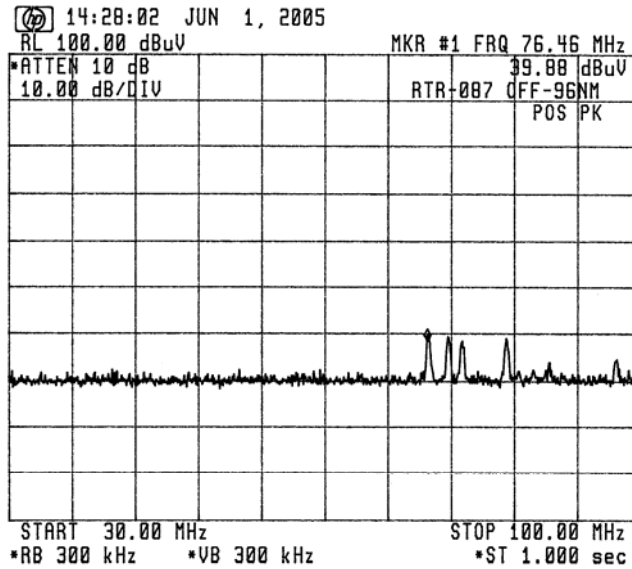


b) Radar TX: ON

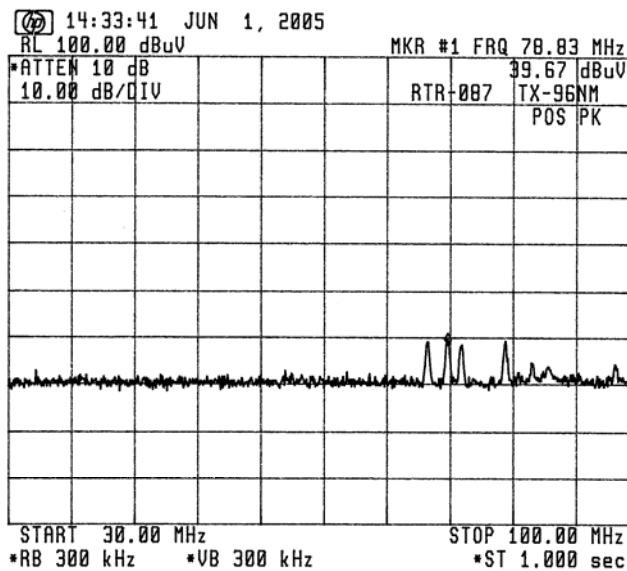


(Band: 30 MHz - 100 MHz)

a) Radar Power: OFF

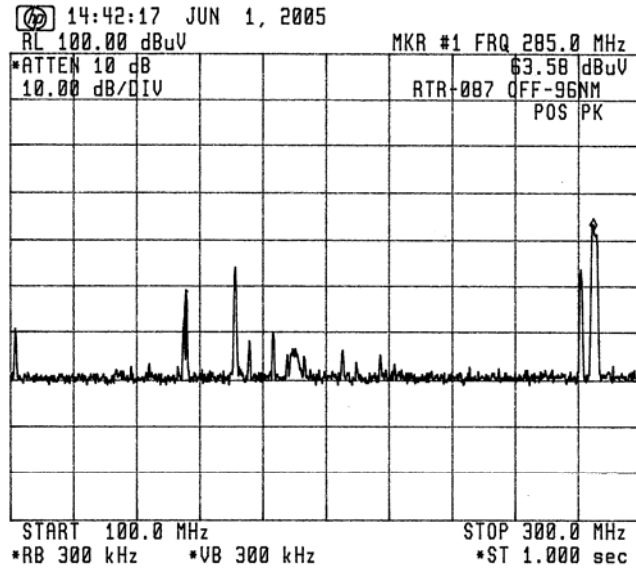


b) Radar TX: ON

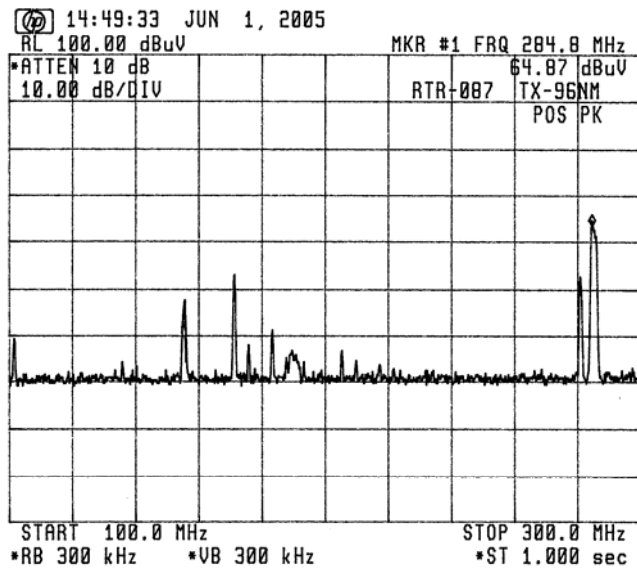


(Band: 100 MHz - 300 MHz)

a) Radar Power: OFF

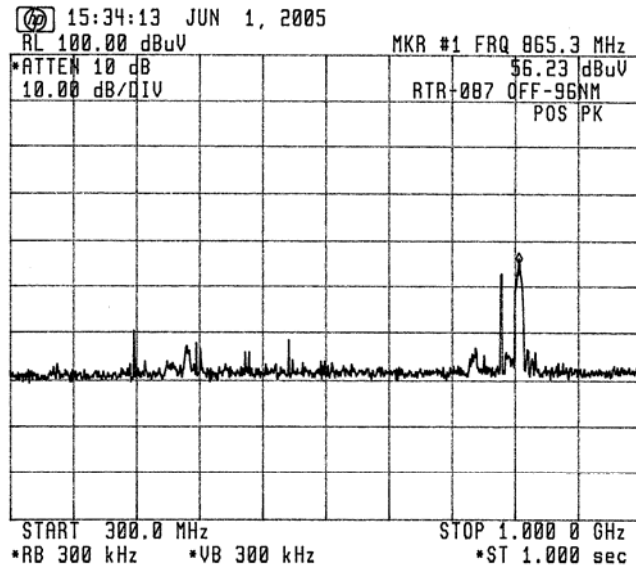


b) Radar TX: ON

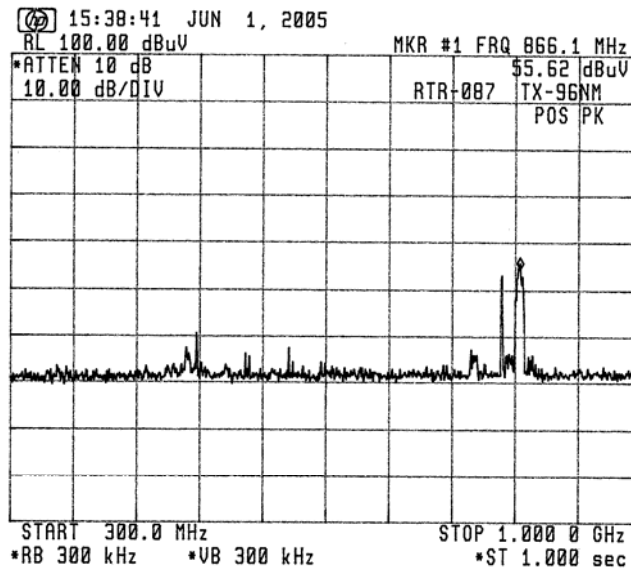


(Band: 300 MHz - 1 GHz)

a) Radar Power: OFF



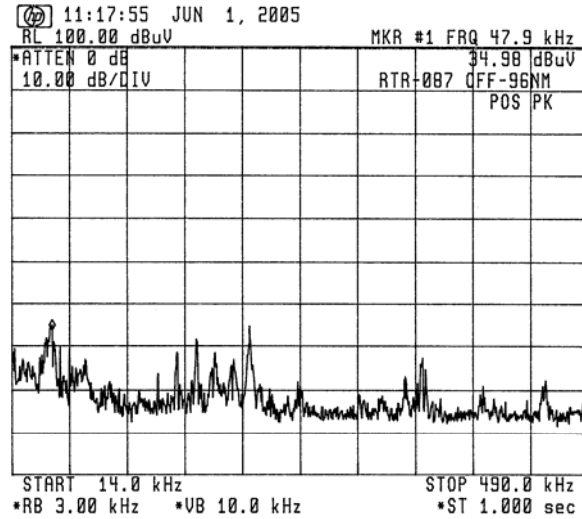
b) Radar TX: ON



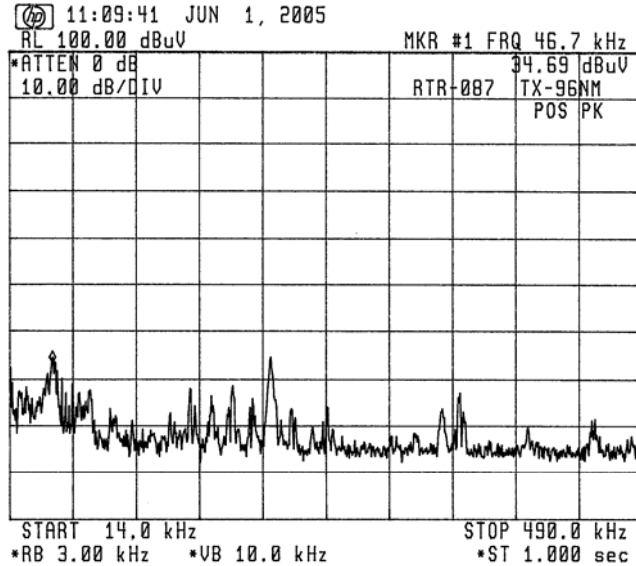
2 Electromagnetic Field

(Band: 14 kHz - 490 kHz, Limit at 1 nm = 0.1  $\mu\text{V}/\text{m}$  = -20 dB $\mu\text{V}/\text{m}$ )

a) Radar Power: OFF



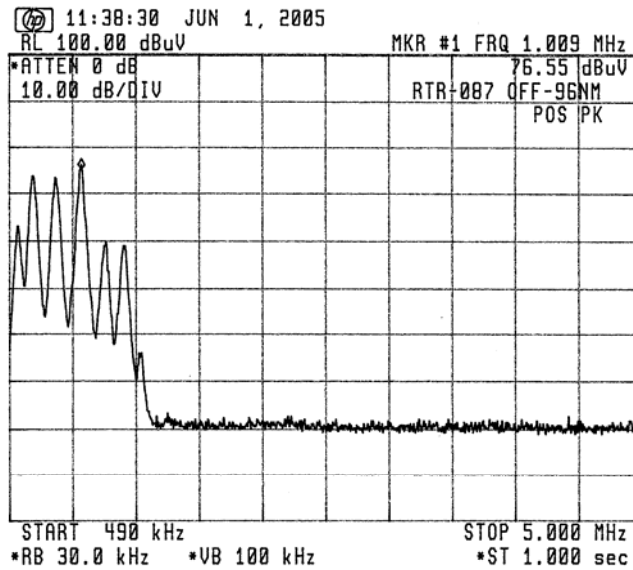
b) Radar TX: ON



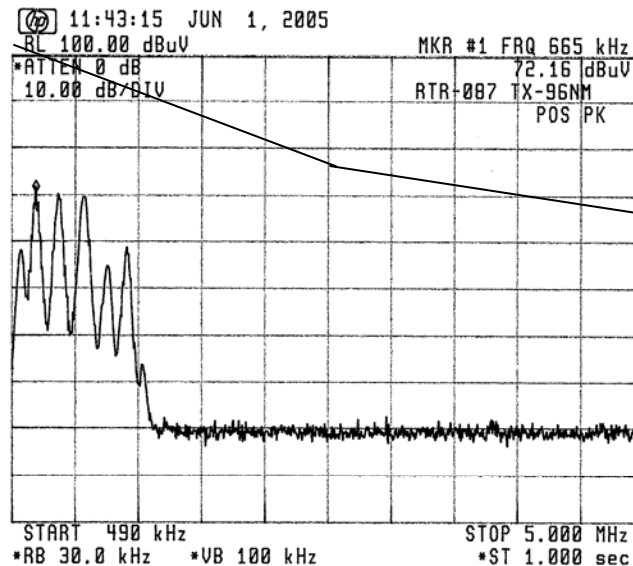
Ref. Level: -26 dB $\mu\text{V}/\text{m}$

(Band: 490 kHz - 5 MHz, Limit at 1 nm = 0.1  $\mu$ V/m = -20 dB $\mu$ V/m)

a) Radar Power: OFF



b) Radar TX: ON



Ref. level (dB $\mu$ V/m)

= 100 - 126 = -26 (at 0.5 MHz)

= 100 - 96 = 4 (at 3 MHz)

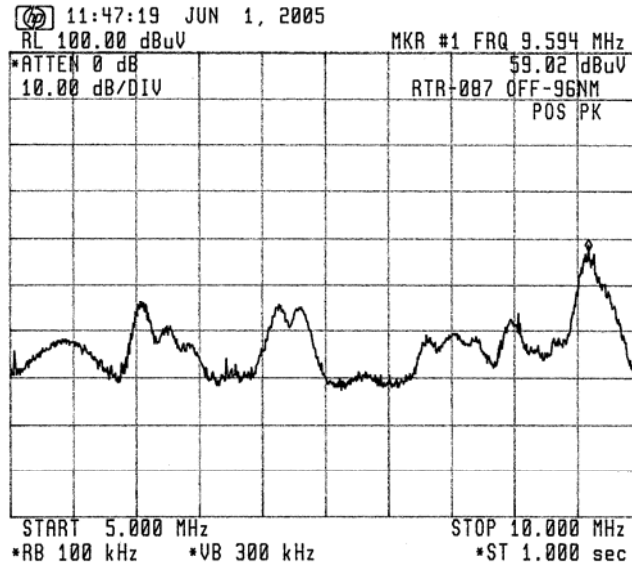
= 100 - 88 = 12 (at 5 MHz)

-20 dB $\mu$ V/m limit line

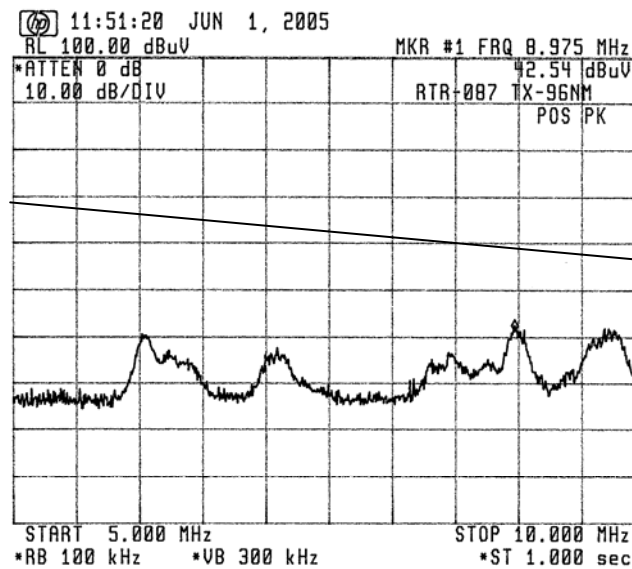


(Band: 5 MHz - 10 MHz, Limit at 1 nm = 0.1  $\mu\text{V}/\text{m}$  = -20 dB $\mu\text{V}/\text{m}$ )

a) Radar Power: OFF



b) Radar TX: ON

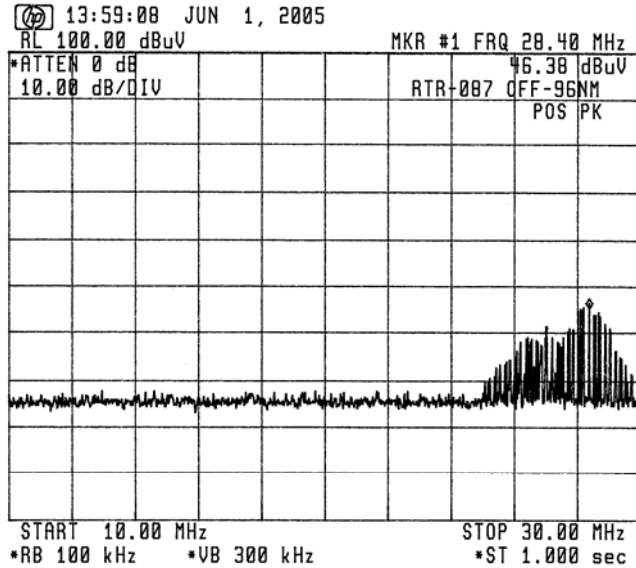


Ref. level (dB $\mu\text{V}/\text{m}$ )  
 = 100 - 88 = 12 (at 5 MHz)  
 = 100 - 83 = 17 (at 7 MHz)  
 = 100 - 78 = 22 (at 10 MHz)

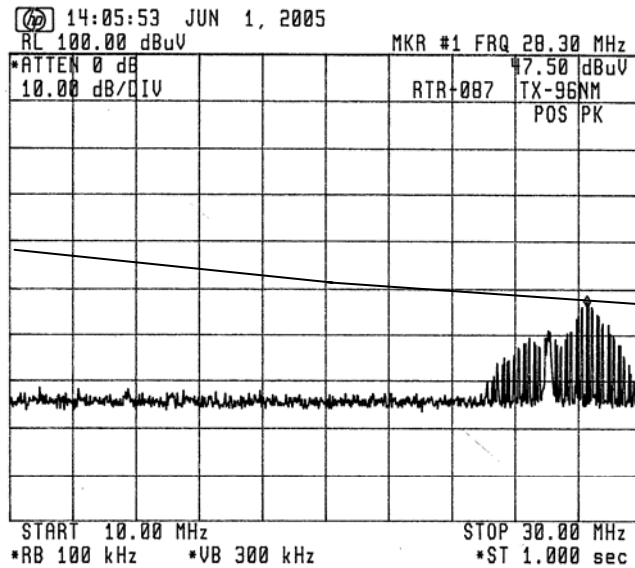
-20 dB $\mu\text{V}/\text{m}$  limit line

(Band: 10 MHz - 30 MHz, Limit at 1 nm = 0.1  $\mu\text{V}/\text{m}$  = -20 dB $\mu\text{V}/\text{m}$ )

a) Radar Power: OFF



b) Radar TX: ON



Ref. level (dB $\mu\text{V}/\text{m}$ )  
 = 100 - 78 = 22 (at 10 MHz)  
 = 100 - 70 = 30 (at 20 MHz)  
 = 100 - 67 = 33 (at 30 MHz)

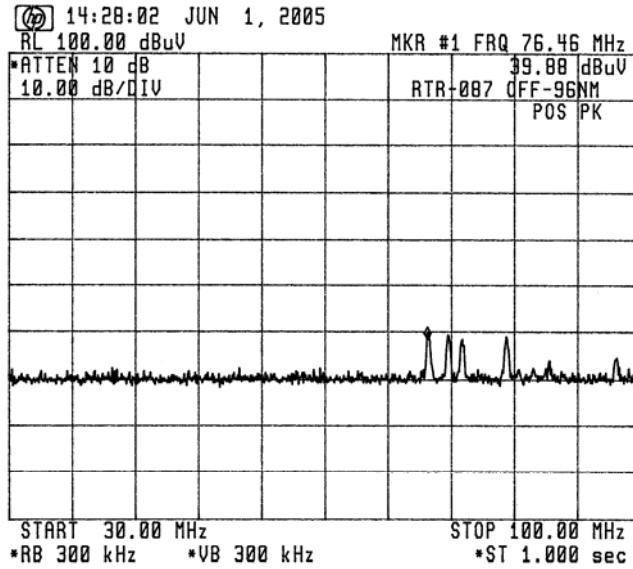
-20 dB $\mu\text{V}/\text{m}$  limit line

Note:

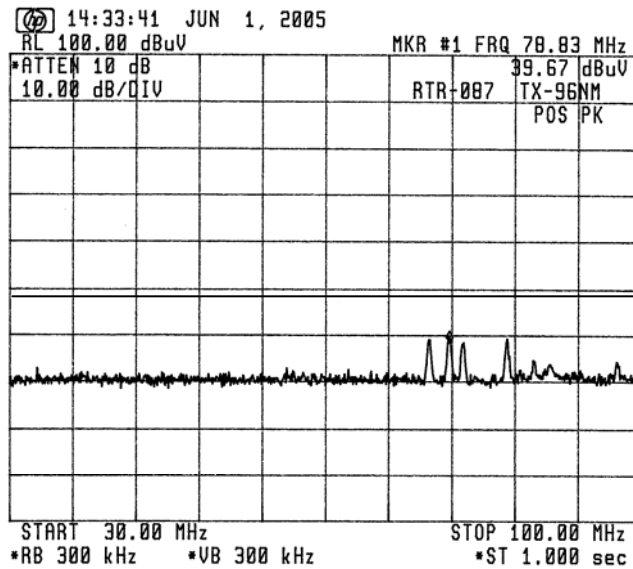
All components above the limit are from external noise or signals, not from Radar.

(Band: 30 MHz - 100 MHz, Limit at 1 nm = 0.1  $\mu\text{V}/\text{m}$  = -10.5 dB $\mu\text{V}/\text{m}$ )

a) Radar Power: OFF



b) Radar TX: ON

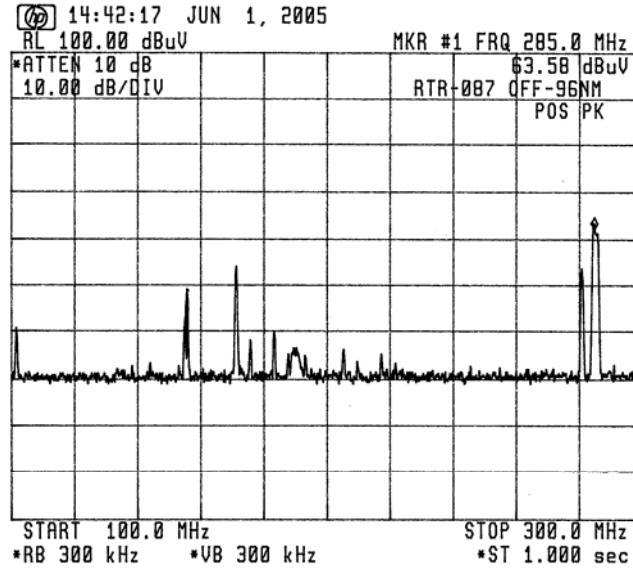


Ref. level (dB $\mu\text{V}/\text{m}$ )  
= 100 - 61 = 39

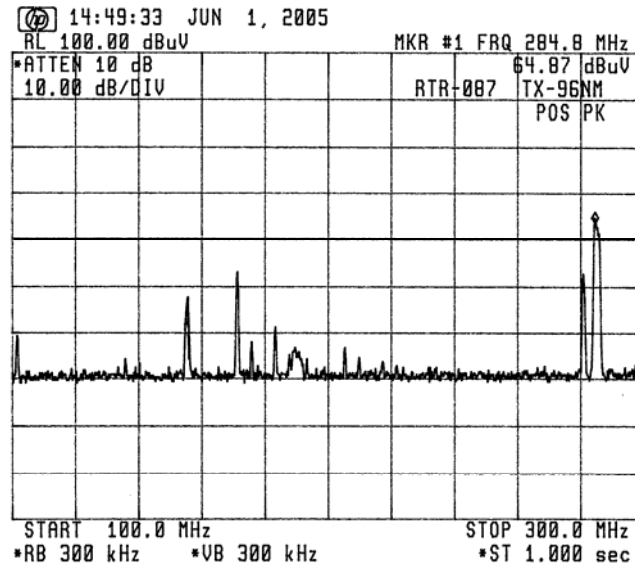
-10.5 dB $\mu\text{V}/\text{m}$  limit line

(Band: 100 MHz - 300 MHz, Limit at 1 nm = 0.1  $\mu\text{V}/\text{m}$  = -0 dB $\mu\text{V}/\text{m}$ )

a) Radar Power: OFF



b) Radar TX: ON



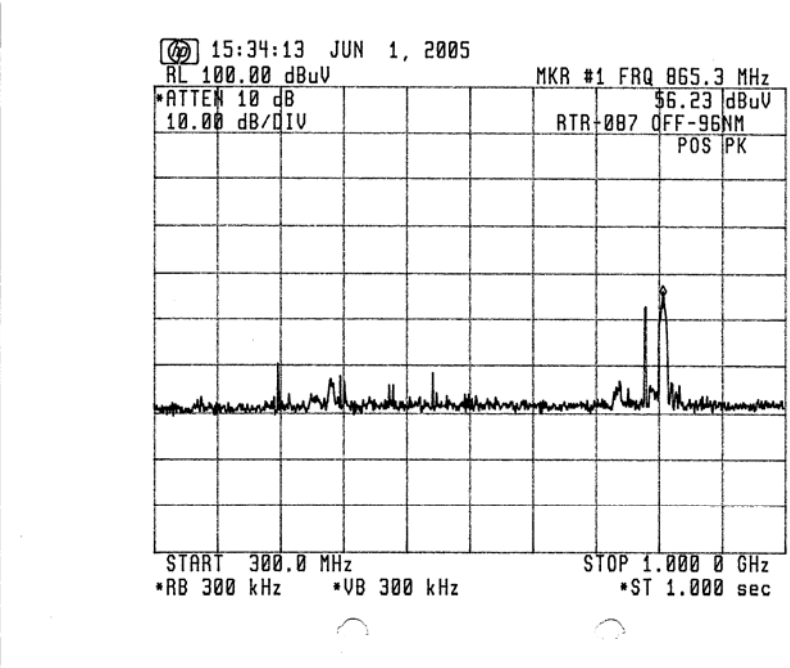
Ref. level (dB $\mu\text{V}/\text{m}$ )  
= 100 - 60 = 40

0 dB $\mu\text{V}/\text{m}$  limit line

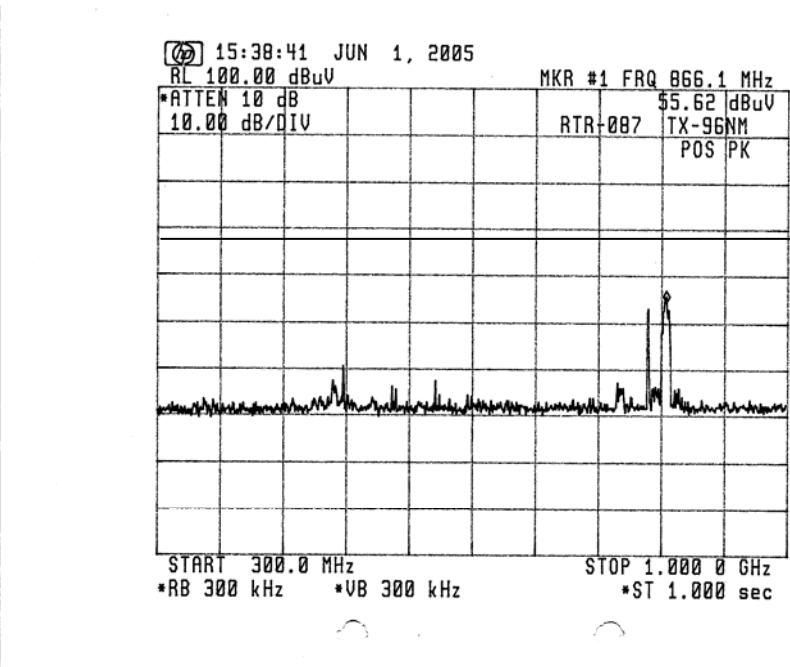
Note:  
All components above the limit  
are from external noise or  
signals, not from Radar.

(Band: 300 MHz - 1 GHz, Limit at 1 nm = 3 μV/m = 9.5 dBμV/m)

a) Radar Power: OFF



b) Radar TX: ON



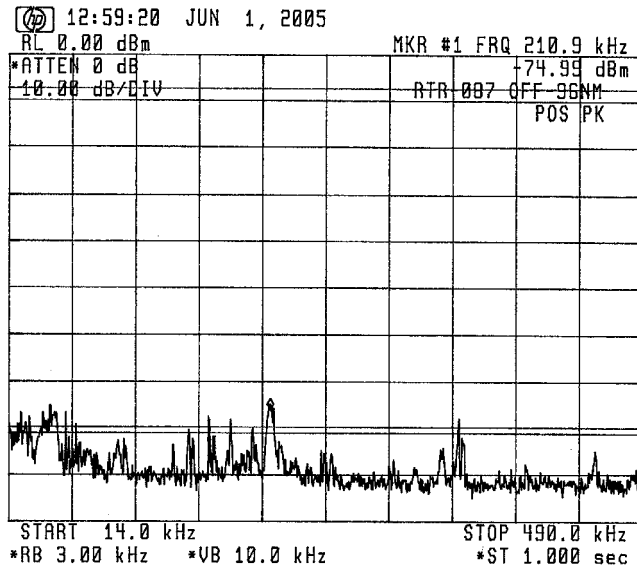
Ref. level (dBμV/m)  
= 100 - 59.5 = 40.5

9.5 dBμV/m limit line

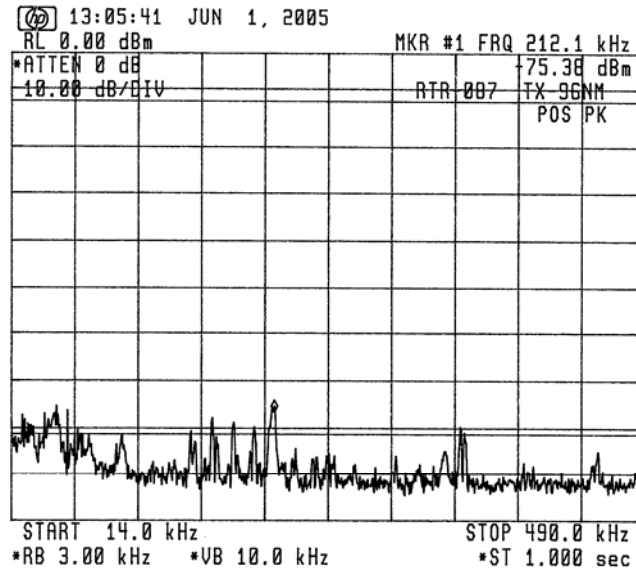
3 Power Input to an Artificial Antenna

(Band: 14 kHz - 490 kHz, Limit at 2 m = -81 dBm)

a) Radar Power: OFF



b) Radar TX: ON

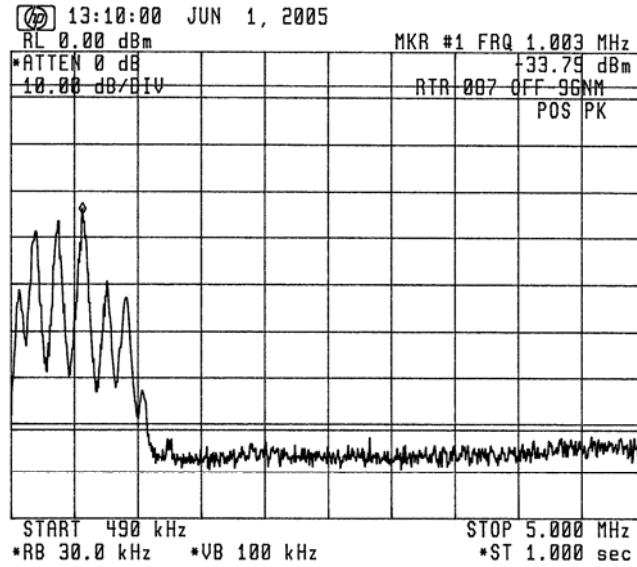


Note:  
All components above the limit  
are from external noise or  
signals, not from Radar.

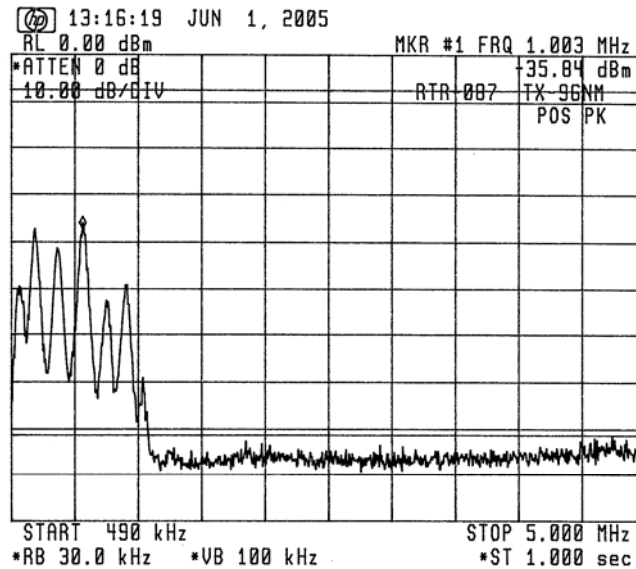
-81 dBm limit line

(Band: 490 kHz - 5 MHz, Limit at 2 m = -81 dBm)

a) Radar Power: OFF



b) Radar TX: ON



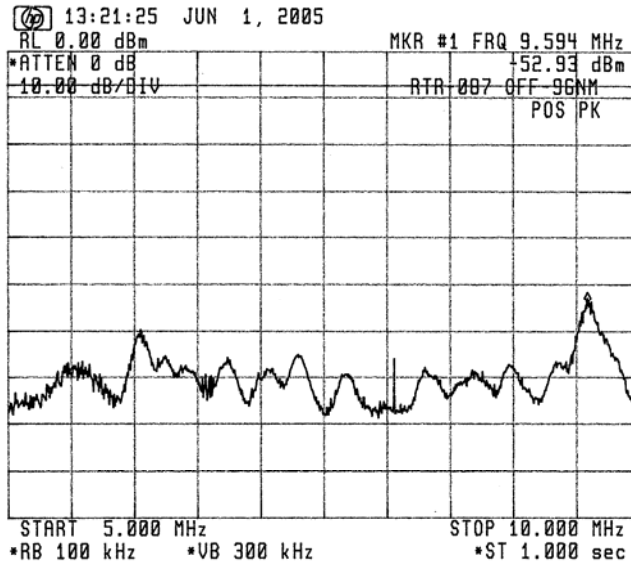
Note:

All components above the limit  
are from external noise or  
signals, not from Radar.

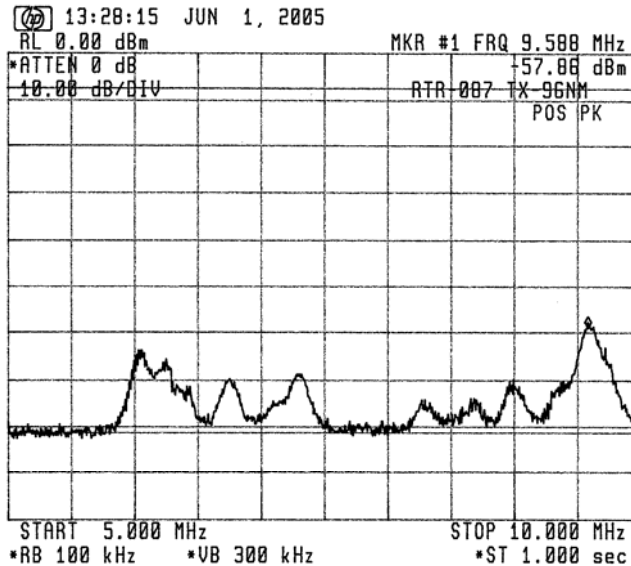
-81 dBm limit line

(Band: 5 MHz - 10 MHz, Limit at 2 m = -81 dBm)

a) Radar Power: OFF



b) Radar TX: ON



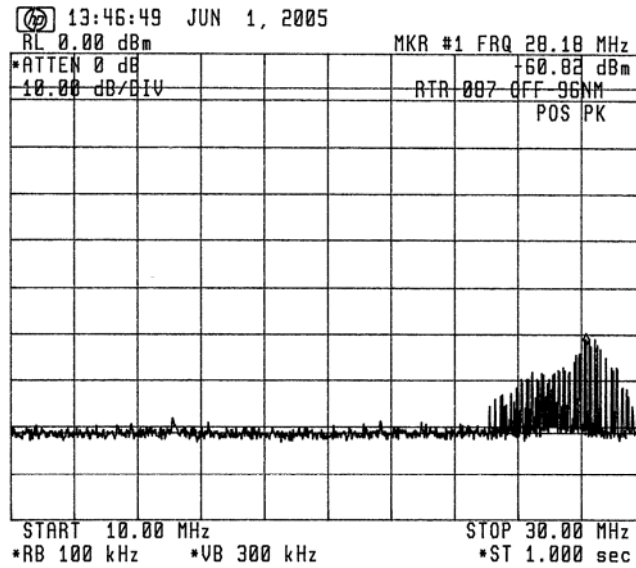
Note:  
All components above the limit  
are from external noise or  
signals, not from Radar.

-81 dBm limit line

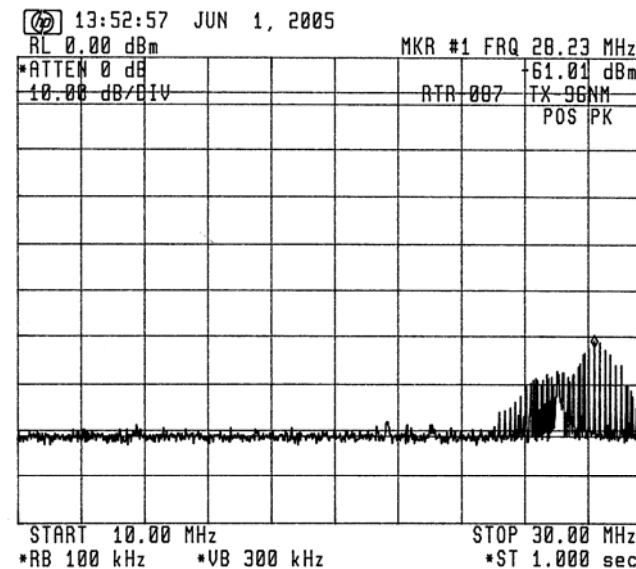


(Band: 10 MHz - 30 MHz, Limit at 2 m = -81 dBm)

a) Radar Power: OFF



b) Radar TX: ON

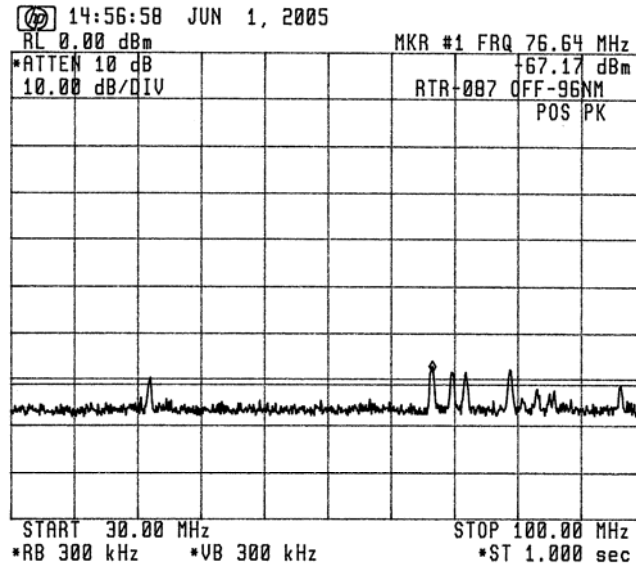


Note:  
All components above the limit  
are from external noise or  
signals, not from Radar.

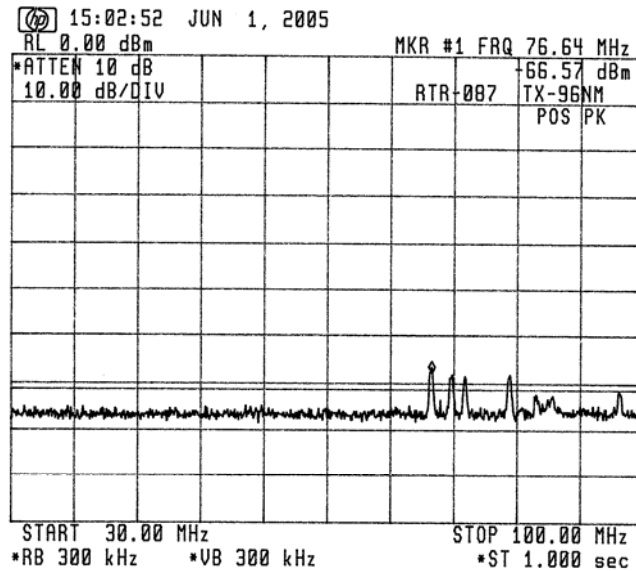
-81 dBm limit line

(Band: 30 MHz - 100 MHz, Limit at 2 m = -71 dBm)

a) Radar Power: OFF



b) Radar TX: ON

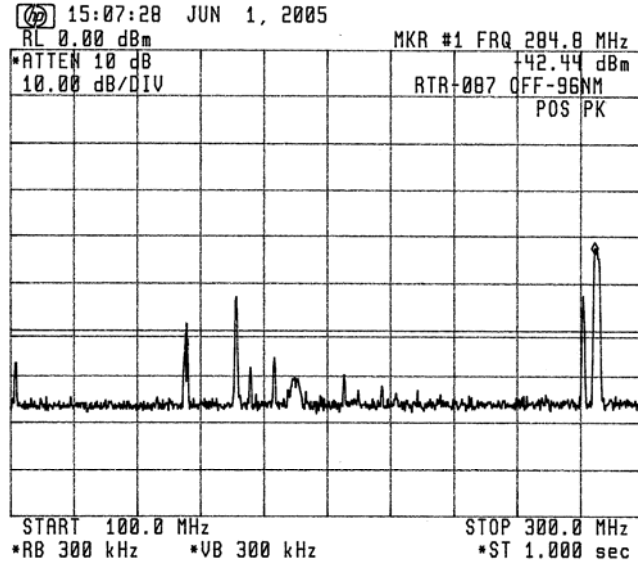


Note:  
All components above the limit  
are from external noise or  
signals, not from Radar.

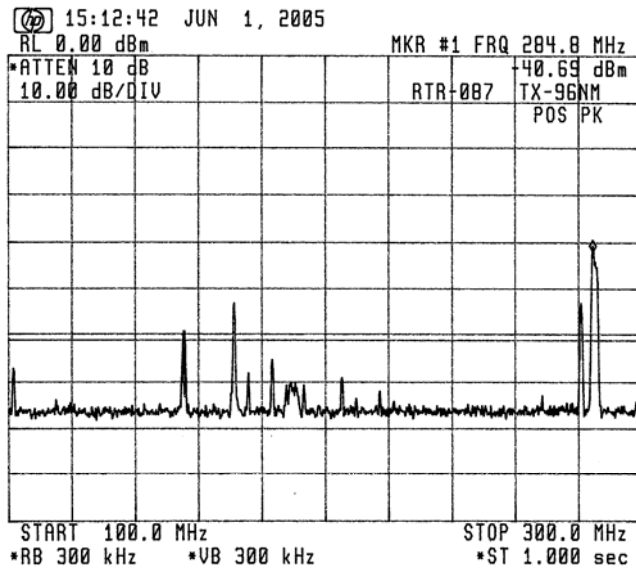
-71 dBm limit line

(Band: 100 MHz - 300 MHz, Limit at 2 m = -61 dBm)

a) Radar Power: OFF



b) Radar TX: ON

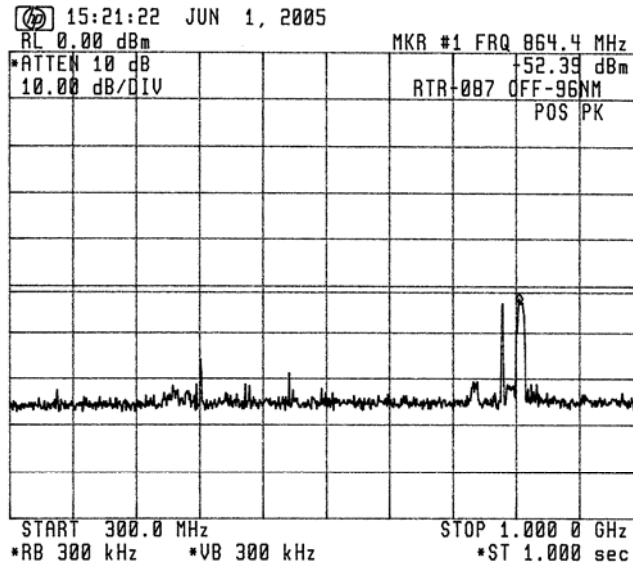


Note:  
All components above the limit  
are from external noise or  
signals, not from Radar.

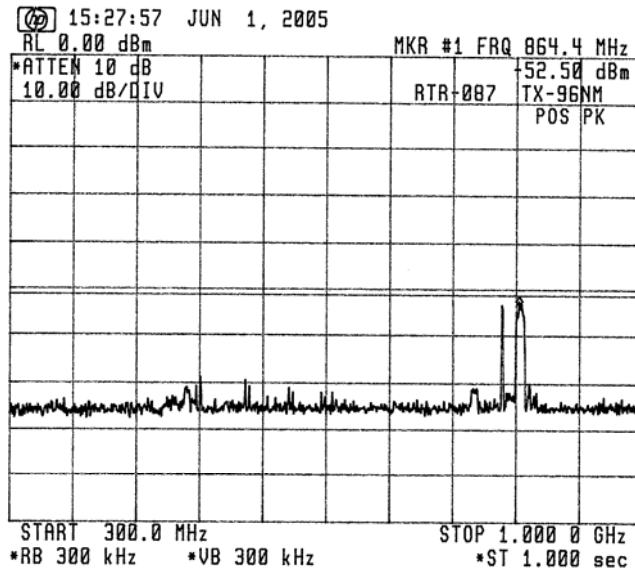
-61 dBm limit line

(Band: 300 MHz - 1 GHz, Limit at 2 m = -51 dBm)

a) Radar Power: OFF



b) Radar TX: ON



-51 dBm limit line

**Attachment D** [ List of Test/Measuring Equipment ] (for X-band radar)

For Clause 3.1 RF Power Output

<u>Model</u>	<u>Type</u>	<u>Serial no.</u>	<u>Mfr.</u>
Spectrum Analyzer	71210C	2927A02847	HP
Oscilloscope	TDS680B	B030202	Tektronix
Directional Coupler	5D364S	R05762	Shimada
Voltage Divider	HV-P30	2780	Iwatsu
Current Transformer	2100	----	Pearson Electronics
Power Meter	436A	2410A19137	HP
Power Sensor	8481A	2349A39603	HP
Frequency Counter	TR5824A	41940036	Advantest
Frequency Meter	X532B	1441A00523	HP
Crystal Detector	423B	1822A19795	HP
Dummy Load	4D376	R05763	Shimada
Attenuator (10 dB step, 70 dB)	8495B	3308A22026	Agilent
Attenuator (1 dB step, 11 dB)	8494B	US00430229	Agilent

For Clause 3.2 Modulation Characteristics

<u>Model</u>	<u>Type</u>	<u>Serial no.</u>	<u>Mfr.</u>
Oscilloscope	TDS680B	B030202	Tektronix
Crystal Detector	423B	1822A19795	HP
Directional Coupler	5D364S	R05762	Shimada
Dummy Load	4D376	R05763	Shimada
Voltage Divider	HV-P30	2780	Iwatsu
Spectrum Analyzer	71210C	2927A02847	HP
Attenuator (10 dB step, 70 dB)	8495B	3308A22026	Agilent
Attenuator (1 dB step, 11 dB)	8494B	US00430229	Agilent

For Clause 3.4 Spurious Emissions at Antenna Terminal

<u>Model</u>	<u>Type</u>	<u>Serial no.</u>	<u>Mfr.</u>
Spectrum Analyzer	71210C	2927A02847	HP
Attenuator (10 dB step, 70 dB)	8495B	3308A22026	Agilent
External Mixer:	11970K	2332A00589	HP
External Mixer:	11970A	2332A01187	HP
Directional Coupler	5D364S	R05762	Shimada
Dummy Load	4D376	R05763	Shimada
Notch Filter (X-band)			
Circulator	MA8L32#82	----	Microwave Associates
Bandpass filter	-----	R9904	Shimada
High Pass Filter (X-band)	-----	-----	Furuno

For Clause 3.5 Field Strength of Spurious Radiation

<u>Model</u>	<u>Type</u>	<u>Serial no.</u>	<u>Mfr.</u>
Broadband Rod Antenna	95010-1		Advanced Electronics
Biconical Antenna	BIA-25	2650	Electro Metrics
Conical Log-Spiral Antenna	LCA-25	2886	Electro Metrics
Double Ridged Guide Horn Antenna :RGA-180		2248	Electro Metrics
Horn Antenna:	----	----	Toshiba
Spectrum Analyzer:	71210C	2927A02847	HP
External Mixer:	11970K	2332A00589	HP
External Mixer:	11970A	2332A01187	HP
Attenuator (10 dB step, 70 dB)	8495B	3308A22026	Agilent
Notch Filter (X-band)			
Circulator	MA8L32#82	----	Microwave Associates
Bandpass filter	-----	R9904	Shimada

For Clause 3.6 Frequency Stability

<u>Model</u>	<u>Type</u>	<u>Serial no.</u>	<u>Mfr.</u>
Power Meter:	436A	2410A19137	HP
Power Sensor:	8481A	2349A39603	HP
Frequency Meter:	X532B	1441A00523	HP
Directional Coupler:	5D364S	R5762	Shimada
Dummy Load:	4D376	R05763	Shimada
Environmental Chamber:	PL-4KP	14004204	Tabai Espec

For Clause 3.7 Suppression of Interference Aboard Ships

<u>Model</u>	<u>Type</u>	<u>Serial no.</u>	<u>Mfr.</u>
Spectrum Analyzer:	71210C	2927A02847	HP
6 m Whip Antenna	14 k - 10 MHz	----	Furuno
4 m Whip Antenna	10 - 30 MHz	----	Furuno
VHF Whip Antenna	30 - 300 MHz	150M-W2UM	Anten
UHF Whip Antenna	300 - 1000 MHz	----	Anten
Network analyzer:	8753C	3214J01067	HP
Spectrum Analyzer	TR4172	30690116	Advantest
Spectrum Analyzer	8566B	2637A03642	HP
Attenuator (10 dB step, 70 dB)	8495B	3308A22026	Agilent