

FURUNO

OPERATOR'S MANUAL

MARINE RADAR

MODEL FR-8062, FR-8122, FR-8252



FURUNO ELECTRIC CO., LTD.
NISHINOMIYA, JAPAN



SAFETY INSTRUCTIONS

WARNING

Radio Frequency Radiation Hazard

The radar antenna emits electromagnetic radio frequency (RF) energy which can be harmful, particularly to your eyes. Never look directly into the antenna aperture from a close distance while the radar is in operation or expose yourself to the transmitting antenna at a close distance.

Distances at which RF radiation levels of 100 and 10 W/m² exist are given in the table below.

Note: If the antenna unit is installed at a close distance in front of the wheel house, your administration may require halt of transmission within a certain sector of antenna revolution. This is possible. Ask your FURUNO representative or dealer to provide this feature.

MODEL		Distance to 100 W/m ² point	Distance to 10 W/m ² point
FR-8062	XN-12A	Nil	Worst case 2.50 m
	XN-13A		Worst case 2.30 m
FR-8122	XN-12A	Worst case 0.50 m	Worst case 7.50 m
	XN-13A	Worst case 0.30 m	Worst case 7.00 m
FR-8252	XN-12A	Worst case 0.80 m	Worst case 9.50 m
	XN-13A	Worst case 0.70 m	Worst case 9.00 m



WARNING



ELECTRICAL SHOCK HAZARD Do not open the equipment.

Only qualified personnel should work inside the equipment.



Turn off the radar power switch before servicing the antenna unit. Post a warning sign near the switch indicating it should not be turned on while the antenna unit is being serviced.

Prevent the potential risk of being struck by the rotating antenna and exposure to RF radiation hazard.



Wear a safety belt and hard hat when working on the antenna unit.

Serious injury or death can result if someone falls from the radar antenna mast.

Do not disassemble or modify the equipment.

Fire, electrical shock or serious injury can result.

Turn off the power immediately if water leaks into the equipment or the equipment is emitting smoke or fire.

Continued use of the equipment can cause fire or electrical shock.



WARNING

Use the proper fuse.

Fuse rating is shown on the equipment. Use of a wrong fuse can result in damage to the equipment.

Keep heater away from equipment.

Heat can alter equipment shape and melt the power cord, which can cause fire or electrical shock.

Do not place liquid-filled containers on the top of the equipment.

Fire or electrical shock can result if a liquid spills into the equipment.

Do not operate the equipment with wet hands.

Electrical shock can result.



WARNING

No one navigational aid should be relied upon for the safety of vessel and crew. The navigator has the responsibility to check all aids available to confirm position. Electronic aids are not a substitute for basic navigational principles and common sense.

- This ARP automatically tracks automatically or manually acquired radar targets and calculates their courses and speeds, indicating them by vectors. Since the data generated by the auto plotter are based on what radar targets are selected, the radar must always be optimally tuned for use with the auto plotter, to ensure required targets will not be lost or unwanted targets such as sea returns and noise will not be acquired and tracked.
- A target does not always mean a land-mass, reef, ships or other surface vessels but can imply returns from sea surface and clutter. As the level of clutter changes with environment, the operator should properly adjust the A/C SEA, A/C RAIN and GAIN controls to be sure target echoes are not eliminated from the radar screen.



CAUTION

The plotting accuracy and response of this ARP meets IMO standards.

Tracking accuracy is affected by the following:

- Tracking accuracy is affected by course change. One to two minutes is required to restore vectors to full accuracy after an abrupt course change. (The actual amount depends on gyrocompass specifications.)
- The amount of tracking delay is inversely proportional to the relative speed of the target. Delay is on the order of 15—30 seconds for high relative speed; 30—60 seconds for low relative speed.

The data generated by ARP, AIS and video plotter are intended for reference only.

Refer to official nautical charts for detailed and up-to-date information.

WARNING LABEL

Warning labels are attached to the equipment. Do not remove any label. If a label is missing or damaged, contact a FURUNO agent or dealer about replacement.

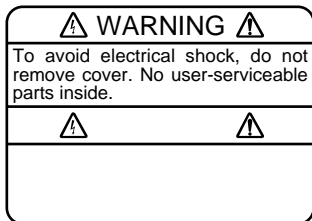

DISPLAY UNIT

Name: Warning Label (1)
Type: 86-003-1011-0
Code No.: 100-236-230

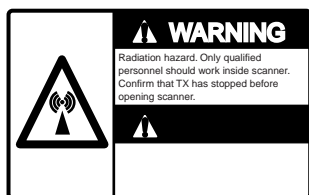

ANTENNA UNIT

Name: Radiation Warning Label
Type: 03-142-3201-0
Code No.: 100-266-890

TFT LCD

The high quality TFT (Thin Film Transistor) LCD displays 99.999% of its picture elements. The remaining 0.01% may drop out or light, however this is an inherent property of the LCD; it is not a sign of malfunction.

TABLE OF CONTENTS

FOREWORD	ix
SYSTEM CONFIGURATION	xi
1. OPERATIONAL OVERVIEW	1-1
1.1 Controls	1-1
1.2 Turning the Radar On/Off, Transmitting	1-4
1.3 Display Indications.....	1-5
1.4 Display Brilliance, Panel Dimmer	1-6
1.5 Menu Overview.....	1-6
1.6 Tuning.....	1-7
1.7 Presentation Modes.....	1-8
1.8 Choosing a Range Scale.....	1-10
1.9 Choosing a Pulse Length	1-11
1.10 Adjusting the Sensitivity.....	1-11
1.11 Suppressing Sea Clutter.....	1-12
1.12 Suppressing Rain Clutter.....	1-13
1.13 Automatic Suppression of Sea and Rain Clutters	1-14
1.14 Cursor.....	1-15
1.15 Interference Rejector	1-16
1.16 Measuring the Range to a Target.....	1-17
1.17 Measuring the Bearing to a Target.....	1-19
1.18 Measuring the Range and Bearing Between Two Targets.....	1-20
1.19 Target Alarm	1-21
1.20 Off Centering the Display	1-24
1.21 Zoom	1-25
1.22 Echo Stretch	1-26
1.23 Echo Averaging	1-27
1.24 Target Trails	1-28
1.25 Parallel Index Lines	1-31
1.26 Outputting Target Position, Inscribing Origin Mark.....	1-32
1.27 Temporarily Hiding the Heading Line, Heading Marker.....	1-33
1.28 Custom Setup.....	1-34
1.29 Programming Function Keys (F1 and F2 keys)	1-36
1.30 Noise Rejector	1-36
1.31 Suppressing Second-trace Echoes	1-37
1.32 Watchman	1-37
1.33 Color Schemes	1-38
1.34 Navigation Data	1-39
1.35 Dynamic Range	1-41
1.36 Characteristics Curve	1-42
1.37 Antenna Speed.....	1-42
1.38 Waypoint Mark.....	1-43
1.39 Alarm Message Display.....	1-44
1.40 Echo Area	1-45
1.41 Customizing (Initial Menu)	1-46
2. RADAR OBSERVATION	2-1
2.1 General.....	2-1
2.2 False Echoes.....	2-3
2.3 SART (Search and Rescue Transponder).....	2-5
2.4 RACON.....	2-6

3. ARP OPERATION	3-1
3.1 Usage Precautions	3-1
3.2 Controls for Use with ARP	3-2
3.3 ARP Display On/Off	3-2
3.4 Acquiring and Tracking Targets	3-3
3.5 Terminating Tracking of ARP Targets	3-4
3.6 Vector Attributes.....	3-5
3.7 History Display (target past position)	3-6
3.8 ARP Target Data	3-7
3.9 CPA and TCPA Alarm	3-8
3.10 Proximity Alarm	3-9
3.11 Lost Target	3-9
3.12 Symbol Color.....	3-10
4. AIS OPERATION.....	4-1
4.1 Controls for Use with AIS	4-1
4.2 Activating, Deactivating the AIS Function	4-1
4.3 Turning the AIS Display On or Off.....	4-2
4.4 AIS Symbols.....	4-2
4.5 Activating Targets	4-2
4.6 Displaying AIS Target Data	4-3
4.7 Display Range.....	4-4
4.8 Sorting Targets.....	4-4
4.9 Display Sector	4-5
4.10 Number of Targets to Display	4-5
4.11 Vector Attributes.....	4-6
4.12 History Display (target past position)	4-7
4.13 CPA and TCPA Alarm	4-8
4.14 Proximity Alarm	4-9
4.15 Lost Target	4-9
4.16 Symbol Color.....	4-10
5. GPS OPERATION	5-1
5.1 Navigator Type.....	5-1
5.2 Datum.....	5-2
5.3 WAAS Setup	5-2
5.4 Satellite Monitor	5-3
5.5 Type 16 Message.....	5-4
5.6 GPS Sensor Installation Position Offset.....	5-5
5.7 Cold Start	5-6
6. MAINTENANCE & TROUBLESHOOTING	6-1
6.1 Preventive Maintenance.....	6-2
6.2 Replacement of Fuses	6-3
6.3 Replacing the Magnetron	6-3
6.4 Trackball Maintenance	6-4
6.5 Simple Troubleshooting	6-5
6.6 Advanced-level Troubleshooting.....	6-6
6.7 System Test	6-8
6.8 LCD Test	6-10
6.9 GPS Test.....	6-11
6.10 Clearing the Memory	6-12
SPECIFICATIONS.....	SP-1
INDEX.....	IN-1

FOREWORD

A Word to the Owner of the FR-8xx2 Marine Radar

FURUNO Electric Company thanks you for purchasing the FR-8xx2 Color LCD Marine Radar series. We are confident you will discover why the FURUNO name has become synonymous with quality and reliability.

For over 50 years FURUNO Electric Company has enjoyed an enviable reputation for quality and reliability throughout the world. This dedication to excellence is furthered by our extensive global network of agents and dealers.

Your equipment is designed and constructed to meet the rigorous demands of the marine environment. However, no machine can perform its intended function unless properly installed and maintained. Please carefully read and follow the operation and maintenance procedures set forth in this manual.

We would appreciate feedback from you, the end-user, about whether we are achieving our purposes.

Thank you for considering and purchasing FURUNO.

Features

The FR-8xx2 series display radar targets on a bright 12.1" color LCD. Operation is simplified with the combination of discrete keys and trackball.

The main features are as follows:

- The FR-8xx2 series consists of the following models:

Model, output, max, range, antenna type

Model	Output	Range	Radar Antenna
FR-8062	4.9 kW	72 nm/sm, 96 km	4 or 6 ft radiator
FR-8122	12 kW	72 nm/sm, 96 km	4 or 6 ft radiator
FR-8252	25 kW	96 nm/km/sm	4 or 6 ft radiator

- Bright 12.1" LCD visible even under direct sunlight
- User-friendly operation with combination of discrete keys, soft keys, and trackball
- Antenna speed may be automatically selected according to pulse length or speed
- Built in ARP optionally available
- AIS data shown with connection of AIS transponder
- User programmable function keys
- One touch setup of major controls with custom setup feature
- Echoes in yellow or green or colors of red, yellow or green in order of descending strength.

Notice

- No part of this manual may be copied or reproduced without written permission.
- This manual is lost or worn, contact your dealer about replacement.
- The contents of this manual and equipment specifications are subject to change without notice.
- The example screens (or illustrations) shown in this manual may not match the screens you see on your display. The screen you see depends on your system configuration and equipment settings.
- This manual is intended for use by native speakers of English.
- FURUNO will assume no responsibility for the damage caused by improper use or modification of the equipment or claims of loss of profit by a third party.

SYSTEM CONFIGURATION

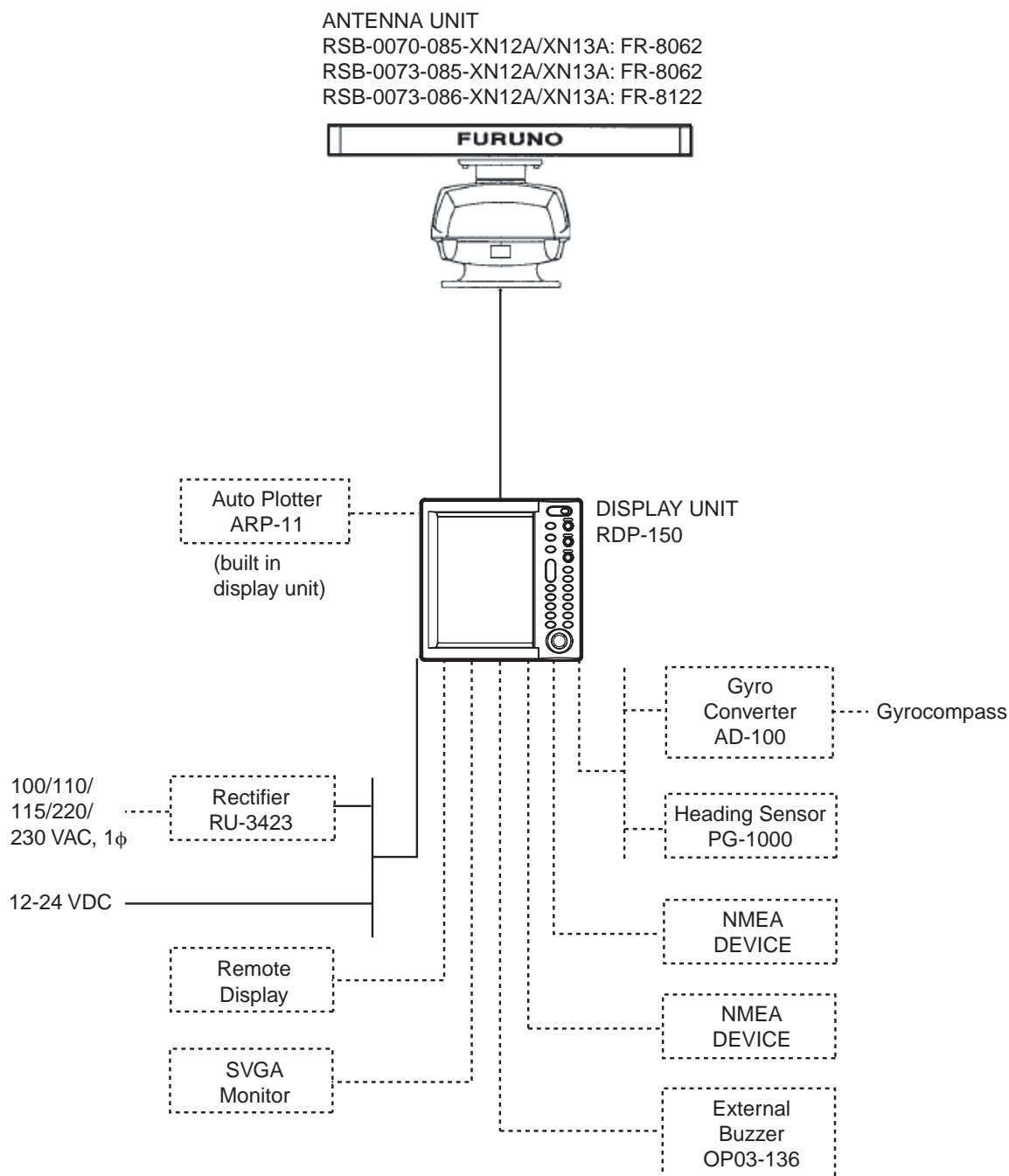

Category of units

Antenna unit: Exposed to weather

All other units: Protected from weather

----- : Optional equipment

FR-8062/8122

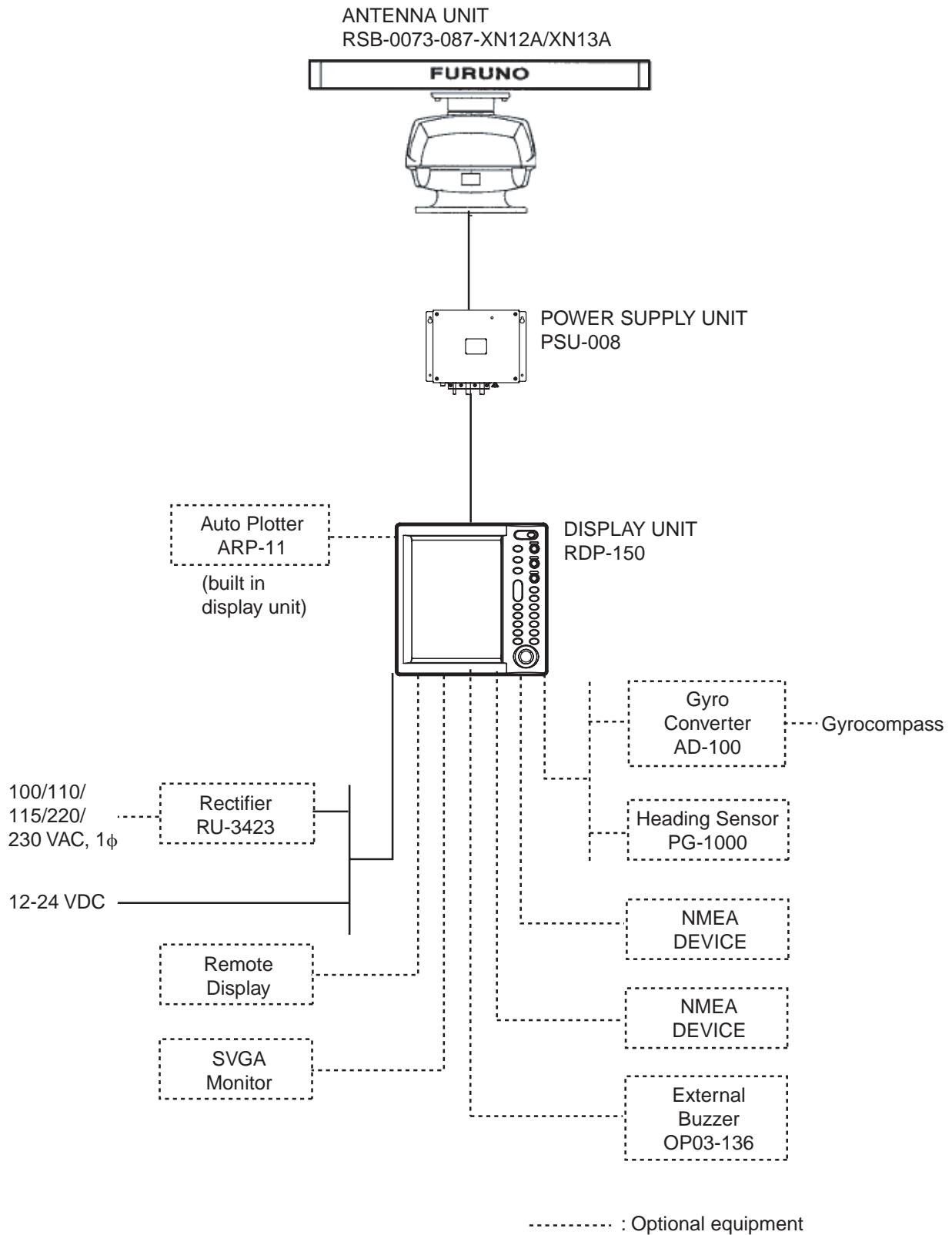

Category of units

Antenna unit: Exposed to weather

All other units: Protected from weather

1. OPERATIONAL OVERVIEW

This chapter provides the information necessary for operating this radar.

1.1 Controls

1.1.1 Display unit

This radar is operated with the controls of the display unit (and the remote controller). 17 keys are labeled and they provide the function shown on their labels. The trackball's main function is to move the cursor across the screen. When you correctly execute an operation, the unit generates a beep. Invalid operation causes the unit to emit several beeps.

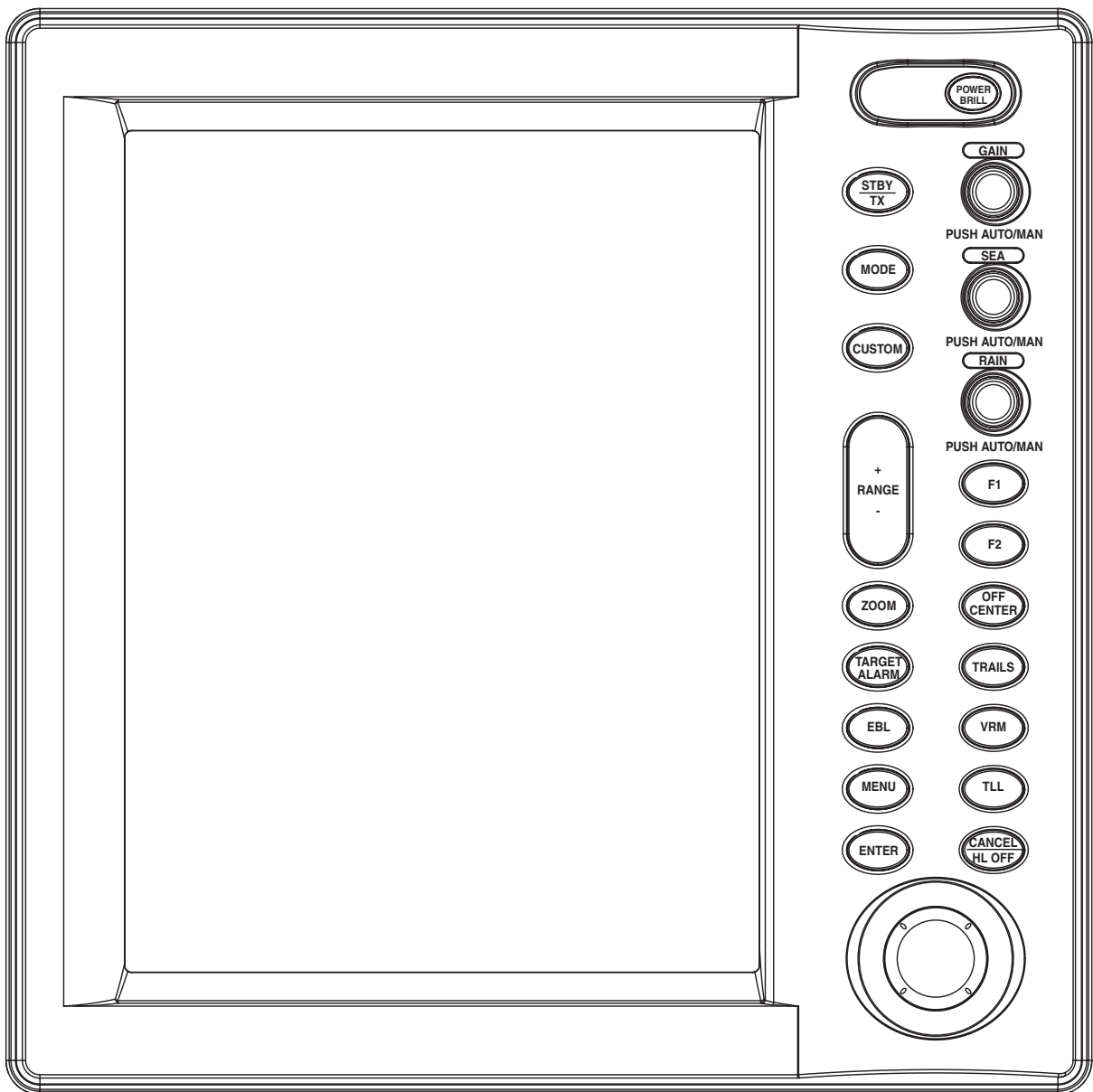

Display unit

1. OPERATIONAL OVERVIEW

Control description

Control	Description
POWER/BRILL	Momentary press: Turns power on; adjusts brilliance. Long press: Turns power off.
STBY/TX	Transmits radar pulses and places radar in standby alternately.
MODE	Chooses presentation mode.
CUSTOM	Presets radar controls for one-touch setup of radar.
RANGE	Chooses radar range.
ZOOM	Zooms chosen target.
TARGET ALARM	Sets target alarm, which watches for targets entering or exiting the user-set alarm zone.
EBL	Measures bearing to a radar target.
MENU	Open/closes the menu.
ENTER	Registers chosen menu option; acquires ARP target; displays data of selected ARP or AIS target.
GAIN	Adjusts the sensitivity of the radar receiver.
SEA	Suppresses sea clutter.
RAIN	Suppresses rain clutter.
F1, F2	Programmable function keys.
OFF CENTER	Shifts own ship position.
TRAILS	Plots radar echo movement.
VRM	Measure range to a radar target.
TLL	Outputs position of chosen target to navigation plotter or inscribes mark at cursor location, or both.
CANCEL/HL OFF	Cancels last entry in menu operation; temporarily erases heading line; cancels tracking of ARP target; removes data of selected ARP or AIS target from data box; goes back one "layer" in multi-layer menu.
Trackball	Chooses menu items; shifts display and cursor.

1.1.2 Remote controller

The remote controller provides armchair control over transmit, standby, range and display offcentering.

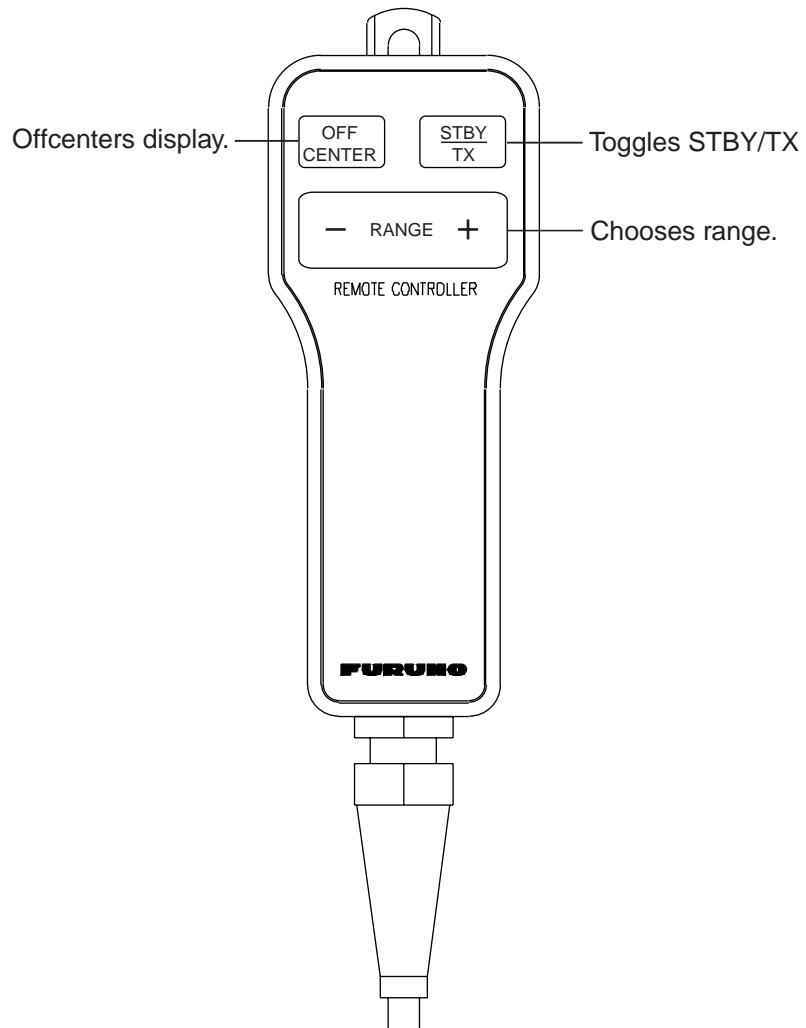

Remote controller

1.2 Turning the Radar On/Off, Transmitting

Press the **POWER/BRILL** key at the upper right-hand corner of the control panel to turn on the radar on. Press and hold down the key until the screen turns black to turn the radar off.

At power-up the start-up screen appears as shown right. The model name and program number are shown and the ROM and RAM are tested. If "NG" appears as the results of the ROM and RAM tests, try pressing any key to proceed. If normal operation is not possible, contact your dealer for advice. After the tests are completed, the bearing scale and a digital timer appear. The digital timer counts down the time remaining to warm up the magnetron, which transmits the radar pulses. This warm-up takes 90 sec. (FR-8252) or 180 sec. (FR-8062, FR-8122).

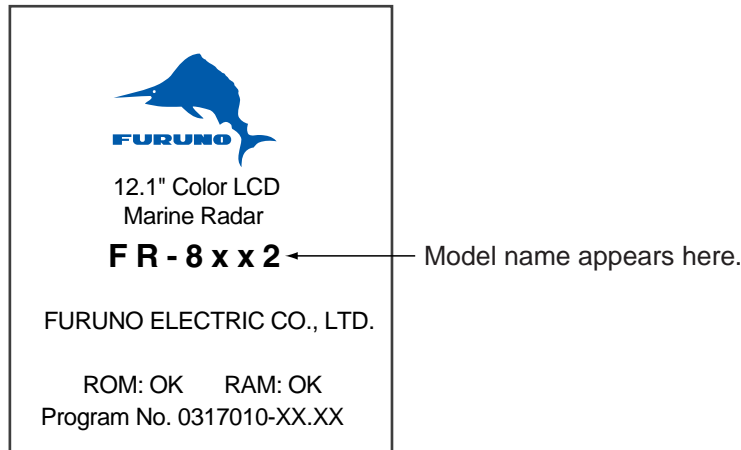

Start-up screen

After the timer has counted down to 0:00, the indication STBY appears at the screen center, meaning the radar is now ready to transmit radar pulses. Press the **STBY/TX** key to transmit radar pulses.

The **STBY/TX** key toggles between stand-by and transmit status. The antenna rotates in transmit condition and is stopped in standby. Because the magnetron ages with use it is highly recommended to set the radar in standby when it will not be required for an extended period of time. This will help extend the life of the magnetron.

Quick start

Provided that the radar was once in use with the transmitter tube (magnetron) still warm, you can get the radar into TRANSMIT condition without the warm-up. If the **POWER/BRILL** key was turned off by mistake or the like and you wish to restart the radar promptly, turn on the **POWER/BRILL** key not later than 10 seconds after power-off. **This feature is not available with the FR-8252.**

1.3 Display Indications

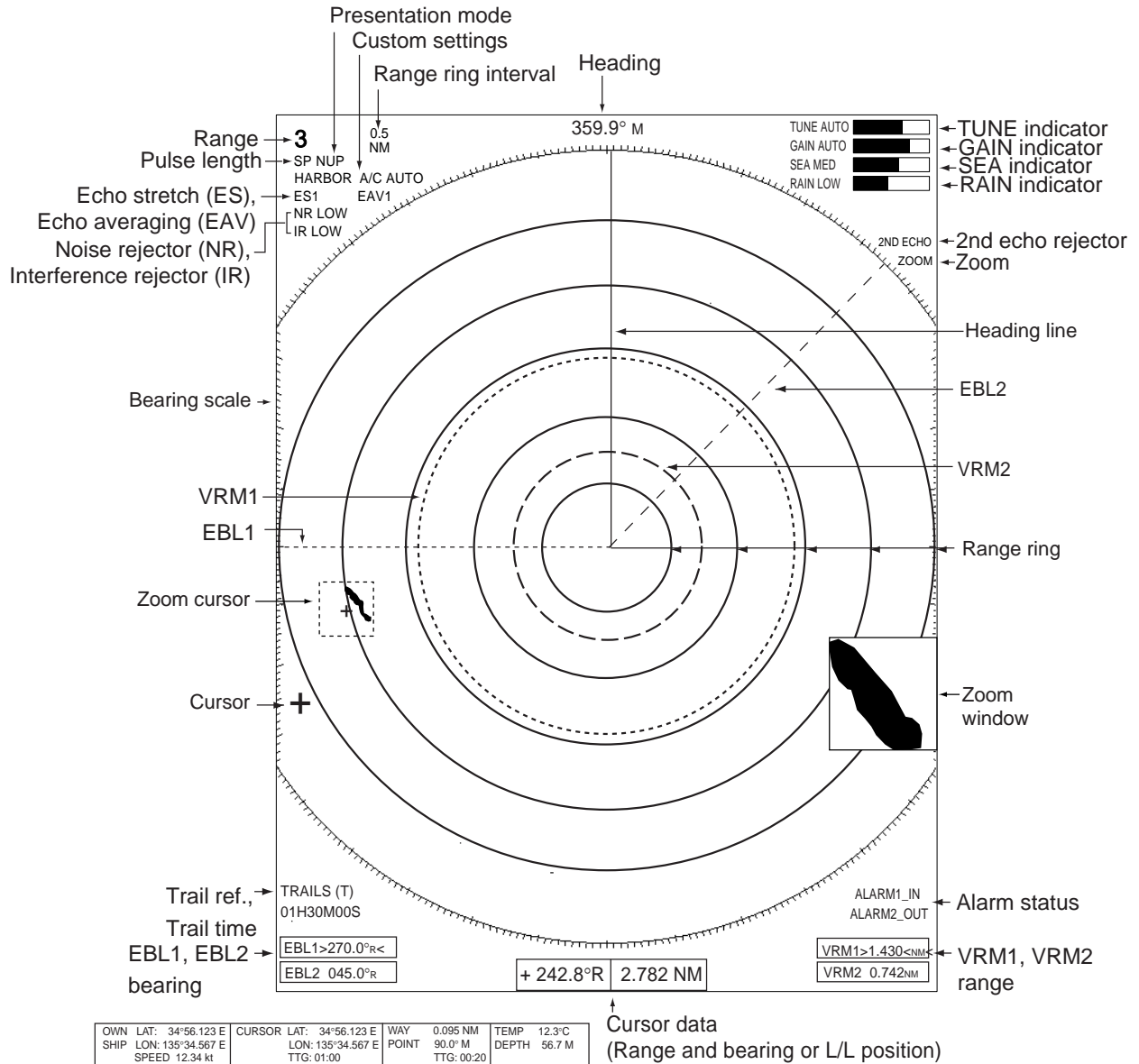

Nav data: Appears at screen bottom when Data Box in the Display sub menu is set to "Nav" or "All". Appropriate sensors required to display nav data.

Display indications

Note: The screen configuration, chosen during the installation, is available in three types, "Sea", "River" and "IEC", and the default configuration is "Sea". The majority of the descriptions in this manual use the "Sea" configuration. The major difference between the Sea, River and IEC configurations is the bearing scale - it is elliptical on the Sea and River types and circular on the IEC type.

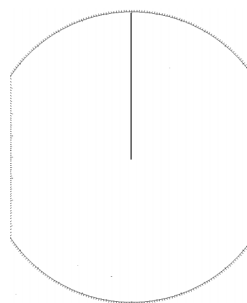

Bearing scale for Sea and River configurations

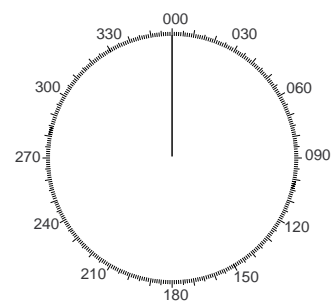

Bearing scale for IEC configuration

1.4 Display Brilliance, Panel Dimmer

The display brilliance and panel dimmer may be adjusted as follows:

1. Press the **POWER/BRILL** key momentarily to show the brilliance/panel dialog box.

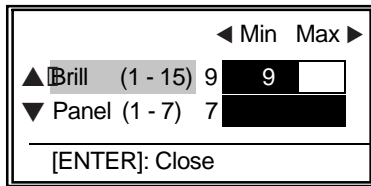

Brilliance/panel dimmer dialog box

2. Roll the trackball upward or downward to choose Brill or Panel, whichever you wish to adjust.
3. Roll the trackball rightward or leftward to adjust. (You may also use the **POWER/BRILL** key.)
4. Press the **MENU** key to close the window.

1.5 Menu Overview

Less-often used functions are controlled through the menu, which consists of 14 menus and 3 sub menus. Use the trackball to choose item and option as below.

1. Press the **MENU** key to display the menu.

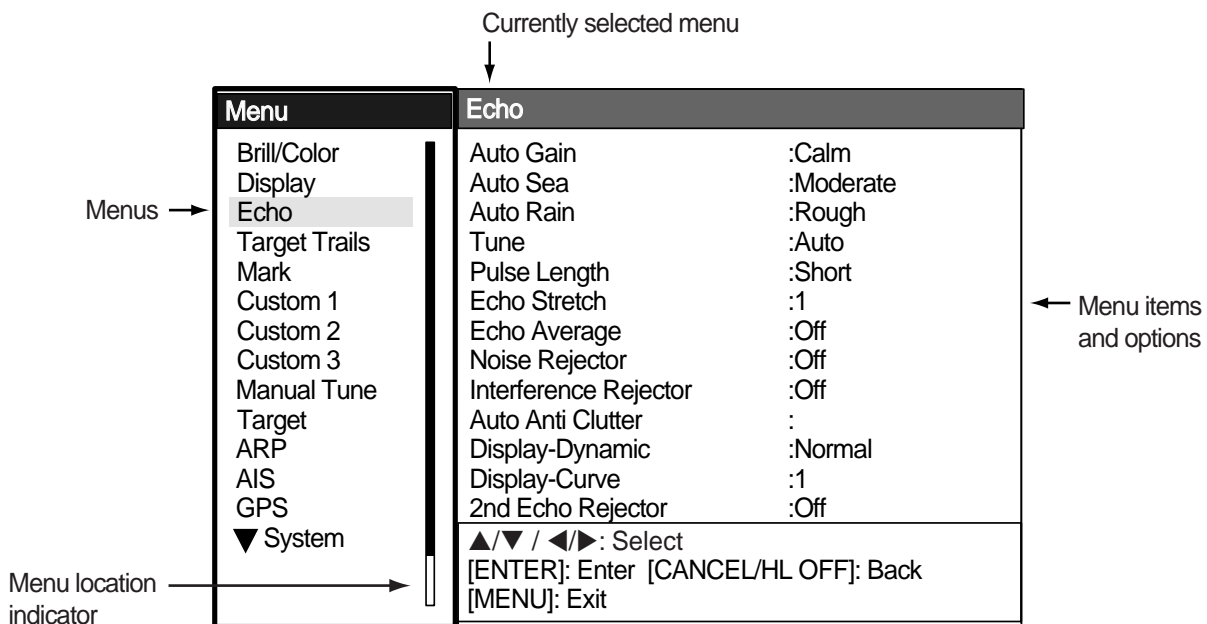

Menu

2. Roll the trackball to choose a menu or sub menu. As you roll the trackball, the highlight in the Menu column indicates menu currently selected and the menu items change according to the menu selected.
3. Press the **ENTER** key to enable operation from chosen menu.

- Roll the trackball to choose the menu item desired and then press the **ENTER** key. A window with options for the corresponding menu item appears. For example, the window below shows the options for Trail Color in the Target Trails menu.

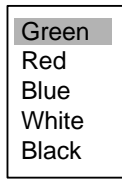

Target trails color options

- Roll the trackball upward or downward to choose appropriate option.
- Press the **ENTER** key to save your selection.
- Press the **MENU** key to close the menu.

Note: The menus on the IEC-type radar close automatically when there is no menu operation for 10 seconds, as per IEC regulations. The following menus and screens however are exempt from this rule: Alarm message, GPS self test, Satellite monitor, TYPE 16 message, Diagnostic, LCD pattern, and Tune initial adjust. Menus do not close automatically in the “River” or “Sea” configuration.

1.6 Tuning

The radar receiver can be tuned automatically or manually, and the default tuning method is automatic. If you require manual tuning, do the following:

- Use the **RANGE** key to choose the 48-mile range.
- Press the **MENU** key to display the main menu.
- Use the trackball to choose Echo and then press the **ENTER** key.
- Use the trackball to choose Tune Mode and then press the **ENTER** key.

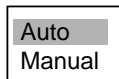

Tuning options

- Choose Manual and then press the **ENTER** key.
- Choose Manual Tune and then push the **ENTER** key. The window shown below appears.

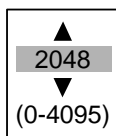

- Roll the trackball upward or downward to adjust the tuning, watching the tuning bar at the top right corner. The best tuning point is where the bar graph swings maximum. The vertical bar on the bar graph shows tuning control position; not the tuning condition.

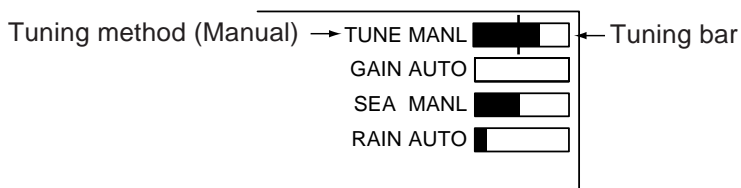

Tuning indicator

- Push the **ENTER** key to finish.
- Press the **MENU** key to close the menu.

1.7 Presentation Modes

This radar has the following presentation modes:

Relative Motion (RM)

Head-up: Unstabilized

Head-up TB: Head-up with compass-stabilized bearing scale (True Bearing) where bearing scale rotates with the compass reading.

Course-up: Compass-stabilized relative to ship's orientation at the time of electing course-up.

North-up: Compass-stabilized with reference to north

True Motion (TM)

North-up: Ground or sea stabilized with compass and speed inputs

1.7.1 Choosing presentation mode

Press the **MODE** key consecutively to choose presentation mode desired. The presentation mode in use appears at the top left corner on the screen.

NOTICE - Loss of gyrocompass signal: When the compass signal is lost, "HEADING" appears in red at the gyro readout, the presentation mode automatically becomes head-up, all ARP and AIS targets and map or chart are erased. After restoring the compass signal, choose the presentation mode with the **MODE** key.

1.7.2 Description of presentation modes

Head-up mode

The head-up mode is a display in which the line connecting own ship and the top of the display indicates own ship's heading.

The target pips are painted at their measured distances and in their directions relative to own ship's heading.

A short line on the bearing scale is the north marker indicating heading sensor north. A failure of the heading sensor input will cause the north marker to disappear and the readout to show *****.*** and the message **SIGNAL MISSING** appears in red at the lower-right corner of the screen.

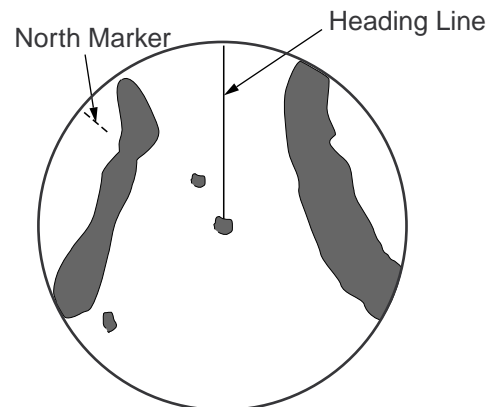

Course-up mode

The course-up mode is an azimuth stabilized display in which a line connecting the center with the top of the display indicates own ship's intended course (namely, own ship's previous heading just before this mode has been selected).

Target pips are painted at their measured distances and in their directions relative to the intended course, which is maintained at the 0-degree position. The heading line moves in accordance with ship's yawing and course change. This mode is useful to avoid smearing of picture during course change.

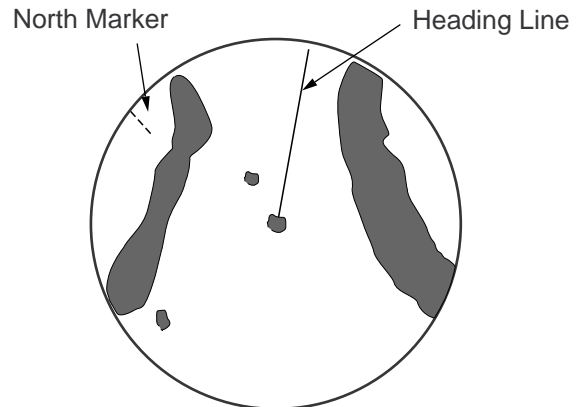
**Head-up TB (True Bearing) mode**

Radar echoes are shown in the same way as in the head-up mode. The difference from normal head-up presentation lies in the orientation of the bearing scale. The bearing scale is heading sensor stabilized. That is, it rotates in accordance with the heading sensor signal, enabling you to know own ship's heading at a glance.

This mode is available when the radar is interfaced with a gyro heading sensor.

If the gyro heading sensor fails, the bearing scale returns to the state of head-up mode.

North-up mode

The north-up mode paints target pips at their measured distances and in their true (heading sensor) directions from own ship, north bearing maintained at the top of the screen. The heading line changes its direction according to the ship's heading. Requires heading signal.

If the compass fails, the presentation mode changes to head-up and the north marker disappears. Also, the HDG indication shows ***.*. And the message "SIGNAL MISSING HEADING" appears in red at the lower-right corner of the screen.

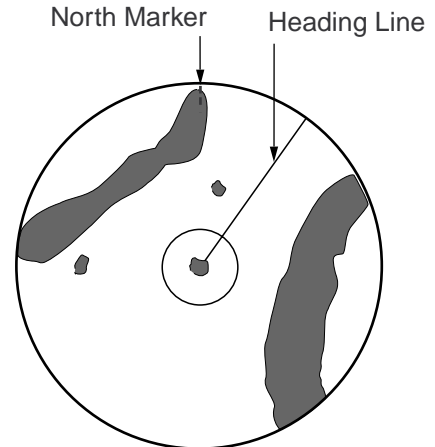

1. OPERATIONAL OVERVIEW

True motion mode

Own ship and other moving objects move in accordance with their true courses and speed. In ground stabilized TM, all fixed targets, such as landmasses, appear as stationary echoes. In the sea stabilized TM without set and drift inputs, the landmass can move on the screen. Note that true motion is not available on the 72 nm or 96 nm range scale.

When own ship reaches a point corresponding to 50% of the radius of the display, own ship position is automatically reset to a point of 75% radius opposite to the extension of the heading line passing through the display center. You may also reset the own ship symbol manually by pressing the **OFFCENTER** key.

If the heading sensor fails, the mode is changed to the head-up and the north marker disappears. The HDG readout shows *****.*** and the message "SIGNAL MISSING HEADING" appears.

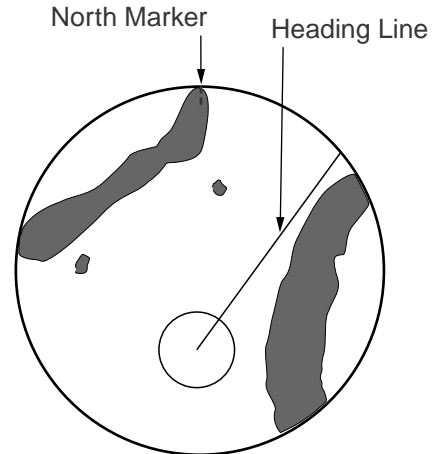

Automatic resetting of own ship mark in true motion mode

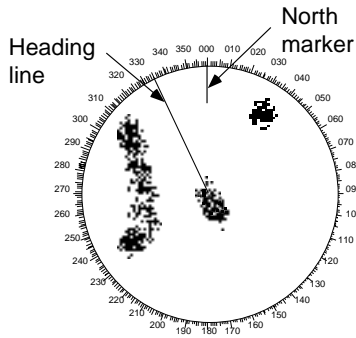

(a) True motion is selected

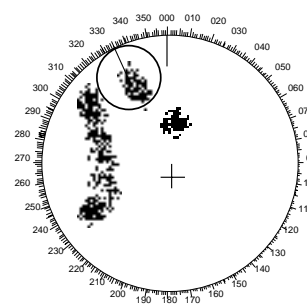

(b) Own ship has reached a point 75% of display radius

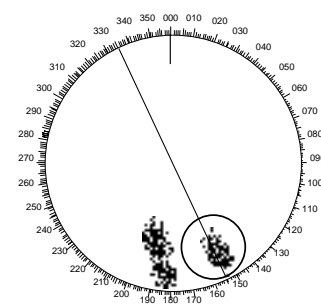

(c) Own ship is automatically reset to 75% of radius

1.8 Choosing a Range Scale

The selected range scale, range ring interval and pulse length are shown at the upper left corner on the screen. When a target of interest comes closer, reduce the range scale so that it appears in 50-90% of the display radius.

Use the **RANGE** key to choose range desired. Hit the "+" part of the key to raise the range; the "-" part to lower the range.

1.9 Choosing a Pulse Length

The pulse length in use appears at the top left position on the screen. Appropriate pulse lengths are preset to individual range scales and functions keys. If you are not satisfied with the pulse length setting on the 1.5 nm or 3 nm range, you may change it as below.

1. Press the **MENU** key to open the menu.
2. Use the trackball to choose the Echo menu and then press the **ENTER** key.
3. Use the trackball to choose Pulse Length and then press the **ENTER** key.

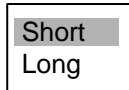

4. Choose Short or Long as appropriate and then press the **ENTER** key.
5. Press the **MENU** key to close the menu.

1.10 Adjusting the Gain (sensitivity)

The **GAIN** control adjusts the sensitivity of the receiver. The proper setting is such that the background noise is just visible on the screen. If you set up for too little sensitivity, weak echoes may be missed. On the other hand excessive sensitivity yields too much background noise; strong targets may be missed because of the poor contrast between desired echoes and the background noise on the display.

1.10.1 Choosing gain adjustment method

Gain may be adjusted automatically or manually. Push the **GAIN** control to choose automatic or manual adjustment alternately. The adjustment method currently chosen is show at the top right corner of the screen. In the example below the adjustment method is "AUTO".

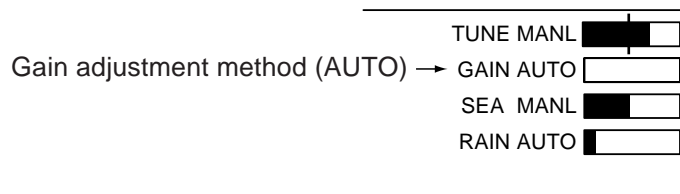

Gain adjustment method indicator

1.10.2 Automatic gain adjustment

1. Press the **MENU** key to open the menu.
2. Choose the Echo menu and then press the **ENTER** key.
3. Choose Auto Gain and then press the **ENTER** key.

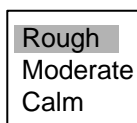

4. Choose the sea condition which best matches the auto gain options.
5. Press the **ENTER** key followed by the **MENU** key to close the menu.

1.10.3 Manual gain adjustment

1. Push the **GAIN** control to show “GAIN MANL” as the gain adjustment method.
2. Rotate the **GAIN** control to adjust the gain. Adjust the control so background noise is just visible on the screen.

1.11 Suppressing Sea Clutter

Echoes from waves cover the central part of the display with random signals known as sea clutter. The higher the waves, and the higher the antenna above the water, the further the clutter will extend. When sea clutter masks the picture, use the **SEA** control to suppress the clutter, either manually or automatically.

1.11.1 Choosing sea clutter adjustment method

Sea clutter may be adjusted automatically or manually. Push the **SEA** control to choose automatic or manual adjustment alternately. The adjustment method currently chosen is show at the top right corner of the screen. In the example below the sea clutter adjustment method is “MANL” (manual).”

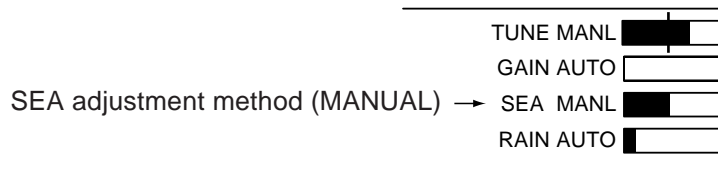

SEA indicator

1.11.2 Automatic sea clutter adjustment

1. Press the **MENU** key to open the menu.
2. Choose the Echo menu and then press the **ENTER** key.
3. Choose Auto Sea and then press the **ENTER** key.

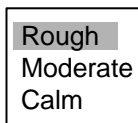

4. Choose the sea condition which best matches the Auto Sea options.
5. Press the **ENTER** key followed by the **MENU** key to close the menu.

1.11.3 Manual sea clutter adjustment

1. Push the **SEA** control to show “SEA MANL” as the SEA adjustment method.
2. Rotate the **SEA** control to suppress sea clutter.

The proper setting of the **SEA** control should be such that the clutter is broken up into small dots, and small targets become distinguishable. If the setting is set too low, targets will be hidden in the clutter, while if the setting is too high, both sea clutter and targets will disappear from the display. In most cases adjust the control until clutter has disappeared to leeward, but a little is still visible windward.

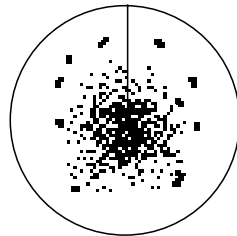

Sea clutter at
screen center

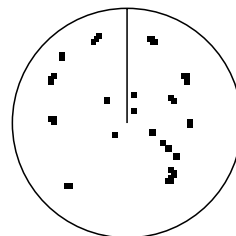

SEA adjusted;
sea clutter suppressed

*How to adjust the **SEA** control*

1.12 Suppressing Rain Clutter

The vertical beamwidth of the scanner is designed to see surface targets even when the ship is rolling. However, by this design the unit will also detect rain clutter (rain, snow, or hail) in the same manner as normal targets.

The **RAIN** control adjusts the receiver sensitivity as the **SEA** control does but rather in a longer time period (longer range). The higher the setting the greater the anti-clutter effect. When echoes from precipitation mask solid targets, adjust the control to split up these unwanted echoes into a speckled pattern, making recognition of solid targets easier.

1.12.1 Choosing rain clutter adjustment method

Rain clutter may be adjusted automatically or manually. Push the **RAIN** control to choose automatic or manual adjustment alternately. The adjustment method currently chosen is show at the top right corner of the screen. In the example below the adjustment method is “AUTO.”

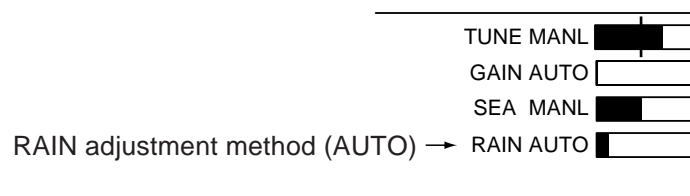

RAIN indicator

1.12.2 Automatic rain clutter adjustment

1. Press the **MENU** key to open the menu.
2. Choose the Echo menu and then press the **ENTER** key.
3. Choose Auto Rain and then press the **ENTER** key.

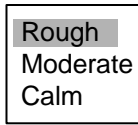

4. Choose the sea condition which best matches the Auto Rain options.
5. Press the **ENTER** key followed by the **MENU** key to close the menu.

1.12.3 Manual rain clutter adjustment

1. Push the **A/C RAIN** control to show "RAIN MANL" as the RAIN adjustment method.
2. Rotate the **A/C RAIN** control to suppress the rain clutter.

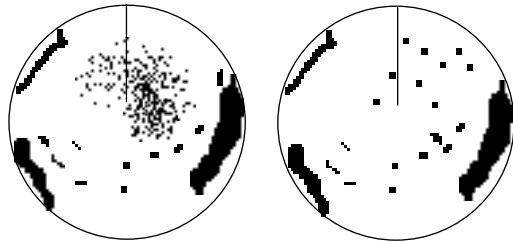

Rain clutter at
screen center

RAIN control adjusted

How to adjust the A/C RAIN control

1.13 Automatic Suppression of Sea and Rain Clutters

Both sea and rain clutters may be adjusted automatically. When this feature is active it overrides the **SEA** and **RAIN** controls.

1. Press the **MENU** key to open the menu.
2. Choose the Echo menu and then press the **ENTER** key.
3. Choose Auto Anti Clutter and then press the **ENTER** key.

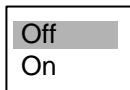

4. Choose Off or On as appropriate.
5. Press the **ENTER** key followed by the **MENU** key to close the menu.

1.14 Cursor

The cursor functions to find the range and bearing to a target or latitude and longitude position of a target, and the default function is range and bearing. Roll the trackball to position the cursor and then read cursor data at the screen bottom.

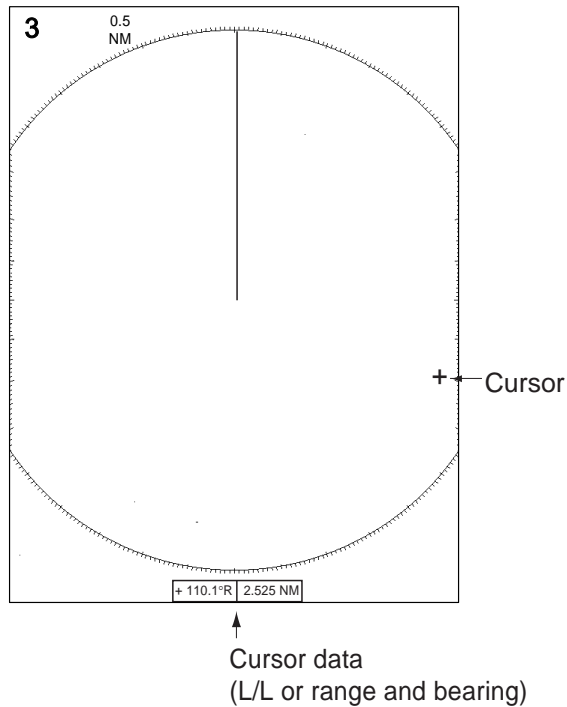

Cursor data

1.14.1 Cursor data

Cursor data can be shown as latitude and longitude or range and bearing to the cursor.

1. Press the **MENU** key to open the menu.
2. Choose the Mark menu and then press the **ENTER** key.
3. Choose Brg/Rng or Lat/Long as appropriate.
4. Press the **ENTER** key followed by the **MENU** key to close the menu.

1.15 Interference Rejector

Mutual radar interference may occur in the vicinity of another shipborne radar operating in the same frequency band. It is seen on the screen as a number of bright spikes either in irregular patterns or in the form of usually curved spoke-like dotted lines extending from the center to the edge of the picture. Activating the interference rejector circuit can reduce this type of interference.

The interference rejector is a kind of signal correlation circuit. It compares the received signals over successive transmissions and suppresses randomly occurring signals. There are three levels of interference rejection depending on the number of transmissions that are correlated.

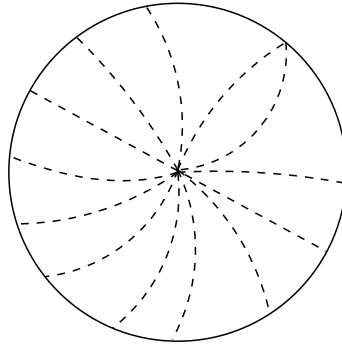

Interference

1. Press the **MENU** key to open the menu.
2. Choose the Echo menu and then press the **ENTER** key.
3. Choose Interference Rejector and then press the **ENTER** key.

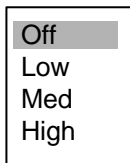

4. Choose Off, Low, Med or High as appropriate and then press the **ENTER** key.
5. Press the **MENU** key to close the menu.

Be sure to turn off the interference rejector when no interference exists so as not to miss small targets.

1.16 Measuring the Range to a Target

The range to a target may be measured three ways: with the fixed range rings, with the cursor (if set to measure range and bearing), or with the VRM.

Use the fixed range rings to obtain a rough estimate of the range to a target. They are the concentric solid circles about own ship, or the sweep origin. The number of rings is automatically determined by the selected range scale and their interval is displayed at the upper-left position of the screen. Count the number of rings between the center of the display and the target. Check the range ring interval and judge the distance of the echo from the inner edge of the nearest ring.

1.16.1 Adjusting range ring brilliance

1. Press the **MENU** key to open the menu.
2. Choose the Brill/Color menu and then press the **ENTER** key.
3. Choose Range Rings Brill and then press the **ENTER** key.

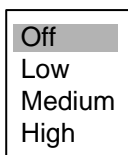

4. Choose appropriate brilliance and then press the **ENTER** key.
5. Press the **MENU** key to close the menu.

1.16.2 Measuring range by the variable range marker (VRM)

There are two VRMs, No. 1 and No. 2, which appear as dashed rings so that you can discriminate them from the fixed range rings. The two VRMs can be distinguished from each other by different lengths of dashes.

1. Press the **VRM** key to display either of the VRMs. Successively pressing the **VRM** key toggles the active VRM between No. 1 and No. 2. The currently active marker is enclosed with >.....<.
2. Operate the Trackball to align the active variable range marker with the inner edge of the target of interest and read its distance at the lower-right corner of the screen. Each VRM remains at the same geographical distance when you operate the **RANGE** key. This means that the apparent radius of the VRM ring changes in proportion to the selected range scale.
3. Press the **VRM** key to erase each VRM.

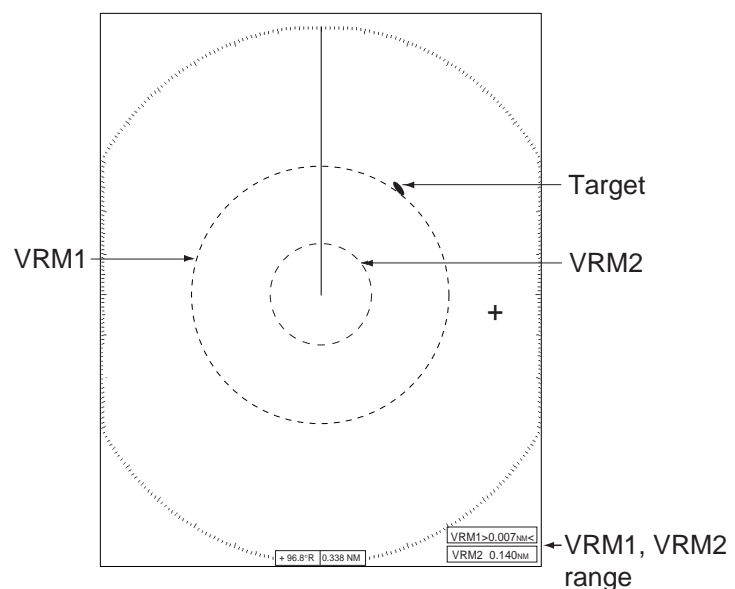

How to measure range with VRMs

1.16.3 Choosing VRM unit

The unit of measurement used by the VRM can be selected to nautical miles, kilometers, statute miles or kilometers/yard.

1. Press the **MENU** key to open the menu.
2. Choose the Mark menu and then press the **ENTER** key.
3. Choose VRM Unit and then press the **ENTER** key.

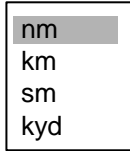

4. Choose desired unit and then press the **ENTER** key.
5. Press the MENU key to close the menu.

1.17 Measuring the Bearing to a Target

Use the Electronic Bearing Lines (EBLs) to take bearings of targets. There are two EBLs, No. 1 and No. 2. Each EBL is a straight dashed line extending out from the own ship position up to the circumference of the radar picture. The fine dashed line is the No. 1 EBL and the coarse dashed one is the No. 2 EBL.

1. Press the **EBL** key to display either of the EBLs. Successively pressing the **EBL** key toggles the active EBL between No. 1 and No. 2. The currently active marker is enclosed with >.....<.
2. Operate the Trackball to bisect the target of interest with the EBL and read its distance at the lower-left corner of the screen.
3. Press the **EBL** key to erase each EBL.

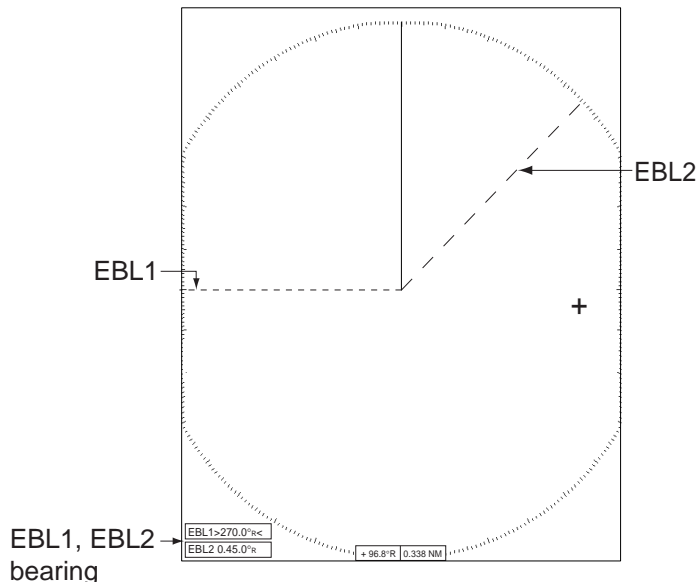

How to measure the bearing to a target with the EBL

1.17.1 EBL reference

The EBL readout is affixed by "R." (relative) if it is relative to own ship's heading, "T." (true) if it is referenced to the north. You may choose relative or true in the head-up modes; in all other modes it is always TRUE.

1. Press the **MENU** key to open the menu.
2. Choose the Mark menu and then press the **ENTER** key.
3. Choose EBL Reference and then press the **ENTER** key.

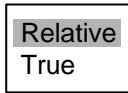

4. Choose Relative or True as appropriate and then press the **ENTER** key.
5. Press the **MENU** key to close the menu.

1.18 Measuring the Range and Bearing Between Two Targets

You may shift the origin of the EBL to measure the range and bearing between two targets.

1. Press the **EBL** key to circumscribe the bearing indication of EBL1 or EBL2 with a dashed rectangle.
2. Drag the EBL to the location of one target and then press the **ENTER** key to anchor the EBL.
3. Roll the trackball to shift the range marker to the location of the other target.
4. Read the bearing and range indications at the bottom of the screen.

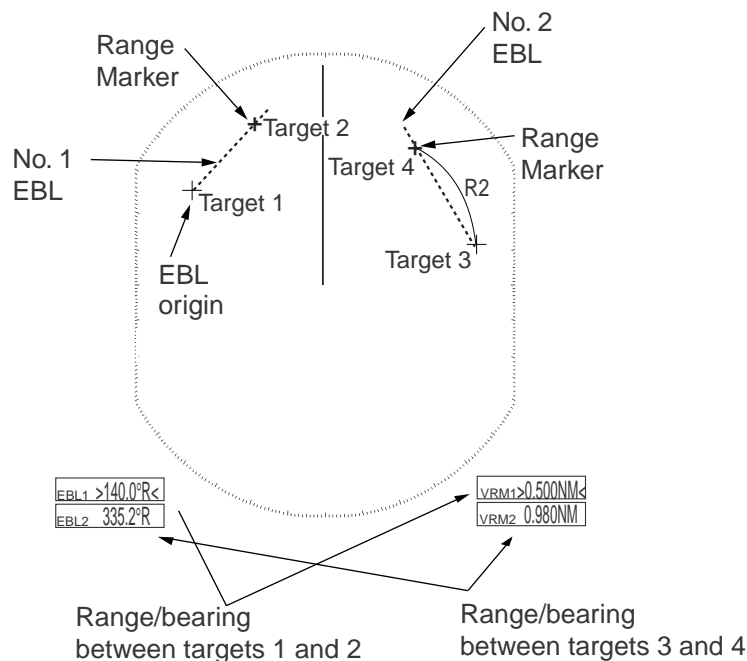

Measuring range and bearing between two target with the EBL

To return the origin of the EBL to the screen center, press the **EBL** key to circumscribe the indication of that the EBL with a solid rectangle.

1.19 Target Alarm

The target alarm serves to alert the navigator to targets (ships, landmasses, etc.) entering a set area, with audible and visual alarms.

The guard alarm zone has a fixed width of 0.5 nm in the radial direction (depth) and is adjustable from 3.0 to 6.0 nm (guard zone 1) and any distance (guard zone 2). The sector of the zone can be set from 0 to 360 degrees in any direction.

The alarm may be set to sound against targets entering or exiting the zone. See paragraph 1.20.3.

 CAUTION
<ul style="list-style-type: none"> • The alarm should not be relied upon as the sole means for detecting possible collision situations. • SEA, RAIN and GAIN controls should be properly adjusted to be sure the alarm system does not overlook target echoes.

1.19.1 Setting a target alarm

The procedure which follows shows you how to set a target alarm, using the illustration below as an example.

1. Press the **TARGET ALARM** key to activate ALARM 1 or ALARM 2 as appropriate.
2. Drag the cursor with the trackball to the location "A" and then press the **ENTER** key.
3. Drag the cursor to the location "B" and then press the **ENTER** key.

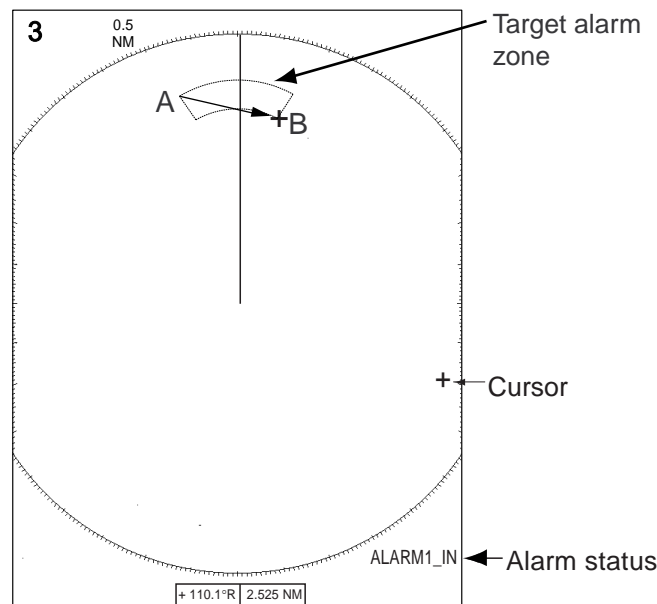

How to set a target alarm zone

Note 1: If you wish to create a target alarm zone having a 360-degree coverage around own ship, set point "B" in almost the same direction as point "A."

Note 2: Two target alarm zones may be set. Note however that the 2nd target alarm zone is available only when the 1st target alarm zone is active.

Note 3: When the target alarm zone is not within the range in use the indication OUT RNG appears in the alarm status area. In this case choose a range which will display the target alarm zone.

1.19.2 Acknowledging the alarm

A target in the target alarm zone produces both visual (flashing) and audible (beep) alarms. To silence the audible alarm, press the **CANCEL/HL OFF** key. The alarm status shows "ALARM1(or 2) ACK." This will deactivate the audible alarm but will not stop the flashing of the offending target. To reactivate the audible alarm, press the **CANCEL/HL OFF** key. The alarm status is then shown as ALARM 1 (or 2) IN(or OUT).

1.19.3 Choosing alarm type

As noted earlier the target alarm may be set sound against targets entering or exiting the alarm. Choose desired type as below.

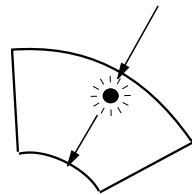

Inward target alarm

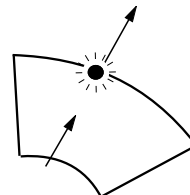

Outward target alarm

In and Out alarms

1. Press the **MENU** key to show the menu.
2. Choose the Mark menu and then press the **ENTER** key.
3. Choose Target Alarm1 Mode or Target Alarm2 Mode as appropriate and then press the **ENTER** key.

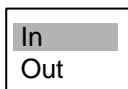

4. Choose In to get the alarm on targets entering target alarm zone or Out to get the alarm on targets exiting a target alarm zone.
5. Press the **ENTER** key followed by the **MENU** key.

1.19.4 Deactivating a target alarm

1. Press the **TARGET ALARM** key to choose ALARM1 or ALARM2 indication at the bottom right corner on the screen. The selected indication is circumscribed with a rectangle.
2. Press the **CANCEL/HL OFF** key.
3. Press the **TARGET ALARM** key again, and a dashed rectangle circumscribes the alarm indication selected.
4. Press the **CANCEL/HL OFF** key again. The target alarm zone and the alarm indication are erased from the screen.

1.19.5 Choosing target strength which triggers target alarm

You may choose the target strength level which triggers the alarm as follows:

1. Press the **MENU** key to open the menu.
2. Choose the Initial sub menu from the System menu and the press the **ENTER** key.
3. Choose Alarm Level and then press the **ENTER** key.

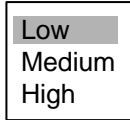

4. Choose the echo strength level which you want to trigger the target alarm.
5. Press the **ENTER** key.
6. Press the **MENU** key to close the menu.

1.20 Off Centering the Display

Own ship position, or sweep origin, can be displaced to expand the view field without switching to a larger range scale. The sweep origin can be off-centered to the cursor position, but not more than 75% of the range in use; if the cursor is set beyond 75% of the range scale, the sweep origin will be off-centered to the point of 75% of the limit.

$$\frac{\text{Ship's speed}}{\text{Shift speed setting}} \times 0.5 = \text{Amount of shift(\%)}$$

This feature is not available on the 72 nm or 96 nm range scale nor in the true motion mode.

The display may be off centered manually, or automatically according to ship's speed. Press the **OFF CENTER** key successively to choose desired off centering method or turn off centering, in the sequence of manual, automatic, off. **OFF CENTER** appears at the top left corner on the display when off centering is enabled. Off center is not available when the zoom function is in use.

1.20.1 Automatic off center

The amount of automatic shift is calculated according to ship's speed, and the amount of shift is limited to 50% of the range in use. For example, if you set the shift speed setting for 15 knots and the ship is running at 10 knots the amount of shift will be about 34%. The formula for determining shift amount is as shown below. Automatic shift mode is only available in the head-up mode.

Choosing speed to use

1. Press the **MENU** key to open the menu.
2. Choose the Initial sub menu from the System menu and press the **ENTER** key.
3. Choose Max Shift Speed and then press the **ENTER** key.

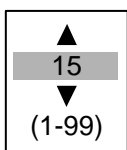

4. Choose the speed to use and then press the **ENTER** key.
5. Press the **MENU** key to close the menu.

Activating automatic off center

Press the **OFF CENTER** key until OFF CENTER appears on the display and the display is not shifted to the cursor location.

1.20.2 Manual off center

1. Place the cursor where you want locate the screen center.
2. Press the **OFF CENTER** key until the display shifts to cursor location.

1.21 Zoom

The zoom function enlarges an area of interest as large as twice the normal viewing size, in the zoom window. You choose the target of interest to zoom with the zoom cursor and that target is zoomed in the zoom window. Zoom is not available when the display is off centered.

Three types of zoom are available: Relative, True and Target.

Relative: The zoom cursor moves relative to own ship's heading.

True: The zoom cursor moves with course and speed of own ship.

Target: The zoom cursor is fixed to the zoomed target.

1.21.1 How to zoom

1. Press the **ZOOM** key to turn on the zoom feature. ZOOM appears at the top right hand corner of the screen together with the zoom cursor, a square (dashed or solid, depending on zoom mode chosen) with a cursor at its center, and the zoom window. The location of the zoom window depends on the location of the zoom cursor. If the zoom cursor is on the left-half of the screen, the zoom window is located at the right side of the screen and vice versa.

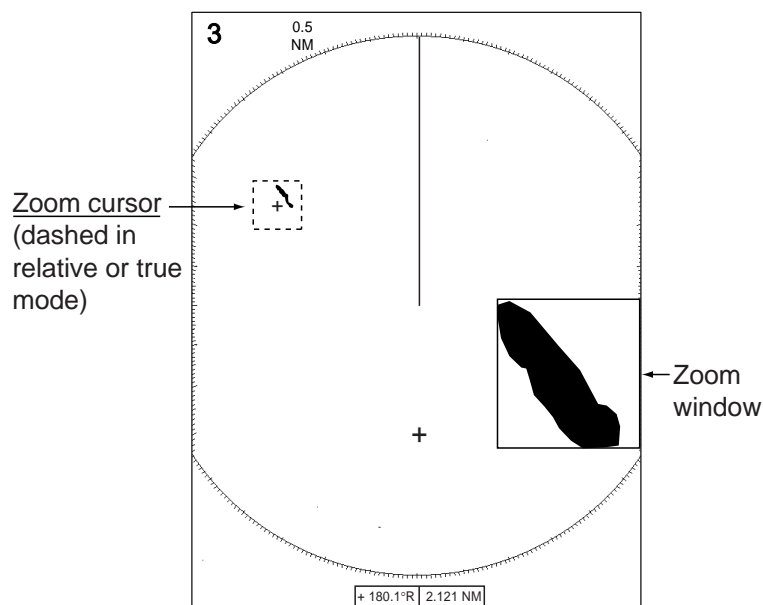

Zoom

2. For the Relative and True modes you may fix the zoom cursor, by pressing the **ZOOM** key again. the zoom cursor then becomes solid.
3. To quit zoom, press the **ZOOM** key again.

1.21.2 Zoom mode

You may choose the zoom mode from among Relative, True or Target.

1. Press the **MENU** key to open the menu.
2. Choose the Mark menu and press the **ENTER** key.
3. Choose Zoom and then press the **ENTER** key.



4. Choose the appropriate echo stretch option and then press the **ENTER** key.
5. Press the **MENU** key to close the menu.

1.22 Echo Stretch

The echo stretch feature enlarges targets to make them easier to see, and it is available on the 1.5 -12 nm ranges depending on echo stretch type. There are 3 settings: ES1 to enlarge in bearing direction for long range detection, ES2 to enlarge in range direction and ES3 to enlarge in bearing and range directions.

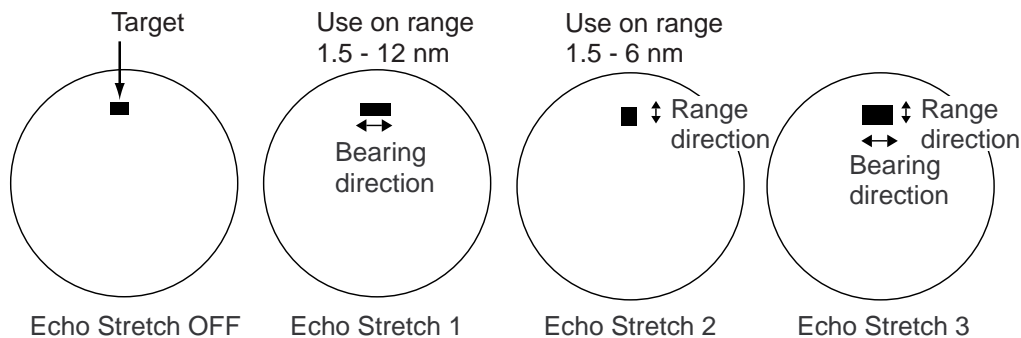

Echo stretch

Note 1: If the 1.5 nm is preset with a pulse length of S1 or S2, and the 3 nm scale with S2, the echo stretch is not available on those range scales.

Note 2: The echo stretch magnifies not only small target pips but also returns (clutter) from sea surface, rain and radar interference. For this reason, make sure these types of interference have been sufficiently suppressed before activating the echo stretch.

1. Press the **MENU** key to open the menu
2. Choose the Echo menu and press the **ENTER** key.
3. Choose Echo Stretch and then press the **ENTER** key.

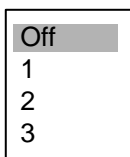

4. Choose the appropriate echo stretch option and then press the **ENTER** key.
5. Press the **MENU** key to close the menu.

1.23 Echo Averaging

The echo average feature effectively suppresses sea clutter. Echoes received from stable targets such as ships appear on the screen at almost the same position every rotation of the antenna. On the other hand, unstable echoes such as sea clutter appear at random positions.

To distinguish real target echoes from sea clutter, echoes are averaged over successive picture frames. If an echo is solid and stable, it is presented in its normal intensity. Sea clutter is averaged over successive scans resulting in reduced brilliance, making it easier to discriminate real targets from sea clutter.

Echo averaging uses scan-to-scan signal correlation technique based on the true motion over the ground of each target. Thus, small stationary targets such as buoys will be shown while suppressing random echoes such as sea clutter. True echo average is not however effective for picking up small targets running at high speeds over the ground.

Note 1: Do not use the echo average function under heavy pitching and rolling; loss of target detection can result.

Note 2: Echo average can be used without a heading sensor. For further details, contact your dealer.

To properly use the echo average function, it is recommended to first suppress sea clutter with the A/C SEA control. Then, do as follows:

1. Press the **MENU** key to open the menu.
2. Choose the Echo menu and press the **ENTER** key.
3. Choose Echo Stretch and then press the **ENTER** key.

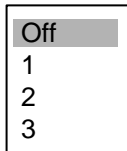

4. Choose the appropriate echo stretch option and then press the **ENTER** key.
5. Press the **MENU** key to close the menu.

1.24 Target Trails

The trails of the radar echoes of targets may be displayed in the form of synthetic afterglow. Target trails are chosen either relative or true and may be sea or ground stabilized. True motion trails require a compass signal and own ship speed input.

1.24.1 Starting, stopping trails

Press the **TRAILS** key to start trails and choose trail time. The chosen time, along with trail mode, is shown at the bottom left corner as shown in the figure below.

Trail time is available among 15 s, 30 s, 1 min., 3 min., 6 min., 15 min., 30 min., Long trail setting (if activated, see paragraph 1.24.10) and CONT(INUOUS) The longer the trail interval the longer the length of the target trail.

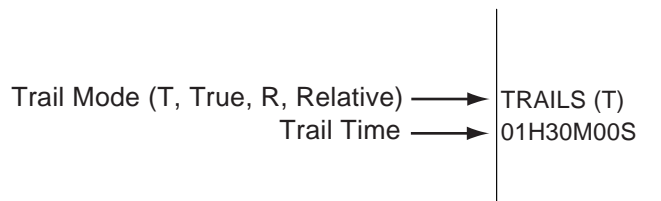

Trail indications

To cancel all trails, press the **TRAILS** key to erase the trail indications.

1.24.2 Trail mode

You may display echo trails in true or relative motion (only true trail on TM). Relative trails show relative movements between targets and own ship. True motion trails require a gyrocompass signal and own ship speed input to cancel out own ship's movement and present true target movements in accordance with their over-the-ground speeds and courses.

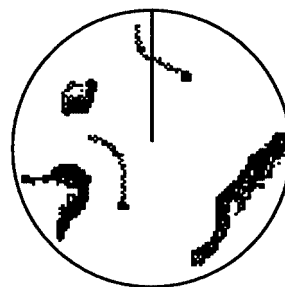

(a) True target trails
(No smearing of stationary targets)

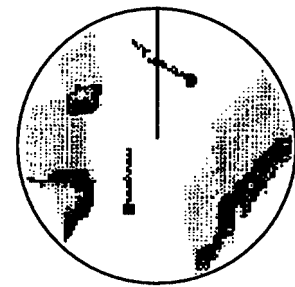

(b) Relative target trails
Targets moving relative to own ship

True and relative target trails

1. Press the **MENU** key to open the menu.
2. Choose the Target Trails menu and press the **ENTER** key.
3. Choose Mode and then press the **ENTER** key.

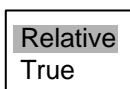

4. Choose the appropriate mode and then press the **ENTER** key.
5. Press the **MENU** key to close the menu.

1.24.3 Trail gradation

Trails may be shown in single or multiple gradation (monocolor) or in multicolor.

1. Press the **MENU** key to open the menu.
2. Choose the Target Trails menu and press the **ENTER** key.
3. Choose Trail Gradation and then press the **ENTER** key.

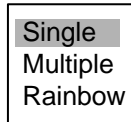

4. Choose the appropriate trail gradation referring to the figure below and then press the **ENTER** key. The item Rainbow display trails in multicolor.



Monotone
(Single)



Gradual shading
(Multi)

5. Press the **MENU** key to close the menu.

1.24.4 Trail color

You may choose trail color as follows:

1. Press the **MENU** key to open the menu.
2. Choose the Target Trails menu and press the **ENTER** key.
3. Choose Color and then press the **ENTER** key.

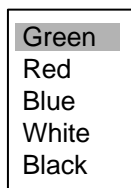

4. Choose the appropriate color and then press the **ENTER** key.
5. Press the **MENU** key to close the menu.

1.24.5 Trail level

The level (intensity) of the afterglow which extends from radar targets may be chosen as below.

1. Press the **MENU** key to open the menu.
2. Choose the Target Trails menu and press the **ENTER** key.
3. Choose Color and then press the **ENTER** key.

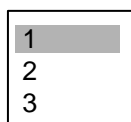

4. Choose 1, 2 or 3 as appropriate level and then press the **ENTER** key.
1: All: signals produce trails, **2:** Normal, **3:** Only weak signals produce trails
5. Press the **MENU** key to close the menu.

1.24.6 Trail copy

Trails are canceled and restarted whenever the range is changed. However, you may continue trails on the same range, without restarting them, when the range is changed to a next larger or smaller range scale. Note however that when the range is changed, only those trails within the previous range are continued; no trails are generated for targets outside the previous range.

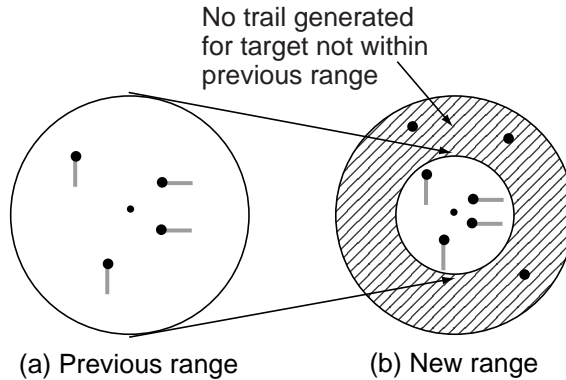

How trail copy works

1. Press the **MENU** key to open the menu.
2. Choose the Target Trails menu and press the **ENTER** key.
3. Choose Trail Copy and then press the **ENTER** key.

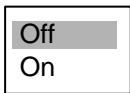

4. Choose Off or On as appropriate and then press the **ENTER** key.
5. Press the **MENU** key to close the menu.

1.24.7 Thin trails

Target trails may be painted with thinner lines if desired. This can be useful when there are a lot of targets on the screen.

1. Press the **MENU** key to open the menu.
2. Choose the Target Trails menu and press the **ENTER** key.
3. Choose Thin and then press the **ENTER** key.
4. Choose Off or On as appropriate and then press the **ENTER** key.
5. Press the **MENU** key to close the menu.

1.24.8 Own ship trail

You may show own ship's trail as follows:

1. Press the **MENU** key to open the menu.
2. Choose Own Ship and then press the **ENTER** key.
3. Choose Off or On as appropriate and then press the **ENTER** key.
4. Press the **MENU** key to close the menu.

1.24.9 Restarting trails

You may clear all target trails to restart the trail process. Target trails are cleared and the trailing process restarts from time count zero at the current target trail plot interval.

1. Press the **MENU** key to open the menu.
2. Choose Restart Trails and then press the **ENTER** key.
3. Choose Off or On as appropriate and then press the **ENTER** key.
4. Press the **MENU** key to close the menu.

1.24.10 Long trails

Several preset trail times are provided for your convenience. If you prefer a different time you may set it as below. The setting range is 45 minutes to 48 hours, in increments of 15 minutes.

1. Press the **MENU** key to open the menu.
2. Choose Long Trails and then press the **ENTER** key.
3. Roll the trackball upward or downward as appropriate to set time and then press the **ENTER** key.
4. Press the **MENU** key to close the menu.

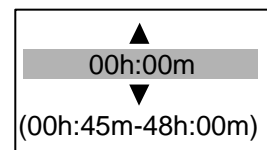

1.25 Parallel Index Lines

Parallel index lines are useful for keeping a constant distance between own ship and a coastline or a partner ship when navigating. Two index lines are available and any two may be displayed. You may control the orientation and line interval.

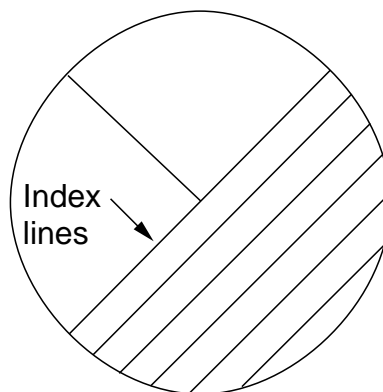

Parallel index lines

1.25.1 Turning parallel index lines on or off

1. Press the **MENU** key to show the menu.
2. Choose Mark and then press the **ENTER** key.
3. Choose Parallel Line and then press the **ENTER** key.

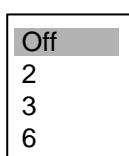

1. OPERATIONAL OVERVIEW

4. Choose the number of parallel index lines to show (2, 3 or 6) or choose Off to turn off the lines. (The actual number of lines visible may be less depending on line interval.)
5. Press the **ENTER** key.
6. Press the **MENU** key to close the menu.

1.25.2 Using the parallel index lines

1. Press the **EBL** key to activate EBL2.
2. Roll the trackball to adjust the orientation of the lines.
3. Press the **VRM** key to activate VRM2.
4. Roll the trackball to adjust the interval between lines.

1.25.3 Parallel index lines mode

Index lines orientation may be chosen from parallel or vertical as follows:

1. Press the **MENU** key to open the menu.
2. Choose Mark and press the **ENTER** key.
3. Choose Parallel Line Mode and then press the **ENTER** key.

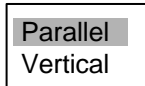

4. Choose Parallel or Vertical as appropriate and then press the **ENTER** key.
5. Press the **MENU** key to close the menu.

1.26 Outputting Target Position, Inscribing Origin Mark

The TLL key functions to output cursor position to a navigation plotter (where it is marked on its screen) and inscribe an asterisk (*) mark at cursor position. Twenty marks may be inscribed on the screen. When you enter a 21st mark the eldest mark is erased to make room for the latest. To erase a mark, place the cursor on it and press the CANCEL/HL OFF key.

1.26.1 TLL key mode

The TLL key can be preset to output target position, inscribe the origin mark or do both.

1. Press the **MENU** key to open the menu.
2. Choose Mark and press the **ENTER** key.
3. Choose TLL Key Mode and then press the **ENTER** key.

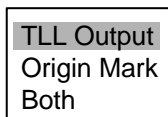

4. Choose TLL Output, Origin Mark or Both as appropriate and then press the **ENTER** key.
5. Press the **MENU** key to close the menu.

1.26.2 Origin mark mode

You may choose origin mark movement from either True or Relative as follows:

1. Press the **MENU** key to open the menu.
2. Choose Mark and press the **ENTER** key.
3. Choose Origin Mark Mode and then press the **ENTER** key.

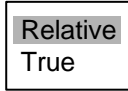

4. Choose Relative or True as appropriate and then press the **ENTER** key.
5. Press the **MENU** key to close the menu.

1.27 Temporarily Hiding the Heading Line, Heading Marker

The heading line indicate the ship's heading in all presentation modes. The heading line is a line from the own ship position to the outer edge of the radar display area and appears at zero degrees on the bearing scale in head-up mode; it changes the orientation depending on the ship orientation in north-up and true motion modes. The heading marker is a small circle on the bearing scale to indicate the heading when the display is off-centered or is in north-up or TM mode.

To temporarily hide the heading line and heading marker to look at targets existing dead ahead of own ship, press and hold down the **CANCEL/HL OFF** key. To re-display the heading line release the key.

1.28 Custom Setup

1.28.1 About custom setup

Every time your navigating environment or task changes, you must adjust the radar, which can be a nuisance in a busy situation. Instead of changing radar settings case by case, it is possible to assign the function keys to provide optimum settings for often encountered situations.

The radar's internal computer offers three default custom setups (see the table below). However you may customize these settings to meet your navigation needs, on the Custom 1, Custom 2 and Custom 3 menus.

To enable a custom setup, press the **CUSTOM** key. Each press of the key enables CUSTOM1, CUSTOM or CUSTOM3 cyclically. The chosen custom setup name is shown at the top left corner. To escape from custom setup, operate any control.

Default custom settings

Menu item (radar function)	Default settings		
	Custom1	Custom2	Custom3
Name	Harbor	Long	Sea
Gain	Moderate	Moderate	Moderate
Sea	Calm	Calm	Calm
Rain	Calm	Calm	Calm
Pulse length	Short	Long	Short
Echo stretch	Off	2	Off
Echo average	Off	3	3
Noise rejector	Off	Med	High
Interference rejector	High	Low	High
Auto anti-clutter	Off	Off	Off
Display dynamic	Wide	Normal	Wide
Display-curve	1	3	3
Antenna speed	48 rpm	24 rpm	48 rpm

1.28.2 Description of custom setup items

Description of custom setup items

Menu item	Description of available settings	See paragraph;
Name	Harbor: Optimum setting for short range navigation in a harbor area using a range scale of 1.5 nm or less Long: Optimum setting for long range detection using a range scale of 6 nm or larger Sea: Optimum setting for navigating in heavy seas. Rain: Optimum setting for navigating in heavy rain. Buoy: Optimum setting for detecting navigation buoys. Bird: Optimum setting for detecting birds.	
Gain	Rough, Moderate, Calm: Choose according to sea state. Manual: Manual adjustment	1.11
Sea	Rough, Moderate, Calm: Choose according to sea state. Manual: Manual adjustment	1.12
Rain	Rough, Moderate, Calm: Choose according to sea state. Manual: Manual adjustment	1.13
Pulse length	Short or Long, changeable on 1.5 and 3 nm ranges.	1.10
Echo stretch	Off, 1, 2, 3	1.23
Echo average	Off, 1, 2, 3	1.24
Noise rejector	Off, Low, Med, High	1.30
Interference rejector	Off, Low, Med, High	1.16
Auto anti-clutter	Off, On	1.14
Display dynamic	Narrow, Normal, Wide.	1.36
Display-curve	1, 2, 3	1.37
Antenna speed	24 rpm, 36 rpm, 48 rpm, Auto/Range.	1.38

1.28.3 Setting custom setups

1. Press the **MENU** key to show the menu.
2. Choose Custom 1, Custom 2 or Custom 3 as appropriate and then press the **ENTER** key.
3. Choose Name and then press the **ENTER** key to display the options shown right.
4. Choose the name which best matches your desired objective and then press the **ENTER** key.
5. Set other menu items according to the objective name chosen at step 4.
6. After adjusting all menu items, choose Save and then press the **ENTER** key. CUSTOM SAVE COMPLETE appears when saving is completed.
7. Press the **MENU** key to close the menu.

Harbor
Long
Sea
Rain
Buoy
Bird

1.29 Programming Function Keys (F1 and F2 keys)

Less-often used functions are provided in the menu. To avoid opening the menus to set up the radar for a particular situation, you may program a function key to provide one-touch access to a desired function.

Function key operation

To activate a function, simply press the appropriate function key. Then, that function's options appear. Push the function key again to choose appropriate option and then press the **ENTER** key.

The default programs are F1, Echo averaging, F2, Display color.

Changing function key program

To change function key program, do the following:

1. Press the **MENU** key to show the menu.
2. Choose Display and then press the **ENTER** key.
3. Choose Function 1 Setup or Function 2 Setup as appropriate and then press the **ENTER** key.

Range Rings Brill	Auto Gain	Trails-Gradation	Waypoint Mark Display	Vector Time	ARP-Display
Echo Color	Auto Sea	Trails-Color	Origin Mark Mode	Vector Reference	ARP-Symbol Color
Display Color	Auto Rain	Trails-Mode	TLL Key Mode	History Dots	ARP-Auto Acquire
Background Color	Tune Mode	Trails-Level	Parallel Line	History Intervals	ARP-All Cancel
Echo Color	Pulse Length	Trails-Copy	Parallel Line Mode	CPA	AIS-Display
Watchman Time	Echo Stretch	Trails-Restart	EBL Reference	TCPA	AIS-Symbol Color
Data Box	Echo Average	Trails-Thin	VRM Unit	Proximity Alarm	AIS-Sort By
Zoom Mode	Noise Rejector	Trails-Own Ship	Cursor Position		GPS-Type
STBY Mode Display	Interference Rejector		Target Alarm1 Mode		GPS-Datum
	Auto Anti Clutter		Target Alarm 2 Mode		
	Display-Dynamic				
	Display-Curve				
	Antenna Speed				
	2nd Echo Rejector				

Function list

4. Choose desired function from the list and then press the **ENTER** key.
5. Press the **MENU** key to close the menu.

1.30 Noise Rejector

White noise may show itself on the screen as random "speckles" spread over the entire radar image. You can remove this noise as follows:

1. Press the **MENU** key to show the menu.
2. Choose Echo and then press the **ENTER** key.
3. Choose Noise Rejector and then press the **ENTER** key.
4. Choose On or Off as appropriate and then press the **ENTER** key.
5. Press the **MENU** key to close the menu.

1.31 Suppressing Second-trace Echoes

In certain situations, echoes from very distance targets may appear as false echoes (second-trace echoes) on the screen. This occurs when the return echo is received one transmission cycle later, or after a next radar pulse has been transmitted.

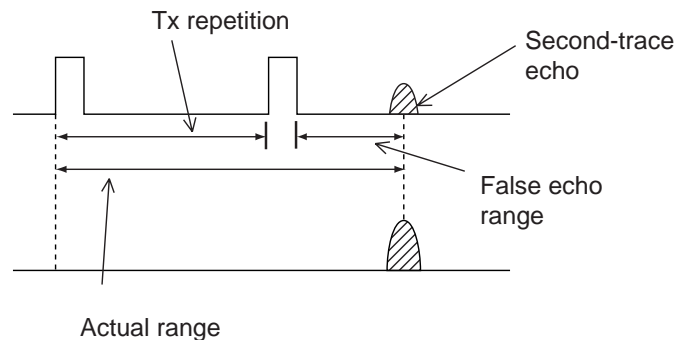

How 2nd trace echoes are produced

1. Press the **MENU** key to show the menu.
2. Choose Echo and then press the **ENTER** key.
3. Choose 2nd Echo Rejector and then press the **ENTER** key.
4. Choose On or Off as appropriate and then press the **ENTER** key.
5. Press the **MENU** key to close the menu.

1.32 Watchman

The watch alarm sounds the audible alarm at the chosen time interval to help you keep regular watch of the radar picture for safety or other purposes.

The watchman time appears at the lower-left corner of the screen with a watch alarm timer which counts down from value set (for example, "10:00").

When a preset time interval has elapsed, the audible watch alarm is released, the screen label WATCH turns red and the watch alarm timer freezes at "0:00." To silence the alarm, press the **CANCEL/HL OFF** key. The label WATCH turns to normal color and the watch alarm timer is reset to the initial value and starts the count-down sequence again.

If you press the **CANCEL** key before the selected time interval is reached, the watch alarm timer is reset to the initial value and starts the count-down sequence again.

To set watch time interval, do the following:

1. Press the **MENU** key to show the menu.
2. Choose Display and then press the **ENTER** key.
3. Choose Watchman Time and then press the **ENTER** key.
4. Choose Off or appropriate time and then press the **ENTER** key.
5. Press the **MENU** key to close the menu.

1.33 Color Schemes

1.33.1 Preset color schemes

Preset color schemes are provided for optimum viewing in daytime, nighttime and twilight. A user arrangeable color scheme is also provided. Below are the default color settings for each preset color scheme.

Display item and color

	Day	Night	Twilight	User
Text	Black	Red	Green	Green
Range rings	Green	Red	Green	Green
Echo	Yellow	Green	Green	Green
Background	White	Black	Blue	Black

1. Press the **MENU** key to show the menu.
2. Choose Brill/Color and then press the **ENTER** key.
3. Choose Display Color and then press the **ENTER** key.

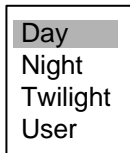

4. Choose a color scheme and then press the **ENTER** key.
5. Press the **MENU** key to close the menu.

1.33.2 User color scheme

The user color scheme lets you choose desired echo color and background color. The display color must be set for “User” (in paragraph 1.33.1) to use user chosen echo and background colors.

1. Press the **MENU** key to show the menu.
2. Choose Brill/Color and then press the **ENTER** key.
3. Choose Echo Color and then press the **ENTER** key.

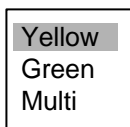

4. Choose a color and then press the **ENTER** key. Multi displays echoes in colors of red, yellow and green according to echo strength, and it is not available on the IMO spec. radar.
5. Choose Background Color and then press the **ENTER** key.

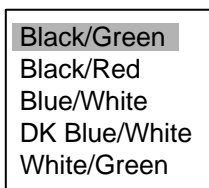

6. Choose background color desired and then press the **ENTER** key.
7. Press the **MENU** key to close the menu.

1.34 Navigation Data

1.34.1 Navigation data during standby

Navigation data is shown when the radar is in standby. Appropriate sensors required to display data.

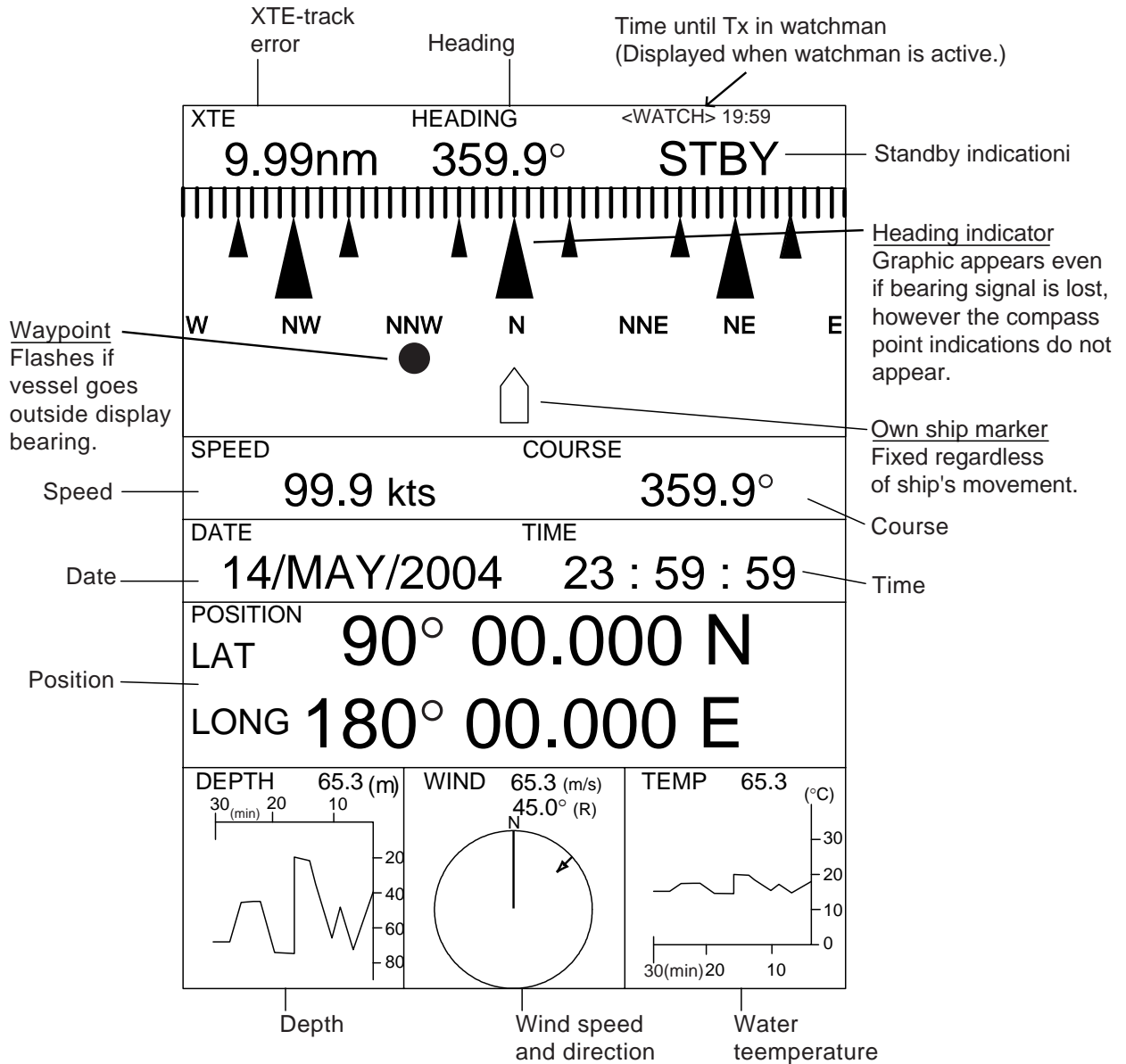

Navigation data display at standby

1. OPERATIONAL OVERVIEW

Depth and water temperature graphs

These graphs display the latest 30 minutes of respective data. The horizontal axis scale is updated and plotted at intervals of 10 seconds. The vertical axis scale is adjusted automatically for every 30 minutes of data. The unit of measurement may be chosen on the Initial sub menu in the System menu.

Wind graph

Wind direction reference may be chosen (on the Initial sub menu) from True or Apparent.

Apparent wind is the direction (in relation to ship's bow) and speed of the wind as it appears to those on board, relative to the speed and direction of the boat; combination of the true wind and the wind caused by the boat's movement. **True wind** is the speed and direction (in relation to ship's bow) of the wind felt or measured when stationary.

1.34.2 Navigation data at the bottom of the screen

Navigation data may be displayed at the bottom of the screen.

OWN LAT: 34°56.123 E	CURSOR LAT: 34°56.123 E	WAY 0.095 NM	TEMP 12.3°C
SHIP LON: 135°34.567 E	LON: 135°34.567 E	POINT 90.0° M	DEPTH 56.7 M
SPEED 12.34 kt	TTG: 01:00	TTG: 00:20	

Navigation data

To show navigation data, do the following:

1. Press the **MENU** key to open the menu.
2. Choose the Display menu and then press the **ENTER** key.
3. Choose Data Box and then press the **ENTER** key.

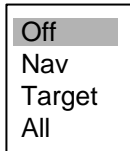

4. Choose Nav or All and then press the **ENTER** key. (Choose All to display Nav data and ARPA and AIS target data.)
5. Press the **MENU** to close the menu.

1.35 Dynamic Range

In radar systems, system dynamic range is crucial for differentiating between highly reflective targets and those which do not have optimum reflective properties. You may change the dynamic range to better differentiate those targets as below.

1. Press the **MENU** key to open the menu.
2. Choose the Echo menu and then press the **ENTER** key.
3. Choose Display-Dynamic and then press the **ENTER** key.

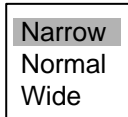

4. Choose Narrow (-6dB), Normal(-12dB) or Wide(-18dB) as appropriate and then press the **ENTER** key.

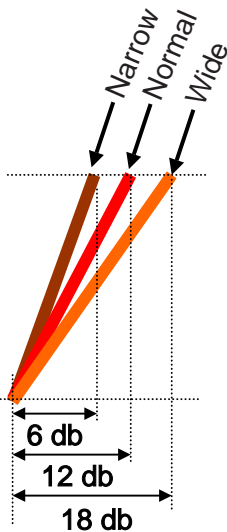

Dynamic range settings

5. Press the **MENU** to close the menu.

1.36 Characteristics Curve

The characteristics curve of this radar may be changed to meet detection requirement.

1. Press the **MENU** key to open the menu.
2. Choose the Echo menu and then press the **ENTER** key.
3. Choose Display-Curve and then press the **ENTER** key.

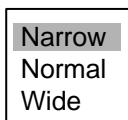

4. Choose 1 (Linear), 2(Exponential) or 3(Logarithm) as appropriate and then press the **ENTER** key.
5. Press the **MENU** to close the menu.

1.37 Antenna Speed

The antenna speed may be changed to meet operating requirement. Choose a high speed when cruising at high speed to ensure timely update of radar targets. Note that the speed cannot be changed on the 24 rpm motor; it is fixed at 24 rpm.

1. Press the **MENU** key to open the menu.
2. Choose the Echo menu and then press the **ENTER** key.
3. Choose Antenna Speed and then press the **ENTER** key.

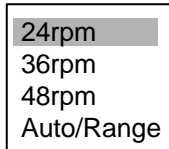

4. Choose appropriate antenna speed. Auto/Range automatically changes antenna speed according to range.
5. Press the **ENTER** key.
6. Press the **MENU** key to close the menu.

1.38 Waypoint Mark

The waypoint marker shows the location of the destination waypoint set on a navigation plotter. You can turn this mark on or off as follows:

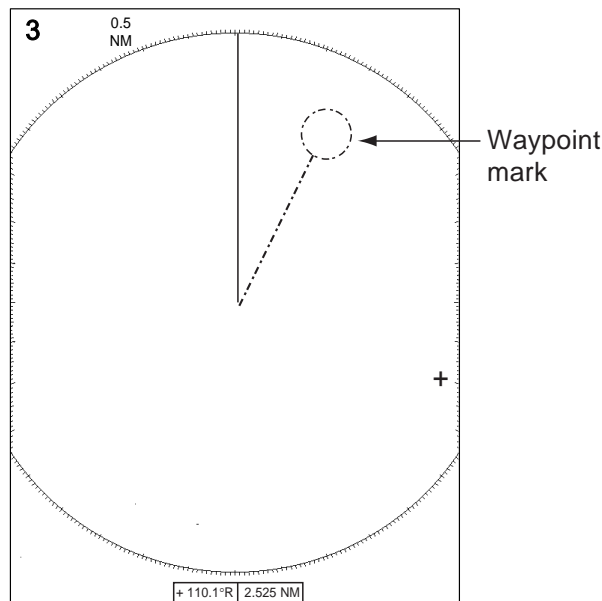

Waypoint mark

1. Press the MENU key to open the menu.
2. Choose Mark and then press the **ENTER** key.
3. Choose Waypoint Mark Display and then press the **ENTER** key.
4. Choose On or Off as appropriate and then press the **ENTER** key.
5. Press the **MENU** key to close the menu.

1.39 Alarm Message Display

When a violation occurs the radar generates audible and visual alarms to alert you. The alarm message display shows all alarms currently violated. You may show this display as follows:

1. Press the **MENU** key to open the menu.
2. Choose the Display menu and then press the **ENTER** key.
3. Choose Alarm Message and then press the **ENTER** key.

[Signal Missing]
 [Target Alarm1]
 [ARP Alarm]

<Please Push Any Key -- To Stop Alarm And Close this Window>

Alarm message display

To close the alarm message display, press any key.

List of alarm messages

List of alarm messages

Category Alarm name	Alarm name
Signal missing	
Heading	Heading signal lost
Bearing	Antenna rotation signal lost
Position	Position data lost
Target Alarm	
Target Alarm1 In (or Out)	Echo has entered (or exited) target alarm zone 1.
Target Alarm1 In (or Out)	Echo has entered (or exited) target alarm zone 1
ARP alarm	
Collision	CPA and TCPA of an ARP target is less than preset CPA and TCPA.
Lost	Acquired ARP target becomes lost
Target-Full	Target tracking capacity is reached.
Proximity	The range to an ARP target is less than the user-set proximity alarm range.
AIS alarm	
Collision	CPA and TCPA of an ARP target is less than preset CPA and TCPA.
Proximity	The range to an AIS target is less than the user-set proximity alarm range.

List of alarm messages

Category Alarm name	Alarm name
AIS system	
TX	TX stopped or TX error
ANT	Antenna VSWR trouble
CH1	TDM2 RX1 board trouble
CH2	TDM2 RX2 board trouble
CH70	RX channel 70 trouble
FAIL	System failure
EPFS	External EPFS trouble
L/L	Position data lost
SOG	Speed data lost
COG	Course data lost
HDG	Heading data lost
ROT	Rate of turn data lost
MKD	Minimum input device lost

1.40 Echo Area

The effective display area can be either ellipsis or square shaped.

1. Press the **MENU** key to open the menu.
2. Choose the Display menu and then press the **ENTER** key.
3. Choose Echo Area and then press the **ENTER** key.

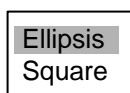

4. Choose desired display area configuration and then press the **ENTER** key.
5. Press the **MENU** to close the menu.

1.41 Customizing (Initial Menu)

The Initial sub menu in the System menu contains items which allow you to customize your radar to meet your operational needs.

1.41.1 Opening the Initial menu

1. Press the **MENU** key to open the menu.
2. Roll the trackball to choose System followed by Initial and then press the **ENTER** key.

Menu	Initial
Brill/Color	Key Beep : On
Display	Range Unit : nm
Echo	Alarm Level : Med
Target Trails	TX Antenna Rotate : Rotate
Mark	Max Shift Speed : 15 kt
Custom 1	STBY Mode Display : Normal
Custom 2	Bearing Source : Magnetic
Custom 3	Range Preset
Manual Tune	Ship Speed Unit : kt
Target	Depth Unit : m
ARP	Temperature Unit : °C
AIS	Wind Direction : Apparent
GPS	Wind Speed Unit : kt
▼ System	Port 1 Setup : Auto
Initial	Port 2 Setup : Auto
Factory	▲/▼ / ◀/▶ : Select
Installation	[ENTER]: Enter [CANCEL/HL OFF]: Back
	[MENU]: Exit

Initial menu

1.41.2 Description of Initial menu

Key Beep: A beep sounds when keys are pressed. You may turn this beep on or off.

Range Unit: Range may be shown in nm, km or sm.

Alarm Level: The target alarm may be set to sound against weak, medium or strong echoes.

TX Antenna Rotate: Radar pulses may be transmitted without rotating the antenna. For the service technician.

Max Shift Speed: Set the maximum shift speed to use with automatic offcentering. The setting range is 1-99 (kts)

STBY Mode Display: STBY Mode Display sets the function of the radar in standby. "Normal" displays "STBY" at the screen center; "Nav" displays navigation data, and "Economy" extinguishes the backlight of the LCD to conserve power.

Bearing Source: Choose the type of bearing sensor connected to the radar; True (gyrocompass) or Magnetic (magnetic compass).

1. OPERATIONAL OVERVIEW

Range Preset: You may choose the radar ranges you wish to use. When you choose Range Preset the option window shown below appears. Choose a range and press the **ENTER** key to turn that range on or off. At least two ranges must be turned on. The maximum range available depends on radar model.

0.125	On
0.25	On
0.5	On
0.75	On
1	Off
1.5	On
2	Off
3	On
4	Off
6	On
8	Off
12	On
16	On
24	On
36	On
48	On
72	On
96	On
Exit?	Yes

Available ranges

Ship Speed Unit: The ship's speed unit may be selected to knots (kts), kilometers/hour (km/h) or miles per hour (mph).

Depth Unit: The depth unit is available in meters (m), feet (ft), fathoms (fa), passi/braza (p/b) or Hiro (hr).

Temperature Unit: Temperature may be displayed in °C (Celsius) or °F (Fahrenheit).

Wind Direction: Wind direction may be shown as True or Apparent. For further details, see paragraph 1.35.1.

Wind Speed Unit: Wind speed may be shown in knots (kts), kilometers per hour (km/h), miles per hour (mph) or meters/second (m/s).

Port 1: Set the baud rate of the equipment connected to Port1. "Auto" provides automatic detection of baud rate. External equipment must be equipped with auto baud rate detection feature.

Port 2: Same function as Port1 but for Port2.

Through Output: Data input to port 1 may be output from port 2. Choose "On" to use this feature.

2. RADAR OBSERVATION

2.1 General

2.1.1 Minimum and maximum ranges

Minimum range

The minimum range is defined by the shortest distance at which, using a scale of 1.5 or 0.75 nm, a target having an echoing area of 10 m² is still shown separate from the point representing the antenna position.

It is mainly dependent on the pulse length, antenna height, and signal processing such as main bang suppression and digital quantization. It is a good practice to use a shorter range scale as far as it gives favorable definition or clarity of picture. The IMO Resolution MSC.64(67) Annex 4 (Shipborne radar) and A.820: 1995 (High Speed Craft Radar) require the minimum range to be less than 50 m and 35 m, respectively. This series of radars satisfy this requirement.

Maximum range

The maximum detecting range of the radar, R_{max} , varies considerably depending on several factors such as the height of the antenna above the waterline, the height of the target above the sea, the size, shape and material of the target, and the atmospheric conditions.

Under normal atmospheric conditions, the maximum range is equal to the radar horizon or a little shorter. The radar horizon is longer than the optical one by about 6% because of the diffraction property of the radar signal. The R_{max} is given in the following equation.

$$R_{max} = 2.2 \times (\sqrt{h_1} + \sqrt{h_2})$$

where R_{max} : radar horizon (nautical miles)

h_1 : antenna height (m)

h_2 : target height (m)

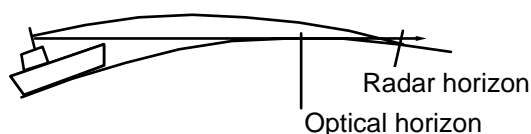

For example, if the height of the antenna above the waterline is 9 meters and the height of the target is 16 meters, the maximum radar range is;

$$R_{max} = 2.2 \times (\sqrt{9} + \sqrt{16}) = 2.2 \times (3 + 4) = 15.4 \text{ nm}$$

It should be noted that the detection range is reduced by precipitation (which absorbs the radar signal).

2.1.2 X-band and S-band

In fair weather, the equation on the previous page does not give a significant difference between X- and S-band radars. However, in heavy precipitation condition, an S-band radar would have better detection than an X-band radar.

2.1.3 Radar resolution

There are two important factors in radar resolution (discrimination): bearing resolution and range resolution.

Bearing resolution

Bearing resolution is the ability of the radar to display as separate pips the echoes received from two targets which are at the same range and close together. It is proportional to the antenna length and reciprocally proportional to the wavelength. The length of the antenna radiator should be chosen for a bearing resolution better than 2.5° (IMO Resolution). This condition is normally satisfied with a radiator of 1.2 m (4 ft) or longer in the X-band. The S-band radar requires a radiator of about 12 feet (3.6 m) or longer.

Range resolution

Range resolution is the ability to display as separate pips the echoes received from two targets which are on the same bearing and close to each other. This is determined by pulse length only. Practically, a 0.08 microsecond pulse offers the discrimination better than 35 m as do so with all FURUNO radars.

Test targets for determining the range and bearing resolution are radar reflectors having an echoing area of 10 m².

2.1.4 Bearing accuracy

One of the most important features of the radar is how accurately the bearing of a target can be measured. The accuracy of bearing measurement basically depends on the narrowness of the radar beam. However, the bearing is usually taken relative to the ship's heading, and thus, proper adjustment of the heading line at installation is an important factor in ensuring bearing accuracy. To minimize error when measuring the bearing of a target, put the target echo at the extreme position on the screen by selecting a suitable range.

2.1.5 Range measurement

Measurement of the range to a target is also a very important function of the radar. Generally, there are two means of measuring range: the fixed range rings and the variable range marker (VRM). The fixed range rings appear on the screen with a predetermined interval and provide a rough estimate of the range to a target. The variable range marker's diameter is increased or decreased so that the marker touches the inner edge of the target, allowing the operator to obtain more accurate range measurements.

2.2 False Echoes

Occasionally echo signals appear on the screen at positions where there is no target or disappear even if there are targets. They are, however, recognized if you understand the reason why they are displayed. Typical false echoes are shown below.

2.2.1 Multiple echoes

Multiple echoes occur when a transmitted pulse returns from a solid object like a large ship, bridge, or breakwater. A second, a third or more echoes may be observed on the display at double, triple or other multiples of the actual range of the target as shown below. Multiple reflection echoes can be reduced and often removed by decreasing the gain (sensitivity) or properly adjusting the SEA control.

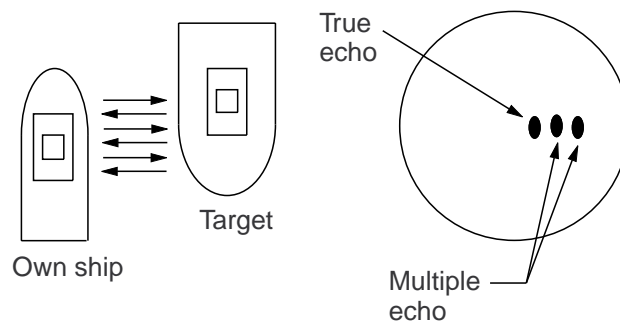

Multiple echoes

2.2.2 Sidelobe echoes

Every time the radar pulse is transmitted, some radiation escapes on each side of the beam, called "sidelobes." If a target exists where it can be detected by the side lobes as well as the main lobe, the side echoes may be represented on both sides of the true echo at the same range. Side lobes show usually only on short ranges and from strong targets. They can be reduced through careful reduction of the gain or proper adjustment of the SEA control.

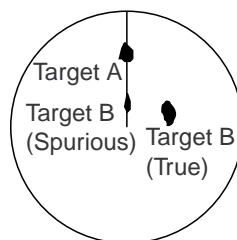

Sidelobe echoes

2.2.3 Virtual image

A relatively large target close to your ship may be represented at two positions on the screen. One of them is the true echo directly reflected by the target and the other is a false echo which is caused by the mirror effect of a large object on or close to your ship as shown in the figure below. If your ship comes close to a large metal bridge, for example, such a false echo may temporarily be seen on the screen.

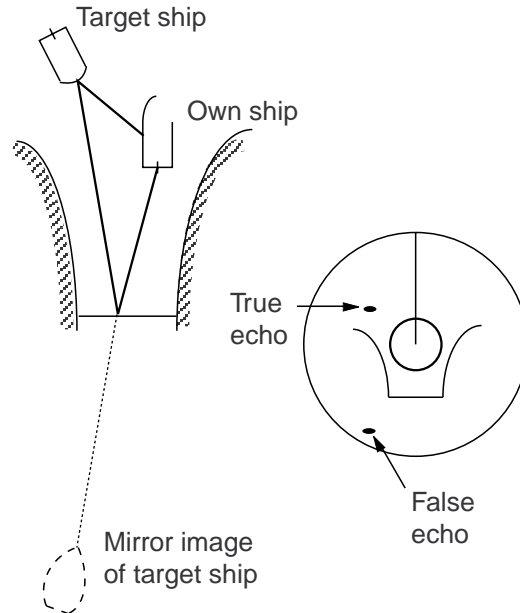

Virtual image

2.2.4 Shadow sector

Funnels, stacks, masts, or derricks in the path of the antenna block the radar beam. If the angle subtended at the antenna is more than a few degrees, a non-detecting sector may be produced. Within this sector targets can not be detected.

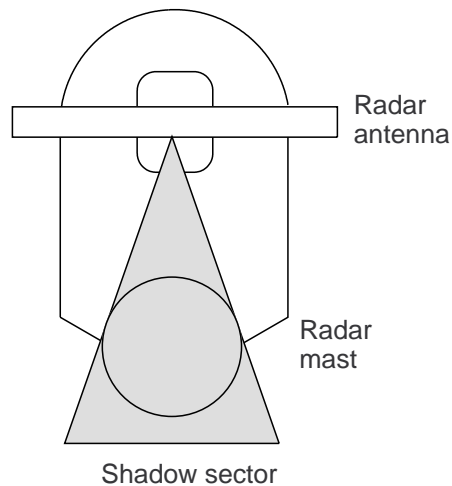

Shadow sectors

2.3 SART (Search and Rescue Transponder)

2.3.1 SART description

A Search and Rescue Transponder (SART) may be triggered by any X-Band (3 cm) radar within a range of approximately 8 nm. Each radar pulse received causes it to transmit a response which is swept repetitively across the complete radar frequency band. When interrogated, it first sweeps rapidly ($0.4 \mu\text{s}$) through the band before beginning a relatively slow sweep ($7.5 \mu\text{s}$) through the band back to the starting frequency. This process is repeated for a total of twelve complete cycles. At some point in each sweep, the SART frequency will match that of the interrogating radar and be within the pass band of the radar receiver. If the SART is within range, the frequency match during each of the 12 slow sweeps will produce a response on the radar display, thus a line of 12 dots equally spaced by about 0.64 nautical miles will be shown.

When the radar to the SART is reduced to about 1 nm, the radar display may show also the 12 responses generated during the fast sweeps. These additional dot responses, which also are equally spaced by 0.64 nautical miles, will be interspersed with the original line of 12 dots. They will appear slightly weaker and smaller than the original dots.

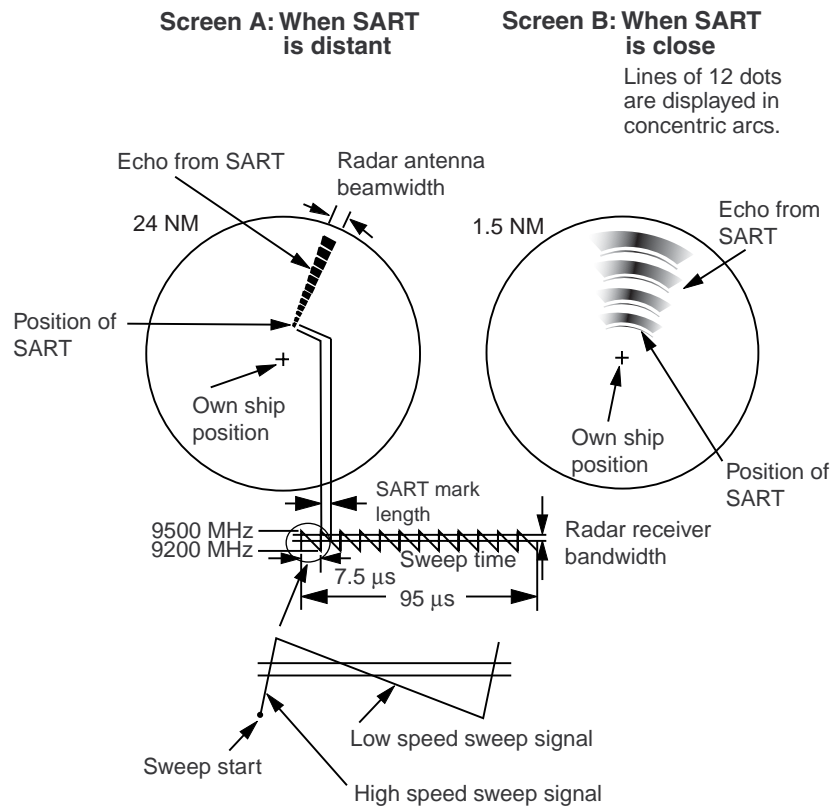

Appearance of SART echo

2.3.2 General remarks on receiving SART

SART range errors

When responses from only the 12 low frequency sweeps are visible (when the SART is at a range greater than about 1 nm), the position at which the first dot is displayed may be as much as 0.64 nm beyond the true position of the SART. When the range closes so that the fast sweep responses are seen also, the first of these will be no more than 150 meters beyond the true position.

Radar bandwidth

This is normally matched to the radar pulse length and is usually switched with the range scale and the associated pulse length. Narrow bandwidths of 3-5 MHz are used with long pulses on long range scales and wide bandwidths of 10-25 MHz with short pulses on short ranges.

A radar bandwidth of less than 5 MHz will attenuate the SART signal slightly, so it is preferable to use a medium bandwidth to ensure optimum detection of the SART.

Radar side lobes

As the SART is approached, side lobes from the radar antenna may show the SART responses as a series of arcs or concentric rings. These can be removed by the use of the anti-clutter sea control although it may be operationally useful to observe the side lobes as they may be easier to detect in clutter conditions and also they will confirm that the SART is near to own ship.

Note: SART information excerpted from IMO SN/Circ 197 OPERATION OF MARINE RADAR FOR SART DETECTION.

2.4 RACON

A RACON is a radar beacon which emits radar receivable signals in the radar frequency spectrum (X- or S-band). There are several signal formats; in general, the RACON signal appears on the radar screen as a rectangular echo originating at a point just beyond the position of the radar beacon. It has a Morse coded pattern. Note that the position on the radar display is not accurate.

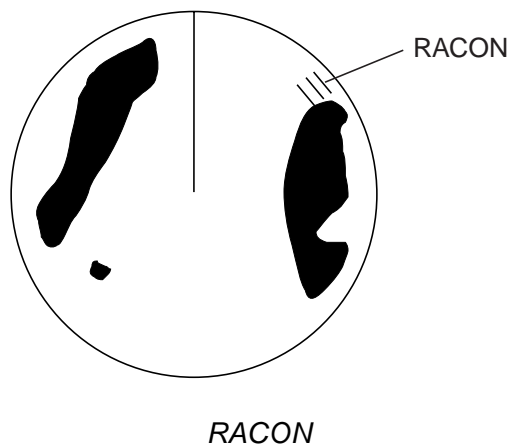

3. ARP OPERATION

The Automatic Radar Plotter ARP-11 (option) manually or automatically acquires and tracks ten targets. Once a target is acquired automatically or manually it is automatically tracked within 0.1 to 32 nm.

3.1 Usage Precautions

CAUTION

No one navigational aid should be relied upon for the safety of vessel and crew. The navigator has the responsibility to check all aids available to confirm position. Electronic aids are not a substitute for basic navigational principles and common sense.

- This auto plotter automatically tracks an automatically or manually acquired radar target and calculates its course and speed, indicating them by a vector. Since the data generated by the auto plotter are based on what radar targets are selected, the radar must always be optimally tuned for use with the auto plotter, to ensure required targets will not be lost or unwanted targets such as sea returns and noise will not be acquired and tracked.
- A target does not always mean a land-mass, reef, ships or other surface vessels but can imply returns from sea surface and clutter. As the level of clutter changes with environment, the operator should properly adjust the A/C SEA, A/C RAIN and GAIN controls to be sure target echoes are not eliminated from the radar screen.

CAUTION

The plotting accuracy and response of this auto plotter meets IMO standards. Tracking accuracy is affected by the following:

- Tracking accuracy is affected by course change. One to two minutes is required to restore vectors to full accuracy after an abrupt course change. (The actual amount depends on gyrocompass specifications.)
- The amount of tracking delay is inversely proportional to the relative speed of the target. Delay is on the order of 15-30 seconds for high relative speed; 30-60 seconds for low relative speed.

Display accuracy is affected by the following:

- Echo intensity
- Radar transmission pulsewidth
- Radar bearing error
- Gyrocompass error
- Course change (own ship or target)

3.2 Controls for Use with ARP

ENTER: Acquires cursor-selected target; Displays data for tracked target (in the data box at the bottom of the screen).

CANCEL/HL OFF: Removes data of cursor-selected tracked target from the data box; stops tracking cursor-selected (when its data is not displayed in the data box).

MENU: Accesses the Target and ARP menus for ARP operations.

Trackball: Chooses target to acquire, cancel tracking or show target data.

3.3 ARP Display On/Off

You may turn off the ARP display as shown below.

1. Press the **MENU** key to display the main menu.
2. Use the trackball to choose ARP and then press the **ENTER** key.

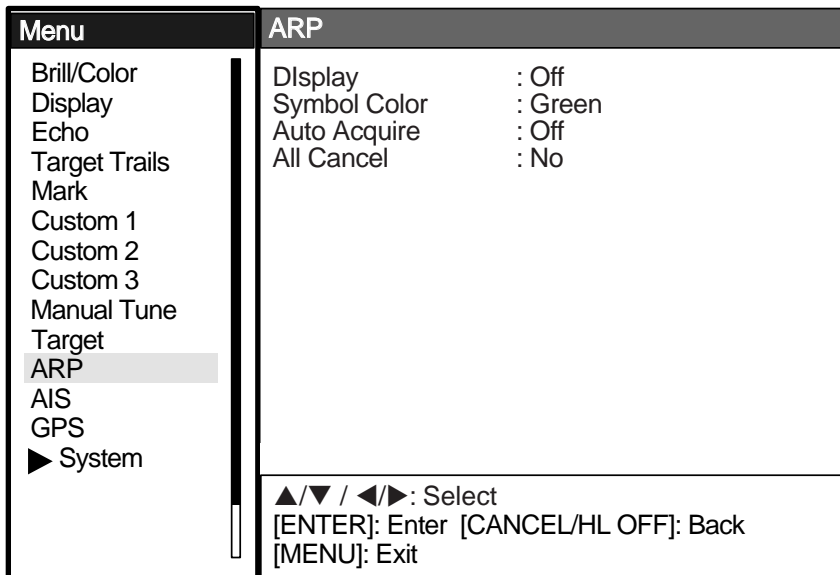

ARP menu

3. Use the trackball to choose Display and then press the **ENTER** key.

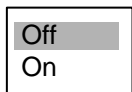

4. Choose Off or On as appropriate and then press the **ENTER** key.
5. Press the **MENU** key to close the menu.

3.4 Acquiring and Tracking Targets

Ten targets may be acquired and tracked manually and automatically. When you attempt to acquire an 11th target, the message "ARP FULL - ALREADY TRACKING 10 TARGETS!" appears for five seconds. To acquire another target, terminate tracking of an unnecessary target, as shown in the paragraph 3.5.

3.4.1 Manual acquisition

When the automatic acquisition (AUTO ACQ. AREA) is set to on, up to five targets may be acquired manually. If you attempt to acquire a sixth target, the alert message appears.

1. Place the cursor on the target to acquire.
2. Press the **ENTER** key.

The plot symbol changes over time as below. A vector appears about one minute after acquisition, indicating the target's motion trend.

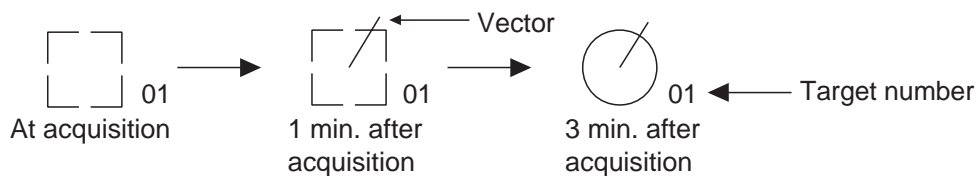

ARP target mark

3.4.2 Automatic acquisition

The ARP can acquire up to ten targets automatically by setting an automatic acquisition area. When automatic acquisition is selected after acquiring targets manually, only the remaining capacity for targets may be automatically acquired. For example, if seven targets have been manually acquired, three targets may be automatically acquired.

The automatic acquisition area is 2.0 to 2.5 miles in range and $\pm 45^\circ$ on either side of the heading line in bearing. Targets being tracked in automatic acquisition are continuously tracked when switching to manual acquisition. Note that targets being tracked in automatic acquisition are continuously tracked when switching to manual acquisition.

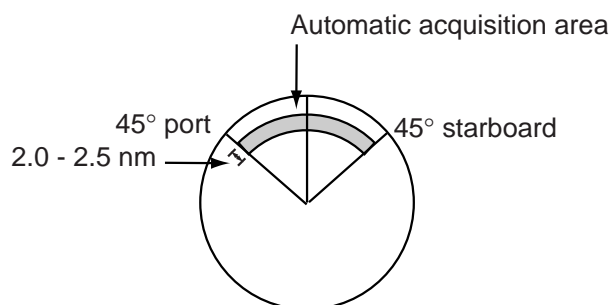

Automatic acquisition area

1. Press the **MENU** key to show the main menu.
2. Choose ARP and then press the **ENTER** key

3. ARP OPERATION

3. Choose Auto Acquire and then press the **ENTER** key.

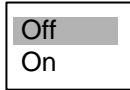

4. Choose On to enable automatic acquisition.
5. Press the **ENTER** key.
6. Press the **MENU** key to close the menu.

3.5 Terminating Tracking of ARP Targets

When ten targets have been acquired, no more acquisition occurs unless targets are cancelled. If you need to acquire additional targets, you must first cancel one or more individual targets, or all targets, using one of the procedures below.

3.5.1 Terminating tracking of selected targets

1. Place the cursor on the target to terminate tracking.
2. Press the **CANCEL/HL OFF** key to terminate tracking and erase the target.

3.5.2 Terminating tracking of all targets

1. Press the **MENU** key to open the menu.
2. Choose ARP and then press the **ENTER** key.
3. Choose All Cancel and then press the **ENTER** key.

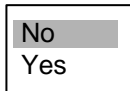

4. Choose Yes.
5. Press the **ENTER** key.
6. Press the **MENU** key to close the menu.

3.6 Vector Attributes

What is a vector?

A vector is a line extending from a tracked target which shows estimated speed and course of the target. The vector tip shows an estimated position of the target after the selected vector time elapses. It can be useful to extend the vector length (time) in order to evaluate the risk of collision with any target.

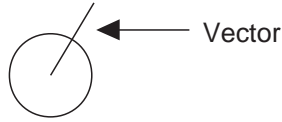

Vector

Vector time, vector reference

Vector time can be set to 30 seconds, 1, 3, 6, 15 or 30 minutes. You may reference the vectors to North (True, requires heading and speed data) or ship's heading (relative) as desired.

1. Press the **MENU** key to open the menu.
2. Choose Target and then press the **ENTER** key.

Menu	Target
Brill/Color	Vector Time : 6 min
Display	Vector Reference : Relative
Echo	History Dots : 5
Target Trails	History Intervals : 1 min
Mark	CPA : 1 nm
Custom 1	TCPA : 1 min
Custom 2	Proximity Alarm : Off
Custom 3	
Manual Tune	
Target	
ARP	
AIS	
GPS	
▶ System	
▲/▼ / ◀/▶: Select [ENTER]: Enter [CANCEL/HL OFF]: Back [MENU]: Exit	

Target menu

3. Choose Vector Time and then press the **ENTER** key.
4. Choose desired vector time and then press the **ENTER** key.
5. Choose Vector Reference and then press the **ENTER** key.
6. Choose Relative or True as appropriate and then press the **ENTER** key.
7. Press the **MENU** key to close the menu.

30sec
1min
3min
6min
15min
30min

Vector time choices

Relative
True

Vector reference choices

Note: The functions of the Target menu are commonly shared by ARP and AIS.

3.7 History Display (target past position)

This radar can display time-spaced dots (maximum ten dots) marking the past positions of any ARP/AIS target being tracked. You can evaluate a target's actions by the spacing between dots. Below are examples of dot spacing and target movement..

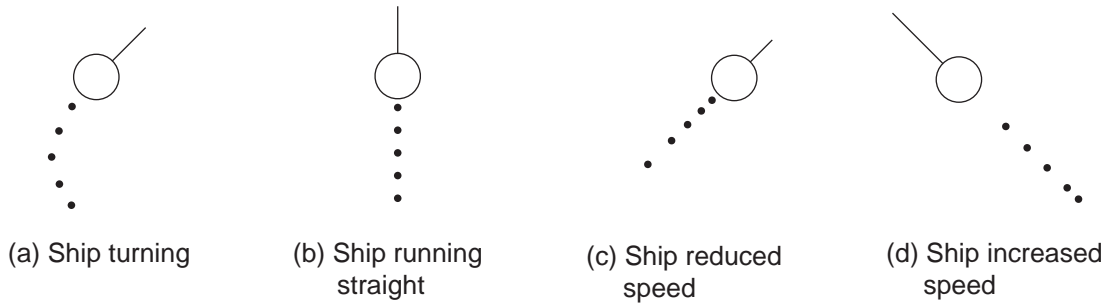

Target movement and history display

You may choose the number of history dots to display and the time interval to display them.

1. Press the **MENU** key to open the menu.
2. Choose Target and then press the **ENTER** key.
3. Choose History Dots and then press the **ENTER** key.

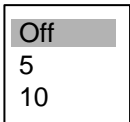

4. Choose number of history dots to display (5 or 10) or choose Off to turn off the history display.
5. Press the **ENTER** key.
6. Choose History Interval and then press the **ENTER** key.

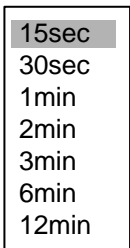

7. Choose appropriate time interval and then press the **ENTER** key.
8. Press the **MENU** key to close the menu.

3.8 ARP Target Data

You can show target data (range, bearing, course, speed, CPA and TCPA) for two tracked ARP targets, in the data box at the bottom of the screen. To display ARP target data, the ARP display must be active and the menu item Data Box in the Display sub menu must be set for Target or All.

1. Place the cursor on the ARP target for which you want to know its data.
2. Press the **ENTER** key to show the target's data.

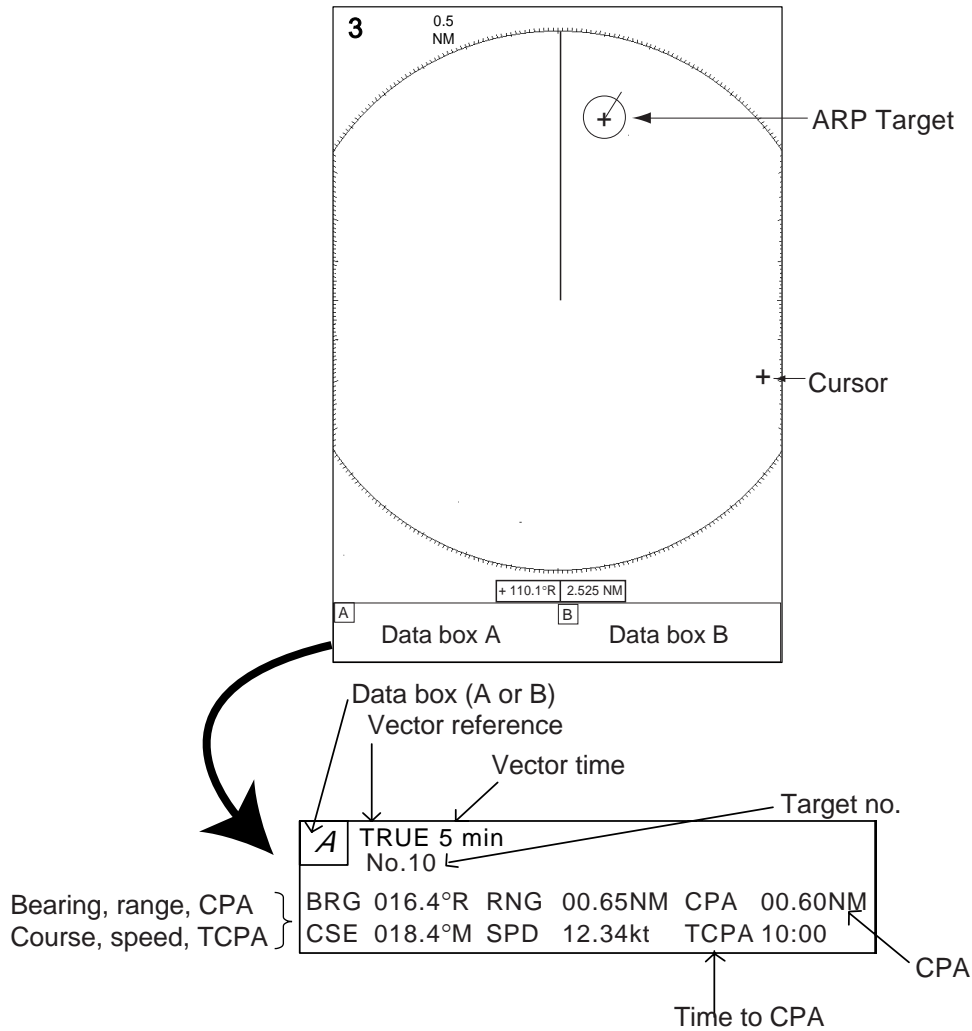

ARP target data

The data for the chosen target is displayed in data box A or B. The box is chosen on a first-in, first-out basis. For example, if both data box A and data box B are currently showing data and an ARP target is selected to show its data, the data in data box A will be erased and replaced with the data of the newly selected ARP target.

To remove a target's data, choose the appropriate data box and press the **CANCEL/HL OFF** key.

3.9 CPA and TCPA Alarm

When the predicted CPA of any ARP/AIS target becomes smaller than a preset CPA alarm range or its predicted TCPA less than a preset TCPA alarm limit, an audio alarm sounds and the collision visual alarm is generated.. In addition, the target plot symbol of the offending target changes to a triangle and flashes together with its vector. You may silence the audio alarm and acknowledge the alarm with the **CANCEL/HL OFF** key. The flashing of the triangle plot symbol continues until you intentionally terminate tracking of the target. The ARP continuously monitors the predicted range at the Closest Point of Approach (CPA) and predicted time to CPA (TCPA) of each track to own ship.

This feature helps alert you to targets which may be on a collision course with own ship. However, it is important that GAIN, SEA, RAIN and other radar controls are properly adjusted and the ARP is set up so that it can track targets effectively..

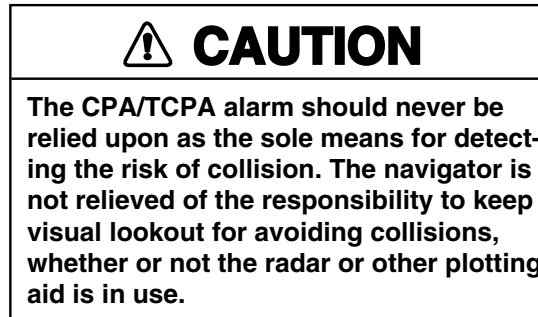

1. Press the **MENU** key to open the menu.
2. Choose Target and then press the **ENTER** key.
3. Choose CPA and then press the **ENTER** key.

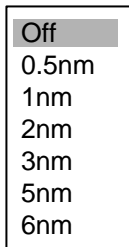

4. Choose appropriate time and then press the **ENTER** key.
5. Choose TCPA and then press the **ENTER** key.

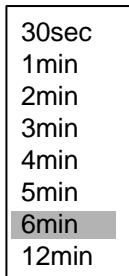

6. Choose appropriate TCPA and then press the **ENTER** key.
7. Press the **MENU** key to close the menu.

3.10 Proximity Alarm

The proximity alerts you by audio and visual alarms when an ARP/AIS target is within the range you specify.

1. Press the **MENU** key to open the menu.
2. Choose Target and then press the **ENTER** key.
3. Choose Proximity Alarm and then press the **ENTER** key.

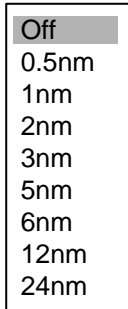

4. Choose appropriate range and then press the **ENTER** key.
5. Press the **MENU** key to close the menu.

3.11 Lost Target

When the system detects a lost target, the target symbol becomes a diamond and tracking is discontinued after one minute.



Lost target mark

Canceling a lost target

Place the cursor on the target and then press the **CANCEL/HL OFF** key.

3.12 Symbol Color

You may choose the ARP/AIS symbol color from among Green, Red, Blue, White or Black.

1. Press the **MENU** key to open the menu.
2. Choose ARP and then press the **ENTER** key.
3. Choose Symbol Color and then press the **ENTER** key.

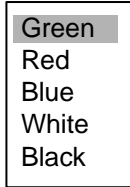

4. Choose appropriate color and then press the **ENTER** key.
5. Press the **MENU** key to close the menu.

4. AIS OPERATION

Connected to an AIS Transponder via an AIS Interface, the FR-8xx2 series can show the name, position and other nav data of the nearest 100 AIS transponder-equipped ships.

This radar accepts position data fixed by WGS-84 geodetic datum. Set the datum to WGS-84 on the GPS navigator connected to this radar. If other type of datum is input, the error message "DATUM" appears and the AIS feature is inoperative.

4.1 Controls for Use with AIS

ENTER: Displays data for cursor-selected active AIS target (in the data box at the bottom of the screen).

CANCEL/HL OFF: Removes data of cursor-selected AIS target from the data box.

MENU: Accesses the Target and AIS menus for AIS operations.

Trackball: Chooses active target to display its data.

4.2 Turning the AIS Display On or Off

You may turn the AIS display on or off. The system continues processing of AIS targets regardless of whether the AIS display is on or off, provided it has been activated.

1. Press the **MENU** key to display the main menu.
2. Choose AIS and then press the **ENTER** key.

Menu	AIS
Brill/Color	Display : Off
Display	Symbol Color : Green
Echo	Range : 3.0nm
Target Trails	Sector Start : 340
Mark	Sector End : 20
Custom 1	Sort By : Range
Custom 2	Number of Target : 100
Custom 3	
Manual Tune	
Target	
ARP	
AIS	
GPS	
▶ System	

▲/▼ / ◀/▶ : Select
[ENTER]: Enter [CANCEL/HL OFF]: Back
[MENU]: Exit

AIS menu

3. Choose Display and then press the **ENTER** key.
4. Choose Off or On as appropriate and then press the **ENTER** key.
5. Press the **MENU** key to close the menu.

4.3 AIS Symbols

When the AIS is turned on, AIS targets are marked with appropriate AIS symbol as below.



AIS symbols

Note 1: AIS symbols are momentarily erased after the screen is redrawn when the heading is changed in the Head-up mode.

Note 2: When no AIS data is received, the message "RECEIVE" appears in the text window. Check the AIS transponder.

4.4 Activating Targets

When you convert a sleeping target to an activated target, that target's course and speed are shown with a vector. You can easily judge target movement by monitoring the vector.

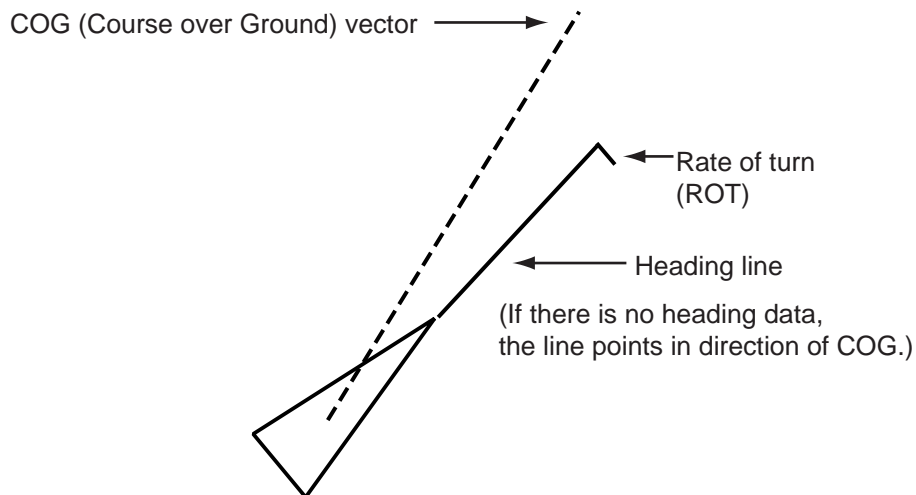

Appearance of an active target

To activate or sleep a target, place the cursor on the target and press the **ENTER** key.

4.5 Displaying AIS Target Data

Place the cursor on the active target that you want to know its data.

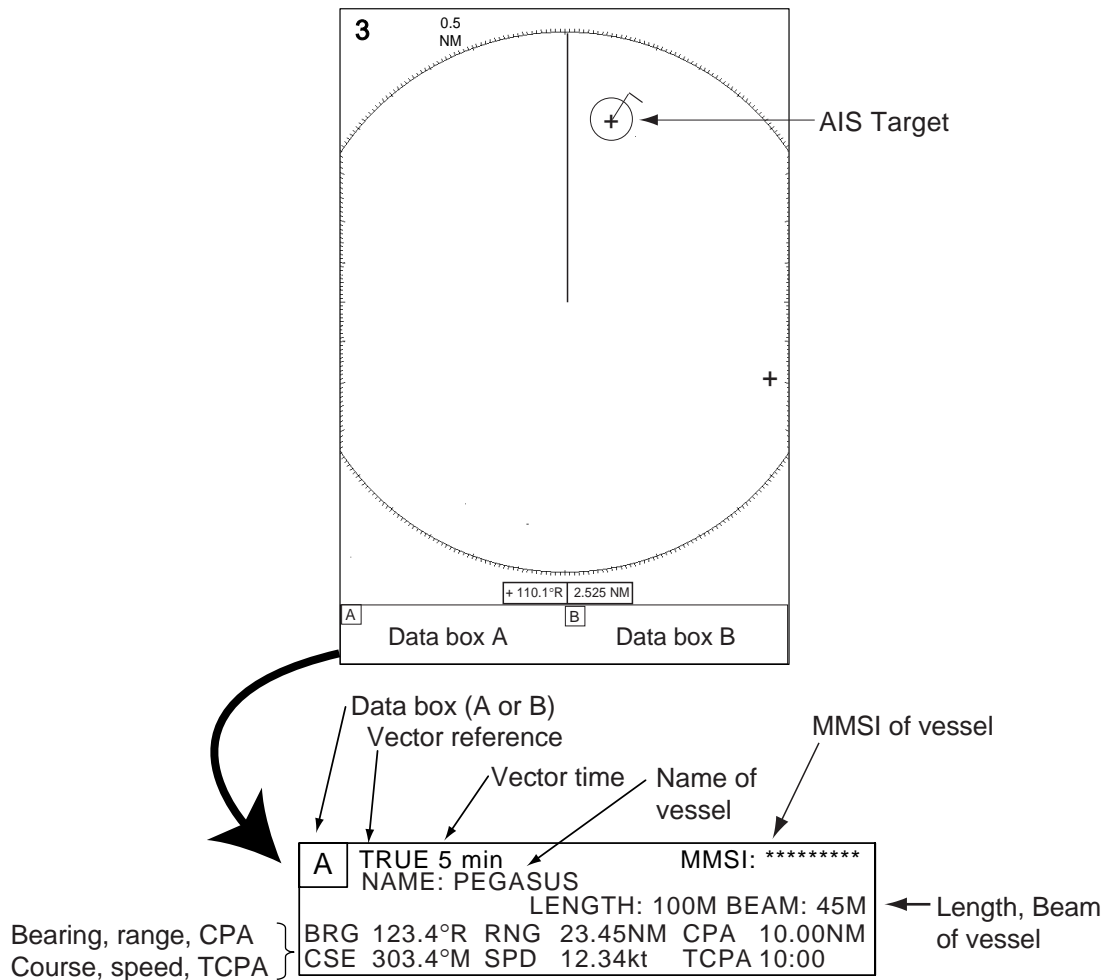

AIS data

The data for the chosen target is displayed in data box A or B. The box is chosen on a first-in, first-out basis. For example, if both data box A and data box B are currently showing data and an AIS target is selected to show its data, the data in data box A will be erased and replaced with the data of the newly selected AIS target.

To remove a target's data, choose the appropriate data box and press the **CANCEL/HL OFF** key.

4.6 Display Range

You may set the AIS target display range as below. This allows you to view only those AIS targets within the range you specify. The setting range is 0-96 miles but actual range depends on the connected AIS Transponder. If the target sorting method is selected to "Range," the target data within the range set here are transmitted to this radar.

1. Press the **MENU** key to open the menu.
2. Choose AIS and then press the **ENTER** key.
3. Choose Range and then press the **ENTER** key.

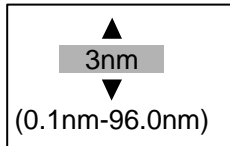

4. Use the trackball to set the display range and then press the **ENTER** key.
5. Press the **MENU** key to close the menu.

4.7 Sorting Targets

You may sort AIS targets by range from own ship, by sector, by CPA or TCPA.

1. Press the **MENU** key to open the menu.
2. Choose AIS and then press the **ENTER** key.
3. Choose Range and then press the **ENTER** key.

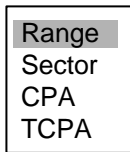

4. Use the trackball to choose desired sorting method and then press the **ENTER** key. For "Sector", the data for targets within the sector are transmitted to this radar.
5. Press the **MENU** key to close the menu.

4.8 Display Sector

You may choose the area where to display AIS targets. The range of the sector may be from 0° to 359°.

1. Press the **MENU** key to open the menu.
2. Choose AIS and then press the **ENTER** key.
3. Choose Sector Start and then press the **ENTER** key.

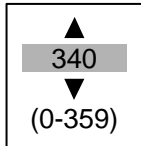

4. Use the trackball to set the starting point for the sector and then press the **ENTER** key.
5. Choose Sector End and then press the **ENTER** key.

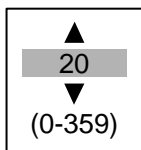

6. Use the trackball to set the end point for the sector and then press the **ENTER** key.
7. Press the **MENU** key to close the menu.

4.9 Number of Targets to Display

You may choose the number of AIS targets to display, from 10-100. This feature is useful when the screen becomes cluttered with AIS targets.

1. Press the **MENU** key to open the menu.
2. Choose AIS and then press the **ENTER** key.
3. Choose Number of Targets and then press the **ENTER** key.

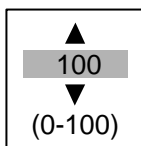

4. Use the trackball to choose the number of targets to display and then press the **ENTER** key. Press the **MENU** key to close the menu.

4.10 Vector Attributes

What is a vector?

A vector is a line extending from a tracked target which shows estimated course of the AIS target. The vector tip shows an estimated position of the target after the selected vector time elapses. It can be useful to extend the vector length (time) in order to evaluate the risk of collision with any target. (See the illustration on page 4-2 for the appearance of a vector.)

Vector time, vector reference

Vector time can be set to 30 seconds, 1, 3, 6, 15 or 30 minutes. You may reference the vectors to North (True, requires heading and speed data) or ship's heading (relative) as desired.

1. Press the **MENU** key to open the menu.
2. Choose Target and then press the **ENTER** key.

Menu	Target
Brill/Color	Vector Time : 6 min
Display	Vector Reference : Relative
Echo	History Dots : 5
Target Trails	History Intervals : 1 min
Mark	CPA : 1 nm
Custom 1	TCPA : 1 min
Custom 2	Proximity Alarm : Off
Custom 3	
Manual Tune	
Target	
ARP	
AIS	
GPS	
▶ System	
▲/▼ / ◀/▶ : Select [ENTER]: Enter [CANCEL/HL OFF]: Back [MENU]: Exit	

Target menu

3. Choose Vector Time and then press the **ENTER** key.
4. Choose desired vector time and then press the **ENTER** key.
5. Choose Vector Reference and then press the **ENTER** key.
6. Choose Relative or True as appropriate and then press the **ENTER** key.
7. Press the **MENU** key to close the menu.

30sec
1min
3min
6min
15min
30min

Vector time choices

Relative
True

Vector reference choices

4.11 History Display (target past position)

This radar can display time-spaced dots (maximum ten dots) marking the past positions of any ARP/AIS target being tracked. You can evaluate a target's actions by the spacing between dots. Below are examples of dot spacing and target movement.

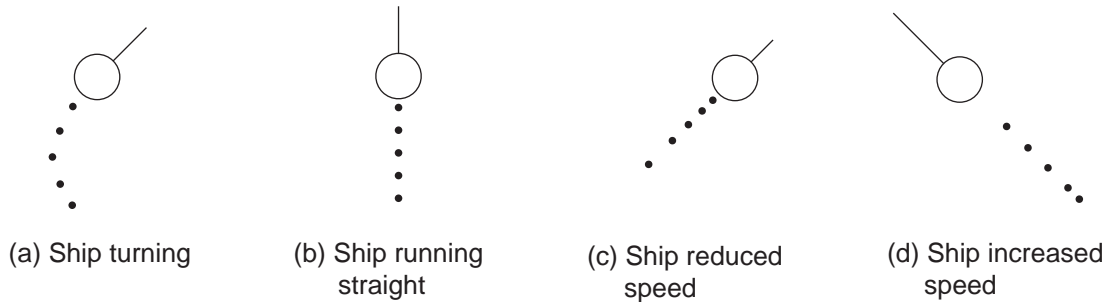

Target movement and history display

You may choose the number of history dots to display and the time interval to display them.

1. Press the **MENU** key to open the menu.
2. Choose Target and then press the **ENTER** key.
3. Choose History Dots and then press the **ENTER** key.

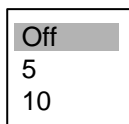

4. Choose number of history dots to display (5 or 10) or choose Off to turn off the history display.
5. Press the **ENTER** key.
6. Choose History Interval and then press the **ENTER** key.

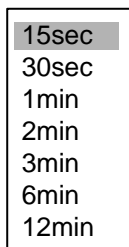

7. Choose appropriate time interval and then press the **ENTER** key.
8. Press the **MENU** key to close the menu.

4.12 CPA and TCPA Alarm

When the predicted CPA of any ARP/AIS target becomes smaller than a preset CPA alarm range or its predicted TCPA less than a preset TCPA alarm limit, an audio alarm sounds and the symbol of the offending AIS target changes to the dangerous target symbol.

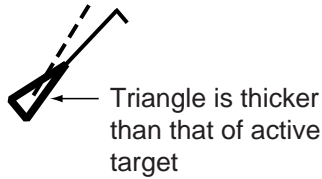

Dangerous target symbol

You may silence the audio alarm with the **CANCEL/HL OFF** key. The flashing of the symbol continues until you intentionally terminate tracking of the target. The ARP continuously monitors the predicted range at the Closest Point of Approach (CPA) and predicted time to CPA (TCPA) of each AIS target.

This feature helps alert you to targets which may be on a collision course with own ship. However, it is important that GAIN, SEA, RAIN and other radar controls are properly adjusted.

1. Press the **MENU** key to open the menu.
2. Choose Target and then press the **ENTER** key.
3. Choose CPA and then press the **ENTER** key.

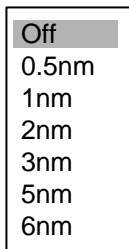

4. Choose appropriate time and then press the **ENTER** key.
5. Choose TCPA and then press the **ENTER** key.

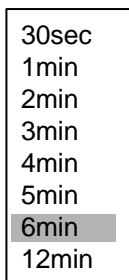

6. Choose appropriate TCPA and then press the **ENTER** key.
7. Press the **MENU** key to close the menu.

4.13 Proximity Alarm

The proximity alerts you by audio and visual alarms when an ARP/AIS target is within the range you specify.

1. Press the **MENU** key to open the menu.
2. Choose Target and then press the **ENTER** key.
3. Choose Proximity Alarm and then press the **ENTER** key.

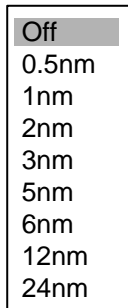

4. Choose appropriate range and then press the **ENTER** key.
5. Press the **MENU** key to close the menu.

4.14 Lost Target

When the system detects a lost target, the target symbol becomes a diamond and tracking is discontinued after one minute.



Lost target mark

Canceling a lost target

Place the cursor on the target and then press the **CANCEL/HL OFF** key.

4.15 Symbol Color

You may choose the ARP/AIS symbol color from among Green, Red, Blue, White or Black.

1. Press the **MENU** key to open the menu.
2. Choose ARP and then press the **ENTER** key.
3. Choose Symbol Color and then press the **ENTER** key.

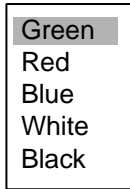

4. Choose appropriate color and then press the **ENTER** key.
5. Press the **MENU** key to close the menu.

5. GPS OPERATION

With connection of a FURUNO GPS navigator, you may set up the GPS navigator from this radar.

5.1 Navigator Type

1. Press the **MENU** key to show the menu.
2. Choose GPS and then press the **ENTER** key.

Menu	GPS
Brill/Color	Type : WAAS
Display	Datum : WGS-84
Echo	Datum Number : 001
Target Trails	WAAS : Auto
Mark	WAAS Number : 120
Custom 1	GPS Self Test
Custom 2	Satellite Monitor
Custom 3	Type 16 Message
Manual Tune	Forward Offset : 0
Target	Right Offset : 0
ARP	Cold Start
AIS	
GPS	
▶ System	

▲/▼ / ◀/▶ : Select
[ENTER]: Enter [CANCEL/HL OFF]: Back
[MENU]: Exit

GPS menu

3. Choose Type and then press the **ENTER** key.

GPS
WAAS
DGPS

4. Choose type of navigator connected to this radar and then press the **ENTER** key.
5. Press the **MENU** key to close the menu.

5.2 Datum

Choose the datum type which matches the paper nautical charts you are using. Choose WGS-84 if the radar is interfaced to an AIS Transponder.

1. Press the **MENU** key to show the menu.
2. Choose GPS and then press the **ENTER** key.
3. Choose Datum and then press the **ENTER** key.

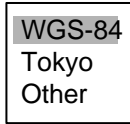

4. Choose appropriate datum type and then press the **ENTER** key. For Other, do steps 5 and 6. For other choices, go to step 7.
5. Choose Datum Number and then press the **ENTER** key.

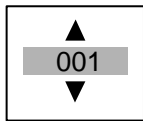

6. Use the trackball to choose datum number and then press the **ENTER** key.
7. Press the **MENU** key to close the menu.

5.3 WAAS Setup

Choose either automatic or manual WAAS satellite tracking. For manual tracking choose the WAAS satellite to use.

1. Press the **MENU** key to show the menu.
2. Choose GPS and then press the **ENTER** key.
3. Choose WAAS and then press the **ENTER** key.

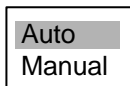

4. Choose Auto or Manual as appropriate and then press the **ENTER** key. For Manual, do steps 5 and 6. For Auto, go to step 7.
5. Choose WAAS Number and then press the **ENTER** key.

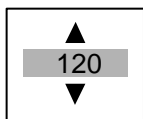

6. Use the trackball to choose appropriate WAAS satellite number and then press the **ENTER** key.
7. Press the **MENU** key to close the menu.

5.4 Satellite Monitor

The Satellite Monitor provides comprehensive information about GPS and WAAS satellites. For more detailed information, see your GPS navigator's owner's manual.

1. Press the **MENU** key to show the menu.
2. Choose GPS and then press the **ENTER** key.
3. Choose Satellite Monitor and then press the **ENTER** key.

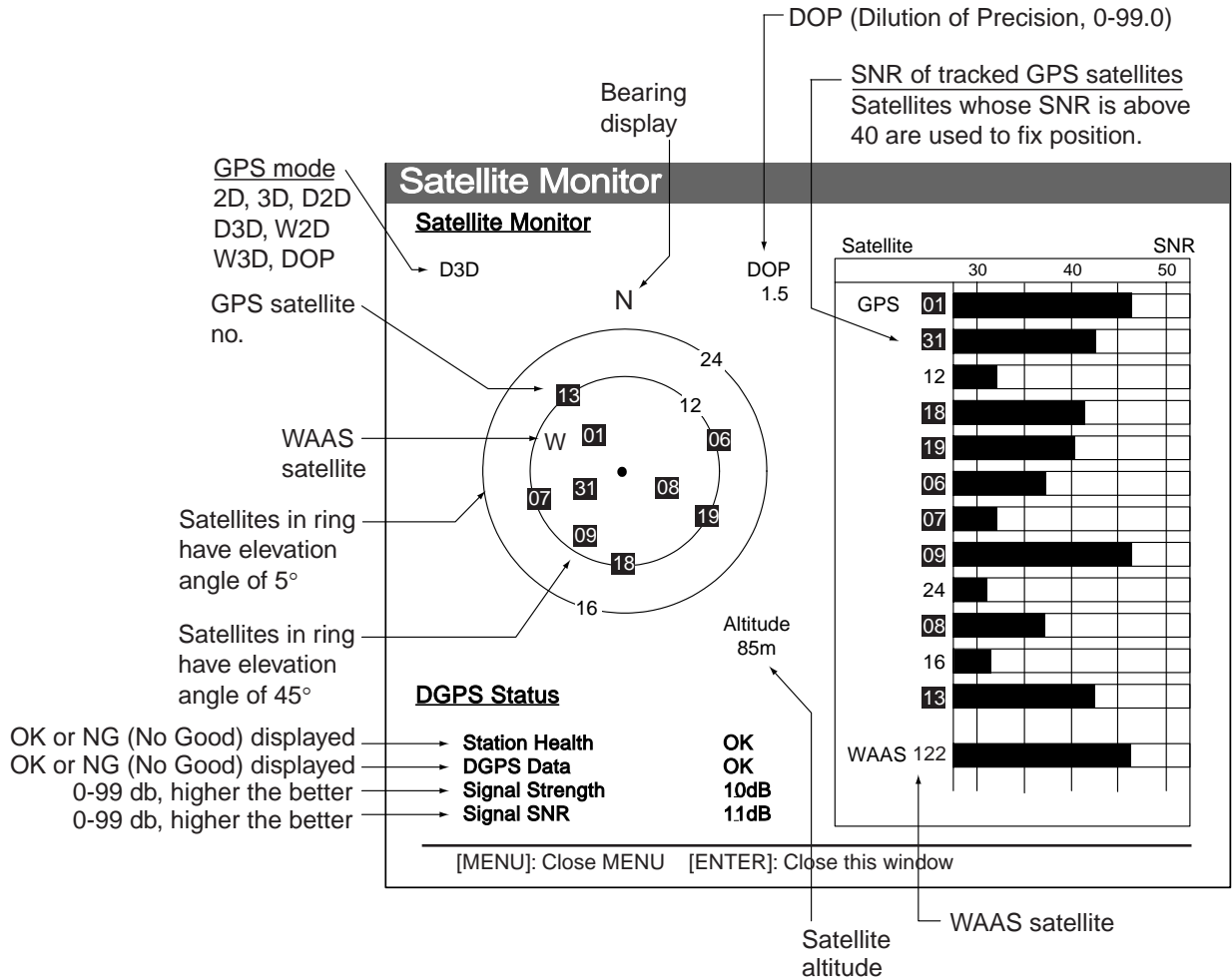

Satellite monitor

To close only the satellite monitor display, press the **ENTER** key.

5.5 Type 16 Message

The type 16 message provides weather information. It is transmitted by the Japan Maritime Safety Agency, thus you must be within the transmitting range of a Japanese DGPS reference station to receive this type of message.

You may display this type of message as follows:

1. Press the **MENU** key to show the menu.
2. Choose GPS and then press the **ENTER** key.
3. Choose Type 16 Message and then press the **ENTER** key. (If no messages are present you cannot choose this menu item.)

Type 16 Message						
Type 16 Message	Time	Wind Direction/Speed	Pressure	Wave		
Murotasaki	13:25	ENE	5m	1015hPa	10m	
	13:55	NE	10m	1016hPa	13m	
Kobe	13:50	N	5m	1017hPa	9m	
	13:55	NW	10m	1017hPa	10m	
Osakako	13:45	NW	5m	1015hPa	11m	
	13:15	N	10m	1017hPa	10m	
Oseki	13:35	SSW	5m	1013hPa	8m	
	13:05	S	10m	1015hPa	9m	
Tomgashima	13:30	NW	5m	1015hPa	5m	
	13:00	W	10m	1016hPa	10m	
Shinomisaki	13:30	NW	5m	1015hPa	5m	
	13:00	W	10m	1016hPa	10m	
[MENU]: Close MENU [ENTER]: Close this window						

Type 16 message

Weather messages from as many as six DGPS reference stations are shown and the latest is at the top. The oldest message is erased when a new message arrives.

To close only the message board, press the **ENTER** key.

5.6 GPS Sensor Installation Position Offset

The installation position of the GPS sensor antenna and the radar antenna must be the same in order to get accurate position information on the radar. If they are different, measure the distance between the GPS sensor antenna and the radar antenna, in the bow/stern and/or port/starboard direction, and enter those distances in the radar as follows:

1. Press the **MENU** key to show the menu.
2. Choose GPS and then press the **ENTER** key.
3. Choose Forward Offset (bow or stern offset) or Right Offset (port or starboard offset) as appropriate and then press the **ENTER** key.

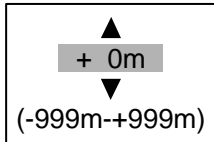

4. Use the trackball to set value and then press the **ENTER** key.
+ value: Bow direction, port direction
- value: Stern direction, starboard direction
5. Press the **MENU** key to close the menu.

5.7 Cold Start

A cold start may be necessary in the following conditions:

- If the GPS receiver has been powered off for a long period of time.
- The vessel has far away from the previous fixing position (e.g., more than 500 km).
- Other reason that prevents the receiver from finding its position within five minutes after power on.

To perform a cold start, do the following:



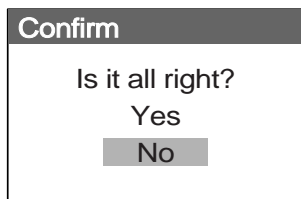

1. Press the **MENU** key to show the menu.
2. Choose GPS and then press the **ENTER** key.
3. Choose Cold Start and then press the **ENTER** key.



4. Choose Yes and then press the **ENTER** key.
5. Press the **MENU** key to close the menu.

6. MAINTENANCE & TROUBLESHOOTING

This chapter provides the necessary procedures for maintenance and troubleshooting. Follow the recommend procedures to keep your radar in good working order.

 WARNING	
	<p>Do not open the equipment.</p> <p>Hazardous voltage which can cause electrical shock exists inside the equipment. Only qualified personnel should work inside the equipment.</p>
	<p>Turn off the radar power switch before servicing the antenna unit. Post a warning sign near the switch indicating it should not be turned on while the antenna unit is being serviced.</p>
	<p>Prevent the potential risk of being struck by the rotating antenna and exposure to RF radiation hazard.</p>
	<p>Wear a safety belt and hard hat when working on the antenna unit.</p> <p>Serious injury or death can result if someone falls from the radar antenna mast.</p>

6.1 Preventive Maintenance

Regular maintenance is important for optimum performance. A maintenance program should be established and should at least include the items shown in the table below.

Maintenance

Interval	Item	Check point	Remedy
When necessary	LCD	The LCD will, in time, accumulate a coating of dust which tends to dim the picture. Wipe LCD lightly with soft cloth to remove dust.	Wipe the LCD carefully to prevent scratching, using tissue paper and an LCD cleaner. To remove dirt or salt deposits, use an LCD cleaner, wiping slowly with tissue paper so as to dissolve the dirt or salt. Change paper frequently so the salt or dirt will not scratch the LCD. Do not use solvents such as thinner, acetone or benzene for cleaning. They may remove paint and markings.
3 to 6 months	Ground terminal on display unit	Check for tight connection and rust.	Tighten or replace as necessary.
	Display unit connectors	Check for tight connection.	Tighten if loosened.
	Exposed nuts and bolts on antenna unit	Check for corroded or loosened bolts.	Clean and repaint as necessary. Sealing compound may be used in place of paint.
	Antenna radiator	Check for dirt and cracks on radiator surface.	Clean radiator surface with freshwater-moistened cloth. Do not use plastic solvents for cleaning.

6.2 Replacement of Fuses

The fuse on the power cable protects the equipment from reverse polarity of the ship's mains and equipment fault. If the fuse blows, find out the cause before replacing it. Use the correct fuse. Using the wrong fuse will damage the equipment and void the warranty.



Unit and fuses

Unit	Power supply	Fuse
Display unit	12 V	15 A
	24 V	10 A
Power supply unit (for FR-8252)	12 V	15 A
	24 V	10 A

6.3 Replacing the Magnetron

When the magnetron has expired, distant targets cannot be seen on the display. When you feel that long range performance has decreased, contact a FURUNO agent or dealer about replacement.

Model and magnetron

Model	Magnetron type	Code No.
FR-8062	MAF1422B	000-146-871
FR-8122	MAF1425B	000-146-872
FR-8252	MAF1458B	000-140-344

6.4 Trackball Maintenance

If the cursor skips or moves abnormally, you may need to clean the Trackball.

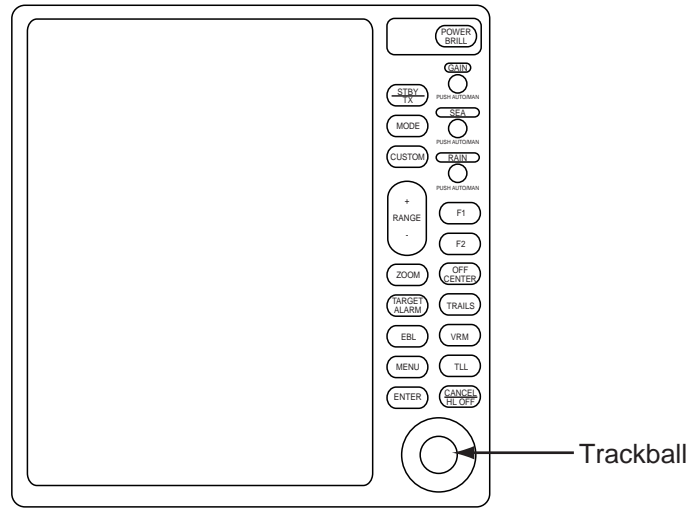

Display unit

1. Turn the retainer ring counterclockwise 45° to unlock it.
2. Remove the retainer ring and ball.
3. Clean the ball with a soft lint-free cloth, and then blow carefully into the ball-cage to dislodge dust and lint.
4. Look for a build-up of dirt on the metal rollers. If dirty, clean the rollers with a cotton swab moistened lightly with isopropyl-rubbing alcohol.
5. Make sure that fluff from the swab is not left on the rollers.
6. Replace the ball and retainer ring. Be sure the retainer ring is not inserted reversely.

Trackball maintenance parts are available as below.

Part	Type No.	Code No.
Retainer ring and ball	MU3721	000-144-645

6.5 Simple Troubleshooting

This section provides simple troubleshooting procedures which the user can follow to restore normal operation. If you cannot restore normal operation do not attempt to check inside the unit. Any trouble should be referred to a qualified technician.

Simple troubleshooting

If...	But...	Then...
you cannot turn on the power		<ul style="list-style-type: none"> • Check for blown fuse. • Check that the power connector is firmly fastened. • Check for corrosion on the power cable connector. • Check for damaged power cable. • Check battery for proper voltage output (10.8-31.2 V).
there is no response when a key is pressed		Turn off and on the power. If there still is no response the key may be faulty. Contact your dealer for advice.
if the power is on and you operated the STBY/TX key to transmit	nothing appears on the display	Check that the antenna cable is firmly fastened.
marks and legends appears	no echo appears	Check that the antenna cable is firmly fastened.
tuning is properly adjusted	sensitivity is poor	The magnetron may need to be replaced. Contact your dealer.
the range is changed	but radar picture does not change	<ul style="list-style-type: none"> • Try to hit the RANGE key again. • Turn the display unit off and on.
there is poor discrimination in range		Adjust the SEA control.
the true motion presentation is not working properly		<ul style="list-style-type: none"> • Reselect the true motion mode. • Check if heading and speed are input.
the range rings are not displayed		Check that the setting of Range Rings Brill in the Brill/Color sub menu is set to other than Off.

6.6 Advanced-level Troubleshooting

This paragraph describes how to cure hardware and software troubles which should be carried out by qualified service personnel.

Note: This radar equipment contains complex modules in which fault diagnosis and repair down to component level are not practicable by users.

Advanced-level troubleshooting

Problem	Probable cause or check points	Remedy
Power turned on but radar does not work	<ol style="list-style-type: none"> 1) Blown fuse. 2) Mains voltage/polarity 3) Power supply board 	<ol style="list-style-type: none"> 1) Replace blown fuse. 2) Correct wiring and input voltage. 3) Replace power supply board.
Brilliance adjusted but no picture	<ol style="list-style-type: none"> 1) SPU Board 	<ol style="list-style-type: none"> 1) Replace SPU board.
Antenna not rotating	<ol style="list-style-type: none"> 1) Antenna drive mechanism 	<ol style="list-style-type: none"> 1) Replace antenna drive mechanism.
Data and marks not displayed in Transmit status	<ol style="list-style-type: none"> 1) SPU board 	<ol style="list-style-type: none"> 1) Replace SPU board.
Adjust GAIN with SEA set at minimum. Marks and indications appear but no noise or echo	<ol style="list-style-type: none"> 1) IF amplifier 2) Signal cable between antenna and processor unit 3. Video amplifier board 	<ol style="list-style-type: none"> 1) Replace IF amplifier. 2) Check continuity and isolation of coaxial cable. <p>Note: Disconnect the plug and lugs at both ends of coaxial cable before checking it (by ohmmeter).</p> <ol style="list-style-type: none"> 3) Check coax line for secure connection. If connection is good, replace SPU board.
Marks, indications and noise appear but no echo (Transmission leak representing own ship position is absent)	<ol style="list-style-type: none"> 1) Tx fuse 2) Magnetron 3) Modulator board 4) SPU board 	<ol style="list-style-type: none"> 1) If fuse has blown, replace it. If it blows again, the modulator or associated circuit may be defective. 2) Check magnetron current. 3) Replace modulator board. 4) Replace SPU board.
Picture not updated or picture freeze-up	<ol style="list-style-type: none"> 1) Bearing signal generator 2) SPU board 3) Video freeze-up 	<ol style="list-style-type: none"> 1) Check that signal cables are fastened securely. 2) Replace SPU board. 3) Turn the radar off and on.
Radar is properly tuned but sensitivity is poor	<ol style="list-style-type: none"> 1) Deteriorated magnetron 2) Detuned MIC 3) Dirt on radiator face 4) 2nd trace echo rejector is ON. 	<ol style="list-style-type: none"> 1) With the radar transmitting on 48 nm range, check magnetron current. If current is below normal, magnetron may be defective. Replace the magnetron. 2) Check MIC detecting current. If it is below normal value, MIC may have become detuned. MIC must be tuned 3) Clean radiator. 4) Turn off the 2nd trace echo rejector, on the Echo menu.

Advanced-level troubleshooting

Problem	Probable cause or check points	Remedy
Range changed but radar picture does not change	1) Defective range key 2) SPU board 3) Video freeze-up	1) Try to operate the RANGE key. If unsuccessful, replacement of the keypad may be necessary. 2) Replace SPU board. 3) Turn radar off and on.
Interference rejector is not working (interference rejection level not displayed)	1) SPU Board	1) Replace SPU Board.
Echo stretch is not working (Neither ES1, ES2 or ES3 is displayed)	1) SPU Board	1) SPU Board
Range rings are not displayed	1) Adjust their brilliance on the Brill/Color menu. 2) SPU Board	1) Replace associated circuit board if unsuccessful. 2) Replace SPU Board.
Poor discrimination in range	Sea clutter control not functioning properly	Improper adjustment of SEA control.
True motion presentation not working properly	1) Poor contact of MODE key. 2) TM display accurate	1) Try to press the key a little harder. 2) Make sure that speed and compass inputs are accurate.
Target not tracked correctly	Poor definition of targets in sea clutter	Adjust SEA and RAIN controls.

6.7 System Test

The diagnostic test checks the system for proper operation.

1. Press the **MENU** key to open the menu.
2. Use the trackball to choose Factory from the System menu and then press the **ENTER** key.

Menu	Factory
Brill/Color	Test
Display	LCD Pattern
Echo	Memory Clear
Target Trails	
Mark	
Custom 1	
Custom 2	
Custom 3	
Manual Tune	
Target	
ARP	
AIS	
GPS	
▼ System	
Initial	▲/▼ / ◀/▶: Select
Factory	[ENTER]: Enter [CANCEL/HL OFF]: Back
Installation	[MENU]: Exit

Factory menu

3. Use the trackball to choose Test and then press the **ENTER** key.

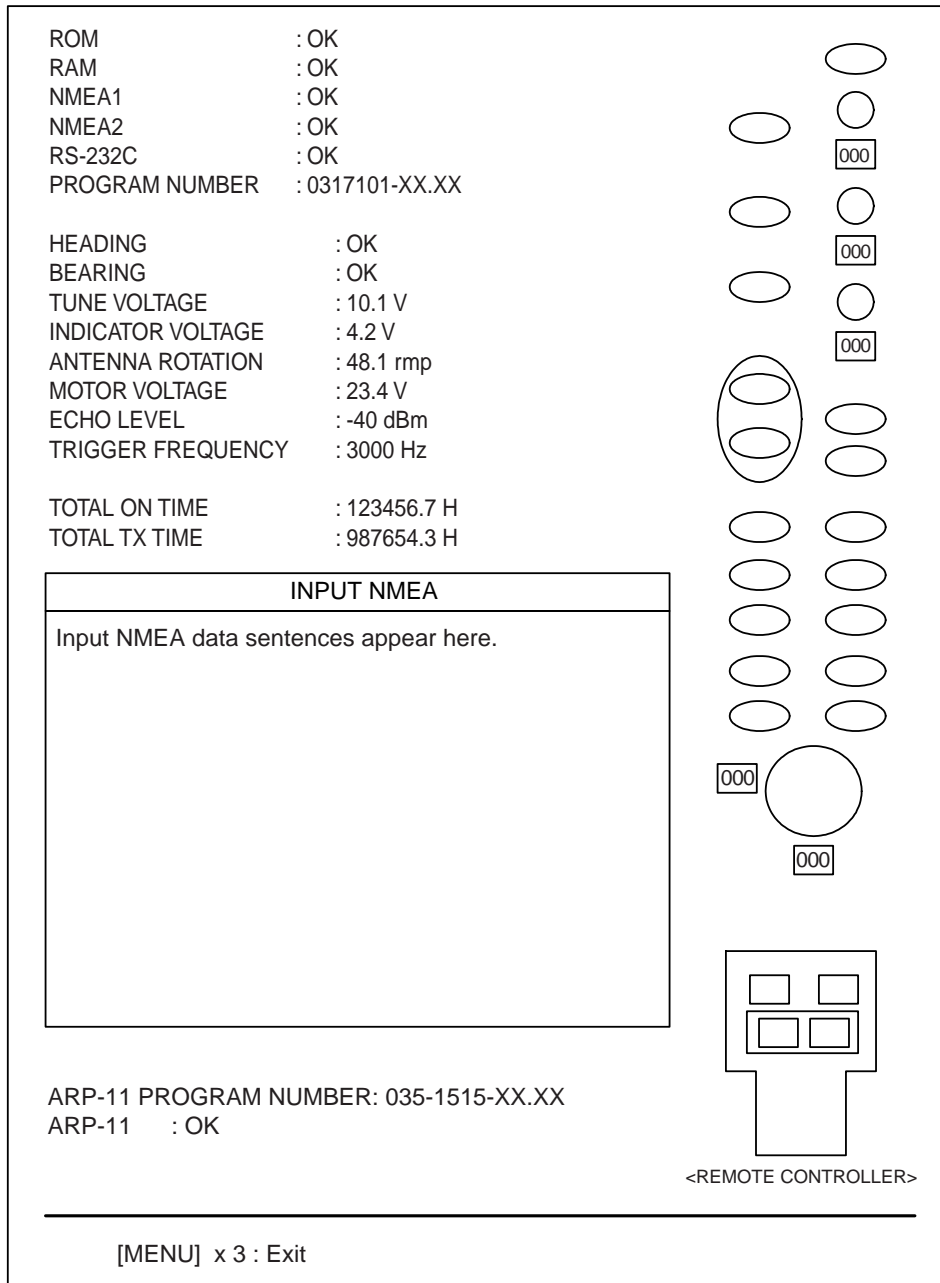

Diagnostics screen

- At the top of the screen the results of system checks are displayed. OK or NG (No Good) is shown as the result for the check of ROM, RAM, data ports NMEA1 and NMEA2 (blank if no data is input) and RS-232C. For any NG contact your dealer for advice. PROGRAM NUMBER shows program number and program version number.
- Heading and bearing signals are checked for proper input and the result displayed as OK or NG. Tune and indicator voltages, antenna rotation speed, antenna motor voltage, echo level and trigger frequency are measured and shown. TOTAL ON TIME and TOTAL TX TIME show the total number of hours the radar has been powered and transmitted, respectively.
- The INPUT NMEA window shows all the NMEA sentences being input to this radar.
- If the optional ARP-11 is connected, its program number and test results are shown below the INPUT NMEA window.

6. MAINTENANCE & TROUBLESHOOTING

- At the right side of the display there are squares, circles and ovals, and they are for checking the controls of the display unit and remote controller. Press each key one by one. The key's on location "lights" (color depends on color scheme in use) if the key is functioning normally and extinguishes when the key is released. For the GAIN, SEA and RAIN controls the three-digits below each control changes according to control position, and the range is 0-100. The three digits below the trackball show the trackball's on-screen X-Y position and the range of display is 0-255.

4. Press the **MENU** key three times on the display unit or remote controller to escape from the test.

6.8 LCD Test

The LCD pattern test checks the LCD for proper display of colors.

1. Press the **MENU** key to open the menu.
2. Use the trackball to choose Factory from the System menu and then press the **ENTER** key.
3. Use the trackball to choose LCD Pattern and then press the **ENTER** key.

The screen is initially all white. Hit the **MENU** key to display the test pattern for black, red, blue and green colors.

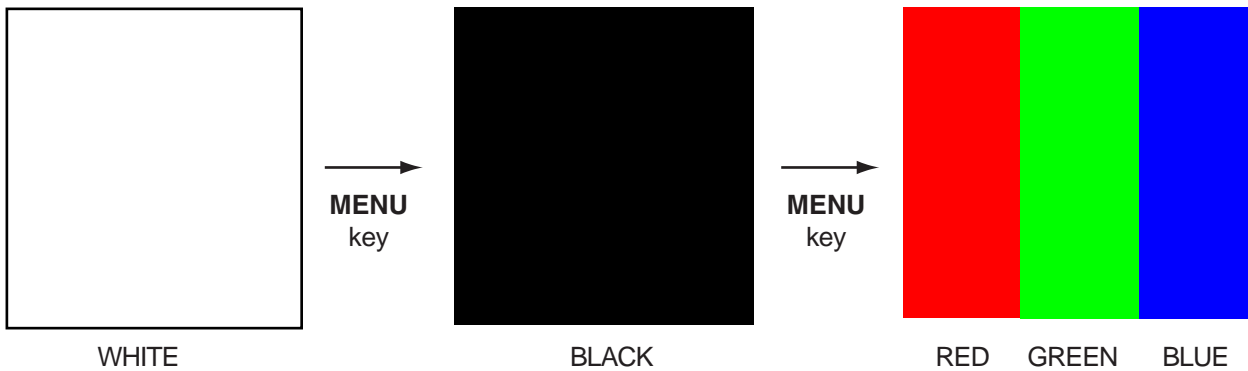

LCD test screens

4. Press the **MENU** key to close the menu.

6.9 GPS Test

The FURUNO GPS receiver interfaced with this radar can be checked for proper operation as follows:

1. Press the **MENU** key to open the menu.
2. Use the trackball to choose GPS and then press the **ENTER** key.
3. Use the trackball to choose GPS Self Test and then press the **ENTER** key. The program no. and results of the test are shown, as OK or NG (No Good). For NG, check the GPS receiver

GPS Self Test	
GPS Self Test	
Program No.	: 48502380XX
Result	: OK

XX = Program version no.

GPS self test results

4. Press the **MENU** key to close the menu.

6.10 Clearing the Memory

You may wish to clear the memory to restore all default settings, to start afresh.

1. Press the **MENU** key to open the menu.
2. Use the trackball to choose Factory from the System menu and then press the **ENTER** key.
3. Use the trackball to choose Memory Clear and then press the **ENTER** key. You are asked if you are sure to clear the memory.

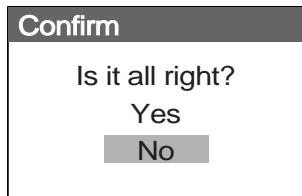

4. Choose Yes and then press the ENTER key to clear the memory.
5. When the memory is cleared a long buzzer sounds.

**SPECIFICATIONS OF MARINE RADAR
FR-8062/FR-8122/FR-8252**

1. GENERAL

1.1 Range, Pulse length, (PL) & Pulse repetition rate (PRR)

Range (nm)	Pulse length (μs)	PRR (Hz approx.)
0.125 to 1.5	0.08	2100
1.5 to 3	0.3	1200
3 to 96	0.8	600

- 1.2 Maximum Range 96 nm (all models)
- 1.3 Range Resolution 20 m
- 1.4 Bearing Resolution 1.9° (4 ft), 1.2° (6 ft)
- 1.5 Minimum Range 21 m
- 1.6 Bearing Accuracy ±1.0°
- 1.7 Range, Range Ring Accuracy 1.0% of range or 8 m, whichever is the greater

2. ANTENNA UNIT

2.1 XN-12A (4 ft)

- 2.1.1 Radiator Slotted array
- 2.1.2 Polarization Horizontal
- 2.1.3 Antenna Rotation 24 rpm, 36 rpm, 48 rpm, range dependent rpm. (24 rpm motor fixed at 24 rpm.)
- 2.1.4 Radiator Length 125.5 cm
- 2.1.5 Horizontal Beamwidth 1.9°
- 2.1.6 Vertical Beamwidth 2.2°
- 2.1.7 Sidelobe Attenuation -24 dB or less (within ±10° of main-lobe)
-30 dB or less (±10° of main-lobe or more)

2.2 XN-13A (6 ft)

- 2.2.1 Radiator Slotted array
- 2.2.2 Polarization Horizontal
- 2.2.3 Antenna Rotation 24 rpm, 36 rpm, 48 rpm, range dependent rpm. (24 rpm motor fixed at 24 rpm.)
- 2.2.4 Radiator Length 180 cm
- 2.2.5 Horizontal Beamwidth 1.35°
- 2.2.6 Vertical Beamwidth 2.2°
- 2.2.7 Sidelobe Attenuation -28 dB or less (within ±10° of main-lobe)
-35 dB or less (±10° of main-lobe or more)

3. RF TRANSCEIVER

- 3.1 Frequency and Modulation 9410 MHz ±30MHz (X band), P0N
- 3.2 Peak Output Power FR-8062: 6 kW, FR-8112: 12 kW, FR-8052: 25 kW

- 3.3 Intermediate Frequency 60 MHz
- 3.4 Tuning Automatic or manual
- 3.5 Pulse length, PL, PRF and range

Pulse length	Short	Medium	Long
PL (μs)	0.08	0.3	0.8
PRF (Hz)	2100	1200	800
Range scale (nm)	0.125, 0,25, 0,5, 0,75, 1,0	1.5, 2, 3	2, 3, 4, 6, 8, 12, 16, 24, 36, 48, 64, 72, 96

- 3.6 Noise figure 6 dB (typical)

4. DISPLAY UNIT

- 4.1 Display 12.1-inch rectangular TFT color LCD, 600 x 800 dots, Effective radar display 298 dots

4.2 Range, Range Ring Interval (RI), Number of Rings

Range	0.125	0.25	0.5	0.75	1	2	3	4	6	8	12	16	24	36	48	6	7	9
Ring Interval	0.025	0.05	0.1	0.25	0.25	0.5	0.5	1	1	2	2	4	4	6	8	1	1	1
No. of rings	5	5	5	3	4	4	6	4	6	4	6	4	6	6	6	4	6	6

- 4.3 Markers Heading Line, Bearing Scale, Range Rings, Variable Range Marker (VRM), Electronic Bearing Line (EBL), Target Alarm Zone, Waypoint Mark (navigation input required), Zoom Window
- 4.4 Alphanumeric Indications Range, Range Ring Interval, Interference Rejection (IR), Variable Range Marker (VRM), Electronic Bearing Line (EBL), Stand-by (ST-BY), Echo Averaging (EAV), TX Pulse width, Guard Alarm (G(IN), G(OUT)), Echo Stretch (ES), Range and Bearing to Cursor or Cursor Position, Echo Trail Reference, Echo Trail Time, Nav Data (Position, Speed, Course, etc.), ARP/AIS Target Data

5. POWER SUPPLY

- 5.1 Rated Voltage/Current FR-8062 - 12-24 VDC: 3.2 A (24 V, no wind)
FR-8122 - 12-24 VDC: 3.8 A (24 V, no wind)
FR-8252 - 12-24 VDC: 5.0 A (24 V, no wind)
- 5.2 Rectifier (option) 100-115/220-230 VAC, 1 phase, 50/60 Hz

6. ENVIRONMENTAL CONDITIONS

- 6.1 Ambient Temperature Antenna Unit: -25°C to +70°C
Display Unit: -15°C to +55°C
Remote Controller: +5°C to +45°C
Power Supply Unit: -15°C to +55°C
- 6.2 Relative Humidity 93% or less at +40°C

- | | | |
|-----|-------------------------|--|
| 6.3 | Waterproofing | Antenna Unit: IPX6
Display Unit: IPX5
Remote Controller, Power Supply Unit: IPX0 |
| 6.4 | Vibration IEC 60945-4th | - 2Hz to 5 Hz and up to 13.2 Hz with a deviation of ± 1 mm $\pm 10\%$ (7 m/s ² maximum acceleration at 13.2 Hz);
- above 13.2 Hz and up to 100 Hz with a constant maximum acceleration of 7 m/s ² . |

7. COATING COLOR

- | | | |
|-----|--------------|------|
| 7.1 | Display Unit | N3.0 |
| 7.2 | Antenna Unit | N9.5 |

This page intentionally left blank.

INDEX

A

Advanced-level troubleshooting, 6-6

AIS

- activating targets, 4-2
- activating, deactivating, 4-1
- controls for, 4-1
- CPA, TCPA alarm, 4-8
- display on/off, 4-2
- display range, 4-4
- display sector, 4-5
- lost target, 4-9
- number of targets, 4-5
- proximity alarm, 4-9
- sorting targets, 4-4
- symbol color, 4-10
- target data, 4-3
- target past positions (history display), 4-7
- vector, 4-6

Alarm message, 1-44

Antenna speed, 1-42

ARP

- acquiring targets, 3-3
- activating, deactivating, 3-2
- controls for, 3-2
- CPA, TCPA alarm, 3-8
- lost target, 3-9
- past target positions, 3-6
- proximity alarm, 3-9
- symbol color, 3-10
- terminating tracking of target, 3-4
- usage precautions, 3-1
- vector, 3-5

B

Background color, 1-38

C

- CANCEL/HL OFF key, 1-33
- Characteristics curve, 1-42
- Color schemes, 1-38
- Control description, 1-2
- Controls, 1-1
- Course-up mode, 1-9
- Cursor, 1-15
- CUSTOM key, 1-34
- Custom setup
 - description, 1-34
 - setting, 1-35

D

- Depth unit, 1-47
- Dynamic range, 1-41

E

EBL

- measuring bearing by, 1-19
- reference, 1-19

EBL key, 1-20

Echo area, 1-45

Echo averaging, 1-27

Echo stretch, 1-26

F

F1, F2 key, 1-36

False echoes, 2-3

Function keys, 1-36

Fuse replacement, 6-3

G

GAIN control

- adjustment method, 1-11
- automatic adjustment, 1-11
- manual adjustment, 1-12

GPS

- cold start, 5-6
- datum, 5-2
- navigator type, 5-1
- satellite monitor, 5-3
- sensor installation offset, 5-5
- test, 6-11
- type 16 message, 5-4
- WAAS, 5-2

GPS test, 6-11

H

Heading line, 1-33

Heading marker, 1-33

Head-up mode, 1-8

Head-up true bearing mode, 1-9

I

Indications, 1-5

Initial menu, 1-46

Interference rejector, 1-16

K

Key beep, 1-46

M

Magnetron replacement, 6-3

Maintenance

- fuse replacement, 6-3
- magnetron replacement, 6-3
- preventive, 6-2
- trackball, 6-4

Memory clear, 6-12

Menu, 1-6

MENU key, 1-6

MODE key, 1-8

Multiple echoes, 2-3

INDEX

N

- Navigation data
 - at screen bottom, 1-40
 - standby, 1-39
- Noise rejector, 1-36
- North-up mode, 1-9

O

- OFF CENTER key, 1-24
- Offcentering the display, 1-24
- Origin mark, 1-33

P

- Parallel index lines
 - mode, 1-32
 - turning on/off, 1-31
- POWER/BRILL key, 1-4, 1-6
- Presentation mode
 - course-up, 1-9
 - heading, 1-8
 - north-up, 1-9
 - true bearing mode, 1-9
 - true motion, 1-10
- Preventive maintenance, 6-2
- Pulse length, 1-11

Q

- Quick start, 1-4

R

- RACON, 2-6
- RAIN control
 - adjustment method, 1-13
 - automatic adjustment, 1-14
 - manual adjustment, 1-14
- Range and bearing between two targets, 1-20
- RANGE key, 1-10
- Range measurement, 1-17
- Range preset, 1-47
- Range ring brilliance, 1-17
- Range unit, 1-46

S

- SART, 2-5
- SEA control
 - adjustment method, 1-12
 - automatic adjustment, 1-12
 - manual adjustment, 1-13
- Second-trace echoes, 1-37
- Ship speed unit, 1-47
- Sidelobe echoes, 2-3
- STBY/TX key, 1-4
- System configuration, 1-ix
- System test, 6-8

T

- Target alarm
 - acknowledging, 1-22
 - alarm type, 1-22
 - sensitivity, 1-23
 - setting, 1-21

- TARGET ALARM key, 1-21

Target trails

- color, 1-29
- gradation, 1-29
- level, 1-29
- long trails, 1-31
- mode, 1-28
- own ship trail, 1-30
- restarting, 1-31
- starting, 1-28
- stopping, 1-28
- thin trails, 1-30
- trail copy, 1-30

Temperature unit, 1-47

Tests

- GPS test, 6-11
- LCD test, 6-10
- system, 6-8

TLL key, 1-32

Trackball maintenance, 6-4

TRAILS key, 1-28

Troubleshooting

- advanced level, 6-6
- simple, 6-5

True motion mode, 1-10

Tuning, 1-7

V

Virtual image, 2-4

VRM

- measuring range by, 1-17
- unit of range measurement, 1-18

VRM key, 1-17

W

- Watchman, 1-37
- Waypoint mark, 1-43
- Wind direction, 1-47
- Wind speed unit, 1-47

Z

- ZOOM key, 1-25