

TECHNICAL INFORMATION

TEST REPORT ON THE PERFORMANCE OF MARINE RADAR

Brand Name : FURUNO

Transceiver Type : RTR-078

Report no.: FLI 12-03-029

Date of issue: July 25, 2003

Furuno Labotech International Co., Ltd.

9-52 Ashihara-cho, Nishinomiya City, Hyogo 662-8580, Japan

Tel: +81-798-63-1094 Fax: +81-798-63-1098

All tests were performed in Furuno Labotech International Co., Ltd.
All data herein contained is true and correct to our best knowledge.

All tests were performed and reported by:

Name : Sadatomo Kuwahara

Function : Chief Engineer

Signature :



Verified by:

Name : Takekazu Yokose

Function : Chief Engineer

Signature :



This report has been approved by:

Date : July 25, 2003

Name : Mitsuyoshi Komori

Function : Manager, Technical Section

Signature :



* * * * * **C O N T E N T S** * * * * *

1	General Information	3
2	Identification of Equipment (FCC Rule, 2.925)	9
3	Test data	10
3.1	RF Power Output (FCC Rule, 2.1046).....	10
3.2	Modulation Characteristics (FCC Rule, 2.1047).....	13
3.3	Occupied Bandwidth (FCC Rule, 2.1049)	24
3.4	Spurious Emissions at Antenna Terminal (FCC Rule, 2.1051)	26
3.5	Field Strength of Spurious Radiation (FCC Rule, 2.1053).....	30
3.6	Frequency Stability (FCC Rule, 2.1055).....	32
3.7	Suppression of Interference Aboard Ships (FCC Rule, 80.217)	35
4	Photographs to Reveal Equipment Construction and Layout (FCC Rule, 2.1033)	39
5	Description of Circuitry and Devices (FCC Rules, 2.1033)	40
5.1	Function of Each Semiconductor or Active Device	40
5.2	Description of the circuitry and devices provided for determining and stabilizing frequency, for suppression of spurious radiation, for limiting modulation, and for limiting power	43
6	Operator' s Manual Incl. Circuit Diagrams (FCC Rule, 2.1033)	47
Attachment A	[Test data for 3.4 Spurious Emissions at Antenna Terminal]	A.1 - A.14
Attachment B	[Test data for 3.5 Field Strength of Spurious Radiation]	B.1 - B.7
Attachment C	[Test data for 3.7 Suppression of Interference Aboard Ships]	C.1 - C.21
Attachment D	[List of Test/ Measuring Equipment]	D.1 - D.3
Attachment E	[Photographs of the EUT]	E.1 - E.56

1 General Information

1.1 General

(a) Manufacturer: Furuno Electric Co., Ltd.
Ashihara-cho 9-52, Nishinomiya-city, 662-8580 Japan

(b) Model: FAR-2117

	Type	Serial Number
Antenna unit	RSB-096	R134-0003
Transceiver:	RTR-078	Contained in Antenna unit
Radiator:	XN-12AF	
Processor unit	RPU-013	4317-0003
Control unit	RCU-014	0003
Monitor unit	MU-201CR	0004

(c) Primary Function: Search, Navigation and anticollision

(d) Discrimination

Range Discrimination: 26 meters on a range scale of 0.75 nm

Bearing Discrimination: on a range scale of 1.5 nm,

Radiator type:	XN-12AF	XN-20AF	XN-24AF
Discrimination (°):	2.13	1.46	1.18

(e) Minimum Range: 22 meters on a range scale of 0.25 nm

(f) Frequency Range: Fixed frequency, X-band

Type of Emission: P0N

(g) Power Supply: 24 VDC or 100 - 115/220 - 230 VAC (for Processor unit),
24 VDC or 100 - 230 VAC (for Monitor unit)

1.2 Antenna Unit

1.2.1 Transceiver

Type: **RTR-078**

(1) Transmitter

(a) Assignable Frequency for Shipborne Radar:

Between 9300 and 9500 MHz (FCC Rule: 80.375 (d)-(1))

(b) Type of RF Generator

Magnetron Type: MAF1425B MG4010

Peak Output Power: 12 kW nominal

(c) Magnetron Ratings

Center frequency of Magnetron: 9410 MHz

Tolerances

MAF1425B MG4010

Manufacturing: ± 30 MHz
 Pulling: 27 MHz
 Tolerance for 20°C temperature variation: -5 MHz

(d) Guard Band:

Guard Band is specified to be equal to $1.5/T$ MHz, where "T" is the pulselength in microseconds. See para (e). (FCC Rule: 80.209(b))

(e) Pulse Characteristics:

Range Scale (nm)	(Short 1)	(Short 2)	(Middle 1)	(Middle 2)	(Middle 3)	(Long 1)	(Long 2)
<u>0.125</u>	0.25						
0.5	0.5						
0.75	0.75		0.75				
1.5	<u>1.5</u>		1.5				
	3		<u>3</u>	3	3		
			6	<u>6</u>	6	6	6
				12	12	12	12
				24	<u>24</u>	24	24
						<u>48</u>	48
						96	<u>96</u>
Pulselength (μ s)	0.07	0.15	0.30	0.50	0.70	1.20	1.20
P.R.R.(Hz)	3000	3000	1500	1000	1000	600	500
Duty cycle	2.10×10^{-4}	4.50×10^{-4}	4.50×10^{-4}	5.00×10^{-4}	7.00×10^{-4}	7.20×10^{-4}	6.00×10^{-4}
Guard Band (MHz)	21.43	10.00	5.00	3.00	2.14	1.25	1.25

Note 1: Tests were carried out for the underlined Range Scales.

(2) **Modulator**

(a) FET Type: 2SK1450
 Trigger Voltage: Approx. +16 VDC positive

(3) **Receiver**

(a) Passband (MHz)
 RF Stage: 100 MHz
 IF Stage:

Pulselength	Short 1	Short 2	Middle 1	Middle 2	Middle 3	Long 1	Long 2
(MHz)	40	40	10	10	10	3	3

- (b) Gain (overall) (dB): Sufficient to cause limiting, approximately 130
- (c) Overall Noise Figure (dB): 6 (typical)
- (d) Video Output Voltage (V): 2 V negative
- (e) Features Provided:
 - Sensitivity Time Controls (Anti-clutter Sea),
 - Fast Time Constant (Anti-clutter Rain)
- (f) If receiver is tunable, describe method of adjusting frequency:
 - Adjustment of tuning voltage of receiver local oscillator (Automatic and manual)

1.2.2 Antenna

- (a) Antenna Rotation ON-OFF Switch:

Not Provided.

- (b) Reflector: Slotted array antenna

Radiator type:	XN-12AF	XN-20AF	XN-24AF
Length (cm):	129	206	257
Length (ft):	4	6.5	8

- (c) Type of Beam: Vertical fan

- (d) Beam Width (between half-Radiator power points)

Radiator type:	XN-12AF	XN-20AF	XN-24AF
Horizontal (°):	1.90	1.23	0.95
Vertical (°):	20	20	20

- (e) Polarization: Horizontal

- (f) Antenna Gain:

Radiator type:	XN-12AF	XN-20AF	XN-24AF
Ant. gain (dB):	27.5	30.0	31.5

- (g) Attenuation of Major Side Lobes with respect to main beam:

Radiator type:	XN-12AF	XN-20AF	XN-24AF
Within $\pm 10^\circ$	-24 dB	-28 dB	-28 dB
Outside $\pm 10^\circ$	-30 dB	-32 dB	-32 dB

- (h) Scanning (rotating or oscillating):

Rotating over 360° continuously clockwise

- (i) Antenna Rotation Rate: 24 rpm for RSB-096, 42 rpm for RSB-097

- (j) Number of Degrees Scanned: 360°
- (k) Sector Scan: Not provided.
- (l) Type of Transmission System: Contained in scanner unit
- (m) Rated Loss of Transmission System per hundred feet:
None. Transmission path is only in the antenna scanner unit.

1.3 Display Unit

- (a) Type:

Monitor type	MU-201CR	MU-231CR
Size (in. diagonal) and Color:	20.1, Color LCD,	23.1, Color LCD
Pixels:	768 x 1024	1024 x 1280
Effective diameter (mm):	> 250	> 340

- (b) Size of Indicator: See above.
- (c) Sweep Linearity: 2% on all ranges
- (d) Range Scales:

Range (nm)	Number of Range Rings	Range Ring Interval (nm)
0.125	5	0.025
0.25	5	0.05
0.5	5	0.1
0.75	3	0.25
1.5	6	0.25
3	6	0.5
6	6	1
12	6	2
24	6	4
48	6	8
96	6	16

- (e) Range Ring Accuracy: Better than 1% of maximum scale in use or 10 m, whichever is the greater
- (f) Overall Bearing Accuracy from Scanner to Display:
Better than 1°

- (g) Target Plot Facility: Simulated afterglow in low shade
- (h) Heading Indicator: Provided, automatic alignment. Heading Line and Heading Marker
- (i) True Bearing Indicator: Not provided

1.4 Functional Controls

Range selector	Power Switch	FTC control
A/C rain	A/C sea	Gain control
Panel dimmer ²⁾		
Heading line off	Echo stretch ²⁾	MENU
Guard zone set/Audio alarm off		Range ring on/off
Interference rejector ²⁾	ST-BY/TX	Arrow keys (VRM/EBL/GUARD)
Trackball		
VRM on/off	SHIFT (Offcenter)	Range set ²⁾
Zoom	EBL on/off	Echo Trail
Contrast	Brilliance ²⁾	Navigation on/off ^{1),2)}
Anchor watch ²⁾	Display brilliance	
PLOT color ²⁾	TRU/REL ^{2), 3)}	Mode ^{2), 3)}
Chart display ²⁾	Waypoint ²⁾	HU/HUTB/CU/NU/TM

Note: ¹⁾ Valid when interfaced with navaid

²⁾ Selected on menu

³⁾ Valid when interfaced with gyrocompass

1.5 Operational Features

- (a) Is positive means provided to indicate whether or not the overall operation of the equipment is such that it may be relied upon to provide effective operation in accordance with its primary function:

Yes (Magnetron/Xtal checker)

- (b) Is the equipment for continuous operation: Yes

- (c) Is provision made for operation with shore based radar beacons (RACONS):

Yes (RACONS and SART)

1.6 Line Power Supply Requirements

- (a) Input Voltage and Power Drain:

Unit	Type	Input voltage	Power drain
Processor unit	RPU-013	12 - 24 VDC	144 W
		24 VDC	140 W (5.8 A)

Unit	Type	Input voltage	Power drain
		100 - 115/220 - 230 VAC	198 VA
Monitor unit	MU201CR	24 DVC	56 W (2.3 A)
		100 - 230 VAC	70 VA
	MU231CR	24 DVC	77 W (3.2 A)
		100 - 230 VAC	90 VA

1.7 Construction Features

- (a) Does equipment embody replacement units with chassis type assembly: **Yes**
- (b) Are fuse alarms provided: **Fuses are provided.**
- (c) State units that are weatherproof: **Antenna Unit (IEC 60529 - IPX6)**
- (d) If all units are not housed in a single container, indicate number and give description of individual units:
- | | | |
|--------------------|-------|---|
| 1 × Antenna Unit | Type: | RSB-096 (24 rpm) or
RSB-097 (42 rpm) |
| Transceiver | Type: | RTR-078 (contained in the Antenna unit) |
| 1 × Processor Unit | Type: | RPU-013 |
| 1 × Control Unit | Type: | RCU-014 |
| 1 × Monitor Unit | Type: | MU-201CR (20.1 inch LCD) or
MU-231CR (23.1 inch LCD) |
- (e) Approximate Weight of Complete Installation:
- | | |
|-----------------|--|
| Antenna Unit: | 42 kg |
| Processor Unit: | 10 kg |
| Control Unit: | 2.7 kg |
| Monitor Unit: | 18.3 kg (for MU-201CR)
23.5 kg (for MU-231CR) |
- (f) Approximate space required for installation excluding scanner:
- | | |
|-----------------|---|
| Monitor Unit: | 734 (W) X 510 (H) X 452 (D) mm (for MU-201CR) or
798 (W) X 560 (H) X 451 (D) mm (for MU-231CR) |
| Processor Unit: | 564 (W) X 498 (H) X 459 (D) mm |
| Control Unit: | 398 (W) X 92 (H) X 250 (D) mm |

2 Identification of Equipment (FCC Rule, 2.925)

The following nameplates are permanently fixed on the corresponding equipment units.

FCC ID: ADB9ZWRTR078

Material of nameplate: Aluminum, 0.5 mm thick

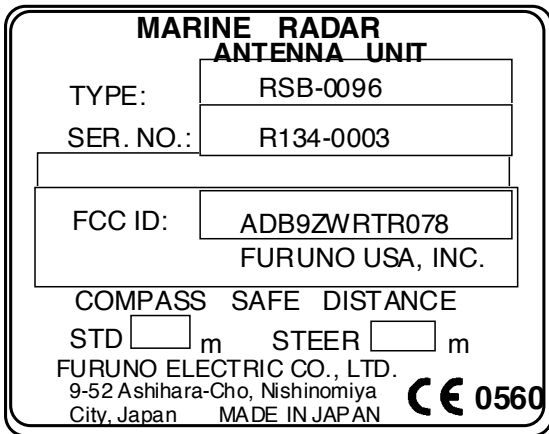

Fig. 2.1 Nameplate for Antenna Unit

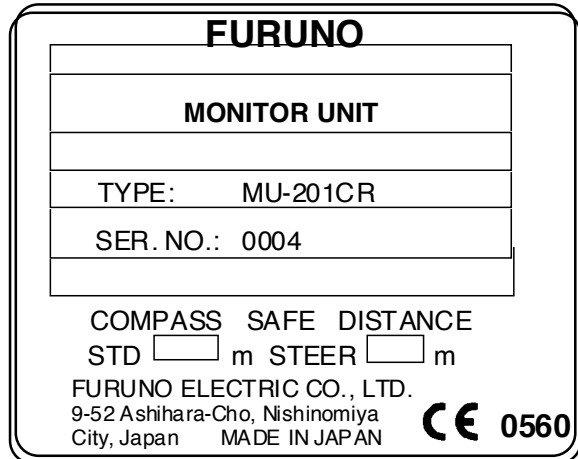

Fig. 2.3 Nameplate for Monitor Unit

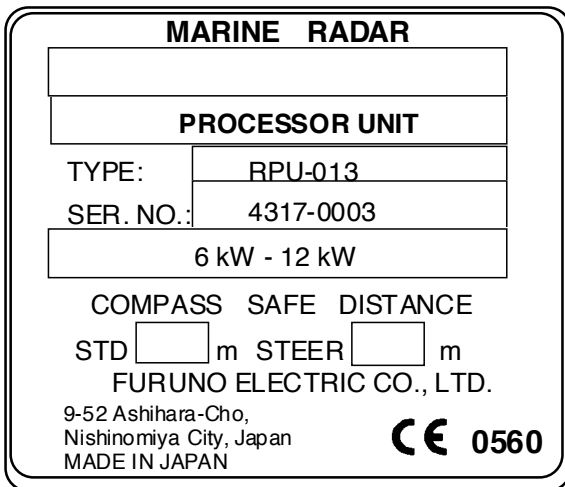

Fig. 2.2 Nameplate for Processor Unit

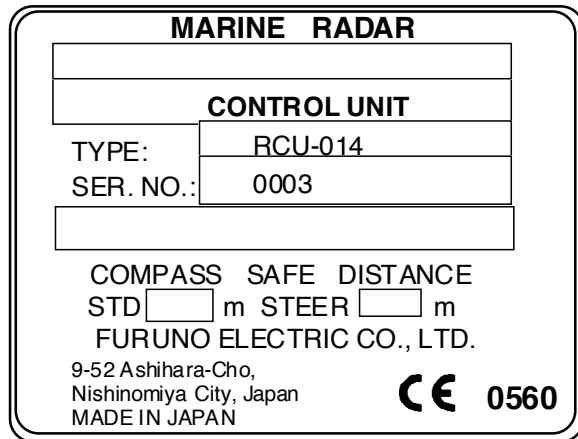

Fig. 2.4 Nameplate for Control Unit

3 Test data

3.1 RF Power Output (FCC Rule, 2.1046)

3.1.1 Microwave characteristics

The peak voltage was determined using the divider having a ratio of 1000 to 1 and the oscilloscope. Current pulse was viewed across the wideband current transformer with output voltage per ampere 1.00.

(1) Nominal values

Pulselength	Short 1	Short 2	Middle 1	Middle 2	Middle 3	Long 1	Long 2
Range scale (nm)	0.125	1.5	3	6	24	48	96
Pulselength (μ s)	0.07	0.15	0.30	0.50	0.70	1.20	1.20
PRR (Hz)	3000	3000	1500	1000	1000	600	500
Duty cycle	2.10×10^{-4}	4.50×10^{-4}	4.50×10^{-4}	5.00×10^{-4}	7.00×10^{-4}	7.20×10^{-4}	6.00×10^{-4}
Guard band (MHz)	21.43	10.00	5.00	3.00	2.14	1.25	1.25

(2) Measured values

Magnetron input pulse voltage

Magnetron input pulse voltage was measured at its cathode using the oscilloscope and divider with ratio 1000 to 1.

Pulselength	Short 1	Short 2	Middle 1	Middle 2	Middle 3	Long 1	Long 2
Directional coupler attenuation (dB)	40.44	40.44	40.44	40.44	40.44	40.44	40.44
Magnetron input voltage (kV)	5.7	5.8	6.0	6.1	6.0	6.1	6.1
Pulselength (μ s) (50 % amplitude)	0.280	0.456	0.776	0.880	0.960	1.412	1.412
Rise time (μ s) (10 - 90 % amplitude)	0.080	0.088	0.092	0.092	0.090	0.092	0.092
Decay time (μ s) (90 - 10 % amplitude)	0.224	0.964	0.976	0.832	0.616	0.328	0.328

Magnetron input pulse current

Magnetron input pulse current was observed across the wideband current transformer with output voltage per ampere 1.00.

Pulselength	Short 1	Short 2	Middle 1	Middle 2	Middle 3	Long 1	Long 2
Magnetron input current (A)	3.4	4.1	5.1	6.3	6.2	6.2	6.3
Pulselength (μ s) (50 % amplitude)	0.068	0.191	0.342	0.506	0.708	1.188	1.184
Rise time (μ s) (10 - 90 % amplitude)	0.073	0.076	0.172	0.278	0.284	0.268	0.268
Decay time (μ s) (90 - 10 % amplitude)	0.090	0.123	0.222	0.256	0.260	0.728	0.736

RF envelope of the magnetron output pulse

The RF envelope of the magnetron output pulse was measured using a diode and the oscilloscope with the following results:

Pulselength	Short 1	Short 2	Middle 1	Middle 2	Middle 3	Long 1	Long 2
Pulselength (μ s) (-3 dB points)	0.085	0.226	0.386	0.562	0.758	1.224	1.224
Rise time (ns) (10 - 90 % amplitude)	20.0	21.6	21.6	21.0	21.4	19.6	21.4
Decay time (ns) (90 - 10 % amplitude)	105.0	110.0	198.0	192.0	190.0	156.0	155.0

Estimated efficiency

The estimated efficiency of the RF generator (magnetron) was determined by the following measurements and calculation. Power output from magnetron was measured using the directional coupler, power meter and the oscilloscope.

Pulselength	Short 1	Short 2	Middle 1	Middle 2	Middle 3	Long 1	Long 2
Range scale (nm)	0.125	1.5	3	6	24	48	96
P.R.R (Hz)	3016.0	3016.0	1508.4	1005.7	1005.7	603.5	502.9
Duty cycle	2.57E-4	6.82E-4	5.82E-4	5.65E-4	7.62E-4	7.39E-4	6.16E-4
Magnetron input, av. (W)	4.89	16.07	17.77	21.44	28.64	27.84	23.50
Magnetron input, peak (kW)	19.02	23.58	30.52	37.94	37.56	37.69	38.18
Power meter reading (mW)	0.167	0.500	0.509	0.552	0.799	0.782	0.654
Magnetron output, av. (W)	1.848	5.533	5.633	6.109	8.842	8.654	7.237

Pulselength	Short 1	Short 2	Middle 1	Middle 2	Middle 3	Long 1	Long 2
Magnetron Output, peak (kW):	7.19	8.12	9.67	10.81	11.60	11.72	11.76
Magnetron efficiency (%):	37.82	34.42	31.70	28.49	30.88	31.08	30.80
Spurious response limits (dB)	45.67	50.43	50.51	50.86	52.47	52.37	51.60

Peak Power Input to RF Generator : 32.1 kW
Estimated Efficiency of RF Generator : 32.2 %

3.2 Modulation Characteristics (FCC Rule, 2.1047)

3.2.1 FET Trigger Pulse

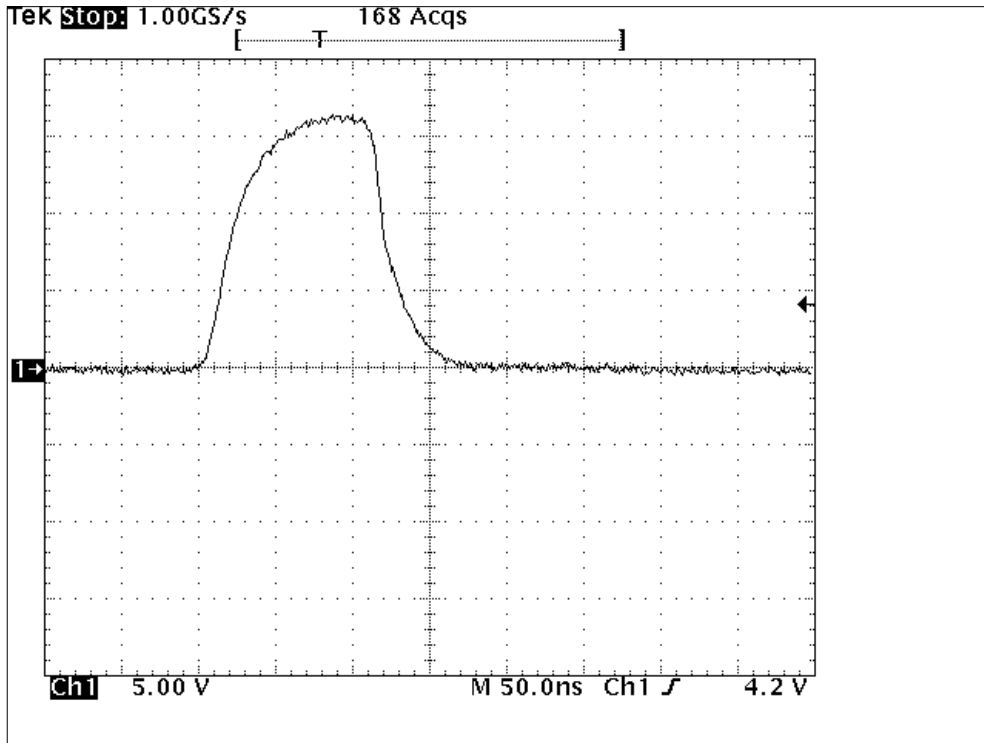

Fig. 3.2.1.1 Typical waveform of Trigger Pulse Scale: 5 V/div., 50 ns/div.

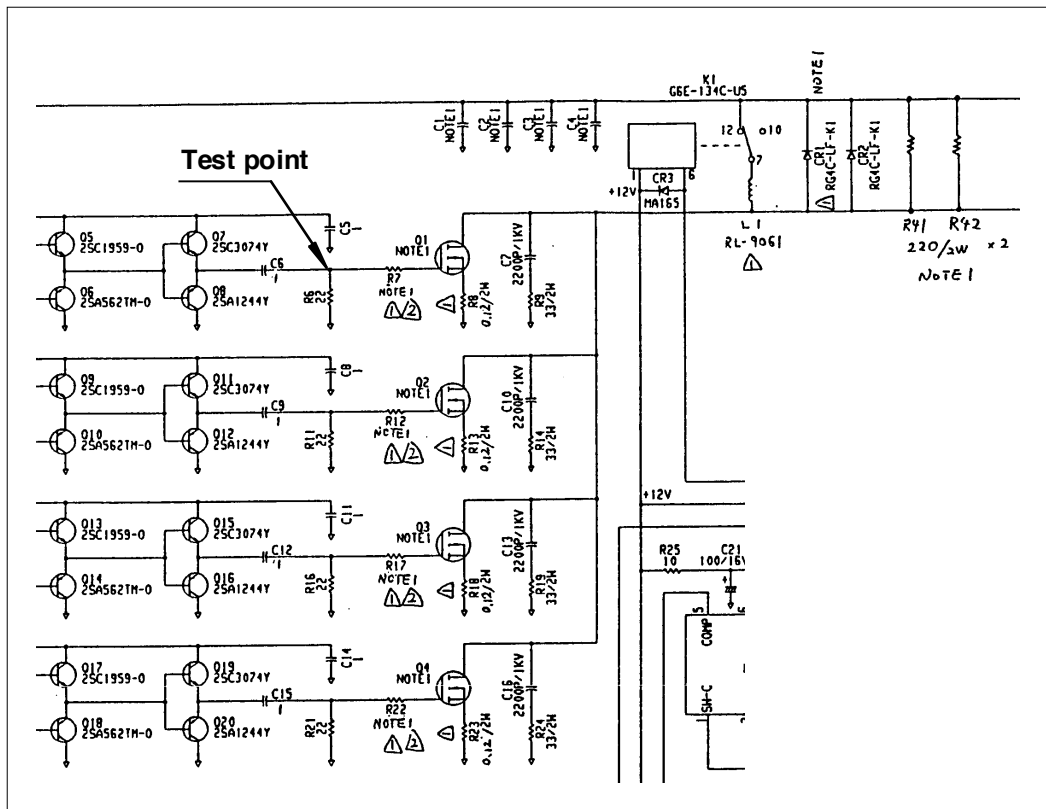

Fig. 3.2.1.2 Test Point for observing Trigger Pulse (in MD board (03P9244) of Radar Antenna Unit)

3.2.2 Trigger Pulse at Magnetron Cathode

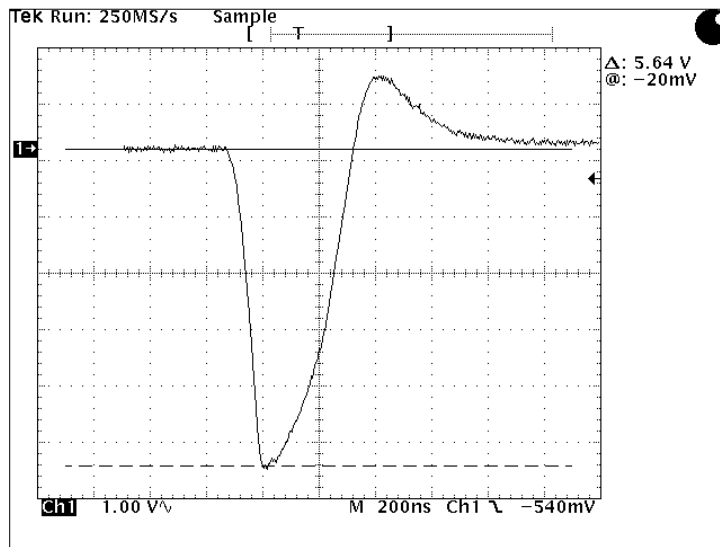

Fig. 3.2.2.1 Short 1 Pulse (0.125 nm Range) Scale: 1 kV/div. 200 ns/div.

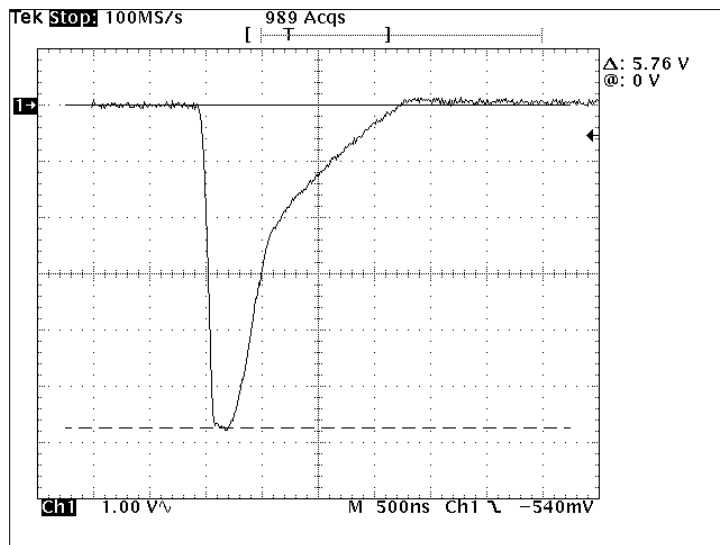

Fig. 3.2.2.2 Short 2 Pulse (1.5 nm Range) Scale: 1 kV/div. 500 ns/div.

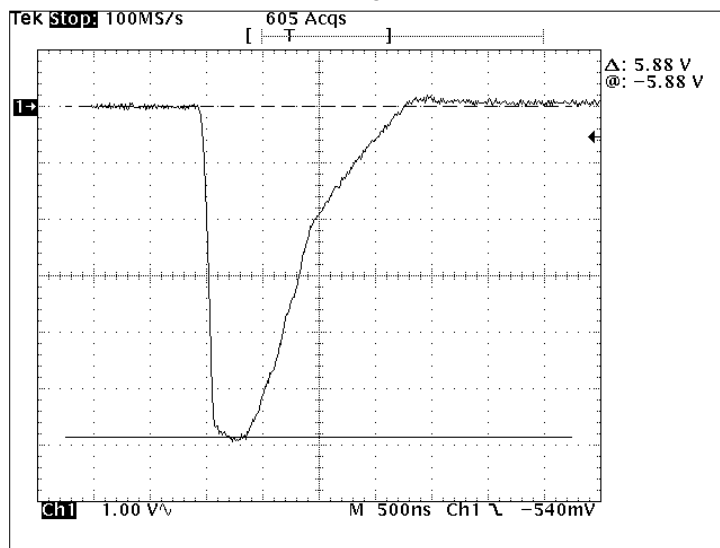

Fig. 3.2.2.3 Middle 1 Pulse (3 nm Range) Scale: 1 kV/div. 500 ns/div.

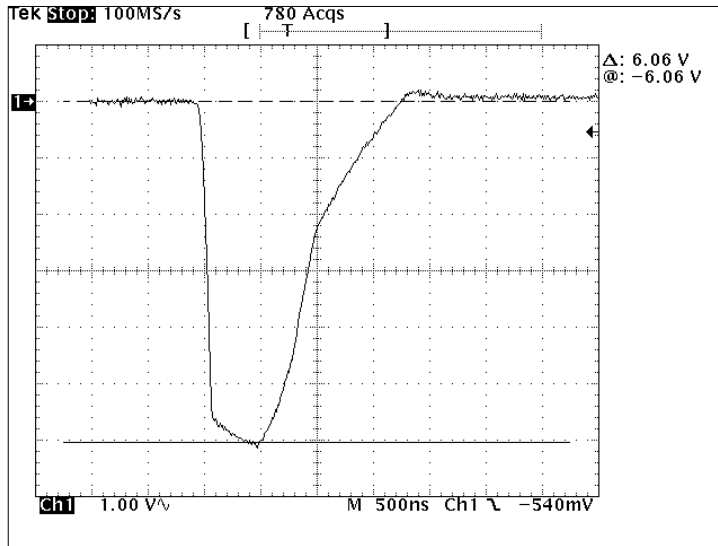

Fig. 3.2.2.4 Middle 2 Pulse (6 nm Range) Scale: 1 kV/div. 500 ns/div.

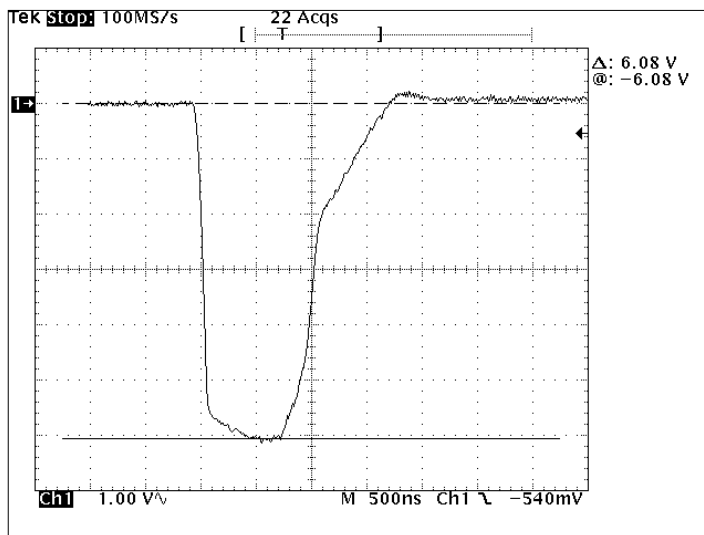

Fig. 3.2.2.5 Middle 3 Pulse (24 nm Range) Scale: 1 kV/div. 500 ns/div.

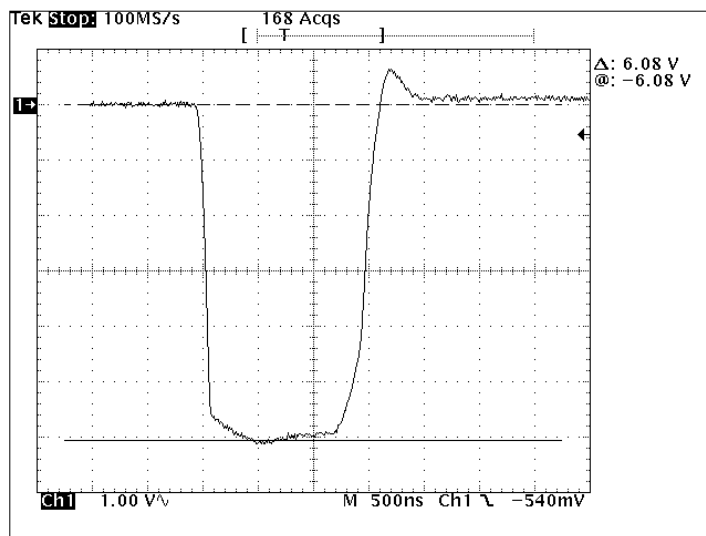

Fig. 3.2.2.6 Long 1 Pulse (48 nm Range) Scale: 1 kV/div. 500 ns/div.

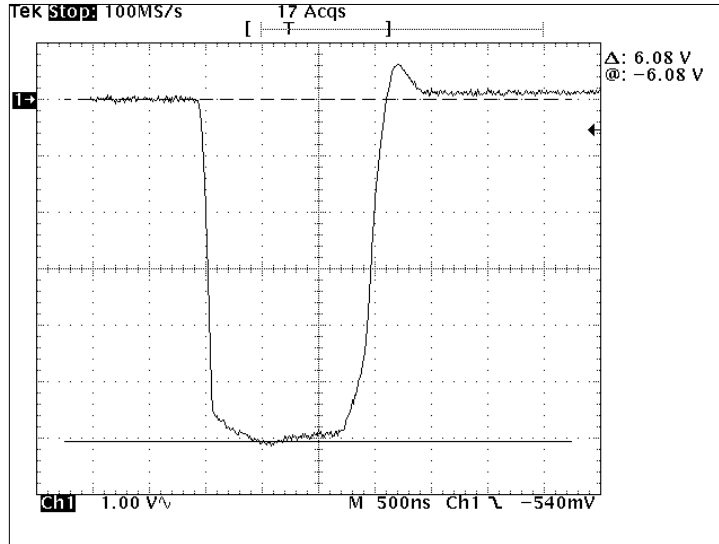

Fig. 3.2.2.7

Long 2 Pulse (96 nm Range)

Scale: 1 kV/div. 500 ns/div.

3.2.3 Magnetron Output (detected):**3.2.3.1 Setup for Measurement:**

Fig. 3.2.3.1

3.2.3.2 Measuring Equipment List:

See Attachment D [List of Test/Measuring Equipment].

3.2.3.3 Measured Data:

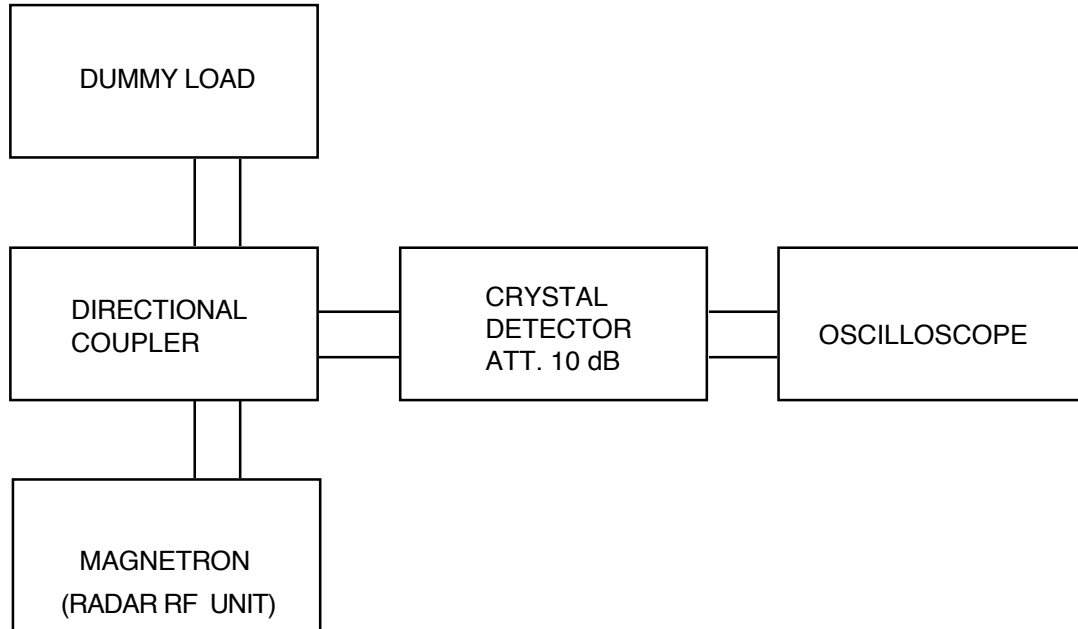
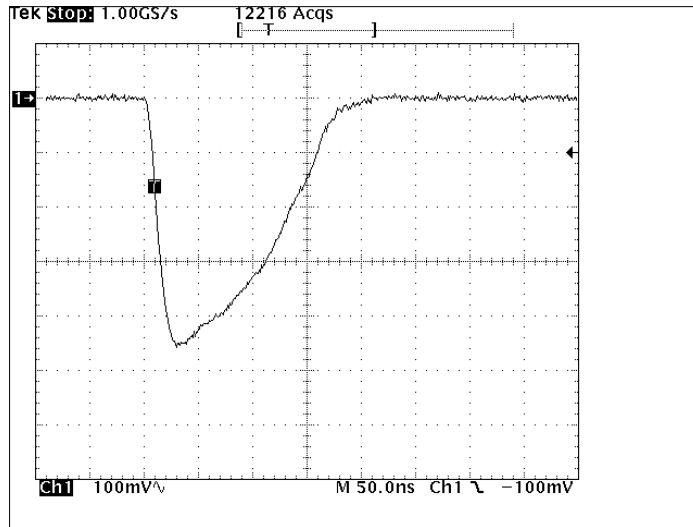

Fig. 3.2.3.2 Short 1 Pulse (0.125 nm Range) Scale: 100 mV/div. 50 ns/div.

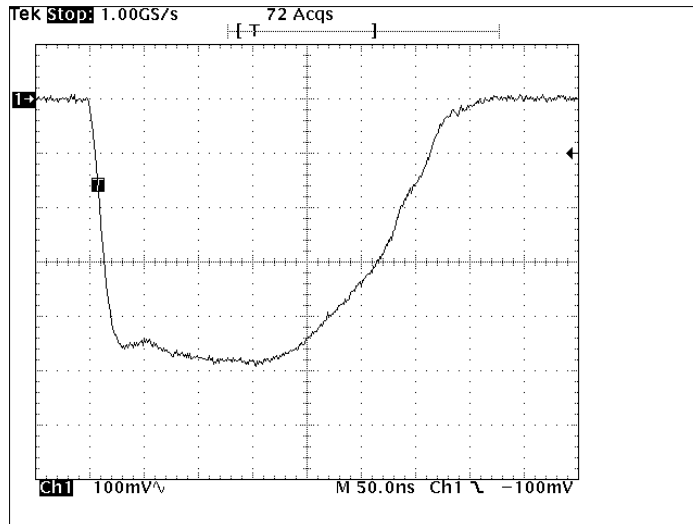

Fig. 3.2.3.3 Short 2 Pulse (1.5 nm Range) Scale: 100 mV/div. 50 ns/div.

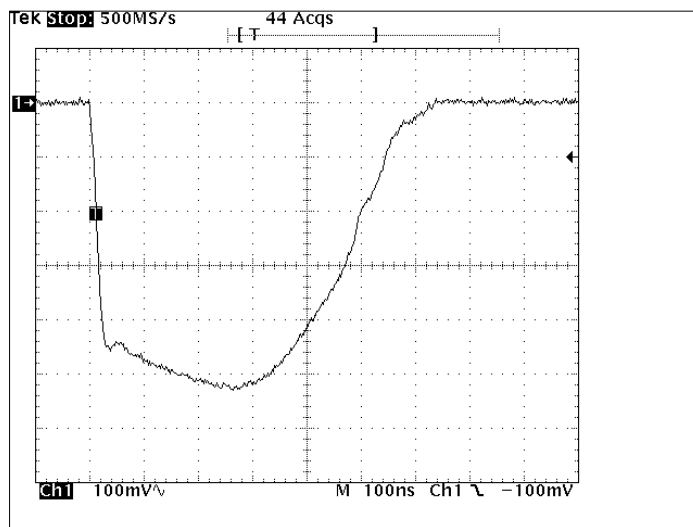

Fig. 3.2.3.4 Middle 1 Pulse (3 nm Range) Scale: 100 mV/div. 100 ns/div.

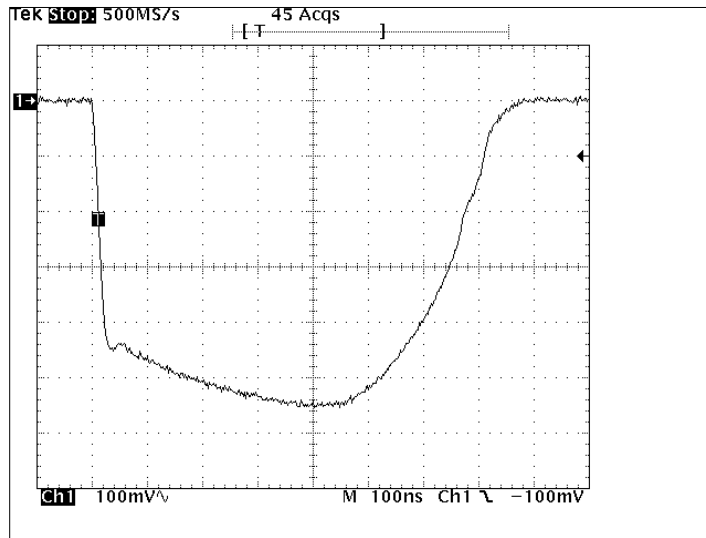

Fig. 3.2.3.5 Middle 2 Pulse (6 nm Range) Scale: 100 mV/div. 100 ns/div.

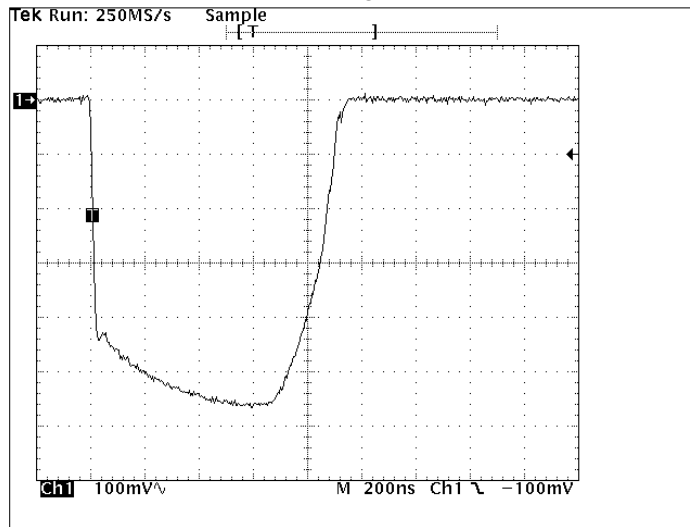

Fig. 3.2.3.6 Middle 3 Pulse (24 nm Range) Scale: 100 mV/div. 200 ns/div.

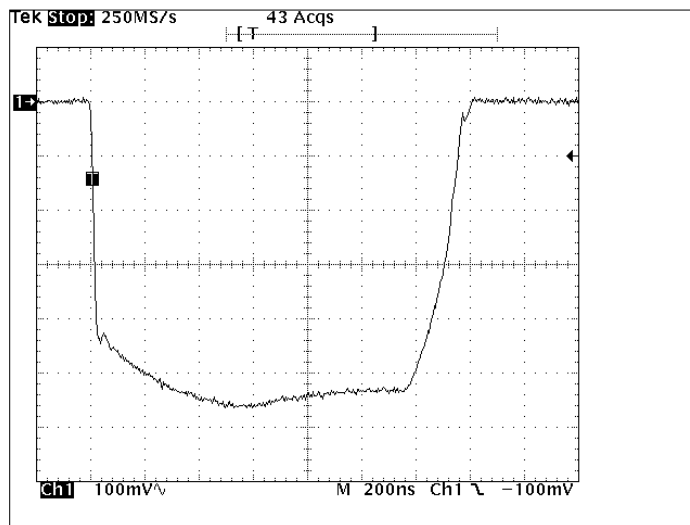

Fig. 3.2.3.7 Long 1 Pulse (48 nm Range) Scale: 100 mV/div. 200 ns/div.

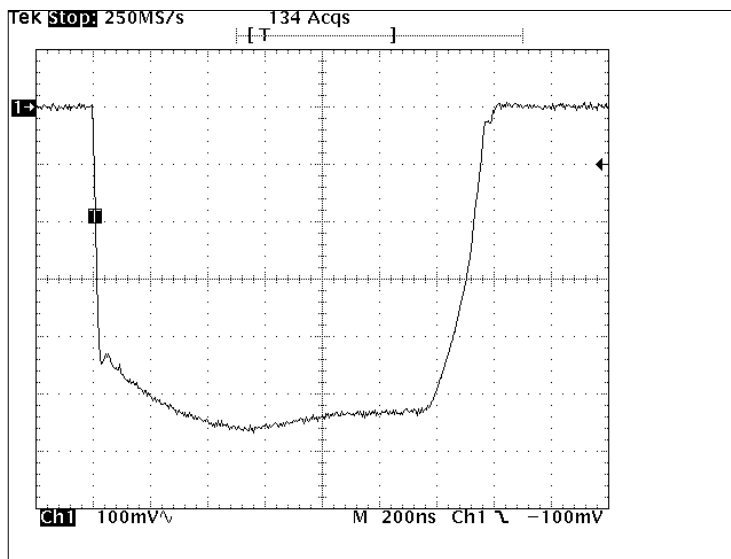

Fig. 3.2.3.8

Long 2 Pulse (96 nm Range)

Scale: 100 mV/div. 200 ns/div.

3.2.4 Radar Pulse Spectrum:

Measured by the spectrum analyzer.

(Test Equipment Setup and Measuring Equipment List are same as Clause 3.4.1 and 3.4.2.)

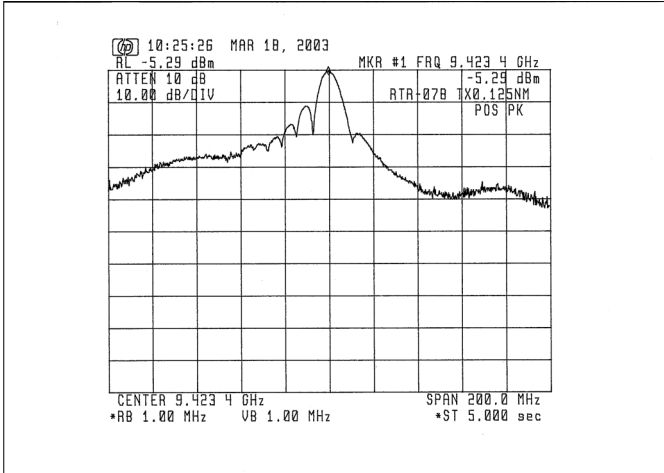

Fig. 3.2.4.1 For Short 1 Pulse (0.125 nm Range)

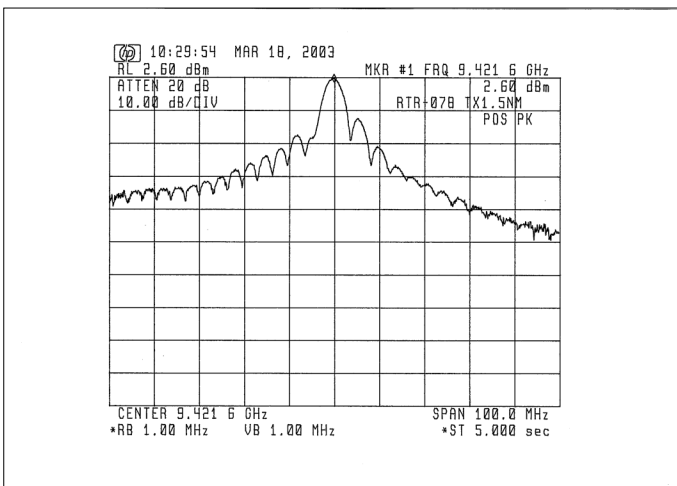

Fig. 3.2.4.2 For Short 2 Pulse (1.5 nm Range)

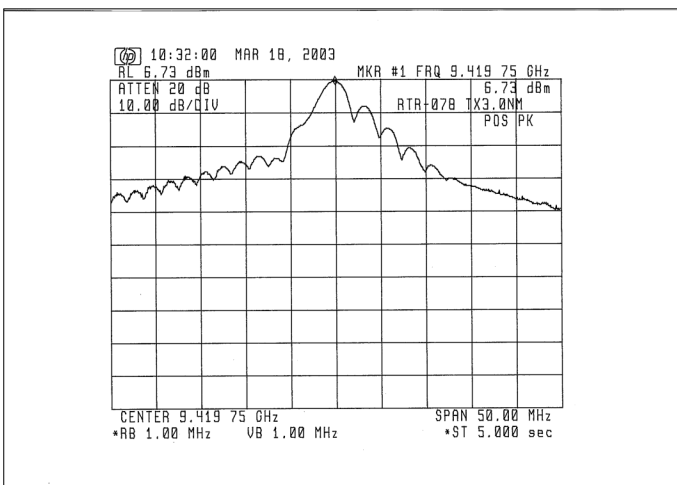

Fig. 3.2.4.3 For Middle 1 Pulse (3 nm Range)

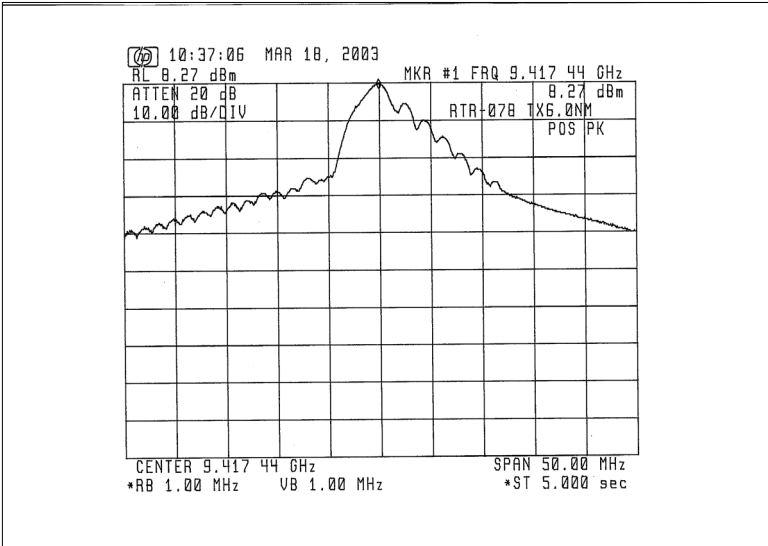

Fig. 3.2.4.4 For Middle 2 Pulse (6 nm Range)

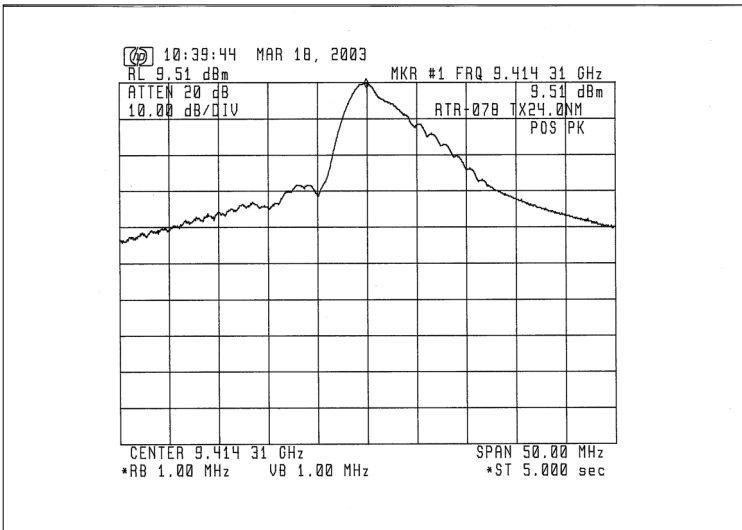

Fig. 3.2.4.5 For Middle 3 Pulse (24 nm Range)

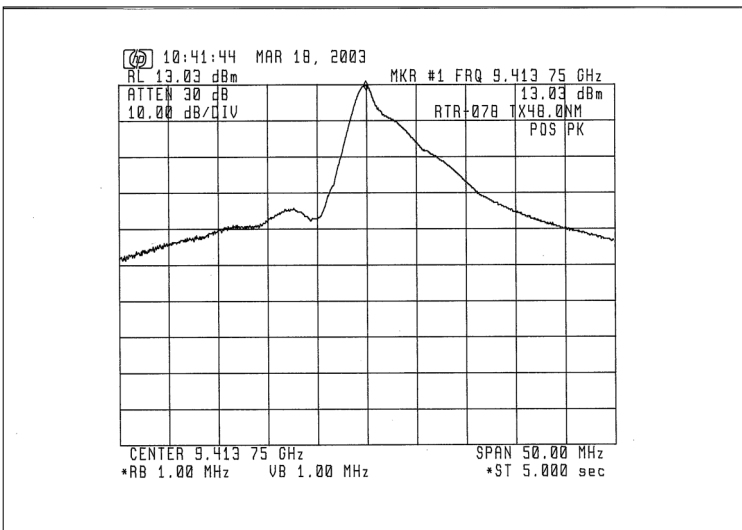

Fig. 3.2.4.6 For Long 1 Pulse (48 nm Range)

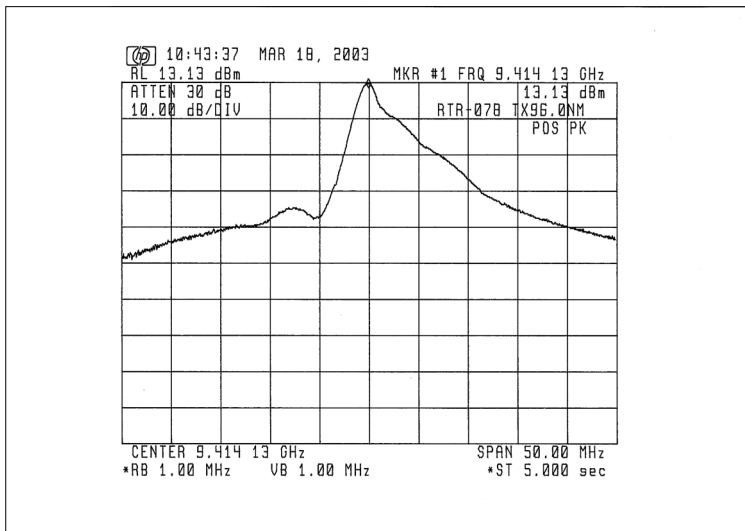

Fig. 3.2.4.7 For Long 2 Pulse (96 nm Range)

3.3 Occupied Bandwidth (FCC Rule, 2.1049)

3.3.1 Measuring Method

FCC rule 47 CFR 2.1049 requires measurements of the occupied bandwidth which is defined in the same section as "the frequency bandwidth such that, below its lower and above its upper frequency limits, the mean powers radiated are each equal to 0.5 percent of the total mean power radiated by a given emission." To obtain the occupied bandwidth of the radar transmitter, a special program (program list shown below) was loaded to the Hewlett-Packard spectrum analyzer and run by entering the HP-provided POWER BANDWIDTH calculation command [PWRBW].

The result was automatically displayed on the screen on the spectrum analyzer as:

```

POWER_BW=----- MHz

10 ! HP_71000 DOWNLOAD PROGRAM
20 ASSIGN @Sa TO 718
30 CLEAR @Sa
40 CALL M_ain(@Sa)
50 LOCAL @Sa
60 END
70 !
80 SUB M_ain(@Sa)
90 M_ain: !
100 CALL Pwr_bw(@Sa)
110 CALL Limit_line(@Sa)
120 !
130 OUTPUT @Sa;"VARDEF K_ey,0;";
140 !
150 OUTPUT @Sa;"FUNCDEF D_LP,^";
160 OUTPUT @Sa;"MOV K_ey,0;";
170 !
180 Main_menu: !
190 OUTPUT @Sa;"REPEAT;";
200 OUTPUT @Sa;"READMENU K_ey;";
210 ! location: %Top----Bottom-%
220 OUTPUT @Sa;" 1,%Limit line %,";
230 OUTPUT @Sa;" 2,%Power bw %,";
240 OUTPUT @Sa;"14,% Exit%,";
250 !
260 OUTPUT @Sa;"IF K_ey,EQ,1;THEN;LIMIT_LINE;";
270 OUTPUT @Sa;"ELSIF K_ey,EQ,2;THEN;PWR_BW;";
280 OUTPUT @Sa;"ELSIF K_ey,EQ,14;THEN;ABORT;";
290 OUTPUT @Sa;"ENDIF;";
300 OUTPUT @Sa;"UNTIL K_ey,EQ,14;";
310 OUTPUT @Sa;"IP;TS;";
320 OUTPUT @Sa;"ADORT;";
330 OUTPUT @Sa;"^"
340 !
350 Define_keydef: !
360 OUTPUT @Sa;"KEYDEF 7,D_LP, %DLP TEST%,";
370 !
380 OUTPUT @Sa;"FUNCDEF D,^";
390 OUTPUT @Sa;"KEYPST;";
400 OUTPUT @Sa;"^"
410 !
420 SUBEND

430 !
440 SUB Limit_line(@Sa)
450 Limit_line: !
460 OUTPUT @Sa;"CLR DSP;";
470 OUTPUT @Sa;"FUNCDEF LIMIT_LINE,^";
480 OUTPUT @Sa;"PU;PA 0,654;";
490 OUTPUT @Sa;"LINET 1;";
500 OUTPUT @Sa;"PD;PA 100,654;";
510 OUTPUT @Sa;"PU;PA 201,654;";
520 OUTPUT @Sa;"PD;PA 300,654;";
530 OUTPUT @Sa;"PU;PA 105,630;";
540 OUTPUT @Sa;"TEXT @-35dB@;";
550 OUTPUT @Sa;"PU;PA 205,720;";
560 OUTPUT @Sa;"TEXT @-25dB@;";
570 OUTPUT @Sa;"PU;PA 301,743;";
580 OUTPUT @Sa;"LINET 1;";
590 OUTPUT @Sa;"PD;PA 400,743;";
600 OUTPUT @Sa;"PU;PA 601,743;";
610 OUTPUT @Sa;"LINET 1;";
620 OUTPUT @Sa;"PD;PA 700,743;";
630 OUTPUT @Sa;"PU;PA 701,654;";
640 OUTPUT @Sa;"LINET 1;";
650 OUTPUT @Sa;"PD;PA 1000,654;HD;";
660 OUTPUT @Sa;"^"
670 SUBEND
680 SUB Pwr_bw(@Sa)
690 Pwr_bw: !
700 ! Calculating Power band width
710 OUTPUT @Sa;" VARDEF P_bw,0;";
720 OUTPUT @Sa;"FUNCDEF PWR_BW,^";
730 OUTPUT @Sa;"CLRW TRA;";
740 OUTPUT @Sa;"CLR DSP;";
750 OUTPUT @Sa;"SNGLS;";
760 OUTPUT @Sa;"MXMH TRA;TS;TS;TS;";
770 OUTPUT @Sa;"MOV P_bw,PWRBW TRA,99.0;";
780 OUTPUT @Sa;"DIV P_bw,P_bw,1000000;";
790 OUTPUT @Sa;"PU;PA 10,800;HD;";
800 OUTPUT @Sa;"TEXT @POWER_BW = @;";
810 OUTPUT @Sa;"DSPLY P_bw,8,3;";
820 OUTPUT @Sa;"TEXT @ MHz @;";
830 OUTPUT @Sa;"^"
840 SUBEND

```

Fig. 3.3.1 Program for Calculation of Occupied Bandwidth

3.3.2 Test Equipment Setup:

Same as Clause 3.4.1.

3.3.3 Measuring Equipment List:

Same as Clause 3.4.2.

3.3.4 Test Result:

The test result is shown below.

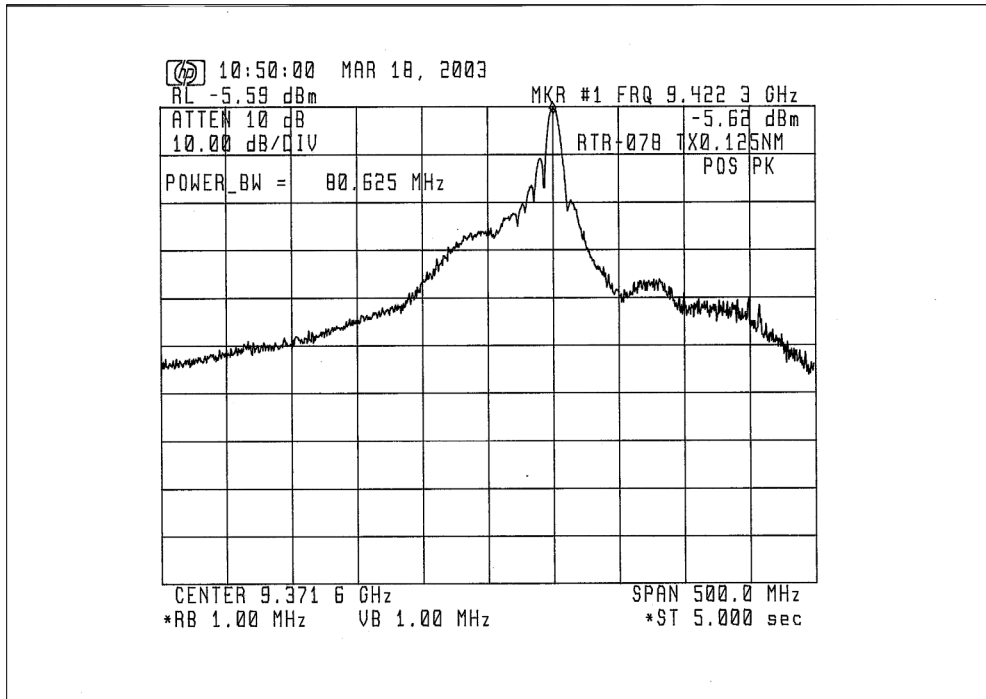

Fig. 3.3.2 Measurement of Occupied Bandwidth

Occupied bandwidth = 80.625 MHz

3.4 Spurious Emissions at Antenna Terminal (FCC Rule, 2.1051)

3.4.1 Test Equipment Setup:

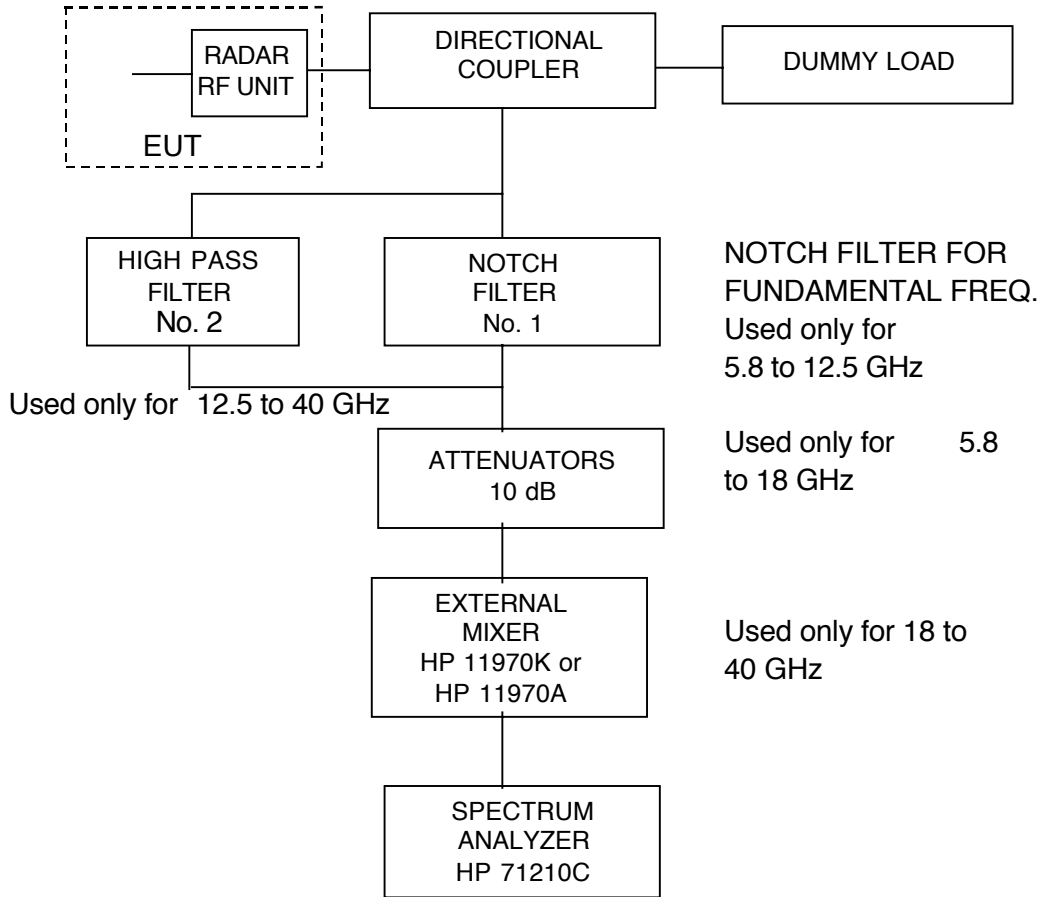

Fig. 3.4.1

3.4.2 Measuring Equipment List:

See Attachment D [List of Test/Measuring Equipment].

- Note : (1) The characteristics of Notch Filter (No. 1) are described in Fig. 3.4.2 to Fig. 3.4.5.
(2) The characteristic of High Pass Filter (No. 2) is described in Fig. 3.4.6.

3.4.3 Test Conditions:

Radar Range Settings: 0.125 nm (Short 1)/1.5 nm (Short 2)/ 3 nm (Middle 1)/6 nm (Middle 2)/24 nm (Middle 3)/48 nm (Long 1)/96 nm (Long 2)

3.4.4 Emission Limits:

- (a) Frequency Range (FCC Rule, 2.1057(1)) : 10 kHz - 40 GHz
- (b) Emission Limits (FCC Rule, 80.211) :

Frequency removed from the assigned frequency	Frequency (Hz)	Emission attenuation (mean power ,dB)
50 - 100 % (of the authorized bandwidth)	9310 - 9360 M	At least 25
	9460 - 9510 M	
100 - 250 %	9160 - 9310 M	At least 35
	9510 - 9660 M	
more than 250 %	10 k - 9160 M	At least $43 + 10 \log_{10}$ (mean power in watts)
	9660- 40,000 M	

- Note : (1) Assigned frequency (center frequency) = 9410 MHz
(2) Authorized bandwidth = 100 MHz

3.4.5 Test Results:

As shown in Attachment A, the spurious emissions at antenna terminal of EUT are found lower than the specified limits.

(Note: Spurious emissions for 10 kHz to 5 GHz are not found due to the antenna terminal structure. (Waveguide tube)).

Characteristic of Filter No. 1 (for X-band)

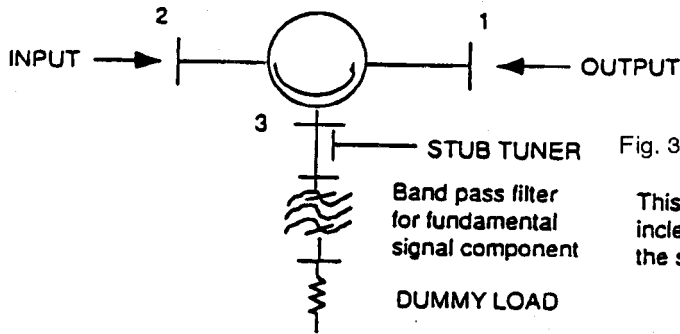

Fig. 3.4.2 Setup of Notch Filter No.1

This notch filter is used to increase the dynamic range of the spectrum analyzer

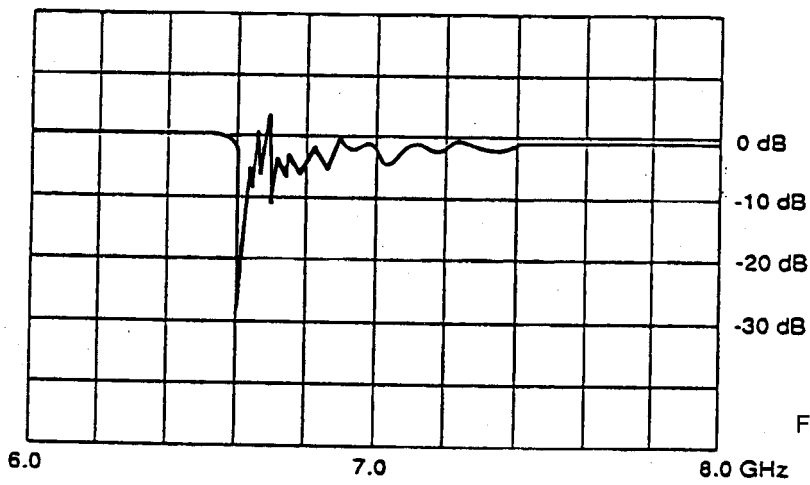

Fig. 3.4.3

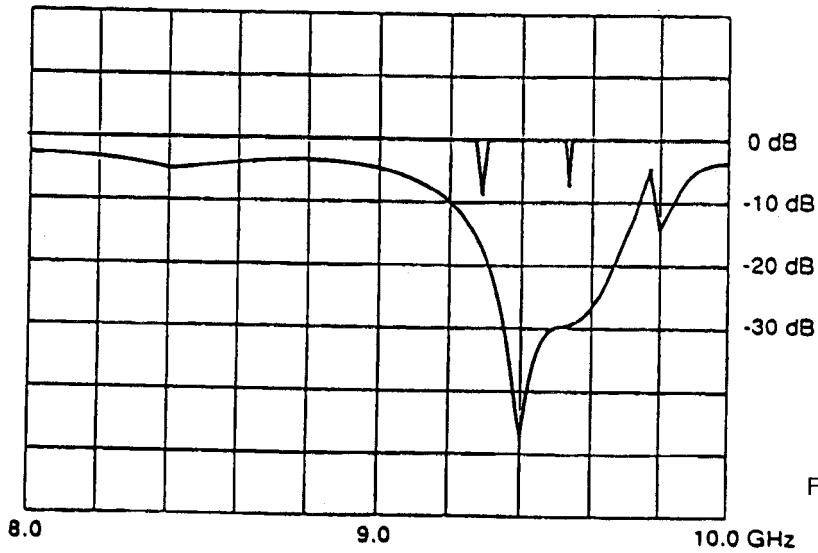

Fig. 3.4.4

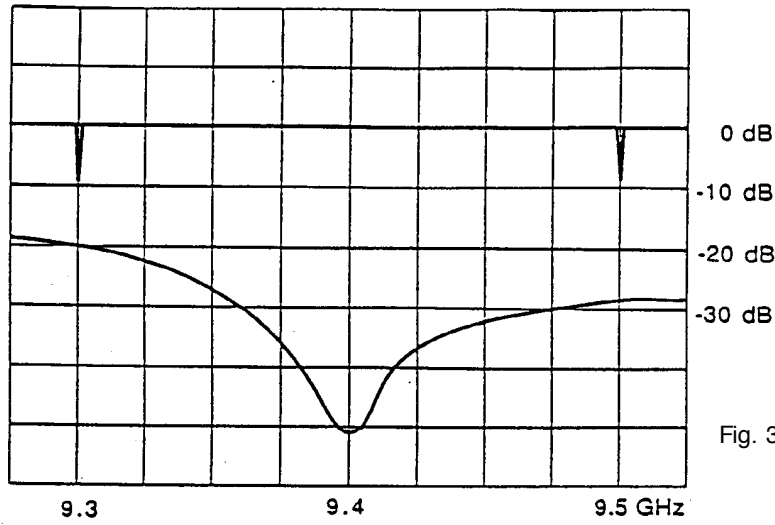
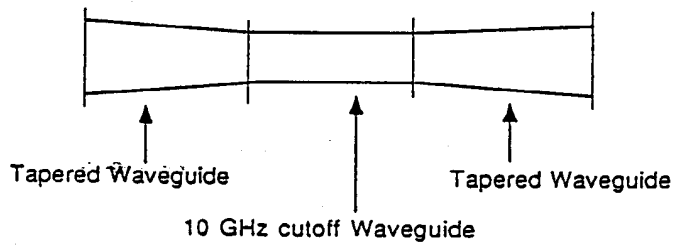

Fig. 3.4.5

Characteristic of Filter No. 2 (for X-band)



This filter is used to filter out the high level fundamental signal to avoid damage to the analyzer.

High Pass Filter Construction

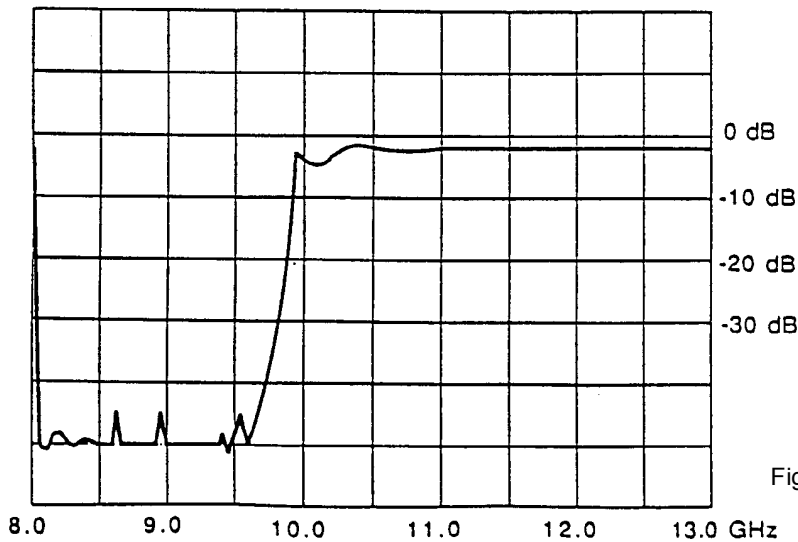

Fig. 3.4.6

3.5 Field Strength of Spurious Radiation (FCC Rule, 2.1053)

3.5.1 Test Site: Rooftop of 6-story building,
FURUNO ELECTRIC CO., LTD.
Ashihara-cho 9-52, Nishinomiya-city, 662-8580 Japan

3.5.2 Distance between the radar set and measuring antenna: 10 m

3.5.3 Radar Range settings: 0.125 nm (Short 1)/1.5 nm (Short 2)/ 3 nm (Middle 1)/6 nm (Middle 2)/24 nm (Middle 3)/48 nm (Long 1)/ 96 nm (Long 2)

3.5.4 Measuring Equipment List:
See Attachment D [List of Test/Measuring Equipment].

3.5.5 Test settings:

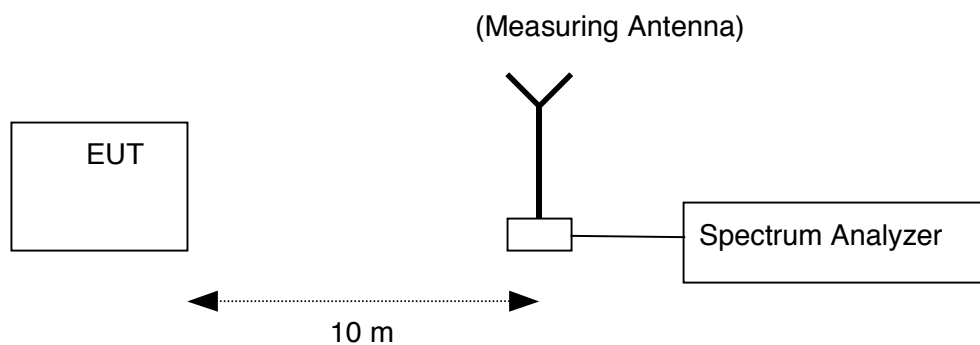

3.5.6 Field Strength Limits:

(a) Frequency Range (FCC Rule, 2.1057(1)) : 10 kHz - 40 GHz

(b) Emission Limits (FCC Rule, 80.211) :

Frequency removed from the assigned frequency	Frequency (MHz)	Emission attenuation (mean power, dB)
50 - 100 % (of the authorized bandwidth)	9,310 – 9,360	At least 25
	9,460 – 9,510	
100 - 250 %	9,160 – 9,310	At least 35
	9,510 – 9,660	
more than 250 %	0.01 – 9,160	At least $43 + 10 \log_{10}$ (mean power in watts)
	9,660 - 40,000	

Note : (1) Assigned frequency (center frequency) = 9410 MHz

(2) Authorized bandwidth = 100 MHz

3.5.7 Test Results:

As shown in Attachment B, the field strengths of spurious radiation generated by EUT are found lower than the specified limits.

3.6 Frequency Stability (FCC Rule, 2.1055)

3.6.1 Setup for Measurement

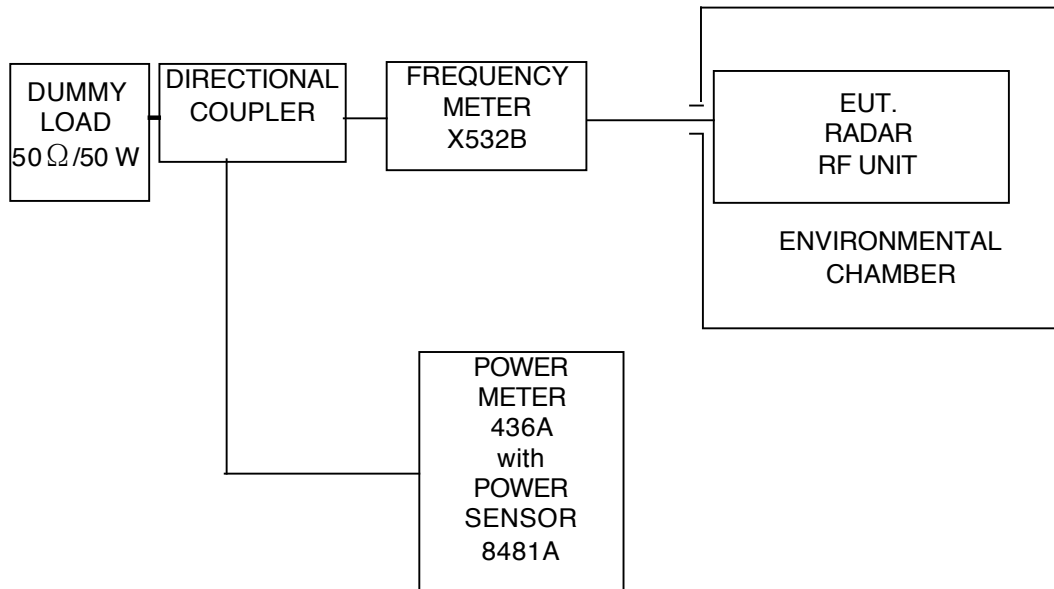

Fig. 3.6.1

3.6.2 Test Conditions:

- 1) Radar Range settings : 0.125 nm (Short 1)/1.5 nm (Short 2)/ 3 nm (Middle 1)/ 6 nm (Middle 2)/24 nm (Middle 3)/48 nm (Long 1)/ 96 nm (Long 2)
- 2) Ambient Temperature settings: - 20°C to + 50°C (10°C step)
- 3) Power Supply Voltage settings: 85 /115% of nominal voltage (85 VAC to 115 VAC)

3.6.3 Measuring Equipment List:

See Attachment D [List of Test/Measuring Equipment].

3.6.4 Frequency Tolerance Limits:

"The frequency at which maximum emission occurs must be within the authorized bandwidth and must not be closer than $1.5/T$ MHz to the upper and lower limits of the authorized bandwidth, where "T" is the pulse duration in microseconds. "

(FCC Rule, 80.209 (b))

- 1) Center frequency (f_0): 9410 MHz
- 2) Authorized bandwidth ($f(AUBW)$): 100 MHz

"Upper limit frequency of the authorized band", $f(UAUBW) = f_0 + f(AUBW)/2 = 9460$ MHz

"Lower limit frequency of the authorized band", $f(LAUBW) = f_0 - f(AUBW)/2 = 9360$ MHz

- 3) Assignable frequency bandwidth : 200 MHz (between 9300 MHz and 9500 MHz)
(FCC Rule, 80.375 (d)-(1))

"Upper limit frequency of the assignable band", $f(UASB) = 9500$ MHz

"Lower limit frequency of the assignable band", $f(LASB) = 9300$ MHz

- 4) Guard Band ($f(1.5/T)$) :

Pulselength	Short 1	Short 2	Middle 1	Middle 2	Middle 3	Long 1	Long 2
Range Scale (nm)	0.125	1.5	3	6	24	48	96
Pulselength (μ sec)	0.07	0.15	0.30	0.50	0.70	1.20	1.20
Guard Band $f(1.5/T)$ (MHz)	21.43	10.00	5.00	3.00	2.14	1.25	1.25

3.6.5 Test Results:

Shown on Fig. 3.6.2.

- (1) "Upper Tolerance Frequency measured (at -20°C)", $f(U) = 9429.0$ MHz
 - (2) "Lower Tolerance Frequency measured (at $+50^\circ\text{C}$)", $f(L) = 9411.2$ MHz
 - (3)-(a)
 $f(U) + \max. f(1.5/T) = 9450.4$ MHz $< f(UAUBW) = 9460$ MHz $\leq f(UASB) = 9500$ MHz
 - (3)-(b)
 $f(L) - \max. f(1.5/T) = 9389.7$ MHz $> f(LAUBW) = 9360$ MHz $\geq f(LASB) = 9300$ MHz
- So, both are found within the specified limits.

FREQUENCY STABILITY WITH VARIATION OF PRIMARY SUPPLY VOLTAGE:

The built-in voltage regulator allows no frequency variation against variations of $\pm 15\%$ of nominal power supply voltage (85 to 115 VAC for nominal 100 VAC).

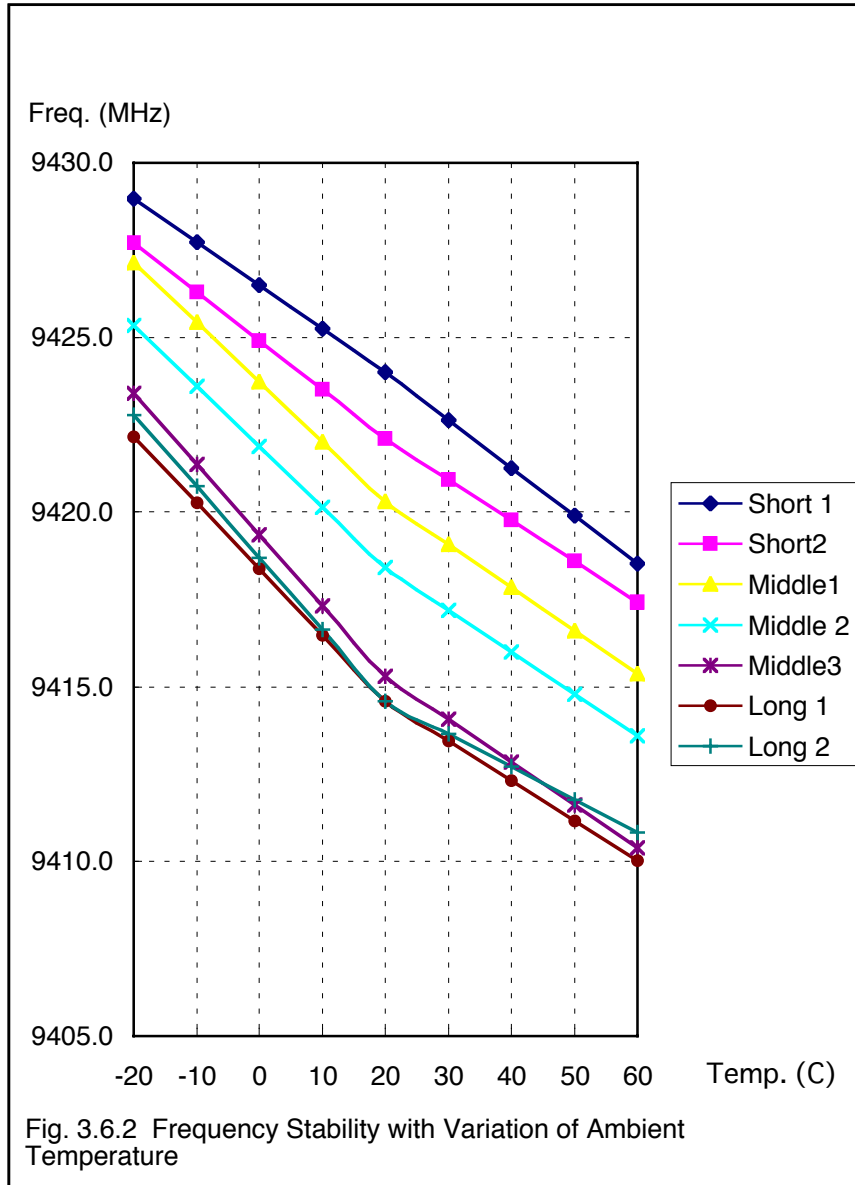

3.7 Suppression of Interference Aboard Ships (FCC Rule, 80.217)

3.7.1 Measuring Antenna Characteristics at Representative Frequencies:

Whip antennas are used to determine the level of interference caused by the radar to shipboard receivers. These antennas have the following characteristics (refer to impedance charts attached):

Length	Test Frequency (Hz)	Impedance (Ω)	θ	R (Ω)	C or L
6 m	500.5 k	1 k	-90°	0	80 pF
6 m	1.992 M	1.25 k	-86°	87.2	64 pF
6 m	10.00204 M	158		109	140 pF
4 m	27.5 M	95		83.5	128 pF
5/8 λ	150 M	116.5		105.5	52.5 nH
1/4 λ	450 M	70.5		34.5	5.68 pF

3.7.2 Test Site: Rooftop of 6-story building,
Furuno Electric Company, Ltd.
Ashihara-cho 9-52, Nishinomiya-city, 662-8580 JAPAN

3.7.3 Measuring Instrument List:

See Attachment D [List of Test/Measuring Equipment].
(Instruments for measuring antenna characteristics are listed below.)

- (1) Network Analyzer, HP 8753C
- (2) Spectrum Analyzer, ADVANTEST TR4172
- (3) Spectrum Analyzer, HP 8566B
- (4) Antennas,
 - for 14 k - 10 MHz, 6 m whip
 - for 10 - 30 MHz, 4 m whip
 - for 30 - 300 MHz, VHF whip
 - for 300 - 1000 MHz, UHF whip

3.7.4 Test Results:

Interference levels to the respective antenna were measured at 2 m from the radar which was put in OFF and TRANSMIT conditions, and found within the specified limits.

3.7.4.1 Harmful Interference to Receiver (FCC Rule, 80.217 (a))

Limits: for 14 - 490 kHz, 5 $\mu\text{V/m}$
for 490 kHz - 1 GHz, 1 $\mu\text{V/m}$

Results: There is no spurious component which is deemed harmful interference. (Test data are shown in Attachment C.)

3.7.4.2 Electromagnetic Field (FCC Rule, 80.217 (b) - 1)

Limits: for below 30 MHz, 0.1 $\mu\text{V/m}$ at 1 nm (-20 dB $\mu\text{V/m}$)
for 30 to 100 MHz, 0.3 $\mu\text{V/m}$ at 1 nm (-10.5 dB $\mu\text{V/m}$)
for 100 to 300 MHz, 1.0 $\mu\text{V/m}$ at 1 nm (0 dB $\mu\text{V/m}$)
for over 300 MHz, 3.0 $\mu\text{V/m}$ at 1 nm (9.5 dB $\mu\text{V/m}$)

Results: Interference was measured with the antenna located 2 m from the radar and converted to levels at 1 nm. There is no spurious component exceeding the limits.
(Test data are shown in Attachment C.)

3.7.4.3 Power Input to an Artificial Antenna (FCC Rule, 80.217 (b) - 2)

Limits: for below 30 MHz, 400 μW
for 30 to 100 MHz, 4,000 μW
for 100 to 300 MHz, 40,000 μW
for over 300 MHz, 400,000 μW

Results: There is no spurious component exceeding the limits.
(Test data are shown in Attachment C.)

MEASUREMENT OF IMPEDANCE OF TEST ANTENNAS

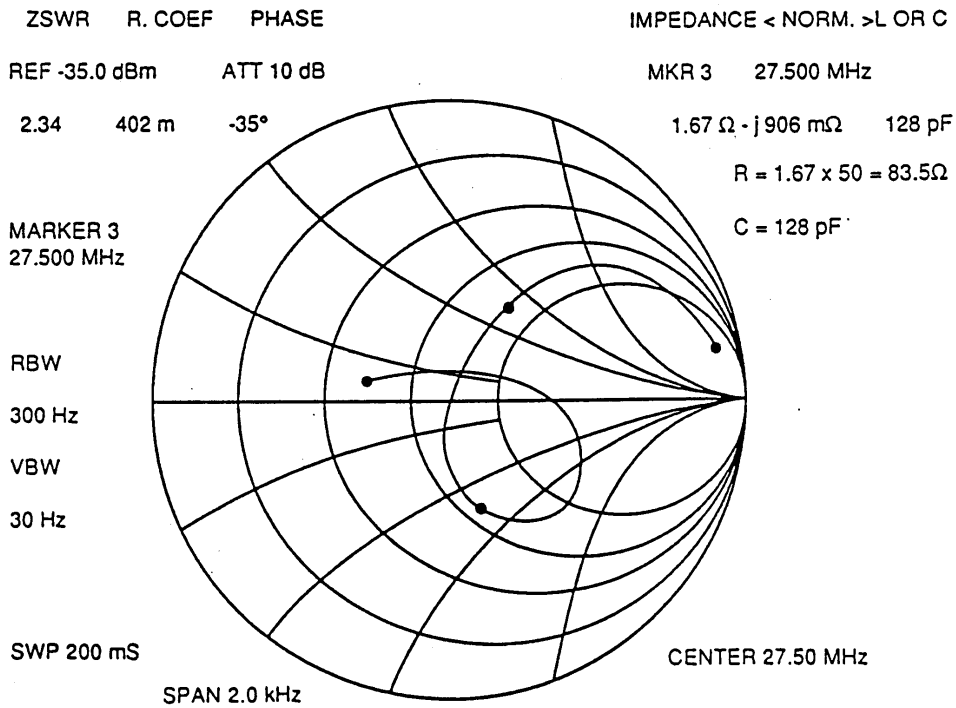
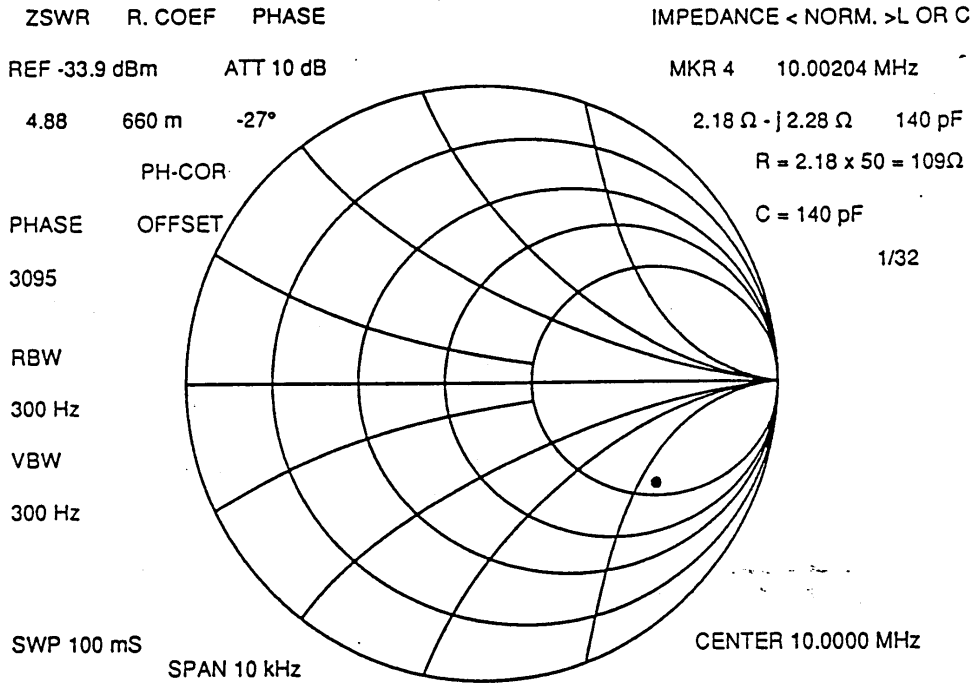

MEASUREMENT OF IMPEDANCE OF TEST ANTENNAS

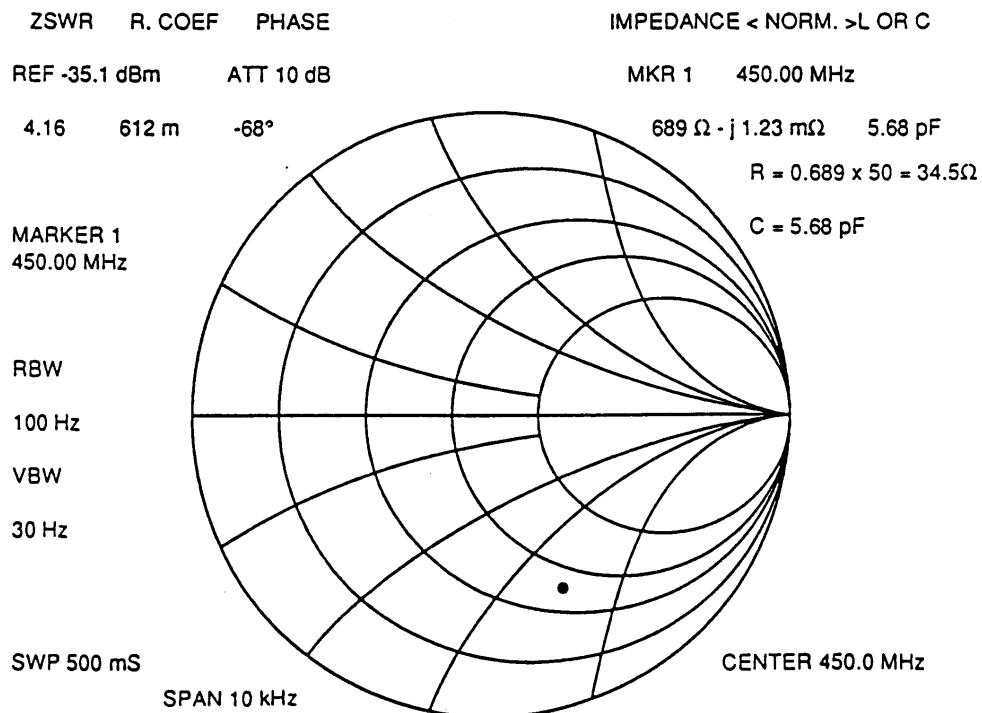
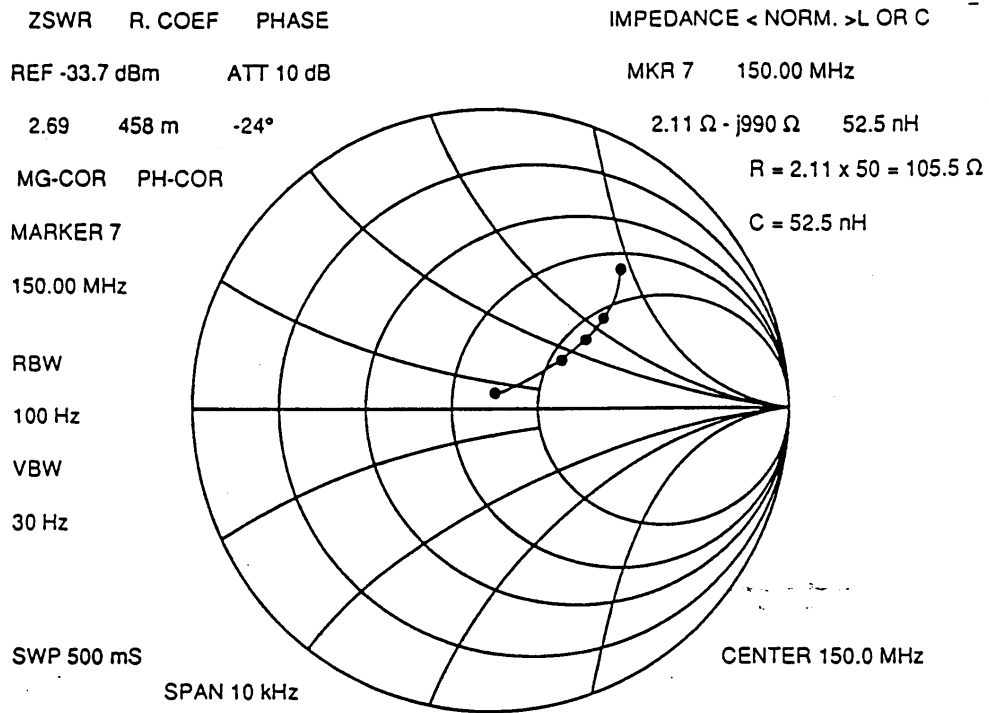

4 Photographs to Reveal Equipment Construction and Layout (FCC Rule, 2.1033)

(See Attachment E Photos of the Equipment Under Test (EUT))

5 Description of Circuitry and Devices (FCC Rules, 2.1033)**5.1 Function of Each Semiconductor or Active Device****ANTENNA UNIT**

TRANSCIVER MODULE (RTR-078)

RF unit controller PCB 03P9346 (RFC)

CR1 - CR4:	Voltage protection
CR5:	Rectifier
CR6 - CR8:	Voltage protection
CR9:	LED
Q1 - Q4:	Pulse amplifier
Q5 - Q12:	Transistor switch
U1:	Operational amplifier
U2:	Voltage regulation
U3:	Buffer
U4:	Voltage regulation
U5:	Operational amplifier
U6:	Oscillator
U7:	A/D converter
U8:	Comparator
U9:	Inverter
U10 - U11:	Buffer

Modulator PCB 03P9244 (MD)

CR1 - CR3, CR5:	Reverse-Voltage Protection
CR4:	Rectifier
Q1-Q4, Q21:	Switching
Q5 - Q20:	FET Gate Driver
U1:	Regulator
U2:	Photo-Coupler

Chassis Mounted Parts

CR802 - CR803:	Clipper
----------------	---------

CR801:	Limiter
HY801:	3 Ports Circulator
U801:	MIC Frequency Converter with Limiter
V801:	Magnetron

IF amplifier PCB 03P9335 (IF AMP)

CR1:	Reverse voltage protection
CR2:	RF detection
CR3 - CR4:	Voltage shifter
CR5:	RF gate
CR6:	Reverse voltage protection
CR7:	Voltage shifter
CR8 - CR9:	RF limiter
CR10:	RF switch
Q1:	RF switch
Q2 - Q3:	Pulse amplifier
Q4:	RF switch
U1:	Comparator
U2:	Pulse amplifier
U3:	Log detector
U4:	Gated amplifier
U5:	Comparator
U6:	Switch
U7:	Variable gain controller
U8:	DC regulator
U9:	Variable gain controller
U10:	Switch
U11 - U12:	Video amplifier
U15:	DC regulator
U16:	Pulse amplifier
U17:	NAND gate
U18:	Comparator
U19:	DC regulator
U20 - U22:	3 dB Hybrid
U23:	Comparator
U24:	AND gate

Bearing Signal Generator PCB 03P9347 (BP GEN)

U1:	Comparator
U3:	Photo-interrupter
Q3 - Q4:	Buffer

Terminal Board 03P9349 (TB)

Active device: none.

Power Board 03P9348 (PWR)

CR1:	Q3 driver
CR2:	Protection for Reverse connection
CR11, CR21, CR31, CR41:	Switching
CR42:	Q41 driver
CR51:	Switching
CR52:	Reverse voltage protection
Q1 - Q2:	Q3 driver
Q3:	Switching
Q11:	Overcurrent protection
Q22 - Q24:	Switching
Q31:	Overcurrent protection
Q41:	Switching
Q42:	Q41 driver
U1:	5 V regulator
U2:	Voltage detector
U11:	12 V line switching controller
U12:	12 V line overcurrent detector
U21:	Magnetron heater line switching controller
U22:	5 V line overcurrent detector
U31:	5 V line switching controller
U41:	-12 V line switching controller
U51:	32 V line series regulator

5.2 Description of the circuitry and devices provided for determining and stabilizing frequency, for suppression of spurious radiation, for limiting modulation, and for limiting power

ANTENNA UNIT

TRANSCEIVER MODULE (RTR-078)

RF unit controller PCB 03P9346 (RFC)

In the RFC Board, the following 4 main functions are incorporated:

- (1) generating TX modulator trigger pulses with the specified pulse-length that fire the modulator FETs in MD Board.

TX trigger signals that are transmitted with the form of serial commands from the Processor unit trigger the internal digital counter included in the Field Programmable Gate Array U17 for counting up to the specified value, and then the TX modulator trigger pulses with the specified pulse-length are produced.

- (2) controlling the tuning voltage input to the MIC.

Micro-Processor U19 reads the tuning indication voltage transferred from the IF Amplifier Board through the internal A/D converter and generates/adjusts the tuning voltage through the internal D/A converter for maximizing the tuning indication voltage by using the feedback-control technologies.

- (3) generating the Gain- and STC-control voltages to input the IF Amplifier Board.

According to the control parameters transferred from the Processor unit, Micro-Processor U19 calculates the Gain and STC control voltages (waveforms) and places those data into the internal memory of the Field Programmable Gate Array U17, and generates the Gain- and STC-control voltages through the D/A converter U13.

- (4) transferring the Heading and Bearing signals with the form converted to the serial commands to the Processor unit.

The Heading and Bearing signals transferred from BP GEN Board is converted to the specified serial bit streams (commands) in the Field Programmable Gate Array U17, and then output to the Processor unit.

Modulator Board 03P9244 (MD)

The function of the modulator board is to produce a high tension pulse that drives the magnetron.

The high voltage (TX-HV) is charged into C1 to C4 through R1/R2 while the magnetron is inactive. This high voltage is discharged through the pulse transformer T801 when FETs Q1 - Q4 are conductive. T801 boosts the voltage and makes the magnetron oscillate.

Because the magnetron oscillates only when the FET is conductive, transmission pulselength can be changed by the pulselength fed to the gates of FETs.

Also the magnetron current is proportional to the discharging current via the FETs, thus the transmission power can be changed by the number of FETs conductive.

The four pulses TRIG.1 to TRIG.4 are produced on the RFC board and applied to the gates of Q1/Q2/Q3/Q4 via the current amplifiers Q5 to Q20.

The relay K1 and coil L1 are provided to eliminate the ringing at the trailing edge of the transmission pulse across the primary winding of T801. This relay is active when the short pulse 1 (Short 1) is selected.

Duplexer and Mixer

Since the radar system uses a single antenna for transmission and reception, and the efficient device is required for switching the transmitter and the receiver, this radar employs circulator HY801. The circulator HY801 is a passive directional coupler with three ports. The incoming signal is bent in the specific direction and emerges from another port with little loss, the other port being isolated. In the same manner, the received signal entering into another port is transferred to the other port, isolating one port. This operation of the circulator protects the receiver during transmission and minimizes loss of the received signal during reception.

The diode limiter is a self-activating switch made of two PIN diodes. Its function is to attenuate the strong transmission signals from the magnetron and other boat radars through the antenna and to protect the MIC (microwave IC) U801. The PIN diode conducts at a certain level of microwave power. When the diode is the cut-off state, the input impedance of the diode limiter matches the impedance of the waveguide, and the microwave energy is delivered to the MIC. When the diode is put into a conductive state, the waveguide is short-circuited and most of the input energy is reflected back to the transmitter side. The strong signal is thus weakened down to about 50 mW by the diode

limiter.

U801 is a microwave IC (MIC) incorporating a local oscillator and mixer diodes. The received microwave signal of 9410 MHz coming from the diode limiter is mixed with the local oscillation signal in the mixer diodes and converted to IF signal of 60 MHz.

IF amplifier PCB 03P9335 (IF AMP)

The 60 MHz IF signal from MIC is amplified by the IF amplifier, gain- and STC-controlled and delivered to the Processor unit.

The IF amplifier consists of 5 main parts, i.e. the first stage amplifiers (Q1, Q2 and Q3,) VGA (Variable Gain Amplifiers) (U7 and U9), the driver amplifier (U16), the logarithmic amplifier (U3) and the tuning amplifier (U2, T2, T4, U4, U6 and U5) for tuning indicator.

- In the first stage amplifiers Q2 and Q3, the input IF signal is split into 2 stages by the 3 dB Hybrid Splitter U20 and then each of the split IF signals are amplified, and finally combined by the 3 dB Hybrid Combiner U21 for improving the saturation level of the IF signal.
- In the VGA (U7 and U9), the IF signal is gain- and STC-controlled.
- In the driver amplifier (U16), the cable loss of IF signal caused between the Antenna unit and the Processor unit is compensated precedently. The amplified IF signal is then output through the TNC type connector (J823) of which the output impedance is 75 Ω .
- In the logarithmic amplifier (U3), the 60 MHz IF signal is detected and the video signal is generated. The video signal is also used for the Sub-display and for the auto-STC control. The video signal for the Sub-display is combined with the 60 MHz IF signal from the driver amplifier U16 by the Duplexer located in the output stage, and then output through the TNC type connector (J823) of which the output impedance is also 75 Ω .
- In the tuning amplifier (U2, T2, T4, U4, U6 and U5) for the tuning indicator, the 60 MHz IF signal from MIC is amplified by the IF amplifier U2, filtered with the band width of 2 MHz by the T2, amplified with the timing gate, detected by the diode CR2, and then output through the buffered amplifier U5. This detected signal consists of a DC voltage with the peak for the center frequency of the 60 MHz input IF signal.

Bearing Signal Generator PCB 03P9347 (BP GEN)

Bearing signal generator in the PCB generates a square wave signal used for synchronizing the sweep-rotation of the Display with the rotation of the Antenna radiator.

U3 Photo-interrupter is composed of a LED and a photo-transistor, and in the shape of "U".

The LED and the photo-transistor are enclosed in the U-shaped package with a gap that the

rotating timing disc goes through.

The timing disc is provided with 60 slits at regular intervals along its perimeter. This disc is fitted on the scanner motor shaft and rotated at a speed of 360 rpm.

The photo-transistor receives the LED light through the slit of the timing disc, and converts into the electric current. The output of the photo-transistor generates the signal voltage across R3, and then is reshaped by the comparator IC U1, and buffered and sent to the Processor unit for the use of the sweep-rotation signal.

6 Operator's Manual Incl. Circuit Diagrams (FCC Rule, 2.1033)

(See separate covers)