

FURUNO®

Installation Manual

MARINE RADAR MODEL 1622

SAFETY INFORMATION i
EQUIPMENT LISTS ii
SYSTEM CONFIGURATION iv

1. INSTALLATION

1.1 ANTENNA UNIT INSTALLATION 1
1.2 DISPLAY UNIT INSTALLATION 3

2. WIRING

2.1 CONNECTIONS 5

3. ADJUSTMENTS

3.1 INSTALLATION CHECK 8
3.2 EXCHANGING DISPLAY UNIT OF MODEL 1621 MARK-2 8
3.3 ADJUSTMENTS 8
3.4 ADJUSTMENTS FOR TECHNICIANS 10
3.5 I/O DATA CONFIRMATION 11
3.6 RESTORING DEFAULT SETTINGS 11

OUTLINE DRAWING D-1
INTERCONNECTION DIAGRAM S-1
SCHEMATIC DIAGRAMS S-2

© FURUNO ELECTRIC CO., LTD.

9-52, Ashihara-cho,
Nishinomiya, Japan 662

Telephone: 0798-65-2111
Telefax: 0798-65-4200

All rights reserved. Printed in Japan

PUB. No. JME-34520-Z
MODEL 1622

Your Local Agent/Dealer

FIRST EDITION :

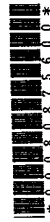

 **FURUNO ELECTRIC CO., LTD.**
NISHINOMIYA, JAPAN

SAFETY INFORMATION

WARNING



Do not open the equipment unless totally familiar with electrical circuits and service manual.

ELECTRICAL SHOCK HAZARD

Only qualified personnel should work inside the equipment.



Wear a safety belt and hard hat when working on the antenna unit.

Serious injury or death can result if someone falls from the radar antenna mast.

Construct a suitable service platform from which to install the antenna unit.

Serious injury or death can result if someone falls from the radar antenna mast.

Turn off the power at the mains switch-board before beginning the installation.

Fire, electrical shock or serious injury can result if the power is left on or is applied while the equipment is being installed.

CAUTION



Ground the equipment to prevent electrical shock and mutual interference.

Observe the following compass safe distances to prevent interference to a magnetic compass:

| | | |
|--------------|------------------|------------------|
| | Standard compass | Steering compass |
| Display unit | 0.65 m | 0.5 m |
| Antenna unit | 1.25 m | 0.95 m |

EQUIPMENT LISTS

Standard Supply

| NAME | TYPE | CODE NO. | QTY | REMARKS |
|------------------------|--------------|-------------|-------|--------------------|
| Antenna Unit | RSB-0060-068 | | 1 | |
| Display Unit | RDP-125-S | | 1 | |
| Installation Materials | CP03-16500 | 000-086-761 | 1 set | No antenna cable |
| | CP03-16510 | 000-086-762 | | 5 m antenna cable |
| | CP03-16520 | 000-086-763 | | 10 m antenna cable |
| | CP03-16530 | 000-086-764 | | 15 m antenna cable |
| | CP03-16540 | 000-086-765 | | 20 m antenna cable |
| Spare Parts | SP03-09800 | 000-085-441 | 1 set | |

Installation Materials

| NAME | TYPE | CODE NO. | QTY | REMARKS |
|----------------------|---------------|-------------|-------|------------------------------------|
| Antenna Cable (5 m) | 03S9144 | 000-129-608 | | Select one, connector at both ends |
| Antenna Cable (10 m) | 03S9145 | 000-129-609 | 1 | |
| Antenna Cable (15 m) | 03S9146 | 000-129-611 | | |
| Antenna Cable (20 m) | 03S9147 | 000-129-612 | | |
| Power Cable Assy. | 03S9148 | 000-129-613 | 1 | Connector, fuse, 3.5 m |
| Hex Head Bolt | M10X25 | 000-862-308 | 4 | For antenna unit |
| Dummy Film | 03-118-1103-0 | 000-185-380 | 1 set | For display unit |
| Tapping Screw | 5X20 | 000-802-081 | 4 | For display unit |
| EMI Core | RFC-10 | 000-141-085 | 1 | For antenna cable |

Spare Parts

| NAME | TYPE | CODE NO. | QTY | REMARKS |
|------|-------------------|-------------|-----|------------------|
| Fuse | FGBO-A 5A 125 VAC | 000-549-064 | 2 | For display unit |

Optional Equipment

| NAME | TYPE | CODE NO. | QTY | REMARKS |
|-------------------------|------------------|-------------|-----|--|
| Cable Assy. | MJ-A6SPF0012-050 | 000-134-424 | 1 | Connector at both ends, 5 m |
| | MJ-A6SPF0012-100 | 000-133-817 | 1 | Connector at both ends, 10 m |
| Antenna Cable Assy. | 03S9175 | 000-130-034 | 1 | Connector at one end, 24 V spec. only. |
| Radome Mounting Bracket | OP03-93 | 008-445-080 | 1 | For sailboat |
| External Buzzer | OP03-136 | 000-086-443 | 1 | Connector at one end, 1 m |

1. INSTALLATION

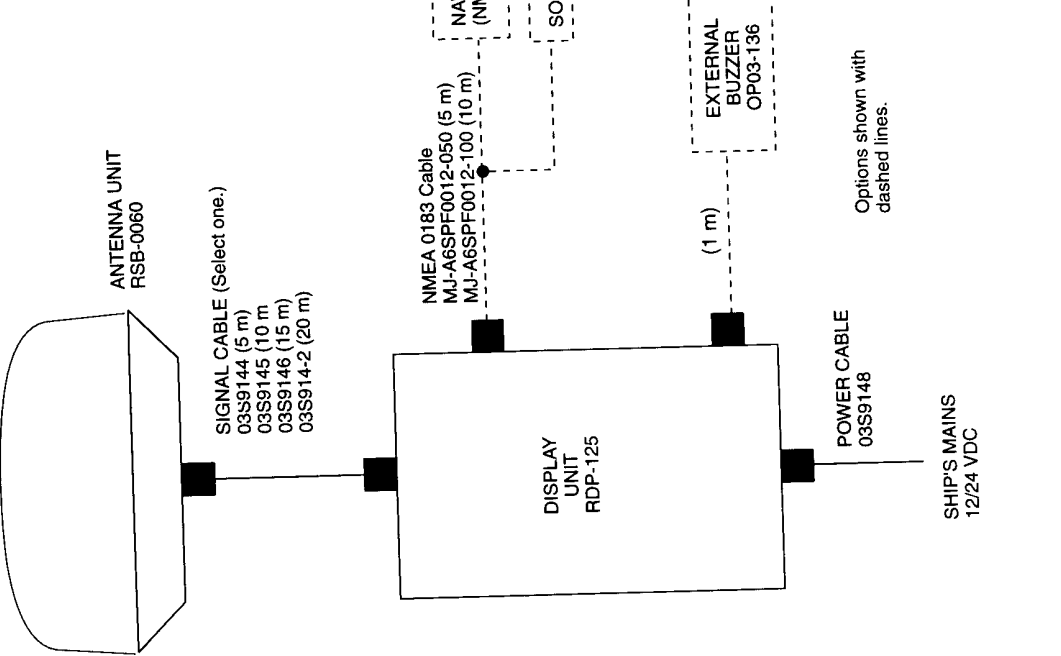

1.1 Antenna Unit Installation

Mounting considerations

When selecting a mounting location for the antenna unit keep in mind the following points.

- Install the antenna unit on the hardtop, radar arch or on a mast on an appropriate platform. (For sailboats, a mounting bracket is optionally available.) It should be placed where there is a good all-round view with, as far as possible, no part of the ship's superstructure or rigging intercepting the scanning beam. Any obstruction will cause shadow and blind sectors. A mast, for instance, with a diameter considerably less than the width of the antenna unit, will cause only a small blind sector. However, a horizontal spreader or crossrees in the same horizontal plane would be a much more serious obstruction; place the antenna unit well above or below it.

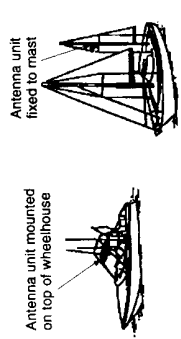

Figure 1 Typical antenna unit placement on powerboat and sailboat

- Locate the unit at least two meters away from a direction finder antenna to prevent interference to the direction finder.
- In order to minimize the chance of picking up electrical interference, avoid where possible routing the signal cable near other electrical equipment onboard. Also avoid running the cable in parallel with power cables.
- The compass safe distance of 1.25 meters (standard compass) and 0.95 meters (steering compass) should be observed to prevent deviation of the magnetic compass.

Mounting using the optional mounting bracket

A mounting bracket for fastening the antenna unit to a mast on a sailboat is optionally available (Type OP03-93, Code No.008-445-080).

1. Remove mounting hardware at the bottom of the antenna base. You may discard the hardware. Assemble the mounting bracket and fasten it to a mast. Fasten the antenna unit to the bracket.

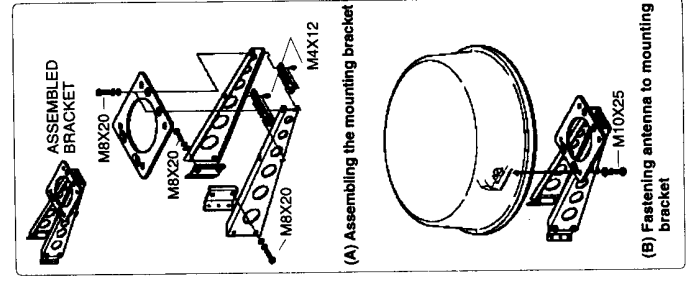

Figure 2 How to assemble and mount the optional mounting bracket

2. Follow steps 5-10 in "Mounting on a platform".

Mounting on a platform

1. Remove mounting hardware at the bottom of the antenna unit; four each of hex bolts (M10X20), spring washers and flat washers. Save mounting hardware to use it to fix the antenna unit to the mounting platform later on.

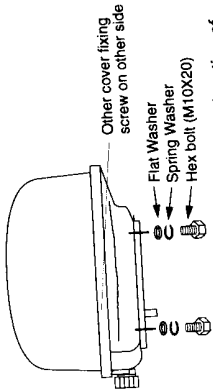

Figure 3 Antenna unit, showing location of mounting hardware

2. Unfasten three screws to remove the cover.
3. Construct a platform (wood, steel, or aluminum) of 5-10 mm in thickness whose dimensions are as shown in Figure 4. Fasten the platform to the mounting location. Find the cable entry on the antenna base. Next, position the base so the cable entrance faces the stern direction and the vent tube is extending downward through the hole for the vent tube.

Note: When drilling holes in the platform, be sure they are parallel with the fore and aft line.

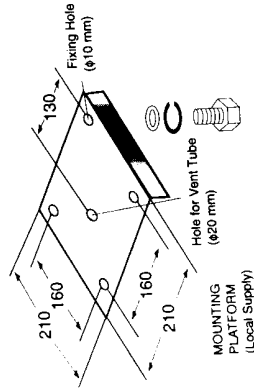

Figure 4 Dimensions of antenna platform

4. Using the hex bolts, flat washers and spring washers removed at step 1, fasten the base to the platform. **The torque should be between 200-250 kg/cm.**

Note: Longer hex bolts (M10X25) are supplied with the installation materials. Use them instead of the hex bolts removed earlier if the mounting platform is very thick.

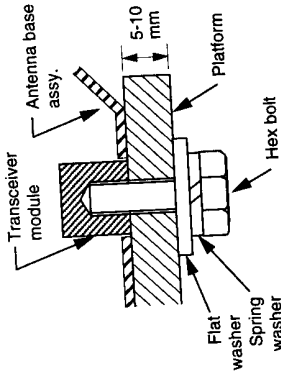

Figure 5 How to fasten the base to platform

5. Unfasten the cable of the rotation detector from the cable clamp.

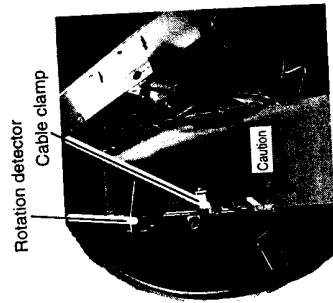

Figure 6 Antenna unit, inside view

6. Unfasten 11 screws to dismount the shield plate.

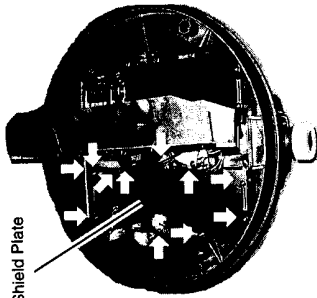

Figure 7 Antenna unit, inside view

7. Pass the antenna cable with connector through the gasket and cable clamp, and then tighten cable gland.

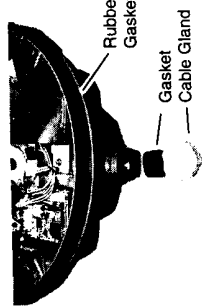

Figure 8 Antenna unit, inside view

8. Referring to Figure 9, connect the 9-pin connector to J801. Attach EMI Core RFC-10 (supplied) to antenna cable. Fasten the shield to location shown in the Figure 9.

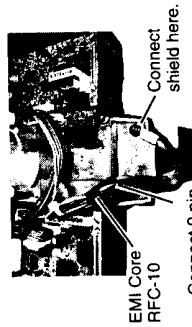

Figure 9 How to connect the signal cable to the antenna unit

9. Refasten the shield plate. Be sure not to pinch cable from the rotation detector with the shield plate. See "Caution" in Figure 6 for details.

10. Confirm that the gasket is properly positioned and then tighten the fixing bolts for the cover. Coat antenna cable gland with sealing compound for waterproofing.

1.2 Display Unit Installation

Mounting considerations

When selecting a mounting location for the display unit keep in mind the following points.

- Locate the display unit in a position where you can view and operate it conveniently.
- The orientation of the display unit should be so the radar screen is viewed while the operator is facing in the direction of the bow. This makes determination of your position much easier.
- The display unit is designed and constructed to be splashproof, thus it can be installed outdoors. You can even hose it down after a day's outing. If it is to be installed outdoors, we recommend installing it in an enclosed cabinet, for maximum protection against the marine environment.
- The display unit consumes only a moderate amount of power, so there is no need for forced air ventilation. However, you should provide adequate space behind and around the unit to permit circulation of air.
- Even though the picture is quite legible even in bright sunlight, keep the display unit out of direct sunlight or at least shaded because of heat that can build up inside the cabinet.
- The temperature and humidity of the mounting location should be stable and moderate. No LCD can provide adequate contrast if the ambient temperature is too low or too high.

2. WIRING

2.1 Connections

Connect the signal cable, the power cable and the ground wire as shown in Figure 11.

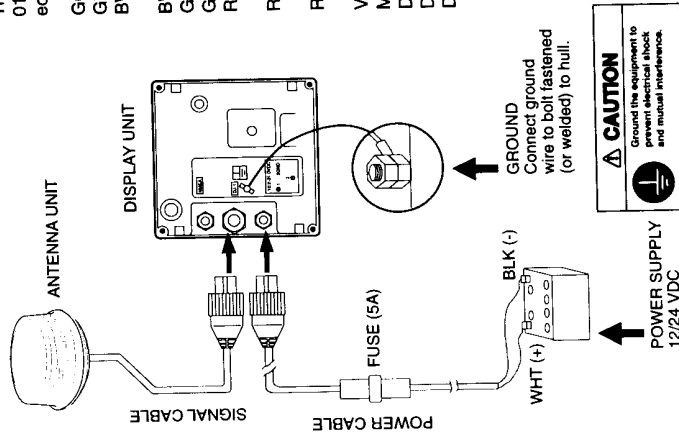

Figure 11 Connections

- Mounting**
- The display unit can be mounted on a tabletop, the overhead, or flush mounted in a panel.
1. Fix the hanger to the mounting location with four tapping screws (supplied).
 2. Fit the knob bolts to the display unit.
 3. Cover the unused bolt holes with the blind films supplied.
 4. Install the display unit in the hanger. Tighten the knob bolts securely.

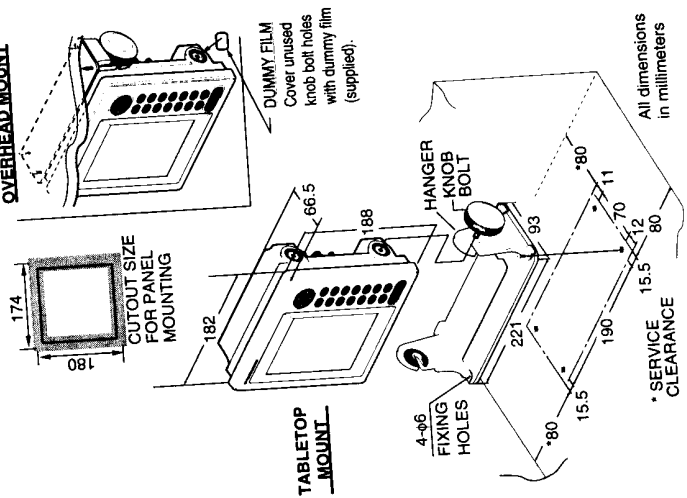

Figure 10 Mounting dimensions of display unit

- Make sure you allow enough clearance both to get to the connectors behind the unit and to allow you to get your hands in on both sides to loosen or tighten the mounting knobs. Make sure you leave at least a foot or so of "service loop" in cables behind the unit for servicing or easy removal of the connectors.
- The compass safe distance of 0.65 meters (standard compass) and 0.5 meters (steering compass) should be observed to prevent deviation of the magnetic compass.

Connection of external equipment Navigator/echosounder

This radar can receive the following NMEA 0183 format data sentences from a navigator or echosounder:

- GGA: GPS - Rx status, L/L
- GLL: Geographic position - Lat/Long
- BWR: Bearing and Distance to Waypoint - Rhumb line
- BWC: Bearing and Distance to Waypoint
- GLC: Geographic Position - Loran-C
- GTD: Geographic Position - Time Difference
- RMA: Recommended Minimum Specific Loran-C Data
- RMB: Recommended Minimum Navigation Information
- RMC: Recommended Minimum Specific GPS/Transit Data
- VTG: Track Made Good and Ground Speed
- MTW: Water Temperature
- DBT: Depth Below Transducer
- DPS: Depth Below Surface
- DPT: Depth

NMEA connection

You will need an NMEA cable (MJ-A6SPF0012-050/100, option) to connect a video sounder or a navigator. Connect it to the NMEA connector at the rear of the radar display unit as shown right.

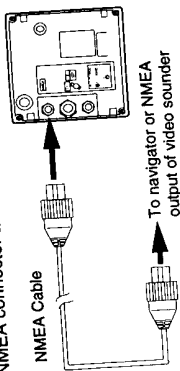
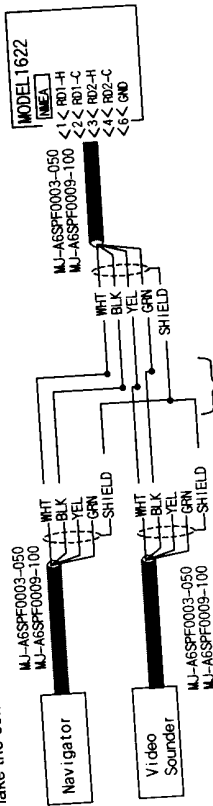

Figure 12 Navigator connection

To connect both a video sounder and a navigator, use NMEA cable MJ-A6SPF0003-050/MJ-A6SPF0009-100 and solder them as shown below.

Note 1: Tape cables to prevent short.

Note 2: Do not use a cross wiring-type NMEA cable which has connectors at both ends (for example, MJ-A6SPF0012-050). Miswiring can result when one of the connectors is removed to make the connection.



After soldering, wrap with self-vulcanizing tape.

Figure 13 Connection of video sounder and navigator cables

To connect equipment whose NMEA output uses other than a FURUNO 6 pin NMEA connector, use NMEA cable type MJ-A6SPF0003/MJ-A6SPF0009-100 to make the connection.

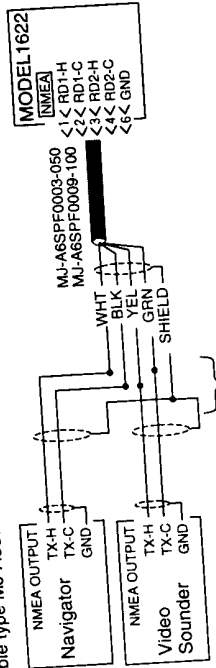

After soldering, wrap with self-vulcanizing tape.

Figure 14 Connection of video sounder and navigator cables using NMEA cable type MJ-A6SPF0003/MJ-A6SPF0009-100

External buzzer

Access J6 on the DU Board as shown in Figure 16. Plug in the connector of the external buzzer at J6. Seal the hole with sealing compound.

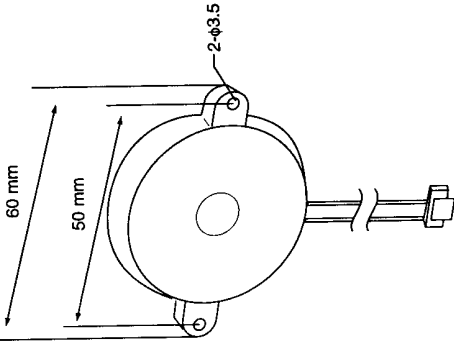
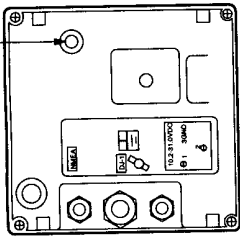

Figure 15 External buzzer

External Buzzer
Make a hole of 16φ here. Seal hole with sealing compound after connecting cable.



Note: Use hammer and appropriate metal rod to make hole.

Figure 16 Display unit, rear view

3. ADJUSTMENTS

2. Select MODEL.

3. Select M1621/M2.

4. Press the [MENU] key to close the menu.

3.3 Adjustments

Do the following in order to adjust the radar.

1) Adjustment of picture

- Press the [POWER] key on the display unit. The display should light. In approximately one, ST-BY appears at the screen center.
- When ST-BY appears press the [TX] key. The radar will start transmitting, and you will probably see some targets, even though the radar is not yet properly adjusted.
- Adjust the sensitivity to display a small amount of noise on the screen.
- Press the [-] key several times to select the minimum range. Adjust the STC to display nearby radar targets clearly on the screen. Too much STC action will eliminate small targets, and too little STC action will cause the screen to be so full of targets and noise that it is hard to determine which target is which as compared to visual sightings.

2) Heading alignment

You have mounted the antenna unit facing straight ahead in the direction of the bow. Therefore, a small but conspicuous target dead ahead visually should appear on the heading mark (zero degrees).

In practice, you will probably observe some small error on the display because of the difficulty in achieving accurate initial positioning of the antenna unit. The following adjustment will compensate for this error, up to ± 30 degrees.

3.1 Installation Check

After installing the system it is a good idea to check it for proper installation, following the checklist provided below.

- The vent tube on the antenna unit is extending downward and is not kinked or pinched.
- Four fixing bolts securing the antenna unit are securely tightened.
- The signal cable is waterproofed at the base of the antenna unit.
- The signal cable is securely retained against the mast or mounting and is free of interference from running rigging.
- The cable gland on the deck or bulkhead is waterproofed, if provided.
- Connectors of external equipment are securely plugged into the radar display unit.
- The power connections to the battery are of correct polarity.

3.2 Exchanging Display Unit of MODEL 1621 MARK-2

When exchanging the display unit of the MODEL 1621 MARK-2 with that of the MODEL 1622, it is necessary to maintain the magnetron warmup time. This should be done with the radar in stand-by.

- Press \blacktriangle together for about 10 seconds to show the display shown in Figure 17.

| | | |
|----------------------|--------------|----------------------------------|
| PROGRAM NO | 03591580XX | SEL MENU BY \blacktriangle KEY |
| 1 | MODEL M1622 | M1621/M2 |
| 2 | DISPLAY MAIN | DEMO |
| NAV DATA (NMEA 0183) | | |
| GLL | BWR | BWC GLC GTD |
| RMA | RMG | RMC VRG MTW |
| DBT | DPT | GGA |

Figure 17 Maintenance menu

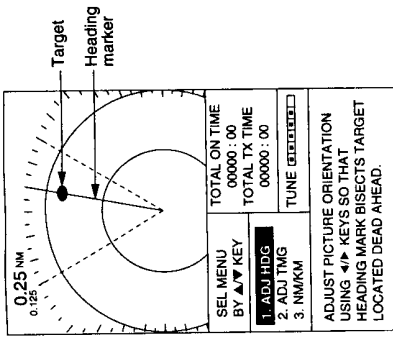

Figure 20 How to adjust heading

- As a final test, move the boat towards a small buoy and confirm that the buoy shows up dead ahead on the radar when it is visually dead ahead.

3) Sweep timing

This adjustment ensures proper radar performance, especially on short ranges. The radar measures the time required for a transmitted echo to travel to the target and return to the source. The received echo appears on the display based on this time. Thus, at the instant the transmitter is fired, the sweep should start from the center of the display (sometimes called sweep origin.)

A trigger pulse generated in the display unit goes to the antenna unit through the signal cable to trigger the transmitter (magnetron). The time taken by the signal to travel up to the antenna unit varies, depending largely on the length of signal cable. During this period the display unit should wait before starting the sweep. When the display unit is not adjusted correctly, the echoes from a straight local object (for example, a harbor wall or straight pier) will not appear with straight edges – namely, they will be seen as pushed out or pulled in near the picture center. The range of objects will also be incorrectly shown.

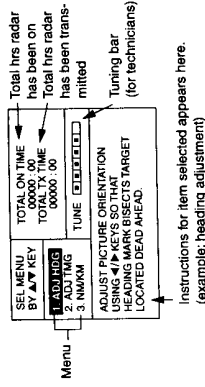

Figure 18 Installation menu

- Select ADJ HDG. Your display should now look something like the one shown in Figure 19.

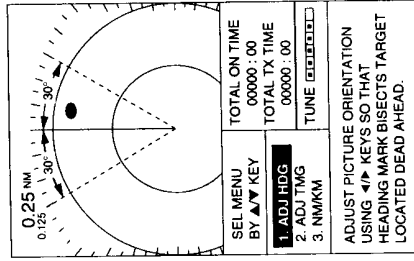

Figure 19 Display for adjustment of heading

- Press \blacktriangle to bisect the target selected at step 1 with the heading marker.

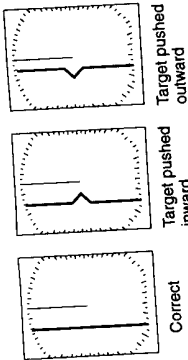

Figure 21 Examples of improper and correct sweep timings

1. Transmit the radar on a range between 0.125 and 0.5 nm and adjust the sensitivity and STC.
2. Visually select a straight echo (harbor wall, straight pier).
3. Select ADJ TMG on the menu.

| | |
|---|-----------------------------|
| SEL MENU BY ▲/▼ KEY | TOTAL ON TIME 00000 : 00 |
| 1. ADJ HDG | TOTAL TX TIME 00000 : 00 |
| 2. ADJ TMG | TUNE <input type="text"/> |
| 3. NM/KM | |
| IDENTIFY STRAIGHT TARGET SUCH AS BREAKWATER, MAKE ITS ECHO STRAIGHT ON SCREEN USING ▲/▼ KEYS. | |

Figure 22 Installation menu, ADJ TMG selected

4. While looking at the target selected at step 2, straighten it by pressing ► if it is pulled inward, or ◀ if it is pushed outward.

4) Unit of range measurement for VRM and cursor

The unit of range measurement for the VRM and the cursor may be selected to nautical mile or Kilometers as follows:

1. Select NM/KM on the menu.

| | |
|---|-----------------------------|
| SEL MENU BY ▲/▼ KEY | TOTAL ON TIME 00000 : 00 |
| 1. ADJ HDG | TOTAL TX TIME 00000 : 00 |
| 2. ADJ TMG | TUNE <input type="text"/> |
| 3. NM/KM | |
| RANGE UNIT PRESS ▲/▼ KEYS TO SELECT NAUTICAL MILE OR KILOMETER AS THE UNIT OF RANGE. | |

Figure 23 Installation menu, NM/KM selected

2. Select unit of range desired.
3. Press the [MENU] key to close the installation menu.

3.4 Adjustments for Technicians

1) Magnetron heater voltage

Magnetron heater voltage is formed at the MD Board of the antenna unit and preadjusted at the factory for use with any length of signal cable. Therefore no adjustment is required. However, verify heater voltage as follows:

1. Turn on the power. Do not transmit the radar.
2. Connect a multimeter, set to 10 V DC range, between #6(+) and #4(-) of test point TP804 on the MD Board in the antenna unit.
3. Confirm that the multimeter shows 8.0 V \pm 0.1 V. If it does not, adjust potentiometer VR801 on the MD Board.

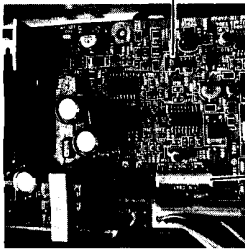

Figure 24 Antenna unit, inside view

2) Radar function

This radar can function as the main radar or a demonstration model, displaying internally generated radar echoes. The demonstration function requires the EG Board (option).

1. Set the radar in stand-by.
2. Press and hold down ▲ and ▼ and together (about 10 seconds) to display the maintenance menu.

| | | |
|--|--------------------------|---|
| ROM prog. no. | PROGRAM NO 03591580XX | SEL MENU BY ▲/▼ KEY |
| Radar function | 1. MODEL M1622 | M1621/M2 DEMO |
| Nav data sentences (confirmation only) | 2. DISPLAY MAIN | DEMO |
| | | NAV DATA (NMEA 0183) GLL BWR BWC GLC GTD RMA RMG RMC VRG MTW DBT DPT GGA |

* Nav data sentences highlighted if corresponding data is input to the radar.

Figure 25 Maintenance menu

3. Select MAIN or DEMO from the DISPLAY field. (MAIN, Main radar display, DEMO, demonstration display.)
4. Press the [MENU] to close the menu.

3.5 I/O Data Confirmation

You can confirm NMEA input from a navigator or echosounder. Follow the procedure shown in 2) Radar function to display the maintenance menu. NMEA sentences being input are shown in reverse video.

3.6 Restoring Default Settings

All default menu settings can be restored by turning on the power while pressing and holding down [MENU] and ▼.

FURUNO

D-1

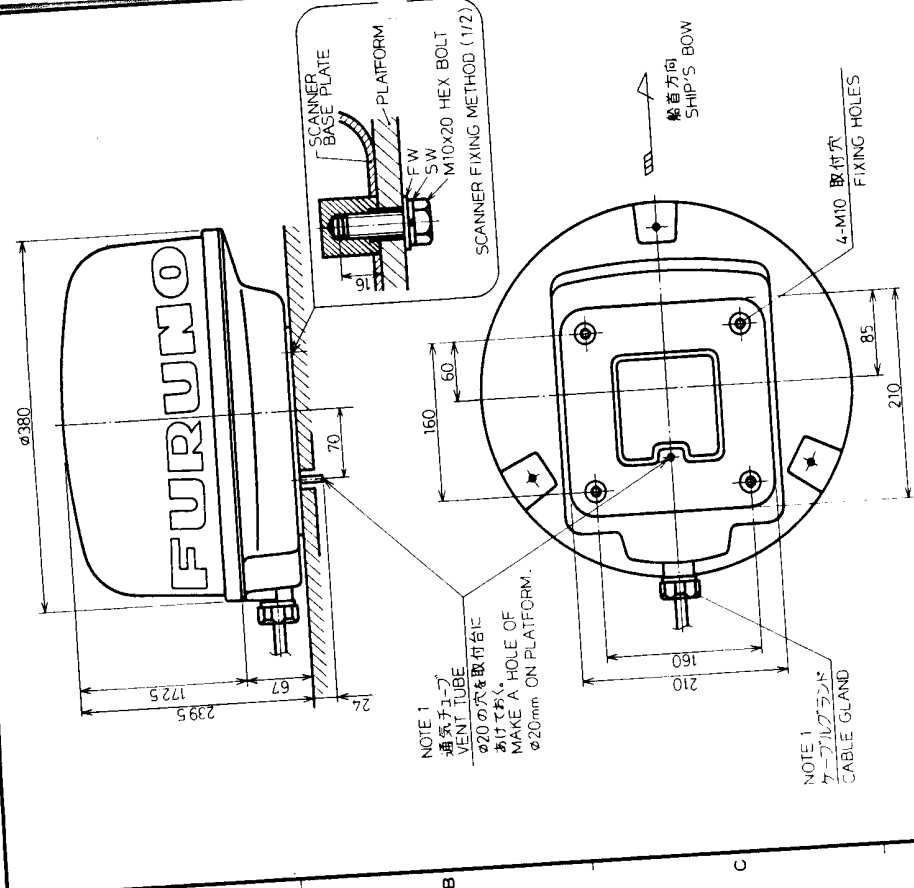

| | | | |
|--------------------|-----------|--------|--------|
| スタンダード STANDARD | 1.7 m | 2.0 m | 1.25 m |
| ステアリング STEERING | 1.3 m | 1.5 m | 0.95 m |
| M-1621 | M-1621 M2 | M-1622 | |

TYPE RSB-0060
名称 変圧機部
外寸図

DRAM
Apr. 28 '99 T.YAMASAKI
CHECKED
Apr. 28 '99 K.KAWAMURA
M1622
M1621M2
M1621M1

03-135-1000-60
OUTLINE DRAWING
NAME DISPLAY UNIT
MODEL 1622 MBR-2
外寸図
指示部
RDP-116/125

DRAM
Apr. 28 '99 T.YAMASAKI
CHECKED
Apr. 28 '99 K.KAWAMURA
M1622
M1621M2
M1621M1

03428-001-B
SCALE 1/3
MASS 2.0 kg

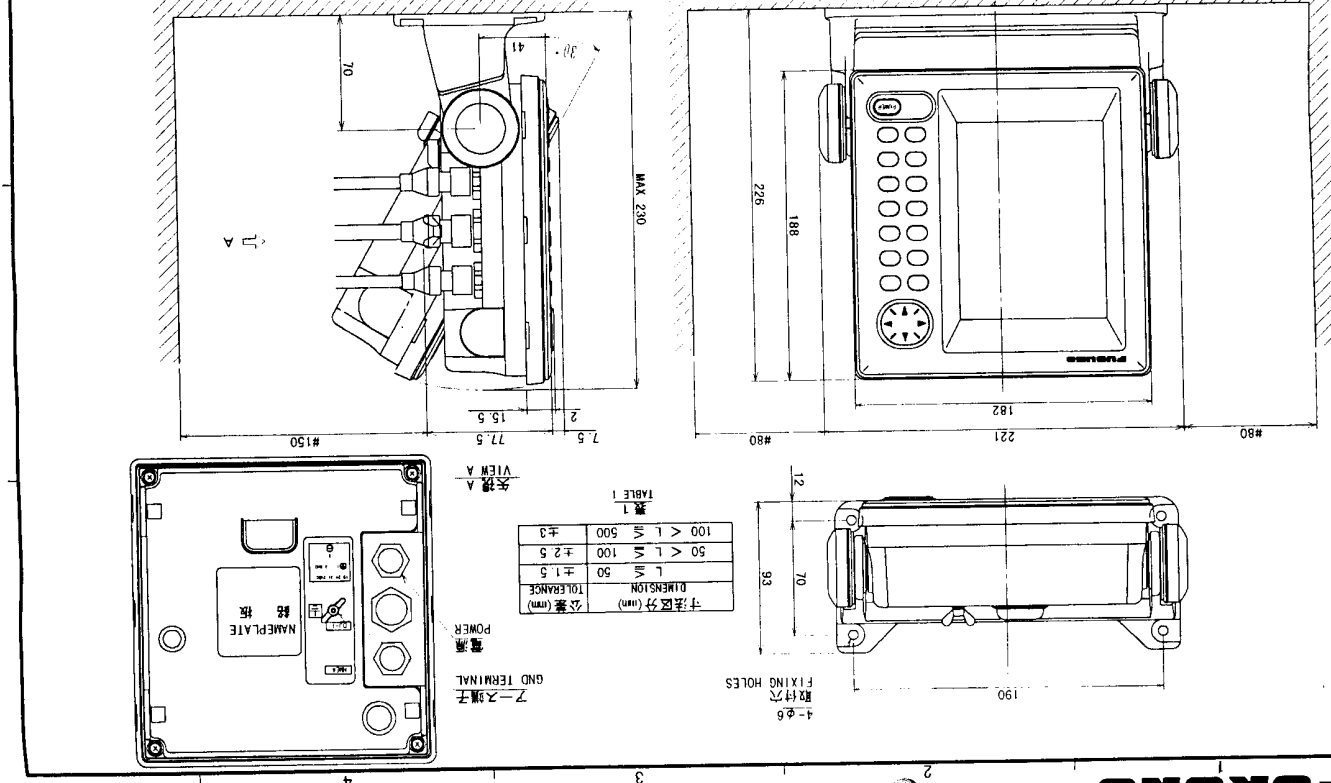

NOTE 1: 指定なき寸法公差は表1による。
NOTE 2: 推奨する最小コーナー空間寸法。

NOTE 1 INDICATES TOLERANCE OF DIMENSIONS.
NOTE 2 # RECOMMENDED SERVICE CLEARANCE.

FURUNO ELECTRIC CO., LTD.

D-2

| | | | |
|----------|-------------------------|----------------|-------------------|
| DWG NO. | C3452-K01-A | 03-146-6003-1 | SCHEMATIC DIAGRAM |
| SCALE | 1/1 | APPLICABLE TO: | SCANNER UNIT |
| APPROVED | Apr 20 1999 K. Kusuriki | MODEL NO. | MODEL 1622 |
| CHECKED | Apr 20 1999 K. Kusuriki | 名称 | 空中線部 |
| DRAWN | Apr 20 1999 T. Yamazaki | 名称 | RSB-0060-068 |

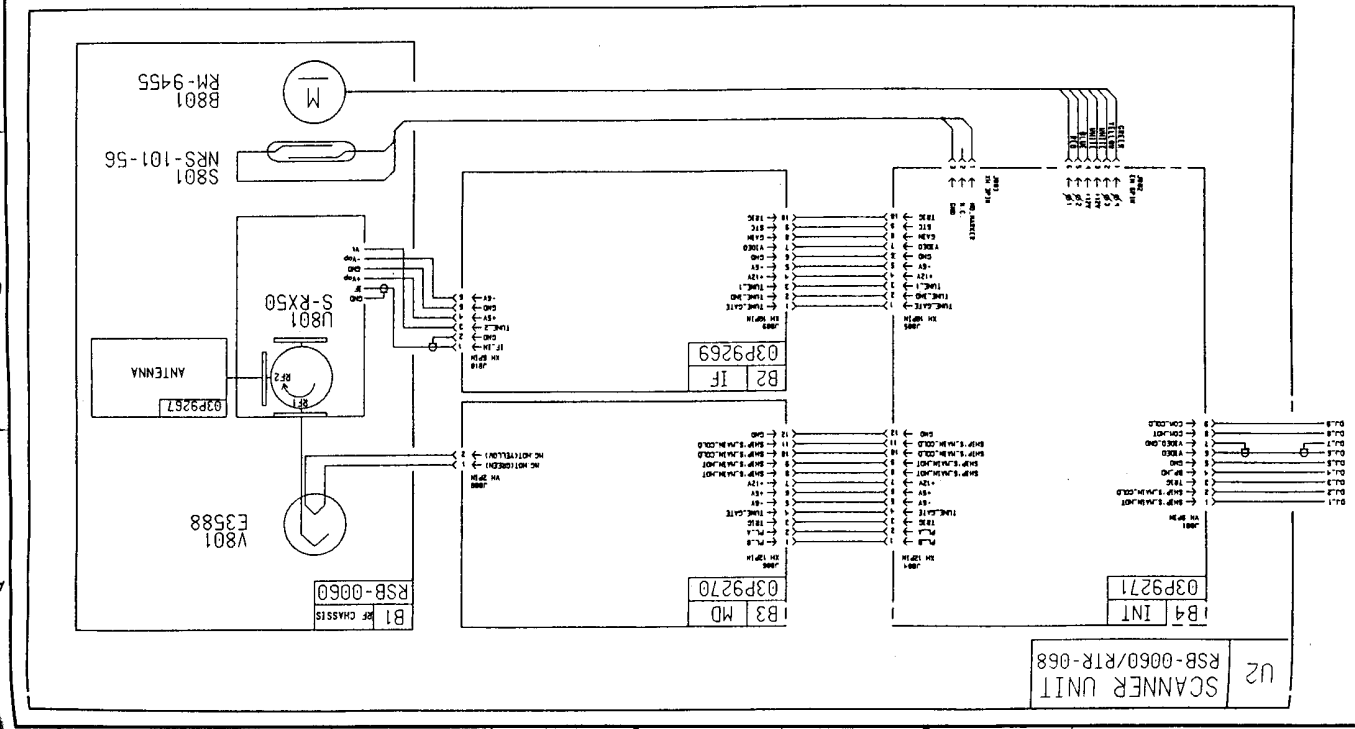

| | | | |
|----------|-------------------------|--------------|-------------------------|
| DWG No. | C3452-001-A | 03-146-6001- | INTERCONNECTION DIAGRAM |
| SCALE | 1/1 | NAME | MARINE RADAR |
| APPROVED | Apr 20 1999 K. Kusuriki | 名称 | 船舶用レーダー |
| CHECKED | Apr 20 1999 K. Kusuriki | 名称 | 船舶用レーダー |
| DRAWN | Apr 20 1999 T. Yamazaki | 名称 | 船舶用レーダー |

- 注記
- 1) 工場にて取付済み。
 - 2) 添付所省略。
 - 3) オプション。
 - 4) 空中線部のケーブルは完全に7-入する。
 - 5) 外部機器に接続。
 - 6) 航海ケーブルは2系統接続可能。(ケーブル加工必要)
- NOTE
- 1) FITTED AT FACTORY.
 - 2) SHIPYARD SUPPLY.
 - 3) OPTION.
 - 4) GROUND EFFECTIVELY AT SCANNER UNIT.
 - 5) SUPPLIED WITH EXTERNAL EQUIPMENT.
 6. 2WAY DATA INPUT AVAILABLE (CABLE MODIFICATION NEEDED)

