

FURUNO

OPERATOR'S MANUAL

Distance Meter for Golfer

“Kyoripita”

MODEL GDM-10



FURUNO ELECTRIC CO., LTD.
NISHINOMIYA, JAPAN

FOREWORD

Thank you for purchasing the FURUNO "Kyori-pita" GDM-10 distance meter for golf.

This distance meter provides a simple way to measure the distance between the player and the pin.

Once the mother unit in back of the pin is calibrated, the distance from the player to the pin can be measured by simply aiming the child unit at the pin and pushing a button.

Operation of the child unit is simple, but the mother unit must be recalibrated when the position of the cup is changed. Be sure to read this manual before operation.

Caution

Changes and/or modifications to the circuit of this distance meter are prohibited by the Radio Law. Do not touch the circuit inside this distance meter.



CONTENTS

Before Using Your Distance Meter	1
How the Kyori-pita Works	1
Part Names and Functions	2
Installing the Mother Unit	3
Mounting the Pole	3
Setting the Mother Unit	3
Installing on the Green	4
Calibration	5
(Entering the distance between the pin and the mother unit)	
Automatic Input Mode	5
Manual Input Mode	6
Setting the Timer and Clock of the Mother Unit	8
Using the Timer	8
Setting the Internal Clock.....	9
Changing the Battery of the child Unit ..	11
(When the Battery is Dead)	
Changing the Child Unit Battery	11
Changing the Battery of the Mother Unit	12
Removing the Battery	12
Installing the Battery	12
Battery Low Display	13
Battery Low Display	13
Charging the Batteries	14
Child Unit	14
Mother Unit	14
Measuring the Distance to the Pin	15
Child Unit Q&A Examples	16
Maintenance	17
Maintenance of the Mother Unit	17
Maintenance of the Child Unit	18
Specifications	19



Before Using Your Distance Meter



How the Kyori-pita Works

- 1 The distance from the pin to the mother unit is measured and entered into the mother unit in advance.
- 2 An ultrasonic signal is sent from the child unit to the mother unit.
- 3 When the mother unit receives the ultrasonic signal from the child unit, it then sends back a signal representing the distance between the child unit and the mother unit minus the distance entered in 1.
- 4 The distance to the pin is displayed on the child unit.

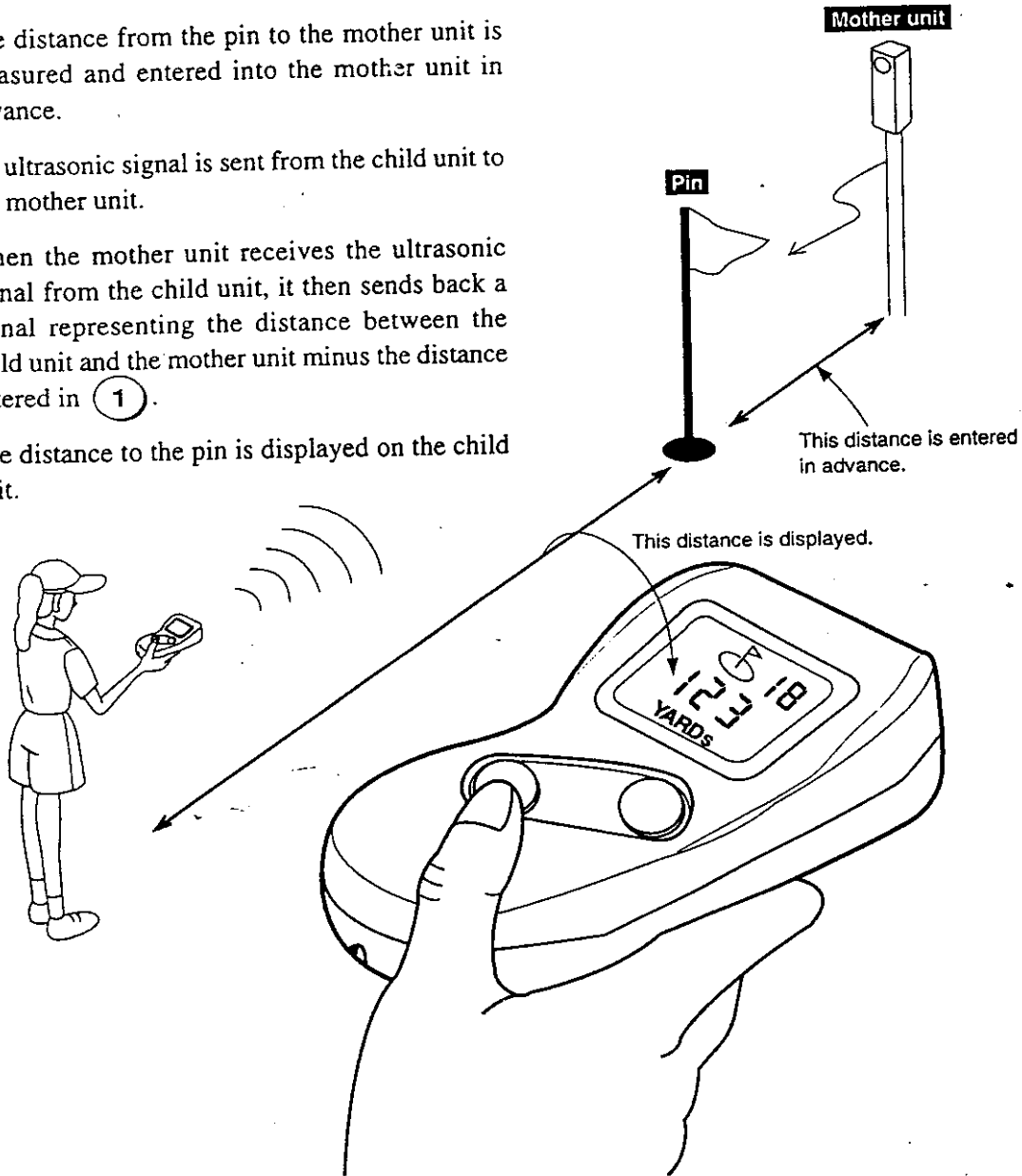

WARNING

Never press the YARDAGE button while aiming the child unit at yourself or another person. In particular, never allow the mesh portion, from which the ultrasonic signal is emitted, to come close to the ears.



Part Names and Functions

■ Mother unit

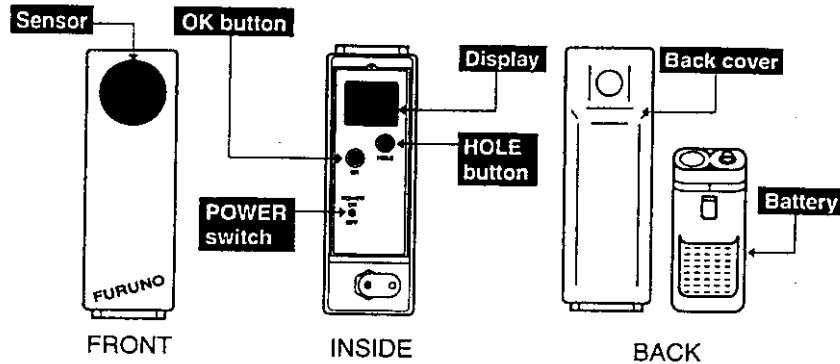

■ Display (Mother unit, child unit)

※ When operating normally, the child unit always displays the flag mark, hole number, and the distance in yards to the pin.
(The child unit does not have a power switch.)

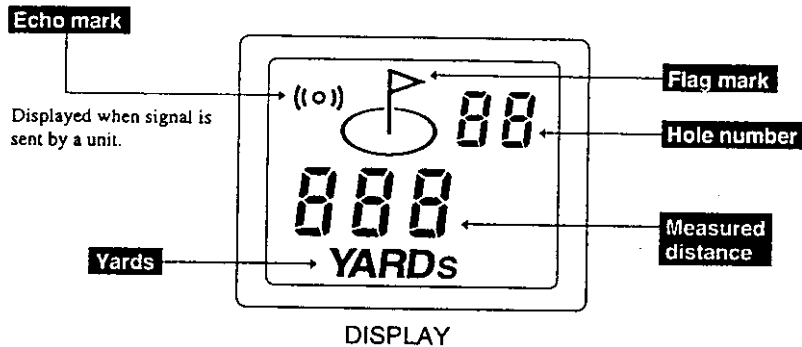

■ Child unit

※ A child unit which displays "CAL" is exclusively for calibration use.

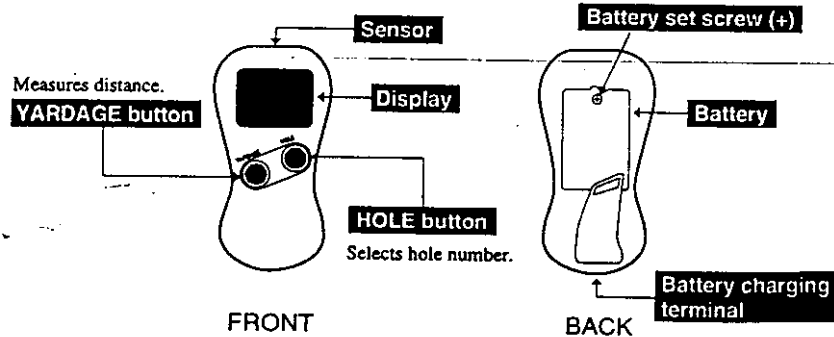

■ Battery charger

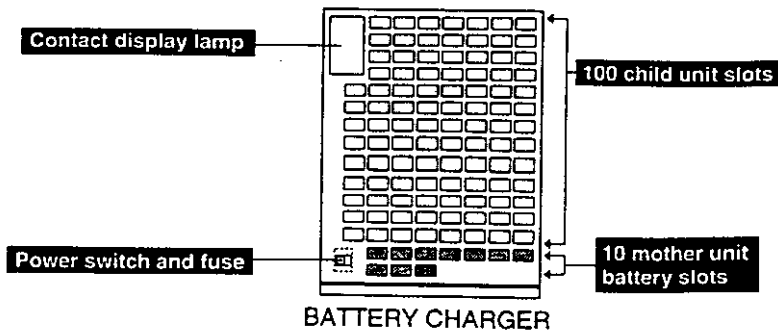

NOTE

Before using for the first time, charge the batteries for about two days.

The capacity of the rechargeable batteries may have worn down. After unpacking the new units, insert the child units (batteries attached) and the batteries for the mother units into their respective slots in the battery charger and allow them to charge for two days. (→P13)



Installing the Mother Unit

- The mother unit is attached to either a standard pole or a long pole (optional) and installed at the far side of the green. Here, only an outline of the procedure is presented. See the separate "Mother Unit Installation Instructions" for details on the actual installation procedure.



Mounting the Pole

- 1 Insert the antenna into the pole.
- 2 Using the special tool, fasten the pole to the mother unit with the screws.

CAUTION

Be sure to attach the antenna to the specified pole.

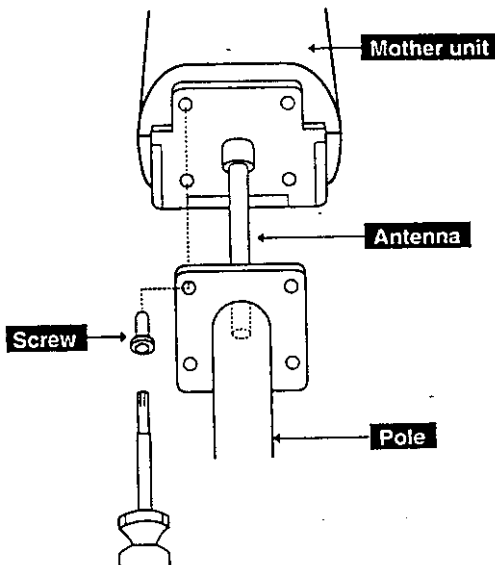

Setting the Mother Unit

- 1 Install the batteries. (→P11)
- 2 Press the HOLE button to set the hole number.
- 3 Set the timer as necessary. (→P8)



Installing on the Green

- 1 Install the pole in a location at least 5 yards from the pin but not more than 100 yards from the pin such that it will not get in the way. If the terrain is hilly and there are places from which it is difficult for the ultrasonic signal to reach the mother unit, use the optional long pole to raise the mother unit as high as possible.

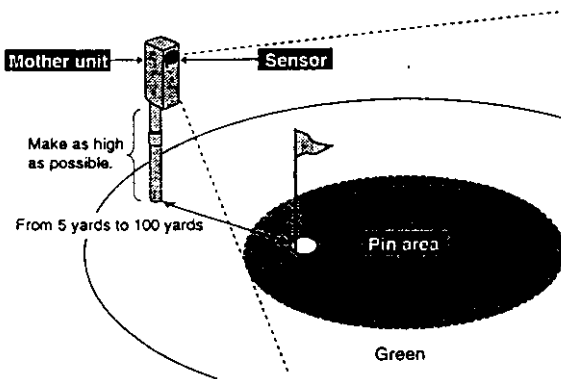

- Install in a location from which the back cover of the mother unit can be opened and closed easily.
- Plant the pole deeply enough into the ground to prevent it from falling over due to such causes as strong winds. (It is strongly recommended that concrete be used to fix the pole in the ground.)
- Do not hammer the top of the mother unit in order to insert the pole into the ground.

- 2 Aim the sensor of the mother unit toward the fairway.
- 3 Calibrate the mother unit.
(→P5)



Calibration

(Entering the distance between the pin and the mother unit)

When the position of the mother unit or the cup is changed, the distance between the mother unit and the pin must be measured and stored in the memory of the mother unit. This is called calibration.

■ There are two methods of calibration: automatic input mode and manual input mode.



Automatic Input Mode

● This method uses the child unit to automatically input the distance between the mother unit and the pin into the mother unit.

● This method is allowed when the distance from the pin to the mother unit is between 5 and 100 yards.

● A calibration child unit which displays "CAL" must be used.

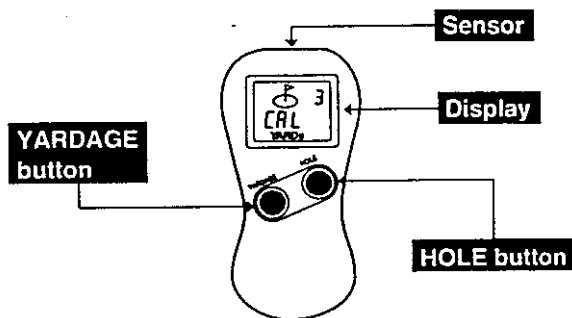

- 1 Press the HOLE button on the calibration child unit to set the hole number.

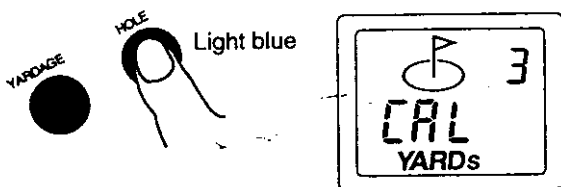

- 2 From the position of the pin, aim the child unit at the mother unit and press the YARDAGE button.

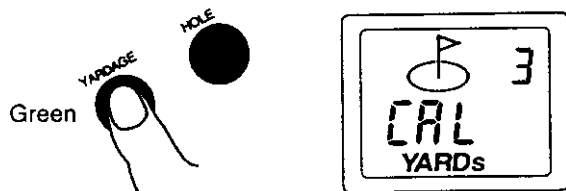

- When four sound pulses — which indicate the signal is being sent — have been emitted and the distance from the mother unit to the pin is displayed, the calibration is complete. (The distance is automatically input into the mother unit.)

If the sound pulse is not emitted four times or the displayed distance is obviously inaccurate, repeat the procedure from **2**.



When only one sound pulse is emitted

Make sure that the power switch of the mother unit is ON and that the correct hole number is displayed.

■ Once the calibration is performed, it does not need to be repeated so long as the position of the pin is not changed.



Manual Input Mode

- Values from 0 to 100 yards can be entered.
- This method requires operation of the mother unit only. (The child unit is not used.)

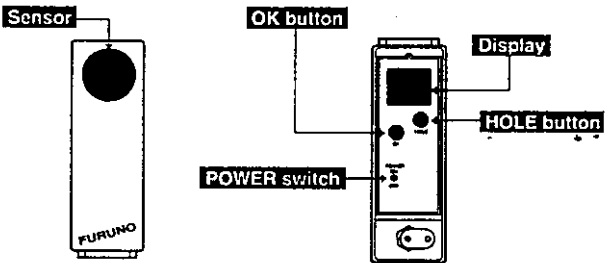

- Use the included key to open the back cover of the mother unit.
- Press the HOLE button to set the hole number to 21.

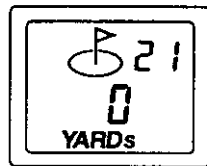
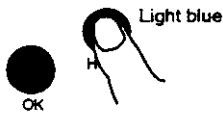

Each time the HOLE button is pressed, the value increases by one. Pressing and holding down the button increases the value quicker.

- Press the OK button.

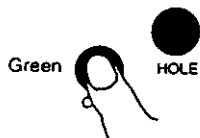

The distance display flashes.

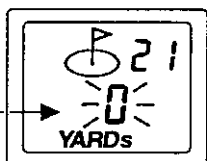

- ④ Press the HOLE button to set the desired value.

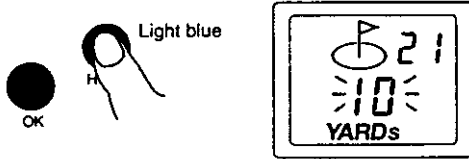

- ⑤ Press the OK button.

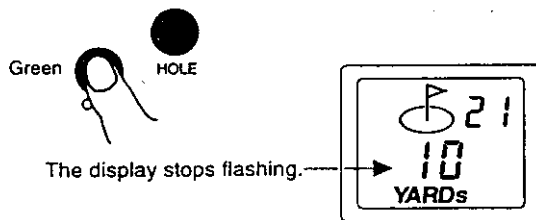

- ⑥ Use the HOLE button to return the hole number to its original value.
- Be sure to perform this step.

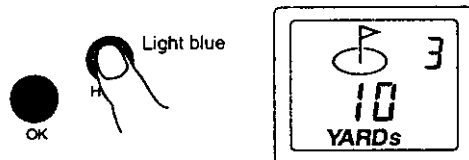

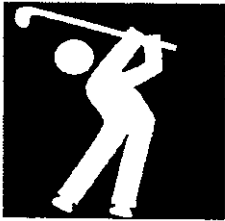

Setting the Timer and Clock of the Mother Unit

The mother unit has an internal clock (timer) which can turn off the unit at night. Set the timer according to the hours of play.



Using the Timer

- 1 Use the included key to open the back cover of the mother unit.
- 2 Press the HOLE button to set the hole number to 20.

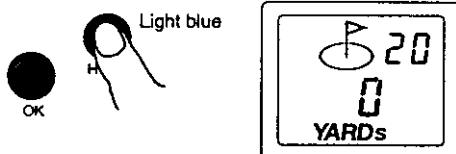

- 3 Press the OK button.

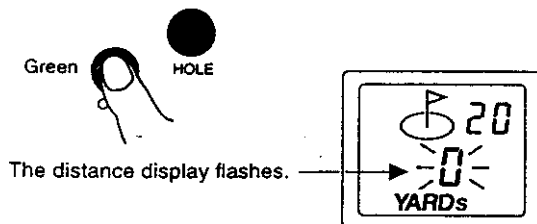

- 4 Press the HOLE button to select the desired operating time-number.

Number	Operating time
1	4:00 - 20:00
2	4:00 - 19:00
3	5:00 - 20:00
4	5:00 - 19:00
5	6:00 - 20:00
6	6:00 - 19:00
7	Always OFF
8	Always ON



The timer is set to number 6 (6:00 - 19:00) at the factory. Select the number which most closely corresponds to the desired operating time.

⊙ Setting the Timer of the Mother Unit ⊙

- 5 Press the OK button.

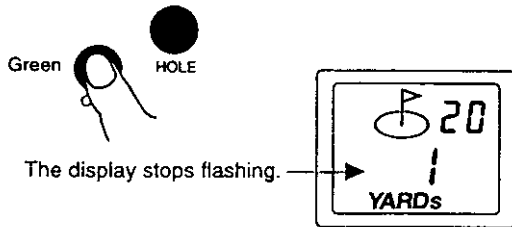

- 6 Use the HOLE button to return the hole number to its original value.
- Be sure to perform this step.

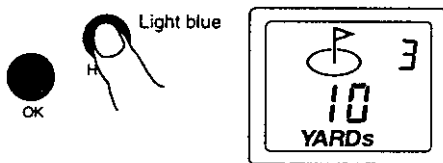

Setting the Internal Clock

- 1 Use the included key to open the back cover of the mother unit.
- 2 Press the HOLE button to set the hole number to 19.

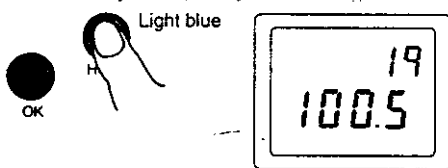

- 3 Press the OK button.

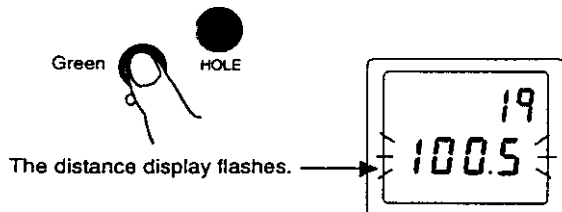

- 4 Press the HOLE button to set the hour value.

- 5 Press the OK button.
The minute value flashes.

- 6 Press the HOLE button to set the minute value.

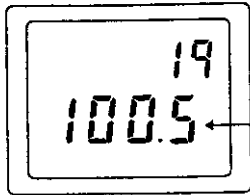

This means 10:05.

- 7 Press the OK button.

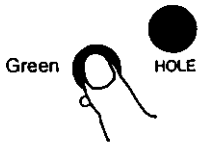

The display stops flashing.

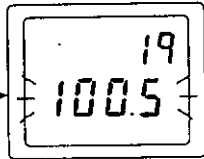

- 8 Use the HOLE button to return the hole number to its original value.
- Be sure to perform this step.

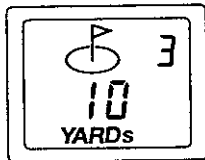
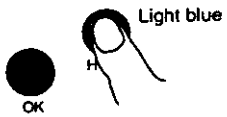

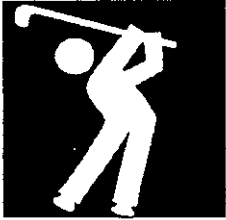

Changing the Battery of the Child Unit (When the Battery is Dead)

- The battery life for both the mother unit and the child unit is approximately three years, although it varies depending on the conditions of use.
- When the batteries run down quickly even after charging for a long period of time, change the batteries.
- Since the batteries inherently have a limited life, they are not covered under the warranty.
- Change all of the batteries together.



Changing the Child Unit Battery

- Be sure to read this section when first using the child unit, as well as when changing the battery.

1 Open the battery case cover. Remove battery.

2 Connect the new battery.
• As shown in the figure, be sure to check the direction and connect the battery correctly.

3 Close the battery case cover.
• Tighten the screw securely with the special screwdriver.
• If the cover is not closed securely, its waterproofing effect will be diminished.

4 Charge for two days.

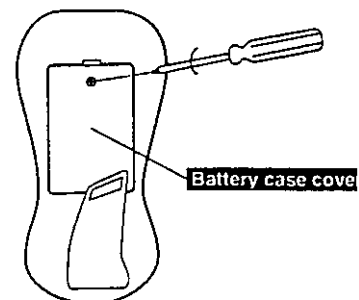
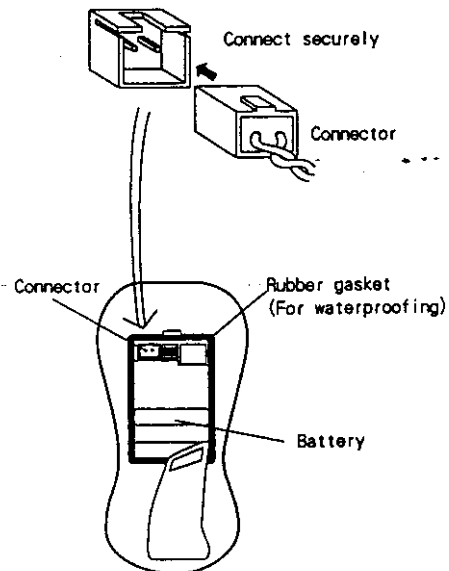



Changing the Battery of the Mother Unit

- Avoid changing the batteries in the rain. Using the unit while wet may result in damage to the unit.
- The battery can be used for one week. Change the battery on the same day every week.
- Change the batteries of all the mother units in the same manner.
- Recharge the removed battery.



Removing the Battery

- 1 Open the back cover using the included key.
- 2 Pull the belt and remove the battery.

CAUTION

Be careful not to short the terminals or pull on the tube.

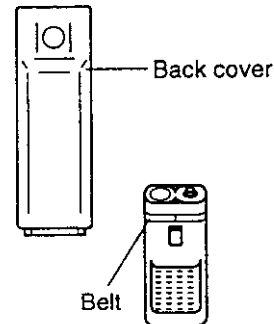

Installing the Battery

- 1 Remove the terminal cover from the battery.
- 2 Insert the battery — terminal end first — and install it.
 - Hold the battery with the terminals up and the label facing toward you.

CAUTION

Be careful not to short the terminals or pull on the tube.

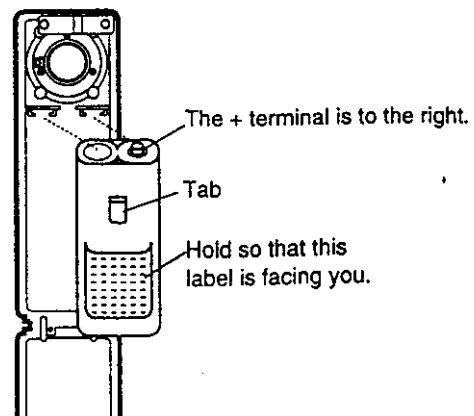

CAUTION

Be careful not to confuse the removed battery with batteries which have been changed.

- 3 Close the back cover.
- 4 Attach the terminal cover to the removed battery.
 - Be careful not to confuse fresh batteries with those which have just been removed.



Battery Low Display



Battery Low Display

For both the mother unit and the child unit, low battery power is indicated by the flag mark, the hole number and the distance all flashing simultaneously.

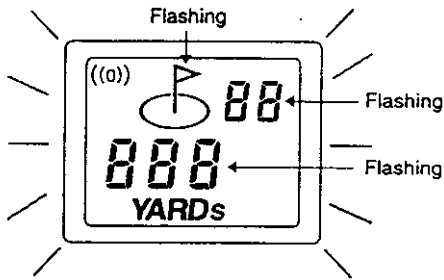

Charge the battery when the indications are flashing.



Charging the Batteries

- Turn ON the power switch to the battery charger before inserting batteries.
- Always insert child units which are not in use and mother unit batteries which have been changed into the battery charger.

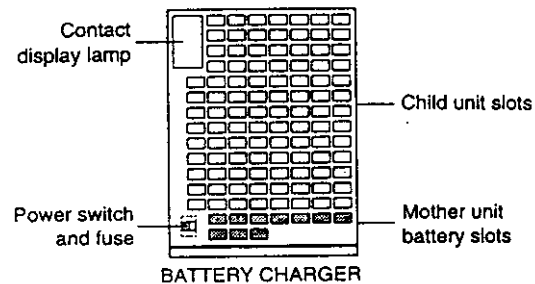

Child Unit

Insert the child unit into the slot in the battery charger as shown in the figure. Make sure the contact display lamp on the upper right-hand corner of the battery charger lights. If the terminals are dirty, wipe them clean with a dry cloth.

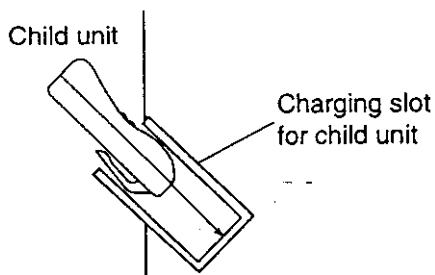

Whenever a child unit is not in use, be sure to insert it into the battery charger.

If left long enough without recharging, the display will go blank and it may not be possible to revive the child unit.



Mother Unit

As shown in the figure, remove the terminal cover and insert the battery pack into the mother unit slot in the battery charger. Make sure the contact display lamp lights. If the terminals are dirty, wipe them clean with a dry cloth.

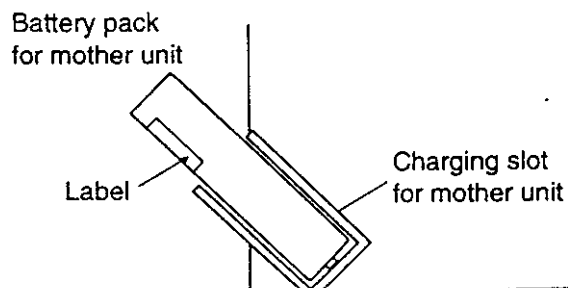



Measuring the Distance to the Pin

- Distances ranging from 30 to 200 yards can be measured.

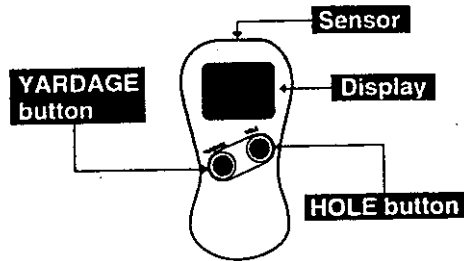

- Use the HOLE button to set the hole number.

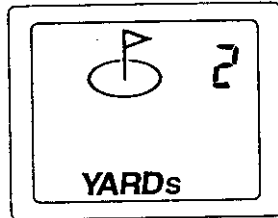
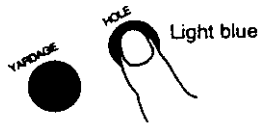

HOLE Button

Each time the button is pressed, the value increases by one. Pressing and holding down the button increases the value quicker.

- Aim the sensor at the pin and press the YARDAGE button.

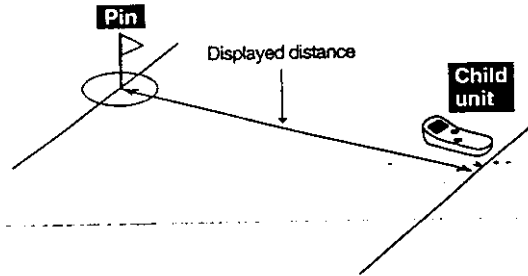
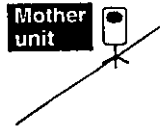
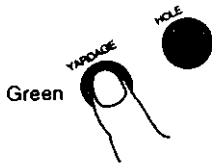

- The distance to the pin is displayed. (The distance is displayed for five seconds.)

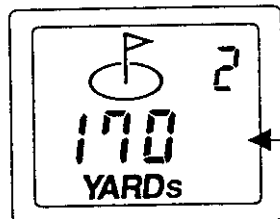

When ERR is displayed after each of several measurement attempts

Make sure the power switch of the mother unit is ON and the displayed hole number is correct.



When ERR is displayed

This display indicates that the measurement failed. Try the measurement again.



When 30 or 200 is flashing

These displays indicate that the measured value was 25-29 yards or 201-220 yards.

CAUTION

- When the course is hilly or there are objects in the way such that it is difficult for the ultrasonic signal to reach the mother unit, or when there are particularly strong winds blowing, measurement may not be possible.
- In strong winds, there may be a fair amount of random error in the distance measurements.
- Use of this apparatus during a public golf tournament violates Article 14, Line 3 of the rules of golf.



WARNING

Never press the YARDAGE button while aiming the child unit at yourself or another person.



Child Unit Q&A Examples

Players who use the child unit will likely have some questions regarding it. Refer to the following to answer their questions.

Q How do you cut off the power?

A There is no need to cut off the power. When the battery gets low, the display will flash, but a fully charged unit can be used for two days.

Q How do you measure the distance?

A Press the light blue button with HOLE written next to it to set the hole number. (If you hold the button down, the hole number changes rapidly.)

Next, aim the head of the unit at the pin and press the YARDAGE button (green). When the YARDAGE is pressed, a "sshu-" sound is heard and the distance is displayed in yards.

Q What range of distances can the unit measure?

A From 30 yards to 200 yards.

Q I measure from all different angles. What is the error of these measurements?

A The error is ± 1 yard.

Q Can you measure the distance when you cannot see the pin?

A The mother unit is positioned so that measurements can be made even when the pin is not visible, but the shape of the terrain sometimes makes measuring difficult.

Q Do you have to be careful with these things?

A The child unit will not be damaged by dropping it on the grass or allowing a little bit of rain to get on it. Although carrying it in your pocket is okay, it is best to attach it to your belt with the belt clip when not using it.

Q There is nothing on the display. What is wrong?

A The battery has probably run down completely. (It needs to be recharged.)

Q Why isn't there a value in the distance display?

A The distance display goes off after five seconds.

Q Why is **Err** displayed?

A Err is displayed when the measurement failed.

Q Why is **30** (or **200**) flashing on the display?

A This occurs when the distance is less than 30 yards (or greater than 200 yards).

Q Everyone is saying that, on a particular hole, the distance measurement is totally incorrect. What is wrong?

A The calibration is probably incorrect. (Resetting is required.)



Maintenance

Perform the following maintenance procedures to keep the units functioning properly.



Maintenance of the Mother Unit

● Cleaning the Waterproofing Gasket

When calibrating the unit, make sure there is no dust or dirt on the waterproofing gasket. If the packing is dirty, wipe it clean with a soft cloth.

If the packing is left dirty, rain water may seep inside the mother unit.

● When Water Gets Inside the Unit

When water has gotten inside the unit, wipe it off with a dry cloth.

Investigate the cause (such as damaged gasket) of the water entering the mother unit.

In order to prevent condensation on the circuit, the waterproofing gasket is cut at the bottom of the case to allow air to enter from the outside. During a storm, a small amount of rainwater may enter through this opening. This rainwater should not inhibit the operation of the mother unit, but it is best to wipe it off with a dry cloth.

● Cleaning the Outside

Wipe off any foreign material with a damp cloth. Do not use paint thinner, alcohol, benzene, or wax.

Do not paint the mother unit.

● Troubleshooting

When the mother unit is not operating properly, have someone hold the spare mother unit and compare the operation of the two units. If it is determined that the mother unit is defective, use the "special tool" to remove the mounting screws on the bottom of the mother unit and replace it with the spare mother unit. Then, calibrate (see pages 5-7) and set the timer and ckoock of the mother unit (see page 8).

Waterproofing
gasket

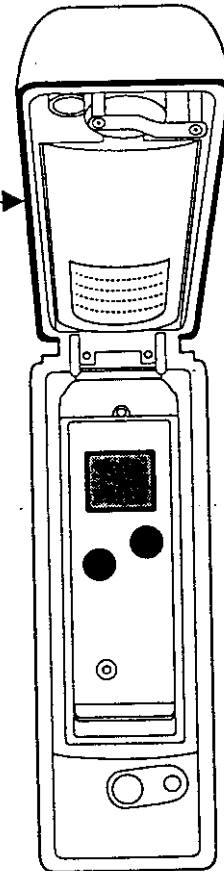



Maintenance of the Child Unit

● Cleaning the Outside

Clean the body using a towel dampened with fresh water. Clean out the corners with a brush.

If the child unit is especially dirty, apply a small amount of neutral detergent to the dampened towel mentioned above. After cleaning, wipe using a towel dampened with fresh water only.

- Never immerse in water to clean.
- Do not rub the label area with excessive force.
- Once a month, wipe the terminals clean using a dry cloth or a cotton swab. (Otherwise, battery charging will require excessive amounts of time or even be completely inhibited.)



Specifications

Specifications

- Display : LCD
- Display range : 30-200 yards
- Display accuracy : 1 yard
- Time usable before recharging : Child unit/2 days
Mother unit/7 days
- Battery charger : Input voltage/AC100V
Power consumption/
50VA MAX
- Function : Distance measurement
Hole setting
Position compensation
between mother unit and pin
(100 yards)
Waterproof structure

★Child unit (230g)

★Mother unit (1.7kg)

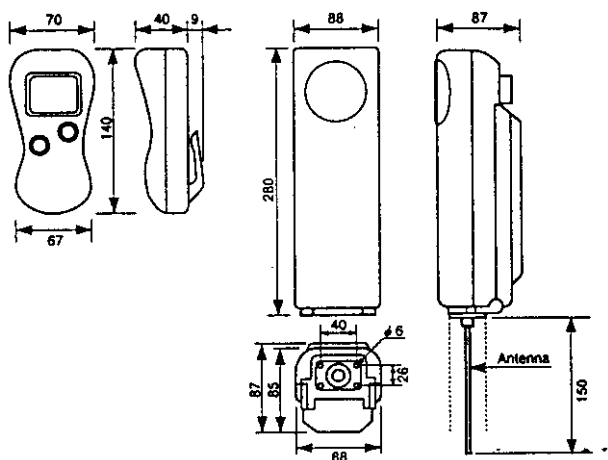

Configuration

- Example for 18-hole course
 - ① 200 child units (approximately 230g per unit)
 - ② 20 mother units (approximately 1.7kg per unit)
 - ③ 2 battery chargers
(Approximately 100kg per unit. Each battery charger has slots for 100 child units and 10 mother units.)
 - ④ Child unit batteries (200)
 - ⑤ Mother unit batteries (40)
 - ⑥ Mounting pole for mother unit (20)
 - ⑦ Slotted-head screwdriver, Phillips screw driver
 - ⑧ Long mounting pole for mother unit (optional)

★Battery charger (100kg)

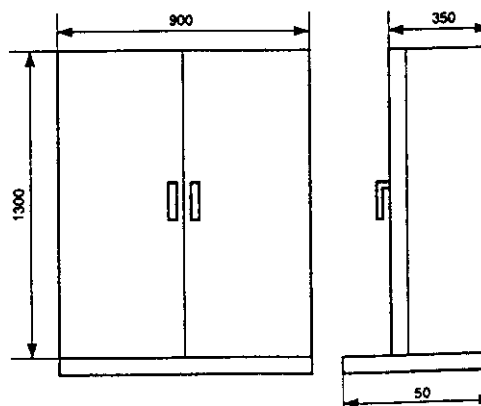

This device complies with Part 15 of FCC Rules. Operation is subject to the following two conditions: (1) This device may not cause harmful interference, and (2) This device must accept any interference received, including interference that may cause undesired operation.

FCC STATEMENT

Changes or modifications not expressly approved in writing by Furuno USA Inc. may void the user's authority to operate this equipment.