

# **FURUNO**

## **OPERATOR'S MANUAL**

*SSB RADIOTELEPHONE*

**FS-1575**

**FS-2575**

**MODEL FS-5075**

---

**ECF**

**(Elemental Chlorine Free)**

The paper used in this manual  
is elemental chlorine free.

**FURUNO ELECTRIC CO., LTD.**

9-52 Ashihara-cho,  
Nishinomiya, 662-8580, JAPAN

Telephone : +81-(0) 798-65-2111

Fax : +81-(0) 798-65-4200

• FURUNO Authorized Distributor/Dealer

All rights reserved.

Printed in Japan

Pub. No. OME-56770-Z4

(YOTA ) FS-2575/5075/1575

A : JUL. 2011

Z4 : NOV. 30, 2011

# IMPORTANT NOTICES

---

## General

- This manual has been authored with simplified grammar, to meet the needs of international users.
- The operator of this equipment must read and follow the descriptions in this manual. Wrong operation or maintenance can cancel the warranty or cause injury.
- Do not copy any part of this manual without written permission from FURUNO.
- If this manual is lost or worn, contact your dealer about replacement.
- The contents of this manual and equipment specifications can change without notice.
- The example screens (or illustrations) shown in this manual can be different from the screens you see on your display. The screens you see depend on your system configuration and equipment settings.
- Save this manual for future reference.
- Any modification of the equipment (including software) by persons not authorized by FURUNO will cancel the warranty.
- All brand and product names are trademarks, registered trademarks or service marks of their respective holders.

## How to discard this product

Discard this product according to local regulations for the disposal of industrial waste. For disposal in the USA, see the homepage of the Electronics Industries Alliance (<http://www.eiae.org/>) for the correct method of disposal.

## How to discard a used battery

Some FURUNO products have a battery(ies). To see if your product has a battery, see the chapter on Maintenance. Follow the instructions below if a battery is used. Tape the + and - terminals of battery before disposal to prevent fire, heat generation caused by short circuit.

### In the European Union

The crossed-out trash can symbol indicates that all types of batteries must not be discarded in standard trash, or at a trash site. Take the used batteries to a battery collection site according to your national legislation and the Batteries Directive 2006/66/EU.

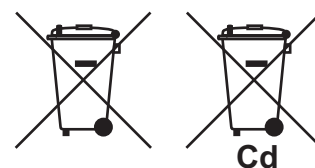

### In the USA

The Mobius loop symbol (three chasing arrows) indicates that Ni-Cd and lead-acid rechargeable batteries must be recycled. Take the used batteries to a battery collection site according to local laws.

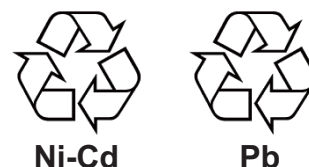

### In the other countries

There are no international standards for the battery recycle symbol. The number of symbols can increase when the other countries make their own recycle symbols in the future.



# SAFETY INSTRUCTIONS

The user and installer must read the appropriate safety instructions before attempting to install or operate the equipment.



## DANGER

Indicates a condition that will result in death or serious injury if not avoided.



## WARNING

Indicates a condition that can cause death or serious injury if not avoided.



## CAUTION

Indicates a condition that can cause minor or moderate injury if not avoided.



Warning, Caution



Prohibitive Action



Mandatory Action



## DANGER

**Never touch the SSB antenna, antenna coupler or lead-in insulator when the SSB radiotelephone is transmitting.**

High voltage which will cause death or serious injury is present at the locations shown in the illustration below when the SSB radiotelephone is transmitting.

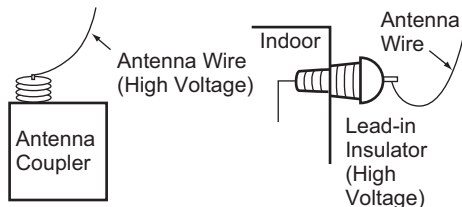

## WARNING



**Immediately turn off the power at the switchboard if the equipment is emitting smoke or fire.**

Continued use of the equipment can cause fire or electrical shock. Contact a FURUNO agent for service.



**Do not place liquid-filled containers on the top of the equipment.**

Fire or electrical shock can result if a liquid spills into the equipment.



**Do not operate the equipment with wet hands.**

Electrical shock can result.



**Turn off the power immediately if you feel the equipment is behaving abnormally.**

Turn off the power at the switchboard if the equipment becomes abnormally warm or is emitting odd noises. Contact a FURUNO dealer or agent for advice.



**Make sure no rain or water splash leaks into the equipment.**

Fire or electrical shock can result if water leaks in the equipment.



**Use the proper fuse.**

Use of the wrong fuse can cause fire or electrical shock.



## WARNING



**Do not open the equipment.**

Only qualified personnel should work inside the equipment.



**Immediately turn off the power at the switchboard if water leaks into the equipment or something is dropped into the equipment.**

Continued use of the equipment can cause fire or electrical shock. Contact a FURUNO agent for service.



**Do not disassemble or modify the equipment.**

Fire, electrical shock or serious injury can result.

**⚠ WARNING**

**⊘ Do not operate the [DISTRESS] key except in case of a life-endangering situation on your vessel.**

Operating the [DISTRESS] key transmits the distress alert. Accidental transmission may prevent search and rescue operations for actual emergency. If the distress alert is accidentally transmitted, contact the nearest station to cancel the alert.

**⚠ CAUTION**

**! If the distress alert is accidentally transmitted, contact the nearest coast station and inform them of the accidental transmission, providing the following data:**

- a) Ship's name
- b) Ship's call sign and DSC number
- c) Position at time of transmission
- d) Time of transmission

**⊘ Do not apply strong pressure to the LCD, which is made of glass.**

Injury can result if the LCD breaks.

### WARNING LABELS

Warning labels are attached to the equipment. Do not remove any label. If a label is missing or damaged, contact a FURUNO agent or dealer about replacement.

**⚠ WARNING ⚠**

To avoid electrical shock, do not remove cover. No user-serviceable parts inside.

**⚠ 警告 ⚠**

感電の恐れあり。  
サービスマン以外の方はカバーを開けないで下さい。内部には高電圧部分が多いので、万ざさわると危険です。

Name: Warning Label 1  
Type: 86-003-1011-3  
Code No.: 100-236-233-10

**⚠ DANGER**

Electrical shock hazard. Do not touch parts inside this cover.

**⚠ 危険**

感電の恐れあり。カバーの内部には、絶対に触れないで下さい。

Name: Warning Label  
Type: 14-055-4202-1  
Code No.: 100-245-221-10



Name: High Temp Warning Label  
Type: 05-089-2142-0  
Code No.: 100-301-620-10

### About the TFT LCD

The TFT LCD is constructed using the latest LCD techniques, and displays 99.99% of its pixels. The remaining 0.01% of the pixels may drop out or blink, however this is not an indication of malfunction.

# DISTRESS ALERT

## How to send distress alert

Below is the procedure for transmitting a distress alert via radiotelephone. Transmit the distress alert when a life-endangering situation occurs on your vessel.

1. Open the **DISTRESS** key cover then press the **DISTRESS** key for four seconds. The following screen appears.

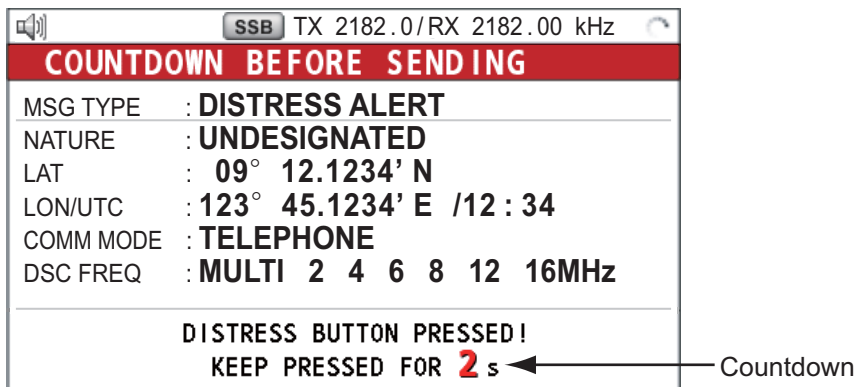

2. When the message "Sending DISTRESS ALERT." appears on the screen, release the **DISTRESS** key. The audio alarm sounds for two seconds. After the distress alert has been sent, the following screens appear in order.

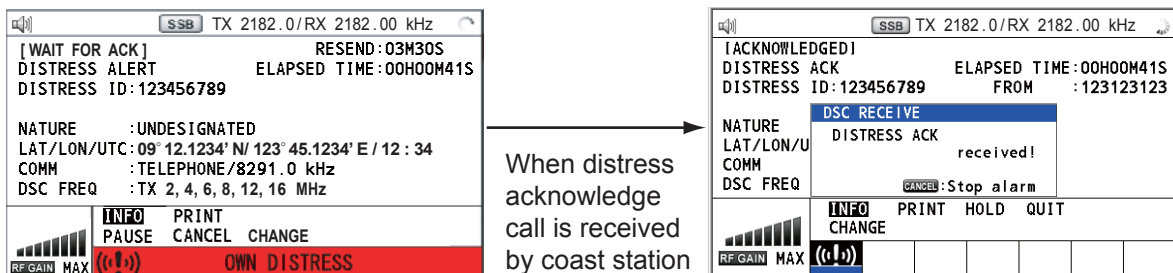

3. The audio alarm sounds. Press the **CANCEL** key to silence the audio alarm.
4. Communicate with the coast station via radiotelephone as below.
  - a) Say "MAYDAY" three times.
  - b) Say "This is ..." name of your ship and call sign three times.
  - c) Give nature of distress and assistance needed.
  - d) Give description of your ship (type, color, number of persons onboard, etc.).

**Note:** If you do not receive the distress alert acknowledge call, the equipment automatically re-transmits the distress alert after 3 min 30 seconds to 4 min 30 seconds. Then awaits the distress alert acknowledge call. This is repeated until the distress alert is acknowledged.

**How to cancel distress alert**

You can cancel the distress alert while it is being sent or while waiting for its acknowledgement as follows.

1. Rotate the **ENTER** knob to select [CANCEL] in the user options area then push the knob.

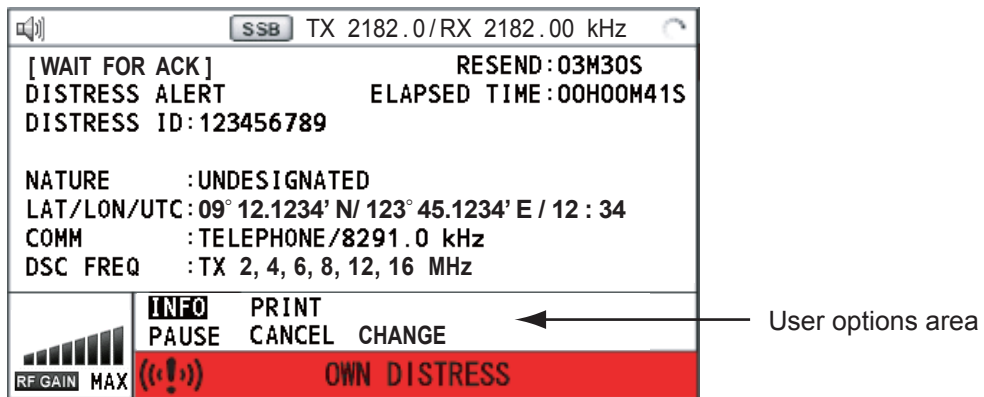

The following message appears on the screen.

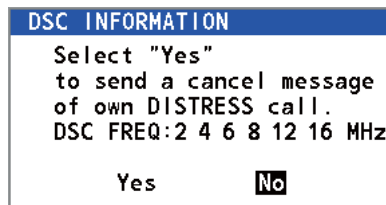

2. Rotate the **ENTER** knob to select [Yes] then push the knob to cancel the distress alert. After transmitting the distress cancel call, the following message appears on the screen.

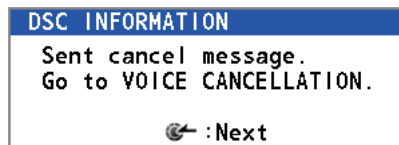

3. Push the **ENTER** knob to erase the message. The screen for the selection of frequency appears.

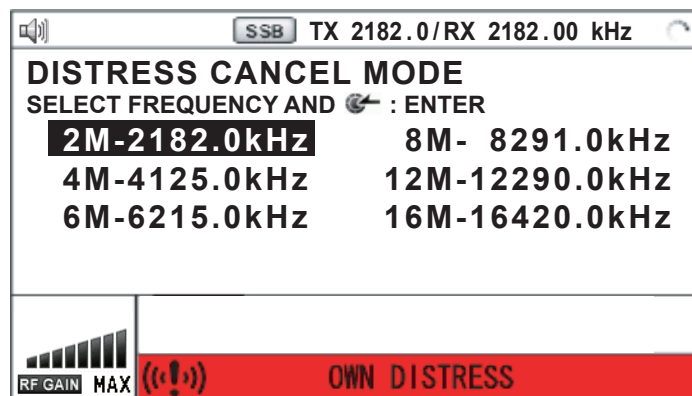

DISTRESS ALERT

4. Rotate the **ENTER** knob to select a frequency then push the knob. The following message appears on the screen.

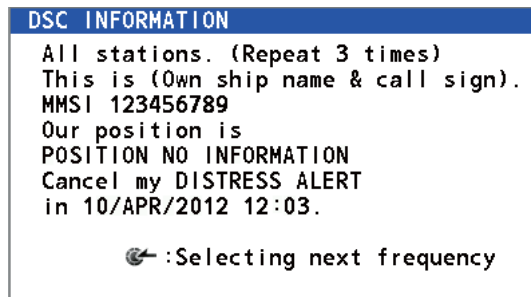

5. Communicate with all ships via radiotelephone referring to the message at step 4.
6. Push the **ENTER** knob. The screen for the selection of frequency appears again. The frequency marked by asterisk shows that the call cancellation by voice was completed for that frequency.

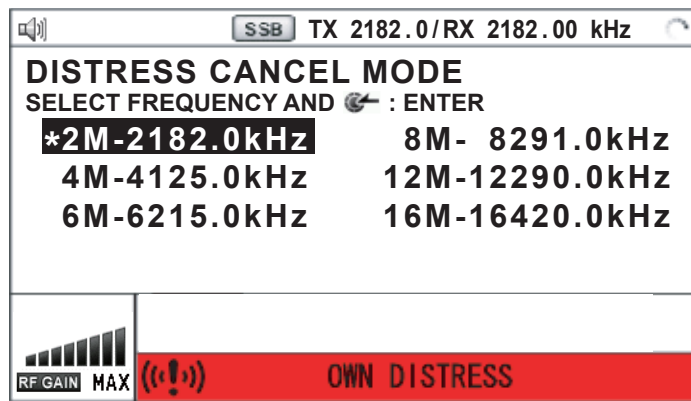

7. Repeat steps 4 through 6 to cancel for ALL frequencies. When cancellation on all frequencies is completed, the options [Finish] and [Resend] appear.

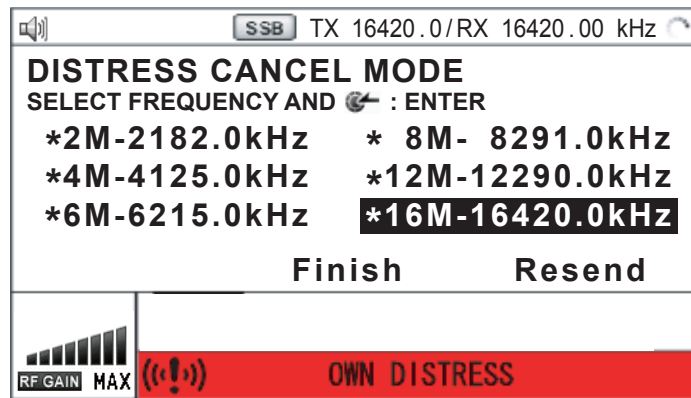

8. Rotate the **ENTER** knob to select [Finish] then push the knob.



# TABLE OF CONTENTS

---

<b>FOREWORD</b> .....	<b>xi</b>
<b>SYSTEM CONFIGURATIONS</b> .....	<b>xiii</b>
<b>1. OPERATIONAL OVERVIEW</b> .....	<b>1-1</b>
1.1 Controls .....	1-1
1.2 How to Turn On/Off the Power .....	1-2
1.3 Radiotelephone (RT) Screen.....	1-2
1.4 DSC Scan Screen .....	1-3
1.5 How to Adjust the Brilliance of the Display and Panel.....	1-4
1.6 How to Turn On/Off the Main Speaker .....	1-4
1.7 How to Scan .....	1-4
1.8 How to Set the Auto Acknowledgement .....	1-5
1.9 Control Unit Priority .....	1-5
1.10 Intercom.....	1-6
1.11 Operation of Session .....	1-7
<b>2. SSB RADIOTELEPHONE</b> .....	<b>2-1</b>
2.1 How to Select the Class of Emission.....	2-1
2.2 How to Select the Channel, Frequency .....	2-1
2.3 Transmission .....	2-3
2.3.1 Transmission procedure.....	2-3
2.3.2 How to change transmission power .....	2-3
2.3.3 Condition of the transmitter .....	2-4
2.4 Reception .....	2-5
2.4.1 RF gain (sensitivity) adjustment .....	2-5
2.4.2 S-meter.....	2-5
2.4.3 Receive AM broadcasting stations .....	2-5
2.4.4 Noise blanker .....	2-5
2.4.5 Noise reduction .....	2-5
2.4.6 Notch filter .....	2-6
2.4.7 Squelch .....	2-6
2.4.8 Attenuator.....	2-6
2.5 User Channels.....	2-6
<b>3. DSC OVERVIEW</b> .....	<b>3-1</b>
3.1 What is DSC? .....	3-1
3.2 DSC Message .....	3-1
3.3 Audio Alarms .....	3-2
3.4 Description of Call Screens .....	3-3
3.4.1 RX calls .....	3-3
3.4.2 TX calls.....	3-4
<b>4. DSC DISTRESS OPERATIONS</b> .....	<b>4-1</b>
4.1 How to Send Distress Alert.....	4-1
4.1.1 How to send distress alert by DISTRESS key with distress information not edited.....	4-1
4.1.2 How to send distress alert by DISTRESS key with distress information edited.....	4-3
4.2 How to Receive a Distress Alert.....	4-6
4.2.1 Distress alert received on MF band.....	4-6
4.2.2 Distress alert received on HF band .....	4-8
4.3 How to Send Distress Relay on Behalf of a Ship in Distress.....	4-11

## TABLE OF CONTENTS

4.3.1	How to send distress relay to coast station.....	4-11
4.3.2	How to send distress relay to ships in your area.....	4-12
4.4	How to Receive Distress Relay from Coast Station.....	4-14
4.5	How to Cancel Distress Alert .....	4-15
<b>5.</b>	<b>DSC GENERAL MESSAGE CALLING, RECEIVING.....</b>	<b>5-1</b>
5.1	Individual Call.....	5-1
5.1.1	How to send an individual call.....	5-1
5.1.2	How to receive an individual call.....	5-6
5.2	Group Call.....	5-10
5.2.1	How to send a group call.....	5-10
5.2.2	How to receive a group call.....	5-11
5.3	Geographical Area Call.....	5-12
5.3.1	How to send a geographical area call.....	5-12
5.3.2	How to receive a geographical area call.....	5-14
5.4	Neutral Craft Call.....	5-14
5.4.1	How to send a neutral craft call.....	5-14
5.4.2	How to receive a neutral craft call.....	5-16
5.5	Medical Transport Call.....	5-17
5.5.1	How to send a medical transport call.....	5-17
5.5.2	How to receive a medical transport call.....	5-18
5.6	How to Receive a Polling Request.....	5-19
5.6.1	Automatic reply.....	5-19
5.6.2	Manual reply.....	5-19
5.7	Position Call.....	5-20
5.7.1	How to request other ship's position.....	5-20
5.7.2	Other ship requests your position.....	5-22
5.8	PSTN Call.....	5-23
5.8.1	How to send a PSTN call.....	5-23
5.8.2	How to receive a PSTN call.....	5-25
<b>6.</b>	<b>MENU OPERATION.....</b>	<b>6-1</b>
6.1	How to Open/Close the MENU Screen.....	6-1
6.2	User Channels.....	6-2
6.2.1	List for user channels.....	6-2
6.2.2	How to register user channels.....	6-2
6.2.3	How to edit user channels.....	6-3
6.2.4	How to delete user channels.....	6-4
6.2.5	How to sort the USER CH list by band.....	6-4
6.2.6	How to select user channels for SSB mode.....	6-5
6.3	Log File.....	6-5
6.3.1	How to open a log file.....	6-5
6.3.2	How to delete log files.....	6-6
6.4	Squelch Frequency.....	6-7
6.5	Key Assignment.....	6-7
6.6	How to Print Messages.....	6-8
6.7	Position Setting.....	6-8
6.8	Date and Time Setting.....	6-9
6.9	Timeout Setting.....	6-10
6.10	FAX Enable/Disable.....	6-10
6.11	How to Select the Antenna.....	6-11
6.12	Clarifier Setting.....	6-11
6.13	External Alarm Setting.....	6-12
6.14	NETWORK Setting.....	6-12
6.15	Address Book.....	6-13
6.15.1	List for address data.....	6-13

6.15.2	How to register addresses.....	6-13
6.15.3	How to edit addresses.....	6-14
6.15.4	How to delete addresses.....	6-15
6.15.5	How to create a DSC message with registered address.....	6-15
6.16	TX Message Preparation.....	6-16
6.16.1	List for message files.....	6-16
6.16.2	Individual calls.....	6-17
6.16.3	Group calls.....	6-18
6.16.4	PSTN calls.....	6-18
6.16.5	Test call.....	6-19
6.16.6	How to edit prepared messages.....	6-19
6.16.7	How to send prepared messages.....	6-20
6.16.8	How to delete prepared messages.....	6-20
6.17	How to Set the AUTO ACK Details.....	6-21
6.18	Special Messages.....	6-22
6.19	How to Set Scan Frequencies.....	6-22
6.20	Sound Setting.....	6-23
6.21	Alarm Lists.....	6-24
<b>7.</b>	<b>NBDP SYSTEM OVERVIEW.....</b>	<b>7-1</b>
7.1	How to Turn on the NBDP System.....	7-1
7.2	Description of Equipment.....	7-1
7.2.1	Terminal unit.....	7-1
7.2.2	Keyboard.....	7-2
7.3	Function Keys, Menu Operation.....	7-3
7.3.1	Menu conventions.....	7-3
7.3.2	Menu overview.....	7-4
7.3.3	Function key description.....	7-4
<b>8.</b>	<b>NBDP PREPARATIONS.....</b>	<b>8-1</b>
8.1	Registration of Answerback & ID Codes.....	8-1
8.1.1	How to register answerback code.....	8-1
8.1.2	How to register ID codes.....	8-2
8.2	User Channels.....	8-2
8.2.1	How to register user channels.....	8-2
8.2.2	How to edit/delete user channels.....	8-3
8.3	Station List.....	8-3
8.3.1	How to register stations.....	8-3
8.3.2	How to edit/delete stations.....	8-5
8.4	Timer Programming.....	8-5
8.4.1	How to register timer programs.....	8-5
8.4.2	How to edit/delete timer programs.....	8-6
8.5	Scan Channel Groups.....	8-6
8.5.1	How to register scan channel groups.....	8-7
8.5.2	How to edit/delete scan channel groups.....	8-8
8.6	How to Change the Window Color.....	8-9
8.7	Screen Saver Function for IB-585.....	8-10
<b>9.</b>	<b>NBDP FILE OPERATIONS.....</b>	<b>9-1</b>
9.1	How to Open and Close Files.....	9-1
9.2	How to Create Files.....	9-1
9.3	How to Save a File.....	9-2
9.3.1	How to format floppy disks or SD cards.....	9-2
9.3.2	How to save a file.....	9-3
9.4	How to Edit Files.....	9-3
9.4.1	How to cut and paste text.....	9-3

## TABLE OF CONTENTS

9.4.2	How to copy and paste text.....	9-4
9.4.3	Select all.....	9-4
9.4.4	How to search text .....	9-5
9.4.5	How to replace text .....	9-5
9.4.6	Goto line.....	9-6
9.4.7	Goto top, Goto bottom.....	9-6
9.5	How to Open Files.....	9-6
9.5.1	Open a file.....	9-6
9.5.2	Switch between files.....	9-7
9.6	How to Rename Files.....	9-7
9.7	How to Save a File Under a New Name .....	9-7
9.8	How to Delete Files .....	9-8
9.9	Real Time Printing.....	9-8
9.10	How to Print Files .....	9-8
<b>10.</b>	<b>NBDP TRANSMISSION, RECEPTION.....</b>	<b>10-1</b>
10.1	Manual Calling .....	10-1
10.2	ARQ Mode Operation.....	10-3
10.3	FEC Mode Operation .....	10-5
10.4	How to Select Reception Mode.....	10-5
10.5	Communication Example .....	10-6
10.6	Timer Operation .....	10-8
10.6.1	How to enable timer operation .....	10-8
10.6.2	How to stop timer operation .....	10-8
10.7	Scanning .....	10-9
10.8	Communication Buffer.....	10-9
10.9	Preparation of Macrofiles for Automatic Telex .....	10-10
10.9.1	Automatic telex overview .....	10-10
10.9.2	Preparations.....	10-10
10.9.3	Commands.....	10-11
10.9.4	Store-and-forward method .....	10-13
10.10	Automatic Telex Using Macrofile.....	10-15
<b>11.</b>	<b>MAINTENANCE &amp; TROUBLESHOOTING.....</b>	<b>11-1</b>
11.1	Test .....	11-1
11.2	Maintenance.....	11-3
11.3	Simple Troubleshooting .....	11-4
11.4	Error Messages.....	11-4
11.5	Breaker on PR-850A.....	11-5
11.6	Test Call.....	11-5
11.7	NBDP Terminal Unit Maintenance .....	11-6
11.7.1	Cleaning the equipment .....	11-6
11.7.2	Connectors and earth connection .....	11-6
11.7.3	Floppy disk drive .....	11-6
11.7.4	Diagnostics.....	11-6
	<b>APPENDIX 1 MENU TREE .....</b>	<b>AP-1</b>
	<b>APPENDIX 2 FREQUENCY TABLES.....</b>	<b>AP-3</b>
	<b>APPENDIX 3 LIST OF ABBREVIATIONS.....</b>	<b>AP-16</b>
	<b>APPENDIX 4 DIGITAL INTERFACE (IEC 61162-1).....</b>	<b>AP-19</b>
	<b>APPENDIX 5 PARTS LIST.....</b>	<b>AP-23</b>
	<b>APPENDIX 6 PARTS LOCATION.....</b>	<b>AP-26</b>
	<b>SPECIFICATIONS .....</b>	<b>SP-1</b>
	<b>INDEX.....</b>	<b>IN-1</b>

# FOREWORD

---

## **A Word to the Owner of the FS-1575/2575/5075**

Congratulations on your choice of the FURUNO FS-1575/2575/5075 SSB Radiotelephone. We are confident you will see why the FURUNO name has become synonymous with quality and reliability.

Since 1948, FURUNO Electric Company has enjoyed an enviable reputation for innovative and dependable marine electronics equipment. This dedication to excellence is furthered by our extensive global network of agents and dealers.

Your equipment is designed and constructed to meet the rigorous demands of the marine environment. However, no machine can perform its intended function unless properly installed and maintained. Please carefully read and follow the operation and maintenance procedures set forth in this manual.

We would appreciate feedback from you, the end-user, about whether we are achieving our purposes.

Thank you for considering and purchasing FURUNO equipment.

## **Features**

The FS-1575/2575/5075 is an MF/HF SSB Radiotelephone with a built-in DSC/Watch Receiver, all contained in a surprisingly compact cabinet. An NBDP (Narrow Band Direct Printing) Terminal Unit is optionally available.

Data is displayed on a large, easy-to-read color LCD. Operation is simplified by the use of few keys and easy-to-follow menus.

The built-in DSC/Watch Receiver produces and receives digital selective callings for quick and efficient establishment of distress, urgency, safety and routine communications with other ships and coast stations that install any MF/HF DSC facilities.

The main features are

### **General**

- Fully meets the following regulations: IMO A.806(19), IMO A.694(17), MSC 36(63), MSC 68(68), IEC 61162-1 Ed.4, IEC 60945 Ed.4, ETS 300 067 Ed.1, EN 300 338, EN 300 373-1, EN 301 033, ITU-R M.476-5, ITU-R M.490, ITU-R M.491-1, ITU-R M.492-6, ITU-R M.493-13, ITU-R M.541-9, ITU-R M.625-3, ITU-R M.821-1, ITU-R M.1082-1, ITU-R M.1173, MSC/Circ. 862.
- Automatic entry of position with manual override
- Optional printer can automatically print out DSC and NBDP received messages and test results.

### **DSC/Watch Receiver**

- Distress, urgency, safety and routine calling
- Scanning of DSC frequencies for distress and general calls on MF/HF
- File editing capability for readiness in case of emergency
- PSTN (Public Switched Telephone Network) capability standard

## FOREWORD

- Log stores 50 each of latest general, distress and transmitted messages, in separate memory blocks.

### **SSB**

- Receiving voice communication
- Noise blanker function, Noise reduction function, Notch filter function, Squelch function are available.
- Simplified setting of channel and frequency

### **NBDP (with optional NBDP Terminal Unit IB-583/IB-585)**

- Automatic error-free telex communications and distress message in compliance with GMDSS requirements
- LCD monitor and keyboard comply with ITU regulations
- Pop-up menus for user-friendly operation
- Memory for 256 operator-customized channels
- Real time message printing with Printer PP-510

## **Program Number**

### **FS-1575/2575/5075**

Location	PC board	Program No.	Version
FS-1575T/2575T/5075T	T-CPU (05P0859)	0550243 (APP)	01.xx
		0550247 (Boot)	01.xx
	MOT (05P0860)	0550245 (CPLD)	01.xx
FS-2575C	C-CPU (05P0852)	0550246 (Boot)	01.xx
ANTENNA COUPLER AT-5075	COUP (05P0875)	0550244	01.xx
ANTENNA COUPLER AT-1575	COUP (05P0883)	0550244	01.xx

xx: minor change

### **Terminal Unit IB-583 (optional unit)**

PC board	Program No.	Version
TERMINAL	0550209	1.22

### **Terminal Unit IB-585 (optional unit)**

PC board	Program No.	Version
TERMINAL	0550251	01.xx

# SYSTEM CONFIGURATIONS

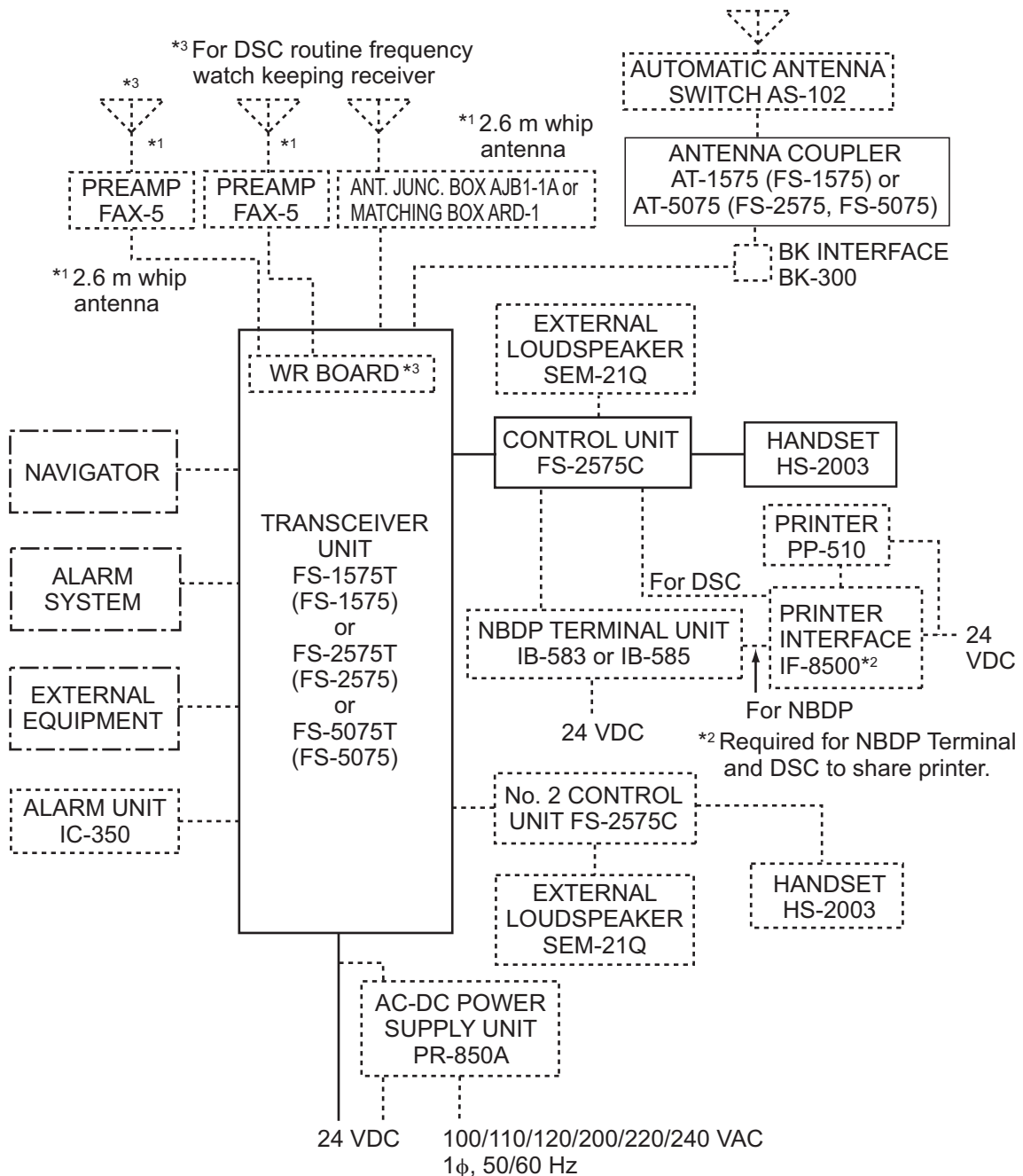

Unit	Category
Preamp Unit	Exposed to the weather
Antenna Coupler	Exposed to the weather OR protected from the weather
Other Units	Protected from the weather

— : STANDARD  
 ..... : OPTION  
 - - - : LOCAL SUPPLY

This page is intentionally left blank.



# 1. OPERATIONAL OVERVIEW

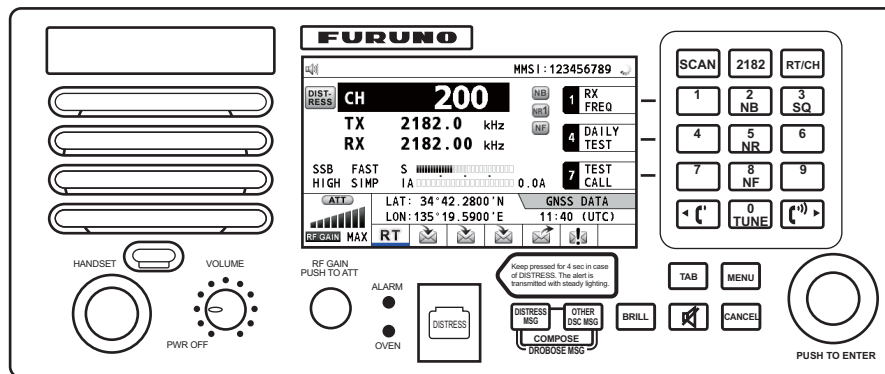

## 1.1 Controls



*Description of controls*

Control	Function
VOLUME/PWR knob	<ul style="list-style-type: none"> <li>Turns the power on or off.</li> <li>Adjusts the volume.</li> </ul>
ENTER knob	Rotate to select menu items or change the page in multi-page screens (e.g., log data); push to confirm a selection.
RF GAIN/ PUSH TO ATT knob	Rotate to adjust the gain; push to turn the attenuator on or off.
DISTRESS key	Press and hold down the key four seconds to transmit the distress alert.
MENU key	Opens/closes the menu.
CANCEL key	<ul style="list-style-type: none"> <li> Cancels the creation of the DSC message currently being created.</li> <li> Silences the audio alarm.</li> <li> Erases error message or pop-up message.</li> <li> Returns one layer in multi-layer menu.</li> <li> Erases character input.</li> </ul>
TAB key	<ul style="list-style-type: none"> <li> Switches control to the tab area.</li> <li> Switches the session.</li> </ul>
🔊 key	Turns the main speaker on or off.
BRILL key	Adjusts the brilliance.
OTHER DSC MSG key	Composes DSC TX message except DISTRESS ALERT and DROBOSE (Distress Relay On Behalf Of Someone Else).
DISTRESS MSG key	Composes DSC TX message for DISTRESS ALERT.
DROBOSE MSG key	Composes DSC TX message for DROBOSE (Distress Relay On Behalf Of Someone Else). Press the DISTRESS MSG key and the OTHER DSC MSG key simultaneously.
SCAN key	<ul style="list-style-type: none"> <li> Opens the scan screen.</li> <li> Stops/starts the scanning of DSC routine frequencies, on the scan screen.</li> </ul>
2182 key	Switches to the RT (radiotelephone) screen and sets freq. to 2182.0 kHz.
RT/CH key	<ul style="list-style-type: none"> <li> Switches to the RT (radiotelephone) screen.</li> <li> Opens the CH setting window on the RT screen.</li> </ul>
0 to 9 keys	Enter alphabet, numeric or symbol.
1, 4 and 7 keys	Execute the operation assigned to the function key in the RT mode.

## 1. OPERATIONAL OVERVIEW

Control	Function
2/NB key	Turns the noise blanker on or off in the RT mode.
3/SQ key	Turns the squelch on or off in the RT mode.
5/NR key	Reduces the noise in the RT mode (NR2 (High), NR1 (Low), Off).
8/NF key	Turns the notch filter on or off in the RT mode.
0/TUNE key	Tunes the antenna in radiotelephone operation.
 key	<ul style="list-style-type: none"> <li>• Turns down the handset volume.</li> <li>• Moves the cursor when setting channel or RX frequency.</li> </ul>
 key	<ul style="list-style-type: none"> <li>• Turns up the handset volume.</li> <li>• Moves the cursor when setting channel or RX frequency.</li> </ul>
ALARM lamp	<ul style="list-style-type: none"> <li>• Flashes in red for distress and urgency messages.</li> <li>• Flashes in green for safety and routine messages, and when daily test is completed.</li> </ul>
OVEN lamp	Lights in green when the main switchboard is on.

### 1.2 How to Turn On/Off the Power

Rotate the **VOLUME/PWR** knob clockwise to turn on the power. The RT screen appears.

To turn off the power, rotate the **VOLUME/PWR** knob counterclockwise to the OFF position.

In the dual control unit system, the No.1 control unit has priority and it controls the power for both itself and the No. 2 control unit. The power switch of the No. 2 control unit powers on/off the No. 2 control unit only.

**Note:** Turn on the power at the switchboard more than five minutes before turning on this equipment.

### 1.3 Radiotelephone (RT) Screen

Turn the power on, or press the **RT/CH** key to show the RT (radiotelephone) screen. This is where you set up the transceiver unit, and communicate by voice or telex.

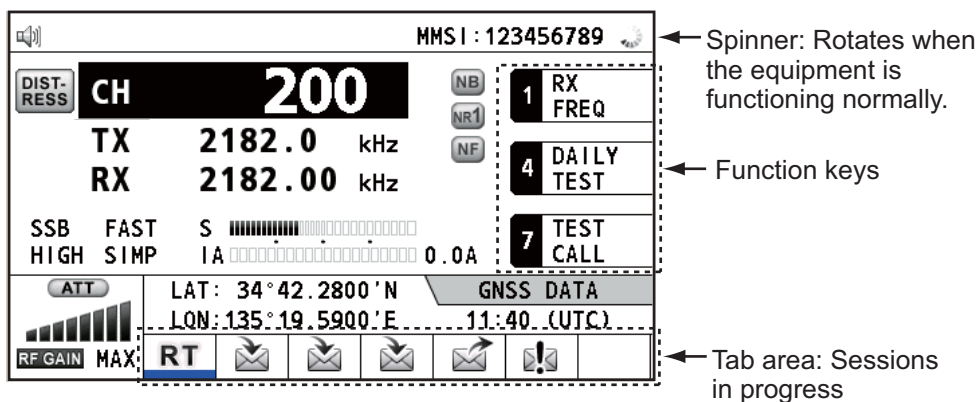

*Radiotelephone (RT) screen*

Indication	Meaning
	Main speaker on or off
CH	Channel
TX	TX frequency (  : while transmitting)
RX	RX frequency
SSB/TLX/AM/FAX	Class of emission
OFF/SLOW/FAST (AGC)	Auto gain control ([OFF]: no adjustment, [SLOW]: low-speed, [FAST]: high-speed)
HIGH/MID/LOW(1)/LOW2	Output power ([LOW2]: FS-5075 only, minimum output power)
SIMP/S-DUP/DUP	Communication mode ([SIMP]: simplex, [S-DUP]: semi-duplex, [DUP]: full-duplex (only for FS-5075, option))
IA/IC/VC/RF/VS	Transceiver unit status ([IA]: antenna current, [IC]: collector current, [VC]: collector voltage, [RF]: RF output, [VS]: source voltage)
S	S-meter, displays the strength of received signal.
NB	Noise blanker (  :On, No indication: Off)
NR2/NR1/OFF	Noise reduction (  : High,  : Low, No indication: Off)
NF	Notch filter (  : On, No indication: Off)
SQ	Squelch (  : On, No indication: Off)
MMSI	Own ship's ID (nine digits)
LAT, LON	Own ship's position (LAT: Latitude, LON: Longitude)
GNSS	UTC (universal time coordinated)
ATT	Attenuator (  : On, No indication: Off)
RF GAIN	Adjusted value of gain

## 1.4 DSC Scan Screen

Press the **SCAN** key to show the DSC scan screen. This screen scans and receives the distress and routine frequencies.

The screenshot displays the DSC Scan Screen with the following information:

- MMSI:** 123456789
- WATCH KEEPING**
  - DISTRESS**

▶ 2187.5	4207.5	6312.0
8414.5	12577.0	16804.5
  - ROUTINE**

▶ 2177.0	4219.5	6331.0
8415.0	12657.0	16904.5
- GNSS DATA**
  - LAT: 34°42.2800' N
  - LON: 135°19.5900' E
  - 11:41 (UTC)
- RF GAIN:** 20
- RT** (Ready to Transmit)
- Icons for various status indicators: envelope, envelope, envelope, envelope, and exclamation mark.

Annotations:



- RX:** Transceiver unit (WR2 shown when optional antenna for routine frequencies is installed.)
- Maximum six distress and routine frequencies scanned.

## 1.5 How to Adjust the Brilliance of the Display and Panel

You can adjust the brilliance of the display and the panel as follows:

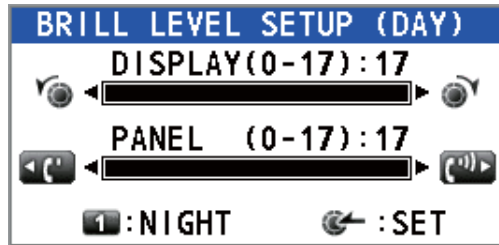
1. Press the **BRILL** key to show the [BRILL LEVEL SETUP] window.



2. Press the **1** key to switch the [DAY/NIGHT] mode.
3. To adjust the [DISPLAY] brilliance, rotate the **ENTER** knob or press the **BRILL** key.  
(Default setting: 17 for [DAY], 7 for [NIGHT])
4. To adjust the [PANEL] brilliance, press the  or  key.  
(Default setting: 17 for [DAY], 12 for [NIGHT])
5. Push the **ENTER** knob to save the settings and close the window. To cancel the settings, press the **CANCEL** key instead of the **ENTER** knob to close the window.

**Note 1:** The equipment keeps values for [DAY] and [NIGHT] separately.

**Note 2:** The window closes automatically when there is no operation for four seconds.

**Note 3:** When you turn on the power with the display brilliance set to 0, the setting automatically changes to 1.

## 1.6 How to Turn On/Off the Main Speaker

You can turn the main speaker (other than DSC communication, error, and key beep) on/off.

1. Press the  key to alternately disable or enable the main speaker.



Speaker ON



Speaker OFF

2. To adjust the volume of the main speaker, rotate the **VOLUME/PWR** knob (cw: volume up, ccw: volume down).

## 1.7 How to Scan

The DSC screen scans multiple routine frequencies according to operator-set interval. For how to set frequency to scan, see section 6.19.

Note that voice and telex communication are not available when scanning.

1. Press the **SCAN** key to show the DSC scan screen. Scanning starts. When receiving the appropriate frequency signal, the scanning stops, and the frequency is highlighted and flashes.
2. Press the **SCAN** key again to stop scanning the routine frequencies.  
**Note:** You can not stop the scanning manually for the distress alert.
3. Rotate the **ENTER** knob to move the cursor to the desired routine frequency which you want to watch. You can scan only the frequency selected by cursor.
4. Press the **SCAN** key to restart the scanning.

**Note:** When scanning starts, the active session (refer to section 1.11) is automatically put on hold.

## 1.8 How to Set the Auto Acknowledgement

Individual, PSTN (public switched telephone network), position, polling and test calls can be acknowledged automatically or manually. This is set on the [ACK SETTINGS] in the [DSC] menu (see section 6.17).

**Note:** When own ship's communication is high priority, set to manual acknowledgement.

The auto acknowledgement is not sent in the following cases:

- Other session is active (except individual call).
- There are RT or DSC sessions (for individual call).
- Channel is in use.
- ECC is NG (No Good).

**Note:** The auto acknowledgement for the individual call is sent only when the proposed channel or communication mode is not available.

## 1.9 Control Unit Priority

If you operate the No.1 control unit while the No.2 control unit is being operated, the right to operate is shifted to the No.1 control unit. The control unit not having priority shows the following:

- The unit name currently in use: No.1 control unit, No.2 control unit or NBDP
- The ongoing operation: Composing messages, Transmitting, Communicating

The control unit which you operate has priority in the following conditions:



- The handset goes OFF HOOK.
- Display the menus or setting windows.
- Display each function screen (for example, Log).
- Press a key or rotate a knob. (The priority is lost after four seconds.)
- NBDP is communicating.

## 1.10 Intercom

The built-in intercom permits voice communications between two control units.

### Calling

You can call over the intercom in on or off hook condition.

1. Press the **MENU** key.
2. Rotate the **ENTER** knob to select [INTERCOM] then push the knob. The pop-up for calling appears and the called party's control unit rings. To cancel calling, press the **CANCEL** key.
3. When the called party picks up their handset, the pop-up for calling disappears and the INTERCOM CONNECTED screen appears. Start communications.  
**Note:** You do not have to press the **PTT** switch to communicate.
4. If needed, adjust the handset volume with  or  key.
5. Hang up the handset or press the **CANCEL** key to turn the intercom off. The last-used screen or the RT screen appears.

### Answering

1. The control unit rings, and both the pop-up for calling and a message, which suggests you to pick up the handset, appear. To cancel reply, press the **CANCEL** key.
2. Pick up the handset, and the alarm stops. The pop-up for calling disappears and the INTERCOM CONNECTED screen appears. Start communications.
3. Hang up the handset or press the **CANCEL** key to turn the intercom off. The last-used screen or the RT screen appears.

# 1.11 Operation of Session

## Description of session

There are two types of sessions: RT session and DSC session. When a session starts, the appropriate icon for the session appears in the tab area.

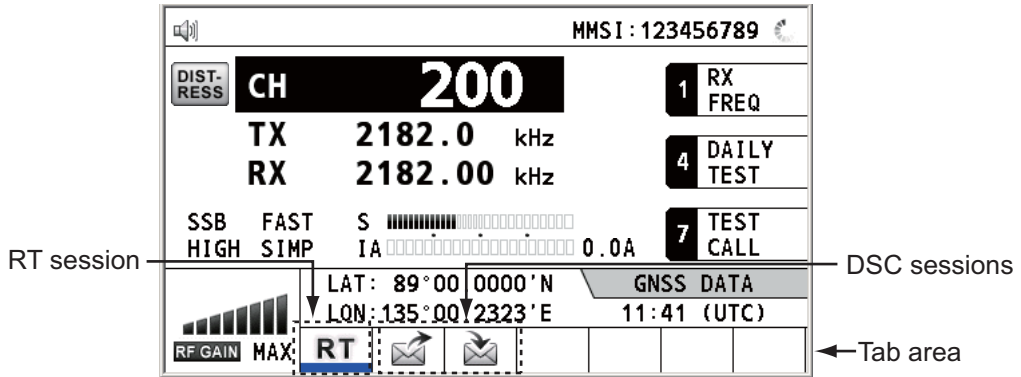

## How to finish a single session

### RT session

1. Press the **TAB** key to select the RT icon in the tab area.
2. Rotate the **ENTER** knob to select [QUIT] then push the knob.

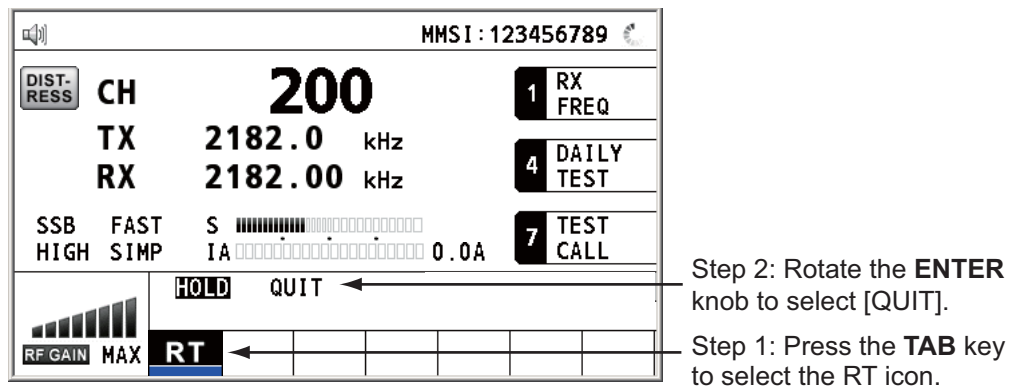

### DSC session

The cursor is in the tab area when the DSC session starts. Rotate the **ENTER** knob to select [QUIT] then push the knob.

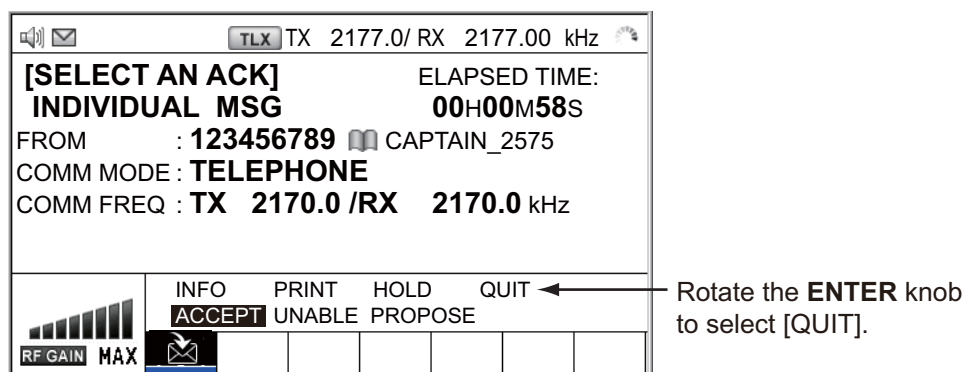

**How to start a new session**

**When another session is active:**

- When sending the distress alert, all sessions except the distress alert TX session automatically close then the distress alert TX session starts.
- When doing an RT session or sending a non-distress DSC message, the currently active session is put on hold then the RT session or non-distress DSC message TX session starts.
- When receiving a DSC message, its session is put on hold.

**When no other session is active:**

- When sending the distress alert, all sessions except the distress alert TX session automatically close then the distress alert TX session starts.
- When sending a non-distress DSC message, its session becomes the active session.

**How to switch sessions**

When one session is active and another message arrives, a new session for the received message does not start automatically. Only one session can be active. For example, when you are transmitting a DSC message and another message arrives, the option [ACTIVE] appears to indicate the start of a new session.

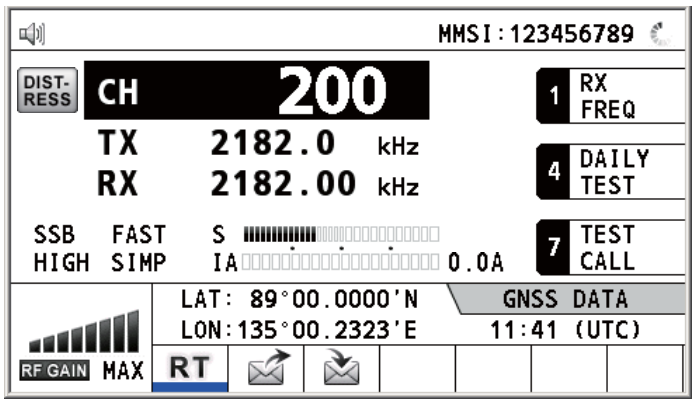

Press the **TAB** key to move the cursor to the tab area.

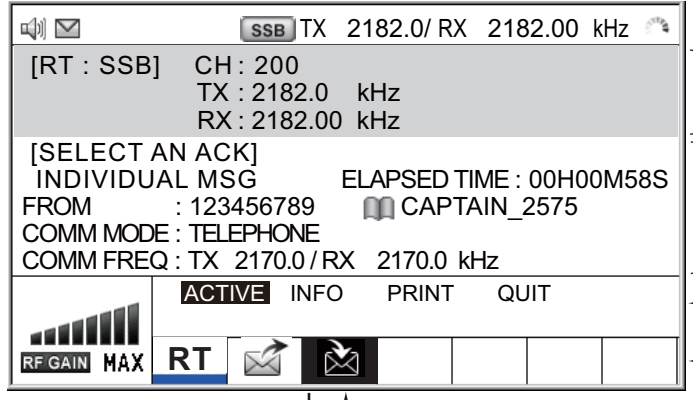

Information for the session underlined in blue (RT in this case)

Information for the session selected by cursor.

← User options area

← Tab area

To select a session, press the **TAB** key. The cursor is here.

With [ACTIVE] selected, push the **ENTER** knob to switch the active session. To switch the option for the session (ACTIVE, INFO, PRINT, QUIT), rotate the **ENTER** knob.

(Continued on next page)



(Continued from previous page) ↓



Only the screen for the selected session appears.

To finish this session, rotate the **ENTER** knob to select [QUIT] then push the knob.

**Note:** When waiting for the ACK, that is, the session is in progress, the confirmation message appears. Rotate the **ENTER** knob to select [YES] or [NO] then push the knob.

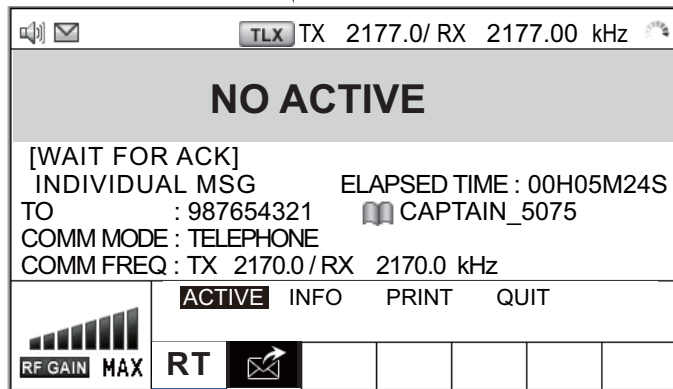

The  icon disappears.

**How to close a session**

To manually close a session, select it with the **TAB** key. Rotate the **ENTER** knob to select [QUIT] in the user options area then push the knob. The session icon disappears from the tab area.

When there is no operation for specific time (see section 6.9), the inactive session is automatically closed.

**Processing when the number of session is maximum**

A maximum of seven sessions can be displayed in the tab area. If a seventh session starts, the following message appears on the screen. Press the **CANCEL** key to close the message. Close a session to make space for the new session.

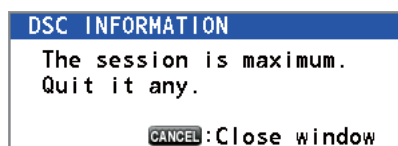

If the eighth session is for sending a distress alert, all sessions except that session automatically close, and the session starts.

## 1. OPERATIONAL OVERVIEW

If the eighth session is for receiving DSC message, the lowest-priority session automatically closes and the message appears.

## 2. SSB RADIOTELEPHONE

You can do SSB communications from any screen which displays the communication frequency.

### 2.1 How to Select the Class of Emission

You can select the class of emission from among the following:

- [SSB]: Single Sideband
- [TLX]: Telex
- [AM]: AM (RX only)
- [FAX]: FAX (RX only. Connect a FAX to this equipment to print FAX messages.)

At the RT screen, select the class of emission as follows:

1. Rotate the **ENTER** knob to highlight the class of emission (default: [SSB]) then push the knob. When you rotate the **ENTER** knob clockwise, the cursor moves from [CH] downward.

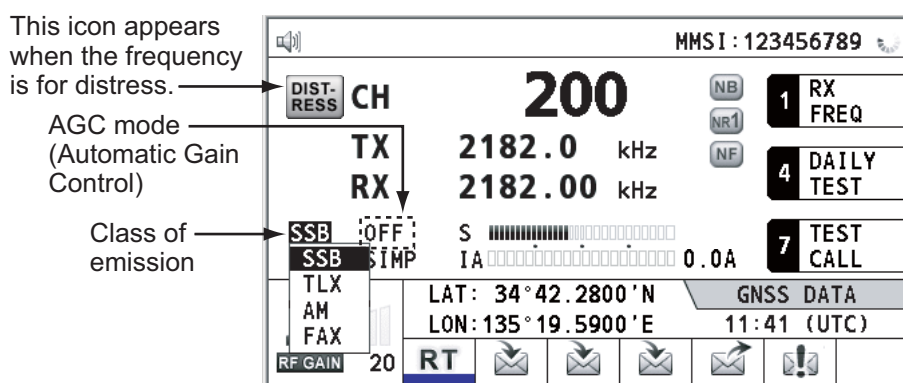

2. Rotate the **ENTER** knob to select the class of emission desired then push the knob. AGC is automatically turned on or off according to the class of emission.

- [SSB]: [FAST]      • [TLX], [FAX]: [OFF]      • [AM]: [SLOW]

3. You can change AGC as below.

- 1) Rotate the **ENTER** knob to select the AGC mode indication then push the knob.



- 2) Rotate the **ENTER** knob to select [OFF], [SLOW] or [FAST] then push the knob.

### 2.2 How to Select the Channel, Frequency

Select the channel or transmitting/receiving frequency to use for the SSB.

**Note:** To set the SSB radiotelephone to 2182 kHz/J3E, press the **2182** key.

**Channel**

1. Rotate the **ENTER** knob to select [CH] on the RT screen then push the knob. You can also show the channel setting window by pressing the **RT/CH** key.

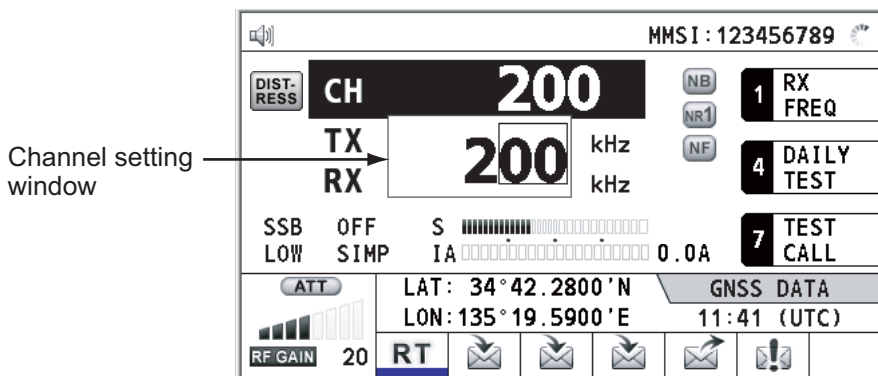

2. A channel can be entered directly with the numeric keys, or by using the **ENTER** knob. See below for details.

Enter channel with the numeric keys:

Use the numeric keys to enter channel then push the **ENTER** knob.

Select band and band channel with the **ENTER** knob:

- 1) Use the **←** or **→** key to place the cursor in the band or band channel position, whichever you want to change.



Cursor position for selection of band



Cursor position for selection of band channel

- 2) Rotate the **ENTER** knob to set band or band channel desired.

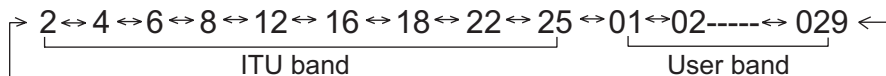

Setting Range

ITU Band (SSB, TLX): 2/4/6/8/12/16/18/22/25

ITU Band (CW): 4/6/8/12/16/22/25

User Band: 01-029 (First zero is necessary)

ITU Channel (SSB): 00 - XX

ITU Channel (TLX): 000 - XXX

ITU Channel (CW): 001 - XXX

User Channel: 01 - 99

- 3) Push the **ENTER** knob to close the setting window.

**Frequency**

1. Rotate the **ENTER** knob to select [TX] or [RX] then push the knob.



2. Enter frequency by one of the methods below.

Enter frequency with the numeric keys:

Use the numeric keys to enter frequency then push the **ENTER** knob. For example, to enter 2161 kHz, key in 2, 1, 6, 1, 0. (Note: Keying in 2-1-6-1 sets 216.1 kHz.) Be sure to include zero for 100 Hz place.

Select frequency with the **ENTER** knob (for RX only):

- 1) Use the **←** or **→** key to change the range which the cursor covers.
- 2) Rotate the **ENTER** knob to set frequency desired.
- 3) Push the **ENTER** knob to close the setting window.

**Note:** When TX and RX frequencies are different, first enter TX then enter RX.

## 2.3 Transmission

After selecting the class of emission and frequency, you can transmit by pressing the **PTT** switch on the handset.

### 2.3.1 Transmission procedure

Maximum transmission power is achieved only when the antenna impedance and transmitter impedance match each other. Because the antenna impedance changes with frequency, antenna impedance matching with the transmitter impedance is done with the antenna coupler. The antenna coupler automatically tunes the transmitter to a wide range of different antenna lengths. The available range is;

- Wire antenna 10 to 18 meters long (horizontal part)
- Whip antenna eight meters long (Horizontal feeder is two meters or longer.)
- Whip antenna 10 meters long

To initiate the tuning, do the following:

1. Press the **PTT** switch on the handset. Tuning is automatically adjusted at first transmission after frequency is changed. For manual tuning, press the **0/TUNE** key on the RT screen. If tuning fails, the message "TUNE NG" appears and the output power is automatically set to [LOW] (for FS-1575/2575) or [LOW2] (for FS-5075).
2. Hold the handset close to your mouth, press the **PTT** switch and speak clearly.

**Note:** When tuning is initiated in the two control unit system, the screen of the idle control unit shows "OCCUPIED (CONTROLLER 1 (or 2))". In this case, only the **DISTRESS** key is operative on the idle control unit.

### 2.3.2 How to change transmission power

To minimize possible interference to other stations, reduce the transmission power. This should be done when using the transceiver in a harbor, near the shore or close to communication partner (other ship).

1. Rotate the **ENTER** knob to select [HIGH], [MID], [LOW] (for FS-1575/2575), [LOW1] (for FS-5075) or [LOW2] (for FS-5075) (whichever is displayed), then push the knob.

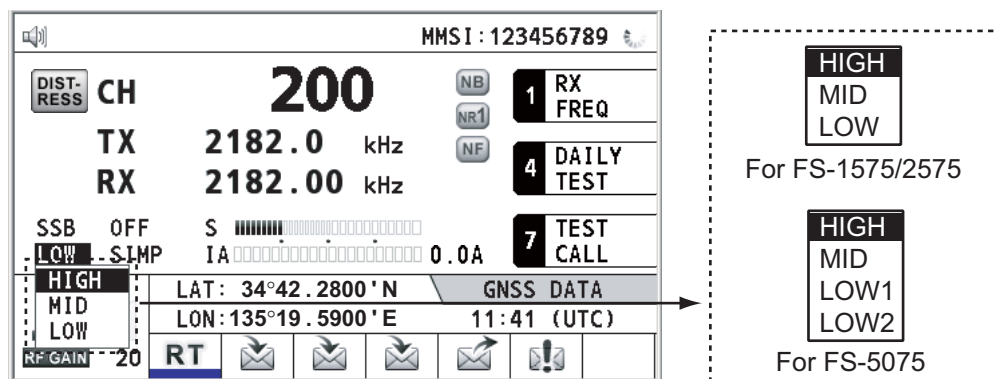

## 2. SSB RADIOTELEPHONE

2. Rotate the **ENTER** knob to select the option desired then push the knob.

	FS-1575/2575	FS-5075
[HIGH]	No reducing	
[MID]	125 Wpep	350 Wpep
[LOW]	90 Wpep	-
[LOW1]	-	200 Wpep
[LOW2]	-	110 Wpep

**Note:** The temperature of the power amplifier is monitored. When its temperature rises above a certain temperature, output power is automatically reduced.

### 2.3.3 Condition of the transmitter

While transmitting, you can display [IA] (antenna current), [IC] (collector current), [VC] (collector voltage), [RF] (RF output) or [VS] (source voltage) on the RT screen.

1. Rotate the **ENTER** knob to select [IA], [IC], [VC], [RF] or [VS] (whichever is displayed) then push the knob.

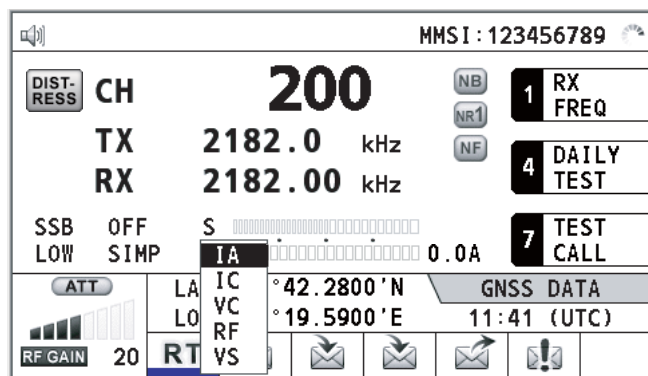

2. Rotate the **ENTER** knob to select the option desired then push the knob.

#### Check the transmission power

During transmission, the IA bar deflects according to the current being fed from the antenna coupler to the antenna feeder. The unit of readout is amperes. The antenna current varies with the effective antenna impedance. The reading differs by the frequency and antenna length. The output power is proportional to the square of an antenna current.

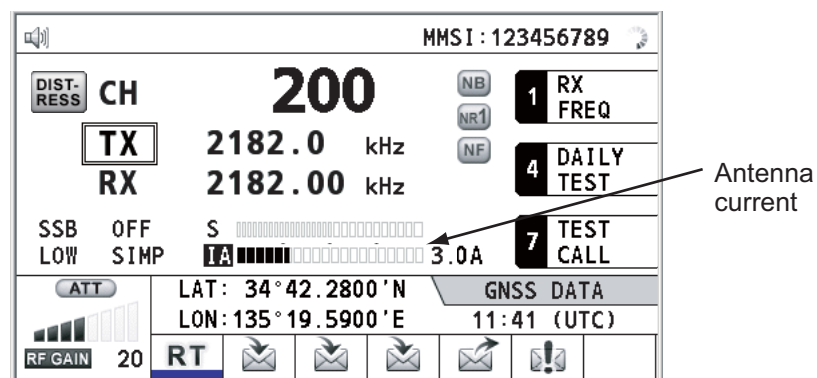

## 2.4 Reception

Check if the class of emission and receiving frequency are set properly. If necessary, set them again referring to sections 2.1 and 2.2.

### 2.4.1 RF gain (sensitivity) adjustment

In normal use the sensitivity should be set for maximum. If the audio on the received channel is unclear or interfered with other signals, adjust (usually reduce) sensitivity to improve clarity.

Rotate the **RF GAIN/PUSH TO ATT** knob to adjust gain (sensitivity). The setting value is displayed at the lower left-hand side of the screen, with analog and digital indications.



### 2.4.2 S-meter

The S-meter shows relative signal strength coming into the receiver front end.

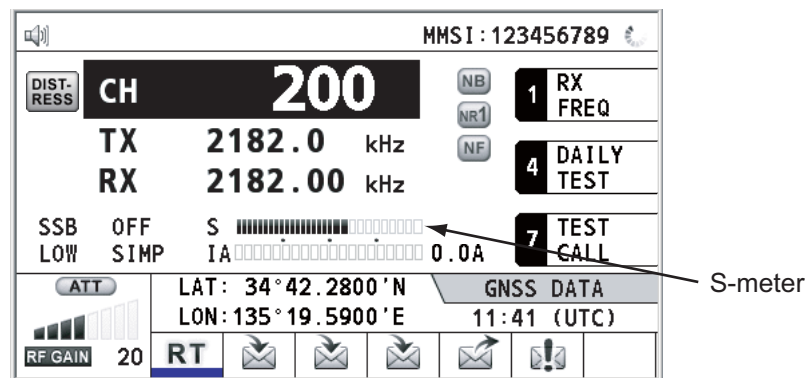

### 2.4.3 Receive AM broadcasting stations

1. If the RT screen is not displayed, press the **RT/CH** key to display the RT screen.
2. Rotate the **ENTER** knob to select the current class of emission then push the knob.
3. Rotate the **ENTER** knob to select [AM] then push the knob (see section 2.1).
4. Rotate the **ENTER** knob to select [RX] then push the knob.
5. Enter RX frequency with the numeric keys then push the **ENTER** knob (see "Frequency" in section 2.2).

### 2.4.4 Noise blanker

The noise blanker removes pulse noise. Press the **2/NB** key on the RT screen to turn the noise blanker on and off alternately. When the noise blanker function is active, **NB** is displayed on the RT screen.

### 2.4.5 Noise reduction

The noise reduction circuit analyzes speech component and noise component, and reduces only noise component. Press the **5/NR** key on the RT screen. Each time you press the **5/NR** key, the effect of noise reduction changes in the sequence of ([NR2]

## 2. SSB RADIOTELEPHONE

(High) → [NR1] (Low) → Off). When the noise reduction function is active, **NR2** or **NR1** is displayed on the RT screen.

### 2.4.6 Notch filter

The notch filter removes mixed CW (continuous wave) or beat signal interference. Press the **8/NF** key on the RT screen to turn the notch filter on and off alternately.

When the notch filter function is active, **NF** is displayed on the RT screen.

### 2.4.7 Squelch

#### Squelch on/off

The squelch mutes the audio output in the absence of an incoming signal. Press the **3/SQ** key on the RT screen to turn the squelch on and off alternately. When radio noise is too jarring during stand-by condition, it can be muted by activating the squelch.

When the squelch function is active, **SQ** is displayed on the RT screen.

#### Squelch frequency

To adjust the squelch frequency, see section 6.4.

### 2.4.8 Attenuator

The attenuator reduces total gain and prevents saturation. Push the **RF GAIN/PUSH TO ATT** knob on the RT screen to turn the attenuator on and off alternately. When the attenuator function is active, **ATT** is displayed on the RT screen.

## 2.5 User Channels

The [USER CH] menu provides for registration of user TX and RX channels, where permitted. For further details, contact your dealer. See section 6.2 for the procedure.

### NOTICE

**FURUNO will assume no responsibility for the disturbance caused by the unlawful or improper setting of user channels.**



# 3. DSC OVERVIEW

## 3.1 What is DSC?

DSC is an acronym meaning Digital Selective Calling. It is a digital distress and general calling system in the MF and HF bands used by ships for transmitting distress alerts and general calls and by coast stations for transmitting the associated acknowledgements.

For DSC distress, safety and urgency callings in the MF and HF bands, the frequencies are 2187.5, 4207.5, 6312.0, 8414.5, 12577.0, and 16804.5 kHz.

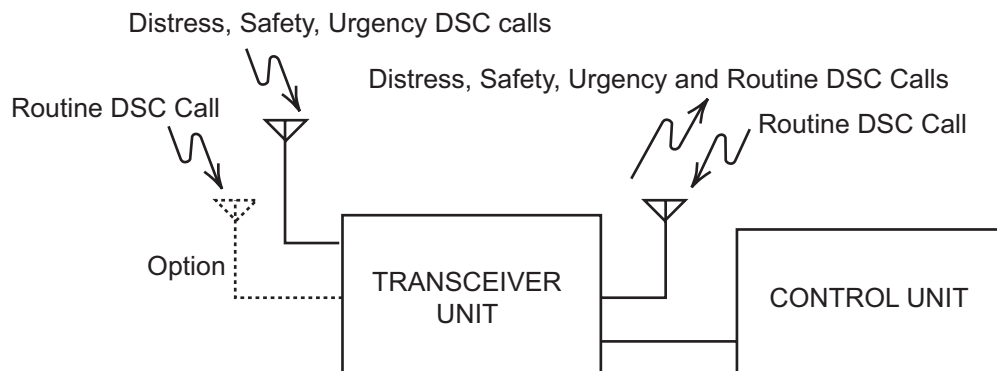

## 3.2 DSC Message

DSC calls are roughly divided in two groups: distress messages and general (safety, urgency and routine) messages. Below are the types of DSC messages.

Call	Description
DISTRESS ALERT	Your ship sends distress message.
DISTRESS RELAY AREA	Your ship relays distress call to all ships in a specific geographical area.
DISTRESS RELAY INDIVIDUAL	Your ship relays distress call to a coast station.
MEDICAL MSG*	Inform areas that your ship is carrying medical supplies.
NEUTRAL MSG*	Inform areas that your ship is not a participant in armed conflict.
INDIVIDUAL MSG	Call to a specific address.
PSTN MSG	Call over Public Switched Telephone Network (PSTN).
TEST MSG	Send test signal to a station to test your station's functionality.
GROUP MSG	Call to a specific group.
AREA MSG	Call to all ships in a specific geographical area.
POSITION MSG	Your ship requests position of other ships.
POLLING MSG	Confirm if your ship is within communicating range with other ships. (Receive and answer only)

\*SPECIAL MSG: To send these messages, set [SPECIAL MSG] to [ABLE]. See section 6.18.

**Contents of a DSC call**• **Calling category**

Call category	Call
DISTRESS	DISTRESS ALERT, DISTRESS RELAY AREA, DISTRESS RELAY INDIVIDUAL
GENERAL	MEDICAL MSG, NEUTRAL MSG, INDIVIDUAL MSG, PSTN MSG, TEST MSG, GROUP MSG, AREA MSG, POSITION MSG, POLLING MSG

• **Station ID (MMSI)**

Your ship ID and sending station ID. Coast station ID begins with 00; Group ID begins with 0.

• **Priority**

**Distress:** Grave and imminent danger and request immediate assistance.

**Urgency:** A calling station has a very urgent call to transmit concerning safety of ship, aircraft or other vehicle or safety of person.

**Safety:** A station is about to transmit a call containing an important navigational or meteorological warning.

**Routine:** General calling

• **Communication mode**

**TELEPHONE:** Telephone (J3E) by SSB radiotelephone

**NBDP-ARQ\*:** Telex (J2B) mode ARQ via NBDP Terminal Unit

**NBDP-FEC\*:** Telex (J2B) mode FEC via NBDP Terminal Unit

\*: NBDP terminal unit is required.

• **Communication frequency**

Working frequency used to call by telephone or NBDP. The sending station may have the receiving station (ship or coast station) assign the frequency to use.

• **Position**

Position can be automatically or manually set.

• **DSC frequency**

DSC frequency to use. If the call priority is SAFETY, URGENCY or DISTRESS, select a DSC distress frequency.

• **End code**

The end of a DSC call is indicated with "EOS" (acknowledgement, acknowledgement required, no acknowledgement required).

### 3.3 Audio Alarms

When you receive a distress alert or general call addressed to your ship, the audio and visual alarms are released. The audio alarm can be silenced with the **CANCEL** key.

Alarm	Frequency (interval)
Safety call received	750 Hz and 650 Hz (50 ms)
Routine call received	750 Hz and 650 Hz (50 ms)
While <b>DISTRESS</b> key is pressed for four seconds	2000 Hz and 0 Hz (500 ms)

Alarm	Frequency (interval)
Distress alert sent	2200 Hz, continuous (2 seconds)
Own ship position not updated	2000 Hz (250 ms) and 0 Hz (500 ms)
Distress alert call received	2200 Hz and 1300 Hz (250 ms)
Distress relay call received	2200 Hz and 1300 Hz (250 ms)
Distress relay ack call received	2200 Hz (500 ms) and 1300 Hz (500 ms)
Distress ack call received	2200 Hz (500 ms) and 1300 Hz (500 ms)
Urgency call received	2200 Hz and 0 Hz (250 ms)
Urgency ack call received	2200 Hz and 0 Hz (500 ms)

### 3.4 Description of Call Screens

This section provides the information necessary for interpreting the receive and send call screens.

#### 3.4.1 RX calls

Below are sample distress alert and individual RX call screens. The contents of other types of RX calls are similar to that of the individual call.

##### Distress alert

Speaker icon →

Call type →

ID No. (MMSI) of ship in distress →

Nature of distress →

Communication mode and suggested channel →

RF gain →

← Working frequency to use

← Elapsed time since distress alert received

← Distance to ship in distress

← Position of ship in distress

← DSC frequency

← Available user options

← Session in progress

##### Individual RX call

Speaker icon →

Call type →

ID No. (MMSI) of ship sending this message →

Communication frequency →

RF gain →

← Working frequency to use

← Elapsed time since call received

← Communication mode

← Available user options

← Session in progress

### 3. DSC OVERVIEW

The marks "\*", "-" appear on the DSC receiving screen in the following conditions:

- "\*" indicates a corrupt character in received data.
- "-" indicates missing digits after decimal point when receiving position data with no info for expansion (expansion: digits after decimal point).

Examples:

- 1) When receiving position data without expansion, the indication is "LAT: 12°34'N".
- 2) When receiving position data with expansion, the indication is "LAT: 12°34,5678'N".
- 3) When receiving position data with no info for expansion, the indication is "LAT: 12°34,----'N".

### 3.4.2 TX calls

Below are sample distress alert and individual TX call screens. The contents of other types of TX calls are similar to that of the individual call.

#### Distress alert

SSB TX 8291.0/RX 8291.00 kHz

**COMPOSE MESSAGE**

MSG TYPE : **DISTRESS ALERT**

NATURE : **UNDESIGNATED** ← Nature of Distress

LAT : **09° 12.1234N** ← Position of ship in distress (your ship) and time of distress

LON/UTC : **123° 45.1234E / 12:34**

COMM MODE : **TELEPHONE / 8291.0kHz** ← Communication mode

DSC FREQ : **MULTI 2 4 6 8 12 16MHz** ← DSC frequency to send distress call

PRESS DISTRESS BUTTON  
TO SEND DISTRESS ALERT.

CANCEL: BACK

#### Individual TX call

SSB TX 2182.0/RX 2182.00 kHz

**COMPOSE MESSAGE**

MSG TYPE : **INDIVIDUAL MSG** ← Message type (Individual)

TO : **123456789** ← ID No. of station where message is to be sent

PRIORITY : **ROUTINE** ← Priority (Routine, Safety, Urgency)

COMM MODE : **TELEPHONE** ← Communication mode (Telephone, NBDP-ARQ, NBDP-FEC)

COMM FREQ : **2170.0kHz** ← Communication frequency

DSC FREQ : **2177.0kHz** ← DSC frequency

CANCEL: BACK      GO TO CALL

# 4. DSC DISTRESS OPERATIONS

## Distress operation overview

1. Press the **DISTRESS** key.
2. Wait for the distress alert acknowledgement.
3. Communicate with the coast station.

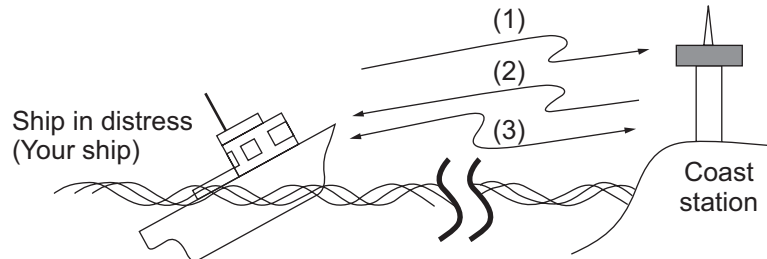

- (1) Ship in distress sends Distress Alert.
- (2) Coast station sends distress acknowledgement (DIST ACK).
- (3) Voice or telex communication between ship in distress and coast station.

## 4.1 How to Send Distress Alert

GMDSS ships carry a DSC terminal with which to transmit the distress alert in the event of a life-endangering situation. A coast station receives the distress alert and sends the distress alert acknowledge call to the ship in distress. Then, voice or telex communication between the ship in distress and coast station begins. Transmission of the distress alert and receiving of the distress alert acknowledgement are completely automatic - simply press the **DISTRESS** key to initiate the sequence.

There are three types of distress alerts; MULTI, SINGLE, AUTO. MULTI is used normally. To use another method, see step 10 in paragraph 4.1.2.

**Note:** After sending the distress alert, no control unit has priority.

### 4.1.1 How to send distress alert by **DISTRESS** key with distress information not edited

1. Open the **DISTRESS** key cover then press the **DISTRESS** key for four seconds. The audio alarm sounds while pressing the key, and the key flashes in red. The countdown message appears on the screen while pressing the **DISTRESS** key (3S → 2S → 1S → 0S).

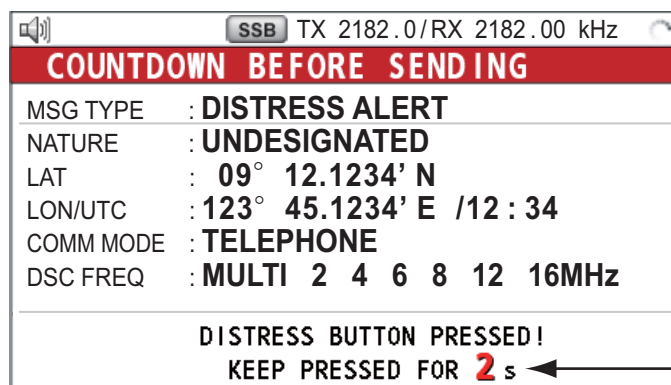

#### 4. DSC DISTRESS OPERATIONS

When the countdown shows 0S, the distress alert is sent. The audio alarm sounds for two seconds and the message "Sending DISTRESS ALERT." appears. The screen shows the contents of the distress alert call. The **DISTRESS** key lights in red and only the icon for DISTRESS transmission () is displayed in the tab area.

After the distress alert has been sent, the screen changes as below. Wait to receive the distress acknowledge call from a coast station. The elapsed time since transmission is displayed. At this time, the icons for other DSC received messages except the distress alert acknowledge call are not displayed. You can only confirm them in the log.

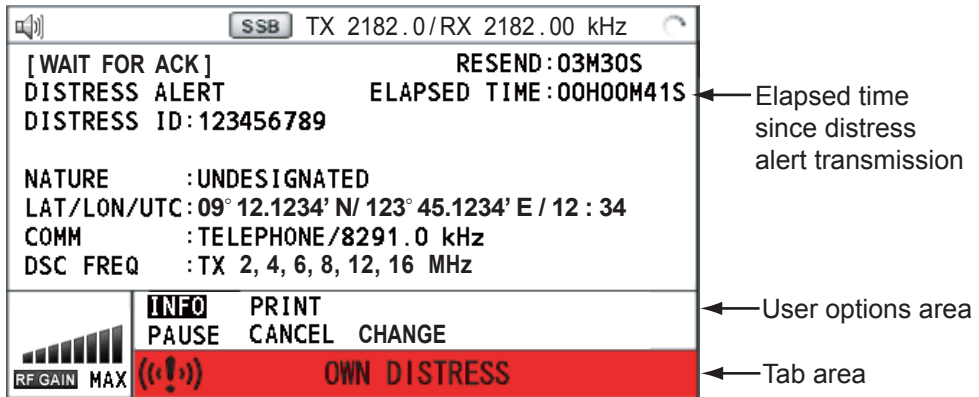

**Note:** If you do not receive the distress alert acknowledge call, the equipment automatically re-transmits the distress alert after 3 min 30 seconds to 4 min 30 seconds. Then awaits the distress alert acknowledge call. This is repeated until the distress alert is acknowledged.

You can temporarily stop the countdown for next retransmission by selecting [PAUSE] in the user options area. [PAUSE] indication changes to [START] and [PAUSE] is displayed instead of the countdown indication. To restart, select [START]. The countdown restarts and [START] indication in the user options area changes to [PAUSE].

Also, you can re-send the distress alert manually by pressing the **DISTRESS** key for four seconds.

When the distress acknowledge call is received, the audio alarm sounds, the LED flashes in red, and the icon for DISTRESS transmission () appears. The screen changes as below.

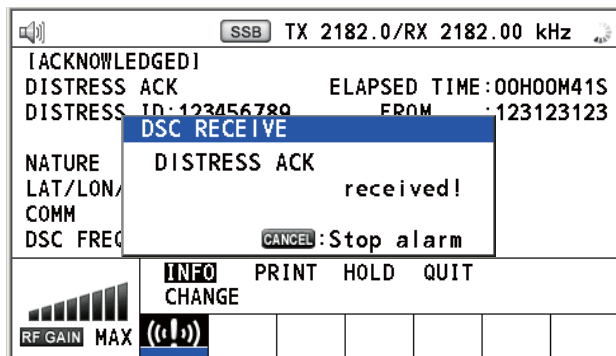

2. Press the **CANCEL** key to silence the audio alarm. Then, the LED stops flashing, and the pop-up message disappears.

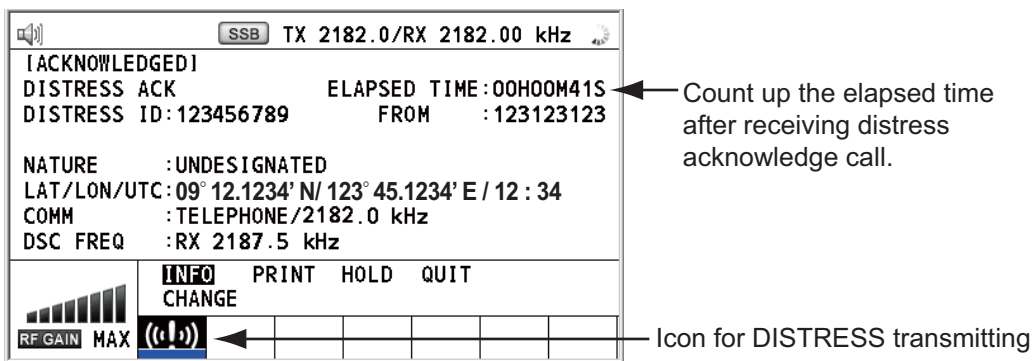

3. Communicate with the coast station via radiotelephone, following the instructions below. If the distress alert was sent using the MULTI mode, the radiotelephone automatically sets the working frequency on which the distress acknowledge call is first received.
  - a) Say "MAYDAY" three times.
  - b) Say "This is ..." name of your ship and call sign three times.
  - c) Give nature of distress and assistance needed.
  - d) Give description of your ship (type, color, number of persons onboard, etc.).

### 4.1.2 How to send distress alert by DISTRESS key with distress information edited

If you have a time to prepare the distress information, send the distress alert as follows:

1. Press the **DISTRESS MSG** key to display the following screen.

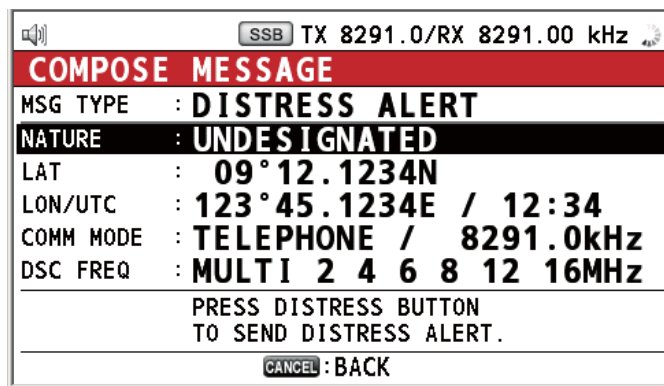

2. With [NATURE] selected, push the **ENTER** knob.
3. Rotate the **ENTER** knob to select nature of distress, among the following 11 selections, then push the knob.
  - UNDESIGNATED
  - FIRE
  - FLOODING
  - COLLISION
  - GROUNDING
  - LISTING
  - SINKING
  - DISABLED&ADR(IFT)
  - ABANDONING
  - PIRACY
  - MAN OVERBOARD

#### 4. DSC DISTRESS OPERATIONS

- With [LAT] and [LON/UTC] selected, push the **ENTER** knob.



[GNSS]: The position information from GNSS is automatically shown.

[MANUAL]: Input your position manually.

[NO INFO]: No information.

- Rotate the **ENTER** knob to select [GNSS], [MANUAL] or [NO INFO] then push the knob. For [MANUAL], go to step 6. For others, go to step 7.
- Use the numeric keys to enter latitude, longitude and UTC time. (If necessary, switch coordinates: **1** key to switch to North (East for longitude); **2** key to switch to South (West for longitude).) Push the **ENTER** knob.

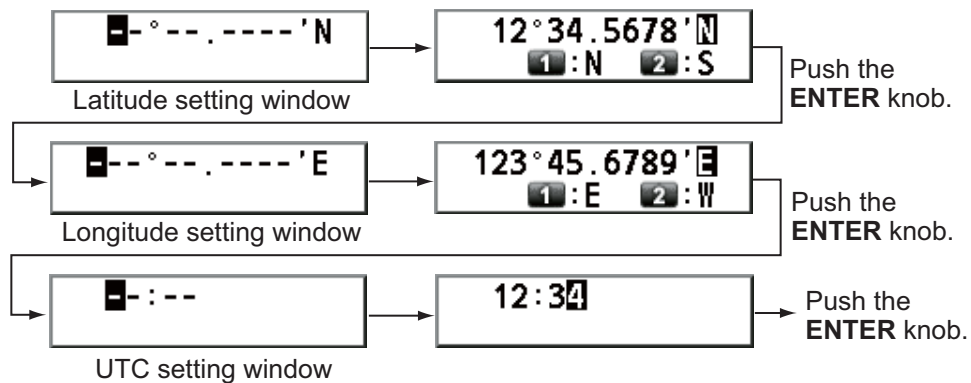

- With [COMM MODE] selected, push the **ENTER** knob.
- Rotate the **ENTER** knob to select [TELEPHONE] or [NBDP-FEC] then push the knob.
- With [DSC FREQ] selected, push the **ENTER** knob.

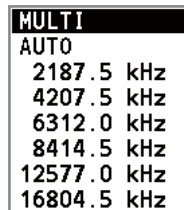

- Rotate the **ENTER** knob to select the DSC frequency desired then push the knob. [MULTI]: Transmit the distress alert on three to six frequencies (in numerical order), which you can select among 2 MHz, 4 MHz, 6 MHz, 8 MHz, 12 MHz and 16 MHz. 2 MHz and 8 MHz are automatically selected and cannot be excluded.

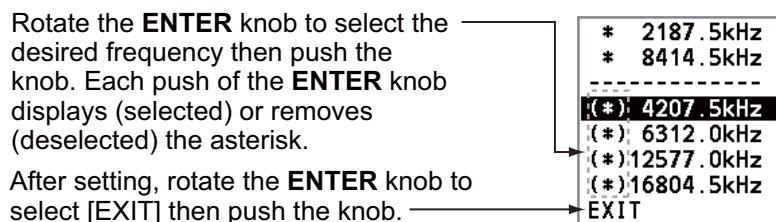

[SINGLE]: You can transmit on the distress frequency of your selection. Select one frequency among 2 MHz, 4 MHz, 6 MHz, 8 MHz, 12 MHz and 16 MHz.

[AUTO]: Transmit the distress alert on 2 MHz at first (40 to 60 seconds). If the distress alert is not acknowledged, transmission occurs in this sequence:

2nd: 8 MHz, 3rd: 16 MHz, 4th: 4 MHz, 5th: 12 MHz and 6th: 6 MHz



11. Press the **DISTRESS** key for four seconds to send the distress alert. The audio alarm sounds while pressing the key, and the key flashes in red. The countdown message appears on the screen while pressing the **DISTRESS** key (3S → 2S → 1S → 0S) (refer to the illustration at step 1 in paragraph 4.1.1.). When the countdown shows 0S, the distress alert is sent. The audio alarm sounds for two seconds and the message "Sending DISTRESS ALERT." appears.
12. When the distress acknowledge call is received, use the telephone or telex to communicate with the coast station. For NBDP, follow the procedure in "Communicating by NBDP terminal unit" on this page. For telephone, follow step 3 on paragraph 4.1.1. If you selected [MULTI] at step 10, you can communicate via telephone, on the communication frequency which the distress acknowledge call is received. If it is necessary to change the frequency, do the following:
  - 1) Rotate the **ENTER** knob to select [CHANGE] in the user options area then push the knob.

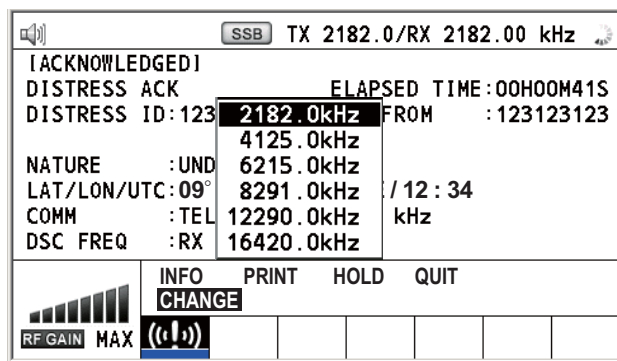

- 2) Rotate the **ENTER** knob to select the appropriate frequency then push the knob.

**Communication by NBDP terminal unit**

The message "STATION ENTRY COMPLETED FROM DSC. Press any key to escape." appears on the NBDP's screen.

1. Press any key on the NBDP terminal unit to erase the message.
2. Press the function key **F3** on the keyboard of the NBDP terminal unit to open the [Operate] menu.
3. Select [Call Station] then press the **ENTER** knob.

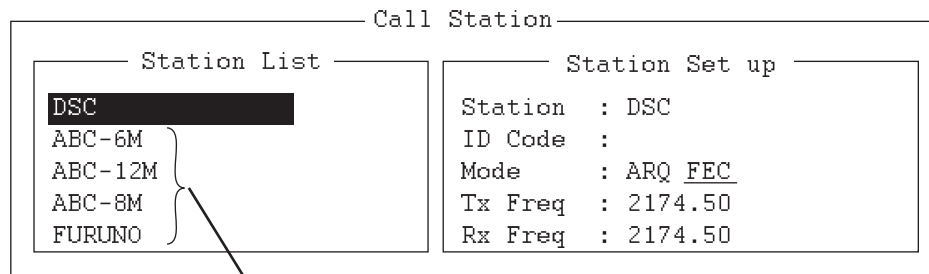

For IB-585, these items are not displayed when sending the distress alert.

4. With [DSC] selected, press the **Enter** key to connect the communication line. "Connect" appears in reverse video.
5. Type and transmit your message, giving the following information:
  - Ship's name and call sign

## 4. DSC DISTRESS OPERATIONS

- Nature of distress and assistance needed
  - Description of your ship
6. Press the function key **F10** to disconnect the line.  
For NBDP details, see chapters 7 through 10.

## 4.2 How to Receive a Distress Alert

When you receive a distress alert from a ship in distress, the audio alarm sounds and the LED flashes in red. The icon for DISTRESS receiving (🔊) appears in the tab area and the pop-up message "DISTRESS ALERT message received! [CANCEL]: Stop alarm" appears on the screen.

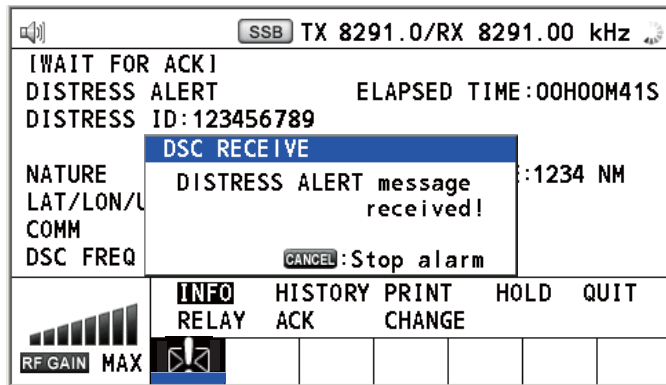

Press the **CANCEL** key to silence the audio alarm. Wait for the distress acknowledge call from a coast station. If you do not receive the distress acknowledge call from a coast station, which usually takes about five minutes from the time of receiving a distress alert, follow the flow charts in this section to determine your action.

**Note:** An asterisk (\*) appearing in a distress alert message indicates an error at the asterisk's location.

### 4.2.1 Distress alert received on MF band

Do the following:

- Continue watching on 2182 kHz. Wait for coast station to acknowledge the distress call. Watch until "SEELONCE FINI" is announced.
- If multiple DSC distress alerts are received from the same ship in distress and it is near your ship, communicate with RCC or coast station and send distress acknowledge call to the ship in distress under the direction of RCC or coast station.
- Watch on the distress frequency.

**Action for ship receiving distress alert on MF band**

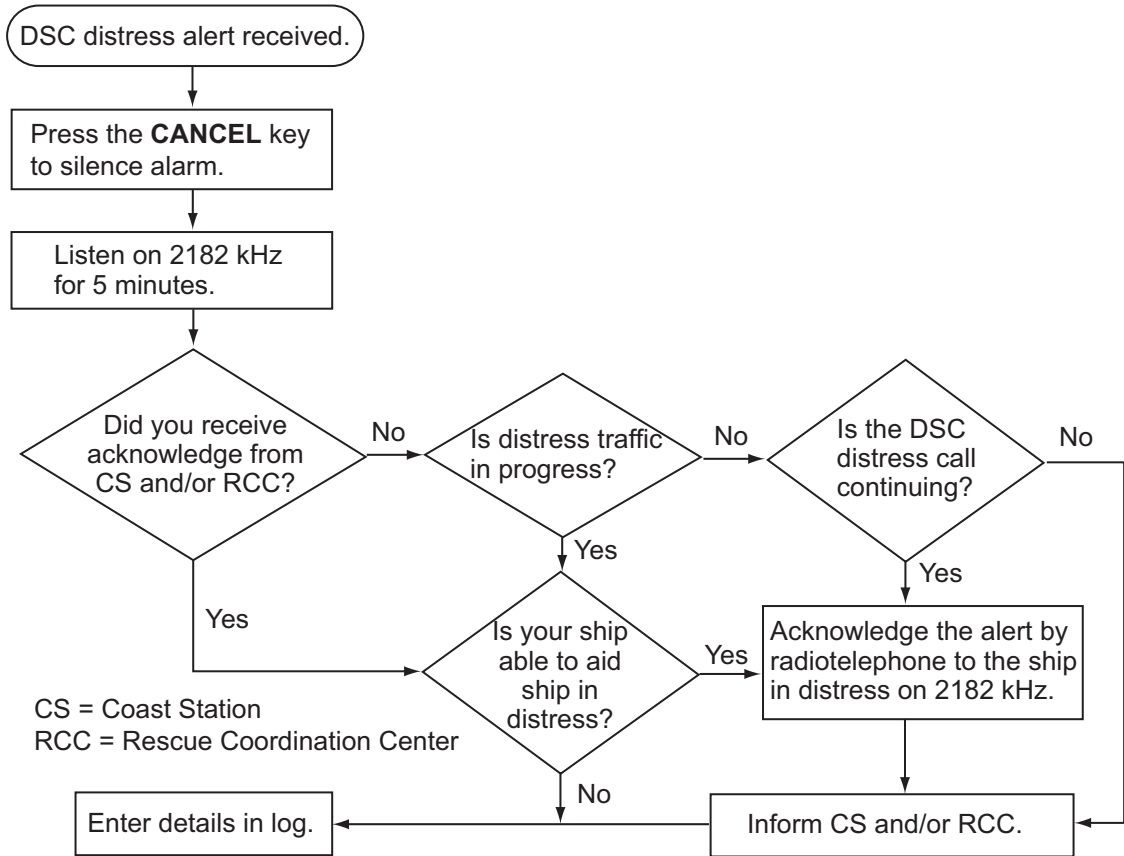

**Send the distress acknowledge call to ship in distress (on MF band)**

**Note:** You must wait at least five minutes before you can acknowledge a distress alert, to allow time for a coast station to transmit the distress acknowledge.

Transmit the distress acknowledge call to the ship in distress only when you do not receive it from a coast station and you are able to aid the ship in distress. First, contact the ship in distress over radiotelephone.

When you receive a distress alert from a ship in distress, the audio alarm sounds and the LED flashes in red. The icon for DISTRESS receiving appears in the tab area and the pop-up message "DISTRESS ALERT message received! [CANCEL]: Stop alarm" appears on the screen.

To terminate transmission of the distress alert, send acknowledge call as follows.

1. Press the **CANCEL** key to silence the audio alarm and stop the flashing of the LED.

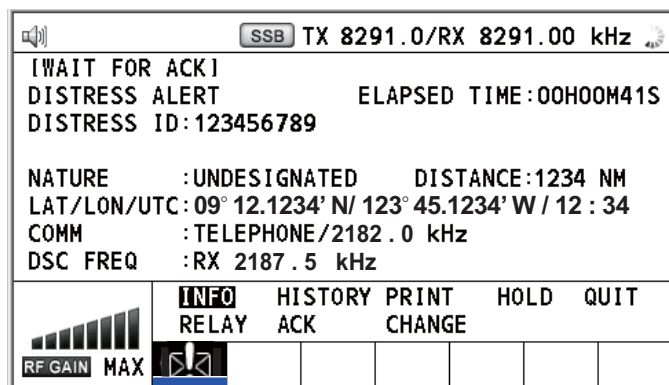

#### 4. DSC DISTRESS OPERATIONS

2. If you do not receive the distress acknowledge call from a coast station and you have received the distress alert more than twice, contact the ship in distress over radiotelephone.
3. Rotate the **ENTER** knob to select [ACK] in the user options area then push the knob. The following message appears on the screen.

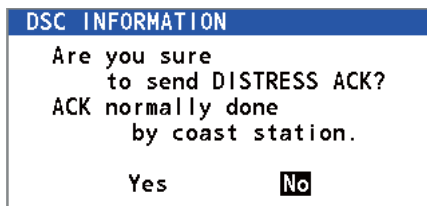

4. Rotate the **ENTER** knob to select [Yes] then push the knob to transmit the distress acknowledge call to the ship in distress. The screen changes as below.

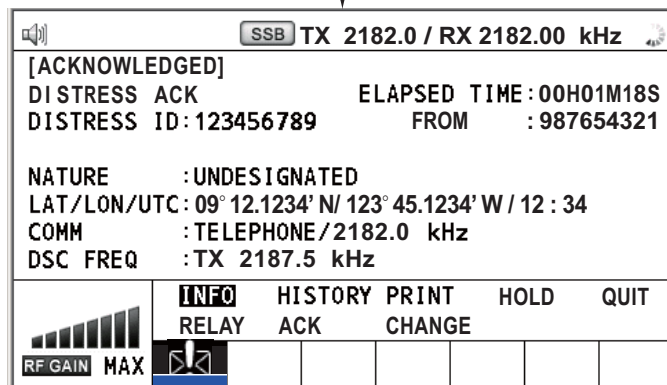
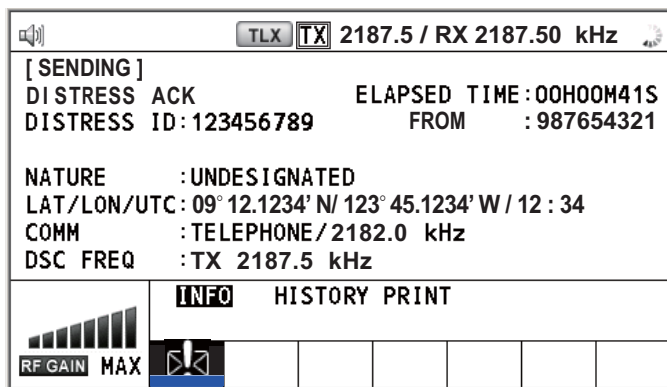

**Note:** You can not edit the message for the distress acknowledge call.

#### 4.2.2 Distress alert received on HF band

If you receive a distress alert on the HF band, the audio alarm sounds and the LED flashes in red. The icon for DISTRESS receiving (📡) appears in the tab area and the pop-up message "DISTRESS ALERT message received! [CANCEL]: Stop alarm" appears on the screen. Press the **CANCEL** key to silence the audio alarm and stop the flashing of the LED. The screen for receiving the distress alert appears. Wait for the distress acknowledge call from a coast station. If you do not receive the distress acknowledge call from a coast station, which usually takes about five minutes from the time of receiving a distress alert, follow the flow chart in this section to determine your action.

- Watch on the distress frequency.