



FCC TEST REPORT

REPORT NO.: RF930127H01

MODEL NO.: WU830G

RECEIVED: Jan. 27, 2004

TESTED: Jan. 28 to 30, 2004

APPLICANT: Motorola, Inc.

ADDRESS: 101 Tournament Drive, Horsham, PA 19044 U.
S. A.

ISSUED BY: Advance Data Technology Corporation

LAB LOCATION: No. 81-1, Lu Liao Keng, 9 Ling, Wu Lung Tsuen,
Chiung Lin Hsiang, Hsin Chu Hsien,
Taiwan, R.O.C.

This test report consists of 58 pages in total. It may be duplicated completely for legal use with the approval of the applicant. It should not be reproduced except in full, without the written approval of our laboratory. The test results in the report only apply to the tested sample.



0536
ILAC MRA



Table of Contents

1	CERTIFICATION.....	4
2	SUMMARY OF TEST RESULTS.....	5
3	GENERAL INFORMATION	6
3.1	GENERAL DESCRIPTION OF EUT.....	6
3.2	DESCRIPTION OF TEST MODES.....	7
3.3	GENERAL DESCRIPTION OF APPLIED STANDARDS	7
3.4	DESCRIPTION OF SUPPORT UNITS.....	8
4	TEST TYPES AND RESULTS	9
4.1	CONDUCTED EMISSION MEASUREMENT.....	9
4.1.1	LIMITS OF CONDUCTED EMISSION MEASUREMENT.....	9
4.1.2	TEST INSTRUMENTS	9
4.1.3	TEST SETUP	10
4.1.4	EUT OPERATING CONDITIONS	11
4.1.5	TEST RESULTS.....	12
4.2	Radiated Emission Measurement.....	14
4.2.1	LIMITS OF RADIATED EMISSION MEASUREMENT.....	14
4.2.2	TEST INSTRUMENTS	15
4.2.3	TEST PROCEDURES	16
4.2.4	TEST SETUP	17
4.2.5	EUT OPERATING CONDITIONS	17
4.2.6	TEST RESULTS.....	18
4.2.7	TEST RESULTS - DSSS.....	19
4.2.8	TEST RESULTS -OFDM.....	22
4.3	6dB BANDWIDTH MEASUREMENT	25
4.3.1	LIMITS OF 6dB BANDWIDTH MEASUREMENT.....	25
4.3.2	TEST INSTRUMENTS	25
4.3.3	TEST PROCEDURE	26
4.3.4	TEST SETUP	26
4.3.5	EUT OPERATING CONDITIONS	26
4.3.6	TEST RESULTS-DSSS	27
4.3.7	TEST RESULTS-OFDM	31
4.4	MAXIMUM PEAK OUTPUT POWER	35
4.4.1	LIMITS OF MAXIMUM PEAK OUTPUT POWER MEASUREMENT	35
4.4.2	TEST INSTRUMENTS	35
4.4.3	TEST PROCEDURES	36



4.4.4	TEST SETUP	36
4.4.5	EUT OPERATING CONDITIONS	36
4.4.6	TEST RESULTS- DSSS	37
4.4.7	TEST RESULTS- OFDM	37
4.5	POWER SPECTRAL DENSITY MEASUREMENT	38
4.5.1	LIMITS OF POWER SPECTRAL DENSITY MEASUREMENT.....	38
4.5.2	TEST INSTRUMENTS	38
4.5.3	TEST PROCEDURE	39
4.5.4	TEST SETUP	39
4.5.5	EUT OPERATING CONDITIONS	39
4.5.6	TEST RESULTS-DSSS	40
4.5.7	TEST RESULTS-OFDM	44
4.6	BAND EDGES MEASUREMENT.....	48
4.6.1	LIMITS OF BAND EDGES MEASUREMENT.....	48
4.6.2	TEST INSTRUMENTS	48
4.6.3	TEST PROCEDURE	48
4.6.4	EUT OPERATING CONDITION.....	48
4.6.5	TEST RESULTS - DSSS.....	49
4.6.6	TEST RESULTS-OFDM	52
4.7	ANTENNA REQUIREMENT.....	55
4.7.1	STANDARD APPLICABLE.....	55
4.7.2	ANTENNA CONNECTED CONSTRUCTION	55
5	PHOTOGRAPHS OF THE TEST CONFIGURATION.....	56
6	INFORMATION ON THE TESTING LABORATORIES.....	58



1 CERTIFICATION

PRODUCT : Wireless USB Adapter
BRAND NAME : Motorola
MODEL NO. : WU830G
APPLICANT : Motorola, Inc.
STANDARDS : 47 CFR Part 15, Subpart C (Section 15.247),
ANSI C63.4-1992

We, **Advance Data Technology Corporation**, hereby certify that one sample of the designation has been tested in our facility from Jan. 28 to 30, 2004. The test record, data evaluation and Equipment Under Test (EUT) configurations represented herein are true and accurate accounts of the measurements of the sample's characteristics under the conditions herein specified.

PREPARED BY: Carol Liao , **DATE:** Feb. 03, 2004
(Carol Liao)

APPROVED BY: Eric Lin , **DATE:** Feb. 03, 2004
(Eric Lin, Manager)



2 SUMMARY OF TEST RESULTS

The EUT has been tested according to the following specifications:

APPLIED STANDARD: 47 CFR Part 15, Subpart C			
Standard Section	Test Type and Limit	Result	REMARK
15.207	AC Power Conducted Emission Limit: 48dBuV	PASS	Meet the requirement of limit Minimum passing margin is -24.01 dBuV at 1.752 MHz
15.247(a)(2)	Spectrum Bandwidth of a Direct Sequence Spread Spectrum System Limit: min. 500kHz	PASS	Meet the requirement of limit
15.247(b)	Maximum Peak Output Power Limit: max. 30dBm	PASS	Meet the requirement of limit
15.247(c)	Transmitter Radiated Emissions Limit: Table 15.209	PASS	Meet the requirement of limit Minimum passing margin is -0.30 dBuV at 9748.00MHz
15.247(d)	Power Spectral Density Limit: max. 8dBm	PASS	Meet the requirement of limit
15.247(c)	Band Edge Measurement Limit: 20 dB less than the peak value of fundamental frequency	PASS	Meet the requirement of limit



3 GENERAL INFORMATION

3.1 GENERAL DESCRIPTION OF EUT

PRODUCT	Wireless USB Adapter
MODEL NO.	WU830G
POWER SUPPLY	5VDC from host equipment
MODULATION TYPE	CCK, OFDM, DBPSK, DQPSK
RADIO TECHNOLOGY	DSSS, OFDM
TRANSFER RATE	1/2/5.5/6/9/11/12/18/24/36/48/54Mbps
FREQUENCY RANGE	2412MHz ~ 2462MHz
NUMBER OF CHANNEL	11
OUTPUT POWER	17.35dBm
ANTENNA TYPE	Printed PCB Antenna
DATA CABLE	USB Cable (Unshielded 1.8m)
I/O PORTS	USB Port
ASSOCIATED DEVICES	NA

NOTE:

1. The EUT operates in the 2.4GHz frequency spectrum with throughput of up to 54Mbps.
2. The EUT complies with IEEE 802.11g draft standards, and backwards compatible with IEEE 802.11b products.
3. For a more detailed features description, please refer to the manufacturer's specifications or User's Manual.



3.2 DESCRIPTION OF TEST MODES

Eleven channels are provided in this EUT.

Channel	Frequency	Channel	Frequency
1	2412 MHz	7	2442 MHz
2	2417 MHz	8	2447 MHz
3	2422 MHz	9	2452 MHz
4	2427 MHz	10	2457 MHz
5	2432 MHz	11	2462 MHz
6	2437 MHz		

NOTE:

1. Below 1 GHz, the channel 1, 6, and 11 were pre-tested in chamber. The channel 11, worst case one, was chosen for final test.
2. Above 1 GHz, the channel 1, 6, and 11 were tested individually.
3. Test result, which were mentioned on section 3.1.
4. Transfer rate, 11Mbps with CCK technique and 6Mbps with OFDM technique, the worst case, were chosen for final test.

3.3 GENERAL DESCRIPTION OF APPLIED STANDARDS

The EUT is a Wireless USB Adapter. According to the specifications of the manufacturer, it must comply with the requirements of the following standards:

47 CFR Part 15, Subpart C. (15.247)
ANSI C63.4 : 1992

All tests have been performed and recorded as per the above standards.

NOTE: The EUT is also considered as a kind of computer peripheral, because the connection to computer is necessary for typical use. It has been verified to comply with the requirements of 47 CFR Part 15, Subpart B, Class B (DoC). The test report has been issued separately.



3.4 DESCRIPTION OF SUPPORT UNITS

The EUT has been tested as an independent unit together with other necessary accessories or support units. The following support units or accessories were used to form a representative test configuration during the tests.

No.	Product	Brand	Model No.	Serial No.	FCC ID
1	PERSONAL COMPUTER	LEO	PERSICA8620G	1A37I62B001880	NA
2	MONITOR	ADI	CM100	026058T10200528	FCC DoC
3	PRINTER	HP	C2642A	MY79F1C3MZ	B94C2642X
4	MODEM	ACEEX	1414	0206026774	IFAXDM1414
5	Keyboard	BTC	KB-5200T	F24800419	E5XKB5122WTH0110
6	MOUSE	BTC	M851	G00347024435	N/A

No.	Signal cable description
1	NA
2	1.8 m braid shielded wire, terminated with VGA connector via metallic frame, w/o core.
3	1.8 m braid shielded wire, terminated with DB25 and Centronics connector via metallic frame, w/o core.
4	1 m braid shielded wire, terminated with DB25 and DB9 connector via metallic frame, w/o core.
5	1.6 m foil shielded wire, terminal by frame, PS2 Connector, w/o Core.
6	1.8 m foil shielded wire, terminal by frame, PS2 Connector, w/o Core.

Note: 1. All power cords of the above support units are unshielded (1.8m).

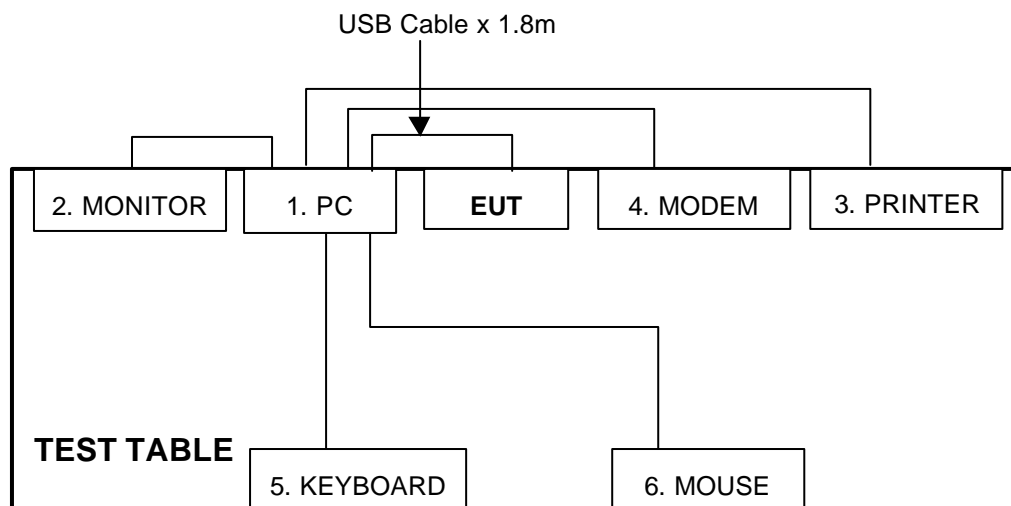

NOTE: 1. Please refer to the photos of test configuration in Item 5 also.



4 TEST TYPES AND RESULTS

4.1 CONDUCTED EMISSION MEASUREMENT

4.1.1 LIMITS OF CONDUCTED EMISSION MEASUREMENT

FREQUENCY OF EMISSION (MHz)	CONDUCTED LIMIT (dB μ V)	
	Quasi-peak	Average
0.15-0.5	66 to 56	56 to 46
0.5-5	56	46
5-30	60	50

NOTE

1. The lower limit shall apply at the transition frequencies.
2. All emanations from a class B digital device or system, including any network of conductors and apparatus connected thereto, shall not exceed the level of field strengths specified above.

4.1.2 TEST INSTRUMENTS

DESCRIPTION & MANUFACTURER	MODEL NO.	SERIAL NO.	CALIBRATED UNTIL
ROHDE & SCHWARZ Test Receiver	ESCS 30	847124/029	Dec. 04, 2004
ROHDE & SCHWARZ LISN (for EUT)	ESHS-Z5	848773/004	Nov. 04, 2004
KYORITSU LISN (for peripheral)	KNW-407	8/1395/12	Jul. 27, 2004
RF Cable (JETBAO)	RG233/U	Cable_CA_01	Jul. 03, 2004
Terminator(for KYORITSU)	50	3	Apr. 11, 2004
Software	Cond-V2e	NA	NA

- NOTE: 1. The calibration interval of the above test instruments is 12 months and the calibrations are traceable to NML/ROC and NIST/USA.
2. The test was performed in ADT Shielded Room No. A.
3. The VCCI Con A Registration No. is C-817.

3. TEST PROCEDURES

- The EUT was placed 0.4 meters from the conducting wall of the shielded room with EUT being connected to the power mains through a line impedance stabilization network (LISN). Other support units were connected to the power mains through another LISN. The two LISNs provide 50 ohm/ 50uH of coupling impedance for the measuring instrument.
- Both lines of the power mains connected to the EUT were checked for maximum conducted interference.
- The frequency range from 150 kHz to 30 MHz was searched. Emission levels over 10dB under the prescribed limits could not be reported

4.1.3 TEST SETUP

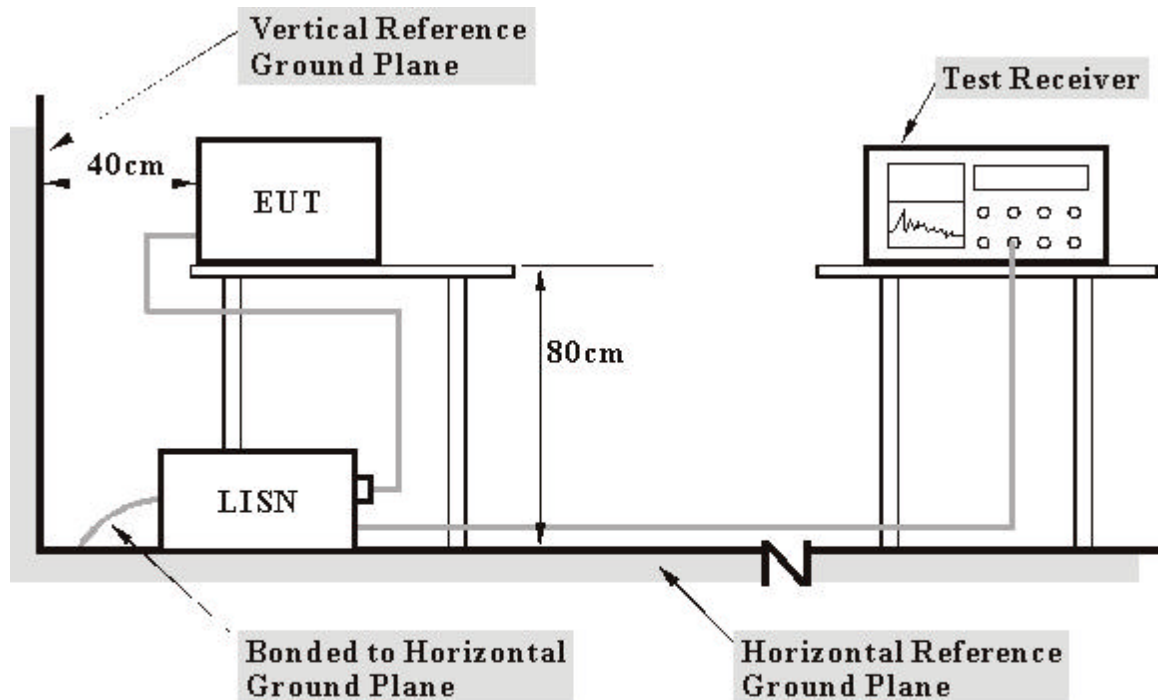

- Note:**
- Support units were connected to second LISN.
 - Both of LISNs (AMN) 80 cm from EUT and at the least 80 cm from other units and other metal planes support units.

For the actual test configuration, please refer to the related item – Photographs of the Test Configuration.



4.1.4 EUT OPERATING CONDITIONS

- a. Connected the EUT to support unit 1 (Personal Computer) and placed on a testing table.
- b. The support unit 1 (Personal Computer) ran a test program to enable EUT under transmission condition continuously at specific channel frequency.
- c. PC sends "H" messages to modem.
- d. PC sends "H" messages to printer via EUT, and the printer prints them on paper.



4.1.5 TEST RESULTS

EUT	Wireless USB Adapter	MODEL	WU830G
MODE	Channel 11	6dB BANDWIDTH	9 kHz
INPUT POWER (SYSTEM)	120Vac, 60 Hz	PHASE	Line (L)
ENVIRONMENTAL CONDITIONS	23 deg. C, 50%RH, 977 hPa	TESTED BY	Eric Lee

No	Freq. [MHz]	Corr. Factor (dB)	Reading Value [dB (uV)]		Emission Level [dB (uV)]		Limit [dB (uV)]		Margin (dB)	
			Q.P.	AV.	Q.P.	AV.	Q.P.	AV.	Q.P.	AV.
1	0.181	0.20	32.24	-	32.44	-	64.43	54.43	-31.99	-
2	1.080	0.30	28.00	-	28.30	-	56.00	46.00	-27.70	-
3	1.283	0.30	30.21	-	30.51	-	56.00	46.00	-25.49	-
4	1.818	0.30	30.91	-	31.21	-	56.00	46.00	-24.79	-
5	2.201	0.31	25.15	-	25.46	-	56.00	46.00	-30.54	-
6	19.897	1.10	31.78	-	32.88	-	60.00	50.00	-27.12	-

- NOTES:**
- "*": Undetectable
 - Q.P. and AV. are abbreviations of quasi-peak and average.
 - "-": The Quasi-peak reading value also meets an average limit, thus measurement with the average detector is unnecessary.
 - The emission levels of other frequencies were very low against the limit.
 - Correction Factor = Insertion loss + Cable loss
 - Margin value = Emission level - Limit value

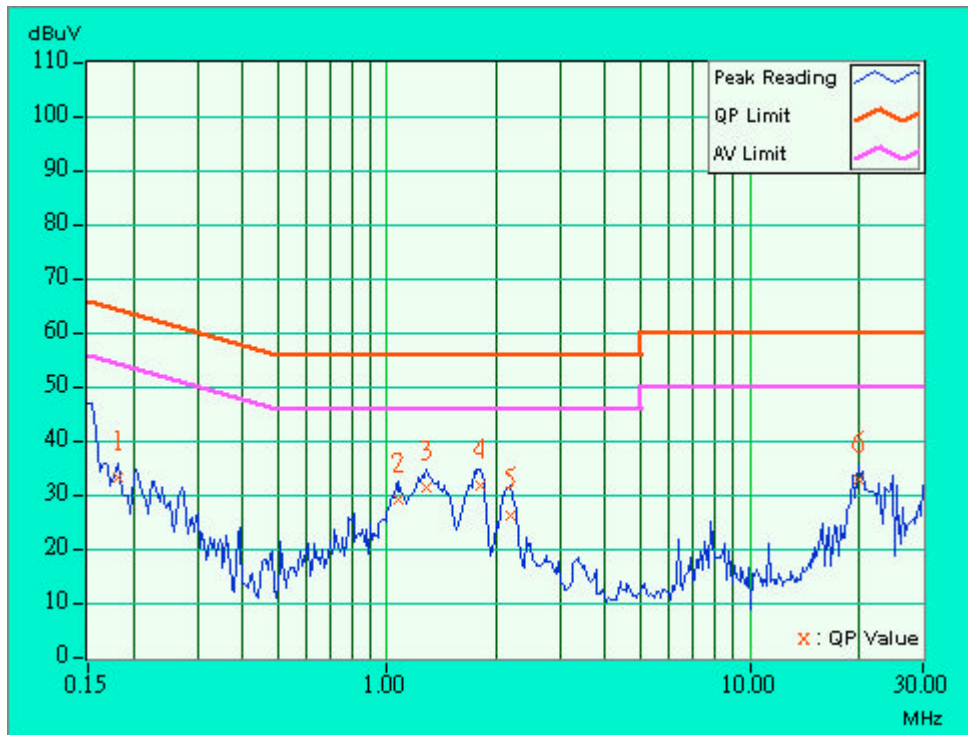



EUT	Wireless USB Adapter	MODEL	WU830G
MODE	Channel 11	6dB BANDWIDTH	9 kHz
INPUT POWER (SYSTEM)	120Vac, 60 Hz	PHASE	Neutral (N)
ENVIRONMENTAL CONDITIONS	23 deg. C, 50%RH, 977 hPa	TESTED BY	Eric Lee

No	Freq. [MHz]	Corr. Factor (dB)	Reading Value [dB (uV)]		Emission Level [dB (uV)]		Limit [dB (uV)]		Margin (dB)	
			Q.P.	AV.	Q.P.	AV.	Q.P.	AV.	Q.P.	AV.
1	0.205	0.20	32.77	-	32.97	-	63.42	53.42	-30.45	-
2	0.228	0.20	31.62	-	31.82	-	62.52	52.52	-30.70	-
3	1.259	0.30	31.22	-	31.52	-	56.00	46.00	-24.48	-
4	1.752	0.30	31.69	-	31.99	-	56.00	46.00	-24.01	-
5	2.154	0.31	27.38	-	27.69	-	56.00	46.00	-28.31	-
6	19.191	1.00	30.76	-	31.76	-	60.00	50.00	-28.24	-

- NOTES:** (1) "": Undetectable
 (2) Q.P. and AV. are abbreviations of quasi-peak and average.
 (3) "-": The Quasi-peak reading value also meets an average limit, thus measurement with the average detector is unnecessary.
 (4) The emission levels of other frequencies were very low against the limit.
 (5) Correction Factor = Insertion loss + Cable loss
 (6) Margin value = Emission level - Limit value

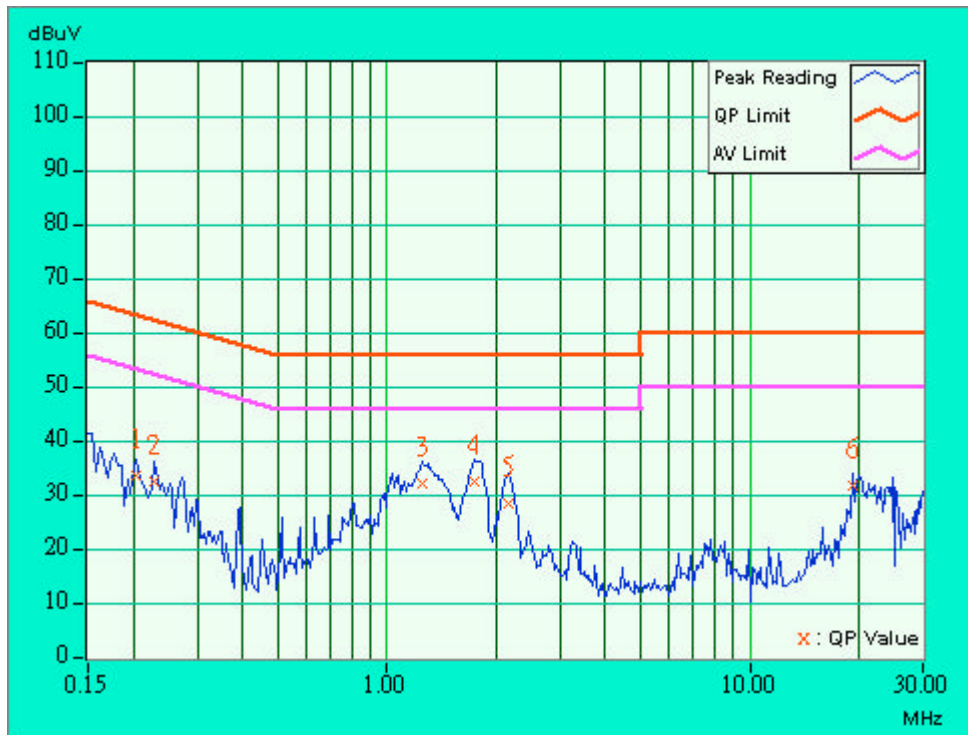



4.2 RADIATED EMISSION MEASUREMENT

4.2.1 LIMITS OF RADIATED EMISSION MEASUREMENT

Field strength limits are at the distance of 3 meters, emissions radiated outside of the specified bands, shall be according to the general radiated limits in 15.209 as following:

Frequencies (MHz)	Field Strength of Fundamental	
	uV/m	dBuV/m
30-88	100	40.0
88-216	150	43.5
216-960	200	46.0
Above 960	500	54.0

NOTE

1. The lower limit shall apply at the transition frequencies.
2. Emission level (dBuV/m) = 20 log Emission level (uV/m).
3. As shown in 15.35(b), for frequencies above 1000MHz, the field strength limits are based on average detector, however, the peak field strength of any emission shall not exceed the maximum permitted average limits, specified above by more than 20dB under any condition of modulation.



4.2.2 TEST INSTRUMENTS

DESCRIPTION & MANUFACTURER	MODEL NO.	SERIAL NO.	CALIBRATED UNTIL
HP Spectrum Analyzer	8590L	3467U00646	Jun. 29, 2004
*ADVANTEST Spectrum Analyzer	R3271A	85060311	Jun. 16, 2004
CHASE RF Pre_Amplifier	CPA9232	1010	Feb. 22, 2004
*HP Pre_Amplifier	8449B	3008A01922	Oct. 13, 2004
*ROHDE & SCHWARZ Test Receiver	ESVS 30	841977/002	Sep. 17, 2004
*CHASE Broadband Antenna	CBL6112B	2798	Apr. 16, 2004
*Schwarzbeck Horn_Antenna	BBHA9120-D1	D123	Sep. 24, 2004
SCHWARZBECK Tunable Dipole Antenna	UHAP	897	Mar. 07, 2005
SCHWARZBECK Tunable Dipole Antenna	VHAP	880	Mar. 07, 2005
*RF Switches	MP59B	1-5161-28698	Jul. 31, 2004
*RF Cable(CHASE)	CH A9525	Cable_OB_01	Jul. 31, 2004
*Software	AS60P8	NA	NA
*CHANCE MOST Antenna Tower	AT-100	CM-A007	NA
*CHANCE MOST Turn Table	TC-008	CM-T007	NA
*CORCOM AC Filter	MRI2030	024/019	NA

Note: 1. The calibration interval of the above test instruments is 12 months (36 months for Tunable Dipole Antenna) and the calibrations are traceable to NML/ROC and NIST/USA.

2. * = These equipment are used for the final measurement.
3. The horn antenna and HP preamplifier (model: 8449B) are used only for the measurement of emission frequency above 1GHz if tested.
4. The test was performed in ADT Open Site No. B.
5. The VCCI Site Registration No. is R-847.
6. The FCC Site Registration No. is 92753.
7. The CANADA Site Registration No. is IC 4284-2.



4.2.3 TEST PROCEDURES

- a. The EUT was placed on the top of a rotating table 0.8 meters above the ground at a 10 meter open area test site. The table was rotated 360 degrees to determine the position of the highest radiation.
- b. The EUT was set 3 meters away from the interference-receiving antenna, which was mounted on the top of a variable-height antenna tower.
- c. The antenna is a broadband antenna, and its height is varied from one meter to four meters above the ground to determine the maximum value of the field strength. Both horizontal and vertical polarizations of the antenna are set to make the measurement.
- d. For each suspected emission, the EUT was arranged to its worst case and then the antenna was tuned to heights from 1 meter to 4 meters and the rotatable table was turned from 0 degrees to 360 degrees to find the maximum reading.
- e. The test-receiver system was set to Peak Detect Function and Specified Bandwidth with Maximum Hold Mode.
- f. If the emission level of the EUT in peak mode was 10 dB lower than the limit specified, then testing could be stopped and the peak values of the EUT would be reported. Otherwise the emissions that did not have 10 dB margin would be re-tested one by one using peak, quasi-peak or average method as specified and then reported in a data sheet.

NOTE:

1. The resolution bandwidth and video bandwidth of test receiver/spectrum analyzer is 120kHz for Peak detection (PK) and Quasi-peak detection (QP) at frequency below 1GHz.
2. The resolution bandwidth and video bandwidth of test receiver/spectrum analyzer is 1 MHz for Peak detection at frequency above 1GHz.
3. The resolution bandwidth of test receiver/spectrum analyzer is 1 MHz and the video bandwidth is 300 Hz for Average detection (AV) at frequency above 1GHz.

4.2.4 TEST SETUP

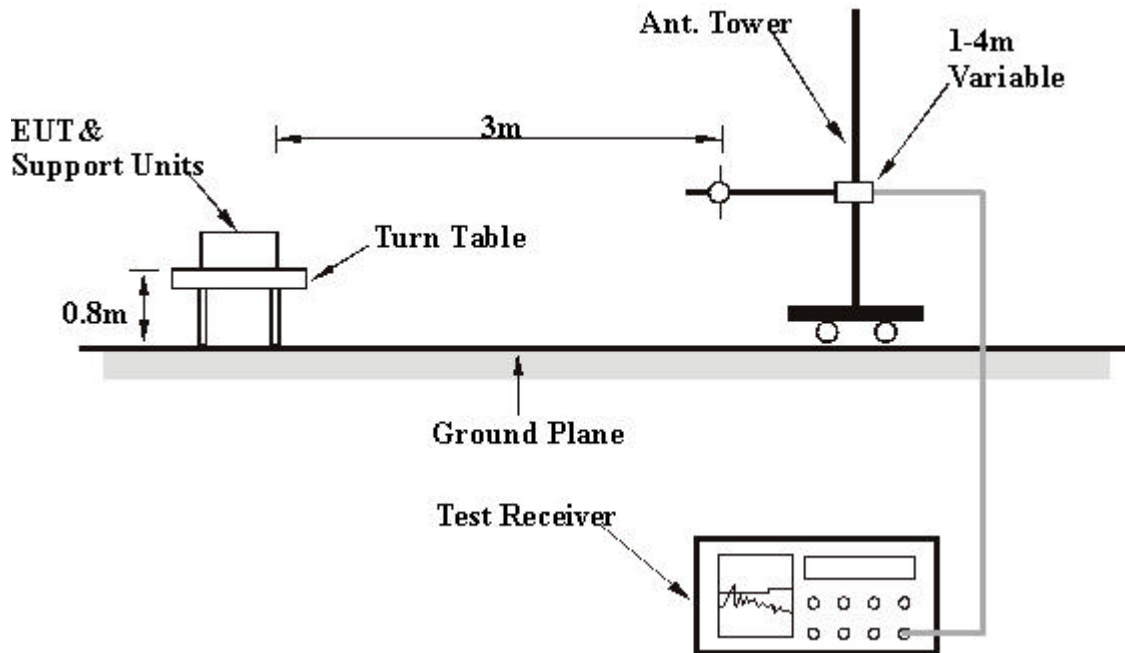

For the actual test configuration, please refer to the related item – Photographs of the Test Configuration.

4.2.5 EUT OPERATING CONDITIONS

Same as 4.1.5.



4.2.6 TEST RESULTS

EUT	Wireless USB Adapter	MODEL	WU830G
MODE	Channel 11	FREQUENCY RANGE	30-1000 MHz
INPUT POWER (SYSTEM)	120Vac, 60 Hz	DETECTOR FUNCTION	Quasi-Peak
ENVIRONMENTAL CONDITIONS	20 deg. C, 59%RH, 977 hPa	TESTED BY	Tony Chen

ANTENNA POLARITY & TEST DISTANCE: HORIZONTAL AT 3 M

No.	Freq. (MHz)	Emission Level (dBuV/m)	Limit (dBuV/m)	Margin (dB)	Antenna Height (m)	Table Angle (Degree)	Raw Value (dBuV)	Correction Factor (dB/m)
1	120.00	23.10 QP	43.50	-20.40	1.41 H	113	11.30	11.80
2	259.09	28.70 QP	46.00	-17.30	1.07 H	146	15.10	13.50
3	336.09	33.80 QP	46.00	-12.20	1.36 H	165	17.60	16.20
4	456.04	26.20 QP	46.00	-19.80	1.45 H	140	6.90	19.30
5	480.06	37.40 QP	46.00	-8.60	1.00 H	174	17.60	19.80
6	624.18	34.80 QP	46.00	-11.20	1.00 H	336	11.60	23.20
7	720.21	33.30 QP	46.00	-12.70	1.06 H	261	8.50	24.80
8	768.22	30.80 QP	46.00	-15.20	1.04 H	271	5.20	25.50
9	960.12	34.30 QP	54.00	-19.70	1.00 H	270	6.30	28.00

ANTENNA POLARITY & TEST DISTANCE: VERTICAL AT 3 M

No.	Freq. (MHz)	Emission Level (dBuV/m)	Limit (dBuV/m)	Margin (dB)	Antenna Height (m)	Table Angle (Degree)	Raw Value (dBuV)	Correction Factor (dB/m)
1	120.00	20.90 QP	43.50	-22.60	1.08 V	235	9.10	11.80
2	192.00	19.90 QP	43.50	-23.60	1.06 V	282	8.10	11.90
3	235.29	23.30 QP	46.00	-22.70	1.03 V	20	10.70	12.60
4	336.10	27.30 QP	46.00	-18.70	1.04 V	256	11.10	16.20
5	432.12	30.90 QP	46.00	-15.10	1.05 V	284	12.20	18.70
6	480.07	31.10 QP	46.00	-14.90	1.00 V	322	11.30	19.80
7	528.15	33.00 QP	46.00	-13.00	1.07 V	3	12.00	21.00
8	624.18	36.20 QP	46.00	-9.80	1.00 V	44	13.00	23.20
9	720.20	33.80 QP	46.00	-12.20	1.07 V	49	9.10	24.80
10	816.24	32.80 QP	46.00	-13.20	1.00 V	354	6.50	26.30

- REMARKS:**
1. Emission level(dBuV/m)=Raw Value(dBuV) + Correction Factor(dB)
 2. Correction Factor(dB/m) = Antenna Factor (dB/m) + Cable Factor (dB)
 3. The other emission levels were very low against the limit.
 4. Margin value = Emission level – Limit value.



4.2.7 TEST RESULTS - DSSS

EUT	Wireless USB Adapter	MODEL	WU830G
MODE	Channel 1	FREQUENCY RANGE	1000~25000MHz
INPUT POWER (SYSTEM)	120Vac, 60 Hz	DETECTOR FUNCTION	Peak(PK) Average(AV)
ENVIRONMENTAL CONDITIONS	15 deg. C, 69%RH, 977 hPa	TESTED BY	Tony Chen

ANTENNA POLARITY & TEST DISTANCE: HORIZONTAL AT 3 M

No.	Freq. (MHz)	Emission Level (dBuV/m)	Limit (dBuV/m)	Margin (dB)	Antenna Height (m)	Table Angle (Degree)	Raw Value (dBuV)	Correction Factor (dB/m)
1	1663.00	44.80 PK	74.00	-29.20	1.40 H	299	17.00	27.90
2	2386.00	61.80 PK	74.00	-12.20	1.87 H	298	32.00	29.80
2	2386.00	52.80 AV	54.00	-1.20	1.87 H	298	23.00	29.80
3	2390.00	63.90 PK	74.00	-10.10	1.27 H	236	34.10	29.80
3	2390.00	53.20 AV	54.00	-0.80	1.27 H	236	23.40	29.80
4	*2412.00	115.60 PK			1.79 H	297	85.70	29.90
4	*2412.00	108.40 AV			1.79 H	297	78.50	29.90
5	4824.00	53.90 PK	74.00	-20.10	1.76 H	310	17.60	36.20
5	4824.00	40.90 AV	54.00	-13.10	1.76 H	310	4.60	36.20
6	7236.00	52.00 PK	74.00	-22.00	1.38 H	294	10.30	41.70
6	7236.00	41.30 AV	54.00	-12.70	1.38 H	294	-0.30	41.70
7	9648.00	55.70 PK	74.00	-18.30	1.68 H	316	10.80	44.90
7	9648.00	44.90 AV	54.00	-9.10	1.68 H	316	0.00	44.90

ANTENNA POLARITY & TEST DISTANCE: VERTICAL AT 3 M

No.	Freq. (MHz)	Emission Level (dBuV/m)	Limit (dBuV/m)	Margin (dB)	Antenna Height (m)	Table Angle (Degree)	Raw Value (dBuV)	Correction Factor (dB/m)
1	1663.00	43.70 PK	74.00	-30.30	1.60 V	308	15.80	27.90
2	2386.00	55.60 PK	74.00	-18.40	1.77 V	294	25.80	29.80
2	2386.00	47.10 AV	54.00	-6.90	1.77 V	294	17.30	29.80
3	2390.00	57.60 PK	74.00	-16.40	1.38 V	208	27.80	29.80
3	2390.00	47.90 AV	54.00	-6.10	1.38 V	208	18.10	29.80
4	*2412.00	110.20 PK			1.65 V	300	80.30	29.90
4	*2412.00	103.10 AV			1.65 V	300	73.20	29.90
5	4824.00	51.00 PK	74.00	-23.00	2.08 V	288	14.80	36.20
5	4824.00	38.70 AV	54.00	-15.30	2.08 V	288	2.50	36.20
6	7236.00	48.20 PK	74.00	-25.80	2.11 V	195	6.50	41.70
7	9648.00	55.60 PK	74.00	-18.40	1.39 V	245	10.70	44.90
7	9648.00	45.90 AV	54.00	-8.10	1.39 V	245	1.00	44.90

- REMARKS:**
1. Emission level(dBuV/m)=Raw Value(dBuV) + Correction Factor(dB)
 2. Correction Factor(dB/m) = Antenna Factor (dB/m) + Cable Factor (dB)
 3. The other emission levels were very low against the limit.
 4. Margin value = Emission level – Limit value.
 5. The limit value is defined as per 15.247
 6. “ * “ : Fundamental frequency



EUT	Wireless USB Adapter	MODEL	WU830G
MODE	Channel 6	FREQUENCY RANGE	1000~25000MHz
INPUT POWER (SYSTEM)	120Vac, 60 Hz	DETECTOR FUNCTION	Peak(PK) Average (AV)
ENVIRONMENTAL CONDITIONS	15 deg. C, 69%RH, 977 hPa	TESTED BY	Tony Chen

ANTENNA POLARITY & TEST DISTANCE: HORIZONTAL AT 3 M

No.	Freq. (MHz)	Emission Level (dBuV/m)	Limit (dBuV/m)	Margin (dB)	Antenna Height (m)	Table Angle (Degree)	Raw Value (dBuV)	Correction Factor (dB/m)
1	1699.00	48.60 PK	74.00	-25.40	1.73 H	301	20.70	27.90
2	*2437.00	117.20 PK			1.79 H	297	87.20	30.00
2	*2437.00	110.00 AV			1.79 H	297	80.00	30.00
3	4874.00	55.20 PK	74.00	-18.80	1.49 H	300	18.70	36.50
3	4874.00	42.00 AV	54.00	-12.00	1.49 H	300	5.50	36.50
4	7311.00	57.30 PK	74.00	-16.70	1.47 H	307	15.50	41.80
4	7311.00	46.60 AV	54.00	-7.40	1.47 H	307	4.90	41.80
5	9748.00	56.60 PK	74.00	-17.40	1.52 H	310	11.90	44.60
5	9748.00	50.20 AV	54.00	-3.80	1.52 H	310	5.60	44.60

ANTENNA POLARITY & TEST DISTANCE: VERTICAL AT 3 M

No.	Freq. (MHz)	Emission Level (dBuV/m)	Limit (dBuV/m)	Margin (dB)	Antenna Height (m)	Table Angle (Degree)	Raw Value (dBuV)	Correction Factor (dB/m)
1	1687.00	38.60 PK	74.00	-35.40	1.12 V	343	10.70	27.90
2	*2437.00	111.30 PK			1.58 V	302	81.30	30.00
2	*2437.00	104.00 AV			1.58 V	302	74.00	30.00
3	4874.00	53.70 PK	74.00	-20.30	1.90 V	287	17.20	36.50
3	4874.00	41.80 AV	54.00	-12.20	1.90 V	287	5.40	36.50
4	7311.00	50.10 PK	74.00	-23.90	1.06 V	296	8.40	41.80
5	9748.00	62.20 PK	74.00	-11.80	1.13 V	302	17.60	44.60
5	9748.00	53.70 AV	54.00	-0.30	1.13 V	302	9.10	44.60

- REMARKS:**
1. Emission level(dBuV/m)=Raw Value(dBuV) + Correction Factor(dB)
 2. Correction Factor(dB/m) = Antenna Factor (dB/m) + Cable Factor (dB)
 3. The other emission levels were very low against the limit.
 4. Margin value = Emission level – Limit value.
 5. The limit value is defined as per 15.247
 6. “ * “ : Fundamental frequency



EUT	Wireless USB Adapter	MODEL	WU830G
MODE	Channel 11	FREQUENCY RANGE	1000~25000MHz
INPUT POWER (SYSTEM)	120Vac, 60 Hz	DETECTOR FUNCTION	Peak(PK) Average (AV)
ENVIRONMENTAL CONDITIONS	15 deg. C, 69%RH, 977 hPa	TESTED BY	Tony Chen

ANTENNA POLARITY & TEST DISTANCE: HORIZONTAL AT 3 M

No.	Freq. (MHz)	Emission Level (dBuV/m)	Limit (dBuV/m)	Margin (dB)	Antenna Height (m)	Table Angle (Degree)	Raw Value (dBuV)	Correction Factor (dB/m)
1	*2462.00	114.40 PK			1.40 H	306	84.30	30.10
1	*2462.00	107.60 AV			1.40 H	306	77.50	30.10
2	2483.50	63.60 PK	74.00	-10.40	1.63 H	360	33.40	30.10
2	2483.50	53.50 AV	54.00	-0.50	1.63 H	360	23.40	30.10
3	2489.00	57.20 PK	74.00	-16.80	1.42 H	307	27.00	30.20
3	2489.00	47.90 AV	54.00	-6.10	1.42 H	307	17.80	30.20
4	4924.00	49.60 PK	74.00	-24.40	1.59 H	301	12.90	36.70
5	7386.00	51.80 PK	74.00	-22.20	1.33 H	307	10.00	41.80
5	7386.00	43.20 AV	54.00	-10.80	1.33 H	307	1.30	41.80
6	9848.00	53.70 PK	74.00	-20.30	1.48 H	304	9.30	44.40
6	9848.00	46.00 AV	54.00	-8.00	1.48 H	304	1.70	44.40

ANTENNA POLARITY & TEST DISTANCE: VERTICAL AT 3 M

No.	Freq. (MHz)	Emission Level (dBuV/m)	Limit (dBuV/m)	Margin (dB)	Antenna Height (m)	Table Angle (Degree)	Raw Value (dBuV)	Correction Factor (dB/m)
1	*2462.00	111.60 PK			1.55 V	307	81.50	30.10
1	*2462.00	104.70 AV			1.55 V	307	74.70	30.10
2	2483.50	60.30 PK	74.00	-13.70	1.00 V	307	30.20	30.10
2	2483.50	50.60 AV	54.00	-3.40	1.00 V	307	20.50	30.10
3	2489.00	57.70 PK	74.00	-16.30	1.55 V	309	27.50	30.20
3	2489.00	48.00 AV	54.00	-6.00	1.55 V	309	17.80	30.20
4	4924.00	50.30 PK	74.00	-23.70	1.89 V	124	13.60	36.70
5	7386.00	49.20 PK	74.00	-24.80	1.10 V	252	7.30	41.80
6	9848.00	57.50 PK	74.00	-16.50	1.54 V	277	13.20	44.40
6	9848.00	51.20 AV	54.00	-2.80	1.54 V	277	6.80	44.40

- REMARKS:**
1. Emission level(dBuV/m)=Raw Value(dBuV) + Correction Factor(dB)
 2. Correction Factor(dB/m) = Antenna Factor (dB/m) + Cable Factor (dB)
 3. The other emission levels were very low against the limit.
 4. Margin value = Emission level – Limit value.
 5. The limit value is defined as per 15.247
 6. “ * “ : Fundamental frequency



4.2.8 TEST RESULTS -OFDM

EUT	Wireless USB Adapter	MODEL	WU830G
MODE	Channel 1	FREQUENCY RANGE	1000~25000MHz
INPUT POWER (SYSTEM)	120Vac, 60 Hz	DETECTOR FUNCTION	Peak(PK) Average(AV)
ENVIRONMENTAL CONDITIONS	15 deg. C, 69%RH, 977 hPa	TESTED BY	Tony Chen

ANTENNA POLARITY & TEST DISTANCE: HORIZONTAL AT 3 M

No.	Freq. (MHz)	Emission Level (dBuV/m)	Limit (dBuV/m)	Margin (dB)	Antenna Height (m)	Table Angle (Degree)	Raw Value (dBuV)	Correction Factor (dB/m)
1	1663.00	44.40 PK	74.00	-29.60	1.79 H	300	16.50	27.90
2	2390.00	62.40 PK	74.00	-11.60	1.46 H	300	32.60	29.80
2	2390.00	52.90 AV	54.00	-1.10	1.46 H	300	23.10	29.80
3	*2412.00	109.10 PK			1.82 H	294	79.20	29.90
3	*2412.00	100.90 AV			1.82 H	294	71.00	29.90
4	2867.00	45.50 PK	74.00	-28.50	1.83 H	295	14.30	31.20
5	4824.00	46.50 PK	74.00	-27.50	1.52 H	296	10.30	36.20
6	7236.00	49.70 PK	74.00	-24.30	1.33 H	308	8.00	41.70
7	9648.00	55.60 PK	74.00	-18.40	1.49 H	319	10.70	44.90
7	9648.00	44.90 AV	54.00	-9.10	1.49 H	319	0.00	44.90

ANTENNA POLARITY & TEST DISTANCE: VERTICAL AT 3 M

No.	Freq. (MHz)	Emission Level (dBuV/m)	Limit (dBuV/m)	Margin (dB)	Antenna Height (m)	Table Angle (Degree)	Raw Value (dBuV)	Correction Factor (dB/m)
1	2390.00	57.00 PK	74.00	-17.00	1.36 V	208	27.20	29.80
1	2390.00	46.20 AV	54.00	-7.80	1.36 V	208	16.40	29.80
2	*2412.00	104.20 PK			1.63 V	304	74.30	29.90
2	*2412.00	94.20 AV			1.63 V	304	64.30	29.90
3	4824.00	42.90 PK	74.00	-31.10	1.30 V	87	6.70	36.20
4	7236.00	48.50 PK	74.00	-25.50	1.36 V	75	6.80	41.70
5	9648.00	56.20 PK	74.00	-17.80	1.31 V	300	11.30	44.90
5	9648.00	44.90 AV	54.00	-9.10	1.31 V	300	0.00	44.90

- REMARKS:**
1. Emission level(dBuV/m)=Raw Value(dBuV) + Correction Factor(dB)
 2. Correction Factor(dB/m) = Antenna Factor (dB/m) + Cable Factor (dB)
 3. The other emission levels were very low against the limit.
 4. Margin value = Emission level – Limit value.
 5. The limit value is defined as per 15.247
 6. “ * “ : Fundamental frequency



EUT	Wireless USB Adapter	MODEL	WU830G
MODE	Channel 6	FREQUENCY RANGE	1000~25000MHz
INPUT POWER (SYSTEM)	120Vac, 60 Hz	DETECTOR FUNCTION	Peak(PK) Average (AV)
ENVIRONMENTAL CONDITIONS	15 deg. C, 69%RH, 977 hPa	TESTED BY	Tony Chen

ANTENNA POLARITY & TEST DISTANCE: HORIZONTAL AT 3 M

No.	Freq. (MHz)	Emission Level (dBuV/m)	Limit (dBuV/m)	Margin (dB)	Antenna Height (m)	Table Angle (Degree)	Raw Value (dBuV)	Correction Factor (dB/m)
1	1652.00	40.00 PK	74.00	-34.00	1.37 H	247	12.20	27.80
2	*2437.00	111.20 PK			1.79 H	301	81.20	30.00
2	*2437.00	101.20 AV			1.79 H	301	71.20	30.00
3	4874.00	45.30 PK	74.00	-28.70	1.24 H	313	8.90	36.50
4	7311.00	48.90 PK	74.00	-25.10	1.29 H	306	7.20	41.80
5	9748.00	54.40 PK	74.00	-19.60	1.43 H	320	9.80	44.60
5	9748.00	44.10 AV	54.00	-9.90	1.43 H	320	-0.60	44.60

ANTENNA POLARITY & TEST DISTANCE: VERTICAL AT 3 M

No.	Freq. (MHz)	Emission Level (dBuV/m)	Limit (dBuV/m)	Margin (dB)	Antenna Height (m)	Table Angle (Degree)	Raw Value (dBuV)	Correction Factor (dB/m)
1	1652.00	41.30 PK	74.00	-32.70	1.71 V	352	13.50	27.80
2	*2437.00	105.20 PK			1.60 V	301	75.20	30.00
2	*2437.00	95.80 AV			1.60 V	301	65.80	30.00
3	4874.00	43.50 PK	74.00	-30.50	1.36 V	20	7.00	36.50
4	7311.00	49.60 PK	74.00	-24.40	1.44 V	314	7.90	41.80
5	9748.00	55.60 PK	74.00	-18.40	1.39 V	292	10.90	44.60
5	9748.00	43.70 AV	54.00	-10.30	1.39 V	292	-0.90	44.60

- REMARKS:**
1. Emission level(dBuV/m)=Raw Value(dBuV) + Correction Factor(dB)
 2. Correction Factor(dB/m) = Antenna Factor (dB/m) + Cable Factor (dB)
 3. The other emission levels were very low against the limit.
 4. Margin value = Emission level – Limit value.
 5. The limit value is defined as per 15.247
 6. “ * “ : Fundamental frequency



EUT	Wireless USB Adapter	MODEL	WU830G
MODE	Channel 11	FREQUENCY RANGE	1000~25000MHz
INPUT POWER (SYSTEM)	120Vac, 60 Hz	DETECTOR FUNCTION	Peak(PK) Average (AV)
ENVIRONMENTAL CONDITIONS	15 deg. C, 69%RH, 977 hPa	TESTED BY	Tony Chen

ANTENNA POLARITY & TEST DISTANCE: HORIZONTAL AT 3 M

No.	Freq. (MHz)	Emission Level (dBuV/m)	Limit (dBuV/m)	Margin (dB)	Antenna Height (m)	Table Angle (Degree)	Raw Value (dBuV)	Correction Factor (dB/m)
1	1736.00	47.70 PK	74.00	-26.30	1.79 H	297	19.70	28.00
2	*2462.00	110.70 PK			1.75 H	301	80.70	30.10
2	*2462.00	101.40 AV			1.75 H	301	71.30	30.10
3	2483.50	62.60 PK	74.00	-11.40	1.28 H	216	32.40	30.10
3	2483.50	53.60 AV	54.00	-0.40	1.28 H	216	23.40	30.10
4	4924.00	46.70 PK	74.00	-27.30	1.53 H	297	10.00	36.70
5	7386.00	49.00 PK	74.00	-25.00	1.22 H	262	7.10	41.80
6	9848.00	53.50 PK	74.00	-20.50	1.35 H	310	9.20	44.40
6	9848.00	42.40 AV	54.00	-11.60	1.35 H	310	-2.00	44.40

ANTENNA POLARITY & TEST DISTANCE: VERTICAL AT 3 M

No.	Freq. (MHz)	Emission Level (dBuV/m)	Limit (dBuV/m)	Margin (dB)	Antenna Height (m)	Table Angle (Degree)	Raw Value (dBuV)	Correction Factor (dB/m)
1	1736.00	41.60 PK	74.00	-32.40	1.38 V	226	13.60	28.00
2	*2462.00	104.20 PK			2.04 V	300	74.20	30.10
2	*2462.00	94.70 AV			2.04 V	300	64.70	30.10
3	2483.50	56.40 PK	74.00	-17.60	2.03 V	222	26.20	30.10
3	2483.50	46.90 AV	54.00	-7.10	2.03 V	222	16.70	30.10
4	4924.00	43.10 PK	74.00	-30.90	1.56 V	301	6.40	36.70
5	7386.00	47.50 PK	74.00	-26.50	1.61 V	285	5.60	41.80
6	9848.00	51.40 PK	74.00	-22.60	1.17 V	232	7.10	44.40
6	9848.00	41.50 AV	54.00	-12.50	1.17 V	232	-2.80	44.40

- REMARKS:**
1. Emission level(dBuV/m)=Raw Value(dBuV) + Correction Factor(dB)
 2. Correction Factor(dB/m) = Antenna Factor (dB/m) + Cable Factor (dB)
 3. The other emission levels were very low against the limit.
 4. Margin value = Emission level – Limit value.
 5. The limit value is defined as per 15.247
 6. “ * “ : Fundamental frequency



4.3 6dB BANDWIDTH MEASUREMENT

4.3.1 LIMITS OF 6dB BANDWIDTH MEASUREMENT

The minimum of 6dB Bandwidth Measurement is 0.5 MHz.

4.3.2 TEST INSTRUMENTS

Description & Manufacturer	Model No.	Serial No.	Calibrated Until
R&S SPECTRUM ANALYZER	FSP40	100037	May. 06, 2004

NOTE:

- 1.The measurement uncertainty is less than +/- 2.6dB, which is calculated as per the NAMAS document NIS81.
- 2.The calibration interval of the above test instruments is 12 months and the calibrations are traceable to NML/ROC and NIST/USA.

4.3.3 TEST PROCEDURE

The transmitter output was connected to the spectrum analyzer through an attenuator. The bandwidth of the fundamental frequency was measured by spectrum analyzer with 100 kHz RBW and 100 kHz VBW. The 6 dB bandwidth is defined as the total spectrum the power of which is higher than peak power minus 6 dB.

4.3.4 TEST SETUP

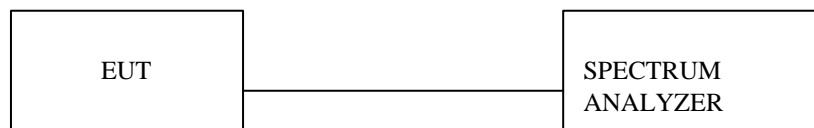

For the actual test configuration, please refer to the related Item – Photographs of the Test Configuration.

4.3.5 EUT OPERATING CONDITIONS

The software provided by client to enable the EUT under transmission condition continuously at lowest, middle and highest channel frequencies individually.



4.3.6 TEST RESULTS-DSSS

EUT	Wireless USB Adapter		
MODEL	WU830G	ENVIRONMENTAL CONDITIONS	17 deg. C, 60%RH, 977 hPa
INPUT POWER (SYSTEM)	120Vac, 60 Hz	TESTED BY	Tony Chen

CHANNEL	CHANNEL FREQUENCY (MHz)	6 dB BANDWIDTH (MHz)	MINIMUM LIMIT (MHz)	PASS/FAIL
1	2412	11.60	0.5	PASS
6	2437	10.85	0.5	PASS
11	2462	10.90	0.5	PASS



CH1

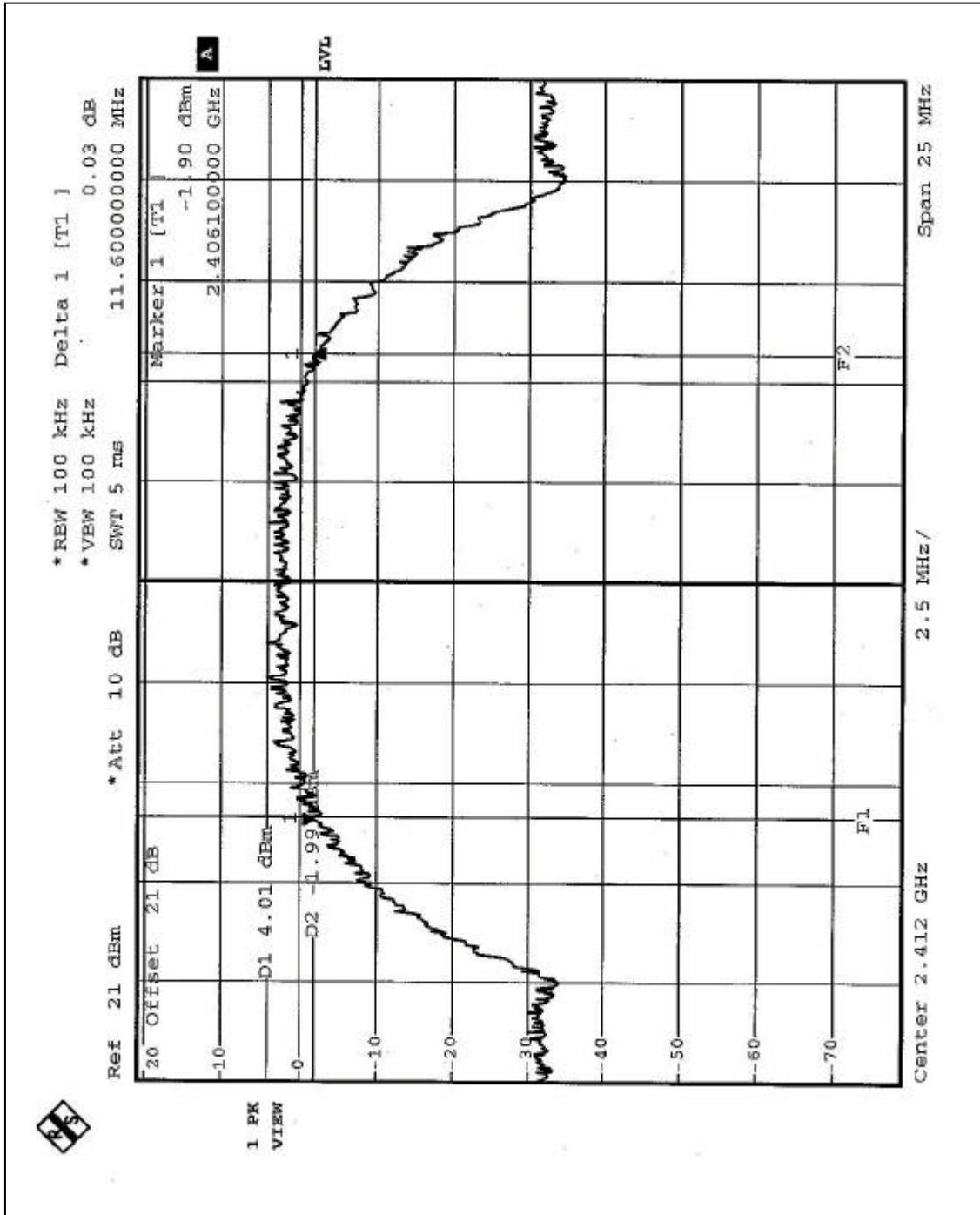



CH6

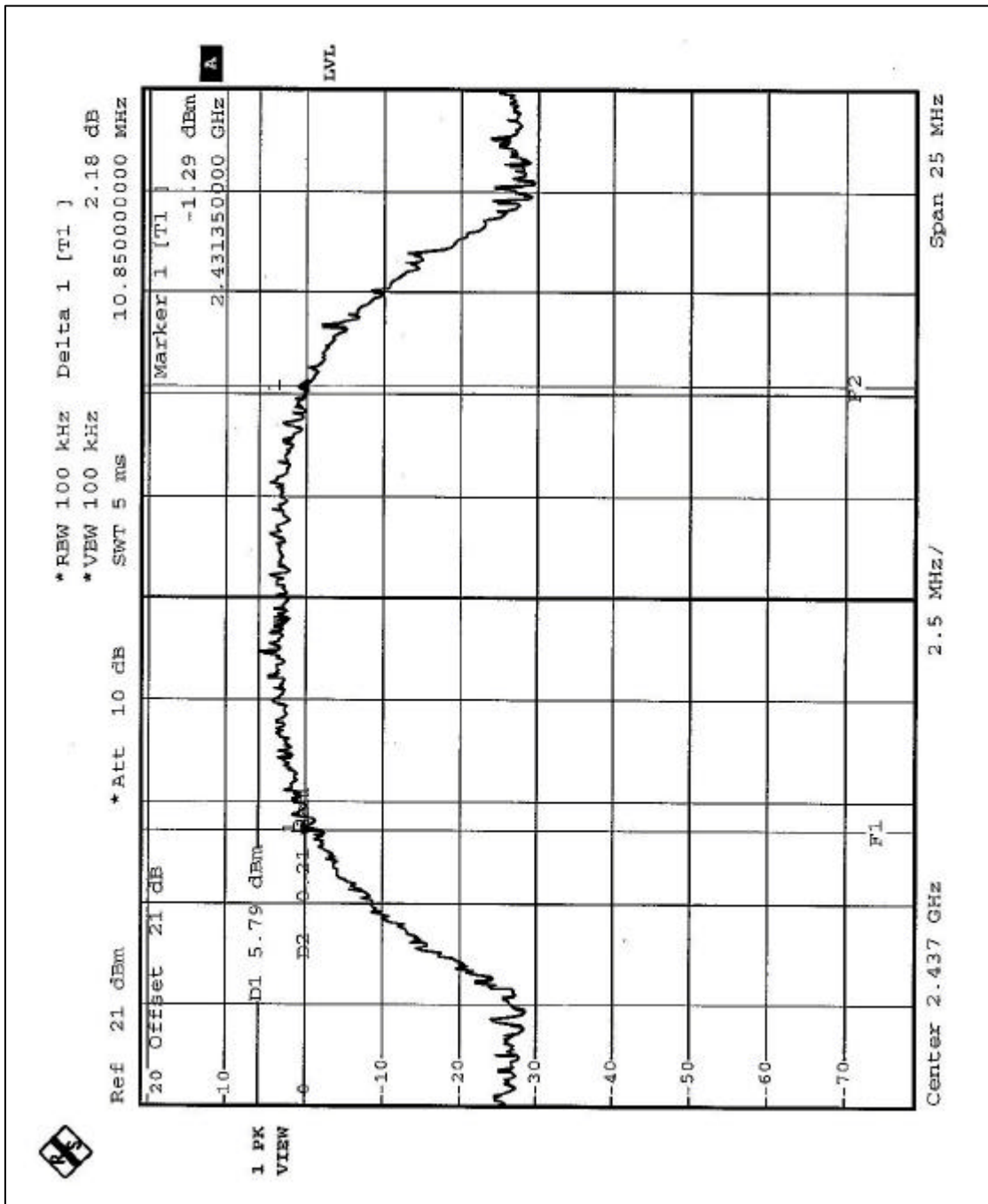



CH11

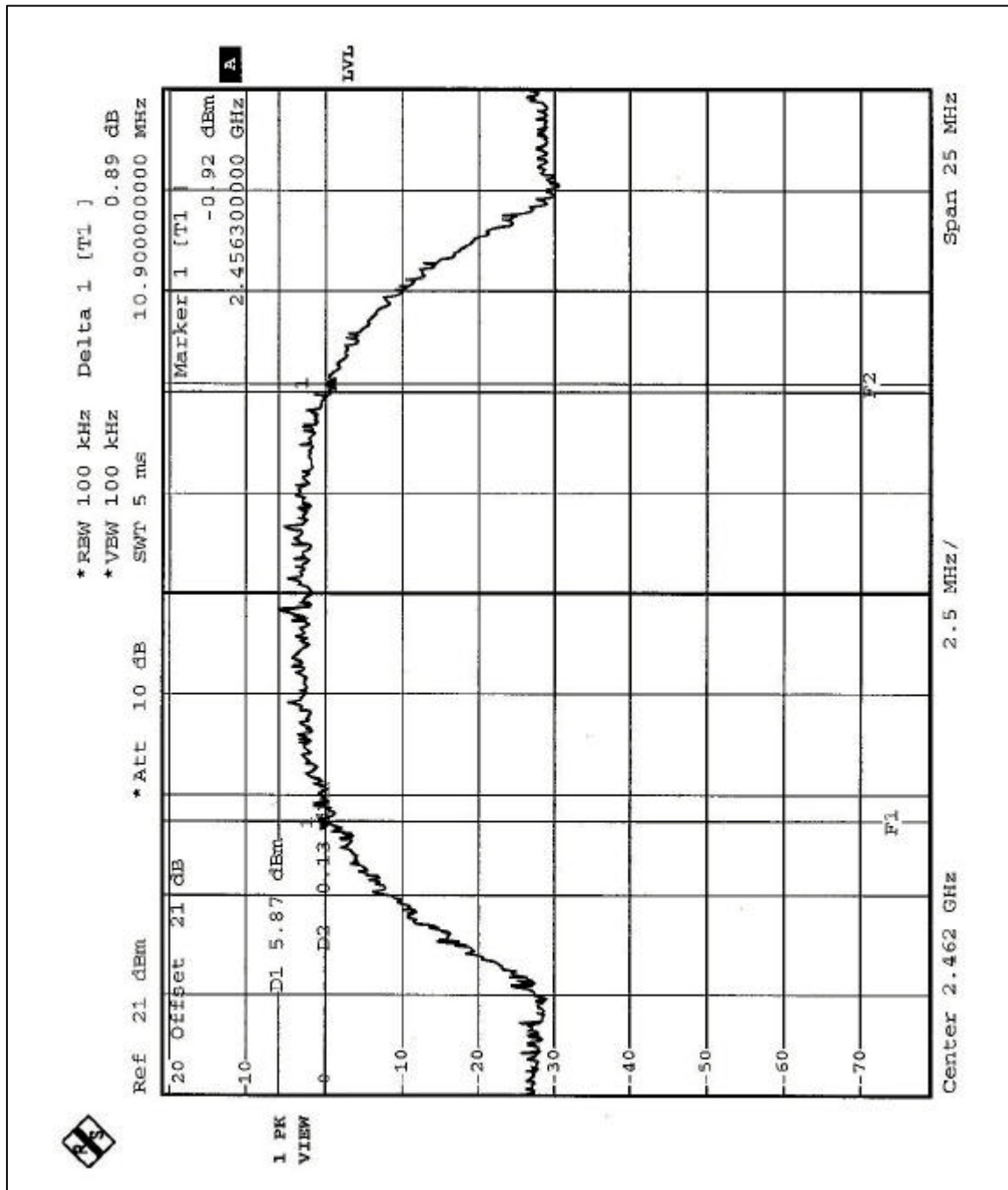



4.3.7 TEST RESULTS-OFDM

EUT	Wireless USB Adapter		
MODEL	WU830G	ENVIRONMENTAL CONDITIONS	17 deg. C, 60%RH, 977 hPa
INPUT POWER (SYSTEM)	120Vac, 60 Hz	TESTED BY	Tony Chen

CHANNEL	CHANNEL FREQUENCY (MHz)	6 dB BANDWIDTH (MHz)	MINIMUM LIMIT (MHz)	PASS/FAIL
1	2412	16.60	0.5	PASS
6	2437	16.60	0.5	PASS
11	2462	16.60	0.5	PASS



CH1

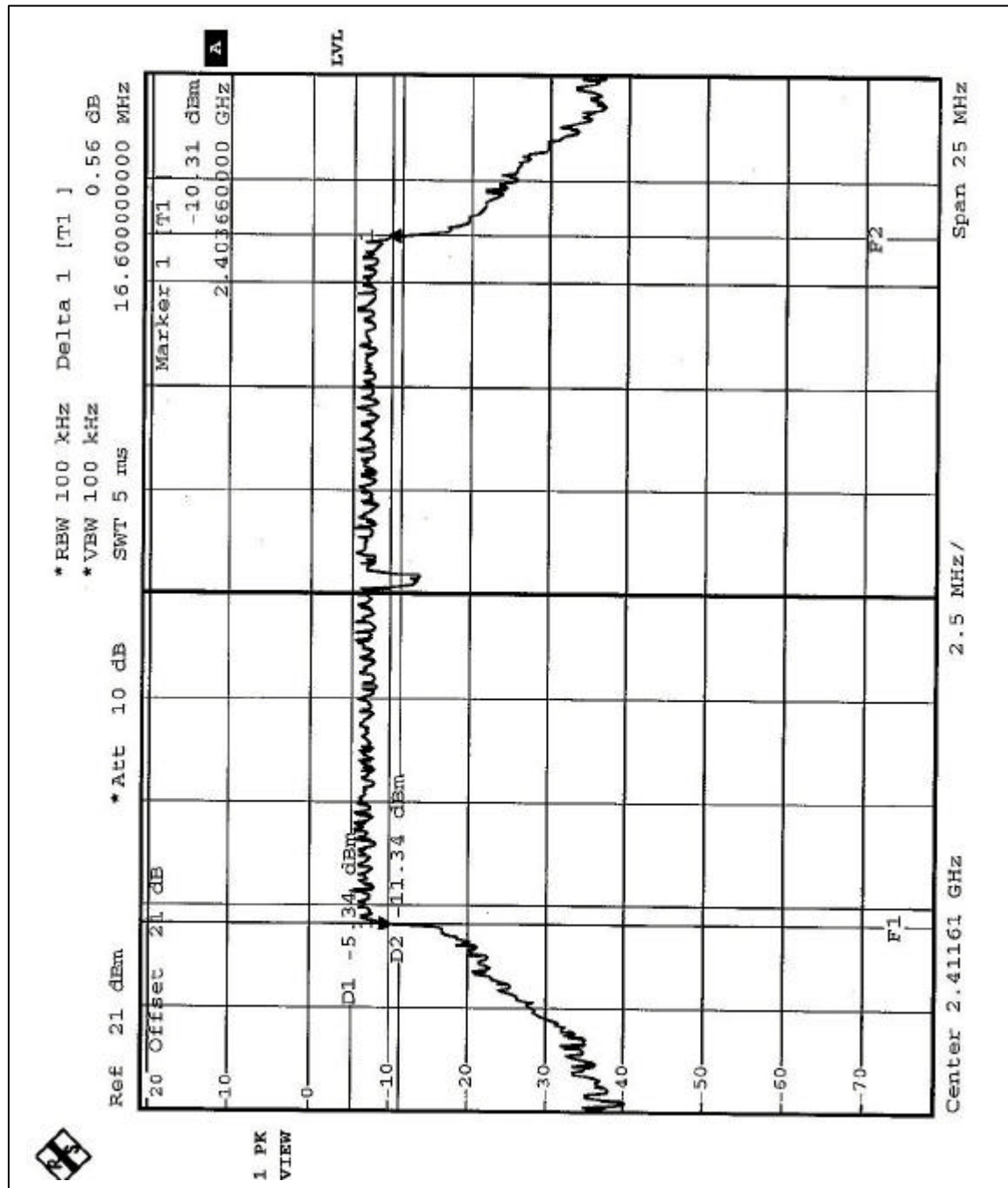



CH6

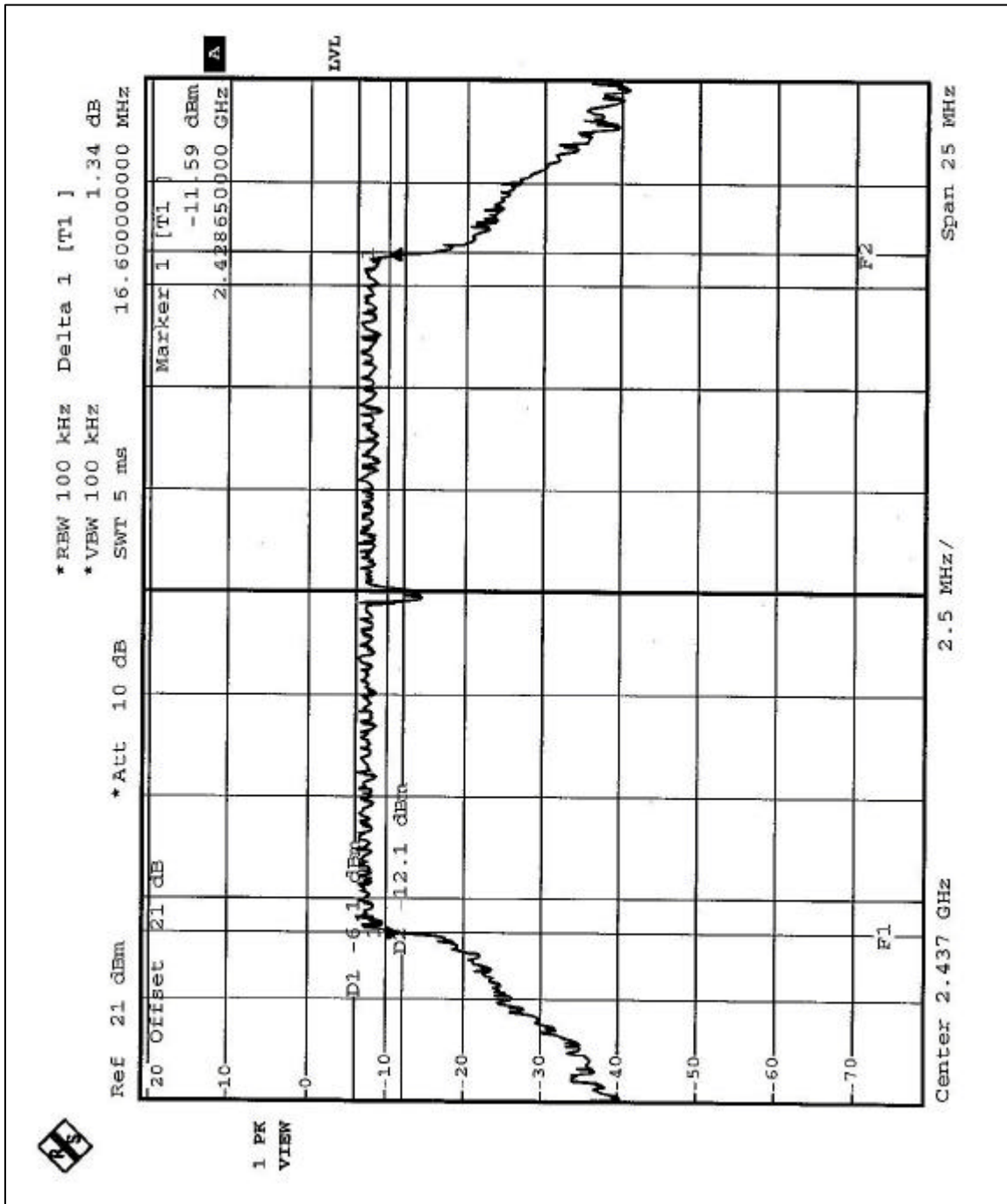



CH11

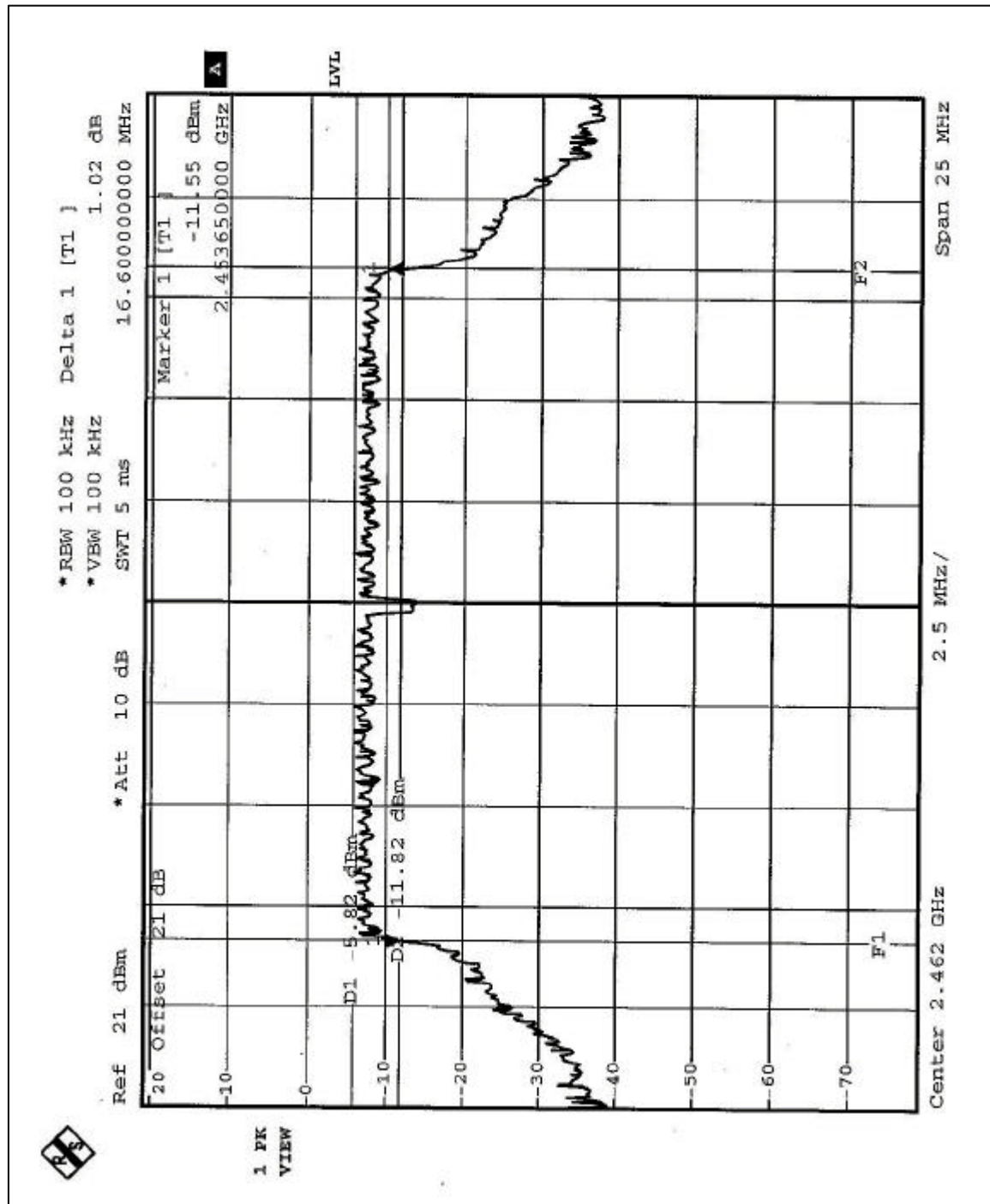



4.4 MAXIMUM PEAK OUTPUT POWER

4.4.1 LIMITS OF MAXIMUM PEAK OUTPUT POWER MEASUREMENT

The Maximum Peak Output Power Measurement is 30dBm.

4.4.2 TEST INSTRUMENTS

Description & Manufacturer	Model No.	Serial No.	Calibrated Until
R&S SPECTRUM ANALYZER	FSP40	100037	May 06, 2004
R&S SIGNAL GENERATOR	SMP04	100011	May 28, 2004
TEKTRONIX OSCILLOSCOPE	TDS 220	B048470	Mar. 05, 2004
NARDA DETECTOR	4503A	FSCM99899	NA

NOTE:

The calibration interval of the above test instruments is 12 months and the calibrations are traceable to NML/ROC and NIST/USA.

4.4.3 TEST PROCEDURES

1. A detector was used on the output port of the EUT. An oscilloscope was used to read the peak response of the detector.
2. Replaced the EUT by the signal generator. The center frequency of the S.G was adjusted to the center frequency of the measured channel.
3. Adjusted the power to have the same peak reading on oscilloscope. Record the power level.

4.4.4 TEST SETUP

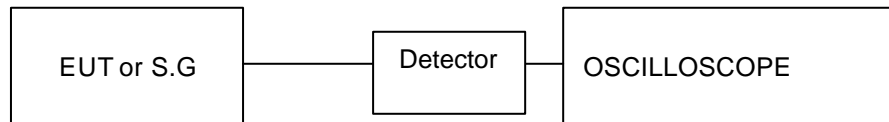

4.4.5 EUT OPERATING CONDITIONS

Same as Item 4.3.5



4.4.6 TEST RESULTS- DSSS

EUT	Wireless USB Adapter		
MODEL	WU830G	ENVIRONMENTAL CONDITIONS	17 deg. C, 60%RH, 977 hPa
INPUT POWER (SYSTEM)	120Vac, 60 Hz	TESTED BY	Tony Chen

CHANNEL	CHANNEL FREQUENCY (MHz)	PEAK POWER OUTPUT (dBm)	PEAK POWER LIMIT (dBm)	PASS/FAIL
1	2412	15.12	30	PASS
6	2437	17.35	30	PASS
11	2462	17.30	30	PASS

4.4.7 TEST RESULTS- OFDM

EUT	Wireless USB Adapter		
MODEL	WU830G	ENVIRONMENTAL CONDITIONS	17 deg. C, 60%RH, 977 hPa
INPUT POWER (SYSTEM)	120Vac, 60 Hz	TESTED BY	Tony Chen

CHANNEL	CHANNEL FREQUENCY (MHz)	PEAK POWER OUTPUT (dBm)	PEAK POWER LIMIT (dBm)	PASS/FAIL
1	2412	13.21	30	PASS
6	2437	12.93	30	PASS
11	2462	13.21	30	PASS



4.5 POWER SPECTRAL DENSITY MEASUREMENT

4.5.1 LIMITS OF POWER SPECTRAL DENSITY MEASUREMENT

The Maximum of Power Spectral Density Measurement is 8dBm.

4.5.2 TEST INSTRUMENTS

Description & Manufacturer	Model No.	Serial No.	Calibrated Until
R&S SPECTRUM ANALYZER	FSP40	100037	May. 06, 2004

NOTE:

- 1.The measurement uncertainty is less than +/- 2.6dB, which is calculated as per the NAMAS document NIS81.
- 2.The calibration interval of the above test instruments is 12 months and the calibrations are traceable to NML/ROC and NIST/USA.

4.5.3 TEST PROCEDURE

The transmitter output was connected to the spectrum analyzer through an attenuator, the bandwidth of the fundamental frequency was measured with the spectrum analyzer using 3 kHz RBW and 30 kHz VBW, set sweep time=span/3kHz. The power spectral density was measured and recorded. The sweep time is allowed to be longer than span/3KHz for a full response of the mixer in the spectrum analyzer.

4.5.4 TEST SETUP

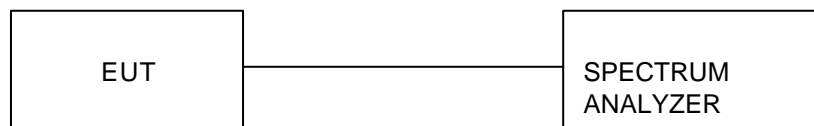

4.5.5 EUT OPERATING CONDITIONS

Same as 4.3.5



4.5.6 TEST RESULTS-DSSS

EUT	Wireless USB Adapter		
MODEL	WU830G	ENVIRONMENTAL CONDITIONS	17 deg. C, 60%RH, 977 hPa
INPUT POWER (SYSTEM)	120Vac, 60 Hz	TESTED BY	Tony Chen

CHANNEL NUMBER	CHANNEL FREQUENCY (MHz)	RF POWER LEVEL IN 3 KHz BW (dBm)	MAXIMUM LIMIT (dBm)	PASS/FAIL
1	2412	-0.71	8	PASS
6	2437	1.14	8	PASS
11	2462	-0.67	8	PASS



CH1

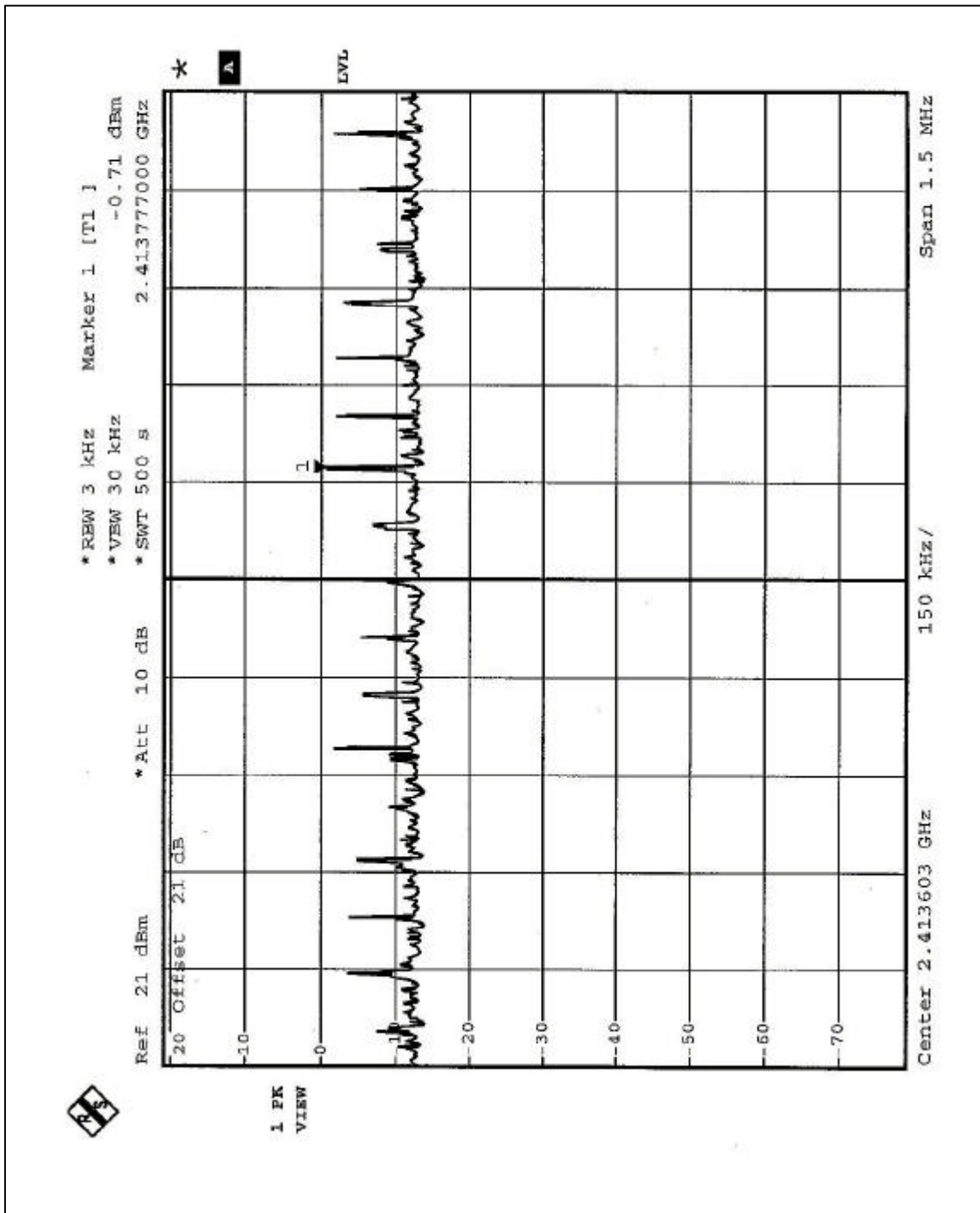



CH6

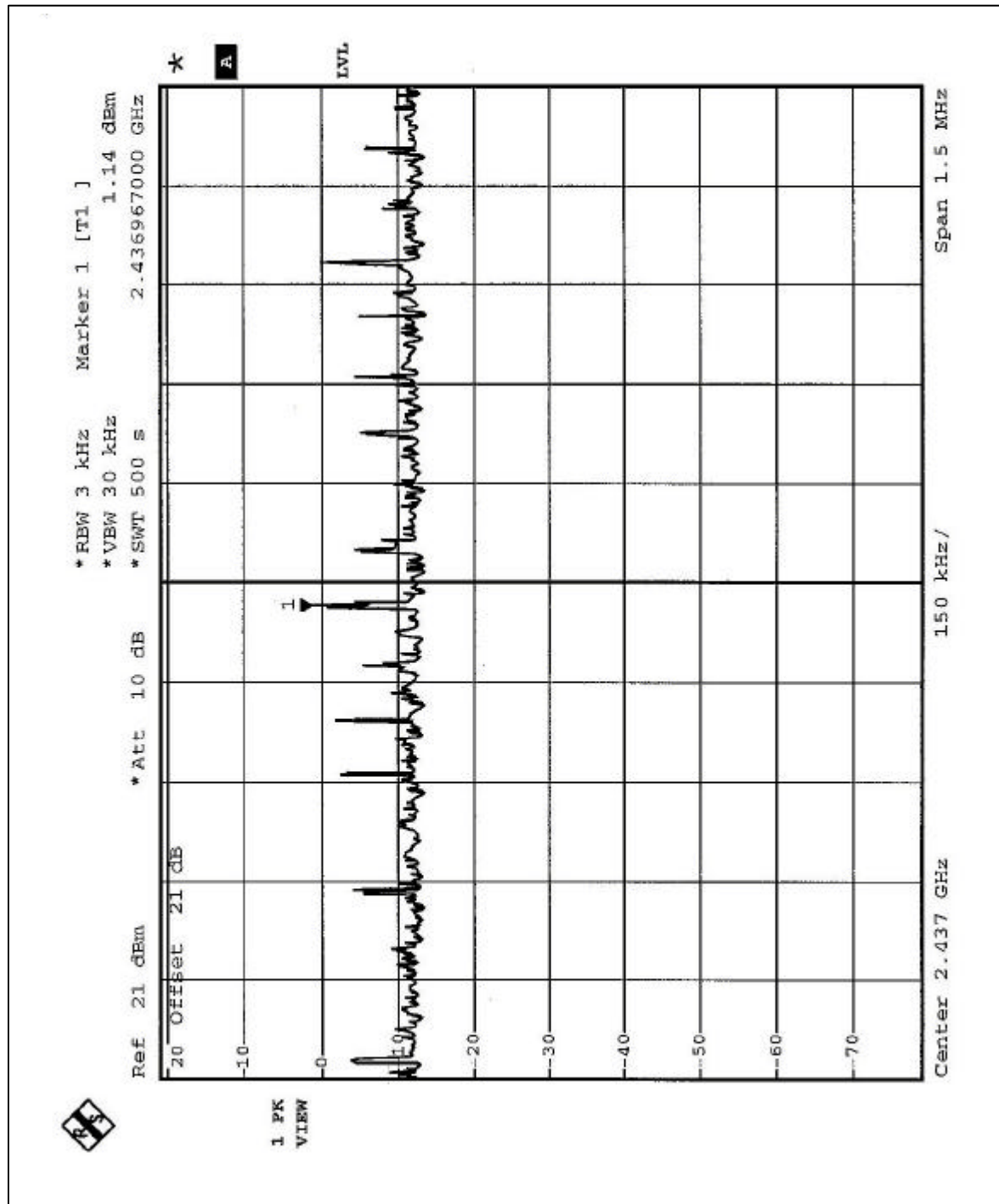



CH11

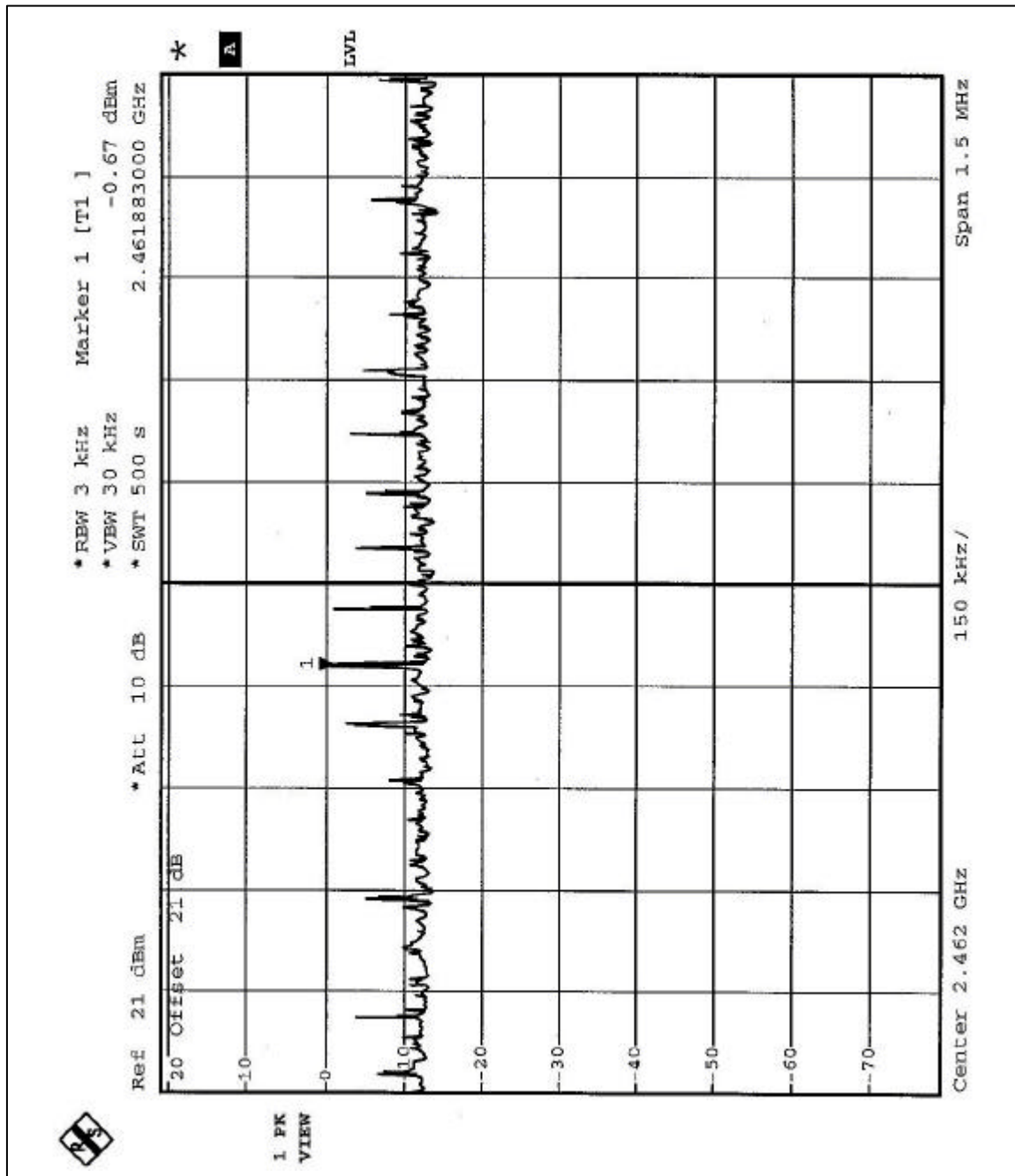



4.5.7 TEST RESULTS-OFDM

EUT	Wireless USB Adapter		
MODEL	WU830G	ENVIRONMENTAL CONDITIONS	17 deg. C, 60%RH, 977 hPa
INPUT POWER (SYSTEM)	120Vac, 60 Hz	TESTED BY	Tony Chen

CHANNEL NUMBER	CHANNEL FREQUENCY (MHz)	RF POWER LEVEL IN 3 KHz BW (dBm)	MAXIMUM LIMIT (dBm)	PASS/FAIL
1	2412	-16.63	8	PASS
6	2437	-17.19	8	PASS
11	2462	-16.61	8	PASS



CH1

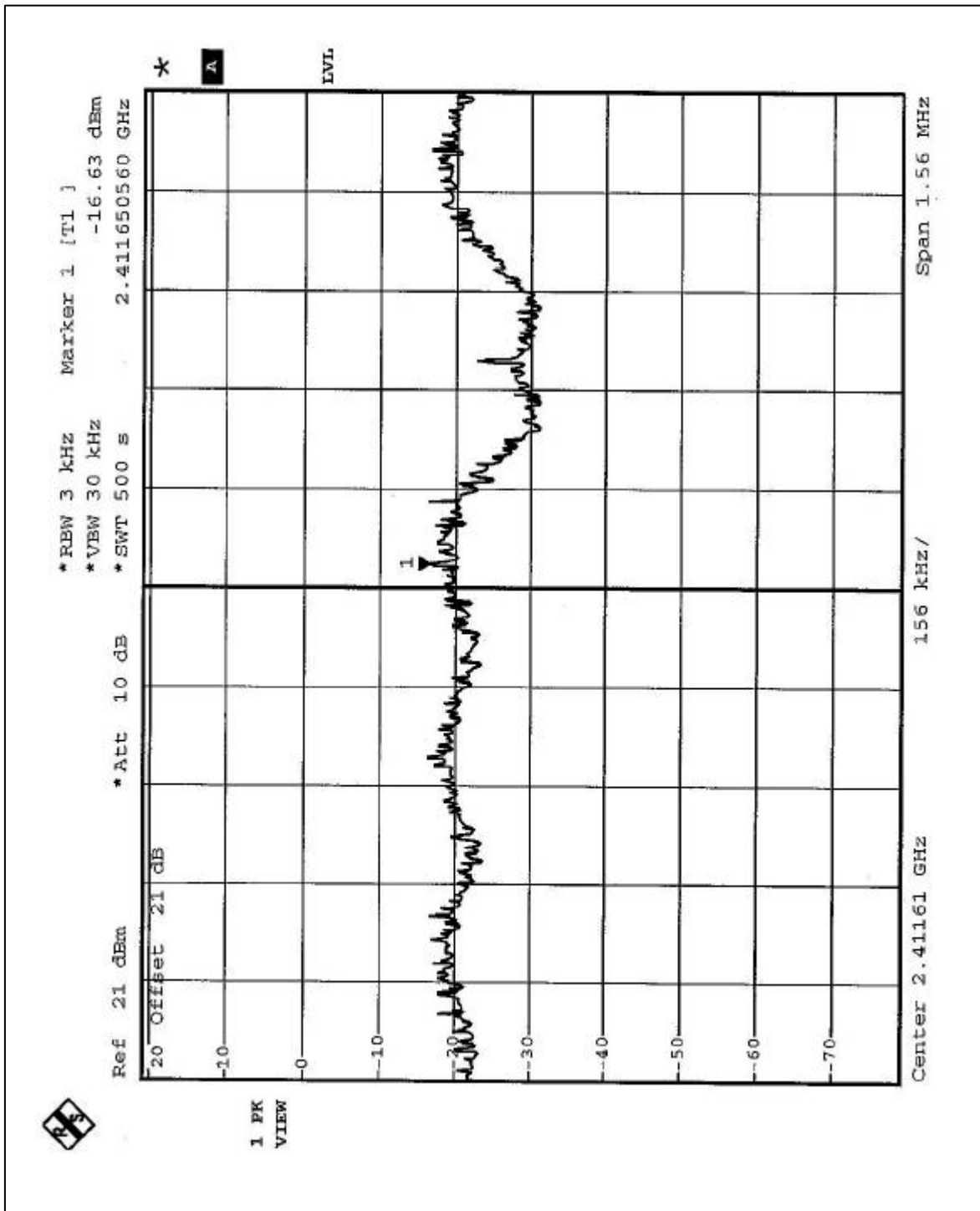



CH6

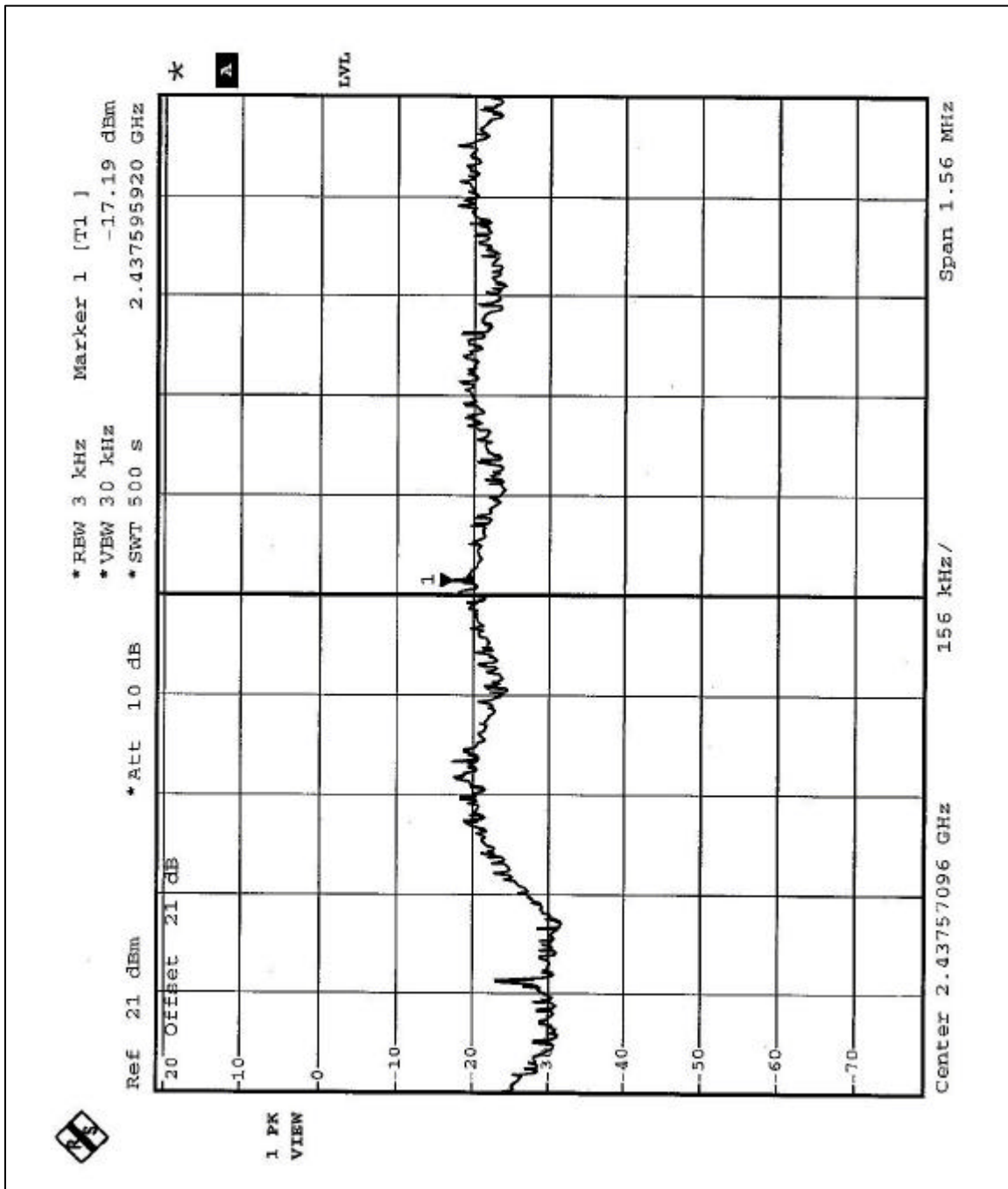



CH11

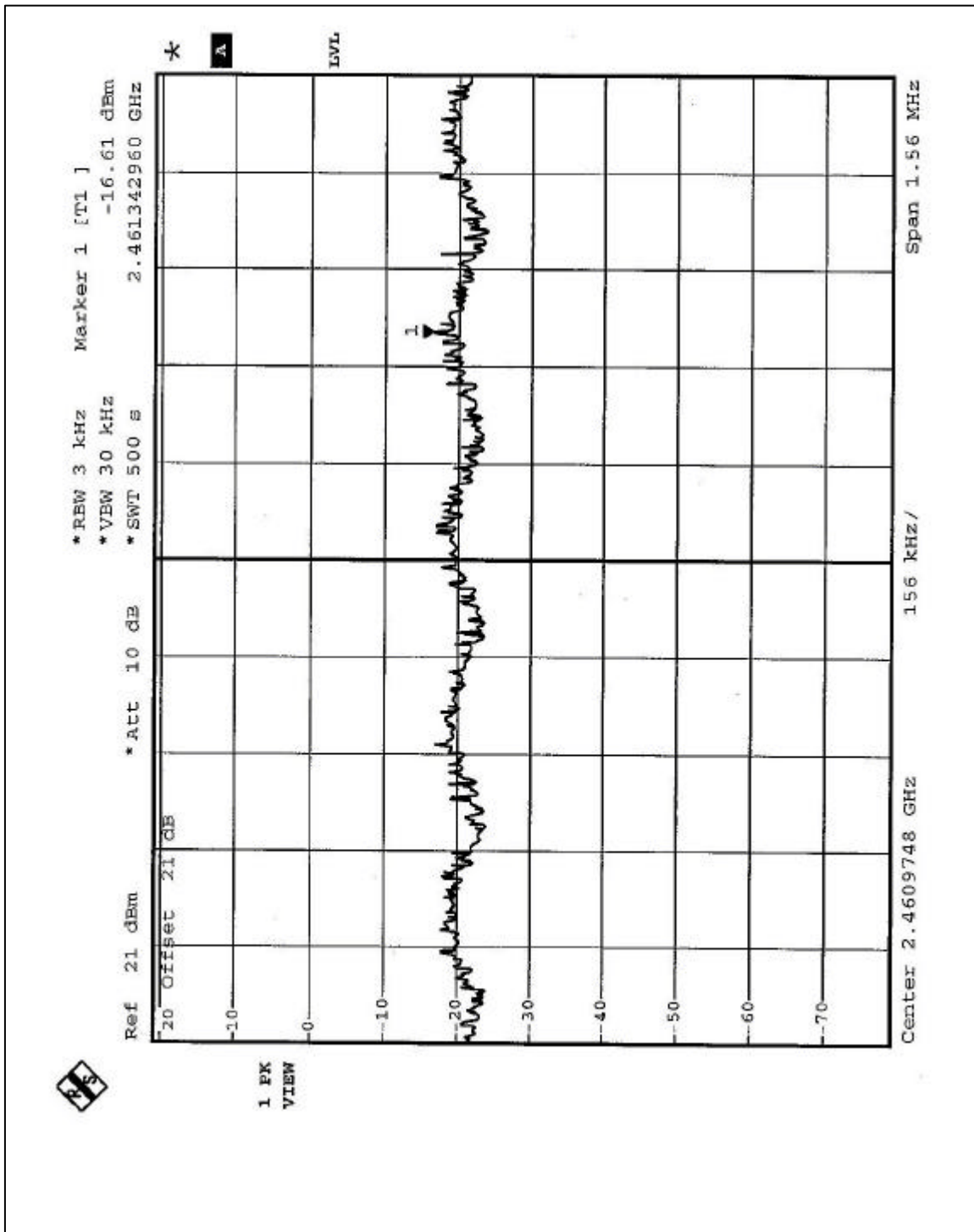



4.6 BAND EDGES MEASUREMENT

4.6.1 LIMITS OF BAND EDGES MEASUREMENT

Below -20dB of the highest emission level of operating band (in 100KHz Resolution Bandwidth).

4.6.2 TEST INSTRUMENTS

Description & Manufacturer	Model No.	Serial No.	Calibrated Until
R&S SPECTRUM ANALYZER	FSP40	100037	May. 06, 2004

NOTE:

- 1.The measurement uncertainty is less than +/- 2.6dB, which is calculated as per the NAMAS document NIS81.
- 2.The calibration interval of the above test instruments is 12 months and the calibrations are traceable to NML/ROC and NIST/USA.

4.6.3 TEST PROCEDURE

The transmitter output was connected to the spectrum analyzer via a low lose cable. Set both RBW and VBW of spectrum analyzer to 100 kHz with suitable frequency span including 100 kHz bandwidth from band edge. The band edges was measured and recorded.

4.6.4 EUT OPERATING CONDITION

Same as Item 4.3.5



4.6.5 TEST RESULTS - DSSS

The spectrum plots are attached on the following 2 pages. D1 line indicates the highest level, D2 line indicates the 20dB offset below D1. It shows compliance with the requirement in part 15.247(C).

NOTE (1): The band edge emission plot on the following first page shows 55.14dB delta between carrier maximum power and local maximum emission in restrict band (2.3900GHz). The emission of carrier strength list in the test result of channel 1 at the item 4.2.7 is 108.4dBuV/m, so the maximum field strength in restrict band is $108.4 - 55.14 = 53.26$ dBuV/m which is under 54 dBuV/m limit.

NOTE (2): The band edge emission plot on the following second page shows 54.91dB delta between carrier maximum power and local maximum emission in restrict band (2.4835GHz). The emission of carrier strength list in the test result of channel 11 at the item 4.2.7 is 107.6dBuV/m, so the maximum field strength in restrict band is $107.6 - 54.91 = 52.69$ dBuV/m which is under 54 dBuV/m limit.

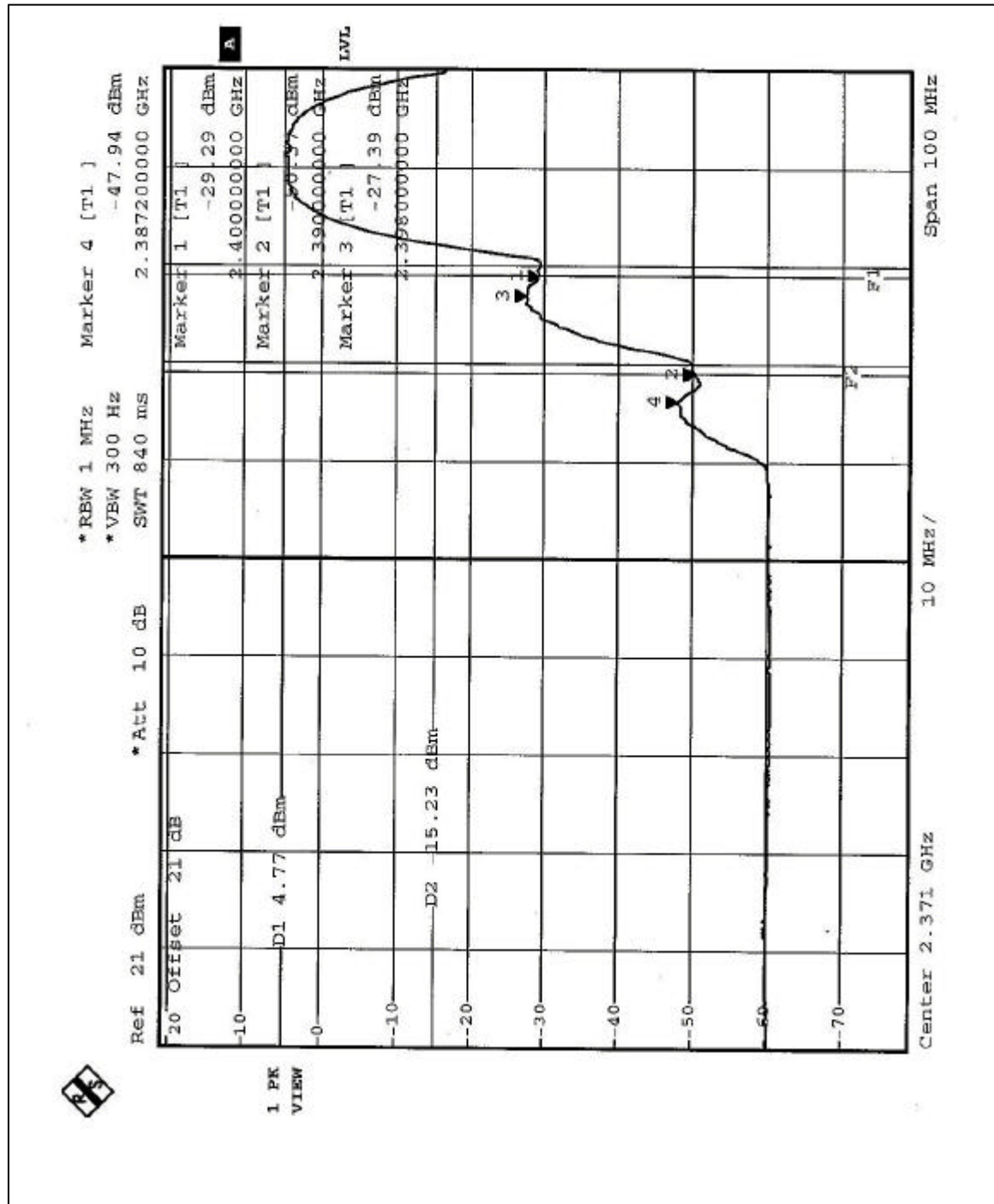

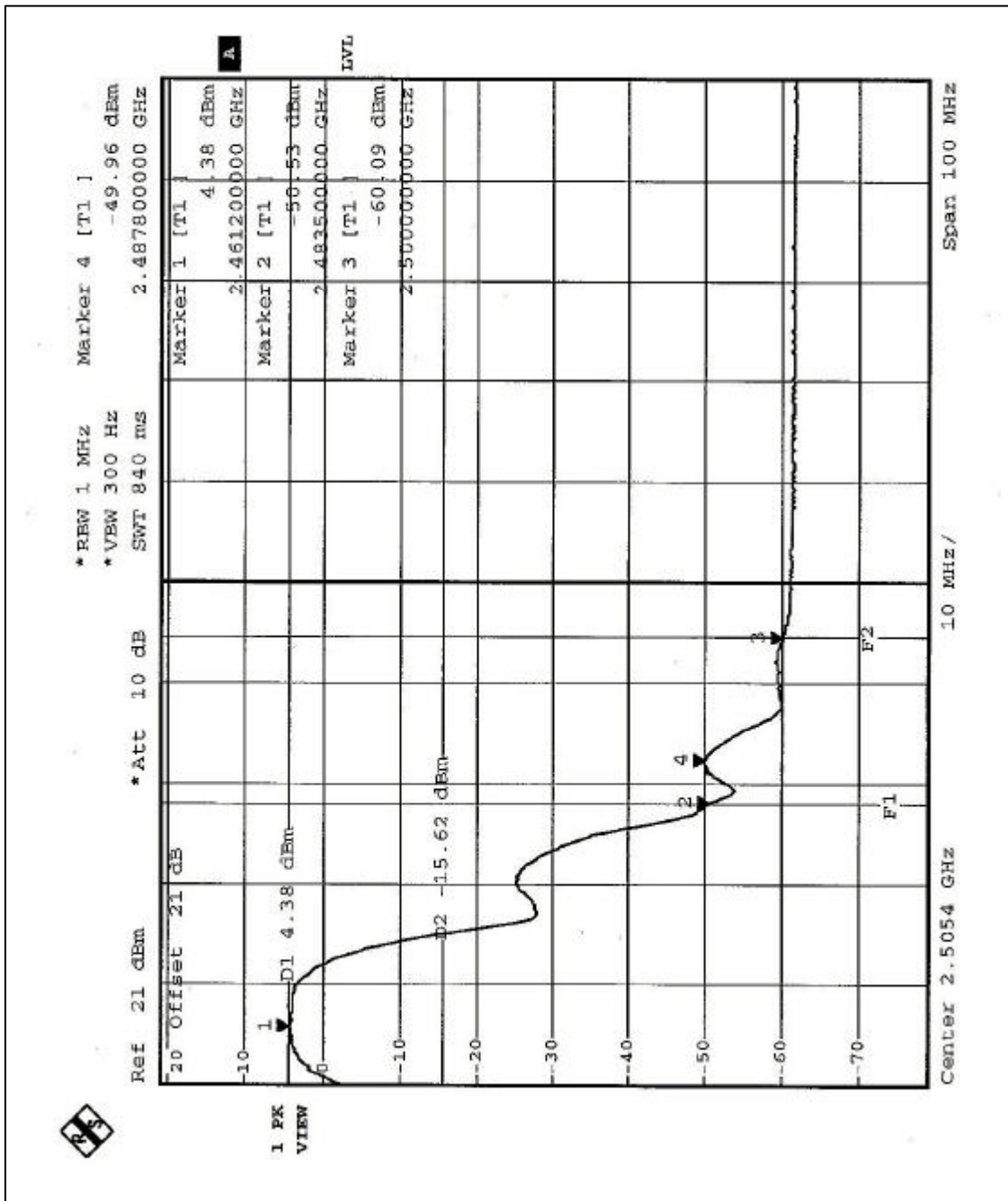



4.6.6 TEST RESULTS-OFDM

The spectrum plots are attached on the following 2 pages. D1 line indicates the highest level, D2 line indicates the 20dB offset below D1. It shows compliance with the requirement in part 15.247(C).

NOTE (1): The band edge emission plot on the following first page shows 48.67dB delta between carrier maximum power and local maximum emission in restrict band (2.3900GHz). The emission of carrier strength list in the test result of channel 1 at the item 4.2.8 is 100.9dBuV/m, so the maximum field strength in restrict band is $100.9-48.67=52.23$ dBuV/m which is under 54 dBuV/m limit.

NOTE (2): The band edge emission plot on the following second page shows 48.32dB delta between carrier maximum power and local maximum emission in restrict band (2.4835GHz). The emission of carrier strength list in the test result of channel 11 at the item 4.2.8 is 101.4dBuV/m, so the maximum field strength in restrict band is $101.4-48.32=53.08$ dBuV/m which is under 54 dBuV/m limit.

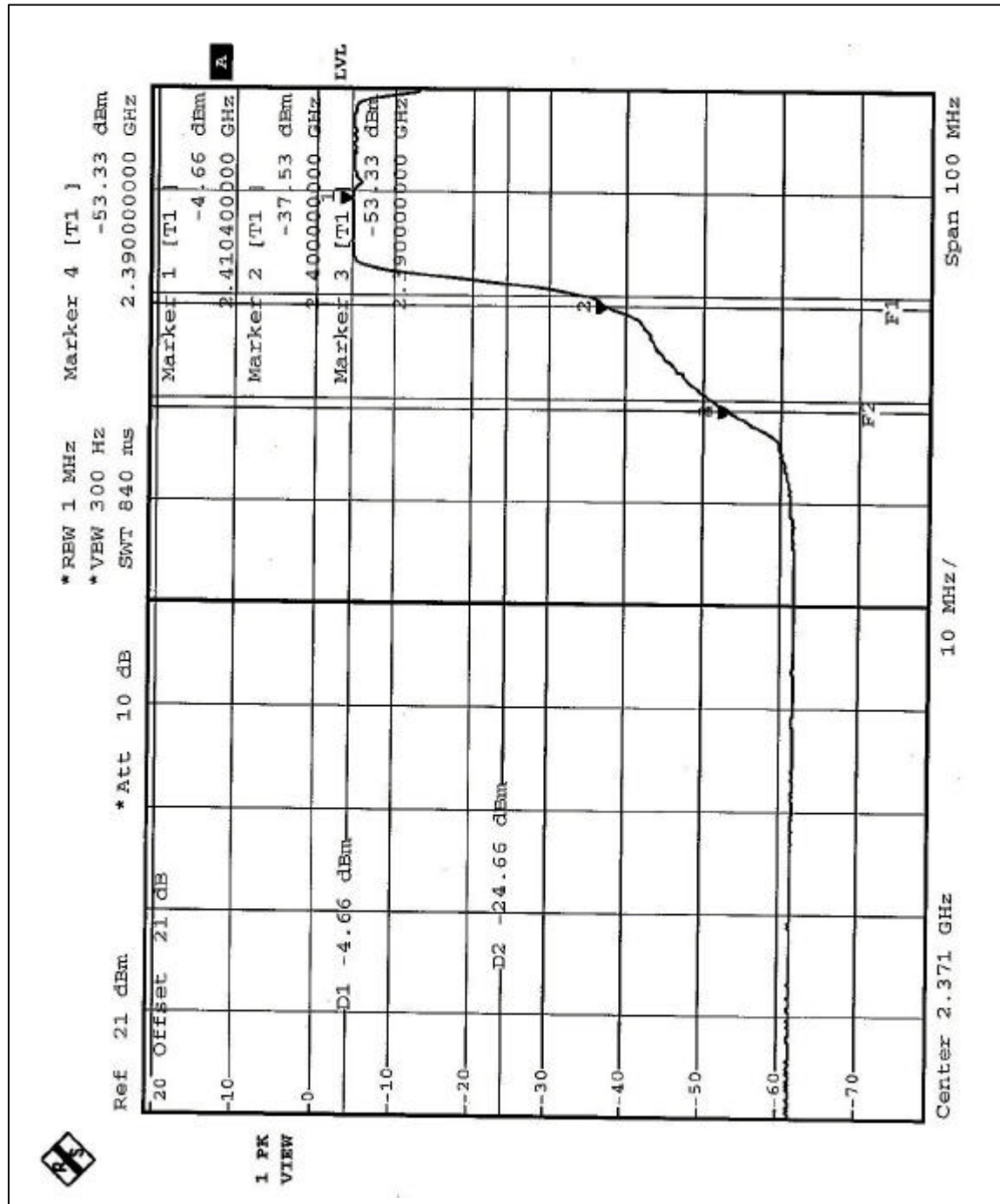

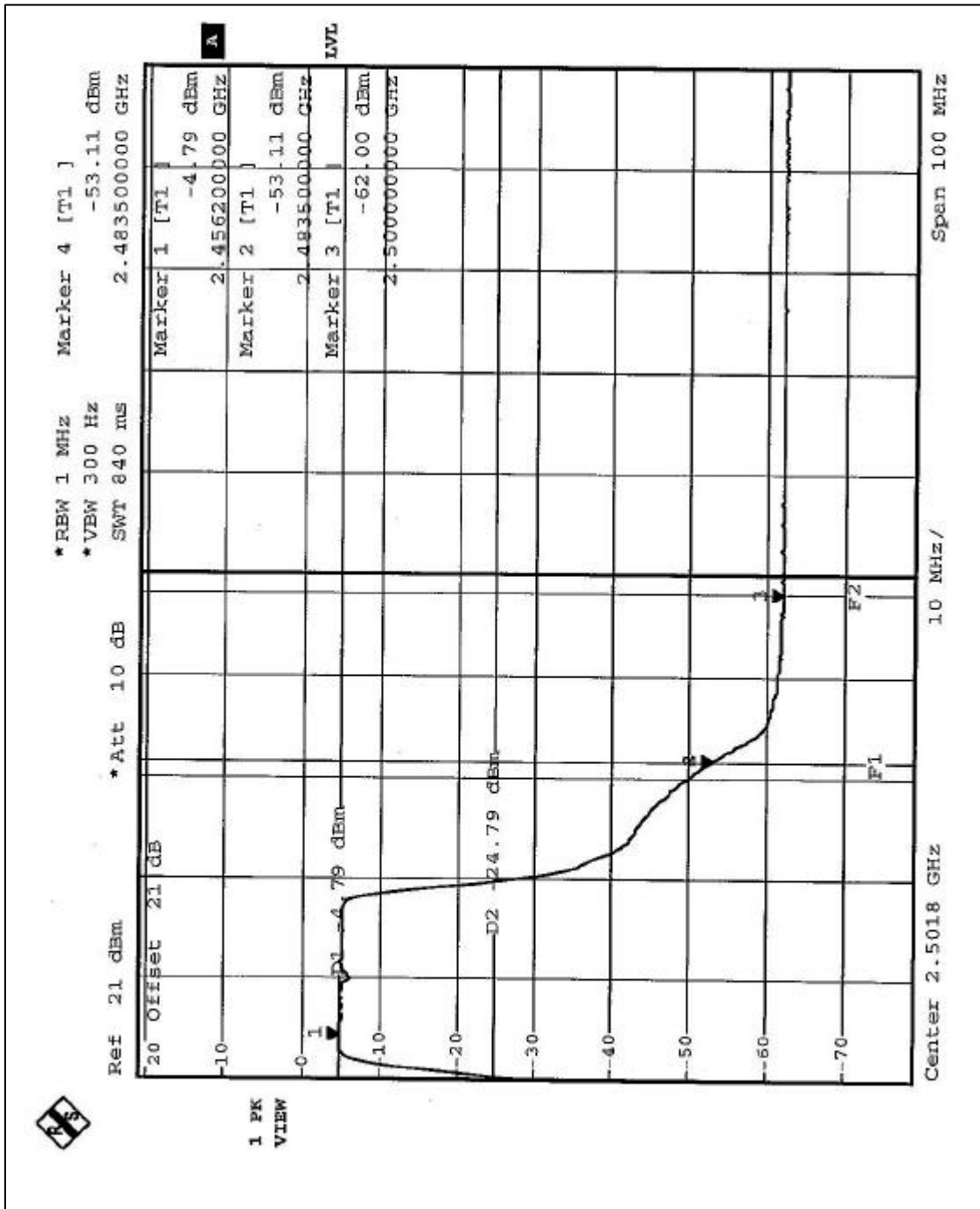



4.7 ANTENNA REQUIREMENT

4.7.1 STANDARD APPLICABLE

For intentional device, according to FCC 47 CFR Section 15.203, an intentional radiator shall be designed to ensure that no antenna other than that furnished by the responsible party shall be used with the device.

And according to FCC 47 CFR Section 15.247 (b), if transmitting antennas of directional gain greater than 6dBi are used, the power shall be reduced by the amount in dB that the directional gain of the antenna exceeds 6dBi.

4.7.2 ANTENNA CONNECTED CONSTRUCTION

The antenna type used in this product is Printed PCB Antenna without connector.

And the maximum Gain of this antenna is only 2 dBi.

5 PHOTOGRAPHS OF THE TEST CONFIGURATION CONDUCTED EMISSION TEST

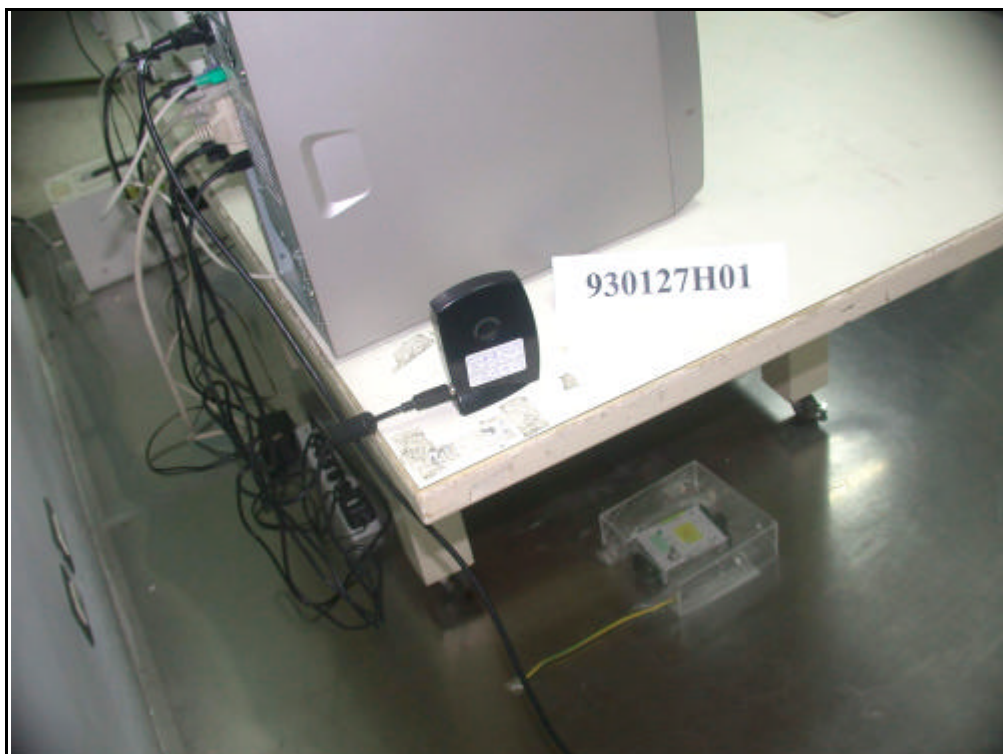

RADIATED EMISSION TEST





6 INFORMATION ON THE TESTING LABORATORIES

We, ADT Corp., were founded in 1988 to provide our best service in EMC and Safety consultation. Our laboratories are accredited and approved by the following approval agencies according to ISO/IEC 17025, Guide 25 or EN 45001:

USA	FCC, NVLAP, UL
Germany	TUV Rheinland
Japan	VCCI
New Zealand	MoC
Norway	NEMKO
Canada	INDUSTRY CANADA
R.O.C.	CNLA, BSMI

Copies of accreditation certificates of our laboratories obtained from approval agencies can be downloaded from our web site:

www.adt.com.tw/index.5/phtml.

If you have any comments, please feel free to contact us at the following:

Lin Kou EMC Lab:

Tel: 886-2-26052180

Fax: 886-2-26052943

Hsin Chu EMC Lab:

Tel: 886-35-935343

Fax: 886-35-935342

Lin Kou Safety Lab:

Tel: 886-2-26093195

Fax: 886-2-26093184

Lin Kou RF&Telecom Lab

Tel: 886-3-3270910

Fax: 886-3-3270892

Email: service@adt.com.tw

Web Site: www.adt.com.tw

The address and road map of all our labs can be found in our web site also.