

FCC Test Report

FCC ID : ACQ-VIP5662
Equipment : STB
Model No. : VIP5662
Brand Name : ARRIS
Applicant : ARRIS Group, Inc.
Address : 101 Tournament Drive, Horsham,
Pennsylvania, United States, 19044
Standard : 47 CFR FCC Part 15.247
Received Date : Sep. 26, 2016
Tested Date : Oct. 17 ~ Oct. 27, 2016

We, International Certification Corp., would like to declare that the tested sample has been evaluated and in compliance with the requirement of the above standards. The test results contained in this report refer exclusively to the product. It may be duplicated completely for legal use with the approval of the applicant. It shall not be reproduced except in full without the written approval of our laboratory.

Reviewed by:



Along Chen / Assistant Manager

Approved by:



Gary Chang / Manager



Table of Contents

1	GENERAL DESCRIPTION	5
1.1	Information.....	5
1.2	Local Support Equipment List	8
1.3	Test Setup Chart	8
1.4	The Equipment List	9
1.5	Test Standards	10
1.6	Measurement Uncertainty	10
2	TEST CONFIGURATION	11
2.1	Testing Condition	11
2.2	The Worst Test Modes and Channel Details	11
3	TRANSMITTER TEST RESULTS.....	12
3.1	Conducted Emissions.....	12
3.2	Unwanted Emissions into Restricted Frequency Bands	15
3.3	Unwanted Emissions into Non-Restricted Frequency Bands	31
3.4	Conducted Output Power	36
3.5	Number of Hopping Frequency	37
3.6	20dB and Occupied Bandwidth	40
3.7	Channel Separation.....	42
3.8	Number of Dwell Time.....	44
4	TEST LABORATORY INFORMATION	47

Release Record

Report No.	Version	Description	Issued Date
FR6O1701AD	Rev. 01	Initial issue	Nov. 15, 2016

Summary of Test Results

FCC Rules	Test Items	Measured	Result
15.207	Conducted Emissions	[dBuV]: 0.159MHz 57.04 (Margin -8.48dB) - QP	Pass
15.247(d) 15.209	Radiated Emissions	[dBuV/m at 3m]: 39.70MHz 37.83 (Margin -2.17dB) - QP	Pass
15.247(d)	Band Edge	Meet the requirement of limit	Pass
15.247(b)(1)	Conducted Output Power	Power [dBm]: 2.55	Pass
15.247(a)(1)(iii)	Number of Hopping Channels	Meet the requirement of limit	Pass
15.247(a)(1)	Hopping Channel Separation	Meet the requirement of limit	Pass
15.247(a)(1)(iii)	Dwell Time	Meet the requirement of limit	Pass
15.203	Antenna Requirement	Meet the requirement of limit	Pass

1 General Description

1.1 Information

1.1.1 Specification of the Equipment under Test (EUT)

RF General Information				
Frequency Range (MHz)	Bluetooth Mode	Ch. Frequency (MHz)	Channel Number	Data Rate
2400-2483.5	BR	2402-2480	0-78 [79]	1 Mbps
2400-2483.5	EDR	2402-2480	0-78 [79]	2 Mbps
2400-2483.5	EDR	2402-2480	0-78 [79]	3 Mbps

Note 1: RF output power specifies that Maximum Peak Conducted Output Power.
 Note 2: Bluetooth BR uses a GFSK.
 Note 3: Bluetooth EDR uses a combination of $\pi/4$ -DQPSK and 8DPSK.

1.1.2 Antenna Details

The device will be equipped with 2 brands of antennas (TSKY Ant. & Mag.Layers Ant.).

Ant. No.	Brand	Model	Type	Gain (dBi)	Connector	Remarks
1	TSKY	A8-A006-00260 (180-100-0694R)	PCB	2	MHF PLUG	---
2	Mag.Layers	PCA-5510-2G4C1-A3 (180-101-0694R)	PCB	2	MHF PLUG	---

1.1.3 Power Supply Type of Equipment under Test (EUT)

Power Supply Type	12Vdc from AC adapter
--------------------------	-----------------------

1.1.4 Accessories

No.	Equipment	Description
1	AC adapter	Brand Name: LiteOn Model Name: PB-1180-3AR1 Power Rating: I/P: 100-120Vac, 60Hz, 0.8A O/P: 12Vdc, 1.5A Power Line: 1.8m non-shielded cable without core
2	AC adapter	Brand Name: NetBit Model Name: NBS18B120150VU Power Rating: I/P: 100-120Vac, 60Hz, 0.5A O/P: 12Vdc, 1.5A Power Line: 1.82m non-shielded cable without core
3	AC adapter	Brand Name: APD Model Name: WB-18D12FU Power Rating: I/P: 100-120Vac, 50-60Hz, 0.5A O/P: 12Vdc, 1.5A Power Line: 1.8m non-shielded cable without core
4	AC adapter	Brand Name: Delta Model Name: ADP-18JW B Power Rating: I/P: 100-120Vac, 57-63Hz, 0.6A O/P: 12Vdc, 1.5A Power Line: 1.8m non-shielded cable without core
5	Internal HDD	Brand Name: TOSHIBA Model Name: MQ01ABD100V Capacity: 1TB
6	HDMI cable	Brand Name: WEBB & WELLS Model Name: HF1257 Power Line: 1.83m shielded cable without core
7	RJ45 cable	Brand Name: Ekson Model Name: ZP01-C258 Power Line: 3m shielded cable without core
8	RJ45 cable	Brand Name: WEBB & WELLS Model Name: K15092301 Power Line: 3m shielded cable without core
9	Remote control	Brand Name: Ruwido Model Name: 2761-529

1.1.5 Channel List

Frequency band (MHz)				2400~2483.5			
Channel	Frequency (MHz)	Channel	Frequency (MHz)	Channel	Frequency (MHz)	Channel	Frequency (MHz)
0	2402	20	2422	40	2442	60	2462
1	2403	21	2423	41	2443	61	2463
2	2404	22	2424	42	2444	62	2464
3	2405	23	2425	43	2445	63	2465
4	2406	24	2426	44	2446	64	2466
5	2407	25	2427	45	2447	65	2467
6	2408	26	2428	46	2448	66	2468
7	2409	27	2429	47	2449	67	2469
8	2410	28	2430	48	2450	68	2470
9	2411	29	2431	49	2451	69	2471
10	2412	30	2432	50	2452	70	2472
11	2413	31	2433	51	2453	71	2473
12	2414	32	2434	52	2454	72	2474
13	2415	33	2435	53	2455	73	2475
14	2416	34	2436	54	2456	74	2476
15	2417	35	2437	55	2457	75	2477
16	2418	36	2438	56	2458	76	2478
17	2419	37	2439	57	2459	77	2479
18	2420	38	2440	58	2460	78	2480
19	2421	39	2441	59	2461	---	---

1.1.6 Test Tool and Duty Cycle

Test Tool	CBT
-----------	-----

1.1.7 Power Setting

Modulation Mode	Test Frequency (MHz)		
	2402	2441	2480
GFSK/1Mbps	Default	Default	Default
$\pi/4$ -DQPSK /2Mbps	Default	Default	Default
8DPSK/3Mbps	Default	Default	Default

1.2 Local Support Equipment List

Support Equipment List					
No.	Equipment	Brand	Model	FCC ID	Signal cable / Length (m)
1	Notebook	DELL	Latitude E6430	DoC	RJ45, 10m non-shielded.
2	TV	CHIMEI	TL-24LF500D	---	MINI DIN to AV/YPbPr, 1.8m shielded. HDMI, 1.83m shielded.
3	USB Flash	Kingston	DTSE9	---	---

1.3 Test Setup Chart

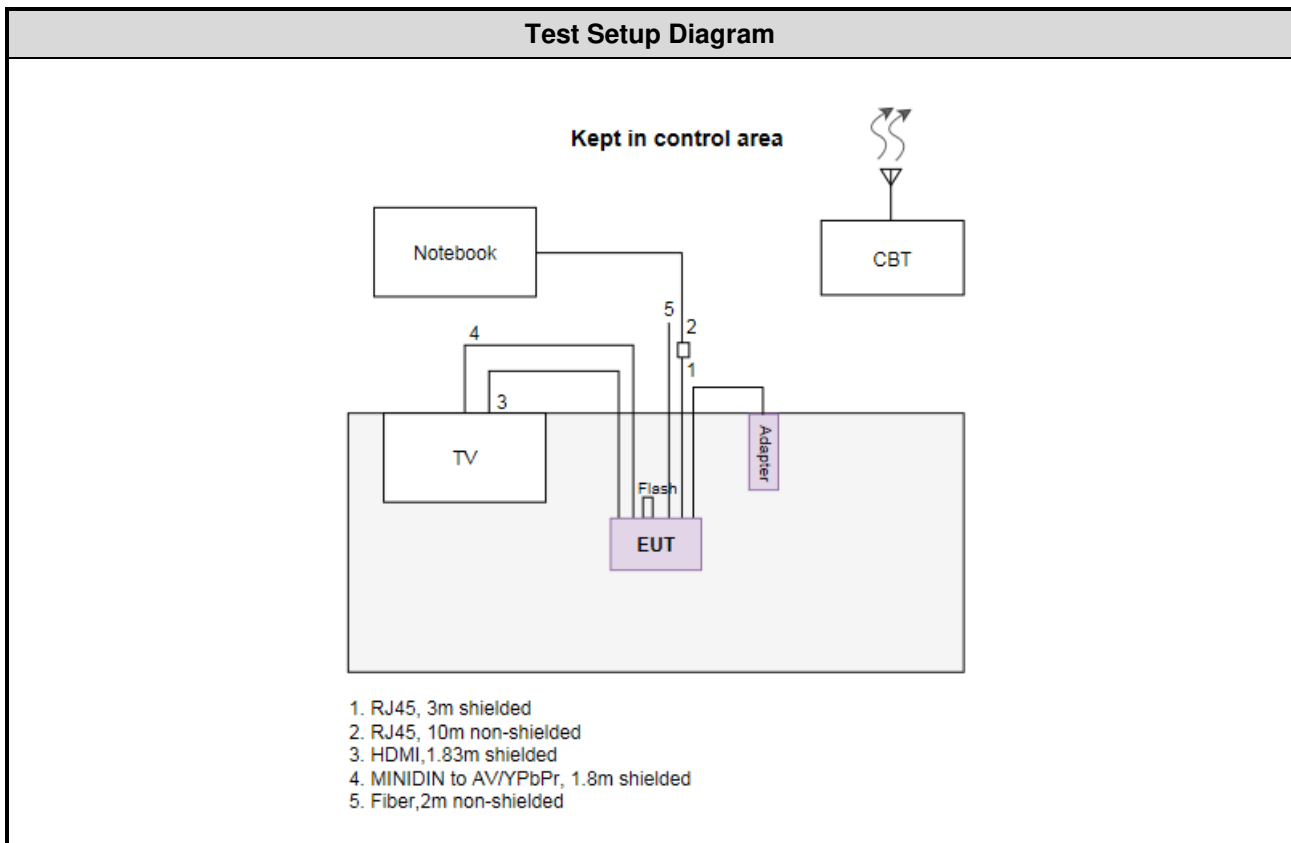

1.4 The Equipment List

Test Item	Conducted Emission				
Test Site	Conduction room 1 / (CO01-WS)				
Tested Date	Oct. 27, 2016				
Instrument	Manufacturer	Model No.	Serial No.	Calibration Date	Calibration Until
Receiver	R&S	ESR3	101658	Nov. 04, 2015	Nov. 03, 2016
LISN	SCHWARZBECK	Schwarzbeck 8127	8127-667	Nov. 13, 2015	Nov. 12, 2016
RF Cable-CON	EMC	EMCCFD300-BM-BM-6000	50821	Dec. 21, 2015	Dec. 20, 2016
Measurement Software	AUDIX	e3	6.120210k	NA	NA
Note: Calibration Interval of instruments listed above is one year.					

Test Item	Radiated Emission				
Test Site	966 chamber1 / (03CH01-WS)				
Tested Date	Oct. 17 ~ Oct. 19, 2016				
Instrument	Manufacturer	Model No.	Serial No.	Calibration Date	Calibration Until
Spectrum Analyzer	R&S	FSV40	101498	Dec. 13, 2015	Dec. 12, 2016
Receiver	R&S	ESR3	101658	Nov. 04, 2015	Nov. 03, 2016
Bilog Antenna	SCHWARZBECK	VULB9168	VULB9168-522	Aug. 04, 2016	Aug. 03, 2017
Horn Antenna 1G-18G	SCHWARZBECK	BBHA 9120 D	BBHA 9120 D 1096	Dec. 16, 2015	Dec. 15, 2016
Horn Antenna 18G-40G	SCHWARZBECK	BBHA 9170	BBHA 9170517	Nov. 04, 2015	Nov. 03, 2016
Loop Antenna	R&S	HFH2-Z2	100330	Nov. 16, 2015	Nov. 15, 2016
Loop Antenna Cable	KOAX KABEL	101354-BW	101354-BW	Dec. 10, 2015	Dec. 09, 2016
Preamplifier	EMC	EMC02325	980225	Aug. 05, 2016	Aug. 04, 2017
Preamplifier	Agilent	83017A	MY39501308	Oct. 06, 2016	Oct. 05, 2017
Preamplifier	EMC	EMC184045B	980192	Aug. 24, 2016	Aug. 23, 2017
RF Cable	HUBER+SUHNER	SUCOFLEX104	MY16014/4	Dec. 10, 2015	Dec. 09, 2016
RF Cable	HUBER+SUHNER	SUCOFLEX104	MY16019/4	Dec. 10, 2015	Dec. 09, 2016
RF Cable	HUBER+SUHNER	SUCOFLEX104	MY16139/4	Dec. 10, 2015	Dec. 09, 2016
LF cable 1M	EMC	EMCCFD400-NM-NM-1000	16052	Dec. 10, 2015	Dec. 09, 2016
LF cable 3M	Woken	CFD400NL-LW	CFD400NL-001	Dec. 10, 2015	Dec. 09, 2016
LF cable 10M	Woken	CFD400NL-LW	CFD400NL-002	Dec. 10, 2015	Dec. 09, 2016
Measurement Software	AUDIX	e3	6.120210g	NA	NA
Note: Calibration Interval of instruments listed above is one year.					

Test Item	RF Conducted				
Test Site	(TH01-WS)				
Tested Date	Oct. 19, 2016				
Instrument	Manufacturer	Model No.	Serial No.	Calibration Date	Calibration Until
Spectrum Analyzer	R&S	FSV40	101063	Feb. 17, 2016	Feb. 16, 2017
Power Meter	Anritsu	ML2495A	1241002	Oct. 06, 2016	Oct. 05, 2017
Power Sensor	Anritsu	MA2411B	1207366	Oct. 06, 2016	Oct. 05, 2017
AC POWER SOURCE	APC	AFC-500W	F312060012	Oct. 26, 2015	Oct. 25, 2016
Measurement Software	Sporton	Sporton_1	1.3.30	NA	NA
Bluetooth Tester	ROHDE&SCHWARZ	CBT	100959	Mar. 02, 2016	Mar. 02, 2017
Note: Calibration Interval of instruments listed above is one year.					

1.5 Test Standards

According to the specification of EUT, the EUT must comply with following standards and KDB documents.

47 CFR FCC Part 15.247

ANSI C63.10-2013

1.6 Measurement Uncertainty

ISO/IEC 17025 requires that an estimate of the measurement uncertainties associated with the emissions test results be included in the report. The measurement uncertainties given below are based on a 95% confidence level (based on a coverage factor ($k=2$))

Measurement Uncertainty	
Parameters	Uncertainty
Bandwidth	± 34.134 Hz
Conducted power	± 0.808 dB
Power density	± 0.463 dB
Conducted emission	± 2.670 dB
AC conducted emission	± 2.90 dB
Radiated emission ≤ 1 GHz	± 3.66 dB
Radiated emission > 1 GHz	± 5.63 dB

2 Test Configuration

2.1 Testing Condition

Test Item	Test Site	Ambient Condition	Tested By
AC Conduction	CO01-WS	26°C / 60%	Howard Huang
Radiated Emissions	03CH01-WS	23-25°C / 61-62%	Vincent Yeh Kevin Lee
RF Conducted	TH01-WS	22°C / 63%	Brad Wu

➤ FCC site registration No.: 181692

➤ IC site registration No.: 10807A-1

2.2 The Worst Test Modes and Channel Details

Test item	Mode	Test Frequency (MHz)	Data Rate (Mbps)	Test Configuration
Conducted Emissions	GFSK	2402	1Mbps	---
Radiated Emissions ≤ 1GHz	GFSK	2402	1Mbps	---
Radiated Emissions > 1GHz	GFSK	2402, 2441, 2480	1Mbps	---
	8DPSK	2402, 2441, 2480	3Mbps	
Conducted Output Power	GFSK	2402, 2441, 2480	1Mbps	---
	π/4 QDPSK	2402, 2441, 2480	2Mbps	
	8DPSK	2402, 2441, 2480	3Mbps	
Number of Hopping Channels	GFSK	2402~2480	1Mbps	---
	8DPSK	2402~2480	3Mbps	
Hopping Channel Separation 20dB and Occupied bandwidth	GFSK	2402, 2441, 2480	1Mbps	---
	8DPSK	2402, 2441, 2480	3Mbps	
Dwell Time	GFSK	2402	1Mbps	---
	8DPSK	2402	3Mbps	

NOTE:

- Four adapters (LiteOn , NetBit, APD & Delta) had been covered during the pretest and found that NetBit adapter was the worst case for radiated emission test and LiteOn adapter was the worst case for conducted emission test.
- The device will be equipped with 2 brands of antennas (TSKY Ant. & Mag.Layers Ant.). Both options were assessed and TSKY Ant. was found to be the worst case and was selected for the final test.
- Two RJ45 cables (Ekson & WEBB & WELLS) had been covered during the pretest and found that Ekson RJ45 cable was the worst case and was selected for final testing.

3 Transmitter Test Results

3.1 Conducted Emissions

3.1.1 Limit of Conducted Emissions

Conducted Emissions Limit		
Frequency Emission (MHz)	Quasi-Peak	Average
0.15-0.5	66 - 56 *	56 - 46 *
0.5-5	56	46
5-30	60	50

Note 1: * Decreases with the logarithm of the frequency.

3.1.2 Test Procedures

1. The device is placed on a test table, raised 80 cm above the reference ground plane. The vertical conducting plane is located 40 cm to the rear of the device.
2. The device is connected to line impedance stabilization network (LISN) and other accessories are connected to other LISN. Measured levels of AC power line conducted emission are across the 50 Ω LISN port.
3. AC conducted emission measurements is made over frequency range from 150 kHz to 30 MHz.
4. This measurement was performed with AC 120V/60Hz

3.1.3 Test Setup



- Note: 1. Support units were connected to second LISN.
 2. Both of LISNs (AMN) are 80 cm from EUT and at least 80 cm from other units and other metal planes

3.1.4 Test Result of Conducted Emissions

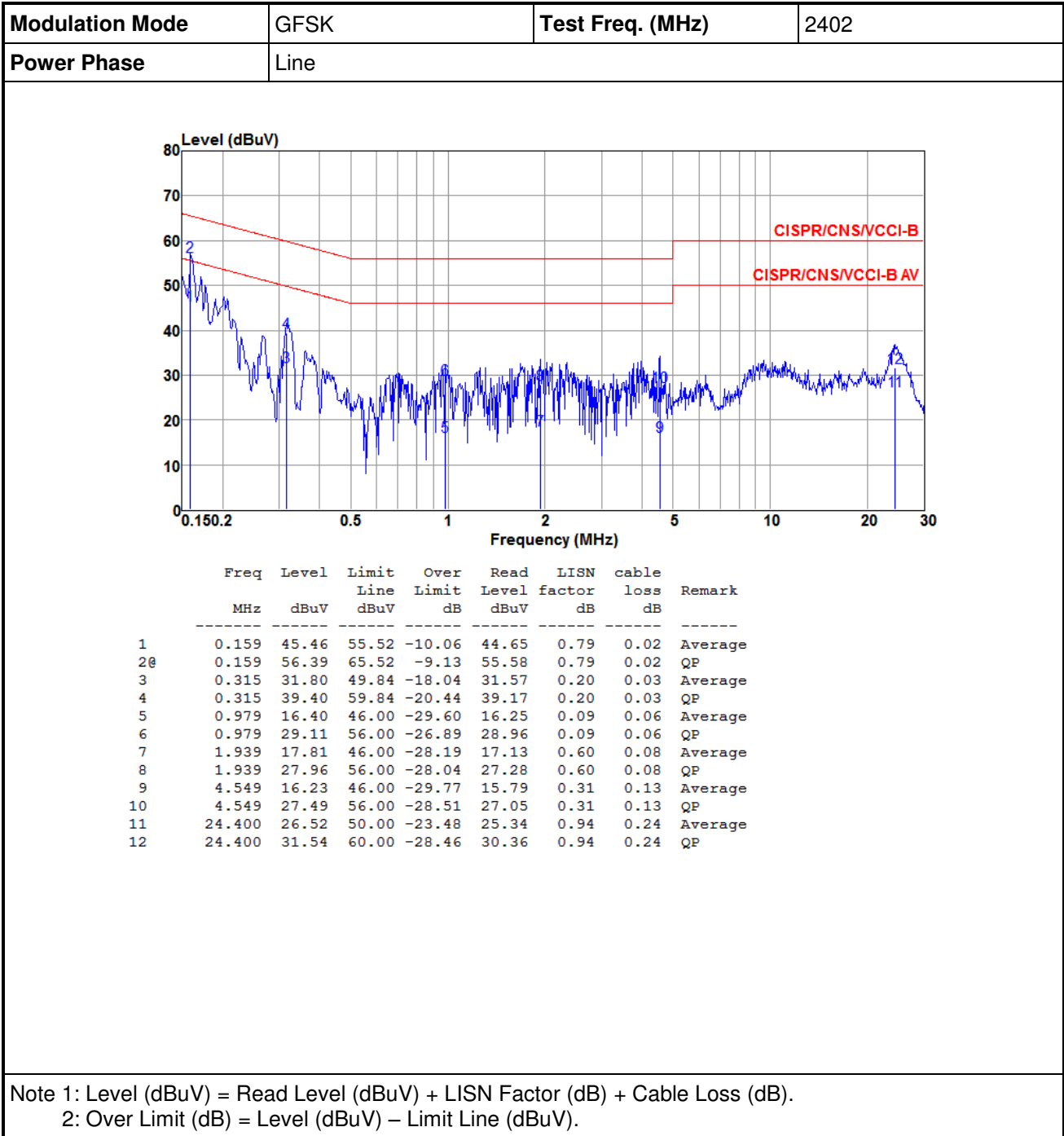

Modulation Mode	GFSK	Test Freq. (MHz)	2402
Power Phase	Neutral		

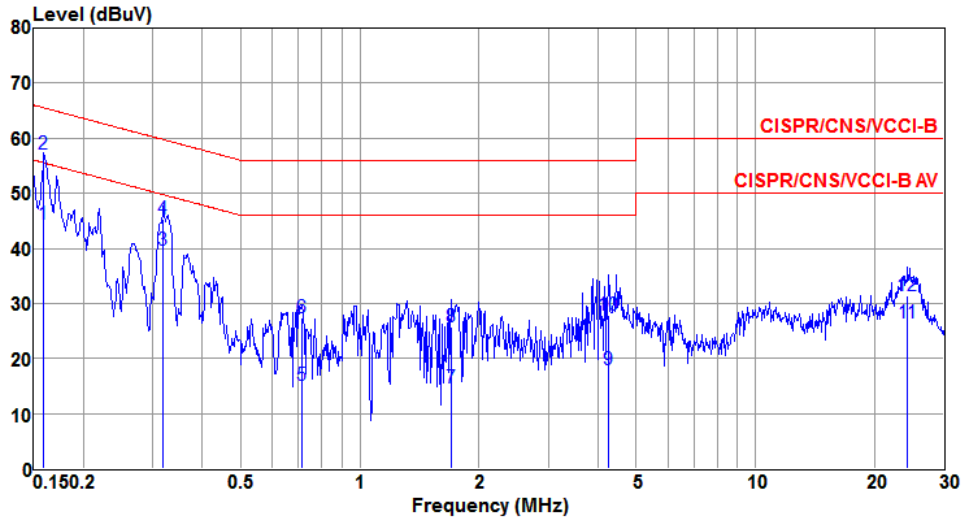

	Freq MHz	Level dBuV	Limit Line dBuV	Over Limit dB	Read Level dBuV	LISN factor dB	cable loss dB	Remark
1	0.159	44.44	55.52	-11.08	43.69	0.73	0.02	Average
2	0.159	57.04	65.52	-8.48	56.29	0.73	0.02	QP
3	0.318	39.67	49.75	-10.08	39.47	0.17	0.03	Average
4	0.318	45.26	59.75	-14.49	45.06	0.17	0.03	QP
5	0.712	15.22	46.00	-30.78	14.95	0.22	0.05	Average
6	0.712	27.33	56.00	-28.67	27.06	0.22	0.05	QP
7	1.698	14.59	46.00	-31.41	14.28	0.23	0.08	Average
8	1.698	25.79	56.00	-30.21	25.48	0.23	0.08	QP
9	4.247	17.83	46.00	-28.17	16.98	0.73	0.12	Average
10	4.247	27.85	56.00	-28.15	27.00	0.73	0.12	QP
11	24.271	26.46	50.00	-23.54	25.22	1.00	0.24	Average
12	24.271	31.35	60.00	-28.65	30.11	1.00	0.24	QP

Note 1: Level (dBuV) = Read Level (dBuV) + LISN Factor (dB) + Cable Loss (dB).
 Note 2: Over Limit (dB) = Level (dBuV) – Limit Line (dBuV).

3.2 Unwanted Emissions into Restricted Frequency Bands

3.2.1 Limit of Unwanted Emissions into Restricted Frequency Bands

Restricted Band Emissions Limit			
Frequency Range (MHz)	Field Strength (uV/m)	Field Strength (dBuV/m)	Measure Distance (m)
0.009~0.490	2400/F(kHz)	48.5 - 13.8	300
0.490~1.705	24000/F(kHz)	33.8 - 23	30
1.705~30.0	30	29	30
30~88	100	40	3
88~216	150	43.5	3
216~960	200	46	3
Above 960	500	54	3

Note 1:
Qusai-Peak value is measured for frequency below 1GHz except for 9–90 kHz, 110–490 kHz frequency band. Peak and average value are measured for frequency above 1GHz. The limit on average radio frequency emission is as above table. The limit on peak radio frequency emissions is 20 dB above the maximum permitted average emission limit

Note 2:
Measurements may be performed at a distance other than what is specified provided. When performing measurements at a distance other than that specified, the results shall be extrapolated to the specified distance using an extrapolation factor as below, Frequency at or above 30 MHz: 20 dB/decade Frequency below 30 MHz: 40 dB/decade.

3.2.2 Test Procedures

1. Measurement is made at a semi-anechoic chamber that incorporates a turntable allowing a EUT rotation of 360°. A continuously-rotating, remotely-controlled turntable is installed at the test site to support the EUT and facilitate determination of the direction of maximum radiation for each EUT emission frequency. The EUT is placed at test table. For emissions testing at or below 1 GHz, the table height is 80 cm above the reference ground plane. For emission measurements above 1 GHz, the table height is 1.5 m
2. Measurement is made with the antenna positioned in both the horizontal and vertical planes of polarization. The measurement antenna is varied in height (1m ~ 4m) above the reference ground plane to obtain the maximum signal strength. Distance between EUT and antenna is 3 m.
3. This investigation is performed with the EUT rotated 360°, the antenna height scanned between 1 m and 4 m, and the antenna rotated to repeat the measurements for both the horizontal and vertical antenna polarizations.

Note:

1. 120kHz measurement bandwidth of test receiver and Quasi-peak detector is for radiated emission below 1GHz.
2. Radiated emission above 1GHz / Peak value
RBW=1MHz, VBW=3MHz and Peak detector
Radiated emission above 1GHz / Average value for harmonics
The average value is: Average = Peak value + 20log(Duty cycle) Where the duty factor is calculated from following formula for DH5 packet type which has worst duty factor:
3.
$$20\log(\text{Duty cycle}) = 20\log \frac{1\text{s} / 1600 * 5}{100 \text{ ms}} = -30.1\text{dB}$$
4. Radiated emission above 1GHz / Average value for other emissions
RBW=1MHz, VBW=1/T and Peak detector

3.2.3 Test Setup

Radiated Emissions below 1 GHz

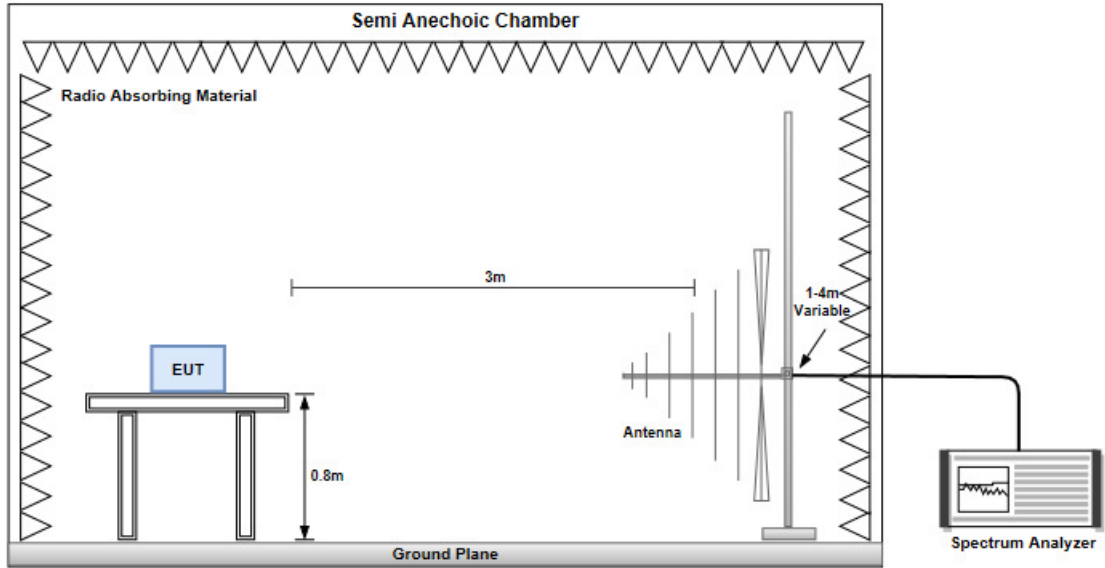

Radiated Emissions above 1 GHz

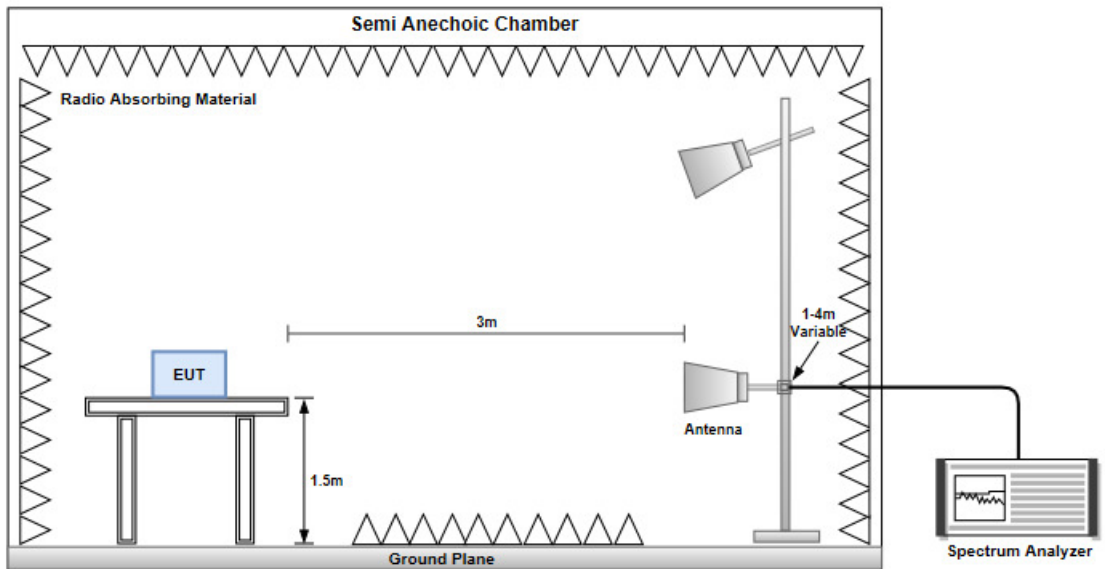

3.2.4 Transmitter Radiated Unwanted Emissions (Below 1GHz)

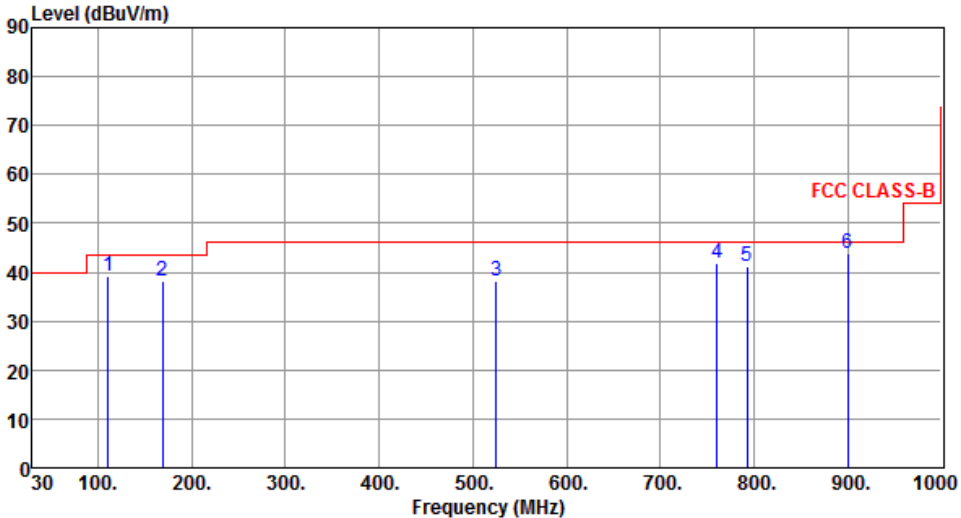
Modulation	GFSK	Test Freq. (MHz)	2402																																																																						
Polarization	Horizontal																																																																								
																																																																									
	<table border="1"> <thead> <tr> <th>Freq.</th> <th>Emission level</th> <th>Limit</th> <th>Margin</th> <th>SA reading</th> <th>Factor</th> <th>Remark</th> <th>ANT High cm</th> <th>Turn Table deg</th> </tr> <tr> <th>MHz</th> <th>dBuV/m</th> <th>dBuV/m</th> <th>dB</th> <th>dBuV</th> <th>dB</th> <th></th> <th></th> <th></th> </tr> </thead> <tbody> <tr> <td>1</td> <td>110.51</td> <td>39.33</td> <td>43.50</td> <td>-4.17</td> <td>50.59</td> <td>-11.26</td> <td>Peak</td> <td>---</td> </tr> <tr> <td>2</td> <td>168.71</td> <td>38.34</td> <td>43.50</td> <td>-5.16</td> <td>47.00</td> <td>-8.66</td> <td>Peak</td> <td>---</td> </tr> <tr> <td>3</td> <td>524.70</td> <td>38.23</td> <td>46.00</td> <td>-7.77</td> <td>40.84</td> <td>-2.61</td> <td>Peak</td> <td>---</td> </tr> <tr> <td>4</td> <td>760.41</td> <td>41.85</td> <td>46.00</td> <td>-4.15</td> <td>40.28</td> <td>1.57</td> <td>Peak</td> <td>---</td> </tr> <tr> <td>5</td> <td>792.42</td> <td>41.33</td> <td>46.00</td> <td>-4.67</td> <td>39.39</td> <td>1.94</td> <td>Peak</td> <td>---</td> </tr> <tr> <td>6</td> <td>900.09</td> <td>43.74</td> <td>46.00</td> <td>-2.26</td> <td>39.90</td> <td>3.84</td> <td>Peak</td> <td>---</td> </tr> </tbody> </table>	Freq.	Emission level	Limit	Margin	SA reading	Factor	Remark	ANT High cm	Turn Table deg	MHz	dBuV/m	dBuV/m	dB	dBuV	dB				1	110.51	39.33	43.50	-4.17	50.59	-11.26	Peak	---	2	168.71	38.34	43.50	-5.16	47.00	-8.66	Peak	---	3	524.70	38.23	46.00	-7.77	40.84	-2.61	Peak	---	4	760.41	41.85	46.00	-4.15	40.28	1.57	Peak	---	5	792.42	41.33	46.00	-4.67	39.39	1.94	Peak	---	6	900.09	43.74	46.00	-2.26	39.90	3.84	Peak	---
Freq.	Emission level	Limit	Margin	SA reading	Factor	Remark	ANT High cm	Turn Table deg																																																																	
MHz	dBuV/m	dBuV/m	dB	dBuV	dB																																																																				
1	110.51	39.33	43.50	-4.17	50.59	-11.26	Peak	---																																																																	
2	168.71	38.34	43.50	-5.16	47.00	-8.66	Peak	---																																																																	
3	524.70	38.23	46.00	-7.77	40.84	-2.61	Peak	---																																																																	
4	760.41	41.85	46.00	-4.15	40.28	1.57	Peak	---																																																																	
5	792.42	41.33	46.00	-4.67	39.39	1.94	Peak	---																																																																	
6	900.09	43.74	46.00	-2.26	39.90	3.84	Peak	---																																																																	
<p>Note 1: Emission Level (dBuV/m) = SA Reading (dBuV/m) + Factor* (dB) *Factor includes antenna factor , cable loss and amplifier gain Note 2: Margin (dB) = Emission level (dBuV/m) – Limit (dBuV/m). Note 3: All spurious emissions below 30MHz are more than 20 dB below the limit.</p>																																																																									

Modulation	GFSK	Test Freq. (MHz)	2402
Polarization	Vertical		

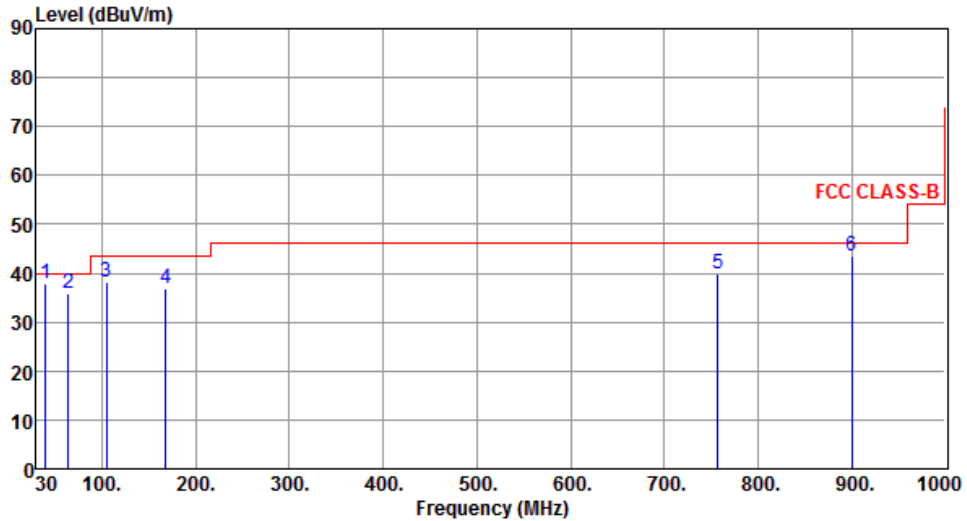

	Freq. MHz	Emission level dBuV/m	Limit dBuV/m	Margin dB	SA reading dBuV	Factor dB	Remark	ANT High cm	Turn Table deg
1	39.70	37.83	40.00	-2.17	45.71	-7.88	QP	100	206
2	63.95	36.02	40.00	-3.98	45.71	-9.69	QP	100	280
3	104.69	38.30	43.50	-5.20	50.51	-12.21	Peak	---	---
4	167.74	36.71	43.50	-6.79	45.32	-8.61	Peak	---	---
5	757.50	39.76	46.00	-6.24	38.21	1.55	Peak	---	---
6	900.09	43.37	46.00	-2.63	39.53	3.84	Peak	---	---

Note 1: Emission Level (dBuV/m) = SA Reading (dBuV/m) + Factor* (dB)

*Factor includes antenna factor , cable loss and amplifier gain

Note 2: Margin (dB) = Emission level (dBuV/m) – Limit (dBuV/m).

Note 3: All spurious emissions below 30MHz are more than 20 dB below the limit.

3.2.5 Transmitter Radiated Unwanted Emissions (Above 1GHz) for GFSK

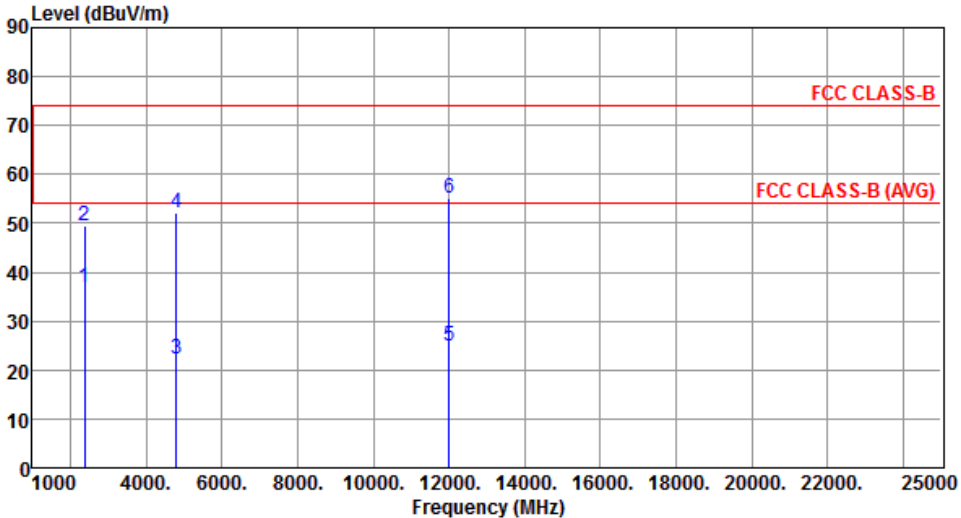
Modulation	GFSK	Test Freq. (MHz)	2402						
Polarization	Horizontal								
									
	Freq.	Emission level	Limit	Margin	SA reading	Factor	Remark	ANT High	Turn Table
	MHz	dBuV/m	dBuV/m	dB	dBuV	dB		cm	deg
1	2390.00	36.92	54.00	-17.08	40.21	-3.29	Average	245	271
2	2390.00	49.43	74.00	-24.57	52.72	-3.29	Peak	245	271
3	4804.00	22.18	54.00	-31.82	18.70	3.48	Average	296	259
4	4804.00	52.28	74.00	-21.72	48.80	3.48	Peak	296	259
5	12010.00	24.97	54.00	-29.03	10.68	14.29	Average	100	170
6	12010.00	55.07	74.00	-18.93	40.78	14.29	Peak	100	170
<p>Note 1: Emission Level (dBuV/m) = SA Reading (dBuV/m) + Factor* (dB) *Factor includes antenna factor , cable loss and amplifier gain Note 2: Margin (dB) = Emission level (dBuV/m) – Limit (dBuV/m).</p>									

Modulation	GFSK	Test Freq. (MHz)	2402
Polarization	Vertical		

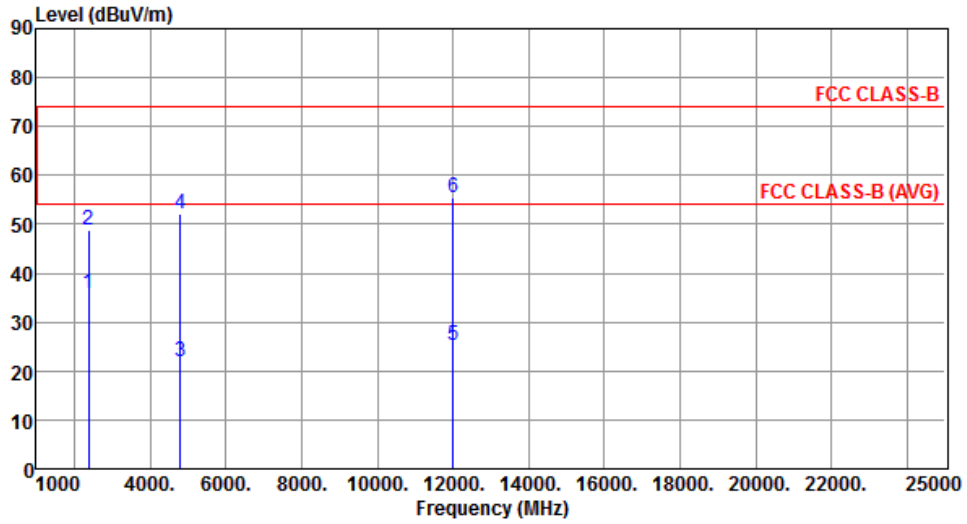

	Freq. MHz	Emission level dBuV/m	Limit dBuV/m	Margin dB	SA reading dBuV	Factor dB	Remark	ANT High cm	Turn Table deg
1	2390.00	35.72	54.00	-18.28	39.01	-3.29	Average	360	310
2	2390.00	48.77	74.00	-25.23	52.06	-3.29	Peak	360	310
3	4804.00	21.98	54.00	-32.02	18.50	3.48	Average	104	332
4	4804.00	52.08	74.00	-21.92	48.60	3.48	Peak	104	332
5	12010.00	25.32	54.00	-28.68	11.03	14.29	Average	100	209
6	12010.00	55.42	74.00	-18.58	41.13	14.29	Peak	100	209

Note 1: Emission Level (dBuV/m) = SA Reading (dBuV/m) + Factor* (dB)

*Factor includes antenna factor , cable loss and amplifier gain

Note 2: Margin (dB) = Emission level (dBuV/m) – Limit (dBuV/m).

Modulation	GFSK	Test Freq. (MHz)	2441
Polarization	Horizontal		

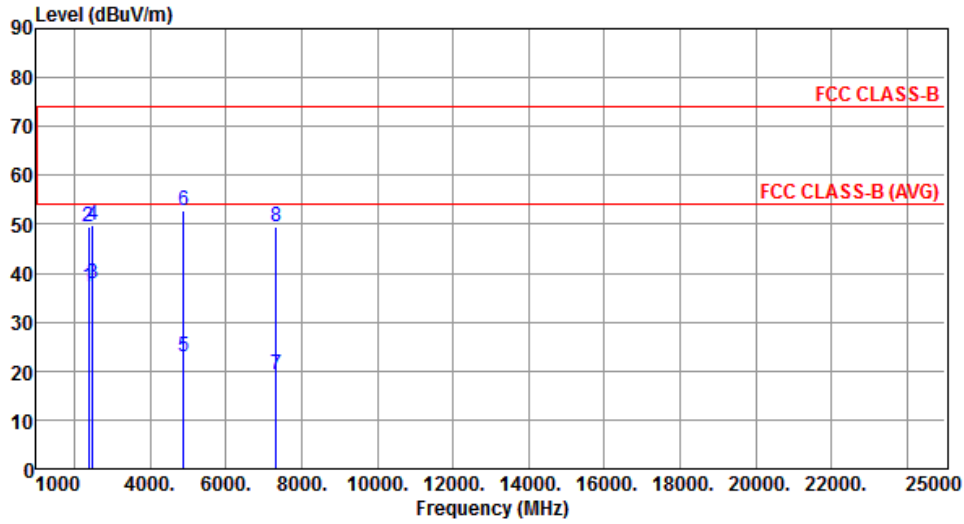

	Freq. MHz	Emission level dBuV/m	Limit dBuV/m	Margin dB	SA reading dBuV	Factor dB	Remark	ANT High cm	Turn Table deg
1	2390.00	37.28	54.00	-16.72	40.57	-3.29	Average	237	267
2	2390.00	49.47	74.00	-24.53	52.76	-3.29	Peak	237	267
3	2483.50	37.93	54.00	-16.07	40.83	-2.90	Average	237	267
4	2483.50	49.86	74.00	-24.14	52.76	-2.90	Peak	237	267
5	4882.00	22.79	54.00	-31.21	19.07	3.72	Average	316	263
6	4882.00	52.89	74.00	-21.11	49.17	3.72	Peak	316	263
7	7323.00	19.34	54.00	-34.66	10.82	8.52	Average	100	298
8	7323.00	49.44	74.00	-24.56	40.92	8.52	Peak	100	298

Note 1: Emission Level (dBuV/m) = SA Reading (dBuV/m) + Factor* (dB)

*Factor includes antenna factor , cable loss and amplifier gain

Note 2: Margin (dB) = Emission level (dBuV/m) – Limit (dBuV/m).

Modulation	GFSK	Test Freq. (MHz)	2441
Polarization	Vertical		

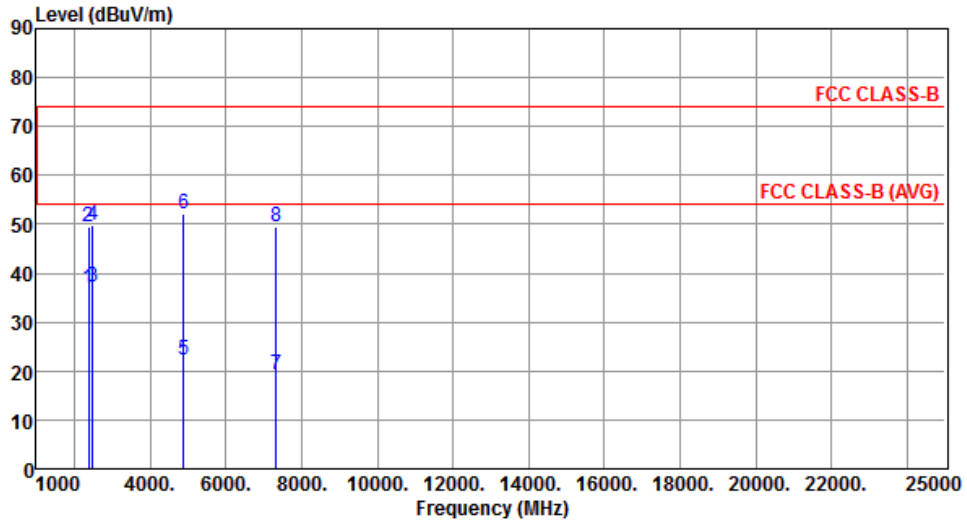

	Freq. MHz	Emission level dBuV/m	Limit dBuV/m	Margin dB	SA reading dBuV	Factor dB	Remark	ANT High cm	Turn Table deg
1	2390.00	36.79	54.00	-17.21	40.08	-3.29	Average	342	228
2	2390.00	49.44	74.00	-24.56	52.73	-3.29	Peak	342	228
3	2483.50	37.03	54.00	-16.97	39.93	-2.90	Average	100	211
4	2483.50	49.96	74.00	-24.04	52.86	-2.90	Peak	100	211
5	4882.00	22.14	54.00	-31.86	18.42	3.72	Average	100	288
6	4882.00	52.24	74.00	-21.76	48.52	3.72	Peak	100	288
7	7323.00	19.24	54.00	-34.76	10.72	8.52	Average	100	211
8	7323.00	49.34	74.00	-24.66	40.82	8.52	Peak	100	211

Note 1: Emission Level (dBuV/m) = SA Reading (dBuV/m) + Factor* (dB)

*Factor includes antenna factor , cable loss and amplifier gain

Note 2: Margin (dB) = Emission level (dBuV/m) – Limit (dBuV/m).

Modulation	GFSK	Test Freq. (MHz)	2480
Polarization	Horizontal		

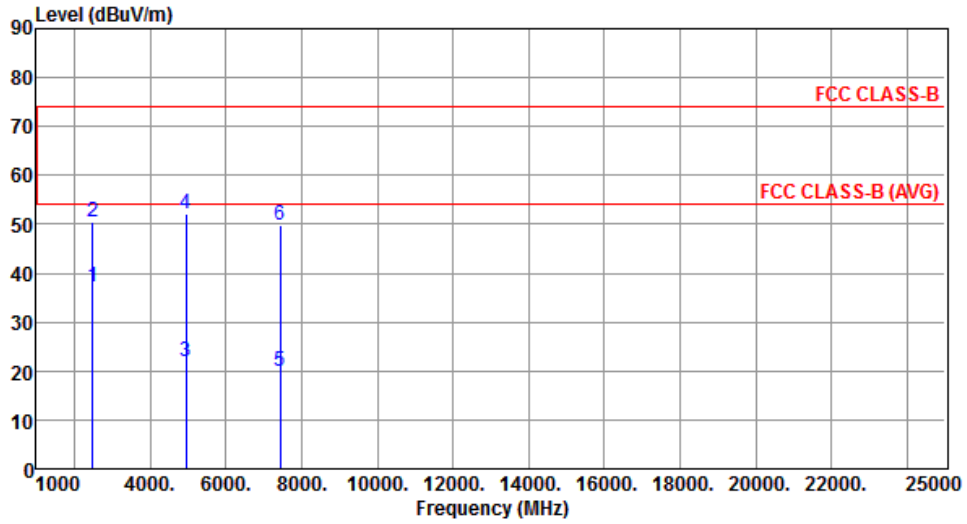

	Freq. MHz	Emission level dBuV/m	Limit dBuV/m	Margin dB	SA reading dBuV	Factor dB	Remark	ANT High cm	Turn Table deg
1	2483.50	37.20	54.00	-16.80	40.10	-2.90	Average	259	269
2	2483.50	50.47	74.00	-23.53	53.37	-2.90	Peak	259	269
3	4960.00	22.00	54.00	-32.00	18.02	3.98	Average	259	269
4	4960.00	52.10	74.00	-21.90	48.12	3.98	Peak	259	269
5	7440.00	19.80	54.00	-34.20	11.16	8.64	Average	100	318
6	7440.00	49.90	74.00	-24.10	41.26	8.64	Peak	100	318

Note 1: Emission Level (dBuV/m) = SA Reading (dBuV/m) + Factor* (dB)

*Factor includes antenna factor , cable loss and amplifier gain

Note 2: Margin (dB) = Emission level (dBuV/m) – Limit (dBuV/m).

Modulation	GFSK	Test Freq. (MHz)	2480
Polarization	Vertical		

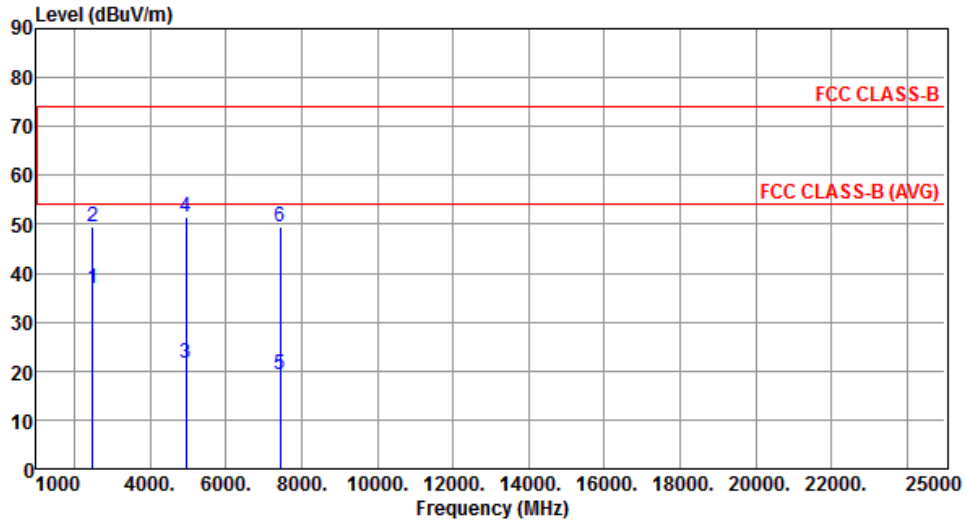

	Freq. MHz	Emission level dBuV/m	Limit dBuV/m	Margin dB	SA reading dBuV	Factor dB	Remark	ANT High cm	Turn Table deg
1	2483.50	36.89	54.00	-17.11	39.79	-2.90	Average	351	191
2	2483.50	49.56	74.00	-24.44	52.46	-2.90	Peak	351	191
3	4960.00	21.52	54.00	-32.48	17.54	3.98	Average	100	347
4	4960.00	51.62	74.00	-22.38	47.64	3.98	Peak	100	347
5	7440.00	19.37	54.00	-34.63	10.73	8.64	Average	100	262
6	7440.00	49.47	74.00	-24.53	40.83	8.64	Peak	100	262

Note 1: Emission Level (dBuV/m) = SA Reading (dBuV/m) + Factor* (dB)

*Factor includes antenna factor , cable loss and amplifier gain

Note 2: Margin (dB) = Emission level (dBuV/m) – Limit (dBuV/m).

3.2.6 Transmitter Radiated Unwanted Emissions (Above 1GHz) for 8DPSK

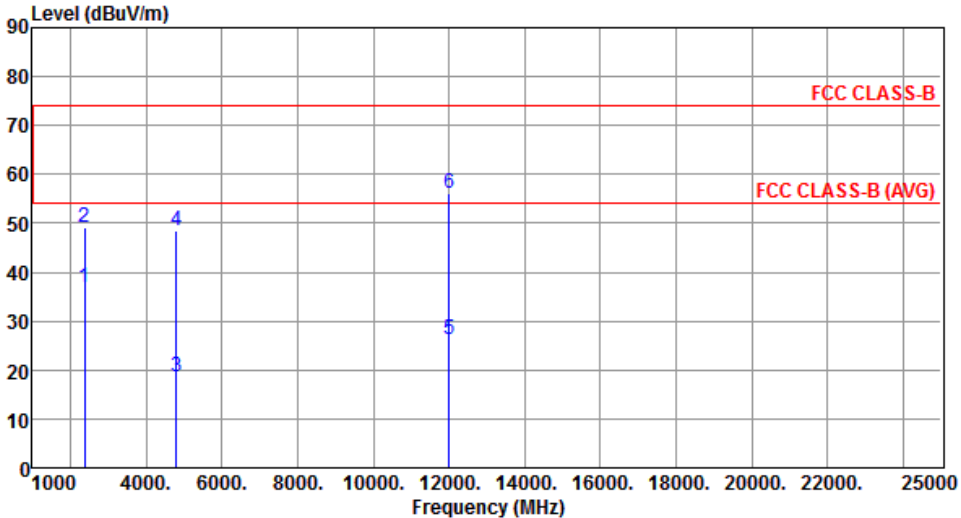
Modulation	8DPSK	Test Freq. (MHz)	2402						
Polarization	Horizontal								
									
	Freq.	Emission level	Limit	Margin	SA reading	Factor	Remark	ANT High	Turn Table
	MHz	dBuV/m	dBuV/m	dB	dBuV	dB		cm	deg
1	2390.00	36.73	54.00	-17.27	40.02	-3.29	Average	246	271
2	2390.00	49.26	74.00	-24.74	52.55	-3.29	Peak	246	271
3	4804.00	18.44	54.00	-35.56	14.96	3.48	Average	313	266
4	4804.00	48.54	74.00	-25.46	45.06	3.48	Peak	313	266
5	12010.00	26.11	54.00	-27.89	11.82	14.29	Average	100	178
6	12010.00	56.21	74.00	-17.79	41.92	14.29	Peak	100	178
<p>Note 1: Emission Level (dBuV/m) = SA Reading (dBuV/m) + Factor* (dB) *Factor includes antenna factor , cable loss and amplifier gain Note 2: Margin (dB) = Emission level (dBuV/m) – Limit (dBuV/m).</p>									

Modulation	8DPSK	Test Freq. (MHz)	2402
Polarization	Vertical		

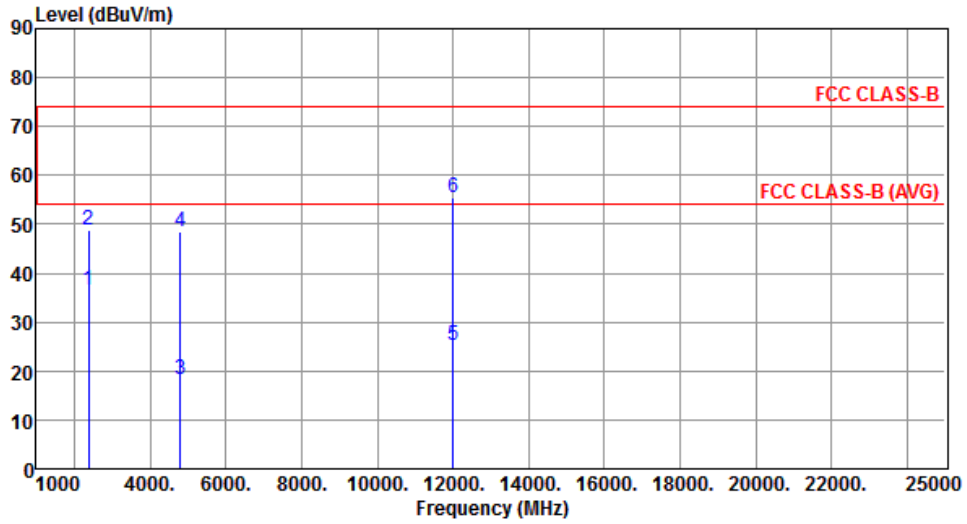

	Freq. MHz	Emission level dBuV/m	Limit dBuV/m	Margin dB	SA reading dBuV	Factor dB	Remark	ANT High cm	Turn Table deg
1	2390.00	36.68	54.00	-17.32	39.97	-3.29	Average	359	315
2	2390.00	48.79	74.00	-25.21	52.08	-3.29	Peak	359	315
3	4804.00	18.27	54.00	-35.73	14.79	3.48	Average	103	334
4	4804.00	48.37	74.00	-25.63	44.89	3.48	Peak	103	334
5	12010.00	25.21	54.00	-28.79	10.92	14.29	Average	103	218
6	12010.00	55.31	74.00	-18.69	41.02	14.29	Peak	103	218

Note 1: Emission Level (dBuV/m) = SA Reading (dBuV/m) + Factor* (dB)

*Factor includes antenna factor , cable loss and amplifier gain

Note 2: Margin (dB) = Emission level (dBuV/m) – Limit (dBuV/m).

Modulation	8DPSK	Test Freq. (MHz)	2441
Polarization	Horizontal		

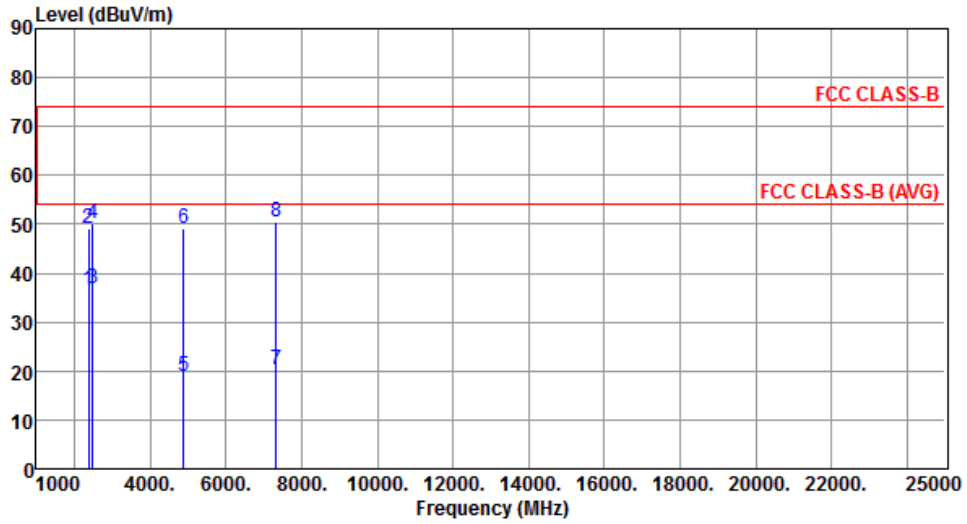

	Freq. MHz	Emission level dBuV/m	Limit dBuV/m	Margin dB	SA reading dBuV	Factor dB	Remark	ANT High cm	Turn Table deg
1	2390.00	36.54	54.00	-17.46	39.83	-3.29	Average	240	268
2	2390.00	49.01	74.00	-24.99	52.30	-3.29	Peak	240	268
3	2483.50	36.87	54.00	-17.13	39.77	-2.90	Average	240	268
4	2483.50	50.10	74.00	-23.90	53.00	-2.90	Peak	240	268
5	4882.00	18.94	54.00	-35.06	15.22	3.72	Average	318	262
6	4882.00	49.04	74.00	-24.96	45.32	3.72	Peak	318	262
7	7323.00	20.32	54.00	-33.68	11.80	8.52	Average	100	311
8	7323.00	50.42	74.00	-23.58	41.90	8.52	Peak	100	311

Note 1: Emission Level (dBuV/m) = SA Reading (dBuV/m) + Factor* (dB)

*Factor includes antenna factor , cable loss and amplifier gain

Note 2: Margin (dB) = Emission level (dBuV/m) – Limit (dBuV/m).

Modulation	8DPSK	Test Freq. (MHz)	2441
Polarization	Vertical		

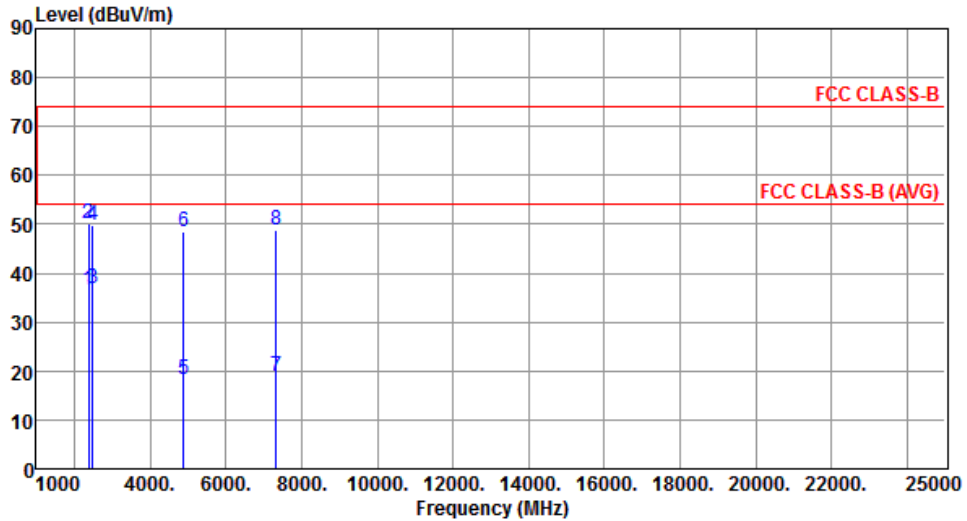

	Freq. MHz	Emission level dBuV/m	Limit dBuV/m	Margin dB	SA reading dBuV	Factor dB	Remark	ANT High cm	Turn Table deg
1	2390.00	36.56	54.00	-17.44	39.85	-3.29	Average	345	229
2	2390.00	49.99	74.00	-24.01	53.28	-3.29	Peak	345	229
3	2483.50	36.87	54.00	-17.13	39.77	-2.90	Average	345	229
4	2483.50	49.86	74.00	-24.14	52.76	-2.90	Peak	345	229
5	4882.00	18.38	54.00	-35.62	14.66	3.72	Average	100	291
6	4882.00	48.48	74.00	-25.52	44.76	3.72	Peak	100	291
7	7323.00	18.79	54.00	-35.21	10.27	8.52	Average	100	210
8	7323.00	48.89	74.00	-25.11	40.37	8.52	Peak	100	210

Note 1: Emission Level (dBuV/m) = SA Reading (dBuV/m) + Factor* (dB)

*Factor includes antenna factor , cable loss and amplifier gain

Note 2: Margin (dB) = Emission level (dBuV/m) – Limit (dBuV/m).

Modulation	8DPSK	Test Freq. (MHz)	2480
Polarization	Horizontal		

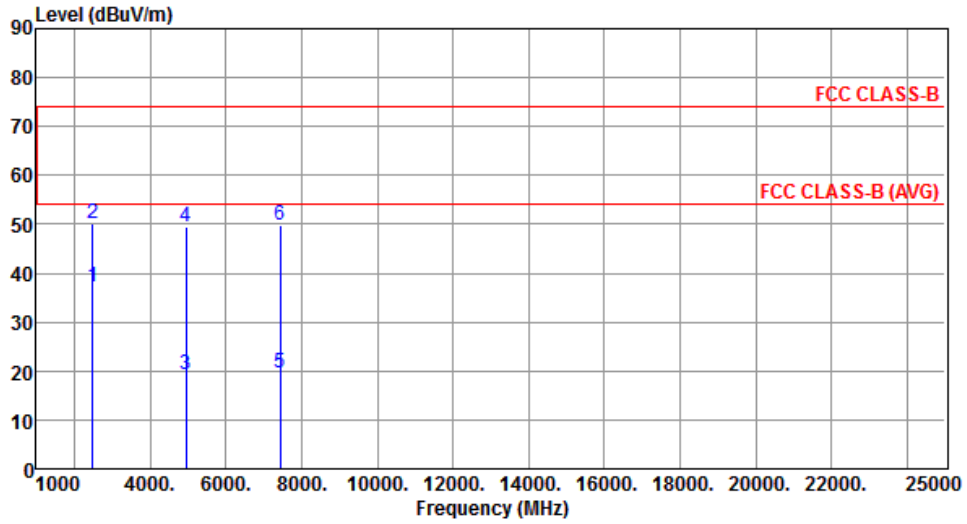

	Freq. MHz	Emission level dBuV/m	Limit dBuV/m	Margin dB	SA reading dBuV	Factor dB	Remark	ANT High cm	Turn Table deg
1	2483.50	37.30	54.00	-16.70	40.20	-2.90	Average	262	268
2	2483.50	50.03	74.00	-23.97	52.93	-2.90	Peak	262	268
3	4960.00	19.25	54.00	-34.75	15.27	3.98	Average	259	257
4	4960.00	49.35	74.00	-24.65	45.37	3.98	Peak	259	257
5	7440.00	19.61	54.00	-34.39	10.97	8.64	Average	100	321
6	7440.00	49.71	74.00	-24.29	41.07	8.64	Peak	100	321

Note 1: Emission Level (dBuV/m) = SA Reading (dBuV/m) + Factor* (dB)

*Factor includes antenna factor , cable loss and amplifier gain

Note 2: Margin (dB) = Emission level (dBuV/m) – Limit (dBuV/m).

Modulation	8DPSK	Test Freq. (MHz)	2480
Polarization	Vertical		

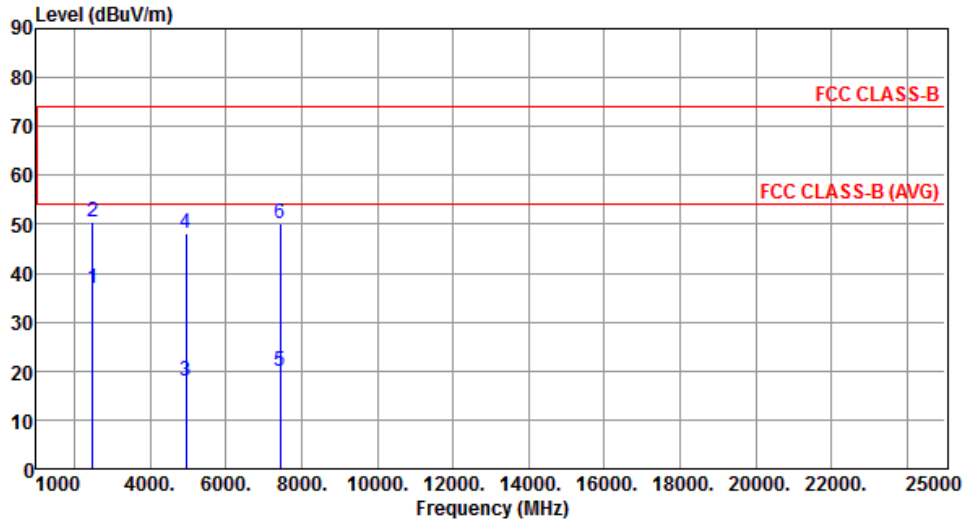

	Freq. MHz	Emission level dBuV/m	Limit dBuV/m	Margin dB	SA reading dBuV	Factor dB	Remark	ANT High cm	Turn Table deg
1	2483.50	36.84	54.00	-17.16	39.74	-2.90	Average	351	189
2	2483.50	50.54	74.00	-23.46	53.44	-2.90	Peak	351	189
3	4960.00	17.97	54.00	-36.03	13.99	3.98	Average	100	347
4	4960.00	48.07	74.00	-25.93	44.09	3.98	Peak	100	347
5	7440.00	19.96	54.00	-34.04	11.32	8.64	Average	100	273
6	7440.00	50.06	74.00	-23.94	41.42	8.64	Peak	100	273

Note 1: Emission Level (dBuV/m) = SA Reading (dBuV/m) + Factor* (dB)

*Factor includes antenna factor , cable loss and amplifier gain

Note 2: Margin (dB) = Emission level (dBuV/m) – Limit (dBuV/m).

3.3 Unwanted Emissions into Non-Restricted Frequency Bands

3.3.1 Limit of Unwanted Emissions into Non-Restricted Frequency Bands

The peak output power measured in any 100 kHz bandwidth outside of the authorized frequency band shall be attenuated by at least 20 dB relative to the maximum in-band peak PSD level in 100 kHz.

3.3.2 Test Procedures

Reference Level Measurement

1. Set the RBW = 100 kHz, VBW = 300 kHz, Detector = peak.
2. Set Sweep time = auto couple, Trace mode = max hold.
3. Allow trace to fully stabilize.
4. Use the peak marker function to determine the maximum amplitude level.

Unwanted Emissions Level Measurement

1. Set RBW = 100 kHz, VBW = 300 kHz, Detector = peak.
2. Trace Mode = max hold, Sweep = auto couple.
3. Allow the trace to stabilize.
4. Use peak marker function to determine maximum amplitude of all unwanted emissions within any 100 kHz bandwidth.

3.3.3 Test Setup

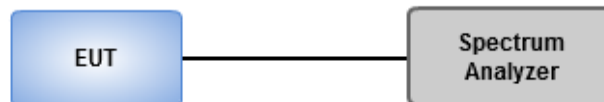

3.3.4 Unwanted Emissions into Non-Restricted Frequency Bands

GFSK

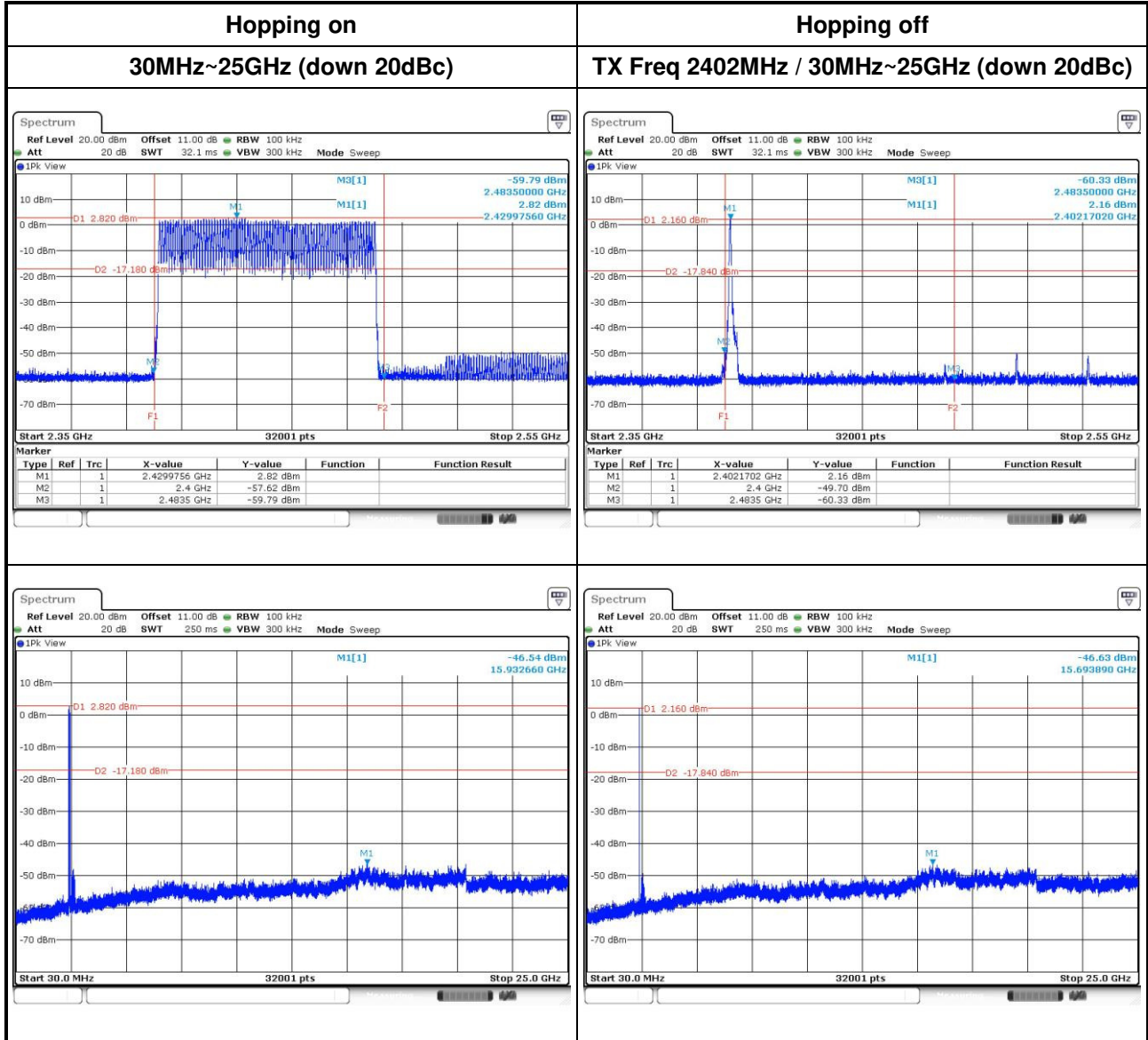

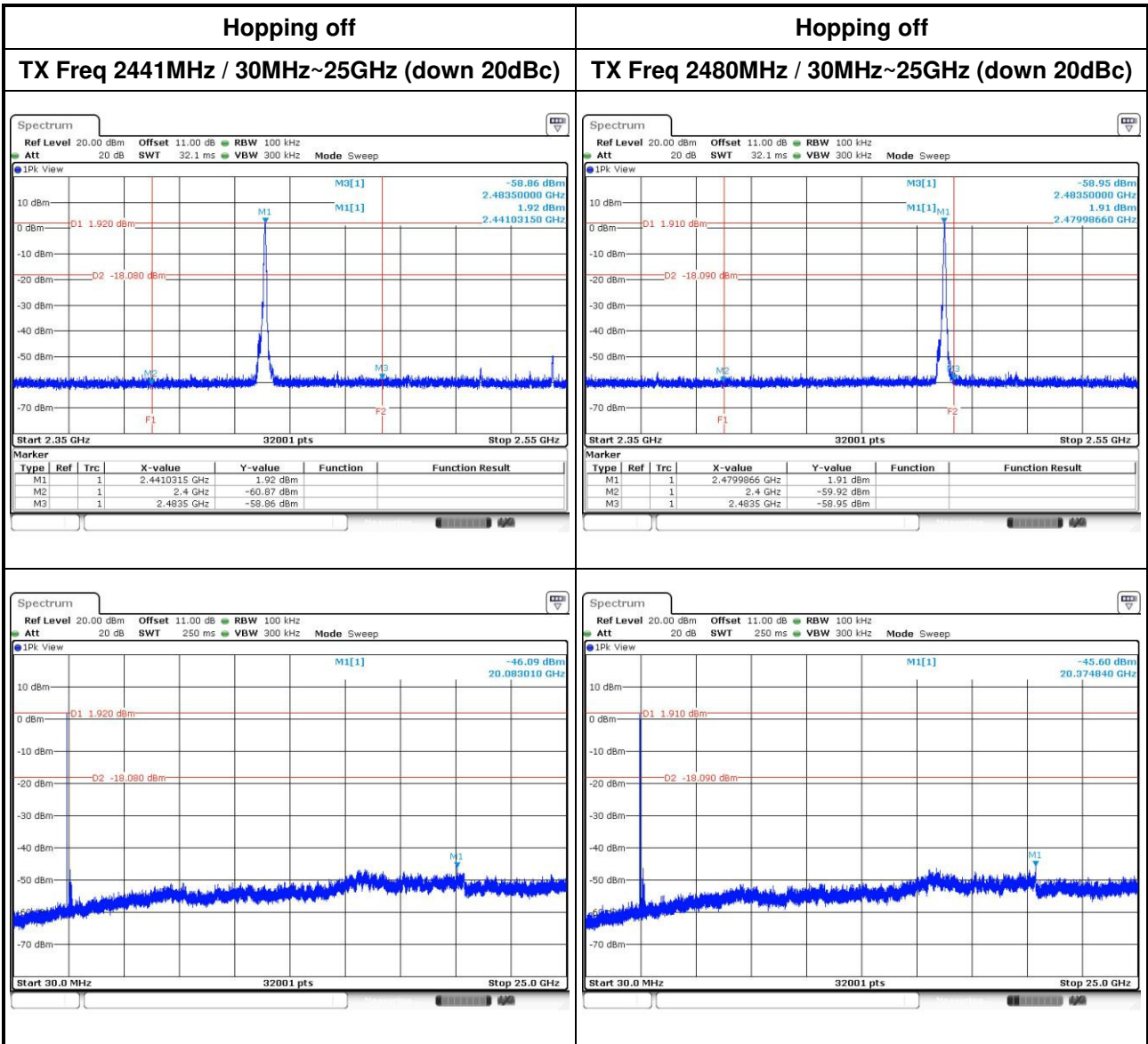

8DPSK

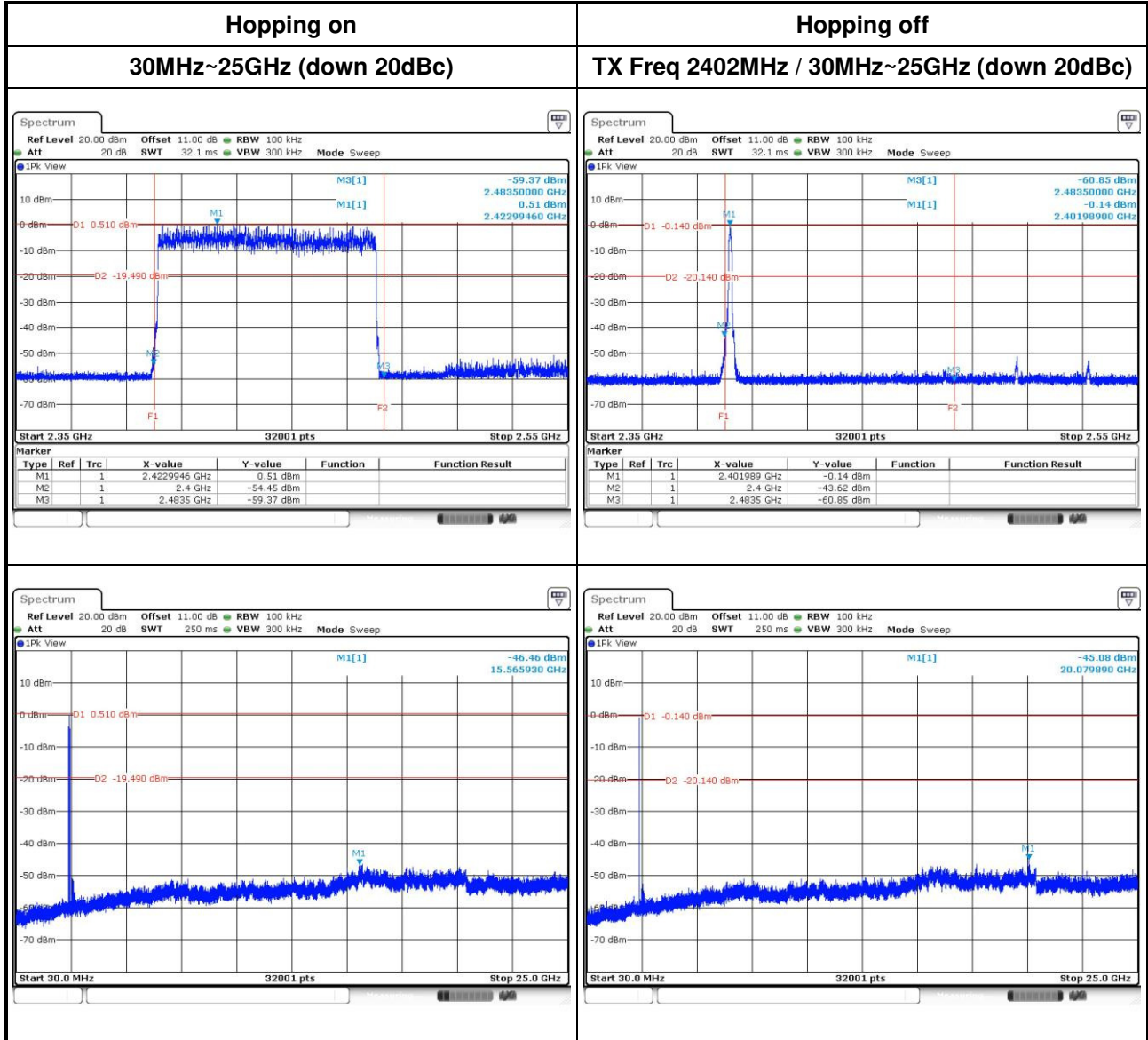

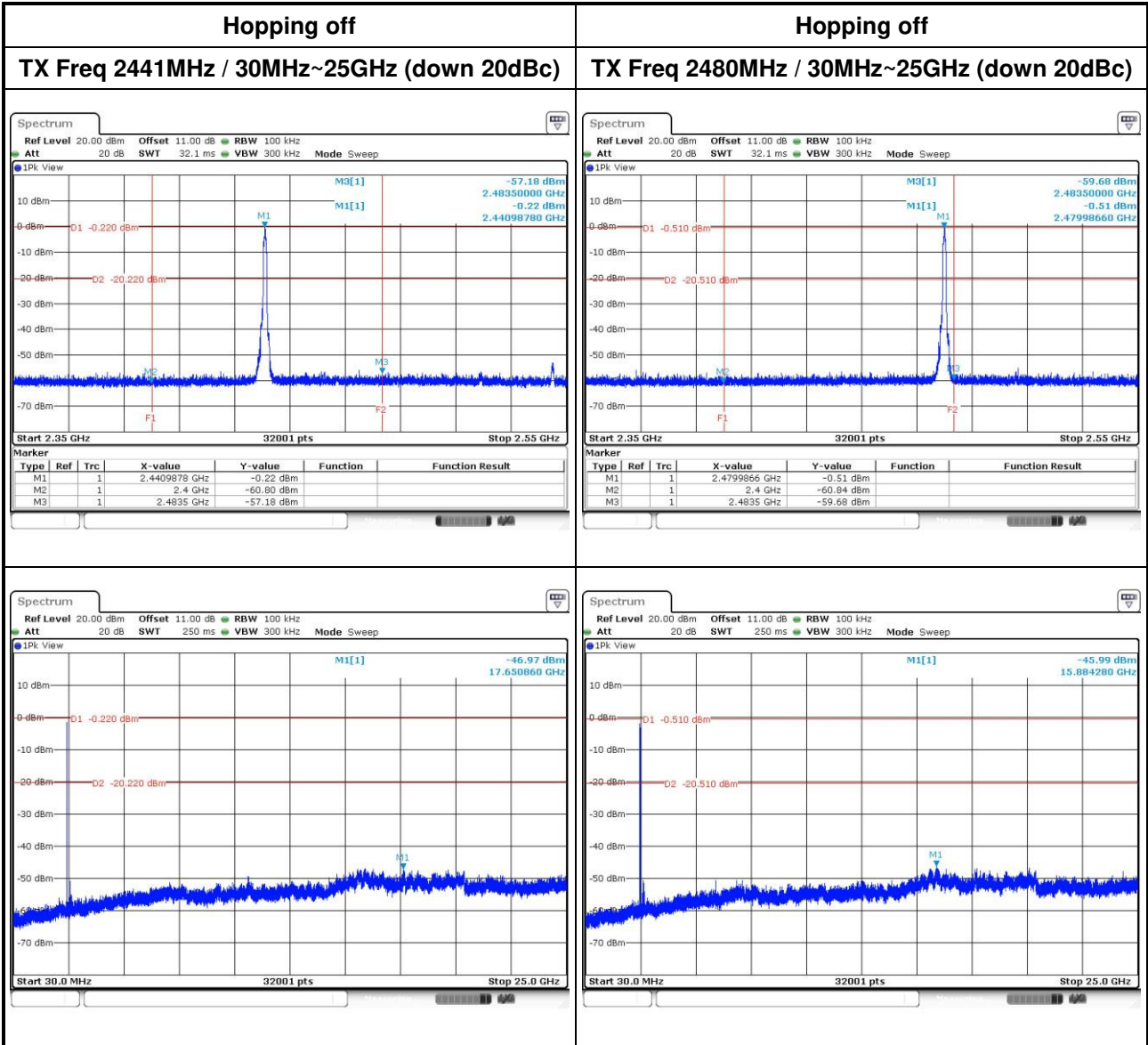

3.4 Conducted Output Power

3.4.1 Limit of Conducted Output Power

- 1 Watt
For frequency hopping systems operating in the 2400–2483.5 MHz band employing at least 75 non overlapping hopping channels, and all frequency hopping systems in the 5725–5850 MHz band.
- 0.125 Watt
For all other frequency hopping systems in the 2400–2483.5 MHz band.
- 0.125 Watt
For Frequency hopping systems operating in the 2400–2483.5 MHz band have hopping channel carrier frequencies that are separated by two-thirds of the 20 dB bandwidth of the hopping channel.

3.4.2 Test Procedures

1. A wideband power meter is used for power measurement. Bandwidth of power sensor and meter is 50MHz
2. If duty cycle of test signal is not 100 %, trigger and gating function of power meter will be enabled to capture transmission burst for measuring output power

3.4.3 Test Setup

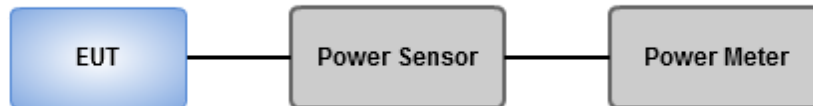

3.4.4 Test Result of Conducted Output Power

Modulation Mode	Freq. (MHz)	Output Power (mW)	Output Power (dBm)	Limit (mW)
GFSK	2402	1.80	2.55	125
GFSK	2441	1.75	2.43	125
GFSK	2480	1.71	2.34	125
$\pi/4$ DQPSK	2402	1.45	1.62	125
$\pi/4$ DQPSK	2441	1.39	1.43	125
$\pi/4$ DQPSK	2480	1.38	1.41	125
8DPSK	2402	1.47	1.68	125
8DPSK	2441	1.42	1.52	125
8DPSK	2480	1.39	1.43	125

Modulation Mode	Freq. (MHz)	AV Output Power (mW)	AV Output Power (dBm)
GFSK	2402	1.67	2.22
GFSK	2441	1.63	2.11
GFSK	2480	1.59	2.02
$\pi/4$ DQPSK	2402	0.73	-1.39
$\pi/4$ DQPSK	2441	0.70	-1.52
$\pi/4$ DQPSK	2480	0.68	-1.69
8DPSK	2402	0.74	-1.31
8DPSK	2441	0.71	-1.46
8DPSK	2480	0.69	-1.61

Note: Average power is for reference only.

3.5 Number of Hopping Frequency

3.5.1 Limit of Number of Hopping Frequency

Frequency hopping systems in the 2400–2483.5 MHz band shall use at least 15 channels.

3.5.2 Test Procedures

1. Set RBW = 100kHz, VBW = 300kHz, Sweep time = Auto, Detector = Peak Trace max hold.
2. Allow trace to stabilize.

3.5.3 Test Setup

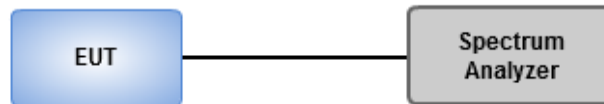

3.5.4 Test Result of Number of Hopping Frequency

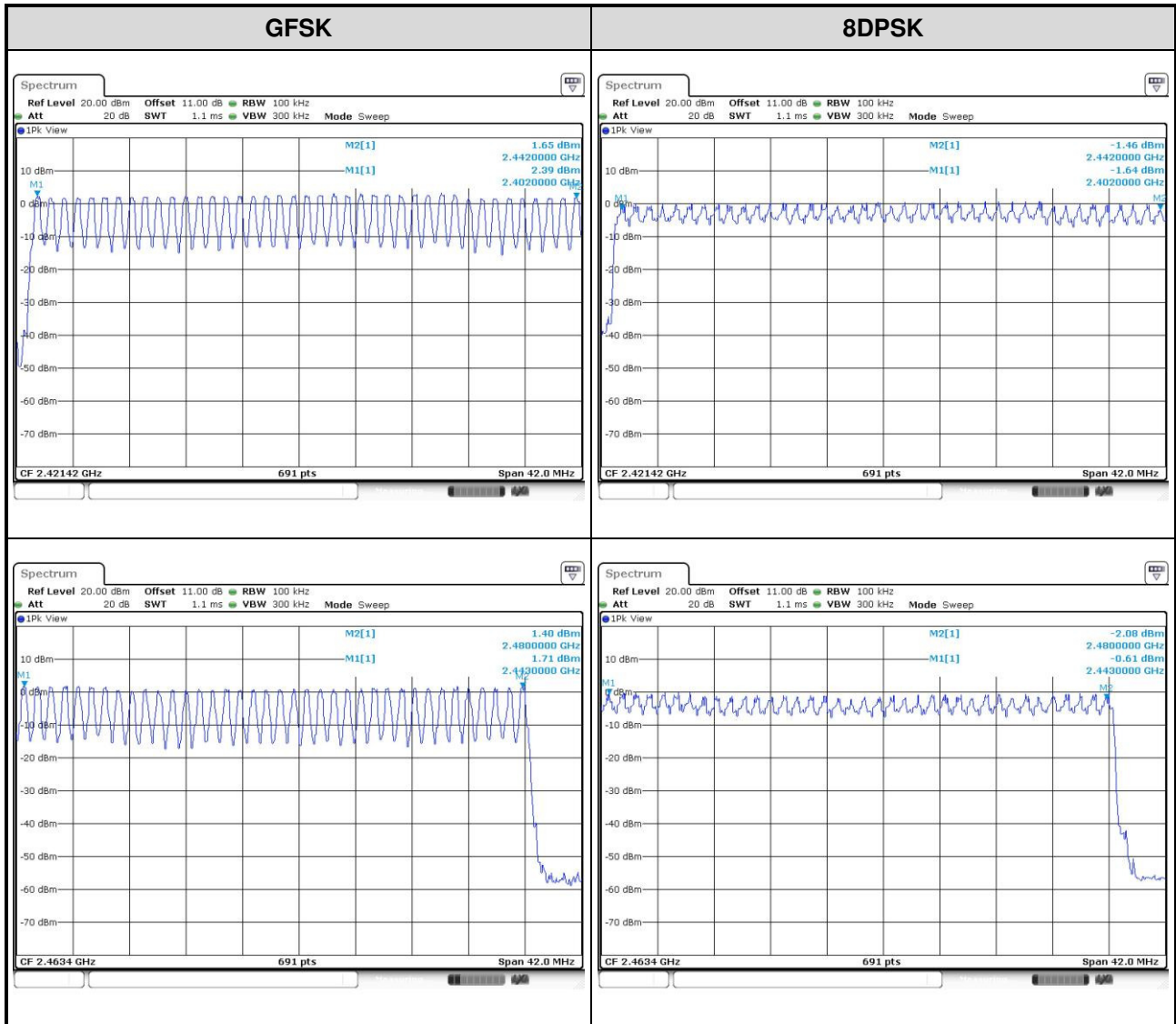

3.6 20dB and Occupied Bandwidth

3.6.1 Test Procedures

20dB Bandwidth

1. Set RBW=30kHz, VBW=100kHz, Sweep time = Auto, Detector=Peak, Trace max hold
2. Allow trace to stabilize
3. Measure the maximum width of the emission that is constrained by the frequencies associated with the two outermost amplitude points (upper and lower) that are attenuated by 20 dB relative to the maximum level measured in the fundamental emission.

Occupied Bandwidth

1. Set RBW=30kHz, VBW=100kHz, Sweep time = Auto, Detector=Sample, Trace max hold
2. Allow trace to stabilize
3. Use Occupied bandwidth function of spectrum analyzer to measuring 99% occupied bandwidth

3.6.2 Test Setup

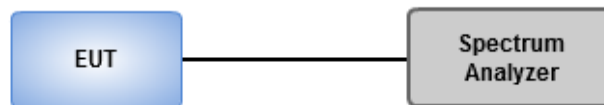

3.6.3 Test result of 20dB and Occupied Bandwidth

Modulation Mode	Freq. (MHz)	20dB Bandwidth (MHz)	Occupied Bandwidth (MHz)
GFSK	2402	0.978	0.886
GFSK	2441	0.983	0.878
GFSK	2480	0.978	0.878
8DPSK	2402	1.296	1.171
8DPSK	2441	1.291	1.171
8DPSK	2480	1.296	1.173

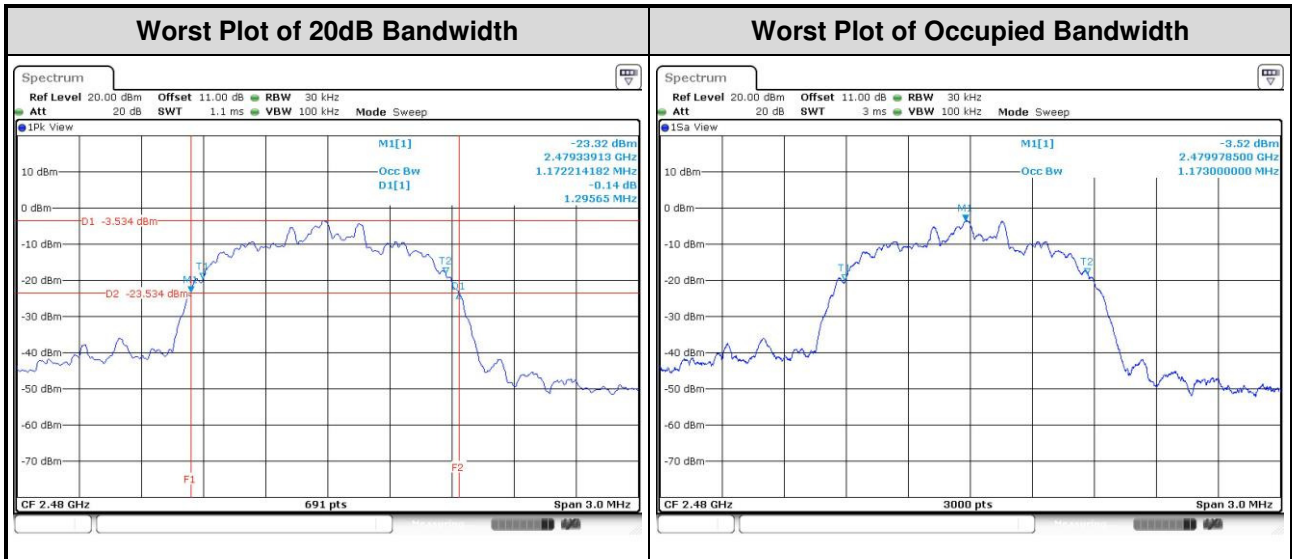

3.7 Channel Separation

3.7.1 Limit of Channel Separation

- Frequency hopping systems shall have hopping channel carrier frequencies separated by a minimum of 25 kHz or the 20 dB bandwidth of the hopping channel, whichever is greater.
- Frequency hopping systems operating in the 2400–2483.5 MHz band may have hopping channel carrier frequencies that are separated by 25 kHz or two-thirds of the 20 dB bandwidth of the hopping channel, whichever is greater.

3.7.2 Test Procedures

1. Set RBW=100kHz, VBW=300kHz, Sweep time = Auto, Detector=Peak Trace max hold
2. Allow trace to stabilize
3. Use the marker-delta function to determine the separation between the peaks of the adjacent channels. The EUT shall show compliance with the appropriate regulatory limit

3.7.3 Test Setup

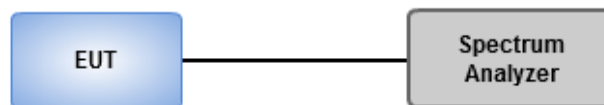

3.7.4 Test result of Channel Separation

Modulation Mode	Freq. (MHz)	Channel Separation (MHz)	20dB Bandwidth (MHz)	Minimum Limit (MHz)
GFSK	2402	1.003	0.978	0.652
GFSK	2441	1.003	0.983	0.655
GFSK	2480	1.003	0.978	0.652
8DPSK	2402	1.003	1.296	0.864
8DPSK	2441	1.003	1.291	0.861
8DPSK	2480	1.003	1.296	0.864

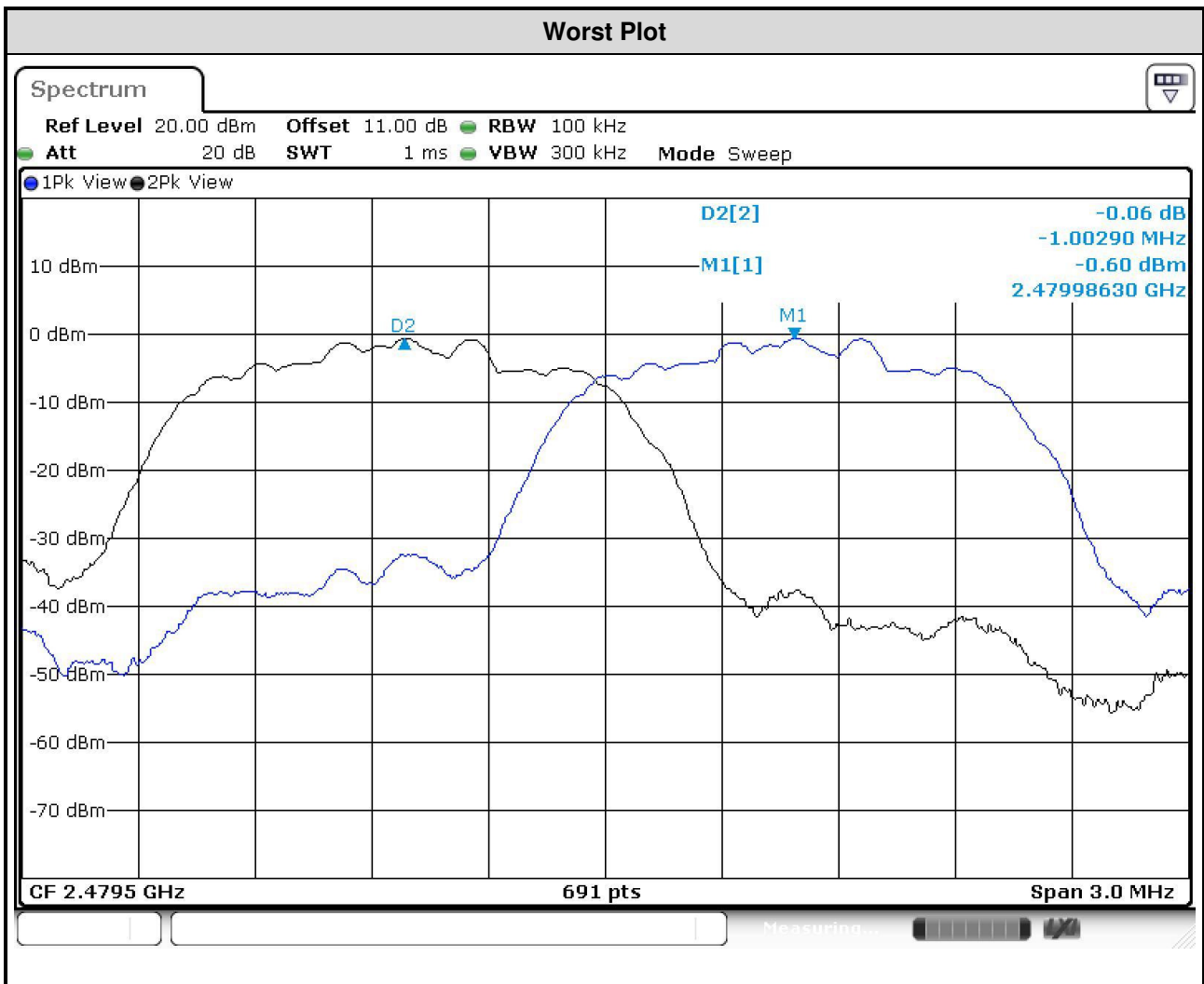

3.8 Number of Dwell Time

3.8.1 Limit of Dwell time

The average time of occupancy on any channel shall not be greater than 0.4 seconds within a period of 0.4 seconds multiplied by the number of hopping channels employed.

3.8.2 Test Procedures

1. Set RBW=100kHz,VBW=300kHz,Sweep time = 500us(DH1),2ms(DH3),4ms(DH5), Detector=Peak, Span=0Hz,Trace max hold
2. Enable gating and trigger function of spectrum analyzer to measure burst on time.
3. The DH1 packet can cover a single time slot. A maximum length packet has duration of 1 time slots. The hopping rate is 1600 hops/second so the maximum dwell time is 1/1600 seconds, or 0.625ms. DH1 Packet permit maximum $1600 / 79 / 2 = 10.12$ hops per second in each channel (1 time slot TX, 1 time slot RX). So, the dwell time is the time duration of the pulse times $10.12 \times 31.6 = 320$ within 31.6 seconds.
4. The DH3 packet can cover up to 3 time slots. A maximum length packet has duration of 3 time slots. The hopping rate is 1600 hops/second so the maximum dwell time is 3/1600 seconds, or 1.875ms. DH3 Packet permit maximum $1600 / 79 / 4 = 5.06$ hops per second in each channel (3 time slots TX, 1 time slot RX). So, the dwell time is the time duration of the pulse times $5.06 \times 31.6 = 160$ within 31.6 seconds.
5. The DH5 packet can cover up to 5 time slots. Operate DH5 at maximum dwell time and maximum duty cycle. A maximum length packet has duration of 5 time slots. The hopping rate is 1600 hops/second so the maximum dwell time is 5/1600 seconds, or 3.125ms. DH5 Packet permit maximum $1600 / 79 / 6 = 3.37$ hops per second in each channel (5 time slots TX, 1 time slot RX). So, the dwell time is the time duration of the pulse times $3.37 \times 31.6 = 106.6$ within 31.6 seconds

3.8.3 Test Setup

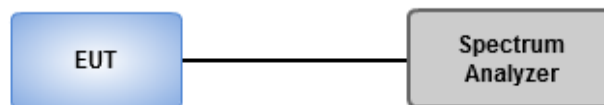

3.8.4 Test Result of Dwell Time

Modulation Mode	Freq. (MHz)	Length of Transmission Time (msec)	Number of Transmission in a 31.6 (79 Hopping*0.4)	Result (s)	Limit (s)
GFSK-DH1	2402	0.44638	320	0.143	0.4
GFSK-DH3	2402	1.70870	160	0.273	0.4
GFSK-DH5	2402	2.96232	106.6	0.316	0.4
8DPSK-DH1	2402	0.45797	320	0.147	0.4
8DPSK-DH3	2402	1.74928	160	0.280	0.4
8DPSK-DH5	2402	3.02609	106.6	0.323	0.4

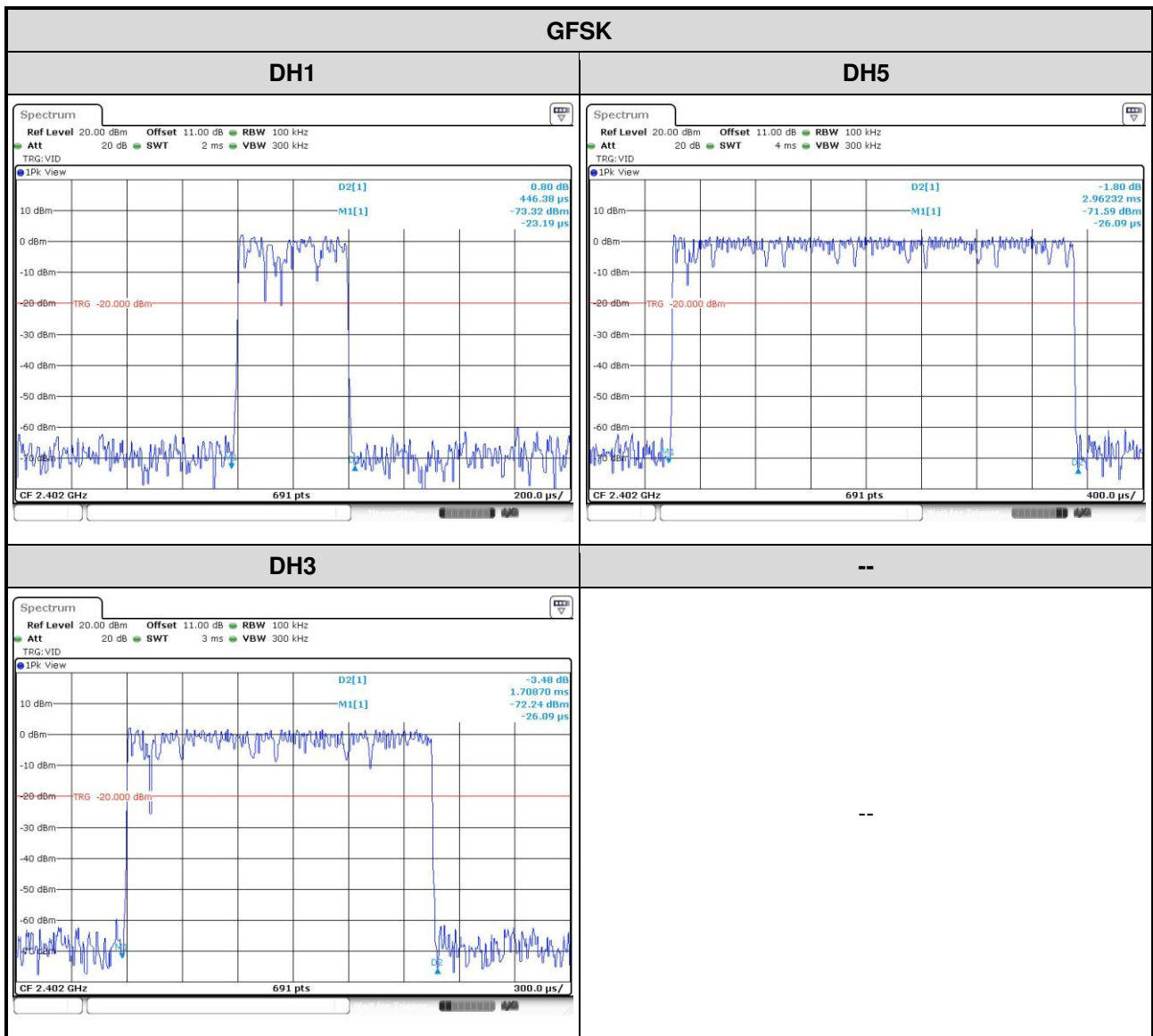

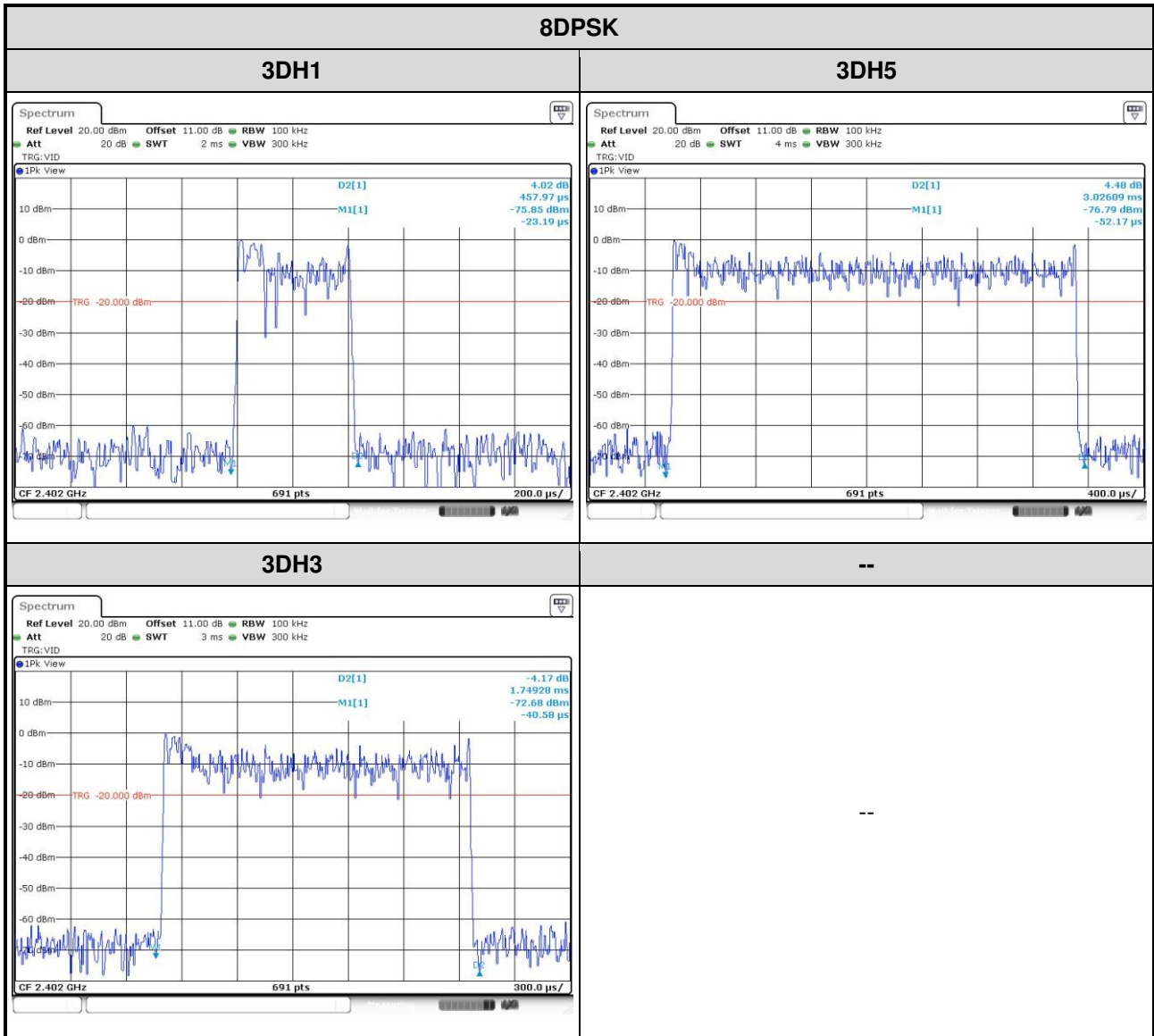

4 Test laboratory information

Established in 2012, ICC provides foremost EMC & RF Testing and advisory consultation services by our skilled engineers and technicians. Our services employ a wide variety of advanced edge test equipment and one of the widest certification extents in the business.

International Certification Corp (EMC and Wireless Communication Laboratory), it is our definitive objective is to institute long term, trust-based associations with our clients. The expectation we set up with our clients is based on outstanding service, practical expertise and devotion to a certified value structure. Our passion is to grant our clients with best EMC / RF services by oriented knowledgeable and accommodating staff.

Our Test sites are located at Linkou District and Kwei Shan District. Location map can be found on our website <http://www.icertifi.com.tw>.

Linkou

Tel: 886-2-2601-1640

No. 30-2, Ding Fwu Tsuen, Lin
Kou District, New Taipei City,
Taiwan, R.O.C.

Kwei Shan

Tel: 886-3-271-8666

No. 3-1, Lane 6, Wen San 3rd St.,
Kwei Shan District, Tao Yuan City
333, Taiwan, R.O.C.

Kwei Shan Site II

Tel: 886-3-271-8640

No. 14-1, Lane 19, Wen San 3rd
St., Kwei Shan District, Tao Yuan
City 333, Taiwan, R.O.C.

If you have any suggestion, please feel free to contact us as below information.

Tel: 886-3-271-8666

Fax: 886-3-318-0155

Email: ICC_Service@icertifi.com.tw

==END==